

Panasonic®

Operating Instructions Home Theater Audio System

Model No. SC-ALL70T

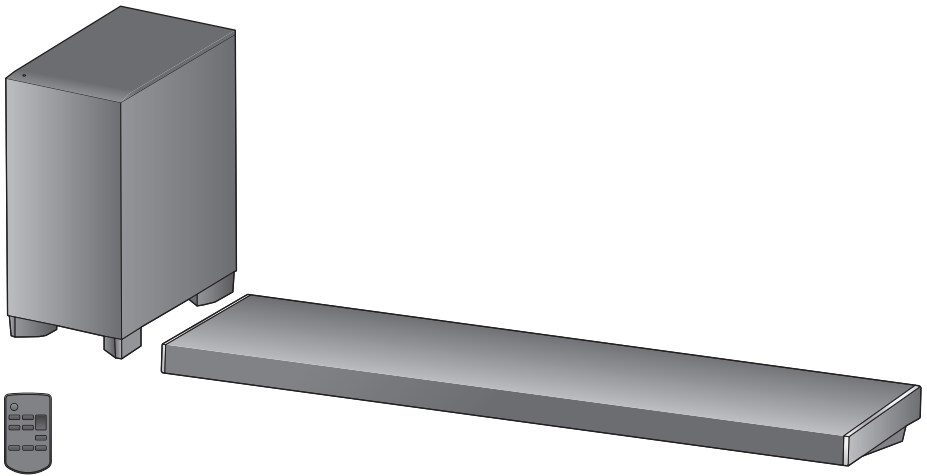

Thank you for purchasing this product.
Please read these instructions carefully before using this product,
and save this manual for future use.

Included Installation Instructions

The installation work should be done by a qualified installation specialist. (⇒ 13 to 18)

Before commencing work, carefully read these installation instructions and the operating instructions to ensure that installation is performed correctly.

(Please keep these instructions. You may need them when maintaining or moving this system.)

VIERA Link

Bluetooth®

Model number suffix “EB” denotes UK model.

EB EG GN

SQT0935-2

Safety precautions

WARNING

Unit

- To reduce the risk of fire, electric shock or product damage,
 - Do not expose this unit to rain, moisture, dripping or splashing.
 - Do not place objects filled with liquids, such as vases, on this unit.
 - Use only the recommended accessories.
 - Do not remove covers.
 - Do not repair this unit by yourself. Refer servicing to qualified service personnel.
- To prevent injury, this apparatus must be securely attached to the wall in accordance with the installation instructions.

AC mains lead

- To reduce the risk of fire, electric shock or product damage,
 - Ensure that the power supply voltage corresponds to the voltage printed on this unit.
 - Insert the mains plug fully into the socket outlet.
 - Do not pull, bend, or place heavy items on the lead.
 - Do not handle the plug with wet hands.
 - Hold onto the mains plug body when disconnecting the plug.
 - Do not use a damaged mains plug or socket outlet.
- The mains plug is the disconnecting device. Install this unit so that the mains plug can be unplugged from the socket outlet immediately.

Button-type battery (Lithium battery)

- Risk of fire, explosion and burns. Do not recharge, disassemble, heat above 60 °C or incinerate.
- Keep the Button-Type battery out of the reach of children. Never put Button-Type battery in mouth. If swallowed call your doctor.

Small object

- Keep the screws out of reach of children to prevent swallowing.
- Keep the button-type battery out of reach of children to prevent swallowing. Never put Button-Type battery in mouth. If swallowed call your doctor.

CAUTION

Unit

- Do not place sources of naked flames, such as lighted candles, on this unit.
- This unit may receive radio interference caused by mobile telephones during use. If such interference occurs, please increase separation between this unit and the mobile telephone.
- This unit is intended for use in moderate climates.
- Product Identification Marking is located on the bottom of the unit.

Placement

- Place this unit on an even surface.
- To reduce the risk of fire, electric shock or product damage,
 - Do not install or place this unit in a bookcase, built-in cabinet or in another confined space. Ensure this unit is well ventilated.
 - Do not obstruct this unit's ventilation openings with newspapers, tablecloths, curtains, and similar items.
 - Do not expose this unit to direct sunlight, high temperatures, high humidity, and excessive vibration.

Button-type battery (Lithium battery)

- Danger of explosion if battery is incorrectly replaced. Replace only with the type recommended by the manufacturer.
- Insert with poles aligned.
- Mishandling of batteries can cause electrolyte leakage and may cause a fire.
 - Remove the battery if you do not intend to use the remote control for a long period of time. Store in a cool, dark place.
 - Do not heat or expose to flame.
 - Do not leave the battery(ies) in a car exposed to direct sunlight for a long period of time with doors and windows closed.
- When disposing of the batteries, please contact your local authorities or dealer and ask for the correct method of disposal.



Caution for AC Mains Lead

(For the AC mains plug of three pins)

For your safety, please read the following text carefully.

This appliance is supplied with a moulded three pin mains plug for your safety and convenience. A 10-ampere fuse is fitted in this plug.

Should the fuse need to be replaced please ensure that the replacement fuse has a rating of 10-ampere and that it is approved by ASTA or BSI to BS1362.

Check for the ASTA mark  or the BSI mark  on the body of the fuse.

If the plug contains a removable fuse cover you must ensure that it is refitted when the fuse is replaced.

If you lose the fuse cover the plug must not be used until a replacement cover is obtained.

A replacement fuse cover can be purchased from your local dealer.

Before use

Remove the connector cover.

How to replace the fuse

The location of the fuse differ according to the type of AC mains plug (figures A and B). Confirm the AC mains plug fitted and follow the instructions below.

Illustrations may differ from actual AC mains plug.

1. Open the fuse cover with a screwdriver.

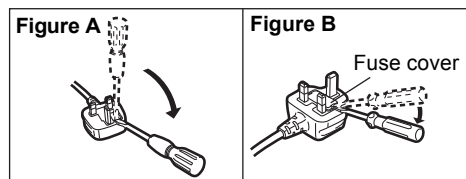

2. Replace the fuse and close or attach the fuse cover.

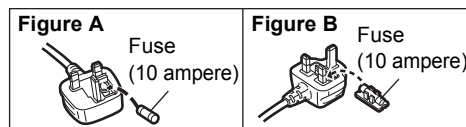

About descriptions in these operating instructions

- Pages to be referred to are indicated as "⇒ ○○".
- Labels on this unit and the remote control are indicated as [○○] in these operating instructions.
- The illustrations shown may differ from your unit.
- These operating instructions are applicable to model SC-ALL70T for variety of regions. Unless otherwise indicated, illustrations in these operating instructions are of the model for the United Kingdom and Ireland.
- Operations in this operating instructions are described mainly with the remote control, but you can perform the operations on the main unit if the controls are the same.

Table of contents

Safety precautions	2
Caution for AC Mains Lead	3

Before use

Supplied items.....	5
Control reference guide.....	6

Getting started

Step 1 Connections	9
Step 2 Placement	13
Step 3 Active subwoofer wireless connection	19
Step 4 Network settings	19

Operations



Using this system	23
Streaming music over the network	24
Bluetooth® operations	27
3D sound	28
Sound menu	28
Setup menu	30
Linked operations with the TV (VIERA Link “HDAVI Control™”)	33

Reference

Troubleshooting	35
About Bluetooth®	40
Unit care	41
Licenses	41
Specifications	42
Limited Warranty (ONLY FOR AUSTRALIA)	47







Supplied items

This system (SC-ALL70T)

<input type="checkbox"/> 1 Main unit (speaker) (SU-ALL70T) 	<input type="checkbox"/> 1 Active subwoofer (SB-ALL70T) 
--	--

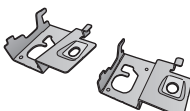
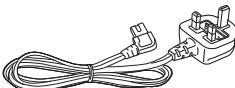
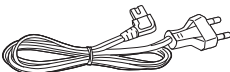
Accessories

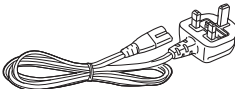
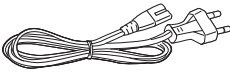
Check the supplied accessories before using this system.

<input type="checkbox"/> 1 Remote control (with a battery) (N2QAYC000098) 	<input type="checkbox"/> 1 IR Blaster (SFQ0014) 	<input type="checkbox"/> 2 Wall mount brackets (RMQ2281A, RMQ2281B) 
<input type="checkbox"/> 1 AC mains lead for the main unit <div style="display: flex; justify-content: space-around;"> <div data-bbox="69 744 396 925"> <p>For the United Kingdom and Ireland (SFQ0017)</p>  </div> <div data-bbox="396 744 714 925"> <p>For Continental Europe (SFQ0015)</p>  </div> <div data-bbox="714 744 1039 925"> <p>For Australia and New Zealand (SFQ0021)</p>  </div> </div>		
<input type="checkbox"/> 1 AC mains lead for the active subwoofer <div style="display: flex; justify-content: space-around;"> <div data-bbox="69 956 396 1136"> <p>For the United Kingdom and Ireland (SFQ0018)</p>  </div> <div data-bbox="396 956 714 1136"> <p>For Continental Europe (SFQ0016)</p>  </div> <div data-bbox="714 956 1039 1136"> <p>For Australia and New Zealand (SFQ0022)</p>  </div> </div>		
<input type="checkbox"/> 2 Screws (XYN5+J14JK) 		



- Product numbers are correct as of April 2015. These may be subject to change.
- The supplied AC mains lead is for use with this system only. Do not use it with other equipment. Also, do not use cords from other equipment with this system.

Control reference guide

This system (Front)

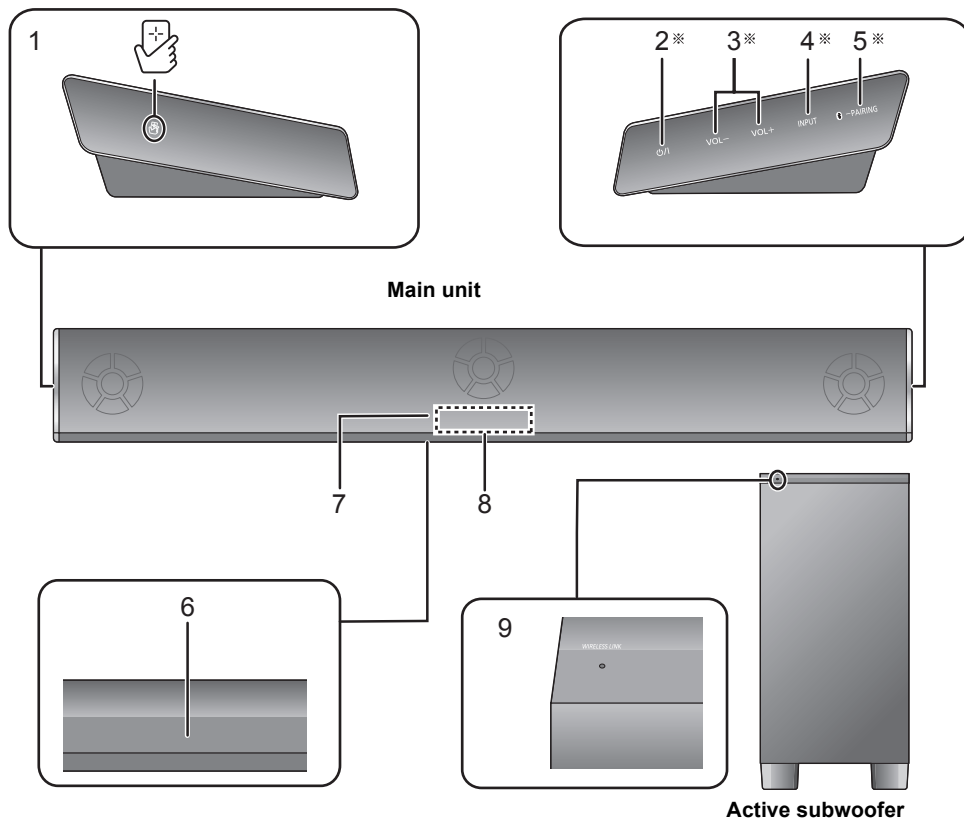

- 1 [NFC] NFC touch area (⇒ 27)
- 2 [Standby/on switch (power icon)] Touch to switch the unit from on to standby mode or vice versa. In standby mode, the unit is still consuming a small amount of power.
- 3 [VOL -] [VOL +] Adjust the volume of this system (⇒ 23)
- 4 [INPUT] Select the input source (⇒ 23)
- 5 [PAIRING]
 - Select the Bluetooth® device as the source (⇒ 23)
 - Bluetooth® pairing (⇒ 27)
 - Disconnecting a Bluetooth® device (⇒ 27)

- 6 Remote control signal sensor for table top layout (⇒ 8)
 - 7 Remote control signal sensor for wall mounting layout (⇒ 8)
 - 8 Display
 - 9 WIRELESS LINK indicator (⇒ 19)
- ※ These switches work just by touching the marks. Each time you touch the switch, there will be a beep sound. The beep sound setting can be changed. (⇒ 30)

This system (Rear)

Main unit

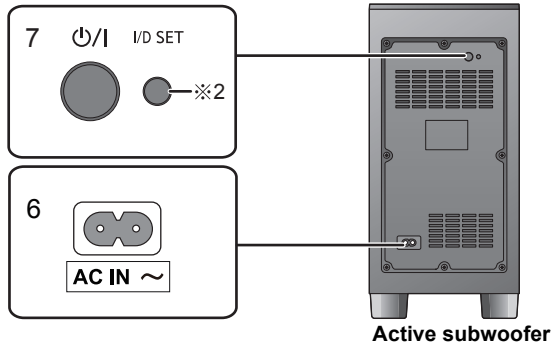
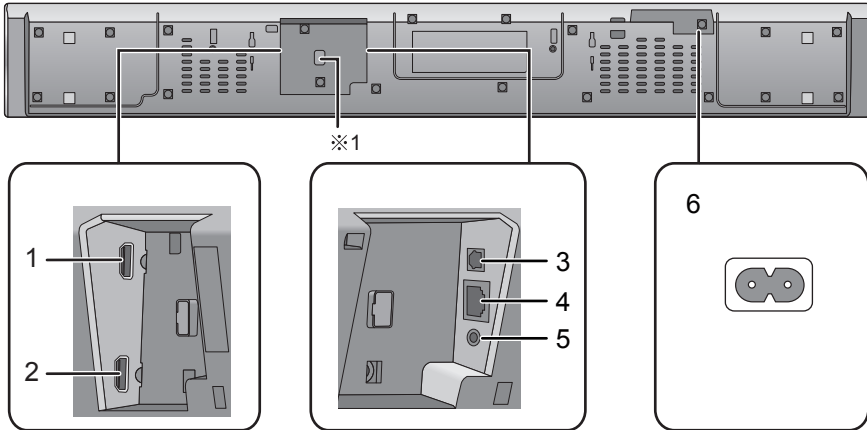

- 1 HDMI AV OUT (TV (ARC)) terminal (ARC compatible) (⇒ 9, 10)
- 2 HDMI AV IN (BD/DVD) terminal (⇒ 11)
- 3 OPTICAL DIGITAL AUDIO IN (TV) terminal (⇒ 10)
- 4 LAN terminal (⇒ 22)
- 5 Ir SYSTEM terminal (⇒ 11)
- 6 AC IN terminal (⇒ 12)
- 7 [I/O] Active subwoofer on/off button (⇒ 19)

- ※1 USB port (for service use only)
- ※2 The I/D SET button is only used when the main unit is not paired with the active subwoofer. (⇒ 39)

Remote control

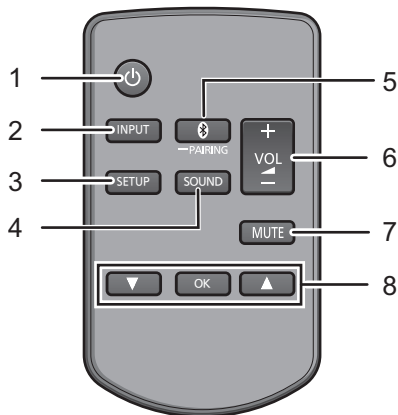

- 1 [⏻] Turn the main unit on or off (⇒ 23)
- 2 [INPUT] Select the input source (⇒ 23)
- 3 [SETUP] Select the setup menu (⇒ 30)
- 4 [SOUND] Select the sound menu (⇒ 28)
- 5 [Bluetooth]-PAIRING]
 - Select the Bluetooth® device as the source (⇒ 23)
 - Bluetooth® pairing (⇒ 27)
 - Disconnecting a Bluetooth® device (⇒ 27)
- 6 [- VOL +] Adjust the volume of this system (⇒ 23)
- 7 [MUTE] Mute the sound (⇒ 23)
- 8 [▼][OK][▲] Select and confirm the option

Before using for the first time

Remove the insulation sheet **A**.

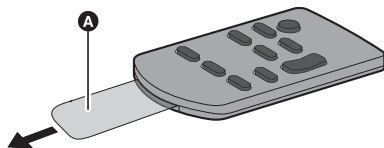

- Dispose of the insulation sheet responsibly after removing it.

To replace a button-type battery

Battery type: CR2025 (Lithium battery)

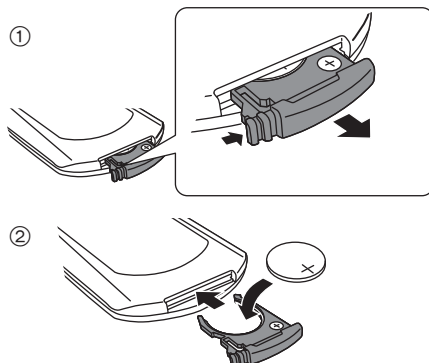

- Set the button-type battery with its (+) mark facing upward.

About remote control signal sensor

The remote control signal sensor is located on the main unit.

- Use the remote control within the correct operation range.
Distance: Within approx. 7 m directly in front
Angle: Approx. 30° left and right

For table top layout

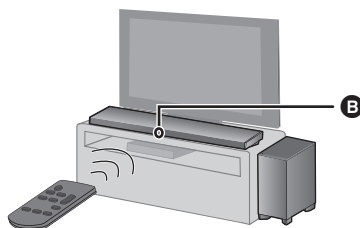

For wall mounting layout

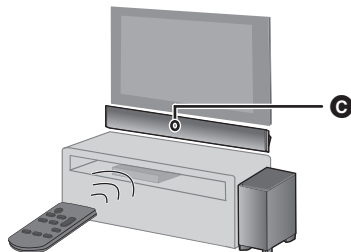

- B** Remote control signal sensor for table top layout
- C** Remote control signal sensor for wall mounting layout

Step 1 Connections

- Turn off all equipment before connection and read the appropriate operating instructions.

Do not connect the AC mains lead until all other connections are completed.

■ HDMI (High-Definition Multimedia Interface)

- The HDMI connection supports VIERA Link "HDAVI Control" (⇒ 33) when used with a compatible Panasonic TV.
- Use the ARC compatible High Speed HDMI Cables. Non-HDMI-compliant cables cannot be utilised.
- It is recommended that you use Panasonic's HDMI cable.

■ HDMI standby pass-through

Even if the main unit is in standby mode, the audio and/or video signal from the device connected to the HDMI AV IN terminal will be sent to the TV connected to the HDMI AV OUT terminal (the sound will not be output from this system).

■ 3D compatibility

Compatible with FULL HD 3D TV and Blu-ray Disc player.

- The main unit can pass-through the 3D video signal from a 3D compatible Blu-ray Disc player to a FULL HD 3D TV.

■ 4K/60p compatibility

Compatible with 4K Ultra HD TV and Blu-ray Disc player.

- This system can pass-through the 4K content of a 4K compatible equipment to a 4K Ultra HD TV.
- When connecting to 4K compatible equipment and 4K Ultra HD TV, use High Speed HDMI cables which support 18 Gbps bandwidth.

Connection with the TV

1 Verify if the TV's HDMI terminal is labelled "HDMI (ARC)".

Connection differs depending on the label printed next to the HDMI terminal.

Labelled "HDMI (ARC)":
Connection **A**

Not Labelled "HDMI (ARC)":
Connection **B**

■ What is ARC?

ARC is an abbreviation of Audio Return Channel, also known as HDMI ARC. It refers to one of the HDMI functions. When you connect the main unit to the terminal labelled "HDMI (ARC)" on the TV, the optical digital audio cable that is usually required in order to listen to sound from a TV is no longer required, and TV pictures and sound can be enjoyed with a single HDMI cable.

2 Make the connection.

A Labeled "HDMI (ARC)"

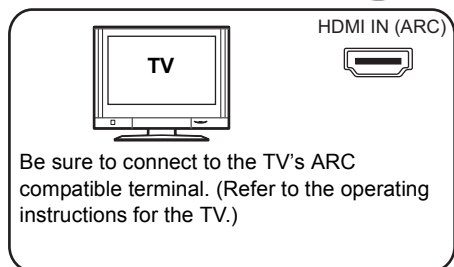
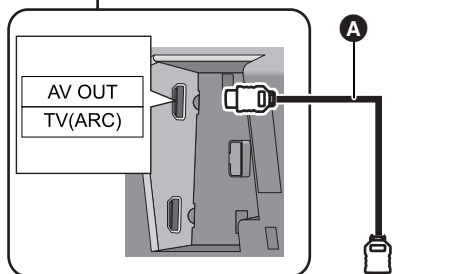

- A** HDMI cable

B Not Labeled "HDMI (ARC)"

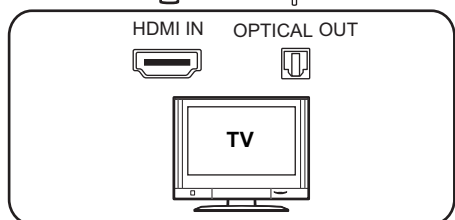
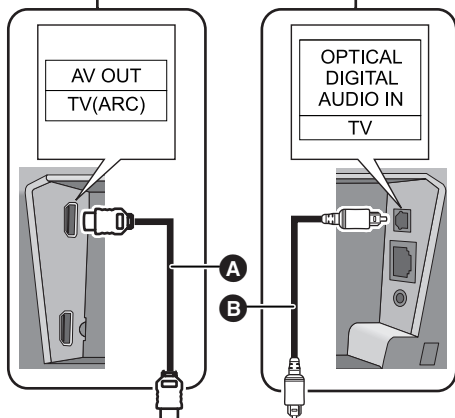

- A** HDMI cable
- B** Optical digital audio cable
- When you use the optical digital audio cable, insert the tip correctly into the terminal.

Connection from an HDMI compatible device

You can direct the audio signal from the connected Blu-ray Disc player, DVD player, Set Top Box, etc. to this system.

Preparation

- Connect the main unit to the TV. (⇒ 9)

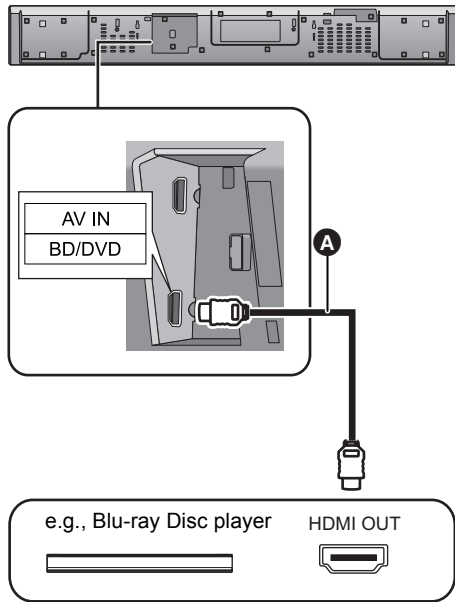

- A** HDMI cable



- Refer to the operating instructions of the connected HDMI compatible device for the necessary setting, to output the video and audio signals.
- When connecting to 4K compatible equipment and 4K Ultra HD TV, use High Speed HDMI cables which support 18 Gbps bandwidth.

Using the IR Blaster

(When the remote control does not work properly)

Depending on how the main unit is setup, it may block the TV's remote control signal sensor, stopping the TV's remote control from working. Use the supplied Ir system cable if this occurs. The TV remote control signals received by the main unit are sent to the TV to operate it.

- For the operation range, refer to page 8.
- Do not use any other IR Blaster except the supplied one.

1 Connect the jack plug to the main unit's Ir SYSTEM terminal.

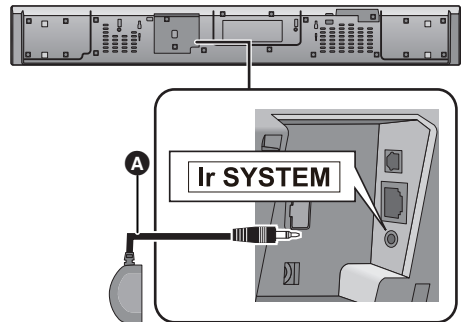

- A** IR Blaster (supplied)

2 Place the infrared emitter in sight of the TV's remote control signal sensor.

Placement example

On the rear of the main unit:

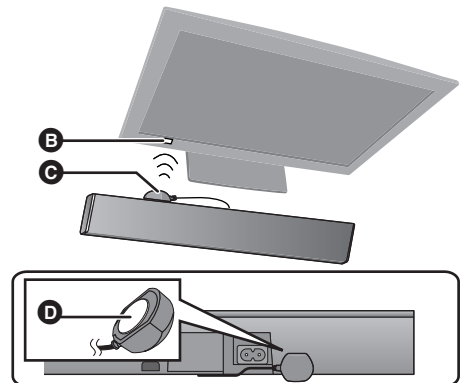

- B** TV remote control signal sensor
C Infrared emitter
D Adhesive tape

3 Aim the TV's remote control at this system's remote control sensor and operate the TV.

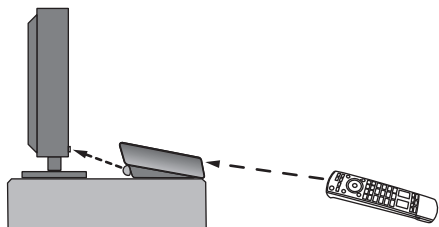

- For the location of the TV's remote control signal sensor, refer to the operating instructions for the TV.
- Select a location that suits the environment.
- Make sure to clean the surface, where the adhesive tape is to be attached.
- If you peel off the adhesive tape, the surface may become damaged and exposed adhesive may remain. Once you have confirmed the TV is operating correctly, secure it by attaching the adhesive tape.
- When the TV receives signals from both its remote control and the IR Blaster, their signals may interfere with each other, making it impossible for you to operate the TV.

Try using the TV's remote control from a different angle.

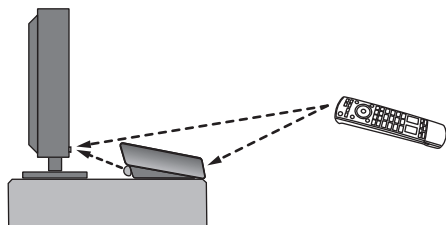

AC mains lead connection

- Connect only after all other connections are completed.

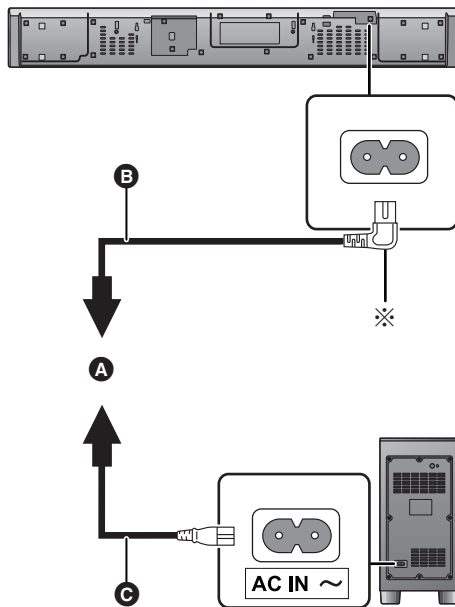

- A** To a household mains socket
 - B** AC mains lead for the main unit (supplied)
 - C** AC mains lead for the active subwoofer (supplied)
- ✖ Insert the AC mains lead fully into the main unit.

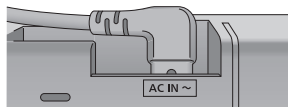

- This system consumes a small amount of AC power (⇒ 42) even when it is turned off. In the interest of power conservation, if you will not be using this system for a long time, unplug it from the household mains socket.

Saving energy

The main unit is designed to conserve its power consumption and save energy.

- The main unit will automatically switch to standby mode when no signal is input and no operation is performed for approx. 20 minutes. Refer to page 30, "AUTO POWER DOWN" to turn this function off.

Step 2 Placement

Safety Precautions

Professional installation is required. The installation should never be done by any other than a qualified installation specialist.
PANASONIC DISCLAIMS ANY PROPERTY DAMAGE AND/OR SERIOUS INJURY, INCLUDING DEATH RESULTING FROM IMPROPER INSTALLATION OR INCORRECT HANDLING.

- Be sure to install the main unit as indicated within this operating Instructions.
- Attach using techniques suited to the structure and materials of the installation location.

Caution

- This system is to be used only as indicated in these instructions. Failure to do so may lead to damage to the amplifier and/or the speaker, and may result in the risk of fire. Consult a qualified service person if damage has occurred or if you experience a sudden change in performance.
- Do not attempt to attach the main unit to a wall using methods other than those described in this manual.



- Do not hold the main unit in one hand to avoid injury, you may drop the main unit when carrying it.
- To prevent damage or scratches, lay down a soft cloth and perform the assembly on it.

The active subwoofer

When carrying the active subwoofer

Take care not to damage the inside speaker unit.

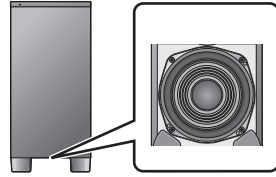

- The speaker protection cover is attached to the speaker unit inside the subwoofer. Remove it before use.
- When the subwoofer is brought close to CRT TVs and other display devices, the magnets in the speaker may cause some colour irregularities or image distortion. If this happens, move the active subwoofer to a place where these symptoms do not occur.
- Interference may occur if the TV has wireless LAN functionality, causing some communication problems (sound is interrupted, sound skips, there is a lot of noise, etc.). If this happens, move the active subwoofer to a place where interference does not occur.

Wireless interference

Interference may occur if you are using other devices (wireless LAN/microwave ovens/cordless phones, etc.) that use the 2.4 GHz frequency band, causing some communication problems (sound is interrupted, sound skips, there is a lot of noise, etc.).

If this happens, separate the other electronic equipment from the main unit and active subwoofer so that interference does not occur.

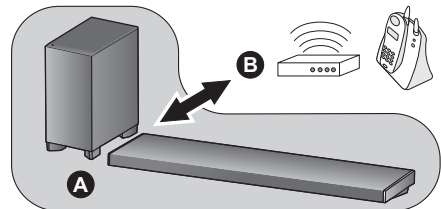

- A** Main unit/active subwoofer
- B** Wireless router, cordless phone and other electronic devices

Selecting the placement method

Choose a placement method that suits you best.

When placing the main unit in a rack or on a table

- Place the main unit on a flat and horizontal surface.

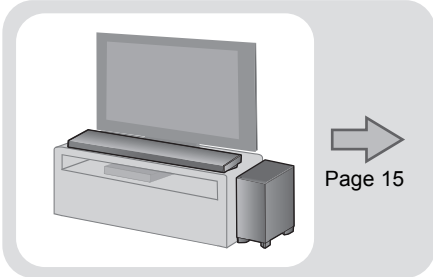

Page 15

When attaching the main unit to a wall

- Place the main unit on a flat and vertical surface.

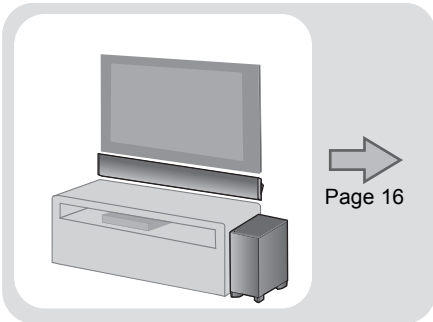

Page 16

■ When placing the main unit in front of the TV

The main unit may block or interfere with the TV's various sensors (C.A.T.S. (Contrast Automatic Tracking System) sensor, remote control sensor, etc.) and the 3D Eyewear transmitters on a 3D compatible TV.

- If interference occurs, move the main unit further away from the TV. If the TV still does not function correctly, try using it in a rack or in the wall mount position.

■ If the TV's remote control sensor is blocked by the main unit

Try using the TV's remote control from a different angle. If the problem persists, you can use the supplied IR Blaster to relay the signal to the TV. (⇒ 11)



- Place the active subwoofer within a few meters of the main unit and in a horizontal position with the top panel facing upward.
- Do not use the main unit or the active subwoofer in a metal cabinet.
- Placing the active subwoofer too close to the walls and corners can result in excessive bass. Cover walls and windows with thick curtains.
- Keep magnetised items away. Magnetised cards, watches, etc., can be damaged if placed too close to the main unit and active subwoofer.

When placing the main unit in a rack or on a table

Additionally required accessories (commercially available)

- Fall prevention cord × 2
- Screw eyes (to attach the fall prevention cord) × 2



- Use commercially available screws that are capable of supporting over 26 kg.
- Use a cord that is capable of supporting over 26 kg (with a diameter of about 1.5 mm).
- Lay the unit on a blanket or soft cloth for assembly.

1 Attach the cord to the main unit.

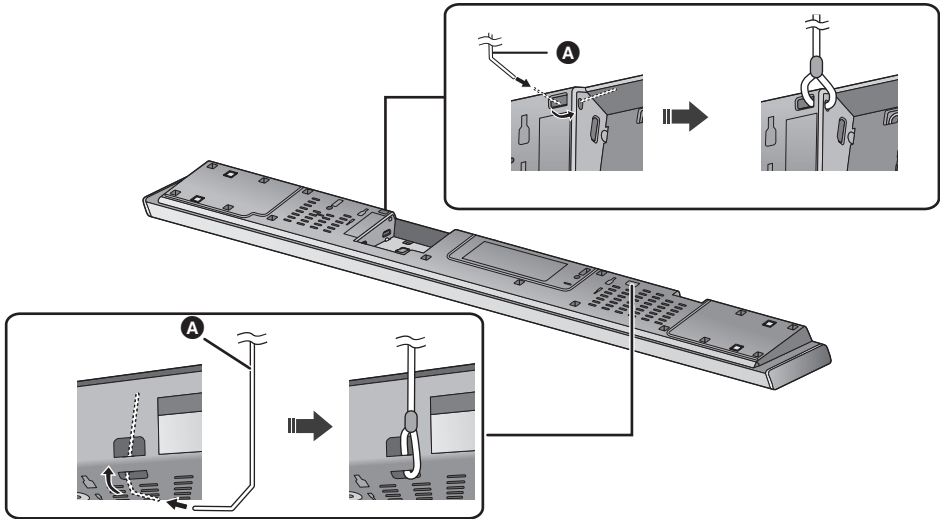

A Cord*

- ※ If the cord cannot be threaded through the holes, try bending the cord in 2 locations, about 5 mm apart from the tip, at an angle of 45° (as illustrated above).

2 Place the main unit in the desired position and attach each cord onto the rack or table.

- Make sure that the slack of the cord is minimal.
- Do not lean the main unit against the TV or wall.

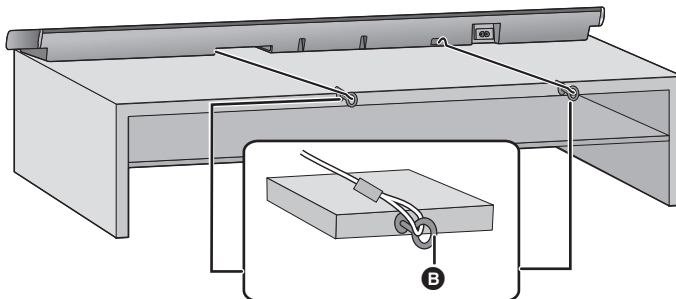

B Screw eye

- Attach at a position capable of supporting over 26 kg.
- Depending on the placement of the main unit, the screwing position of the screw eye may differ.

When attaching the main unit to a wall

The main unit can be wall mounted using the supplied wall mount brackets, etc. Make sure that the screw used and the wall are strong enough to support the weight of at least 26 kg. The screws and other items are not supplied as the type and size will vary with each installation.

- Refer to step 3 for details about the required screws.
- Be sure to attach the fall prevention cord as a secondary safety measure.

Supplied accessories

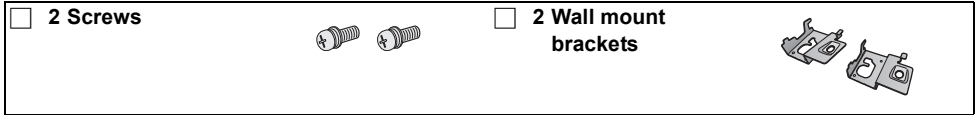

Additionally required accessories (commercially available)

- | | |
|---|-----|
| • Screws for wall mounting..... | × 2 |
| • Fall prevention cord..... | × 2 |
| • Screw eyes (to attach the fall prevention cord) | × 2 |



- Use a cord that is capable of supporting over 26 kg (with a diameter of about 1.5 mm).
- Lay the unit on a blanket or soft cloth for assembly.

1 Attach the cord to the main unit.

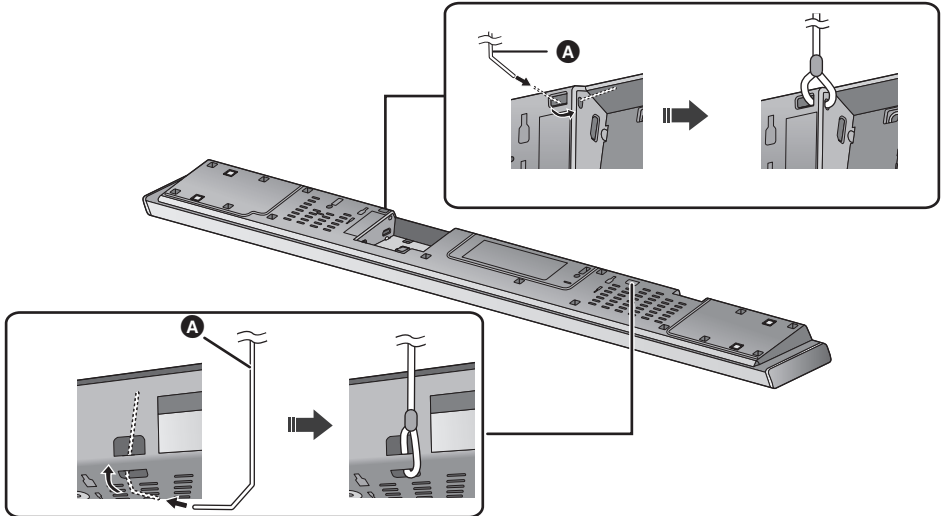

A Cord*

- ※ If the cord cannot be threaded through the holes, try bending the cord in 2 locations, about 5 mm apart from the tip, at an angle of 45° (as illustrated above).

2 Attach the wall mount brackets to the main unit.

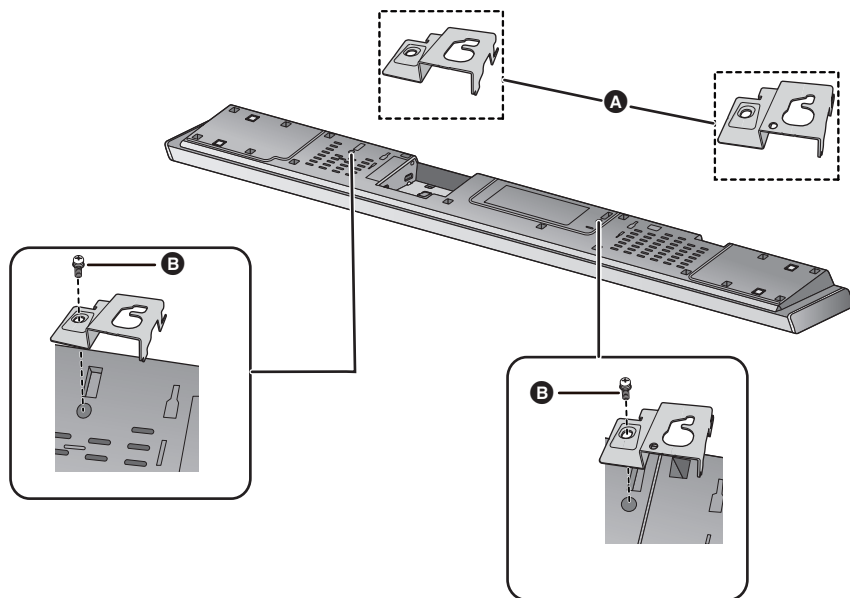

- A** Wall mount bracket (supplied)
- B** Screw (supplied)

3 Drive a screw into the wall.

- Use the measurements indicated below to identify the screwing positions on the wall.
- Leave at least 100 mm of space above of the main unit to allow enough space for fitting the main unit.
- Position the main unit with at least 50 mm of free space to its right. If not, it may not be possible to access the touch keys.
- Be sure to use a level to ensure that both mounting holes are level to each other.

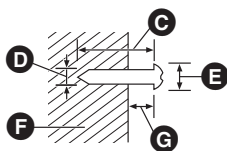

- C** At least 30 mm
- D** $\varnothing 4.0$ mm
- E** $\varnothing 7.0$ mm to $\varnothing 9.4$ mm
- F** Wall or pillar
- G** 2.5 mm to 3.5 mm

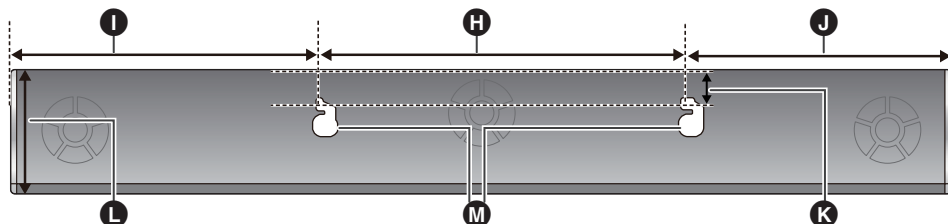

Front view (semi-transparent image)

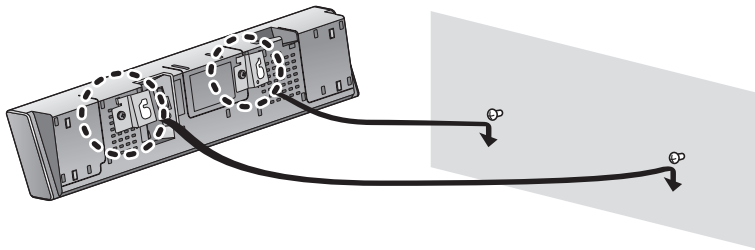

- H** 374 mm
- I** 315 mm
- J** 261 mm
- K** 41 mm
- L** 125.5 mm
- M** Wall mounting hole

4 Fit the main unit securely onto the screw(s).



DO	DO NOT
 <ul style="list-style-type: none">• Move the speaker so that the screw is in this position.	 <ul style="list-style-type: none">• In this position, the speaker will likely fall if moved to the left or right.

5 Secure the cord to the wall.

- Make sure that the slack of the cord is minimal.

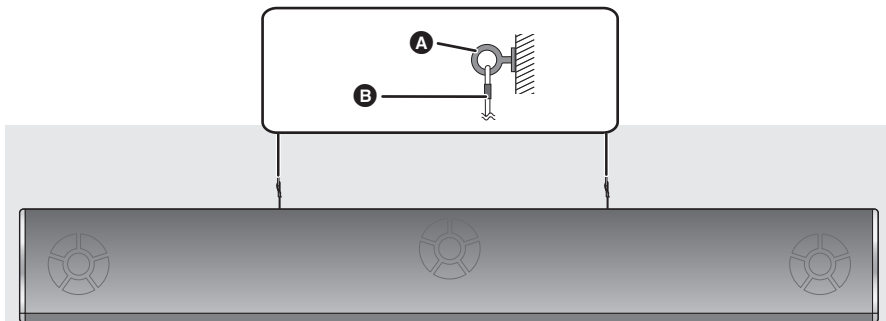

- A** Screw eye
- B** Cord

Step 3 Active subwoofer wireless connection

Preparation

- Turn on the main unit.

1 Press [⏻/⏻].

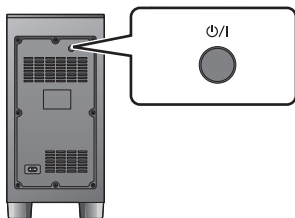

The active subwoofer will still consume a small amount of power even when it is turned off.

2 Check that the wireless link is activated.

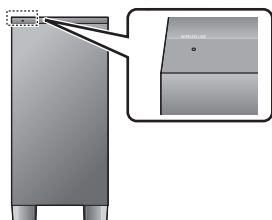

WIRELESS LINK indicator

Lights red:

The wireless link is not activated.

Lights green:

The wireless link is activated.

Blinks green:

The active subwoofer is trying to activate the wireless link with the main unit.



- The wireless link will be activated when the main unit and the active subwoofer are both turned on.

Step 4 Network settings

You can stream music from an iOS device, an Android™ device or a PC, etc. to this system's speakers by using the Qualcomm® AllPlay™ smart media platform or DLNA feature. To use these features, this system must join the same network as the compatible device.

- Please update the system's firmware after the network settings are complete. (⇒ 32, "Firmware update")

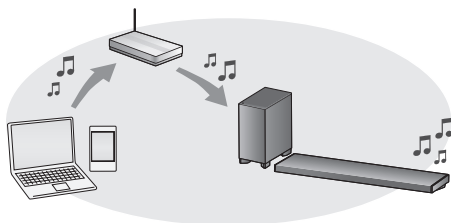

Choose a network setting method from the following.

Wireless LAN connection

Method 1:

"Using an Internet browser" (⇒ 20)

- You can access this system's network settings from the Internet browser on your smartphone or PC, etc.

Method 2:

"Using WPS (Wi-Fi Protected Setup™)" (⇒ 21)

- If your wireless router supports WPS, you can set up a connection by either pressing the WPS button, or entering the WPS PIN code.

Wired LAN connection

Method 3:

"Using a LAN cable" (⇒ 22)

- You can make a stable connection to the network with a LAN cable.



- To cancel wireless connection setting partway through, press [INPUT].
 - "WAIT" blinks on the display for approx. 1 minute.

Method 1: Using an Internet browser

- Do not connect a LAN cable. Doing so will disable the Wi-Fi® function.
- The following explanations are based on a smartphone.

1 Turn this system on.

2 Press [SETUP] on the remote control repeatedly to select “NET SETUP”.

3 Press [▼] [▲] on the remote control to select “MANUAL” and then press [OK].

4 Press [▼] [▲] on the remote control to select “OK?YES” and then press [OK].

- After pressing [OK], the previous network connection you have set with this system will be cleared.
- Proceed to the next step after the display on the main unit changes from a flashing “WAIT” display to a flashing “SETTING” display.

5 Go to Wi-Fi settings on your compatible device.

- Make sure that DHCP is enabled for the network setting on your compatible device.



6 Select “AllPlay □□□□□_AJ” to connect to this system.

- “□” stands for a digit that is unique to each set.
- This can take up to 1 minute to appear in your Wi-Fi list.

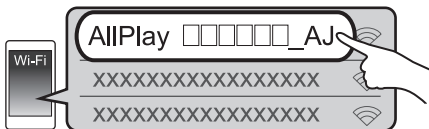

[iOS device] : The settings page will be automatically displayed in the Internet browser.

[Except iOS device] : Open the Internet browser and refresh the page to display the settings page.

- If the settings page is not displayed, type “http://172.19.42.1/” into the URL address field.

7 Type a device name and then select “Next”.

- The device name will be displayed as this system’s name on the network.
- The guaranteed limit is 32 characters.
- The device name is set when “Next” is selected.
- You can also change the device name after the network connection is set up. (⇒ 22, “To make network-related settings”)

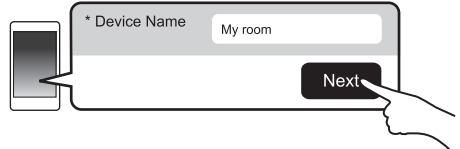

8 Select your network name (SSID) and type the password.

- Check the wireless router for the network name (SSID) and the password.
- A list of network names (SSIDs) will be appeared when you select the “Network Name” box.
- To show the characters typed in the “Password” box, select “Show Password”.
- If your network requires specific settings, deselect “DHCP” to disable DHCP.
 - You can use specific IP address, subnet mask, default gateway, primary DNS, etc.

9 Select “Connect” to apply the settings.

- On the main unit’s display, “SUCCESS” appears when the connection is established. (“W” will be displayed.)
 - If “FAIL” is displayed press [OK], check the network name (SSID) and the password, and then try the setting again.
- Depending on the device, the connection complete screen may not be displayed.

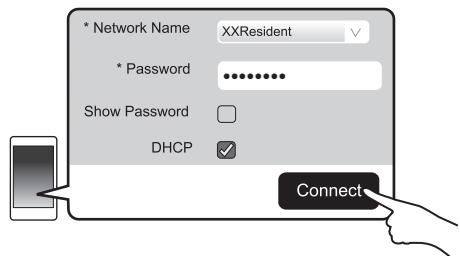

10 Press [OK] on the remote control to exit the setting.

- Your compatible device automatically connects to the original network.



- Enable Java and cookies in your browser settings.
- Wireless connection setting cancels after 20 minutes elapse.

Method 2: Using WPS (Wi-Fi Protected Setup™)

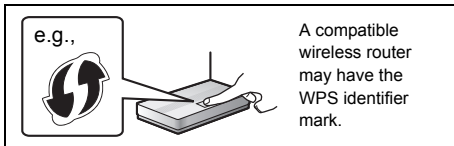

- Do not connect a LAN cable. Doing so will disable the Wi-Fi function.
- The following explanations are based on a smartphone.

1 Turn this system on.

2 To enter “WPS PUSH” mode

- ① Press [SETUP] on the remote control repeatedly to select “NET SETUP”.
 - ② Press [▼] [▲] on the remote control to select “WPS PUSH” and then press [OK].
 - ③ Press [▼] [▲] on the remote control to select “YES” and then press [OK].
- Alternatively, touch and hold [INPUT] and [PAIRING] on the main unit for at least 4 seconds.
 - Proceed to the next step after the display on the main unit changes from a flashing “WAIT” display to a flashing “WPS” display.

3 Activate the WPS button on the wireless router.

- On the main unit’s display, “SUCCESS” appears when the connection is established. (“” will be displayed.)
 - “FAIL” may be displayed if the connection was not made within the set time limit. Try the setting again. If “FAIL” is still displayed, try other methods.

4 Press [OK] on the remote control to exit the setting.

■ Using the WPS PIN code

- 1 Turn this system on.
- 2 Press [SETUP] on the remote control repeatedly to select “NET SETUP”.
- 3 Press [▼] [▲] on the remote control to select “WPS PIN” and then press [OK].
 - Proceed to the next step after the display on the main unit changes from a flashing “WAIT” display to a “64428147” display.
- 4 Enter the PIN code “64428147” into the wireless router.
 - On the main unit’s display, “SUCCESS” appears when the connection is established. (“” will be displayed.)
 - “FAIL” may be displayed if the connection was not made within the set time limit. Try the setting again. If “FAIL” is still displayed, try other methods.
- 5 Press [OK] on the remote control to exit the setting.



- Depending on a router, other connected devices may temporarily lose their connection.
- For details, refer to the operating instructions of the wireless router.
- Wireless connection setting cancels after 2 minutes elapse.

Method 3: Using a LAN cable

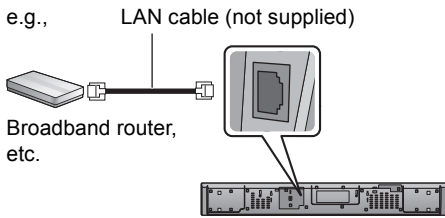

1 Disconnect the AC mains lead.

2 Connect the main unit to a broadband router, etc. using a LAN cable.

3 Connect the AC mains lead to the main unit and turn this system on.

- When the connection is established, "**LAN**" is indicated on the main unit's display.



- Use category 5 or above straight LAN cables (STP) when connecting to peripheral devices.
- The LAN cable must be connected or disconnected while the AC mains lead is disconnected.
- Inserting any cable other than a LAN cable in the LAN port can damage the system.
- If the LAN cable is disconnected, the network-related settings (⇒ right) will be initialized. In that case, make the settings again.
- When a LAN cable is connected, the Wi-Fi function will be disabled.

■ To make network-related settings

You can change this system's name on the network, and use specific IP address, subnet mask, default gateway, primary DNS, etc.

You can also change the name of this system by changing a setting in the app "Panasonic Music Streaming" (⇒ 24). For details on the app, refer to the site below.

- Always use the latest version of the app.
<http://panasonic.jp/support/global/cs/audio/app/>
(This site is in English only.)

Preparation

- Connect this system to the network with a cable. (⇒ left)
- Connect your device to the same network as this system.
- Check this system's IP address (⇒ 31, "NET INFO"), and note it down.

- 1 Start an Internet browser on your device and then type this system's IP address into the address field to display the settings page.
 - It may take a few minutes until the settings page is displayed depending on the environment. In that case, reload the browser.
- 2 Type a device name and then select "Next".
 - Refer to the step 6 of "Using an Internet browser" (⇒ 20) for details on a device name.
- 3 Select and input the details.
 - If your network requires specific settings, deselect "DHCP" to disable DHCP.
 - You can use specific IP address, subnet mask, default gateway, primary DNS, etc.
- 4 Select "Connect" to apply the settings.
 - When the connection is established, "**LAN**" is indicated on the main unit's display.

Using this system

Preparation

- Turn on the active subwoofer.
- Turn on the TV and/or connected device.

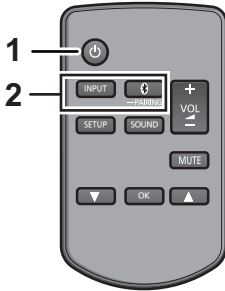

- 1 Press [⏻] to turn on the main unit.
- 2 Select the source.

Press	To select
[INPUT]	<p>Input changes in the following order each time you press [INPUT].</p> <p>"TV" → "BD/DVD" ↑ "BLUETOOTH" ←</p> <ul style="list-style-type: none"> • When switching the source to "BLUETOOTH" and then to "TV" in succession, after switching it to "BLUETOOTH", wait for a while, and press [INPUT].
[Ⓜ -PAIRING]	<p>Select the Bluetooth® device as the source. (⇒ 27)</p>

- This remote control cannot be used to control the operations of the connected devices.

■ When you select "BD/DVD"

Change the input on the TV to the one this unit is connected to, then start play on the device connected to this unit.

■ When you select "BLUETOOTH"

Start play on the Bluetooth® device connected to this unit.

■ To adjust the volume of this system

Press [- VOL +].

- Volume range: 0 to 100

■ To mute the sound

Press [MUTE].

- While muting, "MUTE" is indicated on the display.
- To cancel, press the button again or adjust the volume.
- Muting is cancelled if the main unit is turned off.



If this system does not operate as expected or sound is unusual, returning the settings to the factory preset may solve the problem. (⇒ 35)

- If there is sound coming out of the TV's speakers, reduce the volume of the TV to its minimum.
- There may be a difference in the maximum volume value of the TV and the unit.
- When playing equipment connected to the HDMI AV IN terminal, to switch audio/video to the TV, switch input to the TV tuner. If VIERA Link (HDMI) (⇒ 33) is not enabled, also switch the input of this unit to TV.

Remote control code

When other Panasonic devices respond to this system's remote control, change the remote control code on this system and the remote control.

Preparation

- Turn off all other Panasonic products.
- Turn on the main unit.
- Aim the remote control at this unit's remote control sensor.

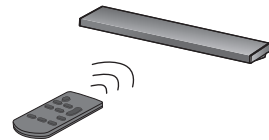

■ To set the code to "REMOTE 2"

While pressing and holding [MUTE], press and hold [OK] for 4 or more seconds.

"REMOTE 2" is indicated on the display.

■ To set the code to "REMOTE 1"

While pressing and holding [MUTE], press and hold [▼] for 4 or more seconds.

"REMOTE 1" is indicated on the display.

Streaming music over the network

You can stream music from your devices or online music services to this system's speakers and other AllPlay speakers.

You can also stream music source of this system to other AllPlay speakers.

For the latest information, refer to the site below.

<http://panasonic.jp/support/global/cs/audio/>
(This site is in English only.)

Streaming music on network devices

You can use the AllPlay or the DLNA function to stream music from the device on the network to this system's speakers by using the app "Panasonic Music Streaming" (free of charge), etc.

 : App Store

 : Google Play™



Preparation

- Complete the network settings. (⇒ 19)
- Connect the following devices to the same network as this system.
 - Device with "Panasonic Music Streaming", etc. installed
 - Device containing music

The following steps are based on "Panasonic Music Streaming". The steps and illustrations may be different depending on the version of the app.

1 Turn this system on.

- Check that "" is indicated on the display.
 - If it is not indicated, check the network settings. (⇒ 19)

2 Start the app "Panasonic Music Streaming".

- Always use the latest version of the app.

3 From "Select Speaker", select this system as the output speakers.

e.g.,

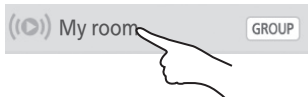

- If you have multiple AllPlay speakers, you can enjoy synchronized sound from them. Select "" and then select the speakers to group.
 - You can also play different songs on other AllPlay speakers at the same time.
 - The number of AllPlay speakers that can perform playback at the same time differs depending on the situation of use.
 - When you turn off one of the AllPlay speakers, other AllPlay speakers in the same group may stop the playback.

4 Select a music source.

- To add music source, select "+ My Music Network" and then select the device containing music.
 - The added music source is numbered in order from 1.

5 Select a song.

- "NETWORK" will be indicated on the main unit's display.



- This system will be displayed as "Panasonic ALL70T" if the device name is not set.
- When playing back music from the DLNA server (PC with Windows 7 or later installed, smartphone, Network Attached Storage (NAS) device, etc.), add the contents and folder to the libraries of the Windows Media® Player, the smartphone, or the NAS device, etc.
 - Playlist of Windows Media® Player can play back only the contents that are stored in the libraries.
- When this system is selected as DLNA speakers ():
 - The volume control on the system may not apply to the app.
 - Playback control using a progress bar on playback screen may not work.
 - The volume level applied to AllPlay speakers will not be reflected.
 - If the system is selected as output speakers by another device, the music source is changed to the new device. However the former device's display may not change.
- About supported format, refer to "Specifications" (⇒ 42).
 - File formats that are not supported by your DLNA server cannot be played.
- Depending on the contents and the connected equipment, playback may not be performed properly.
- Ensure to stop playback on your device before turning it off.

For details on the app "Panasonic Music Streaming", visit

<http://panasonic.jp/support/global/cs/audio/app/>

More apps are available. For details, visit www.panasonic.com/global/consumer/homeav/allseries/service

(These sites are in English only.)

Streaming online music

This system is compatible with several online music services.

Visit the following website for the compatibility information.

www.panasonic.com/global/consumer/homeav/allseries/service

Preparation

- Make sure that the network is connected to the Internet.
- Connect a device with a compatible app installed to the same network as this system.

1 Turn this system on.

- Check that "■" is indicated on the display.
 - If it is not indicated, check the network settings. (⇒ 19)

2 Start the app, and select a song to playback.

■ Using Spotify

You will need Spotify Premium. For details, visit the following website.

www.spotify.com/connect/

After step 2

3 Select the square image of the song's cover art in the bottom left of the playback screen.

4 From "🔊", select this system as the output speakers.

- "Spotify" will be indicated on the main unit's display.
- To enjoy synchronized sound from the multiple AllPlay speakers, you need to group the speakers using the app "Panasonic Music Streaming". (⇒ 24)

■ Using online music services other than Spotify

After step 2

3 From "🔊", select this system as the output speakers.

- "NETWORK" will be indicated on the main unit's display.
- Depending on the service, you might need to open full screen player to display "🔊".
- If you have multiple AllPlay speakers, you can enjoy synchronized sound from them. Select "Group" and then select the speakers to group.



- This system will be displayed as "Panasonic ALL70T" if the device name is not set.
- Registration/subscription is required.
- Fees may apply.
- Services, icons, and specifications are subject to change.
- For details, visit the individual music service's website.

Streaming music on this system to other AllPlay speakers

You can use the app “Panasonic Music Streaming” (⇒ 24) to stream this system’s music source (TV, BD/DVD, BLUETOOTH) to other AllPlay speakers.

For details on the app, refer to the site below.

- Always use the latest version of the app.

<http://panasonic.jp/support/global/cs/audio/app/>

(This site is in English only.)

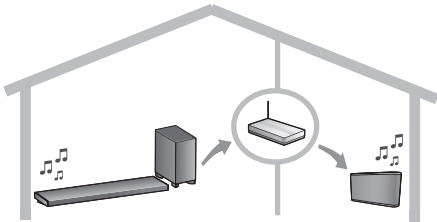

Preparation

- Complete the network settings. (⇒ 19)
- Prepare the desired audio source on this system (e.g. turn on the TV or connected device, etc.).
- Install your device with the app “Panasonic Music Streaming”.
- Connect your device and your AllPlay speakers to the same network as this system.

1 Turn this system on.

- Check that “**W**” is indicated on the display.
 - If it is not indicated, check the network settings. (⇒ 19)

2 Start the app “Panasonic Music Streaming”.



- This system will be displayed as “Panasonic ALL70T” if the device name is not set.
- Sound is output from other AllPlay speakers after a delay of about 1 second.
- If music is streamed to other AllPlay speakers for more than 8 hours, the other AllPlay speakers will automatically stop playing the music.
- Specifications are subject to change without notice.

Bluetooth® operations

By using the Bluetooth® connection, you can listen to the sound of the Bluetooth® audio device from this system wirelessly.

- Refer to the operating instructions of the Bluetooth® device for further instruction on how to connect a Bluetooth® device.

Preparation

- Turn on the Bluetooth® feature of the device and place the device near the main unit.

Bluetooth® pairing

- 1 Press [] -PAIRING] to select “BLUETOOTH”.
 - If “PAIRING” is indicated on the display, go to step 3.
- 2 Press and hold [] -PAIRING] until “PAIRING” is indicated on the display.
- 3 Select “SC-ALL70T” from the Bluetooth® device’s Bluetooth® menu.
 - The MAC address (e.g., 6C:5A:B5:B3:1D:0F) may be displayed before the device name is displayed.
 - If prompted for the passkey on the Bluetooth® device, enter “0000”.
 - Once the Bluetooth® device is connected, the name of the connected device will be indicated on the display for a few seconds.



- You can register up to 8 devices with this system. If a 9th device is paired, the device that has not been used for the longest time will be replaced.

Connecting a paired Bluetooth® device

- 1 Press [] -PAIRING] to select Bluetooth® mode.
- 2 After confirming that “BLUETOOTH READY” is indicated on the display, select “SC-ALL70T” from the Bluetooth® device’s Bluetooth® menu.

■ Disconnecting a Bluetooth® device

Press and hold [] -PAIRING] until the “BLUETOOTH READY” is indicated on the display.



- When “BLUETOOTH” is selected as the source, this system will automatically try and connect to the last connected Bluetooth® device. If the connection attempt fails, try to establish a connection again.
- This system can only be connected to one device at a time.
- To change the sound quality, refer to “LINK MODE”. (⇒ 30)
- When enjoying video contents with this function, the video and audio output may not be synchronised.

One-Touch Connection (Connecting by NFC)

For NFC-compatible Bluetooth® devices (Android™ devices) only

Simply by touching an NFC (Near Field Communication)-compatible Bluetooth® device on the main unit, you can complete all preparations, from registering a Bluetooth® device to establishing a connection.

Preparation

- Turn on the NFC feature of the device.
- Android device version lower than 4.1 requires the installation of the app “Panasonic Music Streaming” (free of charge).
 - 1 Enter “Panasonic Music Streaming” in the search box of Google Play™ to search, and then select “Panasonic Music Streaming”.
 - 2 Start the app “Panasonic Music Streaming” on the device.
 - Follow on-screen instructions on your device.
 - Always use the latest version of the app.

1 Press [] -PAIRING] to select “BLUETOOTH”.

2 Touch and hold your device on the NFC touch area of the main unit []. (⇒ 6)

Do not move the Bluetooth® device until it beeps, displays a message or reacts in some way. Once the Bluetooth® device has reacted, move the device away from the main unit.

- When the registration and connection of the Bluetooth® device is complete, the name of the connected device is indicated on the display for a few seconds.
- The location of the NFC touch area differs depending on the device. When a connection cannot be established even if your Bluetooth® device has touched the NFC touch area of the main unit, change the position of the device or main unit. The condition may also improve if you re-download the dedicated app “Panasonic Music Streaming” and start it up.

3 Start playback on the Bluetooth® device.



- If you touch another device to the main unit, you can update the Bluetooth® connection. The previously connected device will be disconnected automatically.
- When the connection is established, playback may start automatically depending on the type of device being used.
- The One-Touch Connection may not work properly depending on the type of device being used.

3D sound

This system provides a feeling that the sound and the image are as one.

- To change the applied effect, refer to "Sound menu". (⇒ right)

e.g., Image of 3D sound field

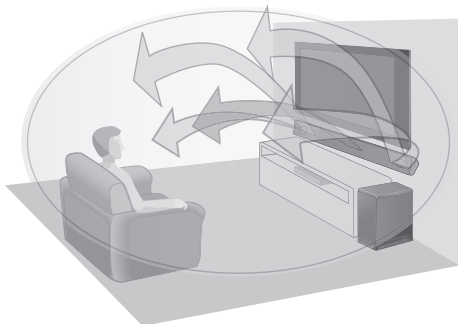

3D sound	
Dolby®Virtual Speaker	With this effect you can enjoy a surround sound effect similar to 5.1ch.
3D surround effect	Adding to the Dolby Virtual Speaker effect, Panasonic has applied its own sound field controlling technology to expand the sound field forwards, backwards, upwards, and downwards, providing a sound with depth and force that better matches 3D images.
Clear-mode dialogue	Sports commentary and dialogues from TV dramas are heard as if the sound is coming from the TV, giving the feeling that the sound and the image are one. Also, the dialogue will stand out from the other sounds during normal volume playback and when the volume is lowered for night time viewing.



- Dolby Virtual Speaker effect is ON except STEREO mode.
- To turn off Dolby Virtual Speaker and the 3D surround effects, select "STEREO" as the sound mode. (⇒ right)
- To turn off the 3D surround and the Clear-mode dialogue effects, refer to "3D CLR DIALOG". (⇒ 29)
- You can also adjust the level of the Clear-mode dialogue effect. (⇒ right)

Sound menu

- 1 Press [SOUND] repeatedly to select the sound effect.
- 2 Press [▼] [▲] repeatedly to select the desired setting and then press [OK].

SOUND MODE	Select the sound mode to suit the TV programme or connected equipment. STANDARD: Best suited for dramas and comedy shows. STADIUM: Produces a realistic sound for live sports broadcasts. MUSIC: Enhance the sound of musical instruments and songs. CINEMA: Produces three-dimensional sound unique to movies. NEWS: Enhance the voice of news and sports commentaries. STEREO: Play any source of sound in stereo.
SUBWOOFER	You can adjust the amount of bass. This system automatically selects the most suitable setting according to the type of playback source. LEVEL 1 LEVEL 2: Default for 2 channel audio source LEVEL 3: Default for multi-channel audio source LEVEL 4 The setting you make is retained and recalled every time you play the same type of source.
DIALOG	Adjust the dialogue level. LEVEL 1 LEVEL 2 LEVEL 3 LEVEL 4 "DIALOG" is not indicated on the display when "3D CLR DIALOG" is set to "OFF".
H.BASS	Enhance the harmonic bass effect. ON OFF

<p>3D CLR DIALOG</p>	<p>The 3D Clear Mode Dialogue feature creates a sound field similar to the sound coming from a TV screen and makes dialogues clearer. <u>ON</u>: 3D Surround, Clear Mode Dialogue and Dolby Virtual Speaker effect OFF: Dolby Virtual Speaker effect The setting is set back to "ON" every time you turn the main unit on.</p>
<p>DUAL AUDIO</p>	<p>Sets the preferred audio channel mode when there are two audio modes received by this system. <u>M1</u>: Main <u>M2</u>: Secondary M1 + M2: Main + Secondary This effect only works if the audio output of the TV or player is set to "Bitstream" and "Dolby Dual Mono" is available in the sound source.</p>
<p>AGC</p>	<p>Auto gain control prevents sudden loud sound by reducing the sound level automatically when the input is too high. This function is suitable for TV broadcast that has sound level difference. <u>ON</u> <u>OFF</u> If the sound becomes unnatural, select "OFF".</p>
<p>LOW VOL MODE</p>	<p>Enhance the dialogue in low volume condition. <u>ON</u> OFF Select "OFF" to cancel this effect if the dialogue does not sound natural in low volume condition.</p>



- The default setting is underlined. Changed settings will be kept until it is changed again, unless otherwise indicated.

Audio format

You can view the current audio format.

Press and hold [SOUND] for more than 4 sec.

<p>DOLBY DIGITAL</p>	<p>Dolby Digital is the audio source.</p>
<p>DTS</p>	<p>DTS® is the audio source.</p>
<p>PCM MULTI</p>	<p>Linear pulse-code modulation is the audio source.</p>
<p>PCM</p>	<p>2 channel pulse-code modulation is the audio source.</p>



- The audio format is displayed for about 2 seconds.
- No audio format is displayed if input to this unit is Bluetooth® or AllPlay/DLNA.

Setup menu

- 1 Press [SETUP] repeatedly to select the setup item.
- 2 Press [▼] [▲] repeatedly to select the desired setting and then press [OK].

DIMMER	<p>Dims the display after 5 seconds of inactivity.</p> <p>ON OFF</p>
BEEP	<p>A beep sounds when you touch the switch on the main unit or when you turn the unit on/off.</p> <ul style="list-style-type: none"> • This works during muting as well. <p>ON OFF</p>
AUTO POWER DOWN	<p>The main unit automatically is turned off if there is no audio input and when you do not use it for approx. 20 minutes.</p> <p>ON OFF</p> <ul style="list-style-type: none"> • When this is set, the display shows "P.OFF 1" to indicate that the main unit will turn off in approximately 1 minute. • If "BLUETOOTH STANDBY", "VIERA LINK" or "NET STANDBY" is set to "ON", this function will also be set to "ON". To change the setting, set "BLUETOOTH STANDBY", "VIERA LINK" and "NET STANDBY" to "OFF". (⇒ 30, 31) – "AUTO POWER DOWN" is not indicated on the display when "BLUETOOTH STANDBY", "VIERA LINK" or "NET STANDBY" is set to "ON".
VOL LIMITATION	<p>Sets the volume limit to 50 when you turn on the main unit although the volume is set to above 50 before it is turned off.</p> <p>ON OFF</p>

BLUETOOTH STANDBY	<p>This function allows you to connect a paired Bluetooth® device when the main unit is in standby mode.</p> <p>ON OFF</p> <p>The main unit will be turned on automatically when you connect a paired Bluetooth® device.</p> <ul style="list-style-type: none"> • If this function is set to "ON", the standby power consumption will increase.
LINK MODE	<p>Change the transmission mode to prioritise transmission quality or sound quality. Make sure that the Bluetooth® device is not connected ("BLUETOOTH READY" is indicated on the display).</p> <p>MODE 1: Emphasis on connectivity. MODE 2: Emphasis on sound quality.</p>
VIERA LINK	<p>Turn on the VIERA Link function.</p> <p>ON OFF</p> <p>Select "OFF" when your HDAVI Control device does not work correctly with this system.</p> <ul style="list-style-type: none"> • ARC will be disabled. Connect an optical digital audio cable. • Turn off all connected devices and then turn them on again after changing the setting.
REAR PAIRING	<p>You can add SC-ALL2 (sold separately) to this system as rear surround speakers.</p> <ul style="list-style-type: none"> • For details, refer to "Rear surround" (⇒ 32)
REAR SPEAKER	<p>You can select to have 5.1 ch output with rear surround speakers (ON) or 3.1 ch output without rear surround speakers (OFF).</p> <p>ON OFF</p>

REAR LEVEL	<p>You can adjust the output level of the rear surround speakers. Pair SC-ALL2 (sold separately) with this system beforehand. (⇒ 32)</p> <ol style="list-style-type: none"> 1 Press [▼] [▲] to select the output level of the left surround speaker and press [OK]. (REAR L) 2 Press [▼] [▲] to select the output level of the right surround speaker and press [OK]. (REAR R) <ul style="list-style-type: none"> • You can adjust the output level between -6 and +6. The default setting is 0. • If only one rear surround speaker has been paired or if both are set in the same channel, either "REAR L" or "REAR R" is displayed. • "REAR LEVEL" is not indicated on the display when "REAR SPEAKER" is set to "OFF" or a rear surround speaker is not linked to this system.
NET SETUP	<p>You can choose how to connect to a network.</p> <ul style="list-style-type: none"> • For details, refer to "Step 4 Network settings" (⇒ 19)
NET INFO	<p>You can confirm the IP address allocated to this system, the MAC address of this system, and the network name (SSID) of this system.</p> <p>IP ADDR MAC ADDR SSID</p> <ul style="list-style-type: none"> • Characters that cannot be displayed are replaced with " * ".
SIGNAL LEVEL	<p>You can check the signal strength of the wireless connection.</p> <ul style="list-style-type: none"> • The signal strength is displayed when you press [OK] while "SIGNAL LEVEL" is being displayed. Press [OK] again to stop the display. • It is recommended to have a signal strength of "LEVEL 3". Change the position or angle of your wireless network router or this system if the indication is "LEVEL 2" or "LEVEL 1" and see if the connection improves. • If "LEVEL 0" is displayed, this system cannot establish a link with the wireless network router. • "WIRED LAN" is displayed when connected with a LAN cable.

NET STANDBY	<p>This system can turn on automatically from standby mode when this system is selected as the AllPlay/DLNA speakers.</p> <ul style="list-style-type: none"> • This function normally switches to "ON" while this system is connected to a network. <ul style="list-style-type: none"> - To turn off this function, select "OFF" and then select a source other than "NETWORK" before switching this system to standby mode. <p>ON OFF</p> <ul style="list-style-type: none"> • If this function is set to "ON" the standby power consumption will increase. • When the system is turned on by this feature, the beginning part of the music may not be played back. • Depending on the app, the conditions for activating this function may differ. • The system may not turn on even when selected as the output speakers. In that case, start playback.
WIRELESS LAN	<p>The wireless LAN function can be enabled or disabled.</p> <p>ON OFF</p>
F/W VERSION	<p>You can check the firmware version.</p> <ul style="list-style-type: none"> • The version of the installed firmware is displayed when you press [OK] while "F/W VERSION" is being displayed. Press [OK] again to stop the display.
F/W UPDATE	<p>You can update the firmware of this system.</p> <ul style="list-style-type: none"> • For details, refer to "Firmware update" (⇒ 32)



- The default setting is underlined. Changed settings will be kept until it is changed again, unless otherwise indicated.

Firmware update

Occasionally, Panasonic may release updated firmware for this system that may add or improve the way a feature operates. These updates are available free of charge.

- After connecting to the network, “NEW FIRMWARE FOUND/PRESS[OK]” is displayed on the display of the main unit when a downloadable piece of new firmware is found. The “F/W UPDATE” display from step 1 is displayed when you press [OK].

You can also update the firmware from a pop-up prompting you to do so on-screen within the app “Panasonic Music Streaming” (⇒ 24). For details on the app, refer to the site below.

- Always use the latest version of the app.

<http://panasonic.jp/support/global/cs/audio/app/>
(This site is in English only.)

Preparation

- Complete the network settings. (⇒ 19)
 - Make sure that the network is connected to the Internet. (⇒ 19)
- 1 Press [SETUP] repeatedly to select “F/W UPDATE”.
 - 2 Press [▼] [▲] to select “UPDATE YES” and then press [OK] to start the update.
 - “WAIT” blinks on the display.

DO NOT DISCONNECT the AC mains lead while one of the following messages is displayed.

“UPDATING” or “□□□ %”
(“□” stands for a number.)

- During the update process, no other operations can be performed.

After the update has finished, “SUCCESS” is displayed, and then “PLEASE DISCONNECT AC MAINS LEAD” scrolls.

- 3 Disconnect the AC mains lead and reconnect it after 3 minutes.



- If there are no updates, “NO NEED” is displayed.
- Downloading will require about 15 minutes. It may take longer or may not work properly depending on the connection environment.
- You cannot output sound from this unit while updating the firmware.
- To view the TV during update, change the settings on the TV to have the sound output from the TV’s speakers. Refer to the operating instructions of the TV for details.

Rear surround

You can add two Panasonic SC-ALL2 (sold separately)* as rear surround speakers to enjoy 5.1 ch surround sound.

※ This product is set to be released in June 2015.

You can add the SC-ALL2 speakers as rear surround speakers using the app “Panasonic Music Streaming” (⇒ 24). For details on the app, refer to the site below.

- Always use the latest version of the app.

<http://panasonic.jp/support/global/cs/audio/app/>
(This site is in English only.)

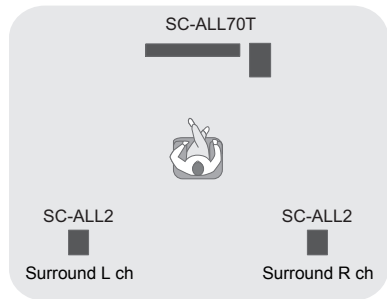

■ Operation with this system

Preparation

- Turn this system and SC-ALL2 on.
- 1 Press [SETUP] on the remote control repeatedly to select "REAR PAIRING".
 - 2 Press [▼] [▲] on the remote control to select "YES" and then press [OK].
 - This system enters the pairing mode and "REAR1 PAIRING" is displayed on the display of the main unit.
 - 3 Start the pairing mode on SC-ALL2.
 - Refer to the operating instructions for SC-ALL2.
 - When pairing with the first speaker finishes, pairing starts with the second speaker and "REAR2 PAIRING" is displayed on the display of the main unit.
 - Make the left and right surround speaker settings on SC-ALL2.

When pairing with both speakers finishes, "PAIRED" is displayed on the display of the main unit.

- When pairing is successful, "REAR SPEAKER" (⇒ 30) comes "ON" automatically and the output setting changes to 5.1 ch.
- If you try to set left and right surround speakers to the same channel on SC-ALL2, pairing fails and "NOT COMPLETED" is displayed on the display of the main unit. Repeat the procedure from the beginning if this occurs.



- The pairing mode is cancelled after about 120 seconds elapses. You can also press [⏏] to cancel it.
- You cannot cancel pairing on this system. Cancel pairing on SC-ALL2.
- The power on paired SC-ALL2 is linked to this system.
 - They remain linked even when the "REAR SPEAKER" (⇒ 30) is "OFF".
- There is no way of adjusting delay time with this system.
- If one of the speakers fails to pair, repeat the procedure from the beginning. When you do so, "REAR PAIRING" is displayed during pairing and "PAIRED" is displayed when pairing is successful.
- You can adjust the output level of the rear surround speakers. (⇒ 31, "REAR LEVEL")

Linked operations with the TV (VIERA Link "HDAVI Control™")

What is VIERA Link "HDAVI Control"?

VIERA Link "HDAVI Control" is a convenient function that offers linked operations of this system, and a Panasonic TV (VIERA) under "HDAVI Control".

You can use this function by connecting the equipment with an HDMI cable. See the operating instructions for connected equipment for operational details.

Preparation

- ① Confirm that the HDMI connection has been made. (⇒ 9, 10, 11)
- ② Set the "HDAVI Control" operations on the connected equipment (e.g., TV).
- ③ For the optimal "HDAVI Control" operations change the following settings on the connected TV*1.
 - Set the default speaker settings to this system.*2
 - Set the speaker selection settings to this system.
- ④ Turn on all "HDAVI Control" compatible equipment and select the TV's input for this system so that the "HDAVI Control" function works properly.
- ⑤ If a device is connected to the HDMI AV IN terminal, start play to check that the picture is displayed on the TV correctly.

When the connection or settings are changed, repeat this procedure.

- *1 The availability and function of the settings may vary depending on the TV. Refer to the operating instructions for the TV for details.
- *2 If the TV has a default speaker setting within the VIERA Link setting items, choosing this system as the default speaker will automatically change the speaker selection to this system.



- VIERA Link "HDAVI Control", based on the control functions provided by HDMI which is an industry standard known as HDMI CEC (Consumer Electronics Control), is a unique function that we have developed and added. As such, its operation with other manufacturers' equipment that supports HDMI CEC cannot be guaranteed.
- This unit supports "HDAVI Control 5" function. "HDAVI Control 5" is the standard for Panasonic's HDAVI Control compatible equipment. This standard is compatible with Panasonic's conventional HDAVI equipment.
- Please refer to individual manuals for other manufacturers' equipment supporting VIERA Link function.

What you can do with VIERA Link "HDAVI Control"

To make sure that the audio is output from this system, turn the main unit on by using the TV's remote control and selecting home cinema from the speaker menu of VIERA Link menu. The availability and function of the settings may vary depending on the TV. Refer to the operating instructions for the TV for details.

■ Speaker control

You can select whether audio output is from this system or the TV speakers by using the TV menu settings.

Home cinema

This system is active.

- When the main unit is in standby mode, changing the TV speakers to this system in the VIERA Link menu will automatically turn the main unit on.
- You can control the volume setting of this system using the volume or mute button on the TV remote control.
- If you turn off the main unit, TV speakers will be automatically activated.
- Audio will automatically be output from this system if the TV is compatible to VIERA Link "HDAVI Control 4" or later.

TV

TV speakers are active.

- The volume of this system is set to its minimum.

■ Automatic input switching

When the following operations are performed, the main unit will automatically change the input to the corresponding source.

- When play starts on an HDMI connected device.*³
- When the TV input or the TV channel is changed.

*³ If the speaker output setting on the TV is set to this system, the TV and the main unit turn on automatically (Power on link).

■ Power off link

When the TV is turned off, the main unit also turns off automatically. (This function does not work when Bluetooth® or AllPlay/DLNA is the source.)

■ Automatic lip-sync function

(for HDAVI Control 3 or later)

Delay between audio and video is automatically adjusted by adding time-lag to the audio output, enabling you to enjoy smooth audio for the picture.



- It may take up to 8 seconds for sound to be output from this unit after turning the TV (VIERA) on. You can reduce the amount of time it takes for sound to be output by using an optical digital audio cable. If you do so, reconnect the HDMI cable to a non-ARC compatible HDMI terminal on the TV (VIERA). (⇒ 10)
- The delay information is automatically set if the TV is compatible to VIERA Link "HDAVI Control 3" or later and the VIERA Link is set to on. The setting causes a sound delay of approximately 0.04 seconds when connected to a Panasonic TV (VIERA) with VIERA Link (HDMI) version 2 or earlier or a TV from another manufacturer.

Troubleshooting

Before requesting service, make the following checks. If you are in doubt about some of the check points, or if the solutions indicated in the following guide do not solve the problem, consult your dealer for instructions.

If this system does not operate as expected, returning the settings to the factory preset may solve the problem.

To return to the factory preset.

- ① While the main unit is on, touch and hold [⏻/⏪] on the main unit until "PLEASE WAIT" is indicated on the display. ("RESET" is indicated on the display when this system is reset.)
- ② Turn the unit off, then turn it on again.
 - The remote control code will return to "REMOTE 1" when this system is returned to the factory preset. To change the remote control code, refer to "Remote control code" (⇒ 23).

General operation

No power.

- Unplug the AC mains lead for 10 sec before plug in again.
- After turning the main unit on, if the main unit immediately turns off, unplug the AC mains lead and consult your dealer.
- If the main unit does not turn on by turning on TV (HDAVI control), turn on the main unit manually.
If the problem persists, refer to "HDMI" in "Troubleshooting".

The remote control does not work properly.

- The battery is depleted. Replace it with a new one. (⇒ 8)
- It is possible that the insulation sheet has not been removed. Remove the insulation sheet. (⇒ 8)
- It may be necessary to set the code of the remote control again after changing the battery of the remote control. (⇒ 23)
- Use the remote control within the correct operation range. (⇒ 8)

The main unit is automatically switched to standby mode.

"AUTO POWER DOWN" function is on.
The main unit will automatically switch to standby mode when no signal is input and no operation is performed for approx. 20 minutes. Refer to page 30 to turn this function off.

The main unit is turned off when the TV's speakers are selected in the speaker control.

This is a normal feature when using VIERA Link (HDAVI Control 4 or later). Please read the operating instructions for the TV for details about its power save feature. (⇒ 33)

The switches on the main unit do not work.

[⏻/⏪], [VOL -], [VOL +], [INPUT], and [⚙️ -PAIRING] on the main unit are touch keys. Touch the switches with your finger. They may not work if operated with your fingernails or hands wearing gloves.

Colour irregularities on a CRT TV.

If colour irregularities appear on the TV, turn off the TV for about 30 minutes and move TV away from this unit slightly. If this does not fix the problem, move this unit away from the TV.

HDMI

This system does not operate correctly.

If the HDMI cable is connected to the wrong terminal (HDMI AV IN or HDMI AV OUT), this system will not operate correctly. Turn the main unit off, disconnect the AC mains lead and reconnect the HDMI cable(s). (⇒ 9, 10, 11)

VIERA Link related operations no longer function properly.

- Check the VIERA Link setting on the connected devices.
 - Turn on VIERA Link function on the connected devices.
 - Select this system as the speaker in the TV's VIERA Link menu.
 - Have you turned the VIERA Link settings off? (⇒ 30)
 - When the HDMI connections are changed, after a power failure or after the AC mains lead has been removed, VIERA Link operations may not function properly.
 - Turn on all the devices that are connected to the TV with an HDMI cable and then turn the TV on.
 - Turn off the VIERA Link settings of the TV and turn it on again. For details refer to the operating instructions for the TV.
 - While the main unit and the TV are connected with the HDMI cable, turn on the TV and then remove the main unit's AC mains lead and reconnect it again.
-

The first few seconds of audio cannot be heard when using the HDMI connection.

This may occur during DVD-Video chapter playback. Change the digital audio output setting on the connected device from "Bitstream" to "PCM".

When operating an HDMI compatible device of a different brand, the main unit reacts in an unwanted manner.

HDAVI Control commands may use a different signal depending on the brand of the device. In this case, turn VIERA Link off. (⇒ 30)

When the main unit is turned on or off, audio and video are temporarily disabled.

When the main unit is turned on or off it is normal for the audio and video to be temporarily disabled. This is not a malfunction. This can occur when the device it is connected to, via HDMI, does not support Panasonic's VIERA Link feature (HDAVI Control 3 or later).

The images from this system do not appear on the TV.

When outputting in 60p (4K), images may be distorted depending on the HDMI cable. Use High Speed HDMI cables which support 18 Gbps bandwidth.

Bluetooth®

Pairing cannot be done.

Check the Bluetooth® device condition.

The device cannot be connected.

- The pairing of the device was unsuccessful or the registration has been replaced. Try pairing the device again. (⇒ 27)
- This system might be connected to a different device. Disconnect the other device and try pairing the device again.

The device is connected but audio cannot be heard through this system.

For some Bluetooth® devices, you have to set the audio output to “SC-ALL70T” manually. Read the operating instructions for the device for details.

Connection is interrupted.

Sound is interrupted/sound skips/there is a lot of noise.

- Remove any obstacle between the main unit and the device.
- Other devices that use the 2.4 GHz frequency band (wireless router, microwaves, cordless phones, etc.) are interfering. Bring the Bluetooth® device closer to the main unit and distance it from the other devices.
- Select “MODE 1” for stable communication. (⇒ 30)

If the above does not fix the problem, you may be able to fix the problem by reconnecting this unit and the Bluetooth® device. (⇒ 27)

The One-Touch Connection (NFC feature) is not working.

- Make sure the main unit and the NFC feature of the device are turned on. (⇒ 27)
- Change the touch location of the Bluetooth® device or main unit and then touch the NFC touch area again.

Sound

No sound (or image).

- Turn muting off. (⇒ 23)
- Check the connections to the other devices. (⇒ 9, 10, 11)
- Make sure that the received audio signal is compatible with this system. (⇒ 42)
- Turn this system off and then on again.
- If the main unit is connected to the TV with only an HDMI cable, make sure that the TV’s HDMI terminal is labelled “HDMI (ARC)”. If not, connect using the optical digital audio cable. (⇒ 9)
- If the main unit is connected to a Panasonic TV and turned on using the remote control or the touch key on the main unit, sound might not be output from this system. In this case, turn the main unit on using the TV’s remote control. (⇒ 33)
- If the connections are correct, there might be a problem with the cables. Redo the connections with different cables.
- Check the audio output settings on the connected device.

The dual audio cannot be changed from main to secondary.

If the audio received from the connected device is not “Dolby Dual Mono” or the output setting is not “Bitstream”, the setting cannot be changed from this system. Change the setting on the connected device.

The volume is lowered when the main unit is turned on.

“VOL LIMITATION” is on.

If the main unit is turned off with the volume setting in the greater half (above 50), the main unit will automatically lower the volume to the middle (50) when the main unit is turned on. (⇒ 30)

The dialogue is too persistent or the dialogue does not sound natural.

This system has a function to make the dialogue stand out when the volume is low. (⇒ 29)

The sound lags behind the image.

Depending on the TV, when this unit is connected to it via Bluetooth®, the sound output from this unit may lag behind the TV image.

Connect this unit and the TV with an HDMI cable/optical digital audio cable. (⇒ 9, 10)

Sound stops.

The power of the main unit turns off automatically.

(When the main unit detects a problem, a safety measure is activated and the main unit automatically switches to standby mode.)

- There is a problem with the amplifier.
- Is the volume extremely high?
If so, lower the volume.
- Is this system placed in an extremely hot place?
If so, move this system to a cooler place and wait a few moments and then try to turn it on again.

If the problem persists, confirm the display, turn this system off, remove the AC mains lead cord and consult your dealer. Please be sure to remember the display that was indicated and inform the dealer.

Network

Cannot connect to the network.

- This system's Wi-Fi security supports WPA2™ only. Your wireless router must therefore be WPA2™ compatible. For details on the security supported by your router and how to change the settings, please refer to the operating instructions or contact your Internet service provider.
 - If the network is set to be invisible, make the network visible while you set up the network for this system or make a wired LAN connection. (⇒ 22)
 - Make sure that the multicast function on the wireless router is enabled.
 - Depending on the routers, WPS button may not work. Try other methods. (⇒ 19)
-

Cannot select this system as the output speakers.

- Make sure that the devices are connected to the same network as this system.
 - Reconnect the devices to the network.
 - Turn off and then on the wireless router.
-

Playback does not start.

The sound is interrupted.

- If using the 2.4 GHz band on the wireless router, simultaneous use with other 2.4 GHz devices, such as microwaves, cordless telephones, etc., may result in connection interruptions. Increase the distance between this system and these devices.
 - If your wireless router supports 5 GHz band, try using the 5 GHz band.
To change to the 5 GHz band, restore the factory defaults (⇒ 35), and redo the network settings using an Internet browser (⇒ 20).
On the step 8, make sure to select your network name (SSID) for the 5 GHz band.
- Do not place this system inside a metal cabinet, for it might block the Wi-Fi signal.
- Place this system closer to the wireless router.
- If several wireless devices are simultaneously using the same network as this system, try turning off the other devices or reducing their network usage.
- Reconnect the devices to the network.
- Turn off and then on the wireless router.
- Try a wired LAN connection. (⇒ 22)
- Restart the app.

Active Subwoofer

No power.

Ensure the AC mains lead of the active subwoofer is connected properly.

After turning the subwoofer on, it immediately turns off.

Unplug the AC mains lead and consult your dealer.

No sound from the subwoofer.

- Check that the active subwoofer is turned on.
 - Check that the WIRELESS LINK indicator lights green. (⇒ 19)
-

The WIRELESS LINK indicator lights red.

- There is no link between the main unit and the active subwoofer.
 - Check that the main unit is turned on.
 - Turn the active subwoofer off and then back on. Alternatively, turn the active subwoofer off, disconnect the AC mains lead and then reconnect it.
- The active subwoofer and the main unit may not be paired correctly. Try the following operation. (Wireless pairing)
 - ① Turn on the main unit and active subwoofer.
 - ② Press and hold [I/D SET] on the rear of the active subwoofer for more than 3 sec. (The WIRELESS LINK indicator will blink in red.)
 - ③ While pressing and holding [INPUT] on remote control, touch and hold [VOL +] on the main unit for more than 4 sec. (“SUBWOOFER PAIRING” will be indicated on the display.)
 - When the wireless pairing is successful, “PAIRED” will be indicated on the display for 2 sec and WIRELESS LINK indicator lights green.
 - ④ Turn the main unit off and on.
- Consult your dealer if the problem persists.

Main unit displays

“F61”

- There is a problem with the amplifier of the system.
 - Disconnect the AC mains lead and consult the dealer.
-

“F70 HDMI” / “U701” / “U703”

- Check HDMI connection.
 - Turn off the main unit and then switch it on again.
 - Disconnect the HDMI cable.
-

“F703” / “F704”

- Turn off the main unit and then switch it on again.
 - Consult your dealer if the problem persists.
-

“F76”

- There is a problem with the power supply.
 - Disconnect the AC mains lead and consult the dealer.
-

“U704”

This system is receiving unsupported video format signal from the input source.

- Change the video resolution setting on the connected device. (Refer to the operating instructions for the device.)
 - If there is no image, connect the device directly to the TV to change the settings.
-

“U705”

The TV's HDMI terminal connected to the main unit or the TV's setting is not compatible with the HDCP 2.2 playback source.

- Ensure to connect to the TV's HDCP 2.2 compatible terminal.
 - Ensure the TV's HDMI HDCP setting corresponds to HDCP 2.2. (Refer to the operating instructions for the TV.)
-

“DL ERROR”

The firmware download has failed. Press [OK] to exit. Please try again later.

“FAIL”

Setting has failed. Read the instructions and try again.

“LINKING”

- This system is trying to connect to the last connected Bluetooth® device when “BLUETOOTH” is selected.
 - This system is communicating with the wireless router to complete the network settings.
Depending on the wireless router this process may take a few minutes. Try moving this system closer to the wireless router.
-

“NO CONNECT”

This system cannot connect to the network. Check the network connection. (⇒ 19)

“REMOTE □” (“□” stands for a number.)

The remote control and this system are using different codes. Change the code on the remote control. (⇒ 23)

“WIRED LAN”

Connection to the network is via a wired LAN connection.

- When setting up wireless connection, disconnect the LAN cable from this system.
-

“WIRELESS LAN OFF”

The wireless LAN function on this system is disabled.

- When setting up wireless connection, set the “WIRELESS LAN” setting to “ON”. (⇒ 31)
-

“WAIT”

- This is displayed, for example, when this system is turning off.
 - This is flashing when the system is trying to enter a network setting mode.
-

“” blinks

- This may occur when, for instance, the network connection is interrupted.

About Bluetooth®

Panasonic bears no responsibility for data and/or information that is compromised during a wireless transmission.

■ Frequency band used

This system uses the 2.4 GHz frequency band.

■ Certification of this device

- This system conforms to frequency restrictions and has received certification based on frequency laws. Thus, a wireless permit is not necessary.
- The action below are punishable by law in some countries:
 - Taking apart or modifying the unit.
 - Removing specification indications.

■ Restrictions of use

- Wireless transmission and/or usage with all Bluetooth® equipped devices is not guaranteed.
- All devices must conform to standards set by Bluetooth SIG, Inc.
- Depending on the specifications and settings of a device, it can fail to connect or some operations can be different.
- This system supports Bluetooth® security features. But depending on the operating environment and/or settings, this security is possibly not sufficient. Transmit data wirelessly to this system with caution.
- This system cannot transmit data to a Bluetooth® device.

■ Range of use

Use this device at a maximum range of 10 m.

The range can decrease depending on the environment, obstacles or interference.

■ Interference from other devices

- This system may not function properly and troubles such as noise and sound jumps may arise due to radio wave interference if the main unit is located too close to other Bluetooth® devices or the devices that use the 2.4 GHz band.
- This system may not function properly if radio waves from a nearby broadcasting station, etc. are too strong.

■ Intended usage

- This system is for normal, general use only.
- Do not use this system near equipment or in an environment that is sensitive to radio frequency interference (example: airports, hospitals, laboratories, etc.).

Unit care

■ Clean this system with a soft, dry cloth

- When dirt is heavy, wring a cloth moistened in water tightly to wipe the dirt, and then wipe it with a dry cloth.
- When cleaning the speakers, use a fine cloth. Do not use tissues or other materials (towels, etc.) that can fall apart. Small grains may get stuck inside the speaker cover.
- Never use alcohol, paint thinner or benzine to clean this system.
- Before using chemically-treated cloth, carefully read the instructions that came with the cloth.

■ To dispose or transfer this system

This system may keep the user settings information in the main unit. If you discard the main unit either by disposal or transfer, then follow the procedure to return all the settings to the factory presets to delete the user settings. (⇒ 35, "To return to the factory preset.")

- The operation history may be recorded in the memory of the main unit.

Licenses

Manufactured under license from Dolby Laboratories. Dolby, Pro Logic, and the double-D symbol are trademarks of Dolby Laboratories.
For DTS patents, see http://patents.dts.com . Manufactured under license from DTS Licensing Limited. DTS, the Symbol, & DTS and the Symbol together are registered trademarks, and DTS Digital Surround is a trademark of DTS, Inc. © DTS, Inc. All Rights Reserved.
HDMI, the HDMI Logo, and High-Definition Multimedia Interface are trademarks or registered trademarks of HDMI Licensing LLC in the United States and other countries.
HDAVI Control™ is a trademark of Panasonic Corporation.
The Bluetooth® word mark and logos are registered trademarks owned by Bluetooth SIG, Inc. and any use of such marks by Panasonic Corporation is under license. Other trademarks and trade names are those of their respective owners.
Google Play and Android are trademarks of Google Inc.

Qualcomm® AllPlay™ smart media platform is a product of Qualcomm Connected Experiences, Inc. Qualcomm is a trademark of Qualcomm Incorporated, registered in the United States, and other countries and used with permission. AllPlay and the AllPlay icon are trademarks of Qualcomm Connected Experiences, Inc., and used with permission.
This product incorporates Spotify software which is subject to 3rd party licenses found here: www.spotify.com/connect/third-party-licenses
DLNA, the DLNA Logo and DLNA CERTIFIED are trademarks, service marks, or certification marks of the Digital Living Network Alliance.
App Store is a service mark of Apple Inc.

The Wi-Fi CERTIFIED™ Logo is a certification mark of Wi-Fi Alliance®. The Wi-Fi Protected Setup™ Identifier mark is a certification mark of Wi-Fi Alliance®. "Wi-Fi®" is a registered trademark of Wi-Fi Alliance®. "Wi-Fi Protected Setup™", "WPA™", and "WPA2™" are trademarks of Wi-Fi Alliance®.
Windows is a trademark or a registered trademark of Microsoft Corporation in the United States and other countries.
MPEG Layer-3 audio coding technology licensed from Fraunhofer IIS and Thomson.
FLAC Decoder Copyright (C) 2000,2001,2002,2003,2004,2005,2006,2007, 2008,2009 Josh Coalson Redistribution and use in source and binary forms, with or without modification, are permitted provided that the following conditions are met: <ul style="list-style-type: none"> – Redistributions of source code must retain the above copyright notice, this list of conditions and the following disclaimer. – Redistributions in binary form must reproduce the above copyright notice, this list of conditions and the following disclaimer in the documentation and/or other materials provided with the distribution. – Neither the name of the Xiph.org Foundation nor the names of its contributors may be used to endorse or promote products derived from this software without specific prior written permission. THIS SOFTWARE IS PROVIDED BY THE COPYRIGHT HOLDERS AND CONTRIBUTORS "AS IS" AND ANY EXPRESS OR IMPLIED WARRANTIES, INCLUDING, BUT NOT LIMITED TO, THE IMPLIED WARRANTIES OF MERCHANTABILITY AND FITNESS FOR A PARTICULAR PURPOSE ARE DISCLAIMED. IN NO EVENT SHALL THE FOUNDATION OR CONTRIBUTORS BE LIABLE FOR ANY DIRECT, INDIRECT, INCIDENTAL, SPECIAL, EXEMPLARY, OR CONSEQUENTIAL DAMAGES (INCLUDING, BUT NOT LIMITED TO, PROCUREMENT OF SUBSTITUTE GOODS OR SERVICES; LOSS OF USE, DATA, OR PROFITS; OR BUSINESS INTERRUPTION) HOWEVER CAUSED AND ON ANY THEORY OF LIABILITY, WHETHER IN CONTRACT, STRICT LIABILITY, OR TORT (INCLUDING NEGLIGENCE OR OTHERWISE) ARISING IN ANY WAY OUT OF THE USE OF THIS SOFTWARE, EVEN IF ADVISED OF THE POSSIBILITY OF SUCH DAMAGE.

Specifications

AMPLIFIER SECTION

RMS output power (non-simultaneous drive)	
Front ch (L, R ch)	70 W per channel (1 kHz, 10 %, 6 Ω)
Centre ch (C ch)	70 W per channel (1 kHz, 10 %, 6 Ω)
Subwoofer ch	140 W per channel (100 Hz, 10 %, 3 Ω)
Total RMS output power	350 W

TERMINAL SECTION

HDAVI Control	This unit supports "HDAVI Control 5" function.
HDMI AV input (BD/DVD)	1
Input connector	Type A (19 pin)
HDMI AV output (TV (ARC))	1
Output connector	Type A (19 pin)
Digital audio input (TV)	
Optical digital input	Optical terminal
Sampling frequency	32 kHz, 44.1 kHz, 48 kHz 88.2 kHz, 96 kHz (only LPCM)
Audio format	LPCM, Dolby Digital, DTS Digital Surround™
IR Blaster	
Terminal Type	3.5 mm jack
USB Port	For service use only.
LAN Port	10 Base-T /100 Base-TX

SPEAKER SECTION

Front speakers (Built-in, L/R/C)	
Full range	6.5 cm cone type × 1/ch
Active subwoofer	
Woofer	16 cm cone type × 1

GENERAL

Power consumption	
Main unit	42 W
Active subwoofer	30 W
In standby condition	
Main unit	
When "Network Standby"*1 is "OFF"	Approx. 0.48 W
When "Network Standby"*1 is "ON"	Approx. 3.0 W
Active subwoofer	
Power switch off	Approx. 0.48 W
The wireless link is not activated	Approx. 1.0 W

Power supply	AC 220 V to 240 V, 50 Hz
---------------------	--------------------------

Dimensions (W×H×D)	
Main unit	
For table top layout	950 mm×55 mm×120 mm
For wall mounting layout	950 mm×125.5 mm×57.2 mm
Active subwoofer	180 mm×378 mm×303 mm

Mass	
Main unit	
For table top layout	Approx. 2.5 kg
For wall mounting layout	Approx. 2.5 kg
Active subwoofer	Approx. 4.7 kg
Operating temperature range	0 °C to +40 °C

Operating humidity range	20 % to 80 % RH (no condensation)
---------------------------------	-----------------------------------

Wi-Fi SECTION

WLAN Standard	IEEE802.11a/b/g/n
Frequency range	2.4 GHz band / 5 GHz band
Security	WPA2™
WPS version	Version 2.0

Audio support format (AirPlay)

MP3/AAC	
Sampling frequency	32/44.1/48 kHz
Audio word size	16 bit
Channel count	2 ch
Bit-rate	8-320 kbps

FLAC/ALAC/WAV	
Sampling frequency	32/44.1/48/88.2/96/176.4/192 kHz
Audio word size	16 bit, 24 bit
Channel count	2 ch

Audio support format (DLNA)

MP3	
Sampling frequency	32/44.1/48 kHz
Audio word size	16 bit
Channel count	2 ch
Bit-rate	8-320 kbps

FLAC/WAV	
Sampling frequency	32/44.1/48/88.2/96/176.4/192 kHz
Audio word size	16 bit, 24 bit
Channel count	2 ch

WIRELESS SECTION

Frequency Range	2.40335 GHz to 2.47735 GHz
No. of channels	38

Bluetooth® SECTION

Bluetooth® system specification	Bluetooth® Ver.2.1 +EDR
Wireless equipment classification	Class 2 (2.5 mW)
Supported profiles	A2DP
Frequency band	2.4 GHz band FH-SS
Operating distance	Approx. 10 m Line of Sight*2
Supported codec	SBC



- Specifications are subject to change without notice.
 - Mass and dimensions are approximate.
 - Total harmonic distortion is measured by a digital spectrum analyzer.
 - Uncompressed FLAC files may not operate correctly.
 - High sampling audio format (above 88.2 kHz) play with down-sampling as below.
88.2 kHz/96 kHz/176.4 kHz/192 kHz → 48 kHz
- ※ 1 "Network Standby" means "BLUETOOTH STANDBY", "VIERA LINK" and "NET STANDBY".
- ※ 2 Prospect communication distance.
Measurement environment.
(Temperature 25 °C, Height 1.0 m)

CE 0560

English

Declaration of Conformity (DoC)

Hereby, "Panasonic Corporation" declares that this product is in compliance with the essential requirements and other relevant provisions of Directive 1999/5/EC.

Customers can download a copy of the original DoC to our R&TTE products from our DoC server:
<http://www.doc.panasonic.de>

Contact to Authorised Representative: Panasonic Marketing Europe GmbH,
Panasonic Testing Centre, Winsbergring 15, 22525 Hamburg, Germany

This product is intended to be used in the following countries. GB, DE, AT, BE, DK, SE, FR, IT, ES, NL, FI, GR, PT, PL, HU, CZ, SK, EE, LV, LT, SI, BG, RO, MT, CY, IE, LU, HR, NO, CH, IS, LI, TR

This product is intended for general consumer. (Category 3)

The WLAN feature of this product shall exclusively be used inside buildings.

This product on purpose to connect to access point of 2.4 GHz or 5 GHz WLAN.

Ελληνικά

Δήλωση συμμόρφωσης (DoC)

Με την παρούσα, η "Panasonic Corporation" δηλώνει ότι το προϊόν αυτό είναι σύμφωνο με τις βασικές απαιτήσεις και άλλες σχετικές διατάξεις της οδηγίας 1999/5/EC.

Οι πελάτες μπορούν να κατεβάσουν ένα αντίγραφο του πρωτοτύπου DoC για τα R&TTE προϊόντα μας από τον DoC server μας:
<http://www.doc.panasonic.de>

Στοιχεία επικοινωνίας Εξουσιοδοτημένου Αντιπροσώπου:
Panasonic Marketing Europe GmbH,
Panasonic Testing Centre, Winsbergring 15, 22525 Hamburg, Γερμανία

Αυτό το προϊόν προορίζεται να χρησιμοποιηθεί στις ακόλουθες χώρες. GB, DE, AT, BE, DK, SE, FR, IT, ES, NL, FI, GR, PT, PL, HU, CZ, SK, EE, LV, LT, SI, BG, RO, MT, CY, IE, LU, HR, NO, CH, IS, LI, TR

Αυτό το προϊόν προορίζεται για καταναλωτές. (Κατηγορία 3)

Το χαρακτηριστικό WLAN του προϊόντος αυτού πρέπει να χρησιμοποιείται αποκλειστικά και μόνο στο εσωτερικό κτίριών.

Το προϊόν αυτό αποσκοπεί στη σύνδεση με σημείο πρόσβασης (access point) των 2,4 GHz ή 5 GHz WLAN.

Português

Declaração de Conformidade (DoC)

Com o presente documento, a "Panasonic Corporation" declara que este produto é conforme os requisitos específicos e demais especificações referentes à Directriz 1999/5/EC.

Os clientes podem baixar uma cópia da declaração de conformidade (DoC) para nossos produtos R&TTE do Server DoC:
<http://www.doc.panasonic.de>

Contacto o representante autorizado: Panasonic Marketing Europe GmbH,
Panasonic Testing Centre, Winsbergring 15, 22525 Hamburg, Alemanha

Este produto deve ser usado nos seguintes países.

GB, DE, AT, BE, DK, SE, FR, IT, ES, NL, FI, GR, PT, PL, HU, CZ, SK, EE, LV, LT, SI, BG, RO, MT, CY, IE, LU, HR, NO, CH, IS, LI, TR

Este produto destina-se ao consumidor geral. (Categoria 3)

A característica WLAN deste produto pode ser usada exclusivamente na estrutura interna.

Este produto deve ser ligado somente a conexões 2,4 GHz ou 5 GHz WLAN.

Hrvatski

Deklaracija o podobnosti (DoC)

Ovime, "Panasonic Corporation" izjavljuje da je ovaj proizvod udovoljava osnovnim zahtjevima i ostalim relevantnim uvjetima Smjernice 1999/5/EC.

Kupci mogu preuzeti kopiju originalne DoC za naše R&TTE proizvode s našeg DoC poslužitelja:
<http://www.doc.panasonic.de>

Adresa ovlaštenog predstavništva: Panasonic Marketing Europe GmbH,
Panasonic Testing Centre, Winsbergring 15, 22525 Hamburg, Njemačka

Ovaj proizvod je predviđen za upotrebu u sledećim zemljama.

GB, DE, AT, BE, DK, SE, FR, IT, ES, NL, FI, GR, PT, PL, HU, CZ, SK, EE, LV, LT, SI, BG, RO, MT, CY, IE, LU, HR, NO, CH, IS, LI, TR

Ovaj proizvod je namijenjen za opću potrošnju. (kategorija 3)

Funkcija bežične mreže ovog proizvoda treba biti korištena jedino u zatvorenim prostorima.

Ovaj proizvod se spaja na pristupne tačke bežične mreže od 2,4 GHz ili 5 GHz.

Lietuviškai

Atitikties deklaracija (AD)

Bendrovė "Panasonic Corporation" patvirtina, kad šis gaminytis tenkina direktyvos 1999/5/EB esminius reikalavimus ir kitas taikytinas nuostatas.

Mūsų R&TTE gaminių originalios atitikties deklaracijos kopiją klientai gali atsisiųsti iš mūsų AD serverio:
<http://www.doc.panasonic.de>

Įgaliojoto atstovo adresas: "Panasonic Marketing Europe GmbH",
Panasonic Testing Centre, Winsbergring 15, 22525 Hamburg, Vokietija.

Šis gaminytis skirtas naudoti toliau išvardytose valstybėse.

GB, DE, AT, BE, DK, SE, FR, IT, ES, NL, FI, GR, PT, PL, HU, CZ, SK, EE, LV, LT, SI, BG, RO, MT, CY, IE, LU, HR, NO, CH, IS, LI, TR

Šis gaminytis skirtas bendrajam vartojimui. (3 kategorija.)

Šio gaminio WLAN savybės naudojamos išskirtinai pastatų viduje.

Šis gaminytis yra skirtas prisijungti prie 2,4 GHz arba 5 GHz WLAN.

Slovensko

Izjava o skladnosti (DoC)

S priložjo izjavo podjetje "Panasonic Corporation" izjavlja, da so svoji izdelki skladni s poglavitnimi zahtevami in drugimi odgovarjajočimi predpisi direktive 1999/5/ES.

Stranka lahko naloži izvod izvirnega DoC o naših izdelkih R&TTE s strežnika DoC:
<http://www.doc.panasonic.de>

Pooblaščen zastopnik: Panasonic Marketing Europe GmbH,
Panasonic Testing Centre, Winsbergring 15, 22525 Hamburg, Nemčija

Ta izdelek je namenjen uporabi v naslednjih državah:

GB, DE, AT, BE, DK, SE, FR, IT, ES, NL, FI, GR, PT, PL, HU, CZ, SK, EE, LV, LT, SI, BG, RO, MT, CY, IE, LU, HR, NO, CH, IS, LI, TR

Izdelek je namenjen splošni uporabi. (Razred 3)

Povezava WLAN tega izdelka je namenjena izključno uporabi v objektih.

Izdelek je namenjen prikjučitvi pri dostopni točki 2,4 GHz ali 5 GHz WLAN.

Slovensky

Vyhlasenie o zhode (DoC)

"Panasonic Corporation" týmto prehlasuje, že tento výrobok je v zhode so základnými požiadavkami a ďalšími príslušnými ustanoveniami smernice 1999/5/ES.

Zákazníci si môžu stiahnuť kópiu pôvodného DoC na naše R&TTE výrobky z nášho servera DoC:

<http://www.doc.panasonic.de>

Kontakt na splnomocneného zástupcu: Panasonic Marketing Europe GmbH, Panasonic Testing Centre, Winsbergring 15, 22525 Hamburg, Nemecko

Tento produkt je určený pre použitie v týchto krajinách:

GB, DE, AT, BE, DK, SE, FR, IT, ES, NL, FI, GR, PT, PL, HU, CZ, SK, EE, LV, LT, SI, BG, RO, MT, CY, IE, LU, HR, NO, CH, IS, LI, TR

Tento produkt je určený pre všeobecného spotrebiteľa. (Kategória 3) WLAN funkcia tohto výrobku musí byť používaná výhradne vo vnútri budov.

Tento výrobok používa na pripojenie k prístupovému bodu 2,4 GHz alebo 5 GHz WLAN.

Norsk

Samsvarserklæring (DoC)

"Panasonic Corporation" erklærer at utstyret er i samsvar med de grunnleggende krav og øvrige relevante krav i direktiv 1999/5/EF. Kundene kan laste ned en kopi av den originale samsvarserklæringen (DoC) for vårt R&TTE utstyr fra vår DoC server:

<http://www.doc.panasonic.de>

Kontakt vår autoriserte representant: Panasonic Marketing Europe GmbH,

Panasonic Testing Centre, Winsbergring 15, 22525 Hamburg, Tyskland

Utstyret er ment til bruk i følgende land.

GB, DE, AT, BE, DK, SE, FR, IT, ES, NL, FI, GR, PT, PL, HU, CZ, SK, EE, LV, LT, SI, BG, RO, MT, CY, IE, LU, HR, NO, CH, IS, LI, TR

Utstyret er beregnet på den vanlige forbruker (klasse 3).

Utstyrets WLAN-funksjon er utelukkende til innendørsbruk.

Utstyret kan kobles til et tilgangspunkt på 2,4 GHz eller 5 GHz WLAN.

Eesti keel

Vastavusdeklaratsioon (DoC)

"Panasonic Corporation" kinnitab käesolevaga, et see toode on vastavuses põhiliste nõuete ja muude direktiivi 1999/5/EÜ asjakohaste sätetega.

Kliendid saavad kopia meie R&TTE toodetele kehtiva originaalvastavusdeklaratsiooni kopia alla laadida meie DoC-serverist: <http://www.doc.panasonic.de>

Võtke ühendust volitatud esindajaga: Panasonic Marketing Europe GmbH,

Panasonic Testing Centre, Winsbergring 15, 22525 Hamburg, Saksamaa

See toode on mõeldud kasutamiseks järgnevatel riikides.

GB, DE, AT, BE, DK, SE, FR, IT, ES, NL, FI, GR, PT, PL, HU, CZ, SK, EE, LV, LT, SI, BG, RO, MT, CY, IE, LU, HR, NO, CH, IS, LI, TR

See toode on mõeldud tavakasutajale. (III kategooria)

Selle toote WLAN-funktsiooni tohib kasutada vaid hoonete sees.

See toode on mõeldud 2,4 GHz või 5 GHz WLAN-

pääsupunktiiga ühenduse loomiseks.

Latviski

Atbilstības deklarācija (DoC)

Kompānija "Panasonic Corporation" ar šo paziņo, ka šis izstrādājums atbilst būtiskām prasībām un citām saistošām Direktīvas 1999/5/EK prasībām.

Pircēji var lejupielādēt oriģinālo DoC kopiju mūsu R&TTE izstrādājumos no mūsu DoC servera:

<http://www.doc.panasonic.de>

Lūdzam sazināties ar pilnvaroto parstāvi Panasonic

Marketing Europe GmbH,

Panasonic Testing Centre, Winsbergring 15, 22525 Hamburg, Vācija

Šo izstrādājumu paredzēts lietots šādās valstīs.

GB, DE, AT, BE, DK, SE, FR, IT, ES, NL, FI, GR, PT, PL, HU, CZ, SK, EE, LV, LT, SI, BG, RO, MT, CY, IE, LU, HR, NO, CH, IS, LI, TR

Šis izstrādājums ir paredzēts parastam patērētājam. (3. kategorija)

Šī izstrādājuma WLAN funkcija jālieto tikai iekšējās.

Šo izstrādājumu ir paredzēts savienot ar 2,4 GHz vai 5 GHz

WLAN piekļuves punktu.

Български

Декларация за съответствие (DoC)

"Panasonic Corporation" декларира, че този продукт съответства на съществените изисквания и другите приложими разпоредби на Директива 1999/5/ЕС.

Потребителите могат да свалят копия от оригиналните DoC към нашите продукти от типа R&TTE от сървъра, на който се съхранява DoC:

<http://www.doc.panasonic.de>

За контакт с оторизиран представител: Panasonic Marketing Europe GmbH,

Panasonic Testing Centre, Winsbergring 15, 22525 Hamburg, Германия

Този продукт е предназначен за използване в следните държави: GB, DE, AT, BE, DK, SE, FR, IT, ES, NL, FI, GR, PT, PL, HU, CZ, SK, EE, LV, LT, SI, BG, RO, MT, CY, IE, LU, HR, NO, CH, IS, LI, TR

Този продукт е предназначен за обща употреба. (Категория 3) Функцията WLAN на продукта може да се използва единствено в закрити помещения.

Този продукт е предназначен за свързване към точки за достъп от 2,4 GHz или 5 GHz WLAN.

Român

Declarație de Conformitate (DoC)

Prin prezenta, societatea "Panasonic Corporation" declară că produsul este conform cu cerințele esențiale și cu alte norme corespunzătoare Directivei 1999/5/EC.

Clienții pot descărca o copie a DoC-ului original al produselor noastre R&TTE de la adresa noastră DoC din Internet:

<http://www.doc.panasonic.de>

Contact la Reprezentanța autorizată: Panasonic Marketing Europe GmbH, Panasonic Testing Centre, Winsbergring 15, 22525 Hamburg, Germania

Acest produs a fost proiectat pentru a fi utilizat în următoarele țări: GB, DE, AT, BE, DK, SE, FR, IT, ES, NL, FI, GR, PT, PL, HU, CZ, SK, EE, LV, LT, SI, BG, RO, MT, CY, IE, LU, HR, NO, CH, IS, LI, TR

Acest produs a fost proiectat pentru clientela generală. (Categorie 3) Funcția WLAN a acestui produs trebuie să fie folosită numai în interiorul clădirilor.

Acest produs a fost proiectat pentru a fi conectat la access point WLAN 2,4 GHz sau 5 GHz.

Magyar

Megfelelőségi Nyilatkozat (DoC)

Ezennel a "Panasonic Corporation" kijelenti, hogy a jelen termék kielégíti az 1999/5/EK Irányelv létfontosságú követelményeit és más vonatkozó rendelkezéseit.

A vásárlók letölthetik az R&TTE termékek eredeti DoC

másolatát a DoC szerverünkről:

<http://www.doc.panasonic.de>

Forduljon a hivatalos márkaképviselethez: Panasonic Marketing Europe GmbH,

Panasonic Testing Centre, Winsbergring 15, 22525 Hamburg, Németország

A terméket az alábbi országokban való használatra szánták.

GB, DE, AT, BE, DK, SE, FR, IT, ES, NL, FI, GR, PT, PL, HU, CZ, SK, EE, LV, LT, SI, BG, RO, MT, CY, IE, LU, HR, NO, CH, IS, LI, TR

A terméket általánosan fogyasztóknak szánták. (3-as kategória)

A termék WLAN jellemzője kizárólag épületen belül használható.

A termék rendelkezése a 2,4 GHz-es vagy 5 GHz-es WLAN

hozzáférési ponthoz kapcsolódás.

Türkçe

Uygunluk Beyanı (DoC)

"Panasonic Corporation" işbu belge ile bu ürünün 1999/5/EC

sayılı Direktifin temel gereklilik ve diğer ilgili hükümlerine uygun olduğunu beyan etmektedir.

Müşterilerimiz R&TTE ürünlerimizden ilgili orijinal DoC belgesinin bir kopyasını DoC sunucumuzdan indirebilir:

<http://www.doc.panasonic.de>

Yetkili Temsilci ile temasa geçin:

Panasonic Marketing Europe GmbH, Panasonic Testing Centre,

Winsbergring 15, 22525 Hamburg, Almanya

İşbu ürün aşağıda belirtilen ülkelere kullanılmak üzere imal edilmiştir.

GB, DE, AT, BE, DK, SE, FR, IT, ES, NL, FI, GR, PT, PL, HU, CZ, SK, EE, LV, LT, SI, BG, RO, MT, CY, IE, LU, HR, NO, CH, IS, LI, TR

İşbu ürün genel tüketiciilere yöneliktir. (Kategori 3)

İşbu ürünün WLAN özelliği sadece ve sadece binaların

içerisinde kullanılmamalıdır.

Bu ürün telep üzerine 2,4 GHz veya 5 GHz WLAN erişim

noktasına bağlanabilir.

Disposal of Old Equipment and Batteries

Only for European Union and countries with recycling systems



These symbols on the products, packaging, and/or accompanying documents mean that used electrical and electronic products and batteries must not be mixed with general household waste.

For proper treatment, recovery and recycling of old products and used batteries, please take them to applicable collection points in accordance with your national legislation.

By disposing of them correctly, you will help to save valuable resources and prevent any potential negative effects on human health and the environment.

For more information about collection and recycling, please contact your local municipality.

Penalties may be applicable for incorrect disposal of this waste, in accordance with national legislation.



Note for the battery symbol (bottom symbol):

This symbol might be used in combination with a chemical symbol. In this case it complies with the requirement set by the Directive for the chemical involved.

This product incorporates the following software:

- (1) the software developed independently by or for Panasonic Corporation,
- (2) the software owned by third party and licensed to Panasonic Corporation,
- (3) the software licensed under the GNU General Public License, Version 2.0 (GPL V2.0),
- (4) the software licensed under the GNU LESSER General Public License, Version 2.1 (LGPL V2.1), and/or
- (5) open source software other than the software licensed under the GPL V2.0 and/or LGPL V2.1.

The software categorized as (3) - (5) are distributed in the hope that it will be useful, but WITHOUT ANY WARRANTY, without even the implied warranty of MERCHANTABILITY or FITNESS FOR A PARTICULAR PURPOSE.

Please refer to the detailed terms and conditions thereof shown in our website below.

http://panasonic.jp/support/global/cs/audio/oss/all8_3_1c.html

At least three (3) years from delivery of this product, Panasonic will give to any third party who contacts us at the contact information provided below, for a charge no more than our cost of physically performing source code distribution, a complete machine-readable copy of the corresponding source code covered under GPL V2.0, LGPL V2.1 or the other licenses with the obligation to do so, as well as the respective copyright notice thereof.

Contact Information: oss-cd-request@gg.jp.panasonic.com

The source code and the copyright notice are also available for free in our website below.

<http://panasonic.net/avc/oss/>

Safety information for customers in Norway

NORSK

ADVARSEL

Produkt

- For å redusere faren for brann, elektrisk støt eller skade på apparatet:
 - Utsett ikke produktet for regn, fukt, drypping eller sprut.
 - Ikke plasser objekter som er fylt med væske, som vaser, på apparatet.
 - Bruk kun anbefalt tilbehør.
 - Fjern ikke deksler.
 - Reparer ikke denne enheten selv, overlatt service til kvalifisert servicepersonell.

Vekselstrømnett

- Nettstøpselet er trukket ut fra denne enheten. Installer denne enheten slik at nettstøpselet umiddelbart kan trekkes fra stikkkontakten.

FORSIKTIG

Produkt

- Plasser ikke åpen ild, slik som levende lys, oppå apparatet.
- Dette apparatet er beregnet for bruk under moderate klimaforhold.

Plassering

- For å redusere faren for brann, elektrisk støt eller skade på apparatet:
 - Ikke plasser apparatet i en bokhylle, et innebygget kabinett eller et annet lukket sted. Pass på at produktet er godt ventilert.
 - Apparatets ventilasjonsåpninger må ikke dekkes til med aviser, duker, gardiner eller lignende.

Limited Warranty (ONLY FOR AUSTRALIA)

Panasonic Warranty

1. The product is warranted for 12 months from the date of purchase. Subject to the conditions of this warranty Panasonic or its Authorised Service Centre will perform necessary service on the product without charge for parts or labour, if in the opinion of Panasonic, the product is found to be faulty within the warranty period.
2. This warranty only applies to Panasonic products purchased in Australia and sold by Panasonic Australia or its Authorised Distributors or Dealers and only where the products are used and serviced within Australia or its territories. Warranty cover only applies to service carried out by a Panasonic Authorised Service Centre and only if valid proof of purchase is presented when warranty service is requested.
3. This warranty only applies if the product has been installed and used in accordance with the manufacturer's recommendations (as noted in the operating instructions) under normal use and reasonable care (in the opinion of Panasonic). The warranty covers normal domestic use only and does not cover damage, malfunction or failure resulting from use of incorrect voltages, incorrect installation, accident, misuse, neglect, build-up of dirt or dust, abuse, maladjustment of customer controls, mains supply problems, thunderstorm activity, infestation by insects or vermin, tampering or repair by unauthorised persons (including unauthorised alterations), introduction of sand, humidity or liquids, commercial use such as hotel, office, restaurant, or other business or rental use of the product, exposure to abnormally corrosive conditions or any foreign object or matter having entered the product.
4. This warranty does not cover the following items unless the fault or defect existed at the time of purchase:
 - (a) Cabinet Part(s)
 - (b) Video or Audio Tapes
 - (c) SD cards or USB devices
 - (d) User replaceable Batteries
 - (e) etc
 - (e) DVD, Blu-ray or Recordable Discs
 - (f) Video / Audio Heads from wear and tear in normal use
 - (g) Information stored on Hard Disk Drive, USB stick or SD card
 - (h) DTV reception issues caused by TV Aerial / Cabling / Wall socket(s)
5. Some products may be supplied with Ethernet connection hardware. The warranty is limited on such products and will not cover
 - (a) Internet and or DLNA connection / setup related problems
 - (b) Access fees and or charges incurred for internet connection
 - (c) The use of incompatible software or software not specifically stipulated in the product operations manual; and
 - (d) Any indirect or consequential costs associated with the incorrect use or misuse of the hardware, its connection to the internet or any other device.
6. To claim warranty service, when required, you should:
 - Telephone Panasonic's Customer Care Centre on 132600 or visit our website referred to below and use the Service Centre Locator for the name/address of the nearest Authorised Service Centre.
 - Send or take the product to a Panasonic Authorised Service Centre together with your proof of purchase receipt as a proof of purchase date. Please note that freight and insurance to and / or from your nearest Authorised Service Centre must be arranged by you.
 - Note that home or pick-up/delivery service is available for the following products in the major metropolitan areas of Australia or the normal operating areas of the nearest Authorised Service Centres:
 - Plasma/LCD televisions / displays (screen size greater than 103 cm)
7. The warranties hereby conferred do not extend to, and exclude, any costs associated with the installation, de-installation or re-installation of a product, including costs related to the mounting, de-mounting or remounting of any screen, (and any other ancillary activities), delivery, handling, freight, transportation or insurance of the product or any part thereof or replacement of and do not extend to, and exclude, any damage or loss occurring by reason of, during, associated with, or related to such installation, de-installation, re-installation or transit.

Panasonic Authorised Service Centres are located in major metropolitan areas and most regional centres of Australia, however, coverage will vary dependant on product. For advice on exact Authorised Service Centre locations for your product, please telephone our Customer Care Centre on 132600 or visit our website and use the Service Centre Locator.

In addition to your rights under this warranty, Panasonic products come with consumer guarantees that cannot be excluded under the Australian Consumer Law. If there is a major failure with the product, you can reject the product and elect to have a refund or to have the product replaced or if you wish you may elect to keep the goods and be compensated for the drop in value of the goods. You are also entitled to have the product repaired or replaced if the product fails to be of acceptable quality and the failure does not amount to a major failure.

If there is a major failure in regard to the product which cannot be remedied then you must notify us within a reasonable period by contacting the Panasonic Customer Care Centre. If the failure in the product is not a major failure then Panasonic may choose to repair or replace the product and will do so in a reasonable period of time from receiving notice from you.

**THIS WARRANTY CARD AND THE PURCHASE DOCKET (OR SIMILAR PROOF OF PURCHASE)
SHOULD BE RETAINED BY THE CUSTOMER AT ALL TIMES**

If you require assistance regarding warranty conditions or any other enquiries, please visit the **Panasonic Australia** website **www.panasonic.com.au** or contact by phone on **132 600**
If phoning in, please ensure you have your operating instructions available.

Panasonic Australia Pty. Limited

ACN 001 592 187 ABN 83 001 592 187

1 Innovation Road, Macquarie Park NSW 2113

PRO-031-F11 Issue: 4.0

01-01-2011

SQT0935

47

Sales and Support Information

Customer Communications Centre

- For customers within the UK: 0344 844 3899
- For customers within Ireland: 01 289 8333
- Monday–Friday 9:00 am – 5:00 pm (Excluding public holidays).
- For further support on your product, please visit our website:
www.panasonic.co.uk

Direct Sales at Panasonic UK

- Order accessory and consumable items for your product with ease and confidence by phoning our Customer Communications Centre Monday–Friday 9:00 am – 5:00 pm (Excluding public holidays).
- Or go on line through our Internet Accessory ordering application at www.pas-europe.com.
- Most major credit and debit cards accepted.
- All enquiries transactions and distribution facilities are provided directly by Panasonic UK.
- It couldn't be simpler!
- Also available through our Internet is direct shopping for a wide range of finished products. Take a browse on our website for further details.



Manufactured by: Panasonic Corporation
Kadoma, Osaka, Japan
Importer for Europe: Panasonic Marketing Europe GmbH
Panasonic Testing Centre
Winsbergring 15, 22525 Hamburg, Germany



Panasonic Corporation
Web Site: <http://www.panasonic.com>

