

Panasonic®

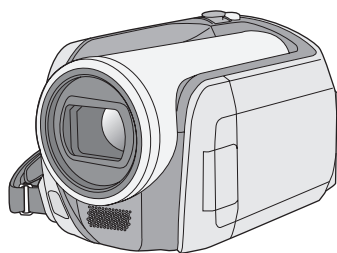

Operating Instructions SD Card/Hard Disk Video Camera

Model No. **SDR-H250EB**
SDR-H20EB

- The illustration shows SDR-H250.
- SDR-H20 does not have a video light.

Before use, please read these instructions completely.

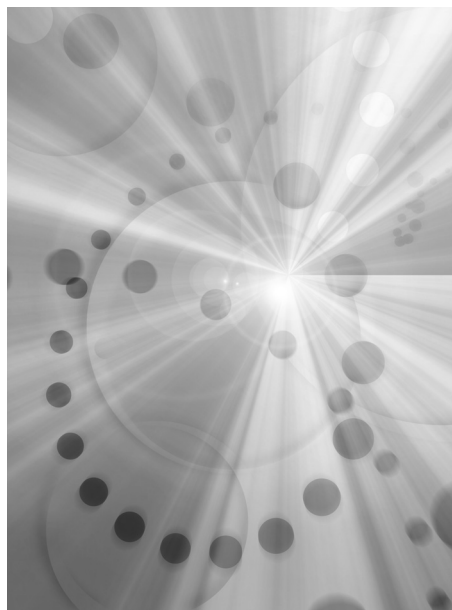

LEICA
DICOMAR

Web Site: <http://www.panasonic-europe.com>

LSQT1211 A

Dear Customer,



We would like to take this opportunity to thank you for purchasing this Panasonic Movie Camera. Please read these Operating Instructions carefully and keep them handy for future reference. Please note that the actual controls and components, menu items, etc. of your Movie Camera may look somewhat different from those shown in the illustrations in these Operating Instructions.

Caution for AC mains lead

For your safety, please read the following text carefully.

This appliance is supplied with a moulded three pin mains plug for your safety and convenience. A 5-ampere fuse is fitted in this plug.

Should the fuse need to be replaced please ensure that the replacement fuse has a rating of 5-ampere and that it is approved by ASTA or BSI to BS1362.

Check for the ASTA mark  or the BSI mark  on the body of the fuse.

If the plug contains a removable fuse cover you must ensure that it is refitted when the fuse is replaced.

If you lose the fuse cover the plug must not be used until a replacement cover is obtained.

A replacement fuse cover can be purchased from your local dealer.

The wire which is coloured Blue must be connected to the terminal which is marked with the letter N or coloured Black or Blue.

The wire which is coloured Brown must be connected to the terminal which is marked with the letter L or coloured Brown or Red.

WARNING: DO NOT CONNECT EITHER WIRE TO THE EARTH TERMINAL WHICH IS MARKED WITH THE LETTER E, BY THE EARTH SYMBOL  OR COLOURED GREEN OR GREEN/YELLOW.

THIS PLUG IS NOT WATERPROOF—KEEP DRY.

Before use

Remove the connector cover.

How to replace the Fuse

The location of the fuse differ according to the type of AC mains plug (figures A and B). Confirm the AC mains plug fitted and follow the instructions below.

Illustrations may differ from actual AC mains plug.

- 1) Open the fuse cover with a screwdriver.

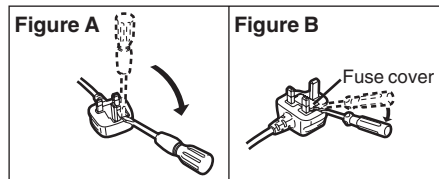

- 2) Replace the fuse and close or attach the fuse cover.

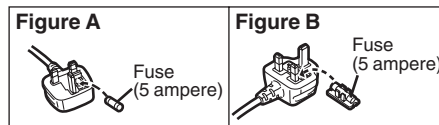

CAUTION!

IF THE FITTED MOULDED PLUG IS UNSUITABLE FOR THE SOCKET OUTLET IN YOUR HOME THEN THE FUSE SHOULD BE REMOVED AND THE PLUG CUT OFF AND DISPOSED OF SAFELY. THERE IS A DANGER OF SEVERE ELECTRICAL SHOCK IF THE CUT OFF PLUG IS INSERTED INTO ANY 13-AMPERE SOCKET.

If a new plug is to be fitted please observe the wiring code as stated below.

If in any doubt please consult a qualified electrician.

IMPORTANT

The wires in this mains lead are coloured in accordance with the following code:

Blue: Neutral, Brown: Live.

As these colours may not correspond with the coloured markings identifying the terminals in your plug, proceed as follows:

Information for Your Safety

WARNING:

TO REDUCE THE RISK OF FIRE, ELECTRIC SHOCK OR PRODUCT DAMAGE,

- **DO NOT EXPOSE THIS APPARATUS TO RAIN, MOISTURE, DRIPPING OR SPLASHING AND THAT NO OBJECTS FILLED WITH LIQUIDS, SUCH AS VASES, SHALL BE PLACED ON THE APPARATUS.**
- **USE ONLY THE RECOMMENDED ACCESSORIES.**
- **DO NOT REMOVE THE COVER (OR BACK); THERE ARE NO USER SERVICEABLE PARTS INSIDE. REFER SERVICING TO QUALIFIED SERVICE PERSONNEL.**

CAUTION!

- **DO NOT INSTALL OR PLACE THIS UNIT IN A BOOKCASE, BUILT-IN CABINET OR IN ANOTHER CONFINED SPACE. ENSURE THE UNIT IS WELL VENTILATED. TO PREVENT RISK OF ELECTRIC SHOCK OR FIRE HAZARD DUE TO OVERHEATING, ENSURE THAT CURTAINS AND ANY OTHER MATERIALS DO NOT OBSTRUCT THE VENTILATION VENTS.**
- **DO NOT OBSTRUCT THE UNIT'S VENTILATION OPENINGS WITH NEWSPAPERS, TABLECLOTHS, CURTAINS, AND SIMILAR ITEMS.**
- **DO NOT PLACE SOURCES OF NAKED FLAMES, SUCH AS LIGHTED CANDLES, ON THE UNIT.**
- **DISPOSE OF BATTERIES IN AN ENVIRONMENTALLY FRIENDLY MANNER.**

The socket outlet shall be installed near the equipment and easily accessible.
The mains plug of the power supply cord shall remain readily operable.
To completely disconnect this apparatus from the AC Mains, disconnect the power supply cord plug from AC receptacle.

Product Identification Marking is located on the bottom of units.

Use only the recommended accessories.

- Do not use any other AV/S cables and USB cables except the supplied one.
- When you use the cable which are sold separately, please make sure to use the one whose length is less than 3 meters.

Information on Disposal for Users of Waste Electrical & Electronic Equipment (private households)



This symbol on the products and/or accompanying documents means that used electrical and electronic products should not be mixed with general household waste.

For proper treatment, recovery and recycling, please take these products to designated collection points, where they will be accepted on a free of charge basis. Alternatively, in some countries you may be able to return your products to your local retailer upon the purchase of an equivalent new product.

Disposing of this product correctly will help to save valuable resources and prevent any potential negative effects on human health and the environment which could otherwise arise from inappropriate waste handling.

Please contact your local authority for further details of your nearest designated collection point.

Penalties may be applicable for incorrect disposal of this waste, in accordance with national legislation.

For business users in the European Union

If you wish to discard electrical and electronic equipment, please contact your dealer or supplier for further information.

Information on Disposal in other Countries outside the European Union

This symbol is only valid in the European Union.

If you wish to discard this product, please contact your local authorities or dealer and ask for the correct method of disposal.

■ Indemnity concerning recording content

The manufacturer shall in no event be liable for the loss of recordings due to malfunction or defect of this unit, its accessories or recordable media.

■ Carefully observe copyright laws

Recording of pre-recorded tapes or discs or other published or broadcast material for purposes other than your own private use may infringe copyright laws. Even for the purpose of private use, recording of certain material may be restricted.

- SDHC Logo is a trademark.
- miniSD Logo is a trademark.
- The Movie Camera uses copyright-protected technologies and is protected by the patented technologies and intellectual properties of Japan and the U.S. To use these copyright-protected technologies, authorization of the Macrovision Company is required. It is prohibited to disassemble or modify the Movie Camera.
- Manufactured under license from Dolby Laboratories.
Dolby and the double-D symbol are trademarks of Dolby Laboratories.
- LEICA is a registered trademark of Leica Microsystems IR GmbH and DICOMAR is a registered trademark of Leica Camera AG.
- Microsoft®, Windows® and DirectX® are either registered trademarks or trademarks of the Microsoft Corporation in the United States and/or other countries.
- IBM and PC/AT are registered trademarks of International Business Machines Corporation of the U.S.
- Celeron®, Intel® and Pentium® are the registered trademarks or trademarks of the Intel Corporation in the United States and other countries
- AMD Athlon and AMD Duron are trademarks of Advanced Micro Devices, Inc.
- Sound Blaster is a trademark of Creative Technology Ltd.
- Microsoft product screen shot(s) reprinted with permission from Microsoft Corporation.

- Other names of systems and products mentioned in these instructions are usually the registered trademarks or trademarks of the manufacturers who developed the system or product concerned.

These operating instructions are designed for use with models SDR-H250 and SDR-H20. Pictures may be slightly different from the original.

- The illustrations used in these operating instructions show model SDR-H250, however, parts of the explanation refer to different models.
- Depending on the model, some functions are not available.
- Features may vary, so please read carefully.

Contents

Caution for AC mains lead	2
Information for Your Safety	3

Before using

Features	8
Accessories	10
Parts identification and handling	11
Using the LCD monitor	14
Using the remote control (SDR-H250)	14
HDD and SD card	16
Concerning the internal HDD and cards that can be used on this unit	16
Concerning SD cards	16
HDD handling precautions	18
Access lamp	18

Setup

Power supply	20
Charging the battery	20
Connecting to the AC outlet	23
Turning the unit on/off	23
Inserting/removing an SD card	24
Selecting a mode	25
How to use the joystick	25
Switching the language	29
Using the menu screen	29
Setting date and time	31
Adjusting the LCD monitor	32

Recording

Before recording	34
Recording motion pictures	36
Recording modes and recordable time available for the motion picture	38
Recording still pictures	39
Number of pixels and picture quality for still picture recording	42
Various recording functions	43
Zoom in/out function	43
Recording yourself	44
Recording with the video light (SDR-H250)	44
Backlight compensation function	45

Fade in/fade out function	45
Soft skin mode	46
Tele macro function (SDR-H250)	47
Colour night view function	47
Self-timer recording	48
Recording guideline function	48
Wide mode	49
Image stabilizer function	49
Wind noise reduction function	49
Manual recording functions	50
Scene mode	50
Manual focus adjustment	51
White balance	51
Manual shutter speed/aperture adjustment	53

Playback

Motion picture playback	55
Still picture playback	59

Editing

Editing scenes	61
Deleting scenes	61
Locking motion picture scenes	62
Using playlists	62
What is a playlist?	62
Creating a new playlist	63
Playing back a playlist	64
Editing a playlist	64
Editing still pictures	66
Deleting still picture files	66
Locking still picture files	67
DPOF setting	68
Copying still picture files	69

HDD and card management

HDD management	70
Formatting HDD	70
Displaying HDD information	70
Card management	70
Formatting an SD card	70

With other products

With a TV	72
Playback on TV	72
With a DVD recorder	73

Dubbing recordings onto a DVD recorder	73
With a VCR.....	73
Dubbing images onto other video devices	73
With a printer (PictBridge).....	74

With a computer

Before using with a computer.....	77
What you can do with a computer	77
Operating environment.....	78
Installation	81
Installing ImageMixer3 for Panasonic	81
Reading the software help.....	82
Software uninstallation	82
Connection and recognition	82
Connection and recognition procedures... ..	82
About the computer display.....	83
To disconnect USB cable safely	84
Using the recorded images on a computer.....	84
DVD COPY function.....	84
Playing back and importing images.....	85
Creating DVD-Video discs with the selected images	87

Others

Menus.....	89
Menu list.....	89
Other menus.....	90
Indications	92
Indications	92
Messages.....	94
Functions that cannot be used simultaneously	96
Frequently asked questions.....	97
Troubleshooting	99
Cautions for use.....	104
Explanation of terms.....	106
Specifications	109
Number of recordable pictures on the HDD or an SD card	112
Index.....	114

Before using

Features

■ Extended recording!

You can record the equivalent of approximately twenty-two 8 cm DVD discs on the 30 GB internal HDD. You can also record motion pictures and still pictures on an SD card.

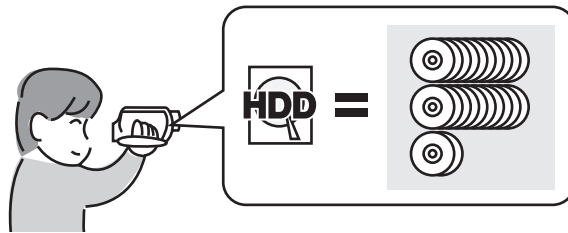

■ Easy recording! (→ 36)

No need to search for the recording start position. The new recording will not overwrite any previously recorded scene.

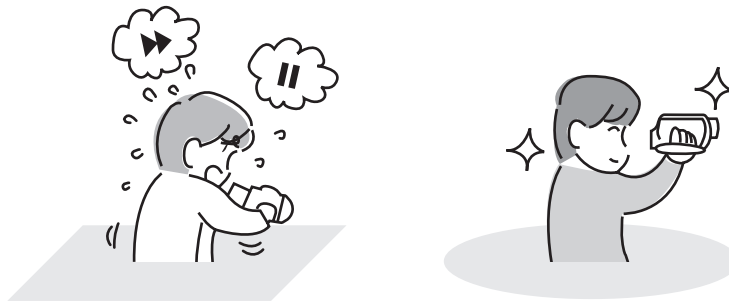

■ Easy playback! (→ 55)

Recorded scenes are displayed as thumbnails. You can easily search for the scenes you want to watch.

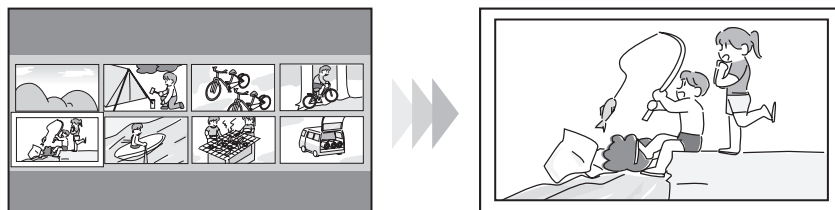

Before using

■ Editing scenes! (→ 61, 62)

You can create an original video (playlist) by collecting together your favourite scenes recorded on the HDD.

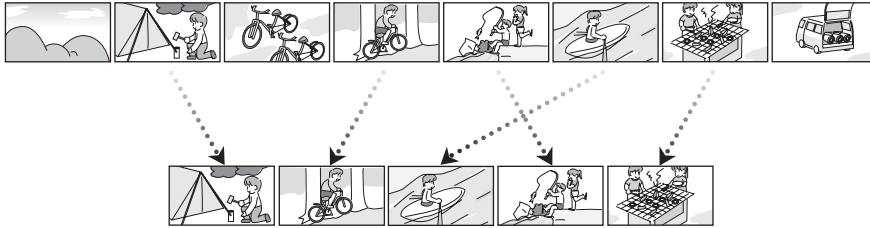

■ Using with a computer! (→ 77)

If you use the supplied software, you can create a backup DVD of the scenes recorded on this unit with just one button.

You can also make an original DVD-Video by exporting the scenes to a computer and then editing them.



Before using

■ Sales and Support Information

Customer Care Centre

- For customers within the UK: 08705 357357
- For customers within the Republic of Ireland: 01 289 8333
- Visit our website for product information
- E-mail: customer.care@panasonic.co.uk

Technical Support for AV Software

- For UK, ROI: 08701 505610

Direct Sales at Panasonic UK

- Order accessory and consumable items for your product with ease and confidence by phoning our Customer Care Centre Monday–Thursday 9.00 a.m.–5.30 p.m., Friday 9.30 a.m.– 5.30 p.m. (Excluding public holidays)
- Or go on line through our Internet Accessory ordering application at www.panasonic.co.uk.
- Most major credit and debit cards accepted.
- All enquiries transactions and distribution facilities are provided directly by Panasonic UK Ltd.
- It couldn't be simpler!
- Also available through our Internet is direct shopping for a wide range of finished products, take a browse on our website for further details.

Interested in purchasing an extended guarantee?

Please call 0870 240 6284 or visit our website www.panasonic.co.uk/quarantee.

Accessories

Check the accessories before using this unit.

SD Memory Card (512 MB)
RP-SDR512



Battery pack (SDR-H250)
CGA-DU12



- The supplied battery pack is not available as spare part, see the list of optional batteries below for alternative battery.

Battery pack (SDR-H20)
CGR-DU06



- The supplied battery pack is not available as spare part, see the list of optional batteries below for alternative battery.

AC adaptor
VSK0651B (DE-974GC)



DC cable
K2GJ2DC00011 or
K2GJ2DC00015



AV/S cable
K2KZ9CB00001



AC cable
K2CT3CA00004
(RJA0053-3X)



Remote control (SDR-H250)
N2QAEC000023



Button-type battery (SDR-H250)
CR2025



Lens cap (SDR-H20)
LSYK2113



USB cable
K1HA05CD0010



CD-ROM



Before using

Optional accessories

Some optional accessories may not be available in some countries.

AC adaptor (VW-AD11EB)
Battery pack (lithium/CGR-DU06/640 mAh) (SDR-H20)
Battery pack (lithium/CGA-DU07/680 mAh) (SDR-H20)
Battery pack (lithium/CGA-DU12/1150 mAh)
Battery pack (lithium/CGA-DU14/1360 mAh)
Battery pack (lithium/CGA-DU21/2040 mAh)
Tripod (VW-CT45E)

Parts identification and handling

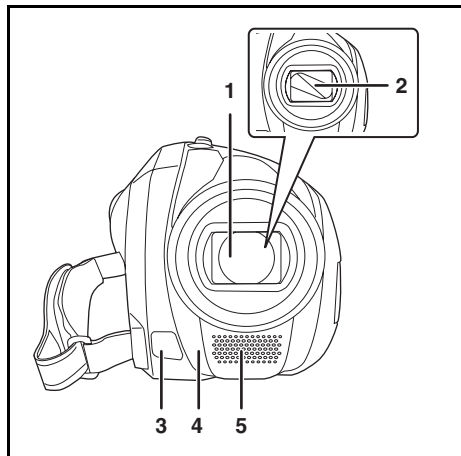

- 1 Lens (LEICA DICOMAR) (SDR-H250)
Lens (SDR-H20)
• Do not attach a conversion lens or a filter to this unit as it will cause vignetting.
- 2 Lens cover (SDR-H250)
- 3 Video light (SDR-H250) (→ 44)
- 4 White balance sensor (→ 52)
Remote control sensor (SDR-H250) (→ 15)
- 5 Microphone (built-in, stereo)

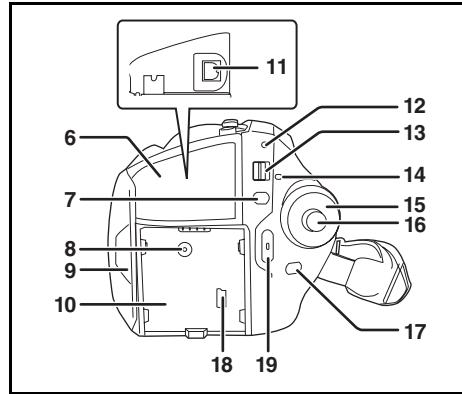

- 6 Terminal cover
- 7 Menu button [MENU] (→ 29)
- 8 DC input terminal [DC/C.C. IN] (→ 23)
- 9 LCD monitor open part (→ 14)
- 10 Battery holder (→ 20)
- 11 Audio-video output terminal [A/V] (→ 72, 73)
- 12 Status indicator (→ 23)
- 13 Power switch [OFF/ON] (→ 23)
- 14 HDD/computer access lamp [ACCESS/PC] (→ 18, 83)
- 15 Mode dial (→ 25)
- 16 Joystick (→ 25)
- 17 Delete button [⏏] (→ 61, 65, 66)
- 18 USB terminal [↔] (→ 74, 82)
- 19 Recording start/stop button (→ 36)

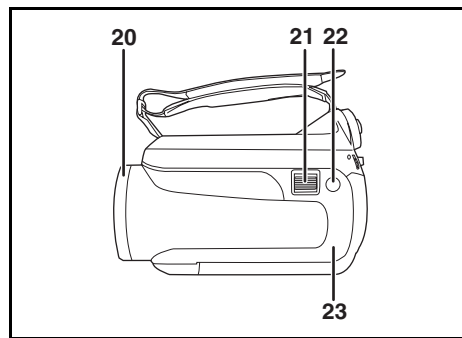

- 20 Lens cover open/close ring (SDR-H250) (→ 12)
- 21 When recording: Zoom lever [W/T] (→ 43)
When playing back: Volume lever [-VOL+] (→ 57)
- 22 Photoshot button [📷] (→ 39)
- 23 Illumination LED (→ 91)

Before using

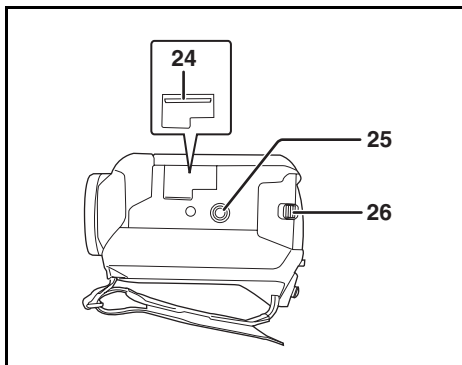

- 24 Card slot (→ 24)
- 25 Tripod receptacle (→ 13)
- 26 Battery release lever [BATTERY] (→ 20)

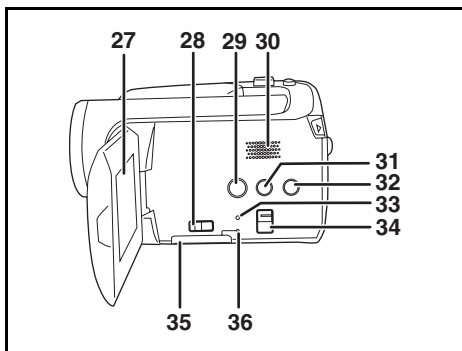

- 27 LCD monitor (→ 14)

Due to limitations in LCD production technology, there may be some tiny bright or dark spots on the LCD monitor screen. However, this is not a malfunction and does not affect the recorded picture.

- 28 Card slot open lever (→ 24)
- 29 DVD COPY button [DVD COPY] (→ 84)
- 30 Speaker
- 31 Power LCD plus button [POWER LCD PLUS] (→ 33)
- 32 Video light button [LIGHT] (SDR-H250) (→ 44)
- 33 Reset button [RESET] (→ 102)
- 34 Mode select switch [AUTO/MANUAL/ FOCUS] (→ 35, 50, 51)
- 35 Card slot cover [SD CARD] (→ 24)
- 36 Card access lamp [ACCESS] (→ 19, 83)

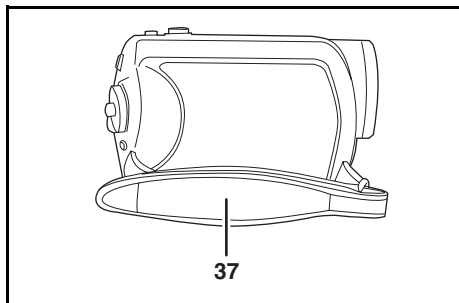

- 37 Grip belt (→ 12)

Using grip belt

Adjust the belt length so it fits your hand.

Adjust the belt length and the pad position.

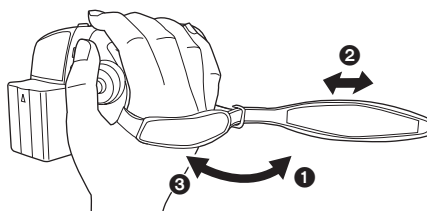

- ① Flip the belt.
- ② Adjust the length.
- ③ Replace the belt.

Using the lens cover (SDR-H250)

For the lens protection, be sure to close the lens cover when not in use.

Rotate the lens cover open/close ring.

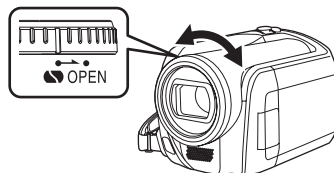

Before using

Attaching the lens cap (SDR-H20)

Attach the lens cap to protect the surface of the lens.

- 1 Pass the end of the lens cap cord through the belt.**

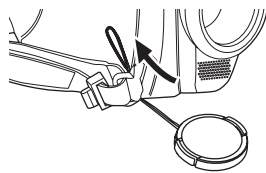

- 2 Pass the lens cap through the loop.**

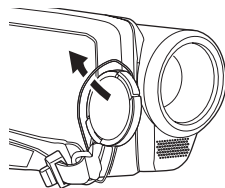

- 3 To attach or remove the lens cap, hold both sides of the lens cap with the tips of your finger and thumb.**

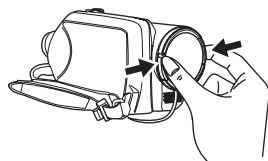

During recording

The removed lens cap can be attached to the lens cap fixture.

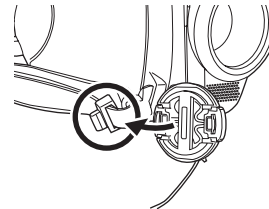

Tripod receptacle

This is a hole for attaching the unit to the optional tripod.

(Please carefully read the operating instructions for how to attach the unit to the tripod.)

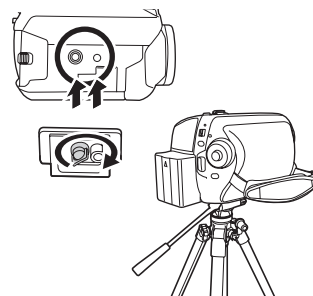

- When the tripod is used, the card slot cover cannot be opened. Insert an SD card before attaching this unit to the tripod. (→ 24)

Before using

Using the LCD monitor

You can record the image while viewing it on the LCD monitor.

- 1 Place your finger on the LCD monitor open part **A** and pull the LCD monitor out in the direction of the arrow.**

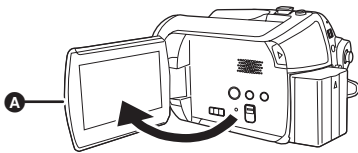

- It can open up to 90°.

- 2 Adjust the angle of the LCD monitor as desired.**

- It can rotate up to 180° **A** towards the lens or 90° **B** towards the opposite direction.

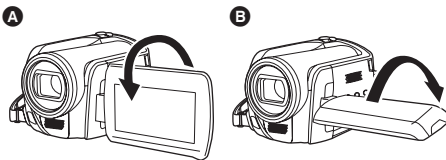

- The brightness and colour level of the LCD monitor can be adjusted from the menu. (→ 32)
- The unit may be damaged or fail if the LCD monitor is forcibly opened or rotated.

Using the remote control (SDR-H250)

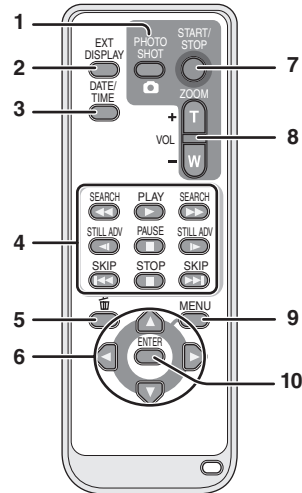

- 1** Photoshot button [PHOTO SHOT,]*
- 2** On-screen display button [EXT DISPLAY] (→ 73)
- 3** Date/time button [DATE/TIME] (→ 31)
- 4** Playback operation buttons (→ 56)
- 5** Delete button []*
- 6** Direction buttons [, , ,] (→ 30)
- 7** Recording start/stop button [START/STOP]*
- 8** Zoom/volume buttons [ZOOM, VOL]*
- 9** Menu button [MENU]* (→ 30)
- 10** Enter button [ENTER] (→ 30)

* means that these buttons function in the same manner as the corresponding buttons on the unit.

■ Install a button-type battery

Install the supplied button-type battery in the remote control before using it.

Before using

- 1 While pressing the stopper **A**, pull out the battery holder.

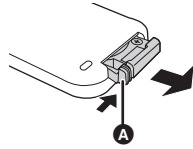

- 2 Set the button-type battery with its (+) mark facing upward and then put the battery holder back in place.

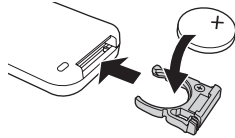

■ Concerning the button-type battery

- When the button-type battery runs down, replace it with a new battery (part number: CR2025). The battery should normally last about 1 year, however this depends on how frequently the unit is used.
- Keep the button-type battery out of the reach of children.

Warning

Keep the Button-Type battery out of the reach of children. Never put Button-Type battery in mouth. If swallowed call your doctor.

WARNING

“THE LITHIUM BATTERY IS A CRITICAL COMPONENT (TYPE NUMBER CR2025 MANUFACTURED BY PANASONIC). IT MUST NEVER BE SUBJECTED TO EXCESSIVE HEAT OR DISCHARGE. IT MUST THEREFORE ONLY BE FITTED IN EQUIPMENT DESIGNED SPECIFICALLY FOR ITS USE. REPLACEMENT BATTERIES MUST BE OF THE SAME TYPE AND MANUFACTURER. THEY MUST BE FITTED IN THE SAME MANNER AND LOCATION AS THE ORIGINAL BATTERY, WITH THE CORRECT POLARITY CONNECTIONS OBSERVED. DO NOT ATTEMPT TO RE-CHARGE THE OLD BATTERY OR RE-USE IT FOR ANY OTHER PURPOSE. IT SHOULD BE DISPOSED OF IN WASTE PRODUCTS DESTINED FOR BURIAL RATHER THAN INCINERATION.”

■ Remote control usable range

The distance between the remote control and the unit's remote control sensor **A**: Within approx. 5 m
 Angle: Approx. 10° up and 15° down, left, and right

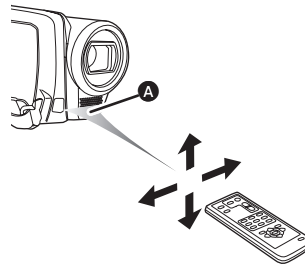



- The remote control is intended for indoor operation. Outdoors or under strong light, the unit may not operate properly even within the usable ranges.

Before using

HDD and SD card

This unit can be used for recording motion pictures and still pictures to the internal HDD and an SD card.

Concerning the internal HDD and cards that can be used on this unit

	Internal HDD (Hard Disk Drive)	SD Memory Card			SDHC Memory Card
Display on the screen					
Indication in these instructions	HDD	SD			
Capacity	30 GB*1	8 MB/ 16 MB	32 MB/ 64 MB/ 128 MB	256 MB/ 512 MB (supplied)/ 1 GB/2 GB	4 GB
Functions					
Recording motion pictures	●	–	●*2	●	
Recording still pictures	●		●		
Creating playlists	●		–		

●: available –: not available

*1 The 30 GB hard drive utilizes a portion of the storage space for formatting, file management and other purposes. 30 GB is 30,000,000,000 bytes. Usable capacity will be less.

*2 Cannot be guaranteed in operation.

Concerning SD cards

This unit is compatible with both SD Memory cards and SDHC Memory cards. You can only use SDHC Memory cards on devices that are compatible with them. You cannot use SDHC Memory cards on devices that are only compatible with SD Memory cards. (When using an SDHC Memory card on another device, be sure to read the operating instructions for that device.)

- For the purposes of these operating instructions, SD Memory Card and SDHC Memory Card are referred to as the "SD card".
- This unit supports SD Memory Cards formatted in FAT12 system and FAT16 system based on SD Memory Card Specifications and SDHC Memory Cards formatted in FAT32 system.

Before using

- Use this unit to format SD cards. If an SD card is formatted on other products (such as a computer), the time spent for recording may become longer and you may not be able to use the SD card. (→ 70)
- When using an SD card on which data has been written many times, the remaining time left for recording may be reduced.
- Keep the Memory Card out of reach of children to prevent swallowing.
- A MultiMediaCard cannot be used on this unit.
- When the write-protect switch **A** on SD card is locked, no recording, deletion or editing will be possible on the card.

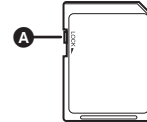

■ About SD cards that you can use for motion picture recording

We recommend using SD cards conforming to Class 2 or higher of the SD Speed Class Rating or the following SD cards made by Panasonic for motion picture recording. (If another kind of SD card is used, the recording may suddenly stop during motion picture recording.)

	Pro High Speed SD Memory Card	Super High Speed SD Memory Card	High Speed SD Memory Card	SDHC Memory Card
256 MB	–	RP-SDH256	RP-SDR256	–
512 MB	RP-SDK512	RP-SDH512*	RP-SDR512	–
1 GB	RP-SDK01G RP-SDV01G	RP-SDH01G*	RP-SDQ01G* RP-SDR01G	–
2 GB	RP-SDK02G RP-SDV02G	–	RP-SDQ02G* RP-SDR02G RP-SDM02G	–
4 GB	–	–	–	RP-SDR04G RP-SDM04G RP-SDV04G

* No longer made.

- Operation in motion picture recording is not guaranteed with the following SD cards.
 - SD cards from 32 MB to 128 MB
 - SD cards from 256 MB to 4 GB other than the ones mentioned above
- Please confirm the latest information on the following website. (This website is in English only.)
http://panasonic.jp/support/global/cs/e_cam

■ Handling precautions

- Do not touch the terminals on the back of the card.
- Do not expose the terminals of the card to water, garbage or dust.
- Do not place the card in the following areas:
 - In direct sunlight.
 - In very dusty or humid areas.
 - Near a heater.
 - Locations susceptible to significant difference in temperature (condensation can occur).
 - Where static electricity or electromagnetic waves occur.
- Put the card back in its bag or case for protection when not using it.
- Electrical noise, static electricity or failure of this unit or the SD card may damage or erase the data stored on the SD card. We recommend saving important data on a computer.

Before using

HDD handling precautions

This unit has an internal HDD. The HDD is a precision instrument so take care when handling it.

■ Do not cause any vibrations or impacts to this unit.

The HDD may no longer be recognised or recording or playback may no longer be possible. In particular, do not cause any vibrations or impacts during recording or playback.

■ Do not drop this unit.

The HDD may be damaged if this unit receives a strong impact due to being dropped etc. This unit has a drop detection function to protect the HDD from impact if this unit is dropped. If it detects that this unit has been dropped during motion picture recording, the HDD protection operation sound may be recorded. Also if it detects that the unit is being continuously dropped, recording or playback may stop.

■ Take note of the temperature of this unit

It may no longer be possible to record or playback if the temperature of this unit is too high or low. A warning message will appear on this unit's LCD monitor if an irregularity in the temperature is detected. (→ 94)

■ Do not use the unit in a low pressure area

The HDD may be damaged if you use this unit where the altitude is more than 3000 m.

■ Back up important recorded data to protect it.

Save recorded data periodically on a computer, DVD disc, etc. for backup purposes. If the HDD fails, the recorded data cannot be repaired.

■ Indemnity concerning recorded content

Panasonic does not accept any responsibility for damages directly or indirectly due to any type of problems that result in loss of recording or edited content, and does not guarantee any content if recording or editing does not work properly. Likewise, the above also applies in a case where any type of repair is made to the unit (including any other non-HDD related component).

Access lamp

■ ACCESS/PC lamp

- When this unit accesses the HDD (reading, recording, playback, erasing, etc.), the ACCESS/PC lamp lights up.
- If the following operations are performed when the ACCESS/PC lamp is lit, then the HDD or the recorded data may be damaged or this unit may malfunction.
 - Causing strong vibrations or impacts to this unit
 - Operating the OFF/ON switch or the mode dial
 - Removing the battery or disconnecting the AC adaptor

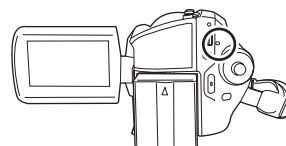

Before using

■ Card access lamp

- When this unit accesses the SD card (reading, recording, playback, erasing, etc.), the access lamp lights up.
- If the following operations are performed when the access lamp is lit, then the SD card or the recorded data may be damaged or this unit may malfunction.
 - Opening the card slot cover
 - Removing the SD card
 - Operating the OFF/ON switch or the mode dial
 - Removing the battery or disconnecting the AC adaptor

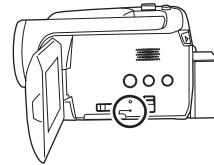

Setup

Power supply

Charging the battery

When this unit is purchased, the battery is not charged. Charge the battery before using this unit.

- If the DC cable is connected to the AC adaptor, then the battery will not be charged. Remove the DC cable from the AC adaptor.

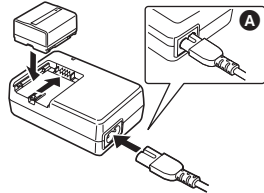

- 1 Connect the AC cable to the AC adaptor and the AC outlet.

- 2 Put the battery on the battery mount by aligning the mark, and then securely plug it in.

- The output plug of the AC cable is not completely connected to the AC adaptor socket. As shown in A, there is a gap.

■ Charging lamp

Lights up: Charging

Goes off: Charging completed

Flashing: The battery is over discharged (discharged excessively). In a while, the lamp will light up and normal charging will start.

When the battery temperature is excessively high or low, the CHARGE lamp flashes and the charging time will be longer than normal.

- Battery charging time (→ 21)
- We recommend using Panasonic batteries. (→ 10, 11)
- If you use other batteries, we cannot guarantee the quality of this product.

Inserting the battery

Push the battery against the battery holder and slide it until it clicks.

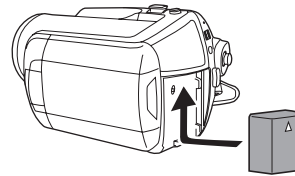

Removing the battery

While sliding the BATTERY lever, slide the battery to remove it.

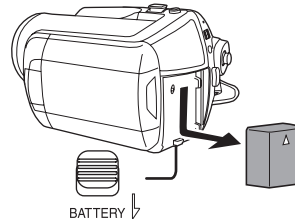

- Hold the battery with your hand so it does not fall.
- Before removing the battery, be sure to set the OFF/ON switch to OFF and check that the status indicator is off.

CAUTION

Danger of explosion if battery is incorrectly replaced. Replace only with the same or equivalent type recommended by the manufacturer. Dispose of used batteries according to the manufacturer's instructions.

Charging time and recordable time

The times shown in the tables below are for when the temperature is 25 °C and the humidity is 60%. If the temperature is higher or lower than 25 °C, the charging time will become longer.

■ Charging time

- The charging time shown in the table are approximations.
- “2 h 25 min” indicates 2 hours 25 minutes.

SDR-H250:

Battery model number	Voltage/capacity	Charging time
Supplied battery/ CGA-DU12 (optional)	7.2 V/1150 mAh	2 h 25 min
CGA-DU14 (optional)	7.2 V/1360 mAh	2 h 45 min
CGA-DU21 (optional)	7.2 V/2040 mAh	3 h 55 min

SDR-H20:

Battery model number	Voltage/capacity	Charging time
Supplied battery/ CGR-DU06 (optional)	7.2 V/640 mAh	1 h 40 min
CGA-DU07 (optional)	7.2 V/680 mAh	1 h 30 min
CGA-DU12 (optional)	7.2 V/1150 mAh	2 h 25 min
CGA-DU14 (optional)	7.2 V/1360 mAh	2 h 45 min
CGA-DU21 (optional)	7.2 V/2040 mAh	3 h 55 min

■ Recordable time

- The actual recordable time refers to the recordable time when repeatedly starting/stopping recording, turning the unit on/off, moving the zoom lever, etc.
- “2 h 5 min” indicates 2 hours 5 minutes.

SDR-H250:

Battery model number	Voltage/capacity	Recording destination	Maximum continuously recordable time	Actual recordable time
Supplied battery/ CGA-DU12 (optional)	7.2 V/1150 mAh	HDD	2 h 5 min	55 min
		SD	2 h 20 min	1 h
CGA-DU14 (optional)	7.2 V/1360 mAh	HDD	2 h 30 min	1 h 5 min
		SD	2 h 45 min	1 h 15 min
CGA-DU21 (optional)	7.2 V/2040 mAh	HDD	3 h 45 min	1 h 40 min
		SD	4 h 10 min	1 h 50 min

Setup

SDR-H20:

Battery model number	Voltage/capacity	Recording destination	Maximum continuously recordable time	Actual recordable time
Supplied battery/ CGR-DU06 (optional)	7.2 V/640 mAh	HDD	1 h 35 min	40 min
		SD	1 h 45 min	45 min
CGA-DU07 (optional)	7.2 V/680 mAh	HDD	1 h 40 min	45 min
		SD	1 h 55 min	50 min
CGA-DU12 (optional)	7.2 V/1150 mAh	HDD	2 h 50 min	1 h 15 min
		SD	3 h 15 min	1 h 25 min
CGA-DU14 (optional)	7.2 V/1360 mAh	HDD	3 h 25 min	1 h 30 min
		SD	3 h 50 min	1 h 40 min
CGA-DU21 (optional)	7.2 V/2040 mAh	HDD	5 h 10 min	2 h 15 min
		SD	5 h 45 min	2 h 35 min

- The display changes as the battery capacity reduces.

 .

If the battery discharges, then  () will flash.

- The recordable times will vary depending on the status of use. These times are approximations. The recordable time will become shorter when you use this unit with the LCD monitor lit up by pressing the POWER LCD PLUS button.
- The batteries heat up after use or charging. This unit will also heat up while being used. This is not a malfunction.
- Be aware that the operating time of the battery will become shorter in low temperatures. We recommend charging a spare battery for use when recording.

Connecting to the AC outlet

The unit is in the standby condition when the AC adaptor is connected. The primary circuit is always "live" as long as the AC adaptor is connected to an electrical outlet.

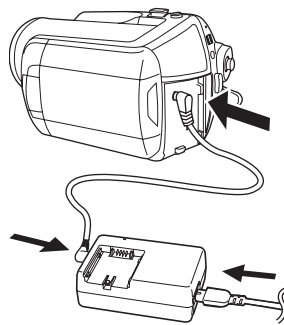

1 Connect the AC cable to the AC adaptor and the AC outlet.

2 Connect the DC cable to the AC adaptor.

3 Connect the DC cable to this unit.

- Do not use the AC cable with any other equipment as it is designed only for this unit. Do not use the AC cable from other equipment with this unit.
- While the DC cable is connected to the AC adaptor, the battery will not be charged.

Turning the unit on/off

- (SDR-H250) When recording, open the lens cover before turning the unit on. (→ 12) If the unit is turned on with the lens cover closed, the automatic white balance adjustment (→ 106) may not function properly.
- (SDR-H20) When recording, remove the lens cap before turning the unit on. If the unit is turned on with the lens cap attached, the automatic white balance adjustment (→ 106) may not function properly.

How to turn on the power

Set the OFF/ON switch to ON.

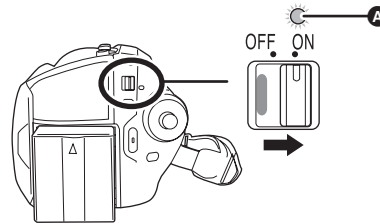

The status indicator **A** lights and the power turns on.

- When the unit is turned on for the first time, a message asking you to set the date and time will appear. Select [YES] and set the date and time. (→ 31)
- When the unit is turned on for the first time, a selection screen will appear to select the recording destination for motion pictures and still pictures. Select [HDD] or [SD CARD] for each type of picture and then press the joystick.

How to turn off the power

Set the OFF/ON switch to OFF.

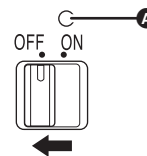

The status indicator **A** goes off when the power turns off.

How to turn the power on and off with the LCD monitor

When the OFF/ON switch is set to ON, the power can be turned on and off with the LCD monitor when the unit is in video recording mode or picture recording mode.

Setup

■ To turn on the power Open the LCD monitor.

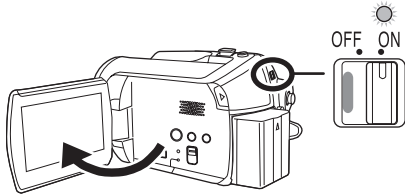

The status indicator lights and the power turns on.

■ To turn off the power Close the LCD monitor.

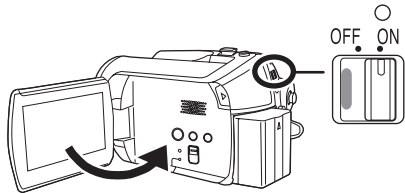

The status indicator goes off and the power turns off.

- The power will not turn off while recording even if the LCD monitor is closed.

Set the OFF/ON switch to OFF when the unit is not being used.

Inserting/removing an SD card

Before inserting/removing an SD card, be sure to set the OFF/ON switch to OFF.

If the SD card is inserted or removed while the OFF/ON switch is set to ON, this unit may malfunction or the data recorded on the SD card may be lost.

1 Set the OFF/ON switch to OFF to turn off the power.

- Check that the status indicator has gone off.

2 Open the LCD monitor and then slide the card slot open lever **A** to open the card slot cover.

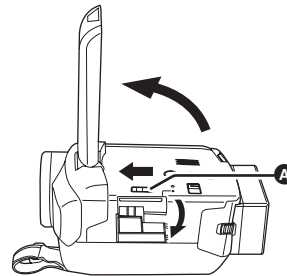

3 Insert/remove the SD card into/from the card slot.

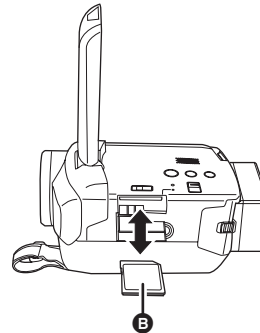

- When inserting an SD card, face the label side **B** upwards and press it straight in as far as it goes.
- When removing the SD card, press the centre of the SD card and then pull it straight out.

4 Securely close the card slot cover.

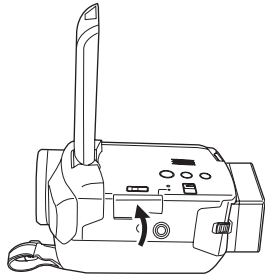



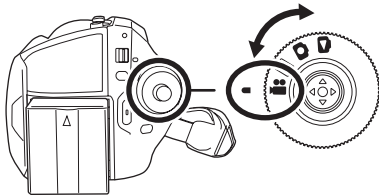

Selecting a mode

The mode dial is used to switch between recording and playback modes. Rotate the mode dial slowly but surely.

Rotate the mode dial, and set the desired mode pictograph to the position shown in the illustration.



	Video recording mode (→ 36) Use this to record motion pictures.
	Video playback mode (→ 55) Use this to play back motion pictures.
	Picture recording mode (→ 39) Use this to record still pictures.
	Picture playback mode (→ 59) Use this to play back still pictures.

- Do not forcefully rotate the dial.

How to use the joystick

This unit has a joystick for selecting functions, performing operations, etc. so it is easy to operate this unit with one hand.

Basic operations

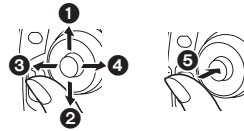

Operations on the menu screen and selection of files on the thumbnail view screen, etc.

Move the joystick up, down, left, or right to select an item or scene, and then press the joystick to set it.



- 1 Select by moving up.
 - 2 Select by moving down.
 - 3 Select by moving left.
 - 4 Select by moving right.
 - 5 Press the joystick to select the item.
- Menu screen operations (→ 29)

Operations during recording

- ◇ Rotate the mode dial to select  or .

- 1 Press the centre of the joystick, and icons will be displayed on the screen.

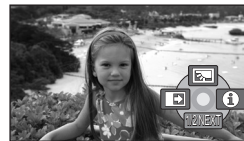

- The indication disappears when the centre of the joystick is pressed again.
- The indication changes each time the joystick is moved down.

Setup

2 Move the joystick up, left or right to select an item.

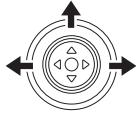

Operations during playback

◇ Rotate the mode dial to select  or .

1 Move the joystick up, down, left or right to select the scene to be played back and press the joystick.

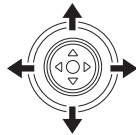

The selected scene is played back on the full screen.

- The operation icon is automatically displayed on the screen.

2 Move the joystick up, down, left or right to operate.

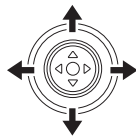

- The operation icon appears or disappears each time the centre of the joystick is pressed.

About the operation icons displayed in each mode

About auto mode and manual mode (→ 35)

Video recording mode

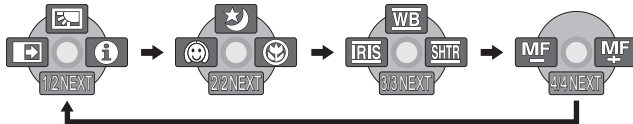

Icon	Direction	Function	Page	
(1/2)		▲	Backlight compensation	45
		◀	Fade	45
		▶	Help mode	29
(2/2)		▲	Colour night view	47
		◀	Soft skin mode	46
		▶	Tele macro (SDR-H250)	47
In manual mode (3/3)		▲	White balance	51
		◀	Iris or gain value	53
		▶	Shutter speed	53
In manual focus mode (4/4)		◀▶	Manual focus adjustment	51

- The shaded operation icons are not displayed while recording.

Video playback mode

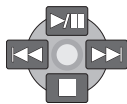

Icon	Direction	Function	Page
	▲	Playback/pause	55
	▼	Stop playback and show thumbnails	55
	◀	Skip	55
		Rewind	56
		Reverse slow/frame playback (during pause)	56
	▶	Skip	55
		Fast forward	56
		Forward slow/frame playback (during pause)	56

Setup

Picture recording mode

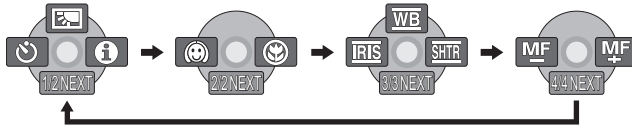

Icon	Direction	Function	Page	
(1/2)		▲	Backlight compensation	45
		◀	Self timer	48
		▶	Help mode	29
(2/2)		◀	Soft skin mode	46
		▶	Tele macro (SDR-H250)	47
In manual mode (3/3)		▲	White balance	51
		◀	Iris or gain value	53
		▶	Shutter speed	53
In manual focus mode (4/4)		◀▶	Manual focus adjustment	51

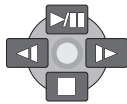

Picture playback mode



Icon	Direction	Function	Page
	▲	Slide show start/pause	59
	▼	Stop playback and show thumbnails	59
	◀	Playback previous picture (during pause)	59
	▶	Playback next picture (during pause)	59

■ Help mode

The help mode explains the operation icons that are displayed when the AUTO/MANUAL/FOCUS switch is set to AUTO in video/picture recording mode.

◇ Rotate the mode dial to select  or .

1 Press the joystick to display the icon during the recording pause.



2 Move the joystick right to select [Ⓢ].



3 Move the joystick up, left or right to select the desired icon.



An explanation of the selected icon is displayed on the screen.

- The indication changes each time the joystick is moved down.

To exit the help mode

Press the MENU button or select [EXIT].



- When the help mode is used, functions cannot be set.
- When the help mode is used, motion pictures and still pictures cannot be recorded.

Switching the language

You can switch the language on the screen display or the menu screen.

1 Press the MENU button, then select [LANGUAGE] and press the joystick.

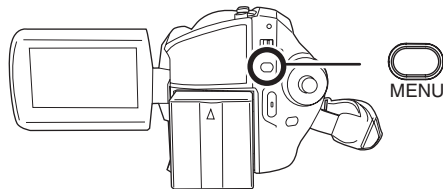

2 Select [English] and press the joystick.

Using the menu screen

Refer to "Menu list" (→ 89) for information about the menus.

1 While stopped, press the MENU button.

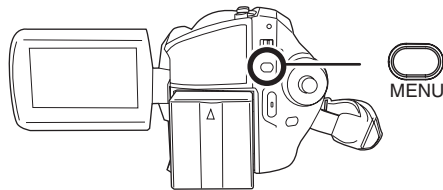

The menu displayed differs depending on the position of the mode dial, the selected medium, etc.

Setup

- Do not switch the mode dial when the menu is displayed.

2 Move the joystick up or down in order to select the desired top menu.



3 Move the joystick right or press the joystick.



4 Move the joystick up or down in order to select the submenu item.



5 Move the joystick right or press the joystick.



6 Move the joystick up or down in order to select the desired item.

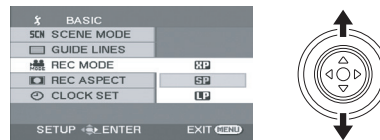

7 Press the joystick to enter the selection.



To get back to the previous screen
Move the joystick left.

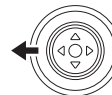

To exit the menu screen
Press the MENU button.



- The menu screen does not appear during recording or playing. You cannot start other operations while the menu screen appears.

Operating with remote control (SDR-H250)

The menu screen transition is the same as when the buttons on the main unit are used.

1 Press the MENU button.

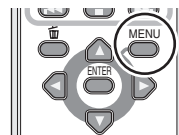

2 Select a menu item.

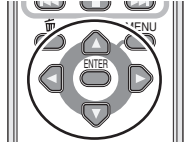

- Use the direction buttons (▲, ▼, ◀, ▶) and ENTER button in place of the joystick on the main unit.

3 Press the MENU button to exit the menu screen.

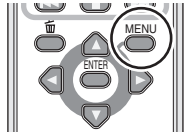

Setting date and time

When the unit is turned on for the first time, a message asking you to set the date and time will appear.

- Select [YES] and press the joystick. Perform steps 2 and 3 below to set the date and time.

If the screen shows the incorrect date and time, then adjust it.

- ◇ Rotate the mode dial to select or .

- 1 Press the MENU button, then select [BASIC] → [CLOCK SET] → [YES] and press the joystick.

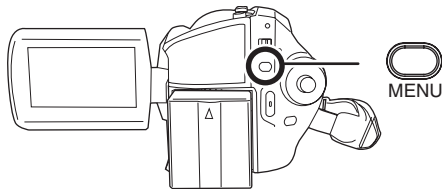

- 2 Move the joystick left or right to select the item to be set. Then, move the joystick up or down to set the desired value.



- The year will change as follows: 2000, 2001, ..., 2099, 2000, ...
- The 24-hour system is used to display the time.

3 Press the joystick to enter the selection.

- The clock function starts at [00] seconds when the joystick is pressed.
- After pressing the MENU button to finish the setting, check the date and time display.

■ Changing the date and time display style

Press the MENU button, then select [SETUP] → [DATE/TIME] → desired display style and press the joystick.

- You can also show or change the date and time display by repeatedly pressing the DATE/TIME button on the remote control. (SDR-H250)

[DATE]	[D/T]
15.12.2007	15.12.2007 15:30
[OFF]	

■ Changing the display style

Press the MENU button, then select [SETUP] → [DATE FORMAT] → desired display style and press the joystick.

Setup

Display style	Screen display
[Y/M/D]	2007.12.15
[M/D/Y]	12.15.2007
[D/M/Y]	15.12.2007

- The date and time function are driven by a built-in lithium battery.
- Make sure to check the time before recording.
- If the time display becomes [- -], the built-in lithium battery has run down. Use the following steps to charge the battery. When you turn on the power for the first time after charging, a message asking you to set the date and time will appear. Select [YES] and set the date and time.

To recharge the built-in lithium battery

Connect the AC adaptor or attach the battery to the unit, and the built-in lithium battery will be recharged. Leave the unit as it is for approx. 24 hours and the battery will save the date and time for approx. 6 months. (Even if the OFF/ON switch is set to OFF, the battery is still being recharged.)

WARNING

THE LITHIUM BATTERY IN THIS EQUIPMENT MUST ONLY BE REPLACED BY QUALIFIED PERSONNEL. WHEN NECESSARY, CONTACT YOUR LOCAL PANASONIC SUPPLIER.

Adjusting the LCD monitor

Adjusting the brightness and colour level

- 1 Press the MENU button, then select [SETUP] → [LCD SET] → [YES] and press the joystick.

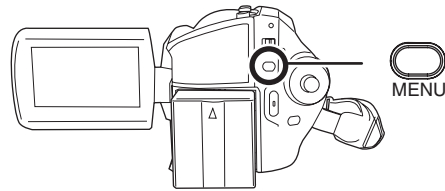

- 2 Move the joystick up or down to select the item to be adjusted. Then, move the joystick left or right to make the adjustment.



The bar display moves.

[BRIGHTNESS]:

Brightness of the LCD monitor

[COLOUR]:

Colour level of the LCD monitor

- When the LCD monitor is rotated by 180° towards the lens, the brightness and colour level of the LCD monitor cannot be adjusted.
- These settings will not affect the images actually recorded.

Increasing and decreasing the brightness of the entire LCD monitor

Press the **POWER LCD PLUS** button.

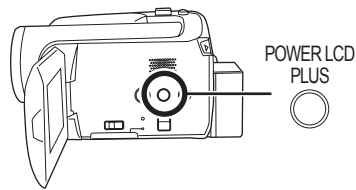

Each time you press the button:

- 1 Original brightness
- 2 Bright
- 3 Brighter
- 4 Darker
- 5 Dark

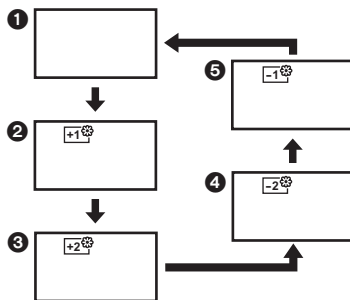

- This will not affect the images to be recorded.
- If you turn on the unit when the AC adaptor is used, this function will automatically be "Bright".
- (SDR-H250) The LCD monitor will become a little darker when the video light is lit.

Recording

Before recording

Basic camera positioning

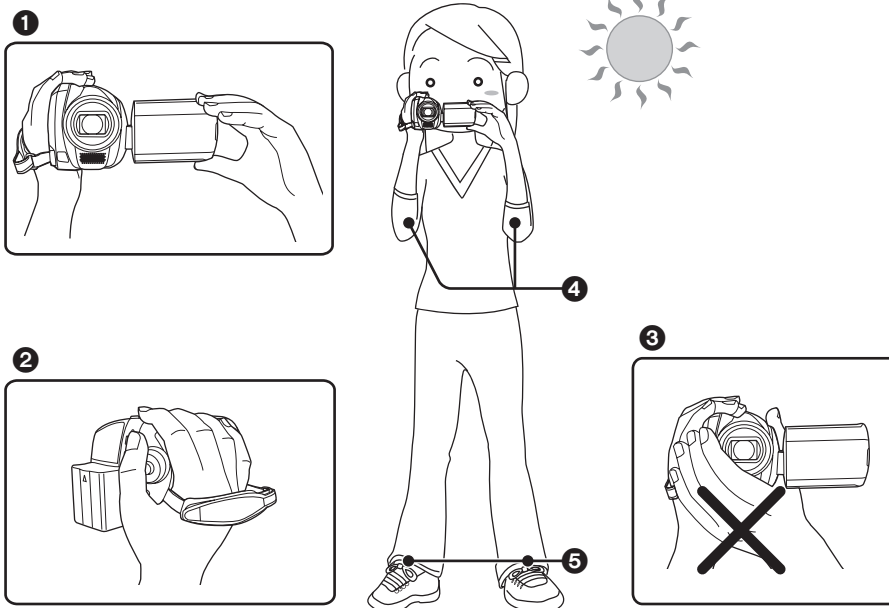

- ❶ Hold the camera with both hands.
 - ❷ Put your hand through the grip belt.
 - ❸ Do not cover the microphones or sensors with your hands.
 - ❹ Keep your arms near your body.
 - ❺ Slightly open your legs.
- When you are outdoors, record pictures with the sunlight behind you. If the subject is backlit, it will become dark in the recording.
 - When recording, make sure your footing is stable and there is no danger of colliding with another person or an object.

■ About auto mode

Set the AUTO/MANUAL/FOCUS switch to AUTO, and colour balance (white balance) and focusing will be adjusted automatically.

- Auto white balance (→ 106)
- Auto focusing (→ 107)

Depending on the brightness of the subject etc., the aperture and shutter speed are automatically adjusted for optimum brightness.

(When set to the video recording mode: The shutter speed is adjusted to a maximum of 1/250.)

- Colour balance and focus may not be adjusted automatically depending on light sources or scenes. If so, manually adjust these settings.
 - Scene mode (→ 50)
 - White balance (→ 51)
 - Shutter speed (→ 53)
 - Iris/gain value (→ 53)
 - Focus (→ 51)

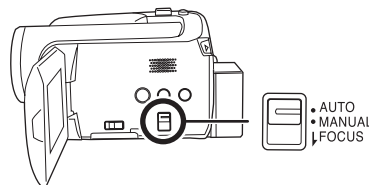

■ Anti-Ground-Shooting (AGS) (SDR-H250)

This function prevents unnecessary recording when you forget to pause recording and walk with the unit tilted upside down while recording continues.

- If the unit continues to be tilted upside down from the normal horizontal position while recording motion pictures, it is automatically set to recording pause.



◇ Rotate the mode dial to select .

Press the MENU button, then select [SETUP] → [AGS] → [ON] and press the joystick.

- The AGS function may activate and cause the unit to pause the recording if you are recording a subject right above or right below you. In these cases, set [AGS] to [OFF] then continue the recording.
- Use the recording start/stop button to pause the recording. The AGS function is only a backup function for when you forget to pause the recording.
- The time it takes the unit to be put into recording pause after being tilted upside down varies depending on the operating conditions.

Recording

Recording motion pictures

HDD SD

This unit can be used for recording motion pictures to the internal HDD and an SD card. (→ 16) Before recording, use the menu to select the recording destination. (→ below)

When the unit is turned on for the first time, the media select screen for recording motion pictures will appear. Select [HDD] or [SD CARD] and press the joystick.

- When the unit is purchased, the aspect ratio is set to [16:9] for recording images compatible with a wide-screen TV.

To watch images on a regular TV (4:3), change the aspect ratio setting (→ 49) before recording the images or when watching them on the connected TV (→ 72).

- (SDR-H250) Open the lens cover before turning the unit on.
If the unit is turned on with the lens cover closed, the automatic white balance adjustment may not function properly.
- (SDR-H20) Remove the lens cap before turning the unit on.
If the unit is turned on with the lens cap attached, the automatic white balance adjustment may not function properly.

1 Turn the unit on.

2 Rotate the mode dial to select .

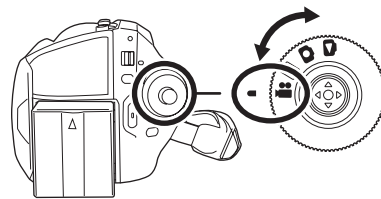

3 Open the LCD monitor.

4 Press the MENU button, then select [MEDIA SELECT] → [HDD] or [SD CARD] to select the recording destination and press the joystick.

5 Press the recording start/stop button to start recording.

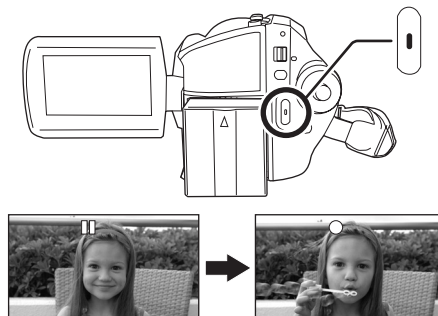

Recording

To end the recording

Press the recording start/stop button again to pause recording.

- [●] and [■] are red during recording. Do not move this unit until [■] is green.

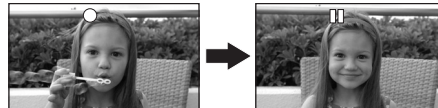

The images recorded between pressing the recording start/stop button to start recording and pressing it again to pause recording become one scene.

However if the recording destination is the HDD, the scene is automatically divided when the recorded data exceeds 4 GB. (The recording will continue.)

- When about 5 minutes have passed without any operation in recording pause, the unit automatically turns off to prevent the battery from running down. When you want to use the unit, turn it on again. This setting can also be set to [OFF]. (→ 90, [POWER SAVE])

Screen indications in the video recording mode

- A** Recording mode
- B** Selected recording destination
- C** Remaining time left for recording
(When the remaining time is less than 1 minute, [R 0h00m] flashes red.)
- D** Recording time elapsed



- Sound is recorded from the internal stereo microphone on the front of the unit. Take care not to block this microphone.
- If the write protection switch on the SD card is set to LOCK, it cannot be used for recording. (→ 17)
- Each time the unit enters the recording pause mode, the counter display will be reset to "0h00m00s".
- While motion picture recording is in progress, the recording will not stop even if the LCD monitor is closed.
- While motion picture recording is in progress, do not disconnect the AC adaptor or remove the battery. If you do, a repair message may be displayed when the power is turned back on. (→ 95, About recovery)

Recording

Recording modes and recordable time available for the motion picture

Changing the recording mode of the motion picture.

Press the MENU button, then select [BASIC] → [REC MODE] → desired item and press the joystick.

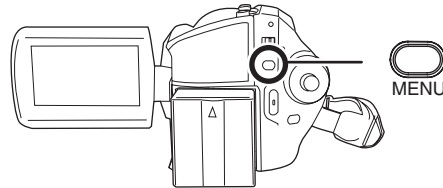

• The recordable time shown in the table are approximations.

■ HDD

Capacity	Recording mode		
	XP (High quality)	SP (Normal)	LP (Long play)
30 GB	7 h	13 h 30 min	27 h

Image quality prioritized ↔ Recording time prioritized

■ SD card

Capacity	Recording mode		
	XP (High quality)	SP (Normal)	LP (Long play)
256 MB	3 min	6 min	12 min
512 MB (supplied)	6 min	12 min	25 min
1 GB	12 min	25 min	50 min
2 GB	25 min	50 min	1 h 40 min
4 GB	50 min	1 h 40 min	3 h 20 min

Image quality prioritized ↔ Recording time prioritized

• This unit records in VBR. VBR is an abbreviation for Variable Bit Rate. VBR recording automatically varies the bit rate (amount of data in a fixed time) depending on the subject being recorded. This means if a subject with sharp movements is recorded, the recording time is reduced.

• Mosaic-pattern noise may appear on a playback image in the following cases.

- When there is a complicated pattern in the background
- When the unit is moved too much or too fast
- When a subject with sharp movements has been recorded
(Particularly if it has been recorded in [LP] mode.)

• If you record still pictures on the HDD or an SD card, the recordable time available for the motion picture will become shorter.

Recording still pictures

HDD SD

This unit can be used for recording still pictures to the internal HDD and an SD card. (→ 16) Before recording, use the menu to select the recording destination. (→ below)

When the unit is turned on for the first time, the media select screen for recording still pictures will appear. Select [HDD] or [SD CARD] and press the joystick.

- When this unit is purchased, [PICTURE SIZE] is set to [[2M]] (SDR-H250)/[[0.2M]] (SDR-H20) for recording pictures compatible with a wide-screen TV (16:9).
To record pictures with a 4:3 aspect ratio, change the [PICTURE SIZE] setting before recording (→ 42).
- (SDR-H250) Open the lens cover before turning the unit on.
If the unit is turned on with the lens cover closed, the automatic white balance adjustment may not function properly.
- (SDR-H20) Remove the lens cap before turning the unit on.
If the unit is turned on with the lens cap attached, the automatic white balance adjustment may not function properly.

1 Turn the unit on.

2 Rotate the mode dial to select .

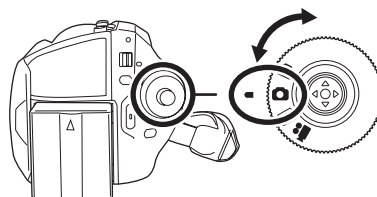

3 Open the LCD monitor.

4 Press the MENU button, then select [MEDIA SELECT] → [HDD] or [SD CARD] to select the recording destination and press the joystick.

■ SDR-H250

5 Press the Photoshot button halfway in order to adjust focusing. (For auto focusing only)

The shutter speed and the iris/gain value are fixed and the unit focuses on the subject automatically.

- If [O.I.S.] (→ 49) is set to [ON], the image stabilizer function will become more effective when the Photoshot button  is pressed halfway.
([[MEGA]] (MEGA optical image stabilizer) will be displayed.)

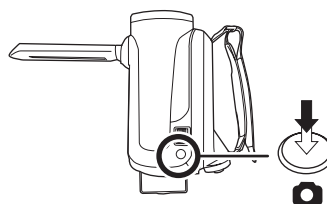

Recording

A Focus indication

- (The white lamp flashes.): Focusing
- (The green lamp lights up.): When in focus
- No mark: When focusing is unsuccessful.
- The focus indication is indicated as follows when the Photoshot button [] is not pressed halfway. Please use it as a guide for recording.
- (The green lamp lights up.): When in focus and a good picture can be recorded.
- (The white lamp lights up.): Almost in focus

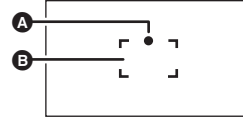

B Focus area

6 Press the Photoshot button [] fully to take the picture.

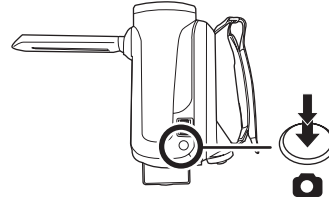



■ SDR-H20

5 Press the Photoshot button [].

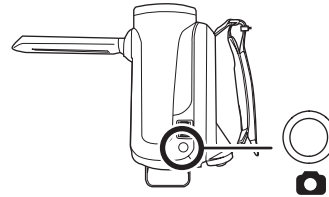
The unit automatically focuses on the subject at the centre of screen (when auto focus is selected).



- For information about the number of recordable still pictures (→ 112)
- The sound cannot be recorded.
- If the write protection switch on the SD card is set to LOCK, it cannot be used for recording. (→ 17)
- The Photoshot button [] on the remote control cannot be pressed halfway. (SDR-H250)
- If the [PICT. QUALITY] is set to [], mosaic-pattern noise may appear on a playback image depending on the picture content.
- Other products may degrade or not play back still pictures recorded with this unit.

■ To record still pictures clearly

- When zooming in on the subject with a magnification of 4× or higher, it is difficult to reduce the slight shaking from holding this unit by hand. We recommend decreasing the zoom magnification and approaching the subject when recording.
- When recording still pictures, hold the unit firmly with your hands and keep your arms stationary at your side so as not to shake the unit.
- You can record stable pictures without shaking by using a tripod and the remote control.

Screen indications in picture recording mode

- A** Size of still pictures
- B** Selected recording destination
- C** Remaining number of still pictures
(Flashes in red when [R 0] appears.)
- D** Quality of still pictures



■ About the focus indication (SDR-H250)

- The focus indication does not appear in manual focus mode.
- Focus on a subject manually when it is not easily focused.
- You can record still pictures even if the focus indication does not appear, but pictures may be recorded without being focused.
 - When the zoom magnification is high.
 - When the unit is shaken.
 - When the subject is moving.
 - When the subject stands in front of a light source.
 - When close subjects and far subjects are included in the same scene.
 - When the scene is dark.
 - When there is a bright part in the scene.
 - When the scene is filled with only horizontal lines.
 - When the scene lacks contrast.

■ Concerning the focusing area (SDR-H250)

When there is a contrasting object ahead or behind the subject in the focus area, the subject may not be focused. If so, move the contrasting object out of the focus area. Even when it is still difficult to focus, adjust the focus manually.

Recording with a shutter operation effect

You can add a shutter sound when recording still pictures.

Press the MENU button, then select [ADVANCED] → [SHTR EFFECT] → [ON] and press the joystick.

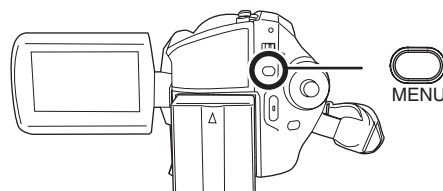

- This function's default setting is [ON].

Recording

Number of pixels and picture quality for still picture recording

■ [PICTURE SIZE]

Changing the recording size.

Press the MENU button, then select [BASIC] → [PICTURE SIZE] → desired item and press the joystick.

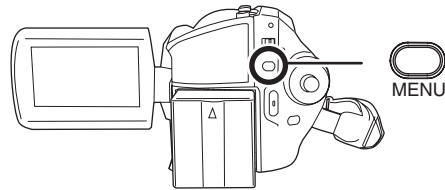

SDR-H250:

Icon	Aspect	Number of pixels
	4:3	2048×1512
	4:3	1280×960
	4:3	640×480
	16:9	1920×1080

SDR-H20:

Icon	Aspect	Number of pixels
	4:3	640×480
	16:9	640×360

- When this unit is purchased, [PICTURE SIZE] is set to [] (SDR-H250)/[] (SDR-H20). The sides of pictures recorded with a 16:9 aspect ratio may be cut at printing. Check before printing.

■ [PICT. QUALITY]

Selecting the picture quality.

Press the MENU button, then select [BASIC] → [PICT. QUALITY] → desired item and press the joystick.

- : Still pictures with a high picture quality are recorded.
- : Priority is given to the number of still pictures recorded. Still pictures are recorded in normal picture quality.

Various recording functions

Zoom in/out function



HDD SD

SDR-H250:

You can zoom in up to 10× optically.

SDR-H20:

You can zoom in up to 32× optically.

◇ Rotate the mode dial to select  or .

Move the zoom lever.

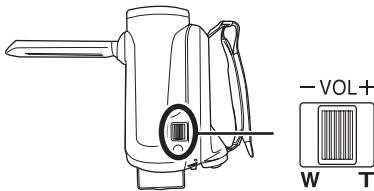

T side:

Close-up recording (zoom in)

W side:

Wide-angle recording (zoom out)

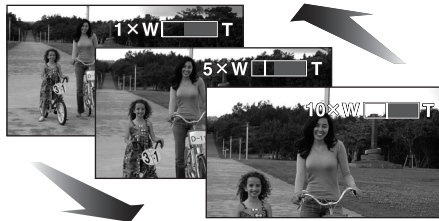

- When zooming in while holding this unit by hand, we recommend using the image stabilizer function. (→ 49)
- When distant subjects are brought closer, they are focused at about 1 m (SDR-H250)/1.3 m (SDR-H20) or more.
- When the zoom magnification is 1×, this unit can focus on a subject approx. 3.5 cm

(SDR-H250)/2 cm (SDR-H20) away from the lens. (Macro function)

- The zoom speed varies depending on the range over which the zoom lever is moved. (The zoom speed does not vary when operating with the remote control.)
- When the zoom speed is high, the subject may not be focused easily.
- If you take your finger off the zoom lever during zoom operation, the operation sound may be recorded. When returning the zoom lever to the original position, move it quietly.

Digital zoom function

HDD SD

If the zoom magnification exceeds 10× (SDR-H250)/32× (SDR-H20), then the digital zoom function will be activated. The maximum magnification provided by the digital zoom can be switched.

◇ Rotate the mode dial to select .

Press the MENU button, then select [ADVANCED] → [D.ZOOM] → desired item and press the joystick.

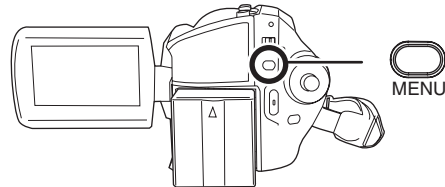

SDR-H250:

[OFF]: Optical zoom only (Up to 10×)

[25×]: Up to 25×

[700×]: Up to 700×

- If [25×] or [700×] is selected, the digital zoom range is displayed in blue while zooming.

SDR-H20:

[OFF]: Optical zoom only (Up to 32×)

[50×]: Up to 50×

[1000×]: Up to 1000×

- If [50×] or [1000×] is selected, the digital zoom range is displayed in blue while zooming.

- The larger the digital zoom magnification, the more the image quality is degraded.

Recording

- This function cannot be used in picture recording mode.

To use the zoom microphone function

HDD SD

The zoom microphone is linked to the zooming operation so that far-away sounds with a tele-shot and close-up sounds with a wide-angle shot are recorded more clearly.

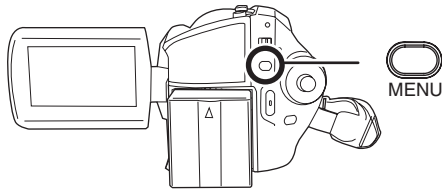

- ◇ Rotate the mode dial to select .
- Press the MENU button, then select [ADVANCED] → [ZOOM MIC] → [ON] and press the joystick.



Recording yourself

HDD SD

You can record yourself while viewing the LCD monitor.

- ◇ Rotate the mode dial to select  or .
- Rotate the LCD monitor towards the lens side.

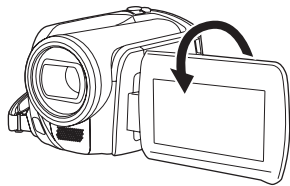

The image is horizontally flipped as if you see a mirror image. (However the image recorded is the same as a normal recording.)

- When the LCD monitor is rotated towards the lens side, the icon will not be displayed even if you press the joystick.
- Only some indications will appear on the screen. When  appears, return the direction of the LCD monitor to normal position and check the warning/alarm indication. (→ 94)



Recording with the video light (SDR-H250)

This built-in video light is for recording in dark places.

HDD SD

Gain up mode works with the video light to enhance the light's brightness and brighten the natural colours in a scene.

- Gain up mode cannot be used in picture recording mode.

- ◇ Rotate the mode dial to select  or .

Press the LIGHT button.

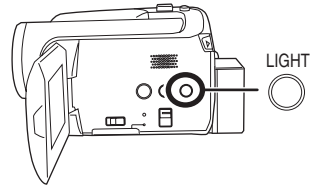

Each time you press the LIGHT button:

- Video light and gain up mode on (video recording mode only):**
Brighter than when only the video light is on, but washed out images will appear.
- Video light on:**
To eliminate washed out images, use this mode.
- Video light off**

Recording

- Video recording mode

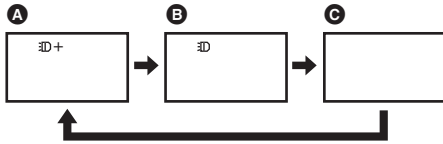

- Picture recording mode

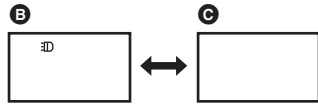

- The subject should be within 1.3 m of the unit.
- Using the video light reduces battery time.
- Set the video light to off when not in use.
- Do not look directly into the light.
- Using the colour night view function at the same time will make conditions even brighter.
- The video light enables brightening of the images taken in a dimly-lit place. We also recommend using it in a bright place to obtain high quality images.
- If you turn off the power or operate the mode dial, the video light is turned off.

Backlight compensation function

This is for protecting a backlit subject from being darkened.

HDD SD

Use this function when the light is emanating from behind the subject and the subject appears dark.

- ◇ Rotate the mode dial to select or .

- 1 Press the joystick. Then move the joystick down to display the icon shown in the illustration.



- 2 Move the joystick up to select .



The image on the screen will become brighter.

To return to normal recording

Select again.

- If you turn off the power or operate the mode dial, the backlight compensation function is cancelled.

Fade in/fade out function

HDD SD

Fade in:

The image and audio gradually appear.

Fade out:

The image and audio gradually disappear.

- ◇ Rotate the mode dial to select .

- 1 Press the joystick. Then move the joystick down to display the icon shown in the illustration.



Recording

2 Move the joystick left to select [RECALL].



3 Press the recording start/stop button.

Start recording. (Fade in)



When you start recording, the image/audio gradually appears.

Pause recording. (Fade out)



The image/audio gradually disappears. After the image/audio completely disappears, recording stops.

- After recording, the fade setting is cancelled.

To cancel fading

Select [RECALL] again.

To select the colour for fade in/out

The colour which appears in fading pictures can be selected.

Press the MENU button, then select [ADVANCED] → [FADE COLOUR] → [WHITE] or [BLACK] and press the joystick.

- If you turn off the power, the fade function is cancelled.
- While the fade in/fade out function is selected, it takes several seconds to display the image when you start recording. It also takes several seconds to pause recording.
- The thumbnails of scenes recorded using fade in become black (or white).

Soft skin mode

This makes skin colours appear softer for a more attractive appearance.

HDD SD

This is more effective if you record a person closely from the torso up.

◇ Rotate the mode dial to select or .

1 Press the joystick. Then move the joystick down to display the icon shown in the illustration.



2 Move the joystick left to select [RECALL].



To cancel the soft skin mode

Select [RECALL] again.

Recording



- If the background or anything else in the scene has colours similar to the skin colour, they will also be smoothed.
- If the brightness is insufficient, the effect may not be clear.
- You may not be able to see the face clearly when recording a distant person. In this case, cancel soft skin mode or zoom in on the face.

Tele macro function (SDR-H250)

This is for bringing only what you want to record into focus to take close-ups.

HDD SD

By focusing only on the subject and blurring the background, the image can be impressive. The unit can focus on the subject at a distance of approx. 50 cm.

- ◇ Rotate the mode dial to select  or .

- 1** Press the joystick. Then move the joystick down to display the icon shown in the illustration.



- 2** Move the joystick right to select [].



- If the magnification is 10× or less, then it is automatically set to 10×.

To cancel the tele macro function

Select [] again.

- If a sharper focus cannot be achieved, adjust the focus manually. (→ 51)
- In the following cases, the tele macro function is cancelled.
 - The zoom magnification becomes lower than 10×.
 - The power is turned off or the mode dial is operated.

Colour night view function

This allows recording in dark locations.

HDD SD

This function allows you to record colour subjects in dark locations to stand out against the background.

Attach this unit to a tripod, and you can record images free from vibration.

- Minimum required illumination: approx. 1 lx (SDR-H250)/approx. 2 lx (SDR-H20)
- Recorded scene is seen as if frames were missed.

- ◇ Rotate the mode dial to select .

- 1** Press the joystick. Then move the joystick down to display the icon shown in the illustration.

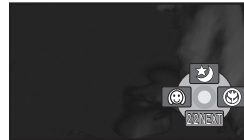

- 2** Move the joystick up to select [].



- If it is difficult to focus, adjust the focus manually. (→ 51)

Recording

To cancel the colour night view function

Select [★] again.

- The colour night view function makes the signal charging time of CCD up to approximately 25× longer than usual, so that dark scenes can be recorded brightly. For this reason, bright dots that are usually invisible may be seen, but this is not a malfunction.
- If you turn off the power or operate the mode dial, the colour night view function is cancelled.
- If set in a bright place, the screen may become whitish for a while.

Self-timer recording

This is for recording shots of yourself as well.

HDD SD

You can record still pictures using the timer.

◇ Rotate the mode dial to select .

1 Press the joystick. Then move the joystick down to display the icon shown in the illustration.

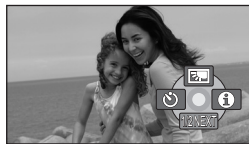

2 Move the joystick left to select [⌚].



3 Press the Photoshot button [📷].

After the [⌚] display flashes for approx.

10 seconds, a still picture will be recorded.

- After recording, the self-timer is cancelled.
- If you press the Photoshot button [📷] halfway and then fully in auto focus mode, the subject

is focused when the button is pressed halfway. (SDR-H250)

- When you press the Photoshot button [📷] fully in auto focus mode, the subject is focused just before recording. (SDR-H250)

To stop the timer midway through

Press the MENU button. (The self-timer setting is cancelled.)



- If you turn off the power, the self-timer standby mode is cancelled.
- Depending on the time taken to bring the subject into focus, the recording may take longer than the set time before the picture is taken.

Recording guideline function

Checking if the image is level.

HDD SD

You can check if the image is level while recording by using the lines displayed on the screen.

◇ Rotate the mode dial to select  or .

Press the MENU button, then select [BASIC] → [GUIDE LINES] → [ON] and press the joystick.

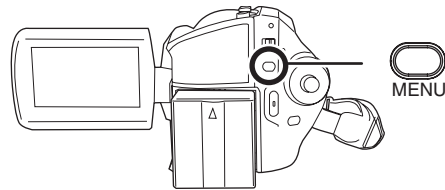

To cancel the Recording guideline function

Press the MENU button, then select [BASIC] → [GUIDE LINES] → [OFF] and press the joystick.

- The guidelines do not appear on the images actually recorded.
- The guidelines are not displayed while rotating the LCD monitor frontward to record yourself.

Wide mode

This is for selecting the screen's aspect ratio when recording motion pictures.

HDD SD

This allows you to record images compatible with wide-screen TVs (16:9) and regular TVs (4:3).

■ Recording images with a 16:9 aspect ratio

◇ Rotate the mode dial to select . Press the MENU button, then select [BASIC] → [REC ASPECT] → [16:9] and press the joystick.

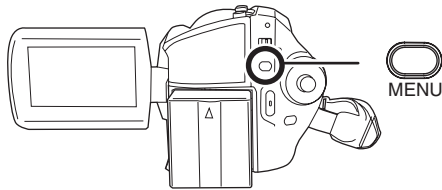

■ Recording images with a 4:3 aspect ratio

◇ Rotate the mode dial to select . Press the MENU button, then select [BASIC] → [REC ASPECT] → [4:3] and press the joystick.



- The default setting is [16:9].

Image stabilizer function

This is for reducing image shakes during recording.

HDD SD

Reduces the image shaking due to hand movement when recording.

◇ Rotate the mode dial to select  or .

Press the MENU button, then select [ADVANCED] → [O.I.S.] → [ON] and press the joystick.

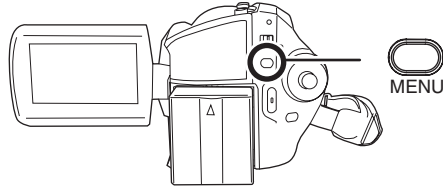

To cancel the image stabilizer function

Press the MENU button, then select [ADVANCED] → [O.I.S.] → [OFF] and press the joystick.

- This function's default setting is [ON].
- In the picture recording mode, pressing the Photoshot button  halfway increases the effect of the image stabilizer function. (MEGA optical image stabilizer) (SDR-H250)
- In the following cases, the image stabilizer function may not work effectively.
 - When the digital zoom is used
 - When the unit is shaken greatly
 - When you record a moving subject while tracking it

Wind noise reduction function

This is for reducing the wind noise coming into the microphone when recording.

HDD SD

◇ Rotate the mode dial to select .

Recording

Press the MENU button, then select [ADVANCED] → [WIND CUT] → [ON] and press the joystick.

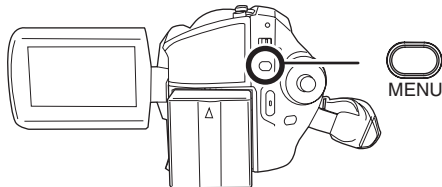

To cancel the wind noise reduction function

Press the MENU button, then select [ADVANCED] → [WIND CUT] → [OFF] and press the joystick.

- This function's default setting is [ON].
- The wind noise reduction depends on the wind strength. (If this function is activated in strong winds, the stereo effect may be reduced. When the wind weakens, the stereo effect will be restored.)

Manual recording functions

Scene mode

This is for recording in various situations.

HDD SD

When you record images in different situations, this mode automatically sets optimum shutter speeds and apertures.

- ◇ Rotate the mode dial to select or .

1 Set the AUTO/MANUAL/FOCUS switch to MANUAL.

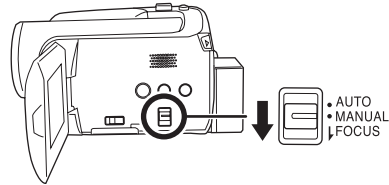

2 Press the MENU button, then select [BASIC] → [SCENE MODE] → desired item and press the joystick.

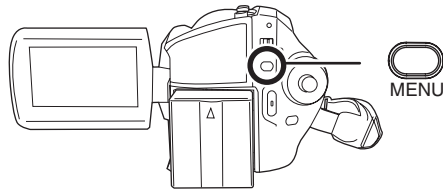

[] Sports

To record sports scenes or scenes where there are quick motions

[] Portrait

To make people stand out against the background

[] Low light

To make the scene brighter in dark conditions

[] Spotlight

To make the subject under a spotlight look more attractive

[] Surf & snow

To record images in bright places such as ski slopes and beaches

To cancel the scene mode function

Press the MENU button, then select [BASIC] → [SCENE MODE] → [OFF] and press the joystick.

- You can also cancel the scene mode function by setting the AUTO/MANUAL/FOCUS switch to AUTO.

Sports mode

- For slow-motion playback or playback pause of recorded pictures, this mode helps diminish camera shake.

Recording

- During normal playback, the image movement may not look smooth.
- Avoid recording under fluorescent light, mercury light or sodium light because the colour and brightness of the playback image may change.
- If you record a subject illuminated with strong light or a highly reflective subject, vertical lines of light may appear.
- If the brightness is insufficient, the sports mode does not function. The [] display flashes.
- If this mode is used indoors, the screen may flicker.

Portrait mode

- If this mode is used indoors, the screen may flicker. If so, change the scene mode setting to [OFF].

Low light mode

- Extremely dark scenes may not be able to be recorded finely.

Spotlight mode

- If the recording subject is extremely bright, the recorded image may become whitish and the periphery of the recorded image extremely dark.



Surf & snow mode

- If the subject is extremely bright, the recorded image may become whitish.

Manual focus adjustment

HDD SD

If auto focusing is difficult due to the conditions, then manual focusing is available.

- ◇ Rotate the mode dial to select  or .

1 Set the AUTO/MANUAL/FOCUS switch to MANUAL.

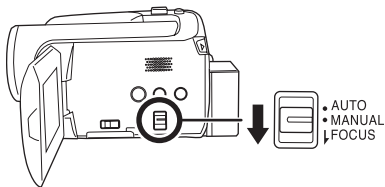

2 Move the switch down and set it to FOCUS position.

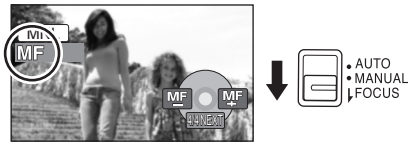

The manual focus indication [MF] and the icon shown in the illustration appear.

3 Move the joystick left or right to bring the subject into focus.



- The subject may not be in focus when zoomed in if focusing with a wide angle. First, zoom in on the subject, and then focus on it.

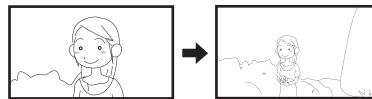

To restore to the automatic adjustment

Press the AUTO/MANUAL/FOCUS switch down again to the FOCUS position.



- You can also restore the auto focusing by setting the AUTO/MANUAL/FOCUS switch to AUTO.

White balance

This is for recording in natural colours.

HDD SD

The automatic white balance function may not reproduce natural colours depending on the scenes or lighting conditions. If so, you can adjust the white balance manually.

- ◇ Rotate the mode dial to select  or .

Recording

1 Set the AUTO/MANUAL/FOCUS switch to MANUAL.

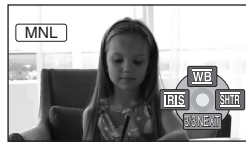

The icon shown in the illustration is displayed automatically.

2 Move the joystick up to select [WB].



3 Move the joystick left or right to select the white balance mode.

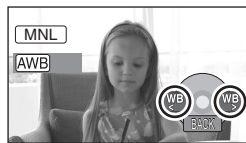

[AWB] Auto white balance adjustment

[☀] Indoor mode (for recording under incandescent lamps)

- Incandescent lights, halogen lamps

[☀] Outdoor mode

- Outdoors under a clear sky

[☀] Manual adjustment mode

- Mercury-vapor lamps, sodium lamps, some fluorescent lights
- Lights used for wedding receptions at hotels, stage spotlights in theatres
- Sunrise, sunset, etc.

To restore to the automatic adjustment

Set the white balance mode to [AWB].

- You can also restore the automatic adjustment by setting the AUTO/MANUAL/FOCUS switch to AUTO.

To set the white balance manually

1 Select [WB], and fill the screen with a white subject.

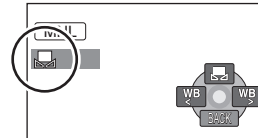

2 Move the joystick up to select [WB].

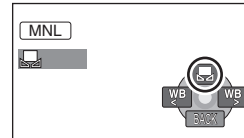

When the [WB] display changes from flashing to on, setting is complete.

- When the [WB] display continues flashing, the white balance cannot be set because the place is dark etc. In this case, use the automatic white balance.

■ About the white balance sensor ^A

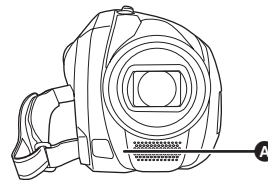

The white balance sensor detects the type of light source during recording.

Do not cover the white balance sensor during recording, or it may not function properly.

■ About the black balance adjustment (SDR-H250)

This is one of the 3CCD system functions that automatically adjusts the black when the white balance is set in the manual adjustment mode. When the black balance is adjusted, the screen

Recording

will temporarily be black. (The black balance cannot be adjusted manually.)



- ① Black balance adjustment in progress. (Flashes.)
- ② White balance adjustment in progress. (Flashes.)
- ③ Adjustment completed. (Lights up.)

- (SDR-H250) When the unit is turned on with the lens cover closed, the automatic white balance adjustment may not function properly. Please turn the unit on after opening the lens cover.
- (SDR-H20) When the unit is turned on with the lens cap attached, the automatic white balance adjustment may not function properly. Please turn the unit on after removing the lens cap.
- When the [WB] display flashes, the manual white balance previously adjusted is stored. Whenever recording conditions change, re-set the white balance for correct adjustment.
- When setting both the white balance and the iris/gain, set the white balance first.

**Manual shutter speed/
aperture adjustment**

HDD SD

Shutter Speed:

Adjust it when recording fast-moving subjects.

Aperture:

Adjust it when the screen is too bright or too dark.

- ◇ Rotate the mode dial to select or .

1 Set the AUTO/MANUAL/FOCUS switch to MANUAL.



The icon shown in the illustration is displayed automatically.

2 Move the joystick left or right to select [IRIS] (aperture) or [SHTR] (shutter speed).



3 Move the joystick left or right to make the adjustment.



A Shutter speed:

- 1/50 to 1/8000
- 1/25 to 1/2000 (SDR-H250)
- 1/50 to 1/500 (SDR-H20)

- The shutter speed closer to 1/8000 is faster.

B Iris/Gain value:

CLOSE → (F16 to F2.0) → OPEN → (0dB to 18dB)

- Value closer to [CLOSE] darken the image.
- Value closer to [18dB] brighten the image.
- When the iris value is adjusted to brighter than [OPEN], it changes to the gain value.

To restore to automatic adjustment

Set the AUTO/MANUAL/FOCUS switch to AUTO.

Recording

- When setting both the shutter speed and the iris/gain value, set the shutter speed and then set the iris/gain value.

■ Manual shutter speed adjustment

- Avoid recording under fluorescent light, mercury light or sodium light because the colour and brightness of the playback image may change.
- If you increase the shutter speed manually, the gain value will increase automatically depending on how much the sensitivity lowers and the noise on the screen may increase.
- You may see vertical lines of light in the playback image of a brightly shining subject or highly reflective subject, but this is not a malfunction.
- During normal playback, image movement may not look smooth.
- When recording in an extremely bright place, the screen may change colour or flicker. If so adjust the shutter speed manually to [1/50] or [1/100].

■ Manual iris/gain adjustment

- If the gain value is increased, the noise on the screen increases.
- Depending on the zoom magnification, there are iris values that are not displayed.

Motion picture playback

HDD SD

Play back the motion pictures recorded on the internal HDD or SD card. Use the menu to select the desired playback medium. (→ below)

1 Rotate the mode dial to select .

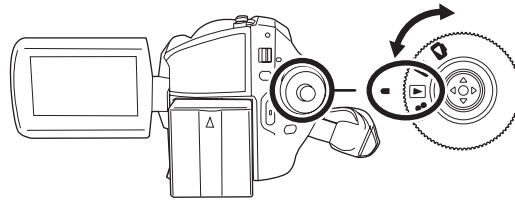

2 Press the MENU button, then select [MEDIA SELECT] → [HDD] or [SD CARD] to select the desired medium and press the joystick.

The motion pictures recorded on the selected medium are displayed as thumbnails.

3 Select the scene to be played back.

- A** Selected medium
- B** Scene number
- C** Scroll bar display

The selected scene will be encircled by a yellow frame.

- When 9 or more scenes have been recorded, the next (or previous) page is displayed by moving the joystick.
- If you move and hold the joystick up or down, you can fast forward or fast rewind the pages. The screen will not change at this time, but the scene numbers and scroll bar display will change. Release the joystick when you have arrived at the page with the scene you want to display.

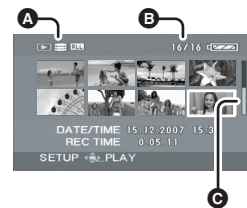





4 Press the joystick.

The selected scene is played back on the full screen.

The operation icon is automatically displayed on the screen.



5 Move the joystick to operate.

- : Playback/Pause
- : Skip playback (backward)
- : Skip playback (forward)
- : Stops the playback and shows the thumbnails.

- No sound will be heard except during normal playback.
- If pause play is continued for 5 minutes, the screen returns to the thumbnails.

Playback

- When the amount of time recorded on the scene is short, playback may not be possible.
- When a scene is displayed as [!] on the thumbnail display, playback is not possible.
- The power will not turn off when the LCD monitor is closed.
- When playing back motion pictures recorded on an SD card with other products on this unit or playing back motion pictures recorded on an SD card with this unit on other products, the picture quality may deteriorate and they may be unplayable. (The message "CANNOT PLAY." appears.)
- The time displayed may be different from the recording time and it may take time to display the thumbnail display when playing back motion pictures recorded on an SD card with other products.

To display the recording date during playback

Press the **MENU** button, then select **[SETUP] → [DATE/TIME] → [D/T] or [DATE]** and press the joystick.

- You can also show or change the date and time display by repeatedly pressing the DATE/TIME button on the remote control. (SDR-H250)
- The recording time is not displayed on the screen during playback of scenes recorded on an SD card with other products.

Fast forward/rewind playback

Move and hold the joystick right during playback until fast-forward starts.

(Move and hold the joystick left to rewind.)

- Move the joystick again to increase the speed.
- Normal playback is restored when you move the joystick up.



■ Operating with the remote control (SDR-H250)

Press the ◀◀ or ▶▶ button.

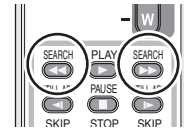

Slow-motion playback

1 Move the joystick up during playback to pause the playback.

2 Move and hold the joystick right.
(Slow-motion pictures will be played back in reverse when you move and hold the joystick left.)

- Normal playback is restored when you move the joystick up.

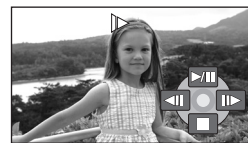

Playback

■ Operating with the remote control (SDR-H250)

Press the ◀ or ▶ button.

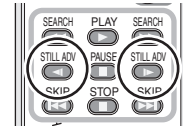

Frame-by-frame playback

The motion picture is advanced one frame at a time.

1 Move the joystick up during playback to pause the playback.

2 Move the joystick right.
(The frames will be advanced one at a time in the reverse direction when you move the joystick left.)

- Normal playback is restored when you move the joystick up.



■ Operating with the remote control (SDR-H250)

1 Press the || button.

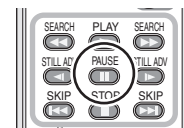

2 Press the ◀ or ▶ button.



To adjust the volume

Adjust the speaker volume during playback.

Move the volume lever to change the volume level.

Towards “+”: increases the volume

Towards “-”: decreases the volume

- The further the [] indicator moves to the right, the higher the volume level becomes.

- When the adjustment is completed, the volume setting display will disappear.

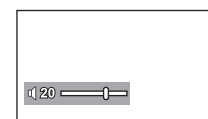
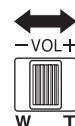

Playing back motion pictures by date

Recorded scenes are grouped by date on this unit.

Playback

Scenes recorded on the same day can be played back in succession.

- 1 Press the **MENU** button, then select **[PLAY SETUP]** → **[PLAY MODE]** → **[BY DATE]** and press the joystick.

The [VIEW BY DATE] screen is displayed by month when playing back motion pictures on the HDD. Proceed to step 3 when playing back an SD card.

- When [PLAY MODE] is set to [VIEW ALL], all recorded motion pictures will be played back in succession.

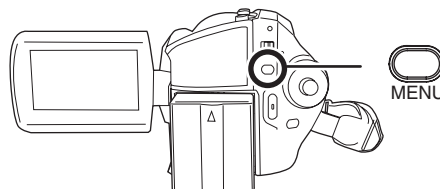

- 2 (When playing back motion pictures on the HDD only) Move the joystick left or right to select the month.



- 3 Move the joystick up or down to select the date for playback, then press the joystick.

The scenes recorded on the same day are displayed as thumbnails.

- 4 Select the scene to be played back.

- Even if scenes are recorded on the same day, they are grouped separately when the number of scenes exceeds 99.

Resuming the previous playback

- Press the **MENU** button, then select **[PLAY SETUP]** → **[RESUME PLAY]** → **[ON]** and press the joystick.

If playback of a motion picture is stopped, [R] appears on the thumbnail view of the stopped scene.

- The resume position on the HDD and the SD card is memorised.
- If playback is stopped at any point during a motion picture while [RESUME PLAY] is set to [OFF], the next time the motion picture is played back, it will be from the beginning.
- The resume position memorised is cleared if you operate the mode dial, etc. (The [RESUME PLAY] setting is kept.)
- [RESUME PLAY] is set to [OFF] if an SD card with the write protection switch at the LOCK position is inserted. (→ 17)

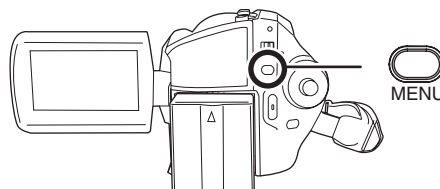

Still picture playback

HDD **SD**

Play back the still pictures recorded on the internal HDD or SD card. Use the menu to select the desired playback medium. (→ below)

1 Rotate the mode dial to select .

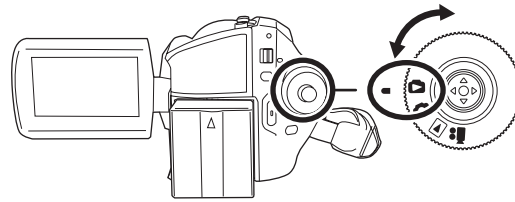

2 Press the MENU button, then select [MEDIA SELECT] → [HDD] or [SD CARD] to select the desired medium and press the joystick.

The still pictures recorded on the selected medium are displayed as thumbnails.

3 Select the file to be played back.

- A** Selected medium
- B** File number
- C** Scroll bar display

The selected file will be encircled by a yellow frame.

- When 9 or more files have been recorded, the next (or previous) page is displayed by moving the joystick.
- If you move and hold the joystick up or down, you can fast forward or fast rewind the pages. The screen will not change at this time, but the file numbers and scroll bar display will change. Release the joystick when you have arrived at the page with the file you want to display.

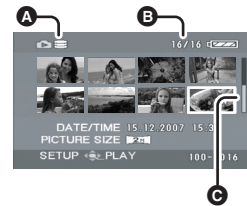

4 Press the joystick.

The selected file is played back on the full screen.

The operation icon is automatically displayed on the screen.



5 Move the joystick to operate.

- ▶/||: Slide show (playback of the still pictures in numerical order) start/pause.
- ◀: Plays back the previous picture.
- ▶: Plays back the next picture.
- : Stops the playback and shows the thumbnails.

■ About still picture compatibility

- This unit is compliant with the unified standard DCF (Design rule for Camera File system) established by JEITA (Japan Electronics and Information Technology Industries Association).

Playback

- The file format supported by this unit is JPEG. (Not all JPEG formatted files will be played back.)
 - If a non-standard file is played back, the folder/file number may not be displayed.
 - This unit may degrade or not play back data recorded or created on another product and another product may degrade or not play back data recorded on this unit.
-

- Do not operate the mode dial during the slide show.
- While this unit accesses the SD card (the access lamp is lit), do not remove the SD card.
- It takes time to display the file depending on the number of pixels of the file.
- When a file is displayed as [?] on the thumbnail display, playback is not possible.
- If you attempt to play back a file recorded in a different format or file data is defective, an error message may appear.
- The time displayed may be different from the recording time and it may take time to display the thumbnail display when playing back still pictures recorded on an SD card with other products.
- The power will not turn off when the LCD monitor is closed.

Editing scenes

Deleting scenes

This is for deleting motion picture scenes.

HDD SD

The deleted scenes cannot be restored.

Deleting scenes one at a time

- ◇ Rotate the mode dial to select .
- ◇ Select [HDD] or [SD CARD] in [MEDIA SELECT].

- 1 Press the  button during playback.**

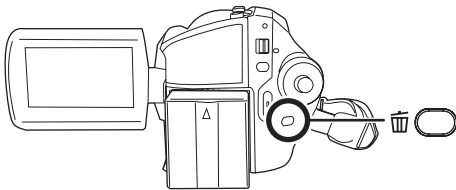

- 2 When the confirmation message appears, select [YES], then press the joystick.**

Deleting multiple scenes from the thumbnail display

- ◇ Rotate the mode dial to select .
- ◇ Select [HDD] or [SD CARD] in [MEDIA SELECT].

- 1 Press the  button in the thumbnail display.**

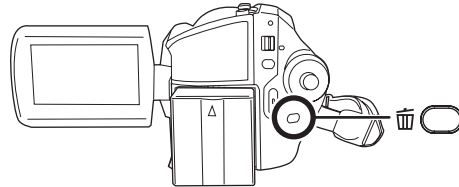

- 2 Select [ALL] or [SELECT] and press the joystick.**

- When [ALL] is selected, the following scenes will be deleted. Proceed to step 5.
 - When [PLAY MODE] is set to [VIEW ALL]: All the scenes on the selected medium except the locked scenes
 - When [PLAY MODE] is set to [BY DATE]: All the scenes selected by date except the locked scenes

- 3 (Only when [SELECT] is selected in step 2) Select the scene to be deleted, then press the joystick.**



The selected scene is encircled by a red frame.

- When the joystick is pressed again, the selected scene will be cancelled.
- Up to 50 scenes can be set in succession.

- 4 (Only when [SELECT] is selected in step 2) Press the  button.**

- 5 When the confirmation message appears, select [YES], then press the joystick.**

(Only when [SELECT] is selected in step 2)

To continue deleting other scenes

Repeat steps 3-5.

Editing

To cancel deleting halfway

Press the MENU button.

- Scenes are deleted from the last scene on the thumbnail display. The scenes that have already been deleted when the deletion is cancelled cannot be restored.

To complete editing

Press the MENU button.

- You can also delete scenes by pressing the MENU button, selecting [DELETE] and then selecting [ALL] or [SELECT].
- In case of [ALL], the deletion may take time if there are many scenes.
- Do not turn off this unit while deleting.
- When you delete scenes, use a battery with sufficient battery power or use the AC adaptor.
- Do not open the card slot cover while deleting scenes recorded on an SD card. The deletion will stop.
- The locked scenes cannot be deleted.

Locking motion picture scenes

This is for preventing motion picture scenes from being deleted by mistake.

HDD SD

Motion picture scenes can be locked so that they are not deleted by mistake. (However, please be aware that if a medium is formatted, then all the data on the medium will be erased.)

- ◇ Rotate the mode dial to select .
- ◇ Select [HDD] or [SD CARD] in [MEDIA SELECT].

- 1 Press the MENU button, then select [PLAY SETUP] → [LOCK

SET] → [YES] and press the joystick.

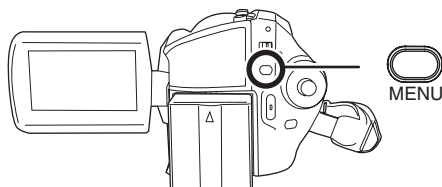

- 2 Select the scene to be protected, then press the joystick.



[] display appears and the selected scene is locked.

- Press the joystick again to release the lock setting.
- You can also select multiple scenes in succession.

To complete the settings

Press the MENU button.

Using playlists

What is a playlist?

You can create a playlist by gathering your favourites from the recorded scenes.

Since the playlist is not created by copying data, you will consume little of the capacity by making a playlist.

- If you create or delete playlists, the original scenes will not be modified. Editing scenes on a playlist will not affect the original scenes.

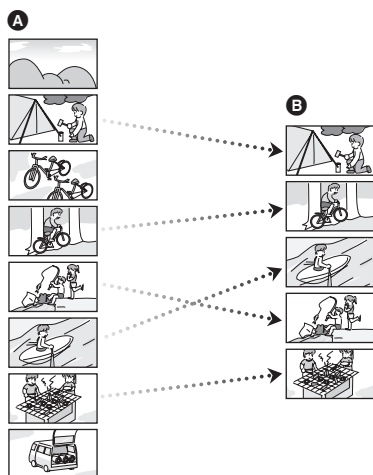

- A** Recorded scenes
- B** Playlist

- You can create a playlist on the HDD only. You cannot create a playlist on an SD card.
- The maximum number of items on the HDD
 - Playlists: 4
 - Playlist scenes: 99
- If original scenes are deleted, the portion of playlists created with these scenes is also deleted.

Creating a new playlist

HDD

- ◇ Rotate the mode dial to select .
- ◇ Select [HDD] in [MEDIA SELECT].

- 1** Press the MENU button, then select [PLAY SETUP] →

[PLAYLIST] → [CREATE] and press the joystick.

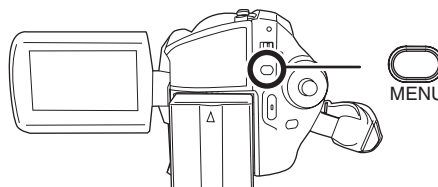

- 2** Select the scene to be added to the playlist, then press the joystick.



The selected scene is encircled by a red frame.

- When the joystick is pressed again, the selected scene will be cancelled.
- Up to 50 scenes can be set in succession.
- The scenes are registered in the playlist in the order that they were selected. After creating a playlist, the order of the scenes in it can be changed with the [MOVE] function. (→ 65)

- 3** Press the MENU button.

- 4** When the confirmation message appears, select [YES], then press the joystick.

The thumbnail view screen of the created playlist is displayed.

To add another scene to the same playlist

Select [ADD]. (→ 64)

To play back a playlist

Select the scene to start playback, then press the joystick.

Editing

Playing back a playlist

HDD

- ◇ Rotate the mode dial to select .
- ◇ Select [HDD] in [MEDIA SELECT].
- 1** Press the MENU button, then select [PLAY SETUP] → [PLAYLIST] → [VIEW LIST] and press the joystick.

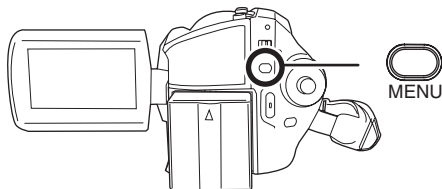

- 2** Select the playlist to be played back, then press the joystick.

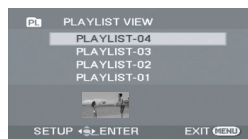

Scenes in the selected playlist are displayed as thumbnails.

- 3** Select the scene to start playback, then press the joystick.



To select a different playlist

Press the MENU button, then select [PLAYLIST VIEW] and press the joystick.

To return to showing the original scenes

Press the MENU button, then select [END] and press the joystick.

Editing a playlist

HDD

Editing scenes on a playlist will not affect the original scenes.

Adding scenes to playlist

- ◇ Select playlist playback mode. (→ 64, "Playing back a playlist", steps 1 and 2)
- 1** Press the MENU button, then select [EDIT] → [ADD] → [YES] and press the joystick.

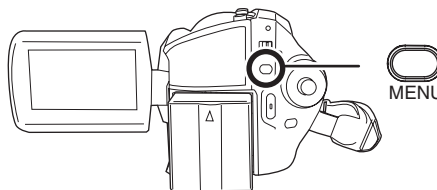

- 2** Select the scene to be added, then press the joystick.



The selected scene is encircled by a red frame.

- When the joystick is pressed again, the selected scene will be cancelled.
- Up to 50 scenes can be set in succession.
- The scenes are added to the playlist in the order that they were selected. The order of the scenes in the playlist can be changed by [MOVE] function. (→ 65)

- 3** Press the MENU button.

- 4** When the confirmation message appears, select [YES], then press the joystick.

The thumbnail view screen of the playlist that scenes were added to is displayed.

To continue adding scenes to the playlist

Repeat steps 1-4.

Moving scenes

The scenes in a playlist can be moved.

- ◇ Select playlist playback mode. (→ 64, “Playing back a playlist”, steps 1 and 2)

- 1 Press the MENU button, then select [EDIT] → [MOVE] → [YES] and press the joystick.

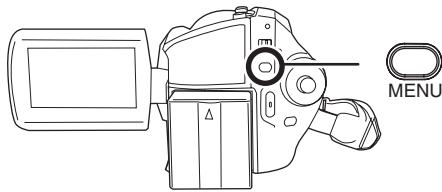

- 2 Select the scene to be moved, then press the joystick.



The selected scene is encircled by a red frame, and the position to insert is shown by a yellow bar.

- 3 Select the position to insert the scene, then press the joystick.

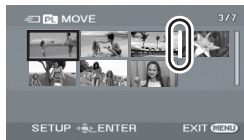

To continue moving other scenes in the playlist

Repeat steps 2-3.

To complete editing

Press the MENU button.

Deleting scenes

- Deleting scenes on a playlist will not affect the original scenes.

Deleting scenes one at a time

- ◇ Select playlist playback mode. (→ 64, “Playing back a playlist”, steps 1 and 2)

- 1 Press the  button during playback.

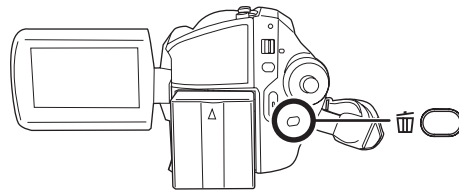

- 2 When the confirmation message appears, select [YES], then press the joystick.

Deleting multiple scenes from the thumbnail display

- ◇ Select playlist playback mode. (→ 64, “Playing back a playlist”, steps 1 and 2)

- 1 Press the  button in the thumbnail display.

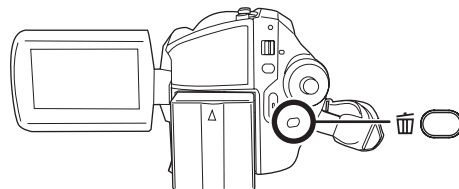

Editing

2 Select [ALL] or [SELECT] and press the joystick.

- When [ALL] is selected, the selected playlist will be erased. Proceed to step 5.

3 (Only when [SELECT] is selected in step 2) Select the scene to be deleted, then press the joystick.

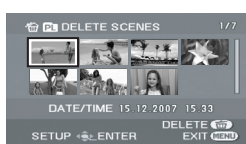

The selected scene is encircled by a red frame.

- When the joystick is pressed again, the selected scene will be cancelled.
- Up to 50 scenes can be set in succession.

4 (Only when [SELECT] is selected in step 2) Press the button.

5 When the confirmation message appears, select [YES], then press the joystick.

(Only when [SELECT] is selected in step 2)

To continue deleting other scenes

Repeat steps 3-5.

To cancel deleting halfway

Press the MENU button.

- Scenes are deleted from the last scene on the thumbnail display. The scenes that have already been deleted when the deletion is cancelled cannot be restored.

To complete editing

Press the MENU button.

- You can also delete scenes by pressing the MENU button, selecting [EDIT] → [DELETE] and then selecting [ALL] or [SELECT].
- Deleting scenes on a playlist will not increase the remaining capacity for recording.
- The playlist itself is deleted if you delete all the scenes in it.

- When a playlist is deleted, the number of each subsequent playlist decreases by one.

Editing still pictures

Deleting still picture files

This is for deleting still picture files.

HDD SD

The deleted files cannot be restored.

Deleting files one at a time

- ◇ Rotate the mode dial to select .
- ◇ Select [HDD] or [SD CARD] in [MEDIA SELECT].

1 Press the button during playback.

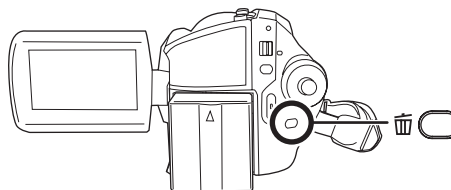

2 When the confirmation message appears, select [YES], then press the joystick.

Deleting multiple files from the thumbnail display

- ◇ Rotate the mode dial to select .
- ◇ Select [HDD] or [SD CARD] in [MEDIA SELECT].

1 Press the button in the thumbnail display.

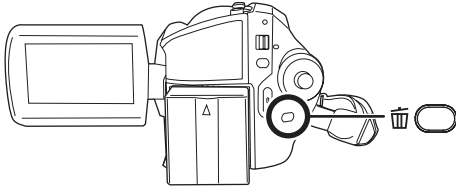

2 Select [ALL] or [SELECT] and press the joystick.

- When [ALL] is selected, all files on the medium except the locked files will be erased. Proceed to step 5.

3 (Only when [SELECT] is selected in step 2) Select the file to be deleted, then press the joystick.

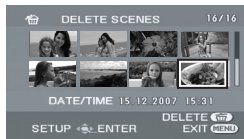

The selected file is encircled by a red frame.

- When the joystick is pressed again, the selected file will be cancelled.
- Up to 50 files can be set in succession.

4 (Only when [SELECT] is selected in step 2) Press the button.

5 When the confirmation message appears, select [YES], then press the joystick.

(Only when [SELECT] is selected in step 2)

To continue deleting other files

Repeat steps 3-5.

To cancel deleting halfway

Press the MENU button.

- Files are deleted from the last file on the thumbnail display. The files that have already

been deleted when the deletion is cancelled cannot be restored.

To complete editing

Press the MENU button.

■ Deleting still picture files recorded on an SD card by other products

A still picture file (other than JPEG) that cannot be played back on this unit may be erased.

- You can also delete files by pressing the MENU button, selecting [DELETE] and then selecting [ALL] or [SELECT].
- In case of [ALL], the deletion may take time if there are many files.
- Do not turn off this unit while deleting.
- When you delete files, use a battery with sufficient battery power or use the AC adaptor.
- Do not open the card slot cover while deleting files recorded on an SD card. The deletion will stop.
- If files conforming to DCF standard are deleted, all the data related to the files will be deleted.

Locking still picture files

This is for preventing still picture files from being deleted by mistake.

HDD SD

Still picture files can be locked so that they are not deleted by mistake. (However, please be aware that if a medium is formatted, then all the data on the medium will be erased.)

- ◇ Rotate the mode dial to select .
- ◇ Select [HDD] or [SD CARD] in [MEDIA SELECT].

Editing

- 1 Press the MENU button, then select [PHOTO SETUP] → [LOCK SET] → [YES] and press the joystick.

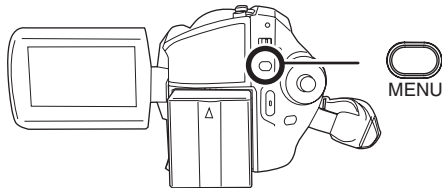

- 2 Select the file to be protected, then press the joystick.

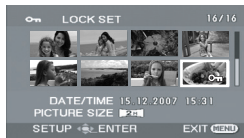

[On] display appears and the selected file is locked.

- Press the joystick again to release the lock setting.
- You can also select multiple files in succession.

To complete the settings

Press the MENU button.

DPOF setting

This is for writing the printing data on an SD card.

SD

You can write the data of the still pictures to be printed and the number of prints (DPOF data) onto the SD card.

- ◇ Rotate the mode dial to select .
- ◇ Select [SD CARD] in [MEDIA SELECT].

- 1 Press the MENU button, then select [PHOTO SETUP] →

- [DPOF SET] → [SET] and press the joystick.

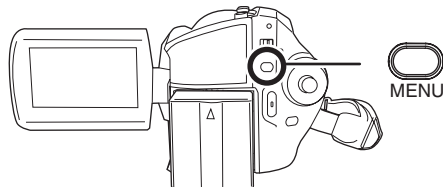

- 2 Select the file to be set, then press the joystick.



The number of prints set to be in DPOF is displayed.

- 3 Move the joystick up or down to select the number of prints, then press the joystick.

- You can select from 0 to 999. (The selected number of pictures can be printed with the printer supporting DPOF.)
- To cancel the setting, set the number of prints to [0].
- You can also select multiple files in succession.

To complete the settings

Press the MENU button.

To cancel all DPOF settings

Press the MENU button, then select [PHOTO SETUP] → [DPOF SET] → [CANCEL ALL] and press the joystick.

- When the confirmation message appears, select [YES], then press the joystick.

■ What is DPOF?

DPOF stands for Digital Print Order Format. This enables picture printing information to be written onto an SD card so that it can be used on a system supporting DPOF.

- The DPOF setting can be established for up to 999 files.
- DPOF setting made on other devices may not be recognised by this unit. Please perform the DPOF settings on this unit.
- You cannot add the recording date to pictures to be printed with the DPOF settings.

Copying still picture files



This is for copying still picture files from the HDD to an SD card or vice versa.

HDD SD

◇ Rotate the mode dial to select .

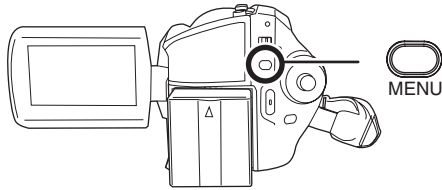
1 Press the **MENU** button, then select **[PHOTO SETUP]** → **[COPY]** → desired direction and press the joystick.



-  Copying from the HDD to an SD card
-  Copying from an SD card to the HDD

2 Select **[SELECT]** or **[ALL]** and press the joystick.

- When **[ALL]** is selected, all still picture files in the HDD or SD card will be copied. Proceed to step 5.

3 (Only when **[SELECT]** is selected in step 2)
Select the file to be copied, then press the joystick.



The selected file is encircled by a red frame.

- When the joystick is pressed again, the selected file will be cancelled.
- Up to 50 files can be set in succession.
- The files are copied in the order that they were selected.

4 (Only when **[SELECT]** is selected in step 2)
Press the MENU button.

5 When the confirmation message appears, select **[YES]**, then press the joystick.

Copying of the file starts.

(Only when **[SELECT]** is selected in step 2)

To continue copying other files

Repeat steps 3-5.

To cancel copying halfway

Press the **MENU** button.

To complete editing

Press the **MENU** button.

- The copied files are recorded after the still picture files in the copy destination. (The file names or the folder names will differ from the original file.)
- The lock and DPOF settings of the file cannot be copied.
- In case of **[ALL]**, the copy may take time if there are many files.
- Do not turn off this unit while copying.
- When you copy files, use a battery with sufficient battery power or use the AC adaptor.
- Do not open the card slot cover while copying. The copying will stop.

HDD and card management

HDD management

Formatting HDD

This is for initializing HDD.

HDD

Please be aware that if the HDD is formatted, then all the data recorded on the HDD will be erased. Store important data on a computer, etc.

- ◇ Rotate the mode dial to select .
- ◇ Select [HDD] in [MEDIA SELECT].

- 1 Press the MENU button, then select [SETUP] → [FORMAT HDD] → [YES] and press the joystick.

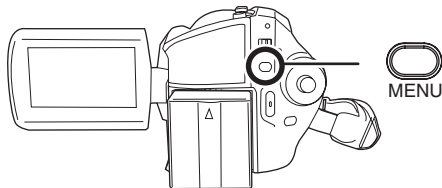

- 2 When the confirmation message appears, select [YES], then press the joystick.

- When formatting is complete, press the MENU button to exit the message screen.
- During formatting, do not turn this unit off.
- When you format the HDD, use a battery with sufficient battery power or the AC adaptor.
- During formatting, do not cause any vibrations or impacts to this unit.

Displaying HDD information

HDD

Information concerning the space used and remaining on the HDD is displayed.

- ◇ Rotate the mode dial to select .
- ◇ Select [HDD] in [MEDIA SELECT].

Press the MENU button, then select [SETUP] → [HDD STATUS] → [YES] and press the joystick.

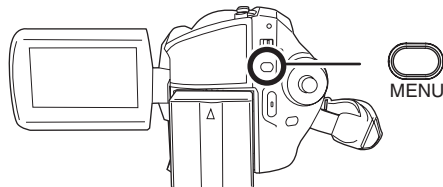

To exit the information screen

Press the MENU button.

- The 30 GB hard drive utilizes a portion of the storage space for formatting, file management and other purposes. 30 GB is 30,000,000,000 bytes. Usable capacity will be less.

Card management

Formatting an SD card

This is for initializing cards.

SD

Please be aware that if an SD card is formatted, then all the data recorded on the card will be erased. Store important data on a computer, etc.

- ◇ Select [SD CARD] in [MEDIA SELECT].

- 1 Press the MENU button, then select [SETUP] → [FORMAT CARD] → [YES] and press the joystick.

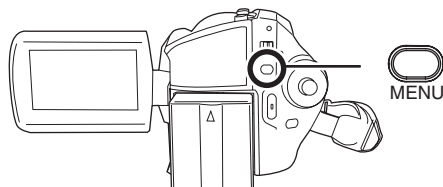

2 When the confirmation message appears, select [YES], then press the joystick.

- When formatting is complete, press the MENU button to exit the message screen.
- Use this unit to format SD cards. If an SD card is formatted on other products (such as a computer), the time spent for recording may become longer and you may not be able to use the SD card.
- Depending on the type of SD card being used, it may take time to format.
- During formatting, do not turn this unit off.
- When you format the SD card, use a battery with sufficient battery power or the AC adaptor.
- Do not open the card slot cover while formatting. The formatting will stop.

With other products

With a TV

Playback on TV

HDD SD

The motion pictures and still pictures recorded by this unit can be played back on a TV.

- Use the AC adaptor to free you from worrying about the battery running down.

1 Connect this unit and a TV.

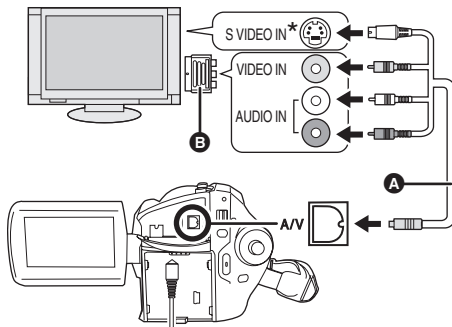

- A AV/S cable (supplied)
- Insert the plugs as far as they will go.
- If your TV is not equipped with AV Input Sockets, the 21-pin Adaptor B (purchase separately) is necessary. Consult your dealer.

* If the TV has an S Video terminal, also connect the S Video plug to it. This allows you to enjoy more beautiful pictures.

2 Turn on this unit, then rotate the mode dial to select or .

3 Press the MENU button, then select [MEDIA SELECT] → [HDD] or [SD CARD] to select the desired medium and press the joystick.

4 Change the input channel on the TV.

- The channel set will differ depending on the terminal to which the unit is connected.

5 Start playback on this unit.

The image and audio are output on the TV.

- If the image or audio from this unit is not output on the TV
 - Check that the plugs are inserted as far as they go.
 - Check the connected terminal.
 - Check the TV's input setting (input switch). (For more information, please read the operating instructions for the TV.)

- If you have a TV with an SD card slot, the motion pictures and still pictures recorded on an SD card may be played back on the TV. (Refer to the operating instructions of the TV for details about TV compatibility.)
- If the images are not displayed correctly on a wide-screen TV, adjust the aspect setting on the TV. (Refer to the operating instructions of the TV for details.) If the pictures are displayed squeezed horizontally on a regular TV (4:3), change the [TV ASPECT] setting on this unit. (→ below)



■ To watch images with a 16:9 aspect ratio on a regular TV (4:3)

When playing back motion pictures recorded with a 16:9 aspect ratio ([REC ASPECT] was set to [16:9]) or still pictures recorded with a 16:9 aspect ratio ([PICTURE SIZE] was set to [2M] (SDR-H250)/[0.2M] (SDR-H20)) on a TV with a 4:3 aspect ratio, the images may be squeezed horizontally. In this case, change the menu setting to play back the pictures in the original aspect ratio. (Depending on the TV setting, the pictures may not be displayed correctly. For more information, please read the operating instructions of your TV.)

Press the MENU button, then select [SETUP] → [TV ASPECT] → [4:3] and press the joystick.

With other products

Example of images with a 16:9 aspect ratio on a regular TV (4:3)

[TV ASPECT] setting	
[16:9]	[4:3]
	

- This function's default setting is [16:9].

■ To display the on-screen information on the TV (SDR-H250)

The information displayed on the screen (operation icon and time code, etc.) can be displayed on the TV.

Press the EXT DISPLAY button on the remote control.

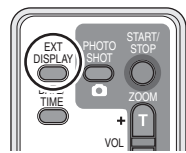

- Press the button again to erase the information.
- The screen on this unit will not change.

With a DVD recorder

Dubbing recordings onto a DVD recorder

SD

If you have a DVD recorder with an SD card slot, images recorded by this unit can be dubbed onto the hard disk or a DVD disc.

Refer to the operating instructions of your DVD recorder for information about whether or not it supports dubbing from an SD card.

- If your DVD recorder does not support dubbing from an SD card or you want to dub images on

the HDD of this unit, connect this unit and the DVD recorder with the AV/S cable (supplied) and then dub. (→ below)

Insert the SD card into the SD card slot on the DVD recorder, then dub the contents onto the hard disk or a disc.

- For details on how to dub the images, refer to the operating instructions of the DVD recorder.

If you dub images directly from the SD card or with the AV/S cable and then play them back on a wide-screen TV, they may be squeezed horizontally. In this case, refer to the operating instructions of the device you are dubbing to or read the operating instructions of the wide-screen TV and set the aspect setting to 16:9 (Full).

With a VCR

Dubbing images onto other video devices

HDD SD

You can dub images played back on this unit onto other video devices.

You can create a playlist by gathering the scenes on the HDD that you want to dub, then dub the scenes in this playlist only to other devices. (→ 63)

- Use the AC adaptor to free you from worrying about the battery running down.

With other products

1 Connect this unit and a video device.

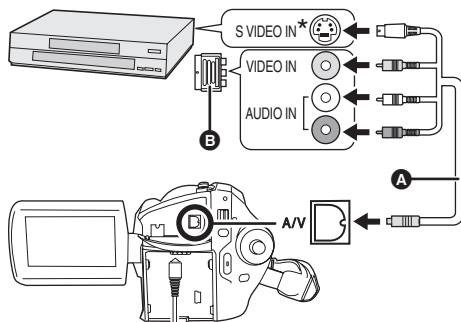

- A** AV/S cable (supplied)
- Insert the plugs as far as they will go.
 - If your recorder is not equipped with AV Input Sockets, the 21-pin Adaptor **B** (purchase separately) is necessary. Consult your dealer.

* If the video device has an S Video terminal, also connect the S Video plug into it. This allows you to enjoy more beautiful pictures.

2 Turn on this unit, then rotate the mode dial to select .

3 Press the MENU button, then select [MEDIA SELECT] → [HDD] or [SD CARD] to select the desired medium and press the joystick.

4 Change the input channel on the video device and TV.

- The channel set will differ depending on the terminal to which the unit is connected.

5 Start playback on this unit. Then start recording on the connected device.

- See the operating instructions of the video device for details.

To stop dubbing

Stop recording on the connected device. Then stop playback on this unit.

- If the date and time display and function indication are unnecessary, cancel them before dubbing. (SDR-H250) (→ 31, 73)

With a printer (PictBridge)

HDD SD

To print pictures by directly connecting this unit to the printer, use a printer compatible with PictBridge. (Read the operating instructions for the printer.)

◆ Connect this unit to the AC adaptor and turn on the unit.

1 Connect this unit and a printer.

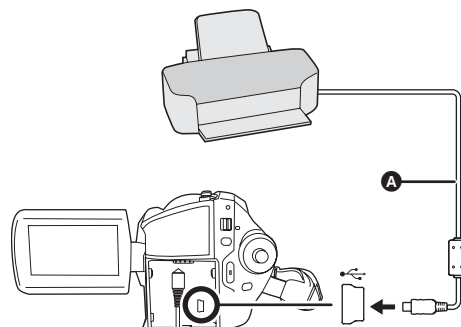

- A** USB cable (supplied)
- Insert the plugs as far as they will go.
 - Do not use any other USB cables except the supplied one. (Operation is not guaranteed with any other USB cables.)

The USB function selection screen will appear.

2 Select [PictBridge] → [HDD] or [SD CARD] and press the joystick.

The [**PictBridge**] indication appears on this unit's screen.

With other products

3 Select a file to be printed, then press the joystick.



The number of pictures set is displayed.

4 Move the joystick up or down to select the desired number of prints, then press the joystick.

- You can set up to 9 prints.
- To cancel the setting, set the number of prints to [0].
- Up to 8 files displayed on a page can be set in succession by repeating steps 3 and 4.

5 Press the MENU button to display the PictBridge menus.

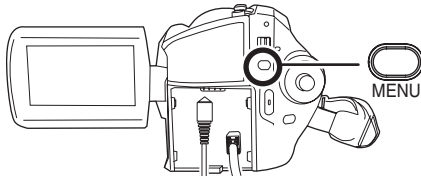

6 Select the date print setting on [DATE PRINT].

- If the printer is not capable of date printing, this setting is unavailable.

7 Select the paper size setting on [PAPER SIZE].

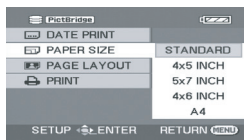

- [STANDARD]:** Size specific to the printer
- [4×5 INCH]:** L size
- [5×7 INCH]:** 2L size
- [4×6 INCH]:** Postcard size

[A4]: A4 size

- You cannot set paper sizes not supported on the printer.

8 Select the layout setting on [PAGE LAYOUT].

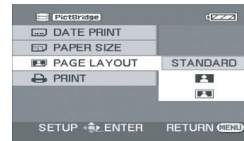

[STANDARD]: Layout specific to the printer

[]: No frame print

[]: Frame print

- You cannot set page layouts not supported on the printer.

9 Select [PRINT] → [YES] and press the joystick.

The pictures are printed.

- Exit PictBridge by disconnecting the USB cable after the pictures have been printed.

When you want to stop printing halfway

Move the joystick down.

A confirmation message appears. If [YES] is selected, the number of prints set is cancelled and the screen returns to step 3. If [NO] is selected, all the settings are kept and the screen returns to step 3.

- Avoid the following operations during printing. These operations disable proper printing.
 - Disconnecting the USB cable
 - Opening the card slot cover
 - Switching the mode dial
 - Turning off the power
- Check the settings for the paper size, quality of print, etc. on the printer.
- The sides of pictures recorded when **[2M]** (SDR-H250)/**[0.2M]** (SDR-H20) is set may be cut at printing. Check before printing. When using a printer with a trimming or borderless printing function, cancel this function before printing. (Refer to the operating instructions of the printer for details.)

With other products

- You may not be able to print still pictures recorded with other products.
- When the unit is connected directly to the printer, the DPOF settings cannot be used.
- Connect the printer directly to this unit. Do not use a USB hub.

With a computer

Before using with a computer

What you can do with a computer

When you have installed ImageMixer3 for Panasonic from the supplied CD-ROM and connected your computer to the unit, you can perform the operations described below.



- A** You can play back the images recorded by this unit on your computer or import the images to your computer.
- B** You can edit the motion pictures you have imported to your computer.
- C** You can import the images recorded by this unit to ImageMixer3 and then create original DVD-Video discs. (→ 87)
You can also write data in the DVD-VR (DVD Video Recording) format on DVD-RAM or DVD-RW discs.
- D** You can automatically write the images recorded on this unit's HDD to DVDs and create DVD-Video discs. (→ 84)
You can also make DVD-Video discs from the playlists you have created on the unit.
- E** You can exit ImageMixer3 for Panasonic.
- F** You can jump to the software support site.
- G** You can display the software help. (→ 82)

- For further details on these operations, refer to software help. (→ 82)

- We cannot guarantee proper operation of this unit if you use software other than that supplied.

With a computer**Operating environment**

- A CD-ROM drive is necessary to install the supplied software.
- When 2 or more USB devices are connected to a computer, or when devices are connected through USB hubs or by using extension cables, proper operation is not guaranteed.
- Use the supplied USB cable when connecting to the computer. (Operation is not guaranteed with any other USB cables.)

■ ImageMixer3 for Panasonic

Hardware	IBM PC/AT compatible personal computer
OS	Microsoft Windows 2000 Professional Service Pack 3 or Service Pack 4 Microsoft Windows XP Home Edition Microsoft Windows XP Professional
CPU	Intel Pentium III 800 MHz or higher, Pentium 4, Celeron, or AMD Athlon XP/ Duron of equivalent performance (Intel Pentium 4 1.7 GHz or higher recommended)
RAM	Windows 2000 Professional: 128 MB or more (256 MB or more recommended) Windows XP Home Edition/Professional: 256 MB or more (512 MB or more recommended)
Display	High Colour (16 bit) or more Desktop resolution of 1024×768 pixels or more Graphic accelerator supporting DirectX 9.0c or later and with 4 MB or more of VRAM
Free hard disk space	For installing the application: 300 MB or more When creating discs (DVD-Video): 14 GB or more for the work folder (28 GB or more in the case of dual layer discs)
Necessary software	DirectX 9.0c
Sound	Sound Blaster or equivalent
Disc drive	Disc drive which has been manufactured and marketed since 1997 and which is capable of creating DVDs
Interface	Hi-Speed USB (USB 2.0) — A type
Languages supported	English, French, Spanish, German, Italian and Simplified Chinese

- You cannot use a Panasonic DVD Video Camera as a device for writing.
- Even if the system requirements mentioned in these operating instructions are fulfilled, some computers cannot be used.
- Operation on an OS other than the one pre-installed is not guaranteed.
- DirectX 9.0c will be installed automatically during installation of the supplied software.
- Operation cannot be guaranteed on all DVD drives.
- DVD discs authored with this software are not guaranteed to play in all DVD players.
- This software is not compatible with a multi-CPU environment.
- Operation on Microsoft Windows XP Media Center Edition, Tablet PC Edition and 64-bit operating system is not guaranteed.

With a computer

- Depending upon the environment of your computer, if it does not support Hi-Speed USB (USB 2.0), for example, frame dropout may occur, the audio may be intermittent, or the software may run slowly when you play back recorded images.
- Set the display resolution to 1024×768 (16 bits colour) or higher.
Select [start] → ([Settings] →) [Control Panel] → ([Appearance and Themes] →) [Display] and select [Settings] tab, and then adjust [Screen resolution] and [Color quality].
- This unit's USB terminal is read only. It cannot be used to write data to the unit from the computer.

■ Using Built-in SD Drive

Hardware	IBM PC/AT compatible personal computer
OS	Microsoft Windows 2000 Professional Microsoft Windows XP Home Edition Microsoft Windows XP Professional
CPU	Intel Pentium II 300 MHz or higher
RAM	32 MB or more (64 MB or more recommended)
Interface	USB 1.1 or later — A type

- The USB equipment operates with the driver installed as standard in the OS.

■ Usable discs

The table below lists the types of DVD discs which can be used by the supplied software.

Disc type	Function	
	For creating discs (DVD-Video format)/ DVD COPY	For creating discs (DVD-VR format)
DVD-R/+R	●	—
DVD-R DL /+R DL	●	—
DVD-RW/+RW	●	● (DVD-RW only)
DVD-RAM	—	●*

●: Can be used.

—: Cannot be used.

* If a DVD-RAM driver is installed, it may not be possible to use DVD-RAM discs.

- Depending on your computer, it may not be possible to use some of the DVD discs listed in the table above.
- Refer to the operating instructions of your computer for details about the DVD discs which can be written to on the computer.
- To playback a DVD disc created using ImageMixer3, the player must support playback of that DVD disc. (Refer to the operating instructions of the player.)
- Use discs made by a trustworthy manufacturer. It may not be possible to record images properly if you use low-quality discs.

With a computer

For technical inquiries about this software, contact the PIXELA Customer Support Center in your region.

UK, Germany, France and Spain: (Toll-Free) +800-1532-4865

Other Countries: +44-1489-564-764

Languages supported: English, German, French, Spanish

Website: <http://www.pixela.co.jp/oem/panasonic/e/index.html> (This website is in English only.)

With a computer

Installation

When installing the software, log on to your computer as the Administrator or with a user name with equivalent authorization. (If you do not have authorization to do this, consult your manager.)

- Before starting the installation, close any other software applications which are running.
- Do not perform any other operations on your computer while the software is being installed.

Installing ImageMixer3 for Panasonic

1 Insert the CD-ROM into the computer.

The setup language selection screen appears.

- If the setup language selection screen does not appear, double-click the CD-ROM drive icon in [My Computer].

2 Select the language for the installation and click [Next].

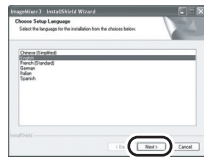

3 Click [Next].

- The software may not run properly if you cancel the installation at any point (e.g. by clicking [Cancel]).

4 Read carefully through the End User License Agreement, check

[I accept the terms of the license agreement], and click [Next].



- You cannot install the application if you check [I do not accept the terms of the license agreement].

5 Select where the application is to be installed, and click [Next].

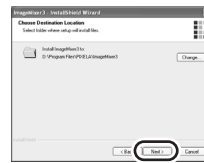

6 Select [PAL] for the TV system, click [Next].



7 Click [Install] to start the installation process.



8 Click [Finish].

With a computer

The computer must be rebooted for the application to work.

- Depending on the operating environment, you may be required to install DirectX 9.0c. If so, click [Yes], and install it.
If you install the software in a computer that is not compatible with DirectX 9.0c, the computer may not work properly. If you are unsure whether or not your computer is compatible, contact the maker of your computer.

Reading the software help

For details on how to use the software, read the help.

- Help uses JavaScript. To view its contents, activate JavaScript using the browser settings.

Click the  icon in the ImageMixer3 launcher screen.

- You can also select [Help] → [ImageMixer3 Help] from the menu bar to display the help.

Software uninstallation

Follow the steps below to uninstall the software if it is no longer required.

- 1 Select [start] → ([Settings] →) [Control Panel] → [Add or Remove Programs (Applications)].

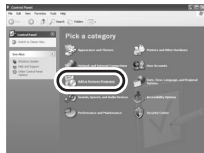

- 2 Select [ImageMixer3], then click [Remove].



- Depending on the operating environment, the name of the buttons may differ. (Example: [Change/Remove])
- Proceed with the uninstallation by following the on-screen instructions.
- After uninstalling the software, be sure to reboot the computer.

Connection and recognition

Connection and recognition procedures

After the software is installed, the unit must be connected to the computer and be correctly recognised by the computer.

- Connect after installing the software.
- If the supplied CD-ROM is inserted in the computer, remove it. (If the installer setup is running, wait until it finishes, then remove the CD-ROM.)
- If the recognition procedure is not accomplished properly, operation will not be possible after connecting the unit to the computer.
- If the unit fails to operate normally, it may mean that you have not conducted the installation or recognition procedure properly.

◇ Connect this unit to the AC adaptor and turn on the unit.

With a computer

1 Connect this unit and a computer.

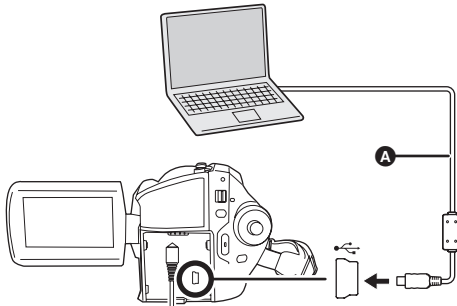

A USB cable (supplied)

- Insert the plugs as far as they will go. The unit and computer will not operate properly if the plugs are not inserted fully.
- Do not use any other USB cables except the supplied one. (Operation is not guaranteed with any other USB cables.)

The USB function selection screen will appear.

2 Select [PC CONNECT] → [HDD] or [SD CARD] and press the joystick.

This unit is automatically recognised by the computer.

- **When the unit is connected to a computer, its power cannot be turned off.**
In this case, disconnect the USB cable (→ 84).
- When a computer is accessing the HDD or card in this unit, the ACCESS/PC lamp or card access lamp lights. (↻ or ↵ appears on the LCD monitor.) Do not disconnect the USB cable or AC adaptor while the HDD or card is being accessed as it may damage the data.
- The HDD and card cannot be accessed simultaneously.
- It may be necessary to reboot the computer after connecting this unit to it for the first time.

About the computer display

When the unit is connected to a computer, it is recognised as an external drive.

- This unit supports only the readout of data using the computer. The computer cannot write data to the unit, or erase data from the unit.
- Depending on the operating environment of the computer, the shape of the drive icon and the drive name (Example: E:) will differ.

■ Drive icons

The icon is displayed in [My Computer].

When accessing the HDD

- Windows XP:

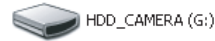

- Windows 2000:

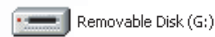

When accessing the card

- Windows XP:



- Windows 2000:

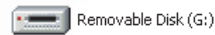

■ Example folder structure

HDD

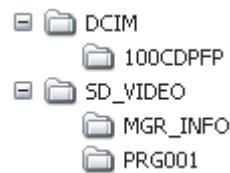

With a computer

SD card

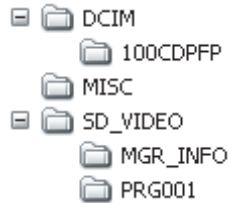

- SD-Video format motion pictures are stored in the [PRG***] folder. ("***" denotes base-16 (hexadecimal) characters from 001 to FFF.)
- Up to 99 files can be recorded in the [PRG***] folder.
- JPEG format still pictures (IMGA0001.JPG etc.) are stored in the [100CDPFP] folder. These can be opened with picture playback software that supports JPEG pictures.
- Up to 999 files can be recorded in the [100CDPFP] or other such folder.
- The DPOF setting files are recorded in the [MISC] folder (SD card only).

- Do not use the computer to delete the SD card's folders. Otherwise, it may no longer be possible for this unit to read the SD card.
- Always use this unit to format SD cards.
- When data not supported by this unit has been recorded on a computer, it will not be recognised by this unit.
- You can use Windows Explorer to copy still picture files to a computer.

To disconnect USB cable safely

1 Double click the icon in task tray.

Hardware disconnect dialogue appears.



- Depending on your computer's settings, this icon may not be displayed.

2 Select [USB Mass Storage Device] and click [Stop].

3 Verify [MATSHITA HDD Cam-HDD USB Device] or [MATSHITA HDD

Cam USB Device] is selected and click [OK].

Click [Close], and you can safely disconnect the cable.

- If you disconnect the USB cable while the ACCESS/PC lamp or card access lamp is on or while  or  appears on the LCD monitor, it may damage the data.

Using the recorded images on a computer

DVD COPY function

When ImageMixer3 is used, you can easily create DVD-Video discs by pressing the unit's DVD COPY button.

Among the images recorded on the unit's HDD, those scenes which have not yet been copied to the DVD using this function will be automatically identified and written onto the DVD.

DVD-Video discs created using this function can be played back on a DVD player or other device.

- ◆ Connect this unit to the AC adaptor and turn on the unit.

1 Rotate the mode dial to select or .

2 Press the DVD COPY button.

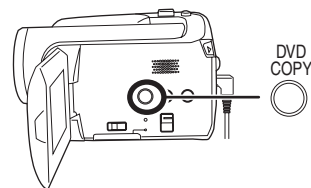

- "PLEASE CONNECT USB CABLE." appears on this unit's LCD monitor. Connect the USB cable while this message appears. Press the DVD COPY button again if the message disappears.

With a computer

3 Connect this unit and a computer.

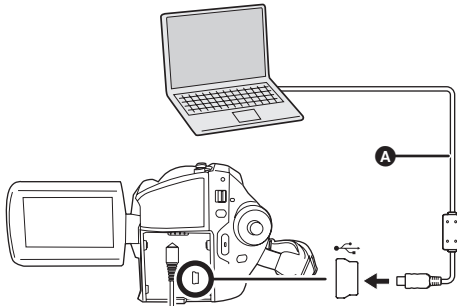

A USB cable (supplied)

- Insert the plugs as far as they will go. The unit and computer will not operate properly if the plugs are not inserted fully.
- Do not use any other USB cables except the supplied one. (Operation is not guaranteed with any other USB cables.)

The DVD COPY preparation screen appears.



4 Insert a DVD disc into the DVD drive.

- It is recommended that you use a brand-new DVD disc.



Data writing on the disc starts.

- When writing to the disc is finished, the disc will be ejected from the drive.
- Depending on the amount of data, writing to the disc may take time.
- Do not subject the unit to vibration while data is being written. Otherwise, the writing process may be aborted.

- If all of the data cannot be written onto one DVD disc, it will be written onto a second (or third, etc.) disc. When the writing on the first disc is completed, a message will appear so insert another disc of the same type as the first.

- Still pictures are converted to motion pictures and written onto the DVD disc.
- Check on the DVD player or other player device whether the DVD-Video disc you have created can be played properly. If the disc cannot be played properly, create the DVD-Video disc by following the steps in "Creating DVD-Video discs with the selected images". (→ 87)
- The images cannot be stored in the computer.
- The images recorded on the DVD-Video disc you have created cannot be edited by the computer. To edit them, import the images to the computer.
- When playing a DVD-Video disc you have created, there will be a pause of several seconds between scenes.
- The images recorded on SD cards cannot be copied onto discs using the DVD COPY function. Import the images to your computer and then write them on the DVD disc. (→ 87)
- The image saving history is stored for each computer user account. For this reason, even if images have already been copied onto a DVD disc, they will be copied onto the DVD disc again when a different user account is used.
- You cannot use a Panasonic DVD Video Camera as a device for writing.

Playing back and importing images

- ◇ Connect this unit to the AC adaptor and turn on the unit.

With a computer

1 Connect this unit and a computer.

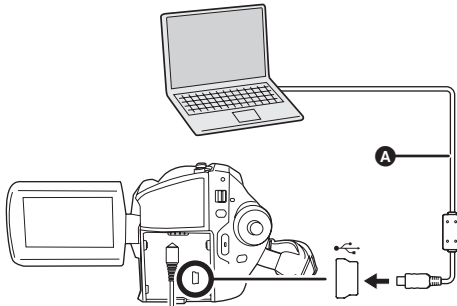

- A** USB cable (supplied)
- Insert the plugs as far as they will go. The unit and computer will not operate properly if the plugs are not inserted fully.
 - Do not use any other USB cables except the supplied one. (Operation is not guaranteed with any other USB cables.)

The USB function selection screen will appear.

2 Select [PC CONNECT] → [HDD] or [SD CARD] and press the joystick.

This unit will be automatically recognised by the computer and ImageMixer3 will start automatically.

If ImageMixer3 fails to start automatically, take the following steps to start it.

Select [start] → [All Programs (Programs)] → [PIXELA] → [ImageMixer3 for Panasonic] → [ImageMixer3 for Panasonic].

3 Click [Playback/Import Video].



The browser screen is displayed.

4 Select [SDR-H250]/[SDR-H20] (HDD) or [Removable Disk] (SD card) in [Source].



The contents recorded on the HDD or SD card are displayed.

- Motion pictures
- Still pictures

5 (To play back the scenes) Click the desired scene and click [Playback] (A).

(To import images to your computer)

Click the desired scene and click [Import] (B).



- Imported images can be checked by clicking [Library].
- Imported images can be edited using ImageMixer3. For details, refer to software help. (→ 82)
- You can change the location where imported images will be saved by selecting from the menu bar [Settings] → [Preferences] → [Library destination settings:].

With a computer

Creating DVD-Video discs with the selected images

Use ImageMixer3 to import the images recorded by this unit that you want to write to a DVD disc and then create a DVD-Video.

DVD-Video discs created using this function can be played back on a DVD player or other device.

- You can edit motion pictures or add your favourite menus. For details, refer to software help. (→ 82)

◇ **Connect this unit to the AC adaptor and turn on the unit.**

1 Connect this unit and a computer.

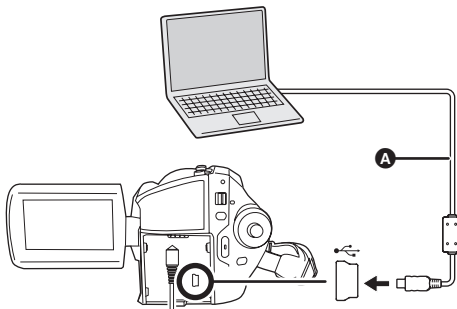

- A** USB cable (supplied)
- Insert the plugs as far as they will go. The unit and computer will not operate properly if the plugs are not inserted fully.
 - Do not use any other USB cables except the supplied one. (Operation is not guaranteed with any other USB cables.)

The USB function selection screen will appear.

2 Select [PC CONNECT] → [HDD] or [SD CARD] and press the joystick.

This unit will be automatically recognised by the computer and ImageMixer3 will start automatically.

If ImageMixer3 fails to start automatically, take the following steps to start it.

Select [start] → [All Programs (Programs)] → [PIXELA] → [ImageMixer3 for Panasonic] → [ImageMixer3 for Panasonic].

3 Click [Create DVD-Video].



4 Click [Create New DVD].



5 Select the appropriate project settings and click [OK].

6 Select [SDR-H250]/[SDR-H20] (HDD) or [Removable Disk] (SD card) and click [Import].



The contents recorded on the HDD or SD card are displayed.

7 Click the desired folder (A), select the scene (B) and add it to the list (C) by drag and drop.

With a computer

- The folder itself can also be added to the list.

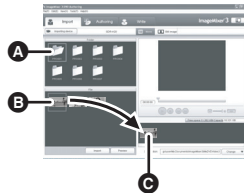

■ To import still pictures

- 1 Click [Still image] (D).
 - 2 Click the desired folder (E), select the file (F) and add it to the list (G) by drag and drop.
- The folder itself can also be added to the list.

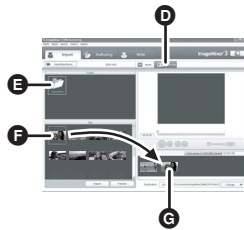

- Still pictures are converted to motion pictures and written onto the DVD disc.

8 Click [Authoring] tab.

9 Click [Theme] and click the desired DVD menu screen.



10 Click [Source], and add the scene to the menu screen by drag and drop.

- You cannot add a still picture to the menu if it is not a file folder. For details, refer to software help. (→ 82)

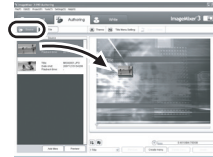

11 Insert a DVD disc into the DVD drive and click [Write] tab.

- It is recommended that you use a brand-new DVD disc.

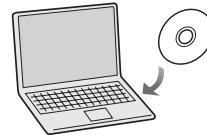

12 Select the appropriate write settings and click [Write].



13 Check the write settings and click [OK].

Writing to the disc starts.

- When writing to the disc is finished, the disc will be ejected from the drive.
- Depending on the amount of data, writing to the disc may take time.

- You cannot use a Panasonic DVD Video Camera as a device for writing.

Menus

Menu list

Motion picture recording menus

BASIC	
SCN SCENE MODE	OFF
GUIDE LINES	OFF
REC MODE	STD
REC ASPECT	16:9
CLOCK SET	NO
SETUP ENTER	
EXIT	

■ [BASIC]

- [SCENE MODE] (→ 50)
- [GUIDE LINES] (→ 48)
- [REC MODE] (→ 38)
- [REC ASPECT] (→ 49)
- [CLOCK SET] (→ 31)

■ [ADVANCED]

- [D.ZOOM] (→ 43)
- [O.I.S.] (→ 49)
- [FADE COLOUR] (→ 46)
- [WIND CUT] (→ 49)
- [ZOOM MIC] (→ 44)

■ [MEDIA SELECT]

- [HDD] (→ 36)
- [SD CARD] (→ 36)

■ [SETUP]

- [DISPLAY] (→ 90)
- [DATE/TIME] (→ 31)
- [DATE FORMAT] (→ 31)
- [FORMAT CARD]^{*2} (→ 70)
- [POWER SAVE] (→ 90)
- [AGS] (SDR-H250) (→ 35)
- [BEEP SOUND] (→ 91)
- [LCD SET] (→ 32)
- [INITIAL SET] (→ 91)
- [ILLUMINATION] (→ 91)
- [DEMO MODE] (→ 91)

■ [LANGUAGE] (→ 29)

Still picture recording menus

BASIC	
SCN SCENE MODE	OFF
GUIDE LINES	OFF
PICTURE SIZE	[2:3]
PICT. QUALITY	±
CLOCK SET	NO
SETUP ENTER	
EXIT	

■ [BASIC]

- [SCENE MODE] (→ 50)
- [GUIDE LINES] (→ 48)
- [PICTURE SIZE] (→ 42)
- [PICT. QUALITY] (→ 42)
- [CLOCK SET] (→ 31)

■ [ADVANCED]

- [O.I.S.] (→ 49)
- [SHTR EFFECT] (→ 41)

■ [MEDIA SELECT]

- [HDD] (→ 39)
- [SD CARD] (→ 39)

■ [SETUP]

- [DISPLAY] (→ 90)
- [DATE/TIME] (→ 31)
- [DATE FORMAT] (→ 31)
- [FORMAT CARD]^{*2} (→ 70)
- [POWER SAVE] (→ 90)
- [BEEP SOUND] (→ 91)
- [LCD SET] (→ 32)
- [INITIAL SET] (→ 91)
- [ILLUMINATION] (→ 91)
- [DEMO MODE] (→ 91)

■ [LANGUAGE] (→ 29)

Motion picture playback menus

PLAY SETUP	
PLAY MODE	VIEW ALL
RESUME PLAY	OFF
LOCK SET	NO
PLAYLIST	CREATE
SETUP ENTER	
EXIT	

■ [DELETE]

- [ALL] (→ 61)
- [SELECT] (→ 61)

■ [PLAY SETUP]

- [PLAY MODE] (→ 57)

Others

[RESUME PLAY] (→ 58)
 [LOCK SET] (→ 62)
 [PLAYLIST]^{*1} (→ 63, 64)

■ [MEDIA SELECT]
 [HDD] (→ 55)
 [SD CARD] (→ 55)

■ [SETUP]
 [DISPLAY] (→ 90)
 [DATE/TIME] (→ 31)
 [DATE FORMAT] (→ 31)
 [FORMAT CARD]^{*2} (→ 70)
 [POWER SAVE] (→ 90)
 [BEEP SOUND] (→ 91)
 [LCD SET] (→ 32)
 [TV ASPECT] (→ 72)
 [ILLUMINATION] (→ 91)
 [FORMAT HDD]^{*1} (→ 70)
 [HDD STATUS]^{*1} (→ 70)

■ [LANGUAGE] (→ 29)

(In playlist playback mode)

■ [EDIT]
 [ADD] (→ 64)
 [MOVE] (→ 65)
 [DELETE] (→ 65)
 ■ [CREATE] (→ 63)
 ■ [PLAYLIST VIEW] (→ 64)
 ■ [END] (→ 64)

Still picture playback menus



■ [DELETE]
 [ALL] (→ 66)
 [SELECT] (→ 66)

■ [PHOTO SETUP]
 [LOCK SET] (→ 67)
 [DPOF SET]^{*2} (→ 68)
 [COPY] (→ 69)

■ [MEDIA SELECT]
 [HDD] (→ 59)

[SD CARD] (→ 59)

■ [SETUP]
 [DISPLAY] (→ 90)
 [DATE/TIME] (→ 31)
 [DATE FORMAT] (→ 31)
 [FORMAT CARD]^{*2} (→ 70)
 [POWER SAVE] (→ 90)
 [BEEP SOUND] (→ 91)
 [LCD SET] (→ 32)
 [TV ASPECT] (→ 72)
 [ILLUMINATION] (→ 91)

■ [LANGUAGE] (→ 29)

*1 Only when [MEDIA SELECT] is set to [HDD]

*2 Only when [MEDIA SELECT] is set to [SD CARD]

Other menus

■ [DISPLAY]
 ● [OFF] ● [ON]

The screen indications are selected as shown in the illustration below.

[OFF]

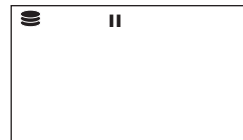

[ON]

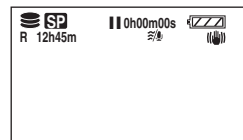

■ [POWER SAVE]
 ● [OFF] ● [5 MINUTES]

[OFF]
 The power saving function is not activated.

[5 MINUTES]
 When about 5 minutes have passed without any operation, this unit automatically turns off to prevent the battery from running down. When you use this unit, turn it on again.

Others

- In the following cases, the unit may not turn off even when you set this to [5 MINUTES].
 - When using the AC adaptor
 - When connecting the unit to a computer or printer via the USB cable

■ [BEEP SOUND]

- [OFF] ● [ON]

This allows operations such as starting and ending recording to be signaled by a beep. When [OFF] is set, no beep is heard when an operation such as recording is started or ended.

1 Beep

When you start recording
When you turn on the power
When this unit is recognised by the computer or the printer, etc.

2 Beeps

When you pause recording
When you turn off the power

2 Beeps for 4 times

When an error occurs e.g. recording not starting. Check the sentence displayed on the screen. (→ 94)

■ [INITIAL SET]

- [YES] ● [NO]

When there is a menu that cannot be selected due another function or mode being activated, set to [YES] for changing the menu settings back to the initial shipping condition. (The language setting cannot be changed back to the initial shipping condition.)

■ [ILLUMINATION]

- [OFF] ● [ON]

This allows operations to be signaled by the lighting of the illumination LED on the top of the unit.

1 Flash

When you turn on the power
(When in a recording mode: in orange)
(When in a playback mode: in blue)

2 Flashes

When you switch the mode to a recording mode (in orange)
When you switch the mode to a playback mode (in blue)

Lights



During motion picture recording (in orange)
During playback and while connected to a computer, a printer, etc. (in blue)

Flashes continuously

While formatting, copying, deleting, etc. (in orange)

■ [DEMO MODE]

- [OFF] ● [ON]

This item is used to start the unit demonstration. (Only when using the AC adaptor and the mode dial is at the  or  position)



If you set this to [ON] without inserting an SD card, this unit is automatically set to the demonstration mode for introducing its functions. If any button is pressed or operated, the demonstration mode is cancelled. If no operations take place for approx. 10 minutes, the demonstration mode automatically starts. To terminate the demonstration mode, insert an SD card, or set this to [OFF]. For normal use, set this function to [OFF].

Others

Indications

Indications

Media indications

	HDD is selected
	SD card is selected



Recording indications

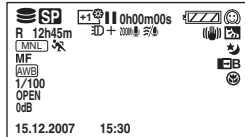



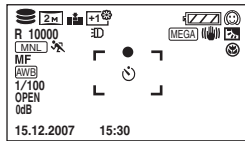









Motion picture recording



Still picture recording



	Remaining battery power
R 0h00m	Remaining time for recording
0h00m00s	Elapsed recording time
15.12.2007 15:30	Date/time indication
●/II (Red)	Recording/writing to the medium
II (Green)	Recording pause
16:9	Wide mode
AUTO	Auto mode
MNL	Manual mode
MF	Manual focus
2×	Zoom magnification indication
	Back light compensation mode
	Image stabilizer
1/100	Shutter speed
OPEN, F2.0	F number
0dB	Gain value

	Soft skin mode
	Tele macro (SDR-H250)
W, B	Fade (White), Fade (Black)
	Colour night view function
ID	Video light (SDR-H250)
ZOOM	Zoom microphone
	Wind noise reduction
+1 / +2 / -1 / -2	Power LCD plus function
XP, SD, LP	Motion picture recording mode
	Sports mode
	Portrait mode
	Low light mode
	Spotlight mode
	Surf & snow mode
AWB	Auto white balance
	Indoor mode (recording under incandescent lamp)
	Outdoor mode
	Manual adjustment mode
○ (White) ● (Green)	Focus indication (SDR-H250)
	Self-Timer recording
MEGA	MEGA OIS (SDR-H250)
SDR-H250:	Number of recording pixels for still pictures
3.1m	2048×1512
2m	1920×1080
1m	1280×960
0.3m	640×480
SDR-H20:	
0.3m	640×480
0.2m	640×360
□ (White) □ (Green) → (Red)	Card can be recorded to Recognising the card Recording/accessing the card
	Still picture quality
R 10000	Remaining number of still pictures

■ Playback indications

Motion picture playback



Still picture playback



	Playback
	Pause
	Fast forward/rewind
	Last/first scene paused
	Skip playback
	Slow motion playback
	Frame-by-frame playback
0h00m00s	Motion picture playback time
	Play mode All scenes on the media displayed
	Scenes recorded on the selected date displayed
	Scenes in the selected playlist displayed
No.10	Scene number
	Volume adjustment
R	Resume playback
100-0001	Still picture folder/file number display
	When a printer compatible with PictBridge is connected
	Accessing the HDD or a card (When connected to a computer)
	DPOF already set (to more than 1)

	Locked motion pictures and still pictures
SDR-H250:	Number of recording pixels for still pictures
	2048×1512
	1920×1080
	1280×960
	640×480
SDR-H20:	
	640×480
	640×360
The picture size is not displayed for still pictures recorded with other products that have different picture sizes from the sizes shown above.	

■ Confirmatory indications

-- (Time display)	The built-in battery is low. (→ 32)
	The warning/alarm indication appears when LCD monitor is rotated towards the lens side. Return the direction of the LCD monitor to normal position and check the warning/alarm indication.
	No SD card is inserted/ unusable card.
	The HDD cannot be accessed as the drop detection function has detected that the unit was dropped. If it detects that the unit is being continuously dropped, recording may stop.

Others

Messages

NO DATA.	There are no images recorded on the media.
CAN NOT RECORD. HDD IS FULL.	The HDD is full or the number of scenes has reached the maximum limit so no further data can be recorded. Back up the data on the HDD to a computer, etc. and then delete unnecessary scenes or format the HDD. (→ 61, 66, 70)
CAN NOT RECORD. THE NUMBER OF SCENES HAS EXCEEDED THE MAXIMUM LIMIT. BACKUP HDD THEN FORMAT.	
RECOMMEND DATA BACK UP PERIODICALLY.	The capacity of the HDD is limited. We recommend backing up important recorded data periodically to a computer etc. to protect it. This message does not indicate that there is a problem with this unit.
HDD BACKUP RECOMMENDED.	There is a possible problem with the HDD. Immediately copy the data on the HDD to a computer etc. and then have the unit repaired.
THIS CARD CANNOT RECORD IN VIDEO MODE.	An 8 MB or 16 MB SD card has been inserted in video recording mode.
CHECK CARD.	This card is not compatible or it cannot be recognised by the unit.
CARD LOCKED.	The write protection switch on the SD card is set to LOCK. (→ 17)
CARD FULL.	The SD card is full or the number of scenes has reached the maximum limit so no further data can be recorded. Delete unnecessary scenes (→ 61, 66) or insert a new SD card.
SCENE NUMBER IS FULL.	
CARD DOOR OPENED.	The card slot cover is open. Close it.
ERROR OCCURRED. RECORDING IS STOPPED.	<ul style="list-style-type: none"> • When using an SD card that can be used for motion picture recording (→ 17) <p>When this message appears, it is recommended that you format the SD card being used. (→ 70) When an SD card is formatted, all the data recorded on it will be deleted. Back up the data on the SD card to a computer, etc. before formatting the SD card.</p> <ul style="list-style-type: none"> • When using any other card <p>Use a Panasonic SD card or another SD card which can be used to record motion pictures. (→ 17)</p>
CANNOT RECORD IN AGS MODE.	The AGS function is activated. (→ 35)

Others

CHANGE TO MANUAL MODE.	
CANCEL NIGHT VIEW MODE.	You are attempting to use a function that cannot be used simultaneously.
TURN OFF THE VIDEO LIGHT.	
OPERATION FAILED. EXCESSIVE SHOCK DETECTED. PLEASE TRY AGAIN AFTER A WHILE.	The unit has detected that it is being dropped so the operation has stopped.
INTERNAL TEMPERATURE TOO HIGH. PLEASE TURN UNIT OFF AND WAIT A WHILE.	The internal temperature of this unit is high so it cannot be operated. Turn off the power, wait until the temperature falls and then turn on the power again.
OPERATION STOPPED. TEMPERATURE TOO LOW.	The internal temperature of this unit is extremely low so it cannot be operated. If "Please Wait." appears after this message, wait a while without turning the unit off. It may take time until the unit can be used.
PUSH THE RESET SWITCH.	An irregularity in the unit has been detected. Remove the SD card then press the RESET button to restart the unit. (→ 102)
DISCONNECT USB CABLE.	The unit cannot correctly establish the connection to the computer or printer. Disconnect and reconnect the USB cable and then select the desired USB function again.
CANNOT OPERATE WHILE USB CONNECTED.	The unit's power cannot be turned off when the unit is connected to the computer.

About recovery

It is possible that the system cannot complete writing of a file normally when, for example, power is turned off for some reason during recording or editing.

If faulty management information is found when the HDD or a card is accessed, one of the following messages may appear. Be sure to follow the messages. (Repairing may take time depending on the error.)

HDD ERROR DETECTED. NOW REPAIRING DATA.
CARD ERROR DETECTED. NOW REPAIRING DATA.

- When you repair the data, use a battery with sufficient battery power or the AC adaptor. Even if the power is turned off without repairing the data, you can repair the data when you turn the power on again.
- Depending on the condition of the data, it may not be possible to completely repair the data.
- Do not repair a card that has been recorded on another device. This may cause the loss of data or the card.

Others

Functions that cannot be used simultaneously

Some functions in this unit are disabled or cannot be selected due to the unit's specifications. The table below shows examples of functions restricted by various conditions.

Functions	Conditions which disable the functions
Digital zoom	<ul style="list-style-type: none"> • In picture recording mode
Fade	
Colour night view	<ul style="list-style-type: none"> • While recording (Cannot set or cancel) • In picture recording mode • When the video light is on (gain up mode)
Backlight compensation	<ul style="list-style-type: none"> • When the colour night view function is used • When the video light is on (gain up mode) • When the iris/gain is set
Soft skin mode (Set and cancel)	<ul style="list-style-type: none"> • While recording
Tele macro (Set and cancel)	
Help mode	
Video light on (gain up mode)	<ul style="list-style-type: none"> • In picture recording mode
Scene mode	<ul style="list-style-type: none"> • When setting the AUTO/MANUAL/FOCUS switch to AUTO • When the colour night view function is used • When the video light is on (When in video recording mode)
Change of white balance	<ul style="list-style-type: none"> • When digital zoom is used • When the colour night view function is used • When the video light is on (gain up mode)
Adjusting the shutter speed, iris/gain	<ul style="list-style-type: none"> • When the colour night view function is used • When the video light is on (gain up mode) • When the scene mode is used

Frequently asked questions

? What kind of cards can be used on this unit?

 SD Memory Cards and SDHC Memory Cards can be used. (→ 16)

? Can motion pictures be recorded on an SD card?

 Yes, they can be recorded.
To record motion pictures, we recommend using SD cards from 256 MB to 4 GB that conform to Class 2 or higher of the SD Speed Class Rating.

? Can I record continuously from the HDD to an SD card or vice versa?

 No, you cannot record continuously.
Use [MEDIA SELECT] on the menu to switch the recording destination. (→ 36, 39)

? Is it possible to copy data on the HDD and an SD card with this unit?

 Copying still pictures is possible. (→ 69)
Copying motion pictures is not possible.

? Is it possible to play back an SD card recorded with this unit on other products?

 Motion pictures:
These can be played back on any device which supports motion pictures based on the SD-Video standard, the MPEG-2 video format and the MPEG-1 Audio Layer 2 audio format.
Still pictures:
These can be played on any device which supports DCF (Design rule for Camera File system).

? What should I do when the HDD is full?

 Use the supplied software to back up the data to a computer or a DVD disc.
You can also connect to a DVD recorder or a VCR with the AV/S cable (supplied) and then dub the data. (→ 73)
After that, delete unnecessary scenes or format the HDD. (→ 61, 66, 70)

? Can software other than that supplied be used?

 For information about software from other companies, contact the makers of the software.

Others

? Can I write data from a computer onto the unit's HDD or SD card?

 No, you cannot.
This unit's USB terminal is read only.

? Is playback possible on a computer?

 Use ImageMixer3.

? Is editing possible on a computer?

 Use ImageMixer3.
• Motion pictures that have been saved to the ImageMixer3 library can be edited.

? Can I use the DVD COPY function to copy still pictures as well?

 Yes, you can.
The motion pictures are recorded first onto the disc and then the still pictures are converted to motion pictures and recorded after the motion pictures. Original still picture files (JPEG files) are also recorded onto the DVD disc.

? Can I use the DVD COPY function to copy motion pictures recorded on SD cards onto DVD discs as well?

 No, you cannot.
You can use the DVD COPY function to copy only the images recorded on the HDD.



? Can I make additions to a DVD disc on which data has already been written?

 You can when you record data in the DVD-VR format onto a DVD-RAM or DVD-RW disc. If you record data in the DVD-Video format onto a DVD-RW or +RW disc on which data has already been written, a message asking you to confirm whether the disc contents are to be erased will appear. You cannot write additional data on the disc without erasing its contents.

Troubleshooting

Problem	Check points
This unit cannot be turned on.	<ul style="list-style-type: none"> ● Is the battery fully charged? → Charge the battery using the AC adaptor. (→ 20) ● The battery protection circuit may have operated. Attach the battery to the AC adaptor for 5 to 10 seconds. If the unit still cannot be used, the battery is faulty. ● Is the LCD monitor opened?
This unit is turned off automatically.	<ul style="list-style-type: none"> ● If you do not use the unit for approximately 5 minutes, the power is automatically turned off to conserve the battery charge. To resume recording, turn the power back on. The power will not turn off automatically when the power save function (→ 90) is set to [OFF].
This unit does not stay on long enough.	<ul style="list-style-type: none"> ● Is the battery low? → If the remaining battery power indication is flashing or the message "LOW BATTERY." is displayed, the battery has run down. Charge the battery. (→ 20)
A clicking sound is heard when the power is turned off.	<ul style="list-style-type: none"> ● This is the sound of the lens moving and is not a malfunction.
Battery runs down quickly.	<ul style="list-style-type: none"> ● Is the battery fully charged? → Charge it with the AC adaptor. (→ 20) ● Are you using the battery in an extremely cold place? → The battery is affected by ambient temperature. In cold places, the operating time of the battery becomes shorter. ● Has the battery worn out? → The battery has a limited life. If the operating time is still too short even after the battery is fully charged, the battery has worn out and can no longer be used.
This unit cannot be operated though it is turned on. This unit does not operate normally.	<ul style="list-style-type: none"> ● The unit cannot be operated unless you open the LCD monitor. ● Remove the SD card then press the RESET button. (→ 102) If normal conditions are not restored yet, remove the battery or AC adaptor, wait about 1 minute and then reconnect the battery or AC adaptor. Then about 1 minute later, turn on the power again. (Conducting the above operation when the access lamp is on may destroy the data on the HDD or card.)
The screen has changed suddenly.	<ul style="list-style-type: none"> ● Has the demonstration started? → If you set [DEMO MODE] to [ON] without inserting a card in video recording mode or picture recording mode, the unit is automatically set to the demonstration mode for introducing its functions. Normally this should be set to [OFF]. Press the MENU button, then select [SETUP] → [DEMO MODE] → [OFF] and press the joystick.

Others

Problem	Check points
The remote control does not function.	<ul style="list-style-type: none"> ● Has the button-type battery of the remote control run out? → Replace it with a new button-type battery. (→ 14)
A function indication such as the remaining time indication or the elapsed time indication is not shown.	<ul style="list-style-type: none"> ● If you set [SETUP]→[DISPLAY]→[OFF], indications other than warnings and date indications disappear.
Recording does not start although power is supplied to this unit.	<ul style="list-style-type: none"> ● Has the SD card's write protect switch been set to LOCK? → No recording is possible while the write protect switch is set to LOCK. (→ 17) ● Is the memory of the HDD or card full? → If the HDD or card has no more available memory, free up some memory by deleting unnecessary scenes (→ 61, 66) or use a new card. ● Is the unit set to the video recording mode or picture recording mode? → No recording is possible unless the mode dial is at  or . ● Is the card slot cover open? → If the cover is open, this unit may not operate normally. Close the card slot cover.
Recording starts but stops immediately. The playback picture breaks up for a moment.	<ul style="list-style-type: none"> ● The unit is hot. Follow the messages on the display. → To use the unit again, turn the unit off and leave it for a while.
The unit arbitrarily stops recording.	<ul style="list-style-type: none"> ● Is the AGS function activated? → Record in the normal horizontal position or set [AGS] to [OFF]. (→ 35) ● Can the SD card be used for motion picture recording? → Use an SD card that can be used for motion picture recording. (→ 17)
The operation arbitrarily stops.	<ul style="list-style-type: none"> ● The drop detection function has activated to protect the HDD. → Do not drop or shake this unit while operating it.
Recording stops suddenly during motion picture recording on a card.	<ul style="list-style-type: none"> ● When using an SD card on which data has been written many times and the data writing speed has reduced, the recording may suddenly stop during motion picture recording. → Use a card recommended as suitable for motion picture recording. (→ 17) If the recording stops even when a suitable SD card is used, back up the data on the card to a computer, etc. and then format the card. (→ 70)



Others

Problem	Check points
<p>Recorded still pictures are not clear.</p>	<ul style="list-style-type: none"> ● Are you trying to record small or finely detailed objects with [PICT. QUALITY] set at []? → If you try to record small or finely detailed objects with [PICT. QUALITY] set at [], the images may break up into a mosaic-like pattern. Record with [PICT. QUALITY] set at [] instead. (→ 42)
<p>Auto focus function does not work.</p>	<ul style="list-style-type: none"> ● Is manual focus mode selected? → Set the AUTO/MANUAL/FOCUS switch to AUTO. ● Are you trying to record a scene which is hard to bring into focus in auto focus mode? → There are some recording subjects and surroundings for which the auto focus does not operate correctly. (→ 107) If so, use the manual focus mode to adjust the focus. (→ 51)
<p>Sound is not played back from the built-in speaker of this unit.</p>	<ul style="list-style-type: none"> ● Is the volume too low? → During playback, move the volume lever to display the volume indication and adjust it. (→ 57)
<p>Although this unit is correctly connected to a TV, playback images cannot be seen. The playback images are squeezed horizontally.</p>	<ul style="list-style-type: none"> ● Have you selected video input on the TV? → Please read the operating instructions of your TV and select the channel that matches the input used for the connection. ● Is the [TV ASPECT] setting correct? → Change the setting to match the aspect ratio of the TV. Press the MENU button, then select [SETUP] → [TV ASPECT] → [16:9] or [4:3] and press the joystick.
<p>Scenes or files cannot be deleted or edited.</p>	<ul style="list-style-type: none"> ● Are the scenes or the files locked? → Locked scenes or files cannot be deleted. Release the lock setting. (→ 62, 67) ● It may not be possible to delete scenes that are displayed as [] on the thumbnail display. If the scenes are unnecessary, format the HDD or card to erase the data. (→ 70) Please be aware that if the HDD or a card is formatted then all the data recorded on the HDD or the card will be erased. ● If the SD card's write protect switch is set to LOCK, then deletion is disabled. (→ 17)
<p>The images on the SD card do not look normal.</p>	<ul style="list-style-type: none"> ● The data may be destroyed. It may have been destroyed by static or electromagnetic waves. Store important data on a computer or other products as well.
<p>Even if HDD or a card is formatted, it cannot be used.</p>	<ul style="list-style-type: none"> ● Either this unit or the card may be damaged. Please consult a dealer. ● Use an SD card from 8 MB to 4 GB with this unit. (→ 16)

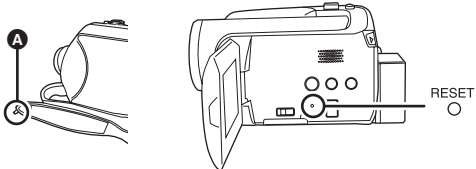
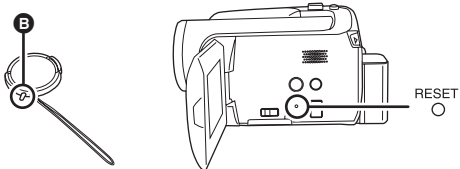
Others

Problem	Check points
<p>The indication disappears.</p> <p>The screen is frozen.</p> <p>No operation can be performed.</p>	<ul style="list-style-type: none"> ● Is this unit connected to a computer? → No operation can be performed on this unit when it is connected to a computer. ● Turn off the power to this unit. If the power cannot be turned off, remove the SD card then press the RESET button, or remove the battery or AC adaptor and then reattach it. After that, turn on the power again. If normal operation is still not restored, detach the power connected, and consult the dealer who you purchased this unit from.
<p>“PUSH THE RESET SWITCH.” is displayed.</p>	<ul style="list-style-type: none"> ● The unit has automatically detected an error. Remove the SD card then press the RESET button to restart the unit. → (SDR-H250) Press the RESET button with the projecting part of the grip belt A.  <ul style="list-style-type: none"> → (SDR-H20) Press the RESET button with the projecting part of the lens cap B.  <ul style="list-style-type: none"> ● If you do not press the RESET button, the power to this unit is turned off automatically about 1 minute later. ● Even after you press the RESET button, the indication may still appear repeatedly. If so, this unit needs repair. Detach the power connected, and consult the dealer who you purchased this unit from. Do not attempt to repair the appliance by yourself.
<p>If the SD card is inserted in this unit, it is not recognised.</p>	<ul style="list-style-type: none"> ● Is the SD card formatted on a computer inserted? → Use this unit to format SD cards. Please be aware that if an SD card is formatted, then all the data recorded on the card will be erased. (→ 70)
<p>If the SD card is inserted in another device, it is not recognised.</p>	<ul style="list-style-type: none"> ● Check that the device is compatible with the capacity or type of SD card (SD Memory Card/SDHC Memory Card) that you inserted. → Refer to the operating instructions of the device for details.

With a computer

Problem	Check points
Even if connected by the USB cable, this unit is not recognised by the computer.	<ul style="list-style-type: none"> • The USB function selection screen does not appear if the USB cable is connected while the menu screen is displayed. → Close the menu screen before connecting the USB cable. • Select another USB terminal on the computer. • Check the operating environment. (→ 78) • Disconnect the USB cable, turn the unit off then on and then reconnect the USB cable.
An image that should have been recorded does not appear when ImageMixer3 is started.	<ul style="list-style-type: none"> • If there are multiple drives, a drive other than this unit may be selected. → HDD: Select [SDR-H250] or [SDR-H20] from [Source]. SD card: Select [Removable Disk] from [Source].
When the USB cable is disconnected, an error message will appear on the computer.	<ul style="list-style-type: none"> • To disconnect the USB cable safely, double-click the  icon in the task tray and follow the instructions on the screen.
The DVD COPY function will not start even when I press the DVD COPY button.	<ul style="list-style-type: none"> • To create DVD-Video discs using the DVD COPY function, you need to install ImageMixer3 for Panasonic from the supplied CD-ROM to your computer. (→ 81) • The DVD COPY function cannot be used in the video recording mode or picture recording mode. → Rotate the mode dial to select  or , then press the DVD COPY button.
I cannot copy images using the DVD COPY function.	<ul style="list-style-type: none"> • Have you already copied those images using the DVD COPY function? → Once images have been copied using the DVD COPY function, they cannot be copied a second or subsequent time. Import the images into ImageMixer3, and then write them on the DVD disc. (→ 87)
It takes a long time to create a DVD.	<ul style="list-style-type: none"> • Creating a DVD may take some time when the size of the motion picture files are small.
The amount of free space on the HDD or SD card does not increase even when the images are backed up on the computer or DVD discs.	<ul style="list-style-type: none"> • The unit's image data is not automatically deleted even when you have imported images to your computer or onto DVD discs using ImageMixer3. → To increase the amount of free space on the HDD or SD card, delete unnecessary images recorded on this unit. (→ 61, 66)
The DVD player cannot play back the discs I have created using ImageMixer3.	<ul style="list-style-type: none"> • To playback a DVD disc created using ImageMixer3, the player must support playback of that DVD disc. (Refer to the operating instructions of the player.)
The DVD-RAM disc cannot be recognised.	<ul style="list-style-type: none"> • If a DVD-RAM driver is installed in your computer, uninstall it.

Others

Cautions for use

About this unit

- The unit and card become warm after long operation, but this is not a malfunction.

Keep the SD Card/Hard Disk Video Camera as far away as possible from electromagnetic equipment (such as microwave ovens, TVs, video games etc.).

- If you use the SD Card/Hard Disk Video Camera on top of or near a TV, the pictures and sound on the SD Card/Hard Disk Video Camera may be disrupted by electromagnetic wave radiation.
- Do not use the SD Card/Hard Disk Video Camera near cell phones because doing so may result in noise adversely affecting the pictures and sound.
- Recorded data may be damaged, or pictures may be distorted, by strong magnetic fields created by speakers or large motors.
- Electromagnetic wave radiation generated by microprocessors may adversely affect the SD Card/Hard Disk Video Camera, disturbing the pictures and sound.
- If the SD Card/Hard Disk Video Camera is adversely affected by electromagnetic equipment and stops functioning properly, turn the SD Card/Hard Disk Video Camera off and remove the battery or disconnect AC adaptor. Then reinsert the battery or reconnect AC adaptor and turn the SD Card/Hard Disk Video Camera on.

Do not use the SD Card/Hard Disk Video Camera near radio transmitters or high-voltage lines.

- If you record near radio transmitters or high-voltage lines, the recorded pictures and sound may be adversely affected.

Make sure to use the supplied cords and cables. If you use optional accessories, use the cords and the cables supplied with them. Do not extend the cords and the cables.

Do not spray insecticides or volatile chemicals onto the unit.

- If the unit is sprayed with such chemicals, its body may be marred and the surface finish may peel off.
- Do not leave rubber or plastic products in contact with the unit for a long time.

When you use the unit in a sandy or dusty place such as a beach, do not let sand or fine dust get into the body and terminals of the unit.

Also, keep the unit away from sea water.

- Sand or dust may damage the unit. (Care should be taken when inserting and removing a card.)
- If sea water splashes onto the unit, wipe off the water with a well wrung cloth. Then wipe the unit again with a dry cloth.

When carrying the unit, do not drop or bump it.

- A strong impact can break the unit's casing, causing it to malfunction.

Do not use benzene, paint thinner or alcohol for cleaning the unit.

- Before cleaning, detach the battery or pull out the AC cable from the AC outlet.
- The camera body may be discoloured and the surface finish may peel off.
- Wipe the unit with a soft dry cloth to remove dust and fingerprints. To remove stubborn stains, thoroughly wring a cloth that has been soaked in a neutral detergent diluted with water and wipe the unit with it. Afterwards, wipe it with a dry cloth.
- When you use a chemical dust cloth, follow the instructions that came with the cloth.

Do not use the unit for surveillance purposes or other business uses.

- If you use the unit for a long time, heat will build up inside it and this may cause a malfunction.
- This unit is not intended for industrial use.

When you are not going to use the unit for an extended time

Others

- When storing the unit in a cupboard or cabinet, it is recommended that you place a desiccant (silica gel) in with it.
- When you travel, do not forget to bring an AC adaptor so that you can recharge the batteries at your destination.

About the battery

The battery used in this unit is a rechargeable lithium-ion battery. It is susceptible to humidity and temperature and the effect increases the more the temperature rises or falls. In cold areas, the full charge indication may not appear or the low battery indication may appear for about 5 minutes after starting use. At high temperatures, the protection function may be triggered, making it impossible to use the unit.

Be sure to detach the battery after use.

- If the battery is left attached, a minute amount of current continues to flow even if the unit's power is off. Keeping the unit in this state may result in over discharge of the battery. This may result in you not being able to use the battery even after it is charged.
- The battery should be stored in the vinyl bag so metal does not come into contact with the terminals.
- The battery should be stored in a cool place free from humidity, with as constant temperature as possible. (Recommended temperature: 15 °C to 25 °C, Recommended humidity: 40% to 60%)
- Extremely high temperatures or low temperatures will shorten the life of the battery.
- If the battery is kept in high-temperature, high-humidity, or oily-smoky places, the terminals may rust and cause malfunctions.
- To store the battery for a long period of time, we recommend you charge it once every year and store it again after you have completely used up the charged capacity.
- Dust and other matter attached to the battery terminals should be removed.

Prepare spare batteries when going out for recording.

- Prepare batteries enough to last for 3 to 4 times the period during you want to record pictures in. In cold places such as a ski resort, the period during which you can record pictures is shortened.

If you drop the battery accidentally, check to see if the terminals are damaged.

- Attaching a battery with damaged terminals can damage the unit or AC adaptor.

Do not throw old battery into fire.

- Heating a battery or throwing it into a fire may result in an explosion.
- If the operating time is very short even after the battery has been recharged, the battery has worn out. Please purchase a new battery.

About the AC adaptor

- If the battery is warm, charging requires more time than normal.
- If the temperature of the battery is extremely high or extremely low, the CHARGE lamp may continue flashing, and the battery may not be charged. Wait until the appropriate temperature is restored before charging the battery again. If the battery still fails to charge, something may be wrong with the battery or AC adaptor. Contact your dealer.
- If you use the AC adaptor near a radio, radio reception may be disturbed. Keep the AC adaptor 1 m or more away from the radio.
- When using the AC adaptor, it may generate whirring sounds. However, this is normal.
- After use, be sure to disconnect the AC adaptor. (If it is left connected, a minute amount of current is consumed.)
- Always keep the electrodes of the AC adaptor and battery clean.



Put this unit near the outlet to make it easy for the interrupting device (plug) to reach it.**About the SD card**

- The memory capacity indicated on the label of an SD card is the total of the capacity for copyright protection and management and the capacity which can be used on the unit, a computer etc.

Others

- During prolonged use, the unit's surfaces and the SD card will heat up slightly. This is normal.

When inserting or removing the SD card, always set the OFF/ON switch to OFF.

While this unit accesses the SD card (while  /  is being displayed/the access lamp is lit), do not open the card slot cover and remove the SD card, operate the mode dial, turn off the power or shake or impact the unit.

■ About the miniSD Card

- Be sure to insert miniSD Cards in the dedicated card adaptor before use. Inserting a card in this unit without the adaptor may damage the unit or the card.
- Do not insert an empty card adaptor in this unit. Do not leave the adaptor in this unit while inserting or removing miniSD Cards. This may cause the unit to malfunction.

LCD monitor

- When the LCD monitor gets dirty, wipe it with a dry soft cloth.
- In a place with drastic temperature changes, condensation may form on the LCD monitor. Wipe it with soft dry cloth.
- When the unit has become very cold, for example due to storage in a cold area, its LCD monitor will be slightly darker than usual immediately after the power is turned on. The normal brightness will be restored when the unit's internal temperature rises.

Extremely high precision technology is employed to produce the LCD Monitor screen featuring a total of approximately 123,000 pixels. The result is more than 99.99% effective pixels with a mere 0.01% of the pixels inactive or always lit. However, this is not a malfunction and does not affect the recorded picture.

About condensation

If condensation forms on the unit, the lens will cloud up, the HDD may be damaged and the unit

may not work properly. Make every effort to ensure that condensation does not form. If it does form, take the actions described below.

Causes of condensation

Condensation takes place when the ambient temperature or humidity is changed as follows.

- When this unit is brought inside from the cold (e.g. a ski slope) to a warm room.
- When this unit is moved from an air-conditioned car to outside.
- When a cold room has been warmed up quickly.
- When cool wind from an air conditioner is directly blown onto this unit.
- After summer afternoon showers of rain.
- When this unit is in a very humid place where the air is thick with steam. (e.g. a heated swimming pool)

When this unit is taken to a location with a significant temperature difference such as from a cold place to a hot place.

If, for example, you have used this unit for recording on a ski slope and are taking it into a heated room, place the unit inside a plastic bag, remove as much of the air from inside the bag as possible, then seal the bag. Leave the unit for about an hour in the room so the temperature of the unit is close to the ambient temperature of the room, then use it.

What to do if the lens is fogged up.

Remove the battery or AC adaptor and leave the unit for about 1 hour. When the unit becomes close to the ambient temperature, the fog disappears naturally.

Explanation of terms

Automatic white balance

White balance adjustment recognises the colour of light and adjusts so the white colour will become a purer white. The unit determines the hue of light that comes through the lens and white balance sensor, thereby judging the recording condition, and selects the closest hue setting.

This is called automatic white balance adjustment.

However, since the unit only stores white colour information under certain light sources, automatic white balance adjustment does not function normally under other light sources.

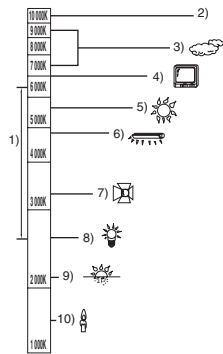

The illustration above shows the range over which the auto white balance functions.

- 1) The effective range of automatic white balance adjustment on this unit
- 2) Blue sky
- 3) Cloudy sky (rain)
- 4) TV screen
- 5) Sunlight
- 6) White fluorescent lamp
- 7) Halogen light bulb
- 8) Incandescent light bulb
- 9) Sunrise or sunset
- 10) Candlelight

Outside of the effective range of automatic white balance adjustment, the image will become reddish or bluish. Even within the effective range of automatic white balance adjustment, the automatic white balance adjustment may not function properly if there is more than one light source. For light outside the functional automatic white balance adjustment range, use the manual white balance adjustment mode.

White balance

The images recorded by the unit may become bluish or reddish under the influence of certain light sources. To avoid such phenomena, adjust the white balance.

White balance adjustment determines the white colour under different light sources. By recognising which is the white colour under sunlight and which is the white colour under a fluorescent light, the unit can adjust the balance among the other colours.

Since the white colour is the reference for all the colours (that make up light), the unit can record pictures in a natural hue if it can recognise the reference colour white.

Auto focus

The lens is moved forward or backward automatically to bring the subject into focus.

Auto focus has the following characteristics.

- Adjusts the focus so that the vertical lines of a subject are seen more clearly.
- Attempts to bring an object with higher contrast into focus.
- Focuses on the screen centre only.

Due to these characteristics, auto focus does not work correctly in the following situations. Record pictures in the manual focus mode.

Recording distant and close-up objects at the same time

Since the unit focuses on whatever is at the centre of the screen, it is difficult to bring the background into focus when close-up objects are placed in focus. When recording people with distant mountains in the background, you cannot focus on both the subject which is close-up and the objects which are in the distance.

Recording a subject behind dirty or dusty window

The subject behind the window will not be focused because the focus is on the dirty window.

Similarly, when recording something on the opposite side of a road with heavy traffic, a vehicle that happens to pass by may be brought into focus.

Recording a subject that is surrounded by objects with glossy surfaces or by highly reflective objects

Since whatever is shiny or glistens is brought into focus, it is hard to focus on the subject to be

Others

recorded. The focus may become blurry when recording subjects at the beach, at night views or in scenes involving fireworks or special lights.

Recording a subject in dark surroundings

The unit cannot focus correctly because the light information that comes through the lens decreases considerably.

Recording a fast-moving subject

As the focus lens-inside moves mechanically, it cannot keep up with a fast-moving subject. When, for example, recording a sports event with fast moving subjects, the focus may lose its sharpness.

Recording a subject with little contrast

It is easy to bring subjects with a sharp contrast or vertical lines or stripes into focus. This means that a subject with little contrast, such as a white wall, may become blurry because the unit achieves focus based upon the vertical lines of an image.

SD Speed Class Rating Class 2

CLASS②

This indicates a Class 2 rating in the high speed standards (SD Speed Class) stipulated by the SD Card Association for high speed writing between SD compatible products and SD Memory cards.

If you use a Class 2 card compatible with the SD Speed Class in an SD compatible product, you can obtain stable recording by using a SD card conformed with Class 2 or more.

Specifications

SD Card/Hard Disk Video Camera

Information for your safety

Power source:	DC 7.9 V/7.2 V
Power consumption:	Recording 5.7 W (SDR-H250)/4.4 W (SDR-H20)

Signal system	CCIR: 625 lines, 50 fields PAL colour signal
Recording format	SD card: Based on the SD-Video standard HDD: Independent standard
Image sensor	<p>SDR-H250: 1/6" 3CCD image sensor Total: 800 K×3 Effective pixels: Moving picture: 630 K×3 (4:3), 540 K×3 (16:9) Still picture: 710 K×3 (4:3), 540 K×3 (16:9)</p> <p>SDR-H20: 1/6" CCD image sensor Total: 800 K Effective pixels: Moving picture: 400 K (4:3), 540 K (16:9) Still picture: 410 K (4:3), 550 K (16:9)</p>
Lens	<p>SDR-H250: Auto Iris, F1.8 to F2.8 Focal length: 3.0 mm to 30.0 mm Macro (Full range AF)</p> <p>SDR-H20: Auto Iris, F1.8 to F3.7 Focal length: 2.3 mm to 73.6 mm Macro (Full range AF)</p>
Zoom	<p>SDR-H250: 10× optical zoom, 25/700× digital zoom</p> <p>SDR-H20: 32× optical zoom, 50/1000× digital zoom</p>
Monitor	2.7" wide LCD monitor (approx. 123 K pixels)
Microphone	Stereo (with a zoom function)
Speaker	1 round speaker ∅ 20 mm
Standard illumination	1,400 lx
Minimum required illumination	12 lx (Low light mode, 1/50) [approx. 1 lx (SDR-H250)/approx. 2 lx (SDR-H20) with the colour night view function]

Others

Video output level	1.0 Vp-p, 75 Ω
S Video output level	Y: 1.0 Vp-p, 75 Ω C: 0.3 Vp-p, 75 Ω
Audio output level (Line)	316 mV, 600 Ω
USB	Card reader function (No copyright protection support) HDD reader function Hi-Speed USB (USB 2.0) compliant PictBridge-compliant
Dimensions (excluding the projecting parts)	70.1 mm (W) × 73.0 mm (H) × 120.8 mm (D)
Mass (without battery and lens cap)	SDR-H250: Approx. 450 g SDR-H20: Approx. 430 g
Operating temperature	0 °C to 40 °C
Operating humidity	10% to 80%
Operating altitude	Less than 3000 m above sea level

Motion pictures

Recording media	SD Memory Card: 32 MB*1/64 MB*1/128 MB*1/256 MB/512 MB/1 GB/2 GB (removable type) (FAT12 and FAT16 format corresponding) SDHC Memory Card: 4 GB (removable type) (FAT32 format corresponding) HDD: 30 GB*2 (fixed type)
Compression	MPEG-2
Recording mode and transfer rate	XP: 10 Mbps (VBR) SP: 5 Mbps (VBR) LP: 2.5 Mbps (VBR)
Recordable time	Refer to page 38.
Audio compression	SD card: MPEG-1 Audio Layer 2, 16 bit (48 kHz/2 ch) HDD: Dolby Digital, 16 bit (48 kHz/2 ch)
Maximum number of recordable folders and scenes	SD card: 99 folders×99 scenes (9801 scenes) HDD: 999 folders×99 scenes (98901 scenes) (When the date changes, a new folder is created and scenes are recorded in this new folder even if the number of scenes in the old folder has not reached 99.)

*1 Cannot be guaranteed in operation.

*2 The 30 GB hard drive utilizes a portion of the storage space for formatting, file management and other purposes. 30 GB is 30,000,000,000 bytes. Usable capacity will be less.

Others

Still pictures

Recording media	SD Memory Card: 8 MB/16 MB/32 MB/64 MB/128 MB/256 MB/512 MB/1 GB/2 GB (removable type) (FAT12 and FAT16 format corresponding) SDHC Memory Card: 4 GB (removable type) (FAT32 format corresponding) HDD: 30 GB* (fixed type)
Compression	JPEG (Design rule for Camera File system, based on Exif 2.2 standard), DPOF corresponding
Picture size	SDR-H250: 2048×1512, 1920×1080 (16:9), 1280×960, 640×480 SDR-H20: 640×480, 640×360 (16:9)
Number of recordable pictures	Refer to page 112.

* The 30 GB hard drive utilizes a portion of the storage space for formatting, file management and other purposes. 30 GB is 30,000,000,000 bytes. Usable capacity will be less.

AC adaptor

Information for your safety

Power source:	AC 110 V to 240 V, 50/60 Hz
Power consumption:	19 W
DC output:	DC 7.9 V, 1.4 A (Unit operation) DC 8.4 V, 0.65 A (Battery charging)





Dimensions	61 mm (W) × 32 mm (H) × 91 mm (D)
Mass	Approx. 110 g





Specifications may change without prior notice.

Others

Number of recordable pictures on the HDD or an SD card





SDR-H250:



Picture size		3.1m (2048×1512)		2m (1920×1080)	
Picture quality					
HDD	30 GB	19160	29950	24960	39230
SD	8 MB	2	4	3	6
	16 MB	7	12	10	16
	32 MB	18	28	23	37
	64 MB	38	61	50	80
	128 MB	75	120	98	155
	256 MB	155	250	210	320
	512 MB	310	490	410	640
	1 GB	630	990	820	1290
	2 GB	1280	2010	1670	2630
4 GB	2520	3950	3290	5170	

Picture size		1m (1280×960)		0.3m (640×480)	
Picture quality					
HDD	30 GB	47070	74890	99999	99999
SD	8 MB	7	12	37	75
	16 MB	20	32	92	185
	32 MB	45	73	200	410
	64 MB	96	155	430	850
	128 MB	185	300	820	1640
	256 MB	390	620	1710	3410
	512 MB	770	1230	3390	6780
	1 GB	1550	2470	6790	13580
	2 GB	3160	5030	13820	27640
4 GB	6200	9870	27150	54290	

Others

SDR-H20:

Picture size		0.3M (640×480)		0.2M (640×360)	
Picture quality					
HDD	30 GB	99999	99999	99999	99999
SD	8 MB	37	75	37	75
	16 MB	92	185	92	185
	32 MB	200	410	200	410
	64 MB	430	850	430	850
	128 MB	820	1640	820	1640
	256 MB	1710	3410	1710	3410
	512 MB	3390	6780	3390	6780
	1 GB	6790	13580	6790	13580
	2 GB	13820	27640	13820	27640
	4 GB	27150	54290	27150	54290

- The number of recordable pictures depends on whether [] and [] are used together and on the subject being recorded.
- The numbers shown in the table are approximations.
- If you record motion pictures on the HDD or an SD card, the number of recordable still pictures will become smaller.

Others

Index

■ A

AC adaptor	20, 23, 105
Anti-Ground-Shooting (AGS)	35
Aperture	53
Auto focus	107
Automatic white balance	51, 106

■ B

Backlight compensation	45
Battery	20, 21, 105
Beep sound	91
Black balance	52

■ C

Card	16, 24, 70, 105
Charging time	21
Colour night view function	47
Copy	69

■ D

Date and time display	31
Delete	
Scene	61
Still picture	66
Demo mode	91
Digital zoom	43
Display	90
DPOF setting	68
Dubbing	73
DVD COPY function	84

■ F

Fade	45
Format	
Card	70
HDD	70
Frame-by-frame playback	57

■ G

Gain	53
Guideline	48

■ H

HDD	16, 18, 70
HDD information	70
Help mode	29

■ I

Illumination	91
Image stabilizer function	49
Initial setting	91
Iris	53

■ L

Language	29
LCD monitor	14, 32, 106
Locking motion picture scenes	62
Locking still picture files	67

■ M

Manual focus	51
Menu	29
Menu list	89
Motion picture playback	55
Motion picture recording	36

■ N

Number of recordable pictures	112
-------------------------------	-----

■ O

Operation icons	27
-----------------	----

■ P

PictBridge	74
Picture quality	42
Picture size	42
Playing back motion pictures by date	57
Playlist	62
Power LCD plus	33
Power save	90

■ R

Recording modes and recordable time	38
Recording time elapsed	37
Recovery	95
Remaining number of still pictures	41
Remaining time	37
Remote control	14
Resume playback	58

■ S

Scene mode	50
SD Memory Card	16
SD Speed Class	108
SDHC Memory Card	16
Self-recording	44
Self-timer recording	48
Shutter effect	41
Shutter speed	53
Skip playback	55
Slow-motion playback	56
Soft skin mode	46
Still picture compatibility	59
Still picture playback	59
Still picture recording	39

■ T

Tele macro	47
TV aspect	72

Others

■ V	
Video light	44
Volume adjustment	57
■ W	
White balance	51, 107
Wide mode	49
Wind noise reduction function	49
■ Z	
Zoom	43
Zoom microphone	44

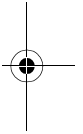
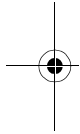
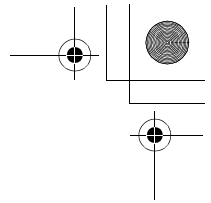
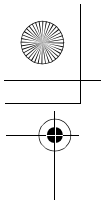

B

LSQT1211 A
F0207Td0 (3000 (A))



Matsushita Electric Industrial Co., Ltd.
Web site: <http://panasonic.net>

