



Panasonic®

Operating Instructions Plasma Television

Model No. **TH-42PZ85B**
TH-46PZ85B

VIERA

VIERA
Link

QLink

DVB®

GUIDE *Plus+*
GEMSTAR

OWNER I.D.

BBE.ViVA
HD3D Sound

SD
HC

FULL
HD
1920x1080p

HD
ready
1080p

HDMI™
HIGH-DEFINITION MULTIMEDIA INTERFACE

Please read these instructions before operating your set and retain them for future reference.
The images shown in this manual are for illustrative purposes only.

U.K. Standard

English



TQB0E0585-1

Turn your living room into a home theatre!

Experience an amazing level of multi-media excitement

- **Receives digital terrestrial broadcastings using an integrated DVB (Digital Video Broadcasting) tuner**

Display DVB programmes with TV Guide (p. 20) / Timer Programming (p. 40) / Register and instantly call up favourite programmes with Profile Edit (p. 32)

- **Sharp pictures with HDMI connection**

Enjoy high-definition digital picture and high-quality sound by using an HDMI cable (p. 52)

- **Links up and controls the connected equipment with “Q-Link” and “VIERA Link”**

Easy recording and playback, create home theatre without complicated settings, etc. (p. 44)

- **Supports Audio Description signal** (p. 15 and p. 26)

This function can add an additional audio track to describe events on-screen and aids understanding and enjoyment, particularly for visually-impaired viewers.

- **Provides natural 3D sound**

BBE ViVA sound provides musically accurate natural 3D sound. (p. 26)

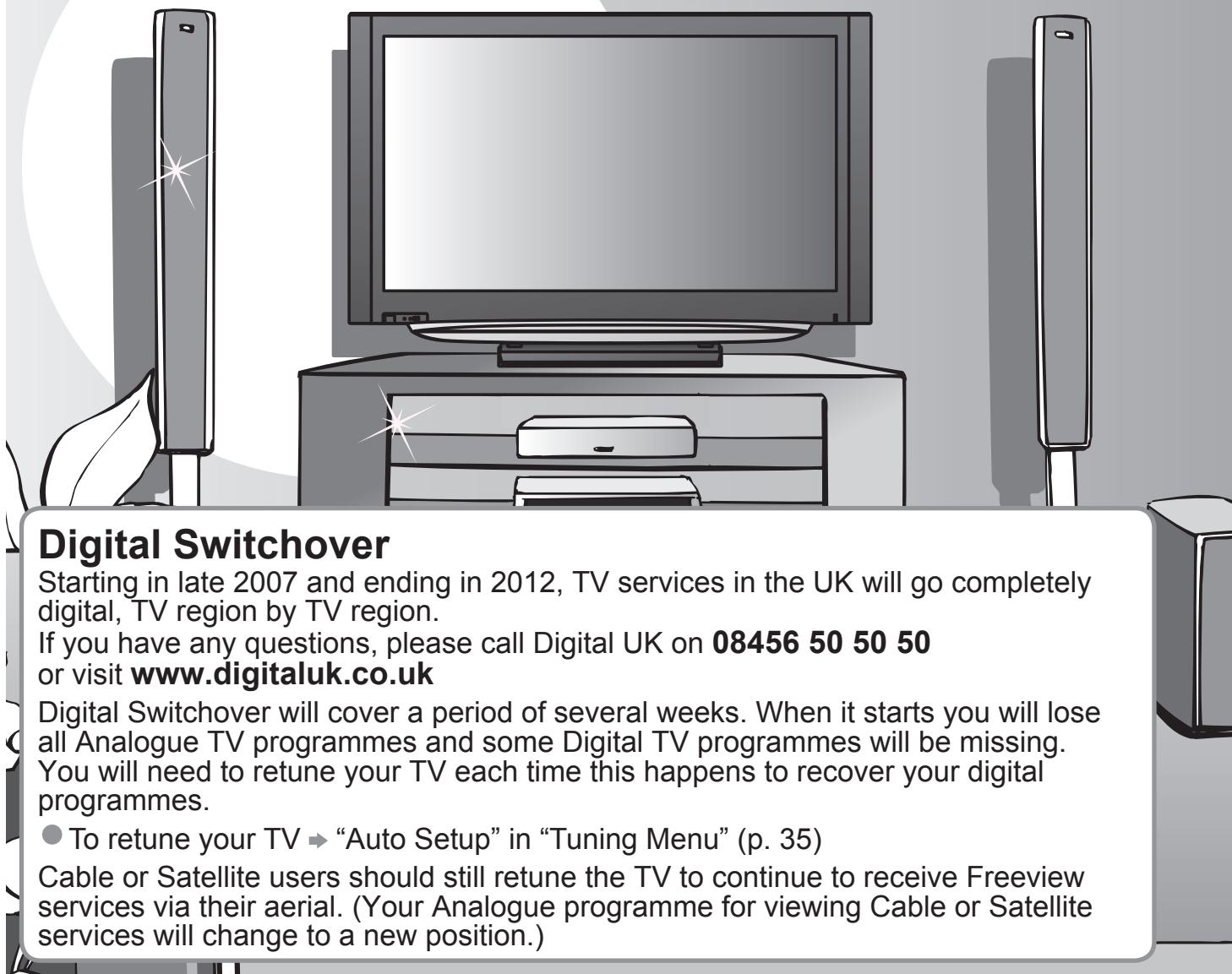

Digital Switchover

Starting in late 2007 and ending in 2012, TV services in the UK will go completely digital, TV region by TV region.

If you have any questions, please call Digital UK on **08456 50 50 50** or visit **www.digitaluk.co.uk**

Digital Switchover will cover a period of several weeks. When it starts you will lose all Analogue TV programmes and some Digital TV programmes will be missing. You will need to retune your TV each time this happens to recover your digital programmes.

- To retune your TV → “Auto Setup” in “Tuning Menu” (p. 35)

Cable or Satellite users should still retune the TV to continue to receive Freeview services via their aerial. (Your Analogue programme for viewing Cable or Satellite services will change to a new position.)

- Due to the digital reception technologies involved, quality of the DTV signals may be relatively low in some cases, despite good reception of analogue programmes.

Contents

Be Sure to Read

- Safety Precautions (Warning / Caution) 4
- Notes 5
- Maintenance 5

Quick Start Guide

- Accessories / Options 6
- Identifying Controls 9
- Basic Connection 10
- Auto Setup 12

Enjoy your TV!

Basic Features

- Watching TV 14
- Viewing Teletext 17
- Using TV Guide 20
- Watching VCR, DVD and Satellites 22

Advanced Features

- How to Use Menu Functions (picture, sound quality, etc.) 24
- DVB Settings (DVB) (pay-TV, software update) 30
- Editing Programmes 32
- Tuning Programmes 34
- Restore Settings 36
- Owner ID 37
- Input Labels 38
- Displaying PC Screen on TV 39
- Recording Controls 40
- Viewing from SD Card (Photos) 42
- Link Functions (Q-Link / VIERA Link) 44
- External Equipment 50

FAQs, etc.

- Technical Information 52
- FAQs 55
- On screen messages 57
- Glossary 58
- Index 58
- Licence 59
- Specifications 59



FULL HD

This TV uses a high definition panel to produce high definition pictures close to their original resolution.



100Hz Double Scan

100Hz Double Scan is a function of this TV that reduces large area flicker.



Intelligent Frame Creation

This increases the frame count and allows natural frame-to-frame transitions, for flicker-less motion images with high resolution.



30,000:1 Native Contrast (1,000,000:1 Dynamic Contrast)

A wide contrast ratio will deliver pictures with a deep black level and a brighter white level for greater image depth.

x.v.Colour

"x.v.Colour" is a promotion name given to the products that have the capability to realize a wide colour space based on the xvYCC specifications.

"x.v.Colour" is a trademark.

x.v.Colour



24p Real Cinema

The 24p source data of movies is converted into a video signal with 6 frames/0.1 second. This produces smoother movie playback.



0.001 msec Panel Response Time

Extremely fast response time to minimise picture lag.



V-Audio Surround

Utilises Panasonic's advanced Digital Amplification technology and BBE ViVA HD3D Sound.

Lead-free display

All VIERA plasma display panels are lead-free. This reduces the impact on the environment when recycling or disposing of them in the future.



Up to 100,000 hours Plasma Panel Lifetime

The Plasma display panel used in the 2008 VIERA TV range is rated for up to 100,000 hours.*

*This measurement is based on the time taken for the brightness of the panel to reduce to half of its maximum level. The time taken to reach this level may vary depending on the image content and the environment where the TV is used. Image retention and malfunctions are not taken into account.

Safety Precautions

Warning & Caution

Handling the mains plug and lead

- Ensure that the mains plug is easily accessible at all times. The On / Off switch on this model does not fully disconnect the TV from the mains supply. Remove the mains plug from the wall socket when the TV is not used for a prolonged period of time.
- Ensure the earth pin on the mains plug is securely connected to prevent electrical shock.
 - An apparatus with CLASS I construction shall be connected to a mains socket outlet with a protective earthing connection.
- Do not use any mains lead other than that provided with this TV. (This may cause fire or electrical shock.)

Do not expose to direct sunlight and other sources of heat

- Avoid exposing the TV to direct sunlight and other sources of heat. To prevent fire never place any type of candle or naked flame on top or near the TV.

Do not place the TV on sloped or unstable surfaces

- The TV may fall off or tip over.

Transport only in upright position

- Transporting the TV with its display panel facing upright or downward may cause damage to the internal circuitry.

IMPORTANT: THE MOULDED MAINS PLUG

FOR YOUR SAFETY, PLEASE READ THE FOLLOWING TEXT CAREFULLY.

This TV is supplied with a moulded three pin mains plug for your safety and convenience. A 5 amp (TH-42PZ85B) / 10 amp (TH-46PZ85B) fuse is fitted in this mains plug. Shall the fuse need to be replaced, please ensure that the replacement fuse has a rating of 5 amps (TH-42PZ85B) / 10 amps (TH-46PZ85B) and that it is approved by ASTA or BSI to BS1362.

Check for the ASTA mark  or the BSI mark  on the body of the fuse.

If the mains plug contains a removable fuse cover, you must ensure that it is refitted when the fuse is replaced.

If you lose the fuse cover the mains plug must not be used until a replacement cover is obtained.

A replacement fuse cover may be purchased from your local Panasonic dealer.

Do not cut off the mains plug.

Do not use any other type of mains lead except the one supplied with this TV.

The supplied mains lead and moulded plug are designed to be used with this TV to avoid interference and for your safety.

If the socket outlet in your home is not suitable, get it changed by a qualified electrician.

If the plug or mains lead becomes damaged, purchase a replacement from an authorized dealer.

WARNING: – THIS TV MUST BE EARTHED.

How to replace the fuse.

Open the fuse compartment with a screwdriver and replace the fuse.

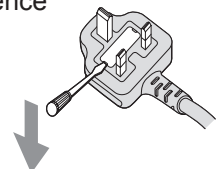

Power source

- This TV is designed to operate on 220-240 V, 50 / 60 Hz AC.

Do not remove the cover

- Do not remove the rear cover as live parts are accessible when it is removed. There are no user serviceable parts inside.

Do not expose your ears to excessive volume from the headphones

- Irreversible damage can be caused.

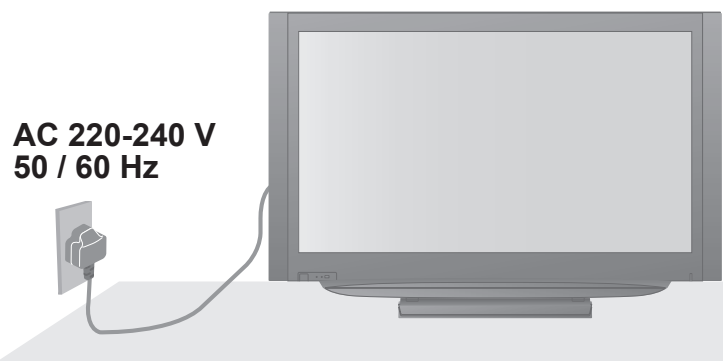

Notes

Do not expose to rain or excessive moisture

- To prevent damage which might result in electric shock or fire, do not expose this TV to rain or excessive moisture. This TV must not be exposed to dripping or splashing water and objects filled with liquid, such as vases, must not be placed on top of or above the TV.

Do not block the rear ventilation openings

- Ventilation should not be impeded by covering the ventilation openings with items such as newspapers, tablecloths and curtains.

Allow sufficient space around the TV for radiated heat

Minimum distance

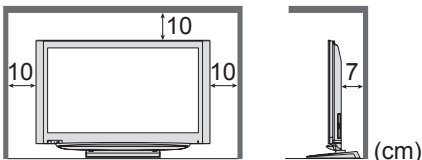

- When using the pedestal, keep the space between the bottom of the TV and the floor surface.
- In case of using Wall-hanging bracket, follow the manual of it.

Use only the dedicated pedestals / mounting equipment

- Using an unapproved pedestal or other fixtures may make the TV unstable, risking injury. Be sure to ask your local Panasonic dealer to perform setup.
- Use approved pedestals / mounts (p. 6).

Do not allow children to handle SD Card

- As with a small object, SD Card can be swallowed by young children. Please remove SD Card immediately after use.

Do not display a still picture for a long time

This causes the image to remain on the plasma screen ("image retention").

This is not considered a malfunction and is not covered by the warranty.

Typical still images

- Programme number and other logos
- Image displayed in 4:3 mode
- Video game
- Computer image



To prevent image retention, contrast is lowered automatically after a few minutes if no signals are sent or no operations are performed. (p. 55)

Auto power standby function

- If no signal is received and no operation is performed in Analogue TV mode for 30 minutes, the TV will automatically go to standby mode.

Keep the TV away from these types of equipment

- Electronic equipment
In particular, do not place video equipment near the TV (electromagnetic interference may distort images / sound).
- Equipment with an infrared sensor
This TV also emits infrared rays (this may affect operation of other equipment).

Maintenance

First, remove the mains plug from the socket outlet.

Display panel

Regular care: Gently wipe the surface clean of dirt by using a soft cloth.
Major contamination: Wipe the surface clean using a soft cloth dampened with clean water or diluted neutral detergent (1 part detergent to 100 parts water). Then, using a soft dry cloth, evenly wipe the surface clean until it is dry.

Caution

- The surface of the display panel has been specially treated and may be easily damaged.
Do not tap or scratch the surface with your fingernail or other hard object.
- Take care not to subject the surface to insect repellent, solvent, thinner, or other volatile substances (this may degrade surface quality).

Cabinet, Pedestal

Regular care: Wipe the surface clean using a soft dry cloth.
Major contamination: Dampen a soft cloth with clean water or water containing a small amount of neutral detergent. Then, wring the cloth and wipe the surface clean with it. Finally, wipe the surface clean with a dry cloth.

Caution

- Take care not to subject the TV's surfaces to detergent. (A liquid inside the TV could lead to product failure.)
- Take care not to subject surfaces to insect repellent, solvent, thinner, or other volatile substances (this may deteriorate the surface by peeling the paint).
- Do not allow the cabinet and pedestal to make contact with a rubber or PVC substance for a long time.

Mains plug

Wipe the mains plug with a dry cloth at regular intervals. (Moisture and dust may lead to fire or electrical shock.)

Accessories / Options

Standard accessories

Check that you have the accessories and items shown

- Remote Control
- N2QAYB000239



- Batteries for the Remote Control (2)
- R6 (UM3)



- Clamper (2)
- TMME289
- ➔ p. 8

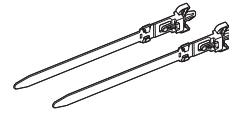

- Mains Lead
- K2CT3DH00018 (TH-42PZ85B)
- K2CT3DH00025 (TH-46PZ85B)
- ➔ p. 11

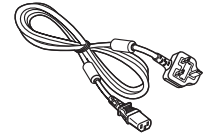

- Operating Instructions
- Pan European Guarantee Card
- 1 Year Guarantee Registration
- CRM (Customer Relationship Management)

- Cleaning cloth
- TXFPE01RLTB



- Pedestal (ST-42R3-W2 / ST-50R3-W2)
- TBLX0043 (TH-42PZ85B)
- TBLX0045 (TH-46PZ85B)
- TXFBL01RLTD
- ➔ p. 7

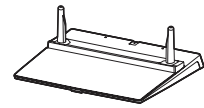

- This product contains possibly dangerous parts (such as plastic bags), that can be breathed in or swallowed by young children accidentally. Keep these parts out of reach of young children.

Optional accessories

Some items may not be available locally.

- Wall-hanging bracket (vertical)
- TY-WK42PV4W

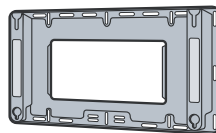

- (angle)
- TY-WK42PR4W

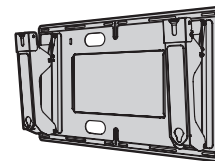

Caution

- In order to maintain the unit's performance and safety, be absolutely sure to ask your dealer or a licenced contractor to secure the wall-hanging brackets.
- Carefully read the instructions accompanying the pedestal, and be absolutely sure to take steps to prevent the TV from tipping over.
- Handle the TV carefully during installation since subjecting it to impact or other forces may cause product damage.

Installing remote's batteries

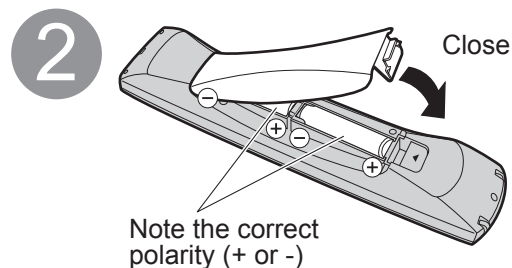
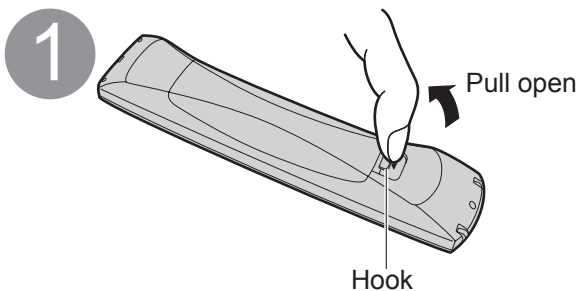

Caution

- Incorrect installation may cause battery leakage and corrosion, resulting in damage to the remote control.
 - Do not mix old and new batteries.
 - Do not mix different battery types (such as alkaline and manganese batteries).
 - Do not use rechargeable (Ni-Cd) batteries.
 - Do not burn or breakup batteries.
- Batteries must not be exposed to excessive heat such as sunshine, fire or the like.

Attaching the pedestal

Warning

Do not disassemble or modify the pedestal.

- Otherwise the TV may fall over and become damaged, and personal injury may result.

Caution

Do not use any other TV and displays.

- Otherwise the TV may fall over and become damaged, and personal injury may result.

Do not use the pedestal if it becomes warped or physically damaged.

- If you use the pedestal while it is physically damaged, personal injury may result. Contact your nearest Panasonic dealer immediately.

During set-up, make sure that all screws are securely tightened.

- If insufficient care is taken to ensure screws are properly tightened during assembly, the pedestal will not be strong enough to support the TV, and it might fall over and become damaged, and personal injury may result.

Ensure that the TV does not fall over.

- If the TV is knocked or children climb onto the pedestal with the TV installed, the TV may fall over and personal injury may result.

Two or more people are required to install and remove the TV.

- If two or more people are not present, the TV may be dropped, and personal injury may result.

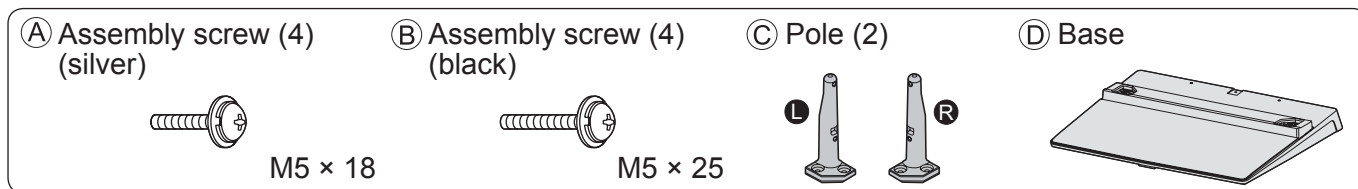

■ Assembling the pedestal

Use the four assembly screws (A) to fasten the left and right poles to the base securely.

- Make sure that the screws are securely tightened.
- Forcing the assembly screws the wrong way will strip the threads.
- "L" or "R" mark is stamped on the bottom of the pole.

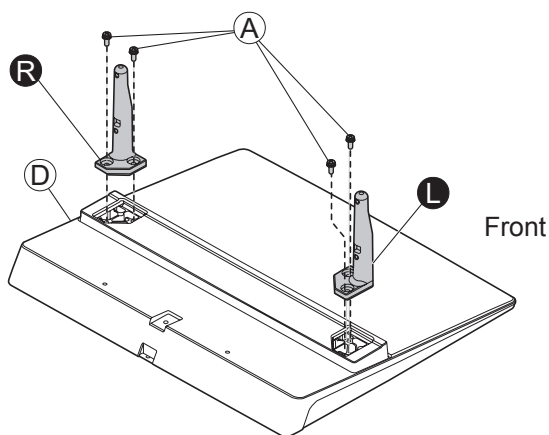

■ Securing the TV

Use the assembly screws (B) to fasten securely.

- Make sure that the screws are securely tightened.
- Carry out the work on a horizontal and level surface.

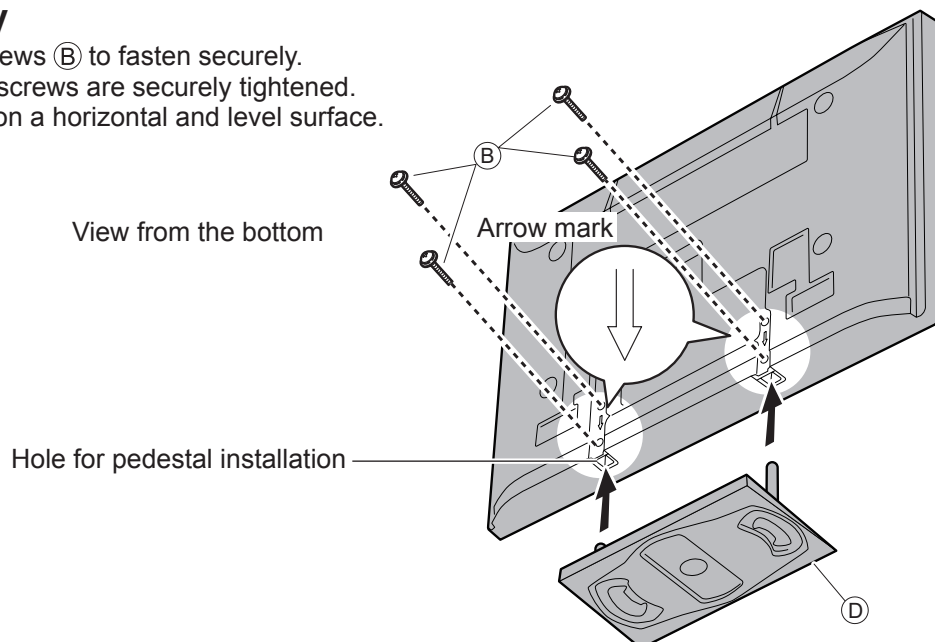

Accessories / Options

Using the clammer

Rear of the TV

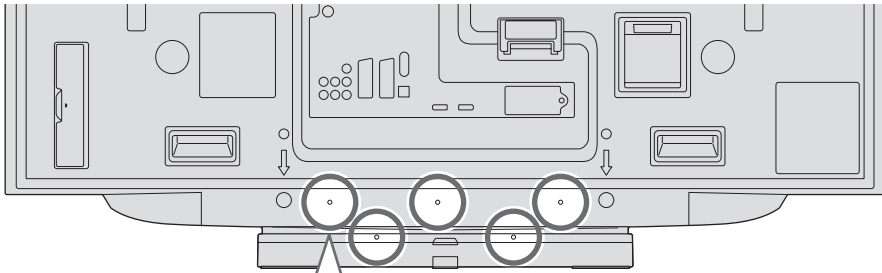

- Do not bundle the RF cable and mains lead together (could cause distorted image).
- Fix cables with clammers as necessary.
- When using the optional accessory, follow the option's assembly manual to fix cables.

■ Attach the clammer

To remove from the TV:

■ Bundle the cables

To loosen:

Adjust the panel to your desired angle

- Ensure that the pedestal does not hang over the edge of the base even if the TV swivels to the full rotation range.
- Do not place any objects or hands within the full rotation range.

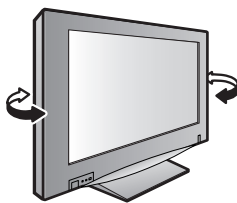

- TH-42PZ85B
a: 521 mm / b: 425 mm / c: 15°
- TH-46PZ85B
a: 513 mm / b: 453 mm / c: 10°

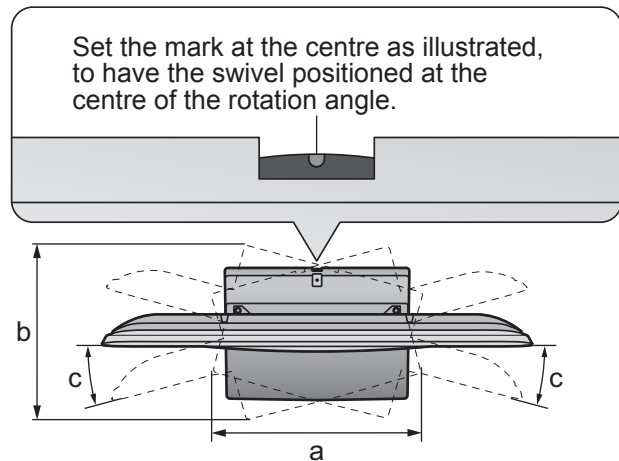

(View from the top)

Identifying Controls

TV

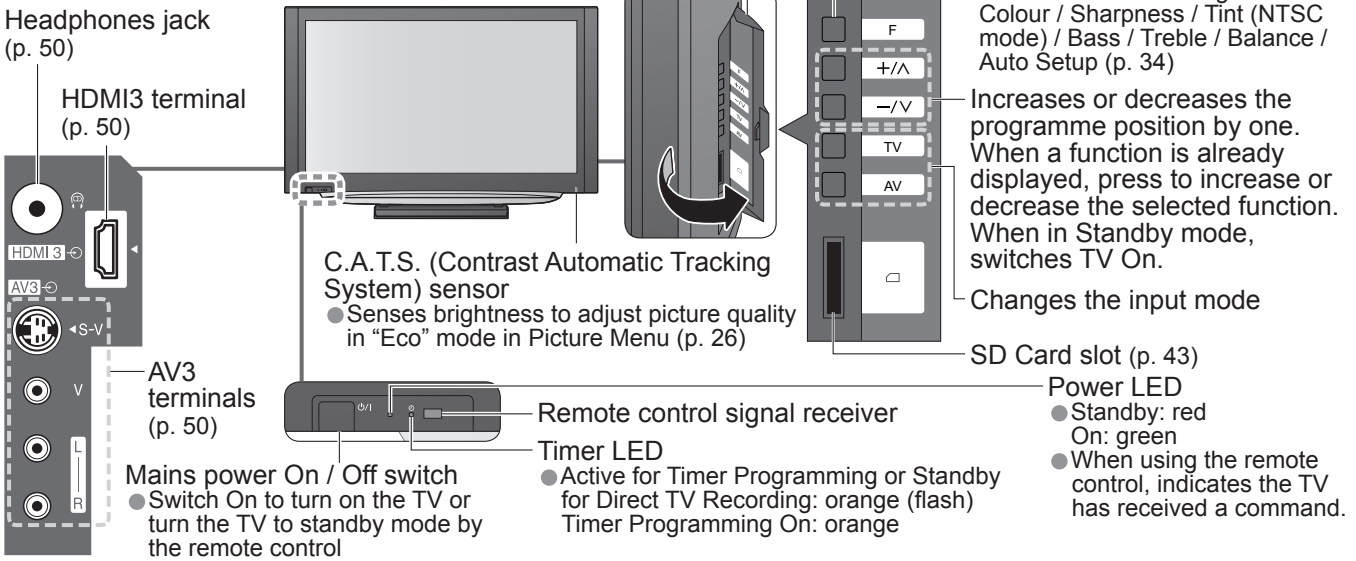

Remote Control

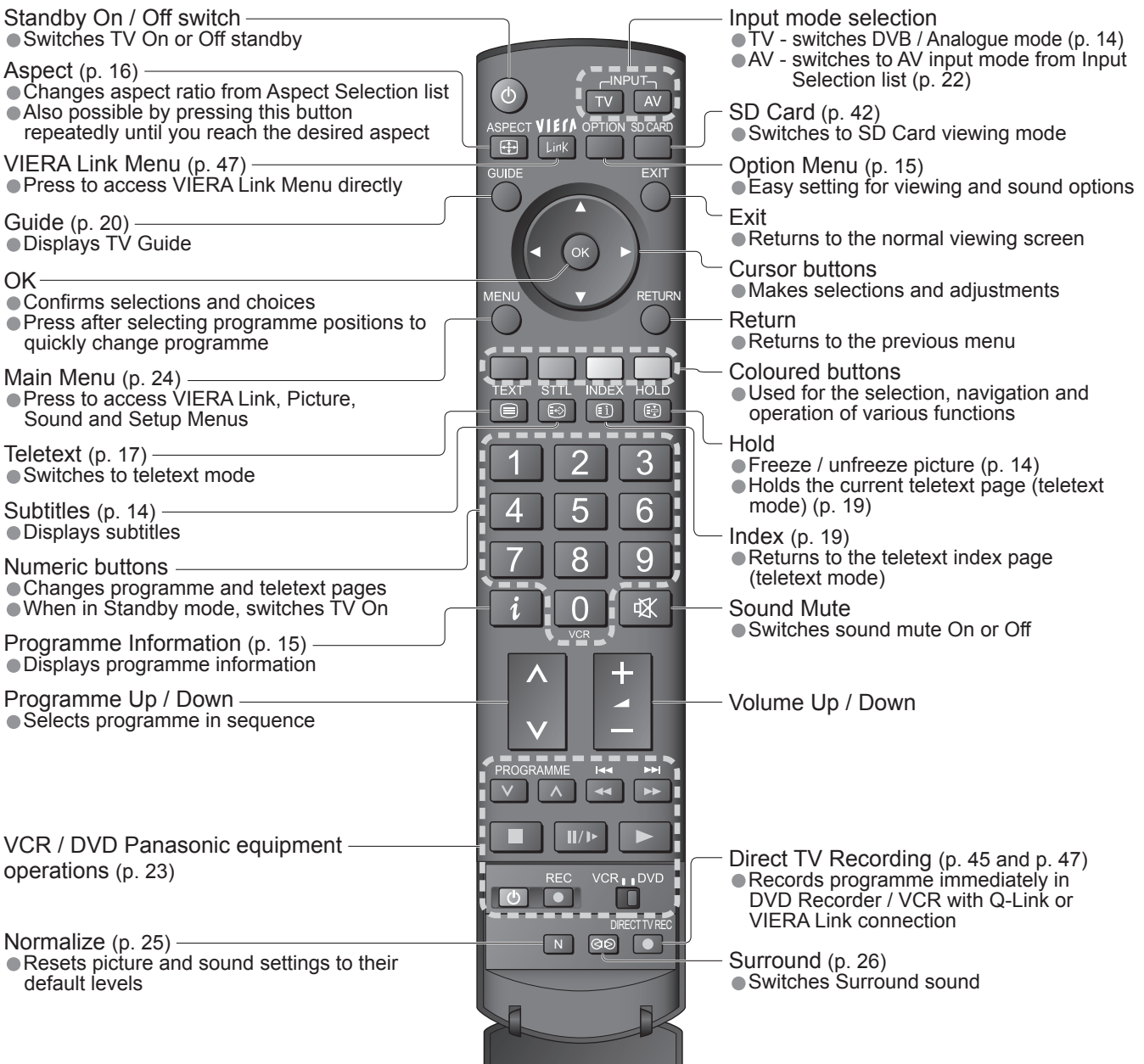

Basic Connection

External equipment and cables shown are not supplied with this TV.
Please ensure that the unit is disconnected from the mains socket before attaching or disconnecting any leads.
When disconnecting the mains lead, be absolutely sure to disconnect the mains plug at the socket outlet first.

Example 1 Connecting aerial

TV only

Rear of the TV

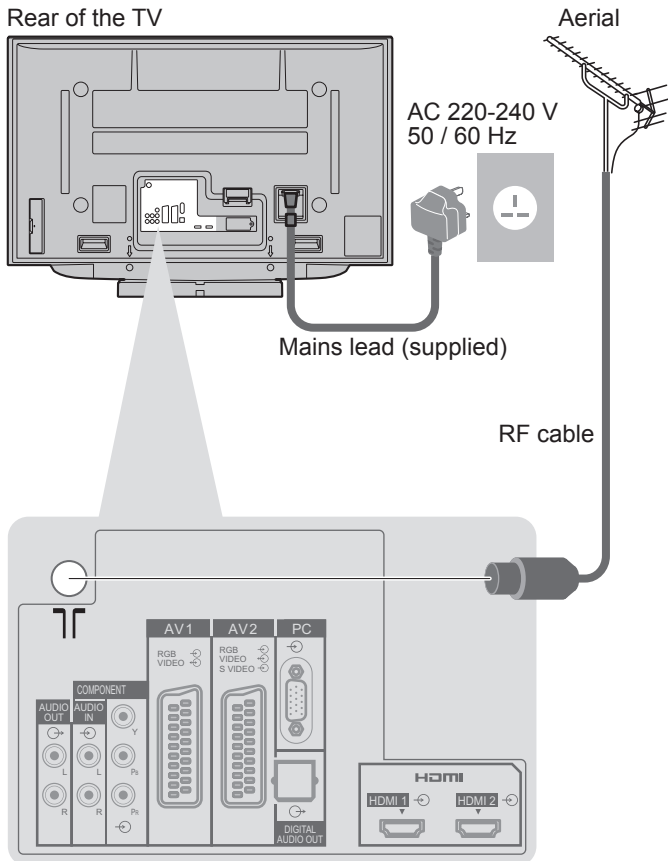

Example 2 Connecting DVD Recorder / VCR

TV, DVD Recorder or VCR

Rear of the TV

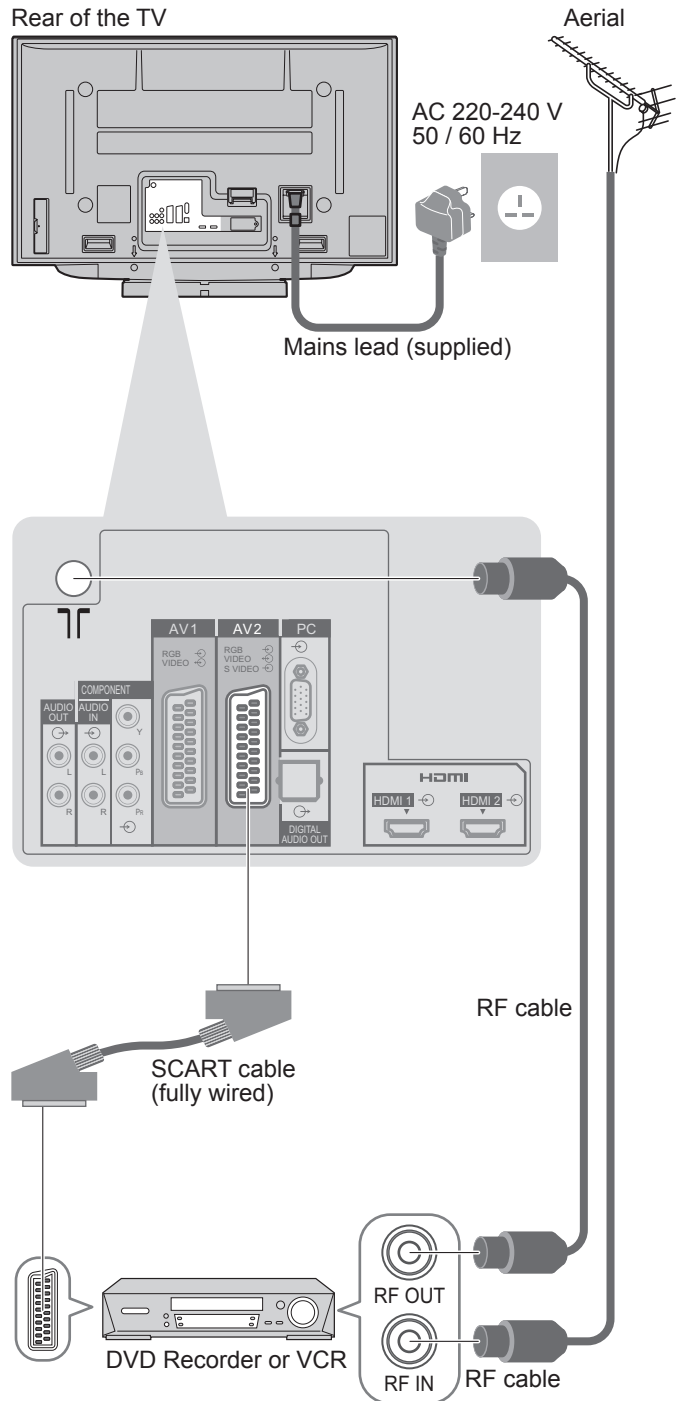

Note

- Connect to AV2 for a DVD Recorder / VCR supporting Q-Link (p. 45).
- Connect to AV1 for a Satellite receiver.
- For HDMI-compatible equipment, possible to connect to HDMI terminals (HDMI1 / HDMI2 / HDMI3) by using HDMI cable (p. 50).
- Q-Link connection → p. 44
- VIERA Link connection → p. 44
- Read the manual of the equipment too.

Auto Setup

Search and store TV programmes automatically.

These steps are not necessary if the setup has been completed by your local dealer.

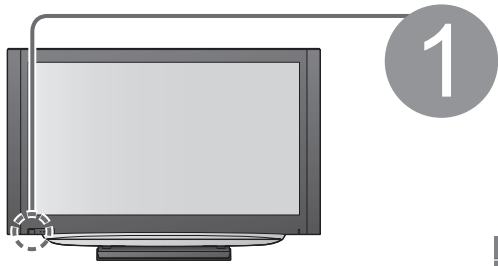

1

Plug the TV into mains socket and switch On (Takes a few seconds to be displayed)



- You can now use the remote control to turn On the TV or turn the TV to standby mode. (Power LED: On)

Auto Setup - Digital and Analogue

Digital Scan	21	68
Analogue Scan	21	68

This will take about 8 minutes.

Channel	Service Name	Type	Quality
62	CBBC Channel	Free TV	10
62	BBC Radio Wales	Free TV	10
62	E4	Free TV	10
62	Cartoon Nwk	Free TV	10
29		Analogue	1-
33	BBC1	Analogue	1-

Free TV: 4 Pay TV: 0 Radio: 0 Data: 0 Analogue: 2

EXIT

- Auto Setup will start to search for TV programmes and store them in the numbered order as specified by the broadcasters.

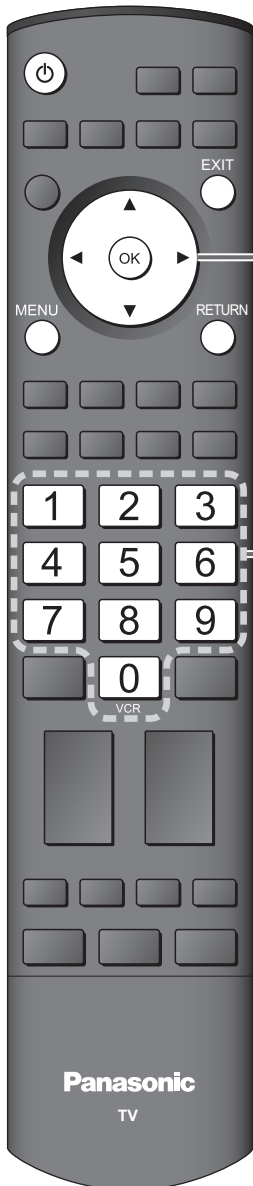

2

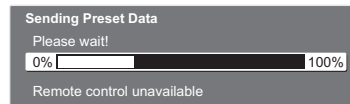

- If Q-Link, or similar technology (p. 45), compatible recorder is connected, analogue programme information is automatically downloaded to the recorder. (Digital programme information is not downloaded.)

When inputting Owner ID

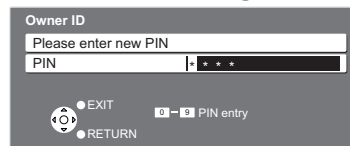

Following the on-screen operation guide, enter your own choice of PIN number, name, etc.

- For detailed procedures → "Owner ID" (p. 37)
- Make a note of the PIN number in case you forget it.

When inputting Owner ID later



- If you input the ID later → "Owner ID" (p. 37)

3

Select the picture setting

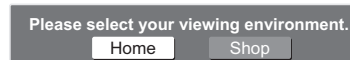

- "Shop" and "Home" are equal to "Dynamic" and "Normal" respectively - "Viewing Mode" in "Picture Menu" (p. 26)

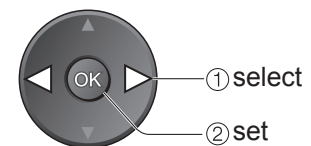

Auto Setup is now complete and your TV is ready for viewing.

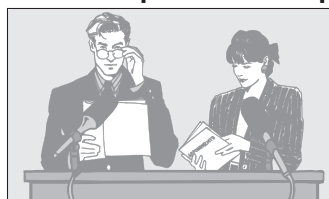

- To check programme list at-a-glance → "Using TV Guide" (p. 20)
- To edit programmes → "Editing Programmes" (p. 32)

Using the On Screen Displays

Many features available on this TV can be accessed via the On Screen Display menu.

■ How to use remote control

MENU



Open the main menu



Move the cursor / select the menu



Move the cursor / adjust levels / select from a range of options



Access the menu / store settings after adjustments have been made or options have been set

RETURN



Return to the previous menu



Exit the menu system and return to the normal viewing screen

■ ON SCREEN HELP Instructions box (example: Owner ID)

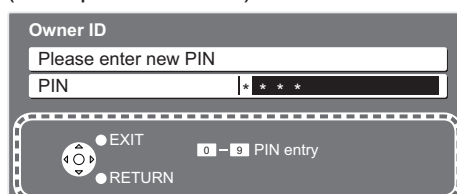

On-screen operation guide will help you.

Note

- If tuning has failed → “Auto Setup” (p. 35)
- If downloading has failed → “Q-Link Download” (p. 27)
- To initialize all settings → “Shipping Condition” (p. 36)
- If you turned the TV Off during Standby mode last time, the TV will be in Standby mode when you turn the TV On with Mains power On / Off switch.

Watching TV

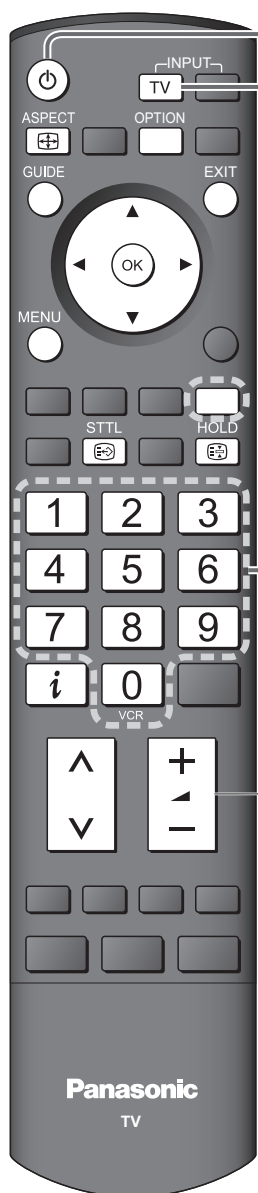

1

Turn power on
(Press for about 1 second)



● Mains power On / Off switch should be On. (p. 9)

2

Select DVB (Digital Video Broadcasting) or Analogue mode



● Also possible to select the mode using the TV button on the side panel of the TV. (p. 9)

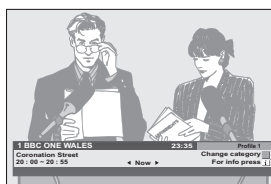

Information banner appears whenever you select a programme

● For details → p. 15

3

Select a programme

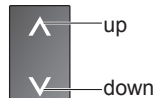

or



● To select the two or three-digit programme number, e.g. 39

→ 3 → 9
(in a short time)

Volume

■ **Select a programme using Information banner (p. 15)**

Possible to confirm the programme name before selecting programmes.

Display Information banner if it is not displayed

While the banner is displayed, select the programme



● Possible to set display timeout in "Banner Display Timeout" (p. 27).

■ **Select a programme using TV Guide (p. 20)**

Possible to confirm the TV Guide (EPG) before selecting programmes.

Display TV Guide

Select the event now on the air

Select "View"



① select

② access



① select

② watch

Note

● To watch pay-TV → p. 31

■ **Other useful functions**

Hold	Freeze / unfreeze picture	HOLD
Display subtitles	Display / hide subtitles (if available) ● To change the language for DVB (if available) → "Preferred Subtitles" (p. 27)	STTL

■ Other useful functions

Display Information banner

Display Information banner 

- Also appears when changing a programme

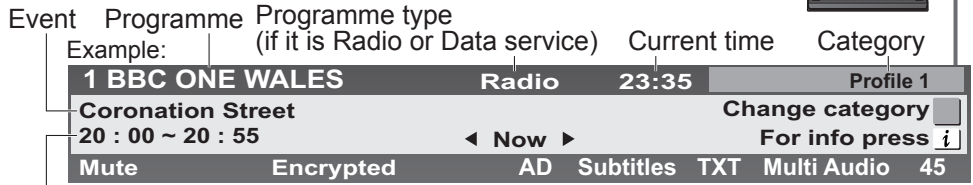







Example:

Event	Programme	Programme type (if it is Radio or Data service)	Current time	Category
1	BBC ONE WALES	Radio	23:35	Profile 1
Coronation Street		20 : 00 ~ 20 : 55		Change category
Mute		Encrypted	AD	Subtitles TXT Multi Audio 45

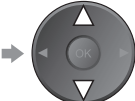
DVB: Event Start / Finish time
Analogue: Programme status

Features available / Message meanings

<p>Mute Sound mute On</p> <p>Bad signal Poor TV signal quality</p> <p>Encrypted Scrambled programme</p> <p>AD Audio Description service available ● This function can aid visually-impaired viewers by adding an additional audio track to describe events on-screen. ● For settings → p. 26</p>	<p>Subtitles Subtitle service available</p> <p>TXT Teletext service available</p> <p>Multi Audio Multiple audio available</p> <p>Stereo, Mono Audio mode</p> <p>1 - 90 Off Timer remaining time ● For settings → p. 16</p>
--	---

- To confirm another tuned programme name → 
- To change the category →  blue
- Information on the next event (DVB mode) → 
- Extra information →  (press again to hide the banner) (DVB mode)
- “AD”, “Subtitles”, “TXT”, “Multi Audio” indications are displayed as available on particular programmes, but may not be available for all individual programmes being broadcast. Display the extra information to confirm availability of these functions.
- To watch the programme listed in the banner → 
- To hide → 
- To set display timeout → “Banner Display Timeout” (p. 27)

Example:



Display the selectable settings for the current programme

Check or change the current programme status instantly 

Multi Audio (DVB mode)
Allows you to select between alternative language for sound tracks (if available)

Subtitle Language (DVB mode)
Allows you to select the language in which subtitles should appear (if available)

NICAM (Analogue mode)
→ Sound Menu (p. 26)

Note

- Also possible to change the settings in Menu list (p. 26 and p. 27).

OPTION

- To change →  ② change
① select

Volume Correction

Adjusts volume of individual programme or input mode

Audio Description (DVB mode)

Select “On” if the programme has Audio Description service, then you will hear an additional audio track to describe events on-screen

Watching TV

Other useful functions

Off Timer

Turn the TV off automatically after a fixed period

Display the menu

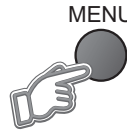

Select "Setup"

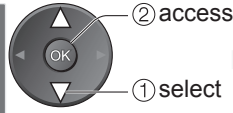

Select "Off Timer" and set the time

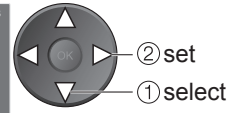
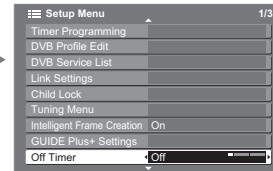

- To cancel → Set to "Off" or turn the TV off.
- To display the remaining time → Information banner (p. 15)
- When the remaining time is within 3 minutes, the remaining time will flash on screen.

Change the aspect ratio

ASPECT



Enjoy viewing the picture at its optimum size and aspect.

Display Aspect Selection list



While the list is displayed, select the mode

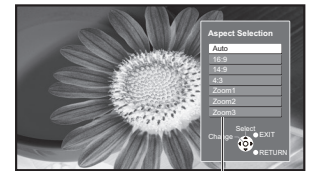
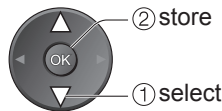

Aspect Selection list

- To change the mode using the ASPECT button only
 →  (Press repeatedly until you reach the desired mode)



Auto

The best ratio is chosen and the picture expanded to fill the screen. For details → p. 52



16:9

Directly displays the image at "16:9" without distortion (anamorphic).

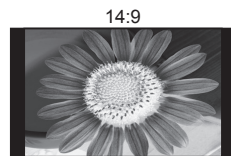

14:9

Displays the image at the standard "14:9" without distortion.

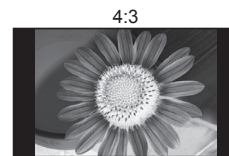

4:3

Displays the image at the standard "4:3" without distortion.



Zoom1

Displays a "16:9" letterbox or "4:3" image without distortion.



Zoom2

Displays a "16:9" letterbox (anamorphic) image full-screen without distortion.



Zoom3

Displays a "2.35:1" letterbox (anamorphic) image full-screen without distortion. At "16:9", displays the image at its maximum (with slight enlargement).

Note

- Only "16:9" and "4:3" are available in PC mode.
- Not available when Subtitle is active in DVB mode.
- Not available in Analogue teletext mode.
- Aspect mode can be memorized separately for SD (Standard definition) and HD (High definition) signals.

Change aspect ratio

Viewing Teletext

You can enjoy news, weather forecasts and subtitles, etc. (depending on the broadcaster)

DVB mode

DVB teletext services

DVB teletext services differ greatly from analogue teletext. When you switch to a DVB teletext service, the images you see can contain graphics and text, laid out and controlled in a manner decided by the broadcaster.

- You can check if the programme has teletext service.

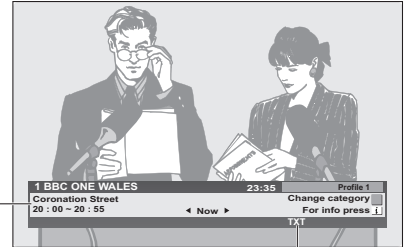

Information banner (p. 15)

Displayed if programme has teletext service

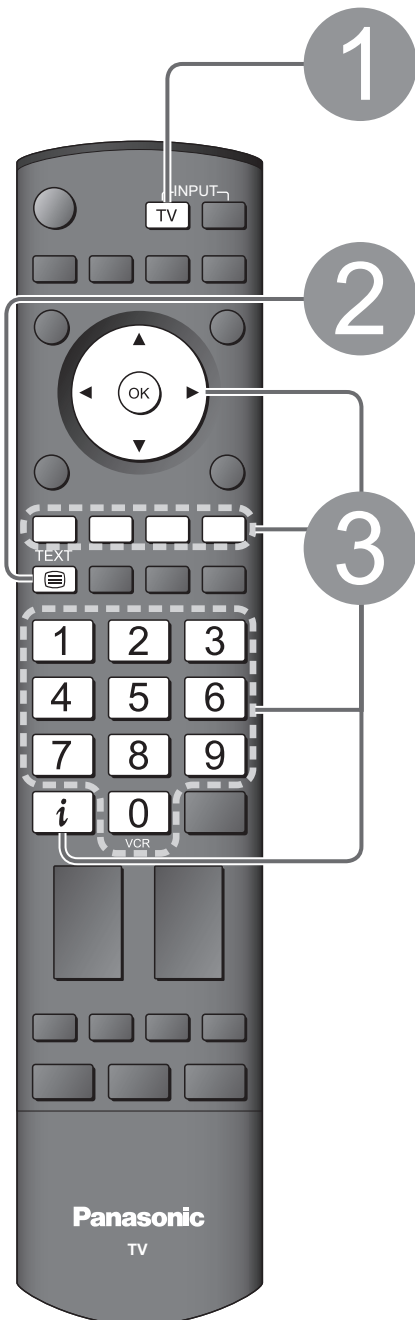

If in Analogue mode
Select DVB



Switch to Teletext

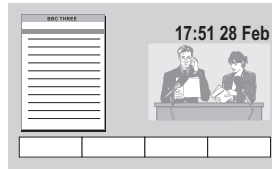

How to use

In all cases, it is possible to navigate the pages using buttons on the remote control, but because the commands available must apply to all manufacturers of DVB equipment, some on screen commands may not correspond exactly to the remote control buttons.

For example:

- When "select" or "go" is displayed →
- When "◀", "▶", "▲", "▼" symbol is displayed →
- When the key words are displayed on colour bar →
- When options with numbers are displayed →
- When "i" is displayed → (information)

■ **To return to TV** →

Note

- As soon as you switch to a DVB programme with links to a teletext service, software is downloaded in the background to enable the teletext function. This means that when switching to a DVB programme, you should wait for approximately 5 seconds before pressing the TEXT button - this will allow the software to download. If you press the TEXT button before download is complete, there will be a short delay before the text screen is displayed.
- While navigating DVB teletext, you will find there is a short delay when moving between pages while the page downloads. There is often a prompt shown somewhere on the page (for example "Loading") to let you know that this is happening.

Viewing Teletext

Analogue mode

What is FASTEXT mode (default)?

In FASTEXT mode, four differently coloured subjects are situated at the bottom of the screen. To access more information about one of these subjects, press the appropriately coloured button. This facility enables fast access to information on the subjects shown.

What is List mode?

In List mode, four differently coloured page numbers are situated at the bottom of the screen. Each of these numbers can be altered and stored in the TV's memory. ("Store frequently viewed pages", p. 19)

■ **To change mode** → "Teletext" in Setup Menu (p. 27)

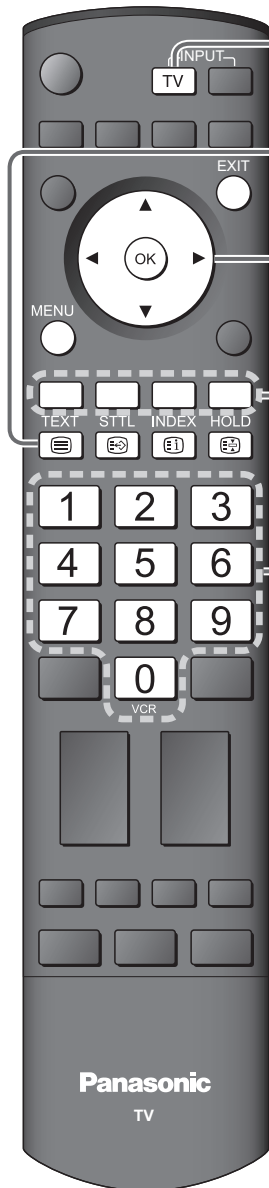

1

If in DVB mode
Select Analogue



2

Switch to Teletext



● Displays the index page (content varies depending on the broadcasters)

3

Select the page



or

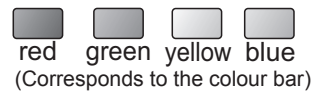

(Corresponds to the colour bar)

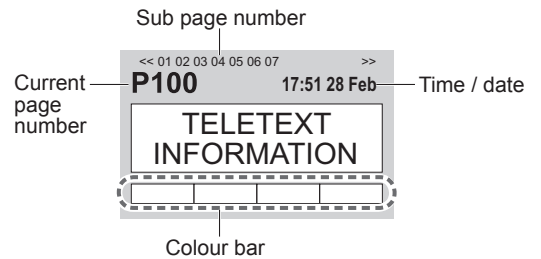

Colour bar

As the blue bar is displayed

■ **To adjust contrast** → MENU (Press twice) → [OK]

■ **To return to TV** → EXIT

Reveal hidden data

Reveal hidden words e.g. quiz page answers

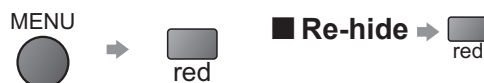

FULL / TOP / BOTTOM

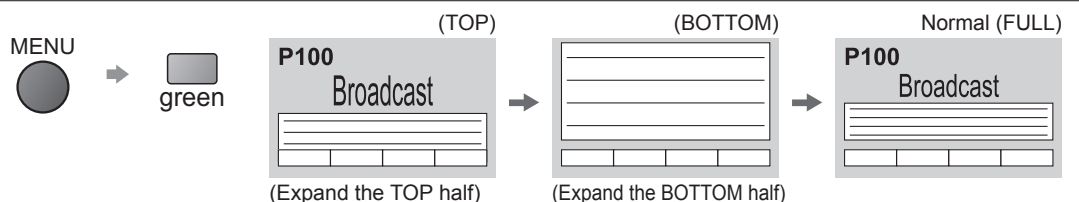

HOLD

Stop automatic updating

(If you wish to hold the current page without updating)



■ To resume →



INDEX

Return to the main index page

Subtitles

View subtitles

- Factory setting is "P888" (subtitle service) on blue button (List mode).

View in multi window

Watch TV and Teletext in two windows at once

- Operations can be made only in Teletext screen.

- Each time pressed: Teletext → TV and Teletext



Store frequently viewed pages

Store frequently viewed pages in the colour bar

(List mode only)

As page is displayed



Corresponding colour button



OK press and hold

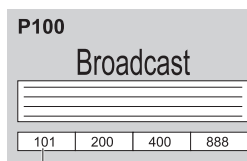

- If you wish to use Subtitles, do not change number on blue button.

The number changes to white.

■ To change stored pages



Colour button you want to change



Enter new page number



OK press and hold

View sub page

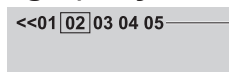
View sub page (Only when teletext is more than one page)

Appears at top of the screen

■ To view specific sub page



blue

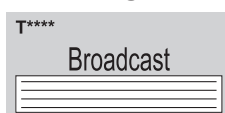

Enter the 4-digit number

example: P6

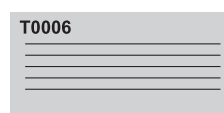

- Sub pages:

The number of sub pages varies depending on the broadcasters (up to 79 pages). It may take some time for searching, during which time you can watch TV.

Watch TV while waiting for update

View the TV picture while searching for a teletext page

Teletext automatically updates itself when new information becomes available.

Changes to TV screen temporarily



yellow



Appears when updating is completed



yellow

View the updated page

(You cannot change the programme.)

- The news page provides a function that indicates arrival of latest news ("News Flash").

Using TV Guide

TV Guide—Electronic Programme Guide (EPG) provides an on-screen listing of the programmes currently broadcast and the forthcoming broadcasts over the next seven days (depending on the broadcasters).

- This TV supports the GUIDE Plus+ system.
- The Gemstar branding partner will supply the rating informations in the event information and the recommended group in the Prog.Type list.
- Analogue programmes will be listed after DVB programmes. “D” means DVB programme and “A” means Analogue programme.
- When this TV is turned on for the first time, or the TV is switched off for more than a week, it may take some time before the TV Guide is completely shown.

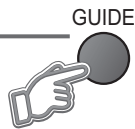
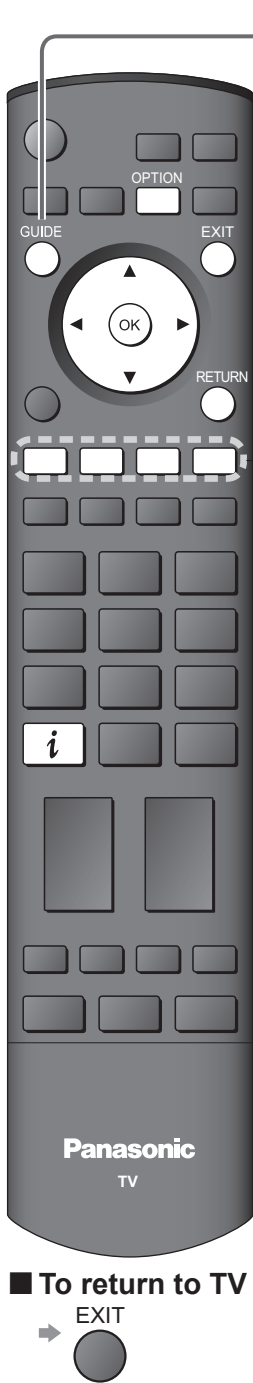

View TV Guide (landscape or portrait)

View “Portrait” to see one programme at a time
View “Landscape” to see many programmes

Example: TV Guide date Event Logo of the Gemstar branding partner

Current date and time: Wed 24/10/2007 10:46

TV Guide time: Wed 24th

Advertisement: **VIERA**

Programme:

Time	19:30	20:00	20:30	21:00
D 1 BBC ONE	Eastender	DIY SOS	The Bill	Red Cap
D 7 BBC THR	Hot Wars		Holiday Program	
D 14 E4	Emmerdal.	Coronation Street	The Bill	
D 70 CBBC Cha	10 O' clock News BBC	Pepsi Char.	Good bye	
D 72 Cartoon	Panorama	Sex And The City	Terminator	
D 105 BBCi	I'm A Celebrity	Pop Idol	News	
D 719 BBC Radi	Rugby	15 To 1	The Bill	

(TV Guide start page)

Landscape (Displays by programme)

To change the layout

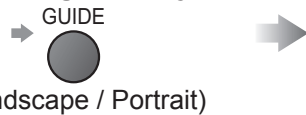

Example:

Example: TV Guide: Portrait

Wed 24/10/2007 10:46

Wed 24th

19:30-20:00 Eastender

20:00-21:00 DIY SOS

21:00-22:00 The Bill

21:00-22:00 Red Cap

22:30-23:00 Live Junction

23:00-23:30 POP 100

23:00-00:00 Rugby

Portrait (Displays by time)

To the previous day (DVB mode)



To the next day (DVB mode)



To view a programme list of the selected type (DVB mode)



Prog. Type

All Types

Movie

News

(Type list)

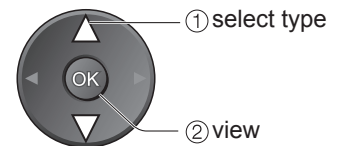

To view a programme list of the selected category



Category

All Services

All DVB Services

All Analogue Services

Free Services

TV and Data Services

Profile 1

Profile 2

Profile 3

Profile 4

(Category list)

Only Analogue TV programmes are listed

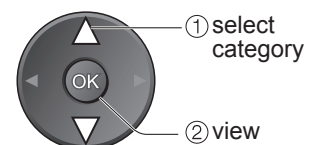

To list favourite programmes → p. 32

■ Other useful functions (Operate after viewing TV Guide)

Watch the programme

Select the current event or programme

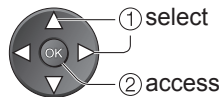

Select "View"

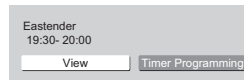
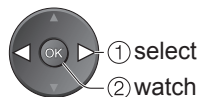

(TV screen)

View details of the event (DVB mode)

Select the event



View details



Details

■ To return to the start page



Timer Programming

Select the event to output to external recorder

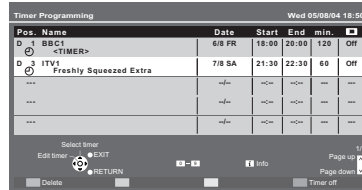
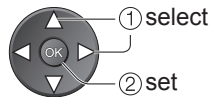

(Timer Programming screen)

Timer LED will turn on if Timer Programming is set.

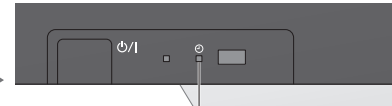

Timer LED

- Orange Timer LED (Blinking during timer active)

■ To check / change / cancel a Timer Programming event → "Timer Programming" (p. 41)

■ To return to TV Guide → RETURN

Note

- When recording programmes, you must make the proper settings on the recorder connected to the TV. If a compatible recorder with Q-Link or similar technologies is connected to the TV (p. 45) and the "Link Settings" (p. 27) are completed, no setting of the recorder is required. Also read the manual of the recorder.
- If you select the current programme, a screen asking you to confirm whether you wish to watch or record it will appear. Select "Timer Programming" to record from the time you finish the Timer Programming setting.

Event recording (Timer Programming according to the TV Guide signal)

Event recording is a timer programme controlled by information from the TV Guide. Programme start and end times may be changed by broadcasters and sent to the TV for timer programme to follow the change. Split Programme is a programme which is interrupted by one or more events. Both of the above are subject to signals being sent by broadcasters.

Select the event to output to external recorder

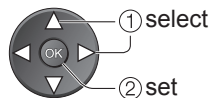

"Guide" is displayed if the timer is set from the TV Guide
 "S/P" is displayed if the timer is set from the TV Guide and the event is a Split Programme

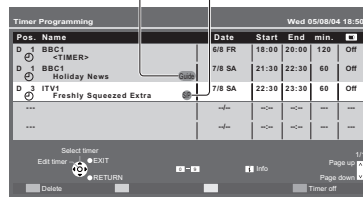

(Timer Programming screen)

Timer LED will turn on if Timer Programming is set.

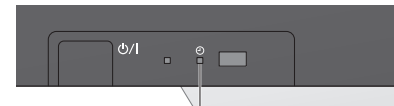

Timer LED

- Orange Timer LED (Blinking during timer active)

■ To check / change / cancel an Event recording event → "Timer Programming" (p. 41)

- If you edit the Event recording after setting to record, it will no longer be performed as Event recording. The recording will be performed according to the time setting in Timer Programming.

■ To return to TV Guide → RETURN

Note

- Whilst making Split Programme recording, it is not possible to record any events between sections.

View advertisement

Enter your postcode when using this function for the first time

→ "Postcode" in "GUIDE Plus+ Settings" (p. 27)

If you have already entered your postcode in Owner ID (p. 12), you do not have to enter again. If you enter an incorrect postcode for your area, or no postcodes are entered, advertisement may not be displayed correctly.

Display advertisement information

OPTION



- To display the latest advertisement, you will need to update the information.
- To update the information continuously, the TV must be left in Standby mode at night.

■ To change advertisements

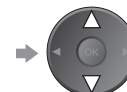

■ To return to TV Guide



Note

- Some advertisements are for future programmes. In this case it is possible to use the Event recording function. → see above
- The information from the GUIDE Plus+ system will not be lost even if turned Off with Mains power On / Off switch.

Watching VCR, DVD and Satellites

Connect the external equipment (VCRs, DVD equipment, etc.) and you can watch the input. Connect the Satellite receiver and you can watch satellite broadcasts.

● To connect the equipment → p. 10 and p. 11

The Remote Control is capable of operating some functions of selected Panasonic external equipment.

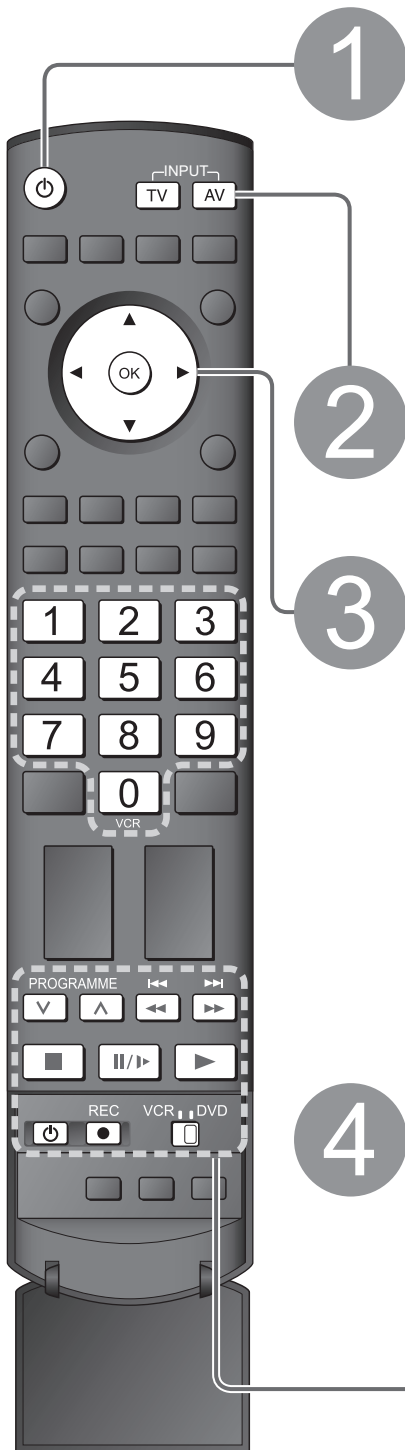

1 Turn the TV on

■ When connecting with SCART as example 2 or 3 (p. 10 and p. 11)

- ➔ Receives input signals automatically when playback starts or satellite receiver is switched on
- Input signals are automatically identified by the SCART (pin 8) terminal.
- This function is also available for HDMI connections (p. 50).

■ If input mode is not switched automatically

- ➔ Perform 2 and 3
- Dependant on the setup of the equipment

2 Display the Input select menu



3 Select the input mode connected to the equipment

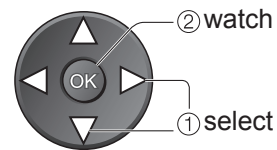
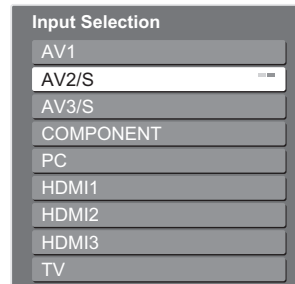

- You can also select the input using the AV button on the remote control or the side panel of the TV. Press the button repeatedly until the desired input is selected.
- You can label or skip each input mode → "Input Labels" (p. 38). Skipped inputs will not be displayed when AV button is pressed.

4 View

Displays the selected mode

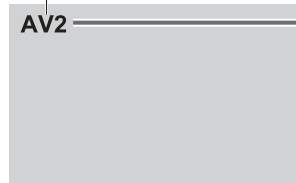

■ To return to TV



Note

- If the external equipment has an aspect adjustment function, set to "16:9".
- For details, see the manual of the equipment or ask your local dealer.



Screen display

Terminal	AV1	AV2	AV3	COMPONENT	PC	HDMI1	HDMI2	HDMI3
Manual input (default setting in "Input Labels")	AV1 AV1-RGB	AV2 AV2-S-Video AV2-RGB	AV3 AV3-S-Video	COMPONENT	PC	HDMI1	HDMI2	HDMI3
Auto input (EC mode or VIERA Link)	EC/AV1 EC/AV1-RGB	EC/AV2 EC/AV2-S-Video EC/AV2-RGB	—	—	—	EC/HDMI1 ● Applicable for EC mode and VIERA Link	EC/HDMI2 ● Applicable for VIERA Link	EC/HDMI3 ● Applicable for VIERA Link

Panasonic equipment connected to the TV can be directly operated with the remote control.

	VCR / DVD switch* Select VCR to operate Panasonic VCR or DVD equipment Select DVD to operate Panasonic DVD equipment or Player home theatre
	Standby Set to Standby mode / Turn on
	Play Playback videocassette / DVD
	Stop Stop the operations
	Rewind / Skip / Search VCR: Rewind, view the picture rapidly in reverse DVD: Skip to the previous track or title Press and hold to search backward
	Fast-forward / Skip / Search VCR: Fast-forward, view the picture rapidly forward DVD: Skip to the next track or title Press and hold to search forward
	Pause Pause / Resume DVD: Press and hold to play at slow speed
	Programme Up / Down Select programme
	Record Start recording

*Setting your remote control to operate Panasonic VCR, DVD, etc.

- Set the VCR / DVD switch to the appropriate position → 
- Press and hold  during the following operations

Enter the appropriate code for the equipment to be controlled, see table below



"VCR" position

Equipment	Code
VCR	10 (default)
DVD	11

"DVD" position

Equipment	Code
DVD	70 (default)
Player home theatre	71

Note

- Confirm if the remote control works correctly after changing the code.
- The codes will be reset to default values if batteries are replaced.
- "DVD" means DVD player, DVD recorders and Recorder home theatre.
- Some operations may not be possible on some equipment models.

How to Use Menu Functions

Various menus allow you to make settings for the picture, sound, and other functions.



1

Display the menu

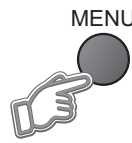

● Displays the functions that can be set (varies according to the input signal)

2

Select the menu



(example: Picture Menu)

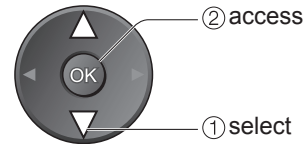

3

Select the item

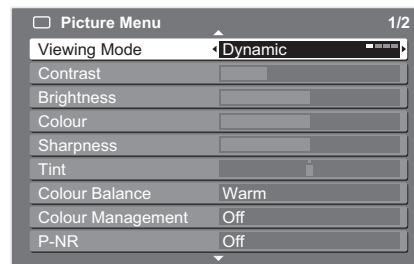

(example: Picture Menu)

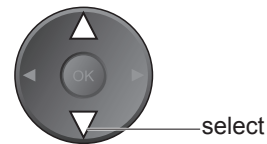

4

Adjust or select

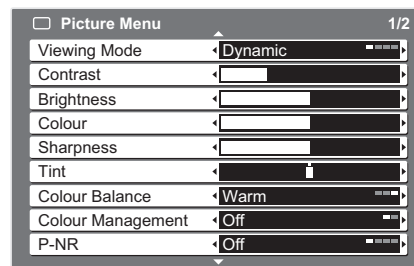

(example: Picture Menu)

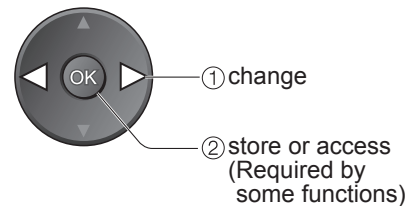

■ To return to TV at any time



■ To return to the previous screen



■ Choose from among alternatives

Number and positions of alternatives



■ Adjust using the slide bar



■ Go to the next screen

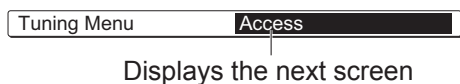

■ Enter characters using alpha / numeric keys

You can input information using alpha / numeric keys.



Set characters

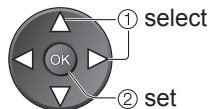

Store



■ To change menu pages

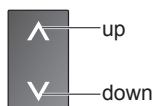

■ To reset the settings

- To reset the picture settings only
 - ➔ "Reset to Default" in Picture Menu (p. 26)
- To reset the sound settings only
 - ➔ "Reset to Default" in Sound Menu (p. 26)
- To reset the picture and sound settings together
 - ➔ **N** (Also volume level and aspect mode are reset)
- To initialize all settings
 - ➔ "Shipping Condition" in Setup Menu (p. 36)

How to Use Menu Functions

■ Menu list

Menu	Item	Adjustments / Configurations (alternatives)
VIERA Link	Pause Live TV	Controls the connected equipment with VIERA Link function, and enables various convenient recording, playback, etc. (p. 47 - 49) ● You can also access VIERA Link Menu directly using the VIERA Link button on the remote control.
	Direct TV Rec	
	VIERA Link Control	
	Speaker Selection	
Picture	Viewing Mode	Selects four different screen settings (Dynamic / Normal / Cinema / Eco) Dynamic : Provides enhanced picture contrast and sharpness when viewing in a bright room Normal : Recommended for viewing under normal ambient room lighting conditions Cinema : For watching movies in a darkened room producing a cinema-like picture Eco : Adjusts picture settings automatically dependent on ambient lighting conditions In each Viewing Mode setting, Contrast, Brightness, Colour, Sharpness, Tint, Colour Balance, Colour Management and 3D-COMB can be adjusted and stored to suit your particular viewing requirement (e.g., you may require different settings for viewing sports, films, news etc.) ● Set for each input signal ● Changes will be stored automatically
	Contrast, Brightness, Colour, Sharpness	Increases or decreases the levels of these options according to your personal preference
	Tint	With an NTSC signal source connected to the TV, the picture hue can be adjusted to suit your taste ● For NTSC signal reception only
	Colour Balance	Allows you to set the overall colour tone of the picture (Cool / Normal / Warm)
	Colour Management	Automatically adjusts colours to vivid ones (Off / On) ● Not valid on PC signal
	P-NR	Picture Noise Reduction Automatically reduces unwanted picture noise and flicker noise in the contoured parts of a picture (Off / Min / Mid / Max) ● Not valid on PC signal
	3D-COMB	Occasionally, whilst viewing still or slow moving pictures, colour patterning may be seen Set to "On" to display sharper and more accurate colours (Off / On) ● For PAL or NTSC signal reception only ● Not valid on RGB, S-Video, Component, PC, HDMI and SD Card
	Reset to Default	Press the OK button to reset the present Picture Mode to the default settings
Sound	Mode	Select two different sound settings (Music / Speech) In each Sound Mode setting, Bass and Treble can be adjusted and stored to suit your particular sound requirement Changes to any settings in a mode will affect all signal sources Sound quality can be improved
	Bass	Increases or decreases level to enhance or minimise lower, deeper sound output
	Treble	Increases or decreases level to enhance or minimise sharper, higher sound output
	Balance	Adjusts volume level of right and left speakers
	Headphone Volume	Adjusts the volume of the headphones
	Surround	Surround sound settings (Off / Simulated Surround / BBE ViVA) Simulated Surround: Provides a dynamic enhancer to simulate improved spatial effects BBE ViVA: BBE ViVA HD3D (High Definition 3D) Sound provides musically accurate natural 3D image with Hi-Fi sound. The clarity of the sound is improved by BBE while the width, depth and height of sound image are expanded by BBE's proprietary 3D sound process. BBE ViVA HD3D Sound is compatible with all TV programmes including news, music, dramas, movies, sports and electronic games. ● Switching is also possible by the Surround button on the remote control (p. 9).
	Volume Correction	Adjusts volume of individual programme or input mode
	Speaker Distance to Wall	Adjusts the low frequency sound (Over 30cm / Up to 30cm) ● If the back space between the TV and wall is over 30 cm, "Over 30cm" is recommended. ● If the back space between the TV and wall is within 30 cm, "Up to 30cm" is recommended.
	Preferred Multi Audio	Selects the preferred language for DVB multi audio (depending on the broadcaster)
	NICAM	NICAM (Near Instantaneous Companded Audio Multiplex) A format for digital sound over television Reproduces stereo sound (Off / On) ● Off if reception is poor (FM monaural sound) ● Analogue mode only
	HDMI1 / 3 Input	Select to fit the input signal (Auto / Digital / Analogue) (p. 52) Auto : Automatic detection of digital or analogue sound source Digital : HDMI cable connection Analogue : HDMI-DVI adapter cable connection ● HDMI input mode only ● HDMI2 terminal is for digital signal only ● No setting for HDMI2 available
	Audio Description Menu	Audio Description
Volume		Adjusts the volume for audio description
Speakers		Set to "On" to activate the description sound track from TV speakers (Off / On)
Headphones		Set to "On" to activate the description sound track from headphones (Off / On)
Reset to Default	Press the OK button to reset the present Sound Mode to the default settings ● Effective to Bass, Treble, Balance, Headphone Volume and Surround	

■ Menu list

Menu	Item	Adjustments / Configurations (alternatives)	
Setup	Timer Programming	Records forthcoming programmes (p. 40)	
	DVB Profile Edit	Creates list of favourite programmes (p. 32)	
	DVB Service List	Skips the unwanted DVB programmes (p. 33)	
	Analogue Service List	Skips the unwanted Analogue programmes or edits Analogue programmes (p. 33)	
	Link Settings	VIERA Link	Sets to use VIERA Link functions (Off / On) (p. 46)
		Q-Link	Selects which AV terminal is to be used for data communication between this TV and a compatible recorder (AV1 / AV2) (p. 45) ● Select the connected terminal to the recorder even it is not compatible with Q-Link.
		AV1 / AV2 out	Chooses the signal to be transmitted from the TV to Q-Link (TV / AV1 / AV2 / AV3 / Monitor) ● Monitor: Image displayed on screen ● Component, PC and HDMI signals cannot be outputted.
		Q-Link Download	Downloads analogue programme information to a Q-Link compatible equipment connected to the TV
	Child Lock	Locks a programme / AV input to prevent access to it (p. 33)	
	Tuning Menu	Auto Setup	Automatically sets the programmes received in the area (p. 35)
		DVB Manual Tuning	Sets the DVB programmes manually (p. 35)
		Analogue Manual Tuning	Sets the Analogue programmes manually (p. 35)
		Add New DVB Services	Adds new DVB services (p. 35)
		New Service Message	Selects whether to give a notification message when a new DVB service is found (p. 35)
		DVB Signal Condition	Checks the DVB signal condition (p. 35)
	Intelligent Frame Creation	Automatically compensates the picture frame rate to make the image smooth (Off / On) ● 24p or 50i/p input signals are recommended for using this function. ● Not valid on PC and SD Card	
	GUIDE Plus+ Settings	Postcode	Sets your postcode to display advertisements in the GUIDE Plus+ system (p. 20)
		System Information	Displays the system information of the GUIDE Plus+ system
	Off Timer	Sets the time the TV automatically turns Off (Off / 15 / 30 / 45 / 60 / 75 / 90 minutes)	
	Power on Preference	Set to "TV" to view picture from TV tuner. Set to "AV" to view input from an external equipment connected to a SCART terminal, e.g. satellite receiver (TV / AV) ● The external equipment must be switched on and sending a control signal for automatic switching at power on to occur.	
	Teletext	Analogue teletext display mode (FASTTEXT / List) (p. 18)	
	Preferred Subtitles	Selects the preferred language for DVB subtitles (depending on the broadcaster) ● To display subtitles → p. 14	
	Shipping Condition	Resets all settings, for example, when moving house (p. 36)	
	Owner ID	Inputs the owner ID (p. 37)	
	Common Interface	Uses include to watch pay-TV (p. 31)	
	System Update	Downloads new software to TV (p. 31)	
	Power Save	Reduces brightness of picture to economise on power consumption (Off / On)	
Side Panel	Increases the brightness of the side panel (Off / Low / Mid / High) ● The recommended setting is "High" to prevent panel "image retention".		
Picture Overscan	Selects the screen area displaying the image (Off / On) On : Enlarged the image to hide the edge of the image. Off : Displayed the image in the original size. ● Set to "On" if noise is generated on the edge of the screen. ● This function is available when aspect is set to Auto (16:9 signal only) or 16:9. ● This function can be memorized separately for SD (Standard definition) and HD (High definition) signals.		
Input Labels	Labels or skips each input terminal (p. 38)		
Banner Display Timeout	Sets how long the information banner (p. 15) stays on screen ● 0 (No display) to 10 sec. in 1-sec. increments		
Software Licence	Displays the software licence information		
System Information	Displays the system information of this TV		

- A different menu will be displayed while PC or SD Card is used. (p. 39 and p. 43)
- Only available items can be selected.

How to Use Menu Functions

Overview

How to operate (p. 24)

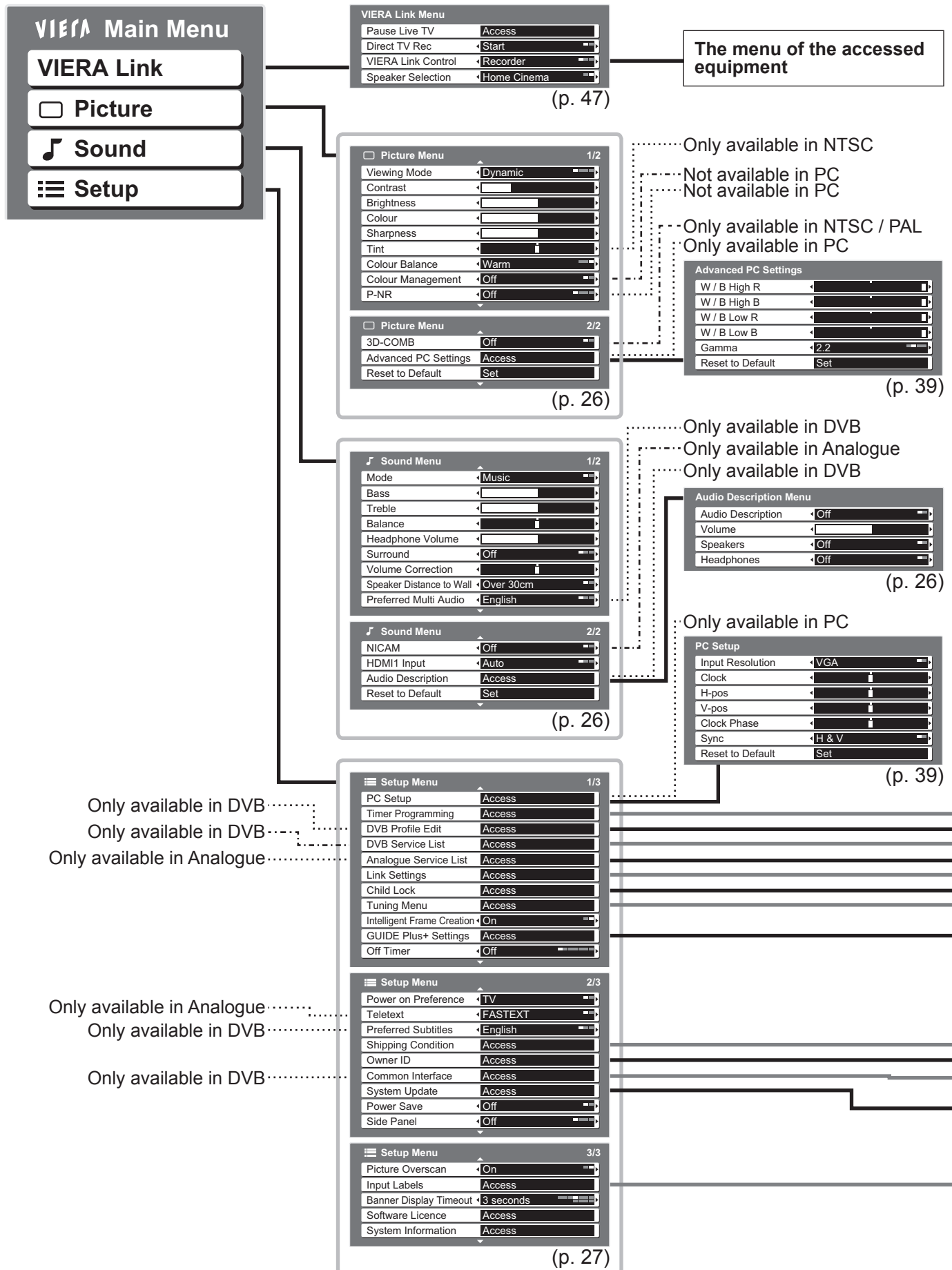

Timer Programming Wed 05/05/04 18:50

Pos.	Name	Date	Start	End	min.	
D 1	BBC1	6/8 FR	18:00	20:00	120	Off
D 1	BBC1	7/8 SA	21:30	22:30	60	Off
D 3	ITV1	7/8 SA	22:30	23:30	60	Off
---	---	---	---	---	---	---

(p. 40)

Profile Editor

All DVB Services	Profile 1
1 BBC One Wales	
7 BBC THREE	
14 E4	
70 CBBC Channel	
72 Cartoon Nwk	
105 BBCi	
719 BBC Radio Wales	
720 BBC Radio Cymru	

(p. 32)

DVB Service List

70 CBBC Channel	<input checked="" type="checkbox"/>
72 Cartoon Nwk	<input checked="" type="checkbox"/>
105 BBCi	<input checked="" type="checkbox"/>
719 BBC Radio Wales	<input type="checkbox"/>
720 BBC Radio Cymru	<input type="checkbox"/>
1 BBC ONE Wales	<input checked="" type="checkbox"/>
7 BBC THREE	<input checked="" type="checkbox"/>

(p. 33)

Analogue Service List

1 BBC1	<input checked="" type="checkbox"/>
2 *****	<input type="checkbox"/>
3 *****	<input type="checkbox"/>
4	<input type="checkbox"/>
5	<input type="checkbox"/>
6	<input type="checkbox"/>
7	<input type="checkbox"/>

(p. 33)

Link Settings

VIERA Link	On
Q-Link	AV2
AV2 out	TV
Q-Link Download	Access

(p. 27)

Child Lock

Change PIN	Access
Child Lock List	

(p. 33)

Only available in DVB
Only available in Analogue
Only available in DVB
Only available in DVB
Only available in DVB

Tuning Menu

Auto Setup	Access
DVB Manual Tuning	Access
Analogue Manual Tuning	Access
Add New DVB Services	Access
New Service Message	On
DVB Signal Condition	Access

(p. 34)

Auto Setup - Digital

Channel	Service Name	Type	Quality
62	CBBC Channel	Free TV	10
62	BBC Radio Wales	Free TV	10
62	E4	Free TV	10
62	Cartoon Nwk	Free TV	10

Free TV: 4 Pay TV: 0 Radio: 0 Data: 0 Searching

(p. 35)

DVB Manual Tuning

Frequency	Signal Quality	Signal Strength	Position	Service Name	Type	New
474 MHz	10	10	0			

Free TV: 0 Pay TV: 0 Radio: 0 Data: 0 Stopped

(p. 35)

Analogue Manual Tuning

1 BBC1	CH33
Manual Tuning	21

(p. 35)

Add New DVB Services

Channel	Service Name	Type	Quality
---------	--------------	------	---------

Free TV: 0 Pay TV: 0 Radio: 0 Data: 0 Searching

(p. 35)

DVB Signal Condition

DVB Programme	[CH70] CBBC Channel
Signal Quality	0 10
Signal Strength	0 10

(p. 35)

GUIDE Plus+ Settings

Postcode	Access
System Information	

(p. 27)

Shipping Condition
All tuning data will be erased
Are you sure?
Are you sure?

(p. 36)

Owner ID

Please enter new PIN	
PIN	*****

(p. 37)

Common Interface

Slot 1:	Module inserted
---------	-----------------

(p. 31)

System Update

Auto Update Search in Standby	On
System Update Search Now	

(p. 31)

Input Labels

AV1	DVD
AV2/S	AV2/S
AV3/S	AV3/S
COMPONENT	COMPONENT
PC	PC
HDMI1	HDMI1
HDMI2	HDMI2
HDMI3	HDMI3

(p. 38)

DVB Settings (DVB mode)

DVB Settings provide access to various advanced features.

1 If in Analogue mode
Select DVB

2 Display the menu

3 Select "Setup"

4 Select "Common Interface" or "System Update"

5 Set

■ To return to TV
EXIT

VIFF Main Menu

VIERA Link
Picture
Sound
Setup

Setup Menu 2/3

Power on Preference	TV
Teletext	FASTEXT
Preferred Subtitles	English
Shipping Condition	
Owner ID	
Common Interface	Access
System Update	Access
Power Save	Off
Side Panel	Off

Pay-TV

Common Interface

The Common Interface Module menu provides access to software contained on Common Interface (CI) Modules.
This TV receiver works only Pay TV modules complying with CI standard.

Caution

- Turn Off Mains power On / Off switch whenever inserting or removing the CI module.
- If a view card and a card reader come as a set, first insert the card reader, then insert the view card into the card reader.
- Do not insert the module up side down.

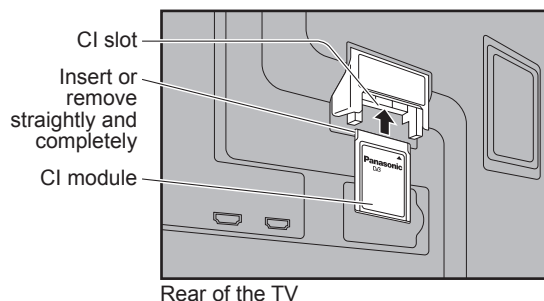

① Insert the CI module (optional)

- The features that appear on screen are dependent on the contents of the selected CI module.
- Normally pay-TV services will appear without ② and ③. If pay-TV service does not appear, perform ② and ③.
- For more details, see the manual of the CI module, or check with the broadcaster.

② Access "Common Interface"

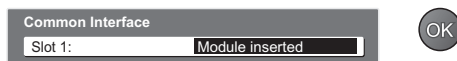

③ Follow the on-screen instructions



- On-screen operation guide may not correspond to the remote control buttons.

Download new software to TV.

- For details → p. 53

If System Update is performed, the software will be updated (it may change TV functions). If you do not wish to do so, set "Auto Update Search in Standby" to Off.

Select "Auto Update Search in Standby" and then set "On" or "Off"

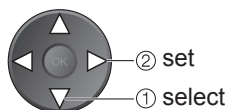
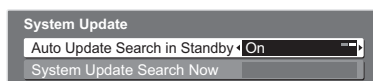

- On: Automatically performs a search in standby and downloads an update, if any software updates are available

■ To update immediately

Select "System Update Search Now"

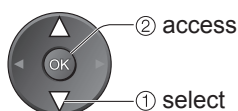

Searches for an update (for several mins.) and displays a corresponding message if any

Download



- Download may take for about 20 mins.

Update TV's software system

System Update

Editing Programmes

You can make your favourite programme lists, skip unwanted programmes and control programme audience, etc.

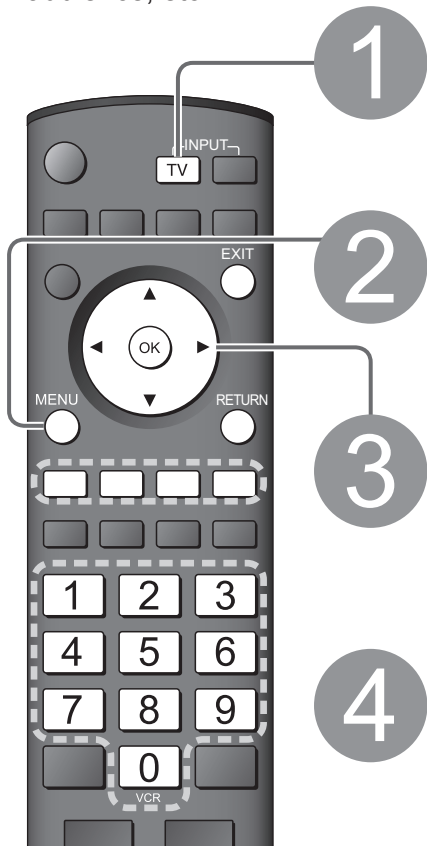

1 Select DVB or Analogue



- "DVB Profile Edit" and "DVB Service List" are available in DVB mode only.
- "Analogue Service List" is available in Analogue mode only.

2 Display the menu

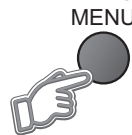

3 Select "Setup"

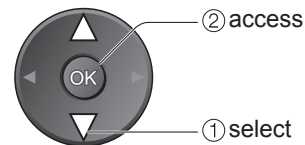
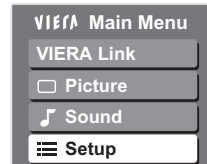

4 Select "DVB Profile Edit", "DVB Service List", "Analogue Service List" or "Child Lock" and set

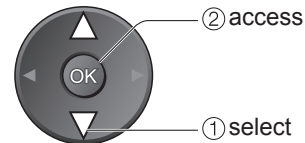
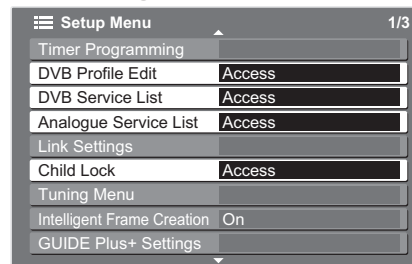

To return to TV



Create your favourite programme list (Profile) from various broadcasters (up to 4: Profile 1 to 4). The list is added to "Category" in TV Guide (p. 20) and information banner (p. 15) and then easily accessed.

Select a programme and add it to the list

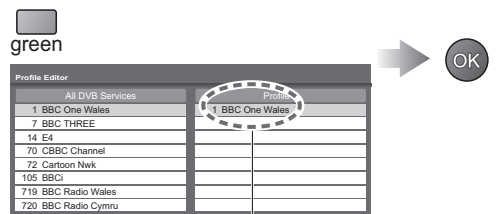
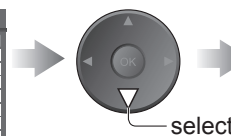
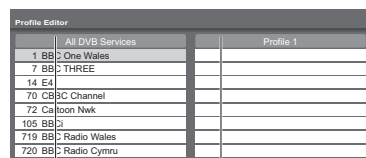

- To change the category → red
- To display another Profile → blue

- To add all programmes to the list → yellow

A programme is added

List favourite programmes

DVB Profile Edit
(DVB mode)

To edit Profile



Select the field of Profile to edit and:

- To name the Profile → red → Select the character → OK → RETURN
- To move the programme → green → Select the new position → Confirm → green → OK
- To delete the programme → yellow → OK
- To delete all programmes → blue → OK

Note

- Programme numbers (known as logical channel numbers) cannot be changed, due to broadcast restrictions.

Skip unwanted programmes

DVB Service List

Analogue Service List

You can hide unwanted services. The deleted services cannot be displayed except in this function. Use this function to skip unwanted programmes.

- "DVB Service List" lists all tuned DVB programmes in DVB mode.
- "Analogue Service List" lists all tuned Analogue programmes in Analogue mode.

Select a service and add / delete

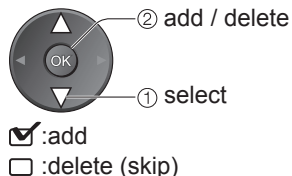
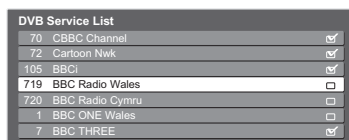

- To retune each programme (Manual Tuning) → red (p. 35)

- :add
- :delete (skip)

Edit analogue programmes (Change name, Move)

Analogue Service List

You can change the programme name and programme position for Analogue programmes.

- This function is available in Analogue mode.
- If a VCR is connected only with the RF cable, edit "VCR".

① Select the programme to edit

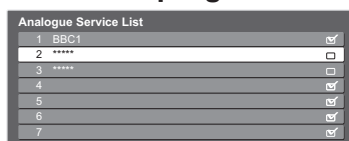

Programme position

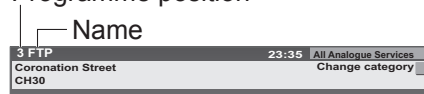

② Edit

■ To change the name displayed when selecting programmes

Select "Rename"



Set characters

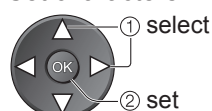

(maximum: five characters)

Store



■ To move the programme position

Select new position



Store



Control programme audience

Child Lock

You can lock specific programmes / AV input terminals and control who watches them. (When the locked programme / input is selected, a message appears; by entering the PIN number, you can watch it.)

① Enter the PIN number (4 digits)

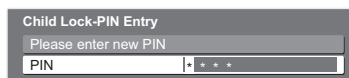

- Enter the PIN number twice at first setting.
- Make a note of the PIN number in case you forget it.

② Select "Child Lock List"

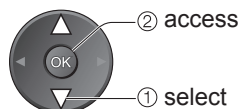

③ Select the programme / input to be locked

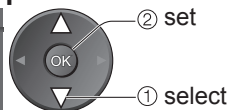
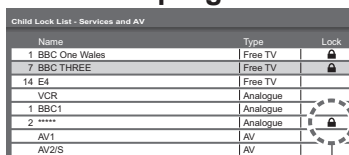

- To cancel → Select the locked programme / input



- To lock all → yellow

- To cancel all locks → blue

Appears when the programme / input is locked

■ To change the PIN number

Select "Change PIN" in ② and enter a new PIN number twice.

Note

- Setting "Shipping Condition" (p. 36) erases the PIN number and all settings.

Tuning Programmes

You can retune all the TV programmes when moving house or search for new services which may have recently started broadcasting.

1 Select DVB or Analogue

- “DVB Manual Tuning”, “Add New DVB Services”, “New Service Message” and “DVB Signal Condition” are available in DVB mode only.
- “Analogue Manual Tuning” is available in Analogue mode only.

2 Display the menu

3 Select “Setup”

VIERA Main Menu
VIERA Link
Picture
Sound
Setup

4 Select “Tuning Menu”

Setup Menu	1/3
Timer Programming	
DVB Profile Edit	
DVB Service List	
Link Settings	
Child Lock	
Tuning Menu	Access
Intelligent Frame Creation	On
GUIDE Plus+ Settings	
Off Timer	Off

5 Select a function

Tuning Menu	
Auto Setup	Access
DVB Manual Tuning	Access
Analogue Manual Tuning	Access
Add New DVB Services	Access
New Service Message	On
DVB Signal Condition	Access

6 Set _____

■ To return to TV
EXIT

■ For Auto Setup, using the buttons on the side of the TV (p. 9)

- ① Press repeatedly until “Auto Setup” appears
■ F
- ② Access “Auto Setup”
■ TV
- ③ Start “Auto Setup”
■ TV

● To return to TV → ■ F

Set all DVB or Analogue programmes automatically

Auto Setup

Automatically retune all DVB or Analogue programmes received in the area.

- Only DVB programmes are retuned in DVB mode.
- Only Analogue programmes are retuned in Analogue mode.
- If a Child Lock PIN number (p. 33) has been set, it must be entered.

Start Auto Setup

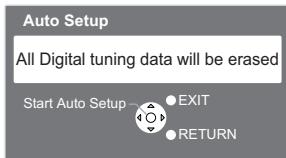

Settings are made automatically

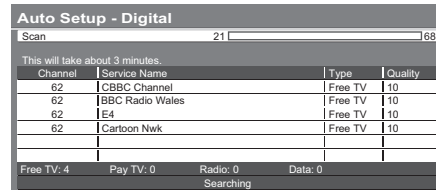

- All the previous tuning settings are erased.
- The analogue settings are downloaded to a Q-Link compatible equipment connected to the TV in Analogue mode.
- When the operation is completed, the programme at programme position "1" will be displayed.
- If tuning has not been done completely → "DVB Manual Tuning", "Analogue Manual Tuning"

Set DVB programme manually

DVB Manual Tuning

Normally use "Auto Setup" or "Add New DVB Services" to add DVB programmes to your service list. If tuning has not been done completely or for adjusting the direction of the aerial, use this function.

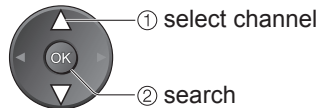
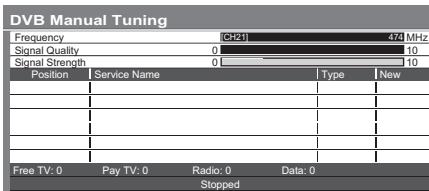

- All services found will be added to the DVB Service List.

Set Analogue programme manually

Analogue Manual Tuning

Set Analogue programme manually after Auto Setup.
 ● If a VCR is connected only with the RF cable, select programme position "0".



Select the programme position



Select the programme



Search and store

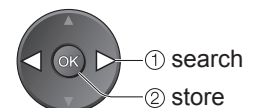

Add DVB programme automatically

Add New DVB Services

Any new services found will be added to the DVB Service List.

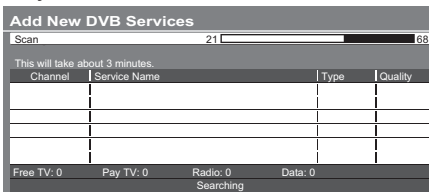

- The new service is added with the current settings saved as they are.

Display a notification message

New Service Message

Selects whether to give a notification message when a new DVB service is found. **(Off / On)**

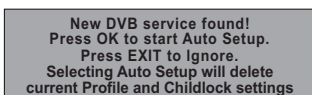

- Selecting OK (Auto Setup) will delete the current Profile and Childlock settings.

Check DVB signal

DVB Signal Condition

Selects a programme and checks the DVB signal condition.

- To change the programme

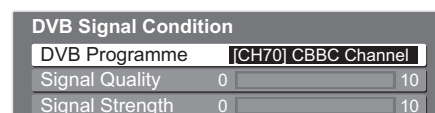

A good Signal Strength is not an indication of suitable signal for DVB reception. Please use the Signal Quality indicator as follows:

Signal Quality:

- Green bar → Good
- Yellow bar → Poor
- Red bar → Bad (Check the aerial)

Restore Settings

Resets the TV to its original condition, i.e. no programmes tuned in. All settings other than "Owner ID" (programmes, picture, sound quality, etc.) are reset.

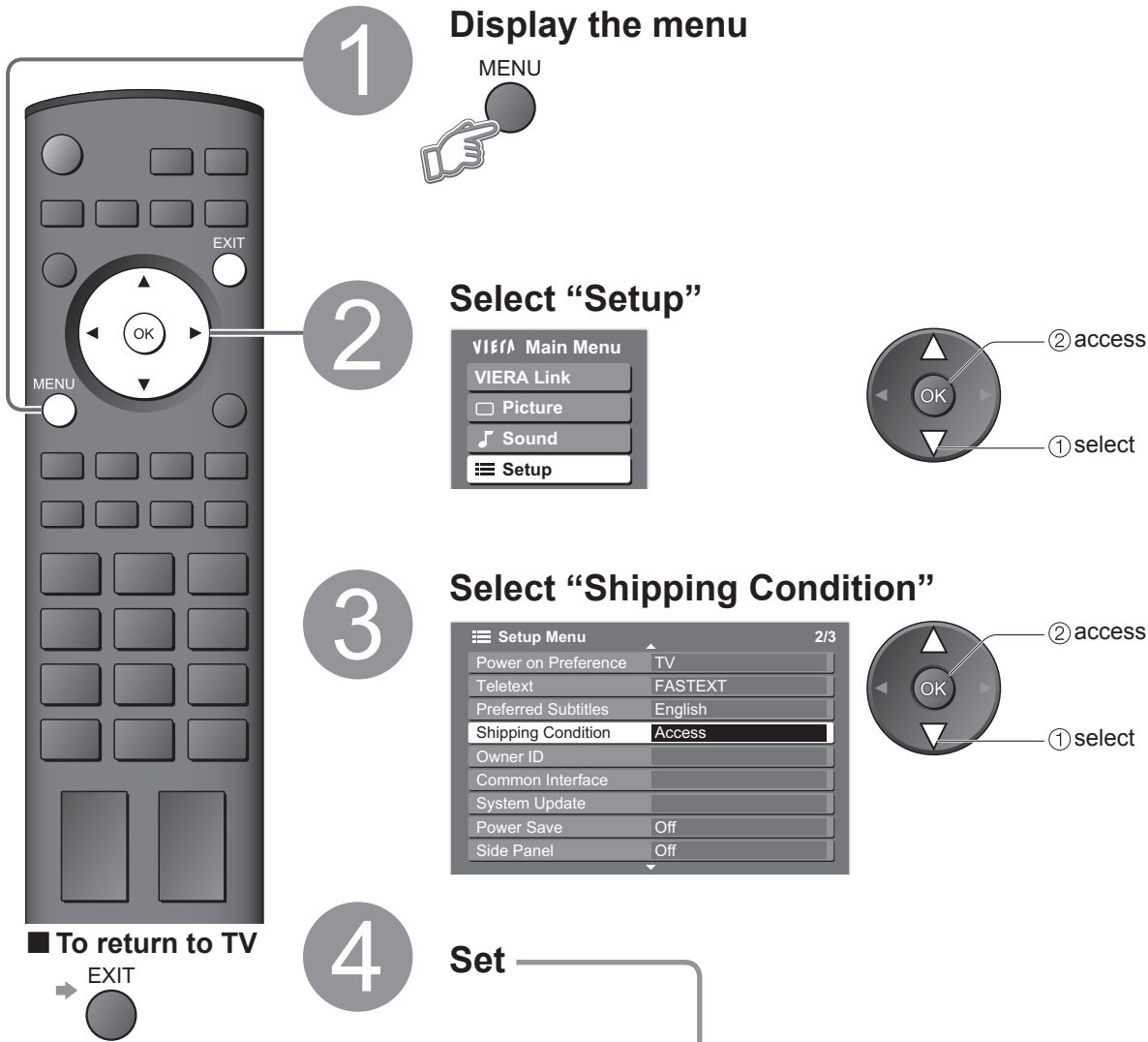

Restore Settings

Shipping Condition

① **Check the message and initialise**

Shipping Condition

All tuning data will be erased
Are you sure?
Are you sure?

Confirm → ● EXIT
● RETURN

● OK

② **Follow the on-screen instructions**

- "Auto Setup" will automatically start when Mains power On / Off switch is next turned On. (p. 12)

■ **To retune TV programmes only, e.g. after moving house**

- ➔ "Auto Setup" (p. 35)

Owner ID

Entry of the security code (PIN number) and “personal information” (your name, address and postcode). In the unfortunate event of theft it will help the Police to determine the owner.
 If you have skipped the Owner ID input in “Auto Setup” (p. 12), and input it later, start from ①.
 If you input the Owner ID in “Auto Setup” (p. 12), perform ④.

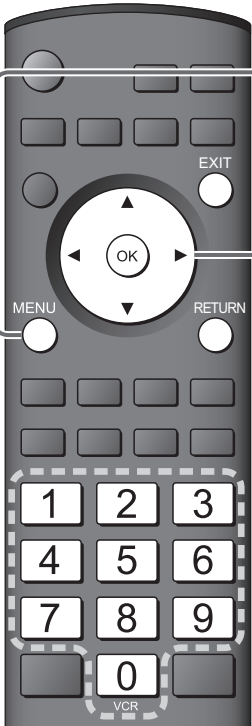

1

Display the menu

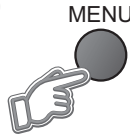

2

Select “Setup”

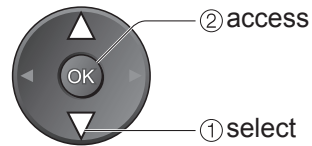
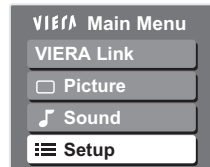

3

Select “Owner ID”

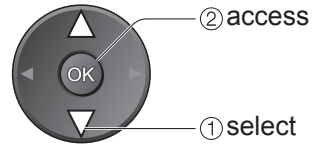
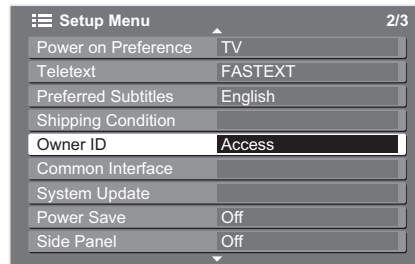

To return to TV



4

Set

● Owner ID
● Restore Settings

Input owner ID

Owner ID

① Enter the PIN number (4 digits)

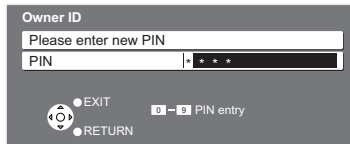

- Enter the PIN number twice at first setting.
- Make a note of the PIN number in case you forget it.

② Enter your name, address, and postcode, in that order

- Select the entry field
- Enter the “User input” mode
- Select the character
- Set
- Store

To check the “personal information” stored

Hold down for about 6 sec.

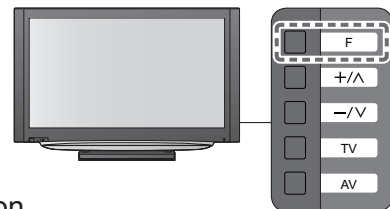

Displays the information on the screen (for several sec.)

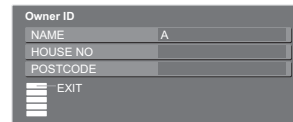

- The PIN number is not displayed.

To change the PIN number

- Select the “PIN” field

➔ Enter a new PIN number twice

Advanced

Input Labels

For easier identification and selection of the input mode, you can label each input terminals or skip terminal that is not connected to any equipment.

- To select the input mode → p. 22

1 Display the menu
 MENU

2 Select "Setup"
 VIERA Main Menu
 VIERA Link
 Picture
 Sound
 Setup

3 Select "Input Labels"
 Setup Menu 3/3
 Picture Overscan On
 Input Labels Access
 Banner Display Timeout 3 seconds
 Software Licence
 System Information

4 Select a input terminal and set
 Input Labels
 AV1 DVD
 AV2/S AV2/S
 AV3/S AV3/S
 COMPONENT COMPONENT
 PC PC
 HDMI1 HDMI1
 HDMI2 HDMI2
 HDMI3 HDMI3

■ To return to TV



The labels you set will be displayed in "Input Selection" menu (p. 22) or banner.
 ● If "Skip" is selected, you cannot select the mode.

■ User input

You can name each input terminals freely.

Select "User input"

Set characters

Store

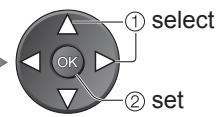
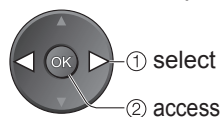

(maximum: ten characters)

Displaying PC Screen on TV

The screen of the PC connected to the TV can be displayed on the TV.
You can also listen to PC sound with the audio cable connected.

- To connect PC → p. 50

1 Select the external input

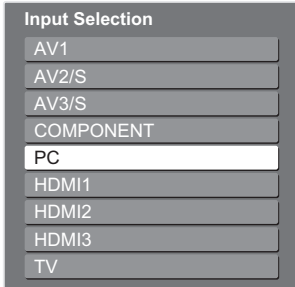
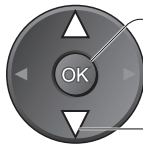

2 Select "PC"

② access
① select

- Corresponding signals → p. 54
- If "H-freq." or "V-freq." is shown in red, the signals may not be supported.

■ To return to TV



■ PC menu setting (changed as desired)

- To make settings → "How to Use Menu Functions" ① to ④ (p. 24)

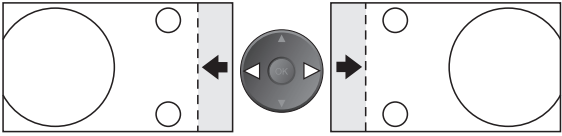
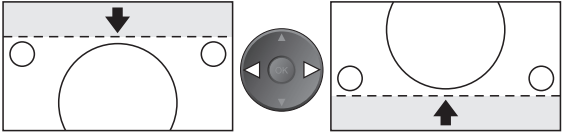
Menu	Item	Adjustments / Configurations (options)
Picture	W/B High R	White balance of bright red area
	W/B High B	White balance of bright blue area
	W/B Low R	White balance of dark red area
	W/B Low B	White balance of dark blue area
	Gamma	(S Curve / 2.0 / 2.2 / 2.5)
	Reset to Default	Press the OK button to reset to the default Picture settings
Setup	Input Resolution	Switches to a wide view ● VGA (640 × 480 pixels), WVGA (852 × 480 pixels), XGA (1,024 × 768 pixels), WXGA (1,366 × 768 pixels) ● Options change depending on signals
	Clock	Set to the minimum level if noise occurs
	H-pos	Adjusts horizontal position 
	V-pos	Adjusts vertical position 
	Clock Phase	Eliminates flicker and distortion ● Adjust after Clock adjustment ● Set to the minimum level if noise occurs
	Sync	Chooses another synchronous signal if the image is distorted (H & V / On G) ● H & V : by the horizontal and vertical signals from your PC On G : by the green signal from your PC (if available)
	Reset to Default	Press the OK button to reset to the default Setup settings

- Other items → p. 26 and p. 27

Recording Controls

Timer Programming from Menu

The Timer programming menu allows you to choose programmes that you wish to record. At the correct time, the TV will switch on and tune to the correct programme (even if the TV is in Standby mode). TV Guide may also be used to set timer programming. (p. 20)

- If the recorder is compatible with Q-Link or similar technologies (p. 45), and setup / connection are done completely (p. 44 and p. 45), you do not need to programme the recorder – the TV will control the recording progress.
- If the recorder is not compatible with Q-Link or similar technologies, set “Q-Link” in Setup Menu (p. 27) to the connected terminal (AV1 or AV2), and make timer programming of the recorder (Read the manual of the recorder).
- “D” means DVB programme and “A” means Analogue programme.

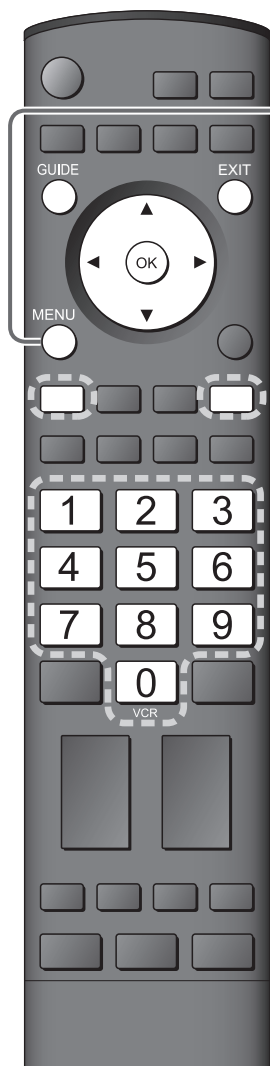

1

Display the menu

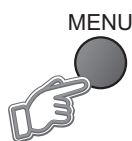

2

Select “Setup”

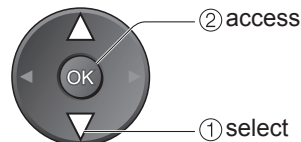
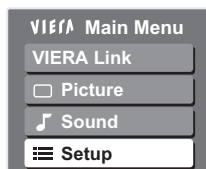

3

Select “Timer Programming”

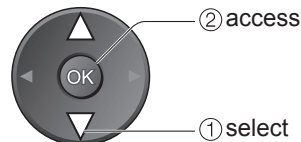
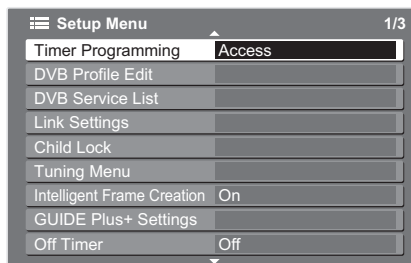

4

Set

5

Store



To return to TV



To stop recording



Caution

- The TV must either be On or in standby.
- For preparations of a recorder, read the manual of the recorder.
- No other programme can be selected during recording.
- It may not be possible to record an encrypted programme (which is copy-protected).

Set timer programming details

① Start making the settings



② Repeat the operations as below, and set items in the order of ① to ⑤



select the item



set

● ①, ③ and ④ can also be entered with numeric buttons.

Timer recording
Records according to the time setting

Guide: Event recording
Records according to the TV Guide signal (p. 21)

S/P: Split Programme (p. 21)

Pos.	Name	Date	Start	End	min.	
D 7	BBC THREE <TIMER>	6/8 FR	17:00	18:30	90	Off
D 1	BBC1 Holiday News	6/8 FR	18:00	20:00	120	Off
D 3	ITV1 Freshly Squeezed Extra	7/8 SA	21:30	22:30	60	Off
...

Displayed if the timer programming events are overlapped

Current timer programming event

① Programme

② Date

③ Starting time

④ Ending time

⑤ Subtitles (Off / Auto)

● Recording time (automatic display)

● one day ahead

● daily or weekly (press repeatedly)

● Daily SU-SA: Sunday to Saturday

● Daily MO-SA: Monday to Saturday

● Daily MO-FR: Monday to Friday

● Weekly SA/FR/TH/WE/TU/MO/SU: Same time on the same day every week

■ To change a timer programming event

- ➔ Select the programme to be changed
- ② access
- ① select
- ➔ Correct as necessary (as above)

■ To cancel a timer programming event

- ➔ Select the programme to be deleted
- red
- OK

■ To cancel a timer programming event temporarily

- ➔ Select the programme to be cancelled
- blue
- Each time pressed: cancel ↔ stop cancelling

■ To view details of the programming

- ➔ Select the programme to be viewed
- i
- Press again to return to Timer Programming menu.

■ Event recording (Timer Programming from TV Guide-EPG) ➔ p. 21

Event recording is a timer programme controlled by information from the TV Guide.

Programme start and end times may be changed by broadcasters and sent to the TV for timer programme to follow the change.

Split Programme is a programme which is interrupted by one or more events.

Both of the above are subject to signals being sent by broadcasters.

■ Direct TV Recording ➔ p. 45 and p. 47

You can record the current programme to DVD Recorder / VCR immediately.

Note

- Check that the Timer LED (Orange) is lit. If not, timer programmes are not active or not stored.
- "!" will identify any timer events that have been set and overlap. If this occurs then the first event will start and finish as programmed. The next timer event can then start.
- 2 mins. before the starting time: a reminder message appears.
(To remove the message ➔ OK; To cancel the programming ➔ EXIT)
- A Timer Programming event will automatically change to the desired programme 10 seconds before the start time.
- To stop Timer Programming event directly prior to the start time, it is necessary to stop the recorder manually.
- Timer Programming will be performed even if the TV is in Pause Live TV recording (p. 47). In this case, Pause Live TV recording will be cancelled.

Viewing from SD Card

Still images recorded by digital cameras will be displayed.

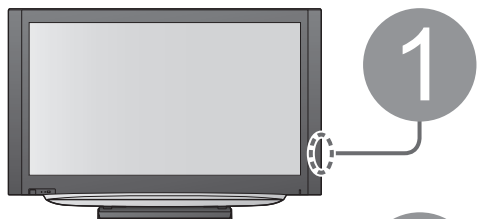

1 Insert the SD Card

Signal output from all AV terminals will be disabled during SD card view.
Press OK to proceed.
Press EXIT to return to TV viewing.

- Warning message for output signal is displayed.

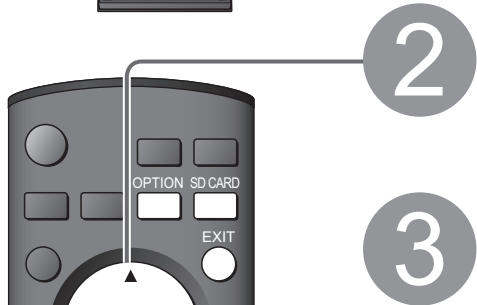

2 Enter SD mode (Photo View Mode)



- All photos in SD Card are displayed by thumbnail.

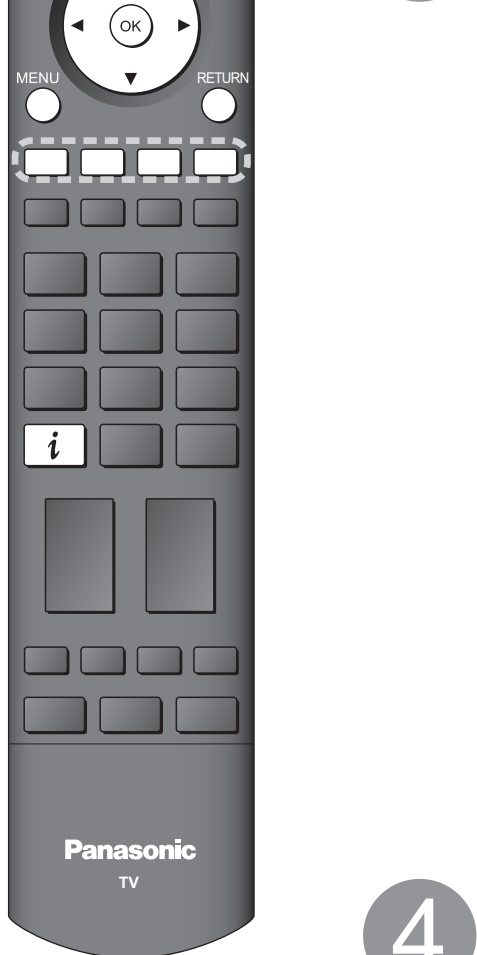

3 Select the photo to be viewed

Selected photo Error display (images that could not be loaded, etc.)

Photo View Mode
All pictures
1/175

Filename p1010001
Date 23/10/2007
Pixel 1600 x 1200

Reading
View Select MENU
EXIT Select RETURN

Slide show Sort by Month Sort by Date

(Thumbnail)

① select
② view

Slide show → p. 43

Selected photo information is displayed

- The maximum number of characters for Filename is 8.
- The photo without record of the date is shown "*****/*****".

To sort by date or month recorded

(Sort by Month / Sort by Date)

Display the thumbnail grouped by the same date or the same month

(Sort by Month)
yellow

(Sort by Date)
blue

Select the group to be viewed

① select
② view the thumbnail of the selected group

Note

- The group of the photos without record of the date is shown as "Unknown".

To return to TV

EXIT or SD CARD



4 View

To display the operation guide

Displayed one at a time

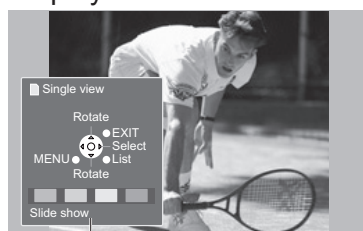

Operation guide

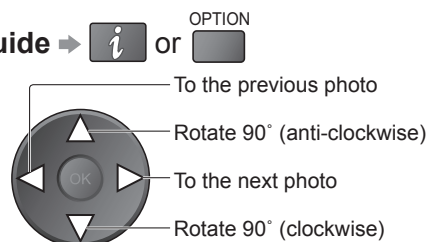

- To return to thumbnail



Caution

- During the operation, no signals are output from the monitor output terminals.

(Photos)

SD Card

● For details on SD Cards → p. 53

■ **To insert**

■ **To remove**

Slide show

■ **Start Slide show** (operate in step ③ or ④)

- ① Select the photo for the first view ② Start Slide show



● To pause →

● To return to Single view →

Note

● A Slide show will be completed within the group from which it was started.

■ **Slide show settings** (operate in step ③ or ④)

- ① Display the menu ② Select "Viewing Setup" ③ Select the items and set

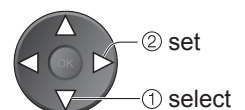
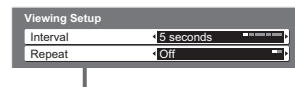
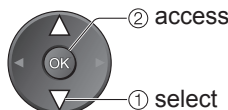

● "Picture Menu" (p. 26)

Menu	Item	Adjustments / Configurations (alternatives)
Viewing Setup	Interval	Select slide show interval (5 / 10 / 15 / 30 / 60 / 90 / 120 seconds)
	Repeat	Slide show repeat (Off / On)

Cautions in handling SD Card

- Do not remove the card while the TV is accessing data (this can damage card or TV).
- Do not touch the pins on the back of the card.
- Do not subject the card to a high pressure or impact.
- Insert the card in the correct direction (otherwise, card may be damaged).
- Electrical interference, static electricity, or erroneous operation may damage the data or card.
- Back up the recorded data at regular intervals in case of deteriorated or damaged data or erratic operation of the TV. (Panasonic is not liable for any deterioration or damage of recorded data.)

On screen messages

Message	Meaning / Action
Cannot read file	<ul style="list-style-type: none"> ● The file is broken or unreadable. ● The TV does not support the format. (For the applicable formats and data, see p. 53.)
Is SD Card in?	<ul style="list-style-type: none"> ● Confirm SD Card is inserted correctly.
No valid file to play	<ul style="list-style-type: none"> ● The card has no data.
Over 9999 pictures found	<ul style="list-style-type: none"> ● Maximum valid number of photos is 9,999.

Viewing from SD Card (Photos)

Advanced

Link Functions (Q-Link VIERA Link)

Q-Link connects the TV and DVD Recorder / VCR, and enables easy recording, playback, etc. (p. 45)
 VIERA Link (HDAVI Control™) connects the TV and the equipment with VIERA Link function, and enables easy control, convenient recording, playback, etc. (p. 46 - 49)
 You can use Q-Link and VIERA Link functions together.

Summary of Q-Link and VIERA Link functions

Features	Connection	Q-Link (SCART connection)	VIERA Link (HDMI connection only)	VIERA Link (SCART and HDMI connection)
Analogue programme download		○	—	○
Easy playback***		○	○	○
Power on link***		○	○	○
Power off link***		○	○	○
Speaker control***		—	○	○
Control the menu of the connected equipment by VIERA remote control		—	○*	○*
Direct TV Recording		○	—	○**
Pause Live TV programme		—	—	○**

* : Available with the equipment which has “HDAVI Control 2” or “HDAVI Control 3” function.

** : Available with the equipment which has “HDAVI Control 3” function.

*** : These features may be available even with other manufacturers’ equipment supporting HDMI CEC.

Connections

Read the manual of the equipment, too.

Q-Link

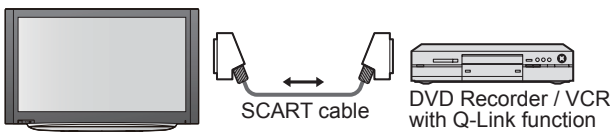

- Connect the DVD Recorder / VCR supporting Q-Link to the TV’s AV1 or AV2 terminal via a fully wired SCART cable.

VIERA Link

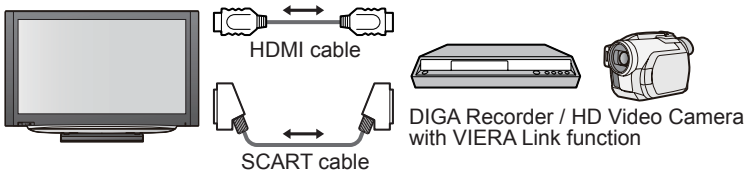

- Connect the equipment supporting VIERA Link to the TV’s AV1, AV2, HDMI1, HDMI2 or HDMI3 terminals via fully wired SCART and HDMI cables together.
- Some functions are available only with HDMI cable connection. But use both HDMI and SCART cables to support many features normally.

- SCART cable
Use fully wired SCART cable.
- HDMI cable
Use fully wired HDMI compliant cable. Non-HDMI-compliant cables cannot be utilized.
Recommended Panasonic’s HDMI cable part number:
 • RP-CDHG10 (1.0 m)
 • RP-CDHG15 (1.5 m)
 • RP-CDHG20 (2.0 m)
 • RP-CDHG30 (3.0 m)
 • RP-CDHG50 (5.0 m)

For Speaker control (Home Cinema)

- To use Amplifier

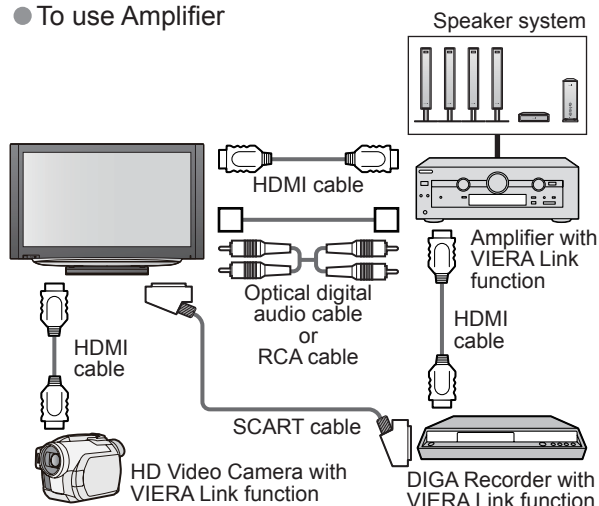

- To use Player theatre

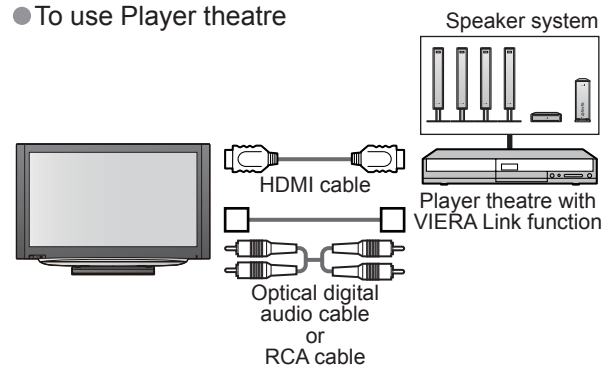

Q-Link

■ Preparations

- Connect the DVD Recorder / VCR with the following logos: "Q-Link", "NEXTVIEWLINK", "DATA LOGIC", "Easy Link", "Megalogic" or "SMARTLINK"
- Q-Link connection → p. 44
- Set up the DVD Recorder / VCR. Read the manual of the equipment.
- Q-Link terminal setup in Setup Menu → "Q-Link" (p. 27), "AV1 / AV2 out" (p. 27)
- Download Analogue programme setting → "Q-Link Download" (p. 27) or "Auto Setup" in Analogue mode (p. 35) or "Auto Setup" - when first using the TV (p. 12)

■ Features available

Some recorders are not applicable. Read the manual of the recorder.

Recording the current programme in DVD Recorder / VCR immediately.

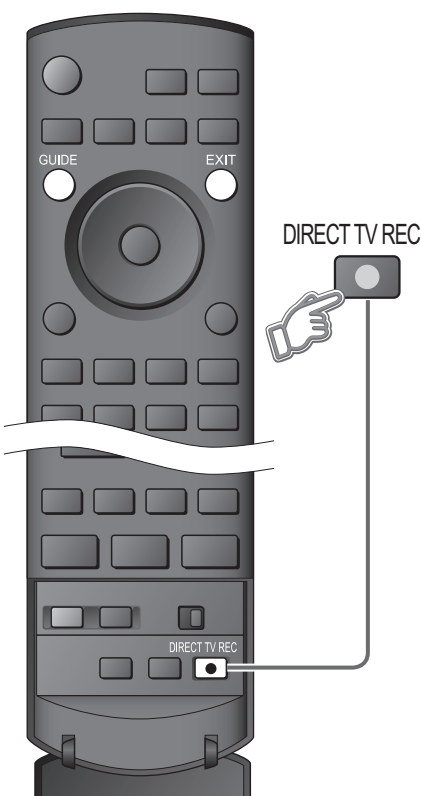

● Available conditions:

Current mode	Using tuner	How to record
Analogue	TV	TV monitor out
	Recorder	Recorder's tuner
DVB	TV	TV monitor out
AV (watching recorder's tuner)	Recorder	Recorder's tuner
AV (watching recorder's external input)	—	Recorder's external input
AV (watching TV's external input)	—	TV monitor out

- When Direct TV Recording is performed, the recorder is automatically turned on if it is in Standby mode.
- Changing programme or turning off the TV is available while the recorder is recording from its own tuner.
- Changing programme is not available while the recorder is recording from the TV tuner.
- Turning off the TV will stop the recording if the recording from an AV source connected to the TV.

■ To stop recording



Direct TV Recording -
What you see is What you record

Information / Message

Recording information or if recording is not possible, a message is displayed.

Power on link and Easy playback

When DVD Recorder / VCR starts playback or direct navigator / function menu for the equipment are activated, the TV is turned on and input mode is switched automatically so that you can view the content. (Only when TV is in Standby mode.)

Power off link

When TV is set to Standby mode, the recorder is also automatically set to Standby. (Only when the videocassette or DVD is not active.)

● Link Functions
(Q-Link / VIERA Link)

Advanced

• "DATA LOGIC" (a trademark of Metz Corporation)
• "Easy Link" (a trademark of Philips Corporation)

• "Megalogic" (a trademark of Grundig Corporation)
• "SMARTLINK" (a trademark of Sony Corporation)

Link Functions (Q-Link VIERA Link)

VIERA Link “HDAVI Control™”*

*Enjoy additional HDMI Inter-Operability with Panasonic products which have “HDAVI Control” function. This TV supports “HDAVI Control 3” function.

Connections to the equipment (DIGA Recorder, HD Video Camera, Player theatre, Amplifier, etc.) with HDMI and SCART cables allow you to interface them automatically.

These features are limited to models incorporating “HDAVI Control” and “VIERA Link”.

- Some functions are not available depending on the equipment’s version of HDAVI Control. Please confirm the connected equipment’s version of HDAVI Control.
- VIERA Link “HDAVI Control”, based on the control functions provided by HDMI which is an industry standard known as HDMI CEC (Consumer Electronics Control), is a unique function that we have developed and added. As such, its operation with other manufacturers’ equipment that supports HDMI CEC cannot be guaranteed.

Please refer to individual manuals for other manufacturers’ equipment supporting VIERA Link function. About applicable Panasonic equipment, consult your local Panasonic dealer or refer to the URL: www.panasonic.co.uk

■ Preparations

- Connect the equipment supporting VIERA Link.
- VIERA Link connection ➔ p. 44
- Set up the connected equipment. Read the manual of the equipment.
- For optimal recording, the settings of the recorder might be required. For details, read the manual of the recorder.
- Download Analogue programme setting ➔ “Q-Link Download” (p. 27) or “Auto Setup” in Analogue mode (p. 35) or “Auto Setup” - when first using the TV (p. 12)
- Set VIERA Link On in Setup Menu ➔ “VIERA Link” (p. 27)
- Set up the TV
 - ➔ **After connection, turn the equipment on and then switch the TV on. Select the input mode to HDMI1, HDMI2 or HDMI3 (p. 22), and make sure that an image is displayed correctly.**
 - This setup should be done each time when the following conditions occur:
 - for the first time
 - when adding or reconnecting equipment
 - when changing setup

■ Features available

Easy playback	Automatic Input switching - When the connected equipment is operated, input mode is switched automatically. When it is stopped operating, input mode is returned.
Power on link	When the connected equipment starts playback or direct navigator / function menu for the equipment are activated, the TV is automatically turned on. (Only when TV is in Standby mode.)
Power off link	When TV is set to Standby mode, the connected equipment is also automatically set to Standby. <ul style="list-style-type: none"> ● This function will work even if the TV enters standby mode automatically by Off Timer function or auto power standby function.

■ Features available (Using VIERA Link Menu)

Direct TV Recording - What you see is What you record (HDAVI Control 3)

Direct TV Rec

Recording the current programme in DIGA Recorder immediately.

- This function is available with DIGA Recorder which has "HDAVI Control 3" function.
- Connect DIGA Recorder with both HDMI and SCART cables to use this function.
- If you cannot operate, check the settings and the equipment → "Preparations" (p. 46)
- Changing programme or turning off the TV is available while the recorder is recording from its own tuner.
- Changing programme is not available while the recorder is recording from the TV tuner.
- Turning off the TV will stop the recording if the recording from an AV source connected to the TV.

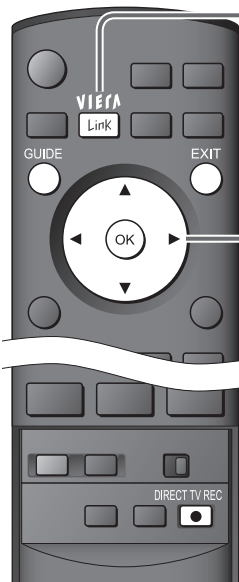

① Display "VIERA Link Menu"



② Select "Direct TV Rec" and start recording

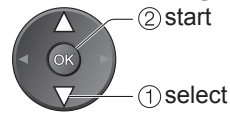
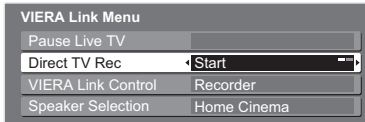

● You can also start recording directly → DIRECT TV REC



■ To stop recording

Select "Stop" in "Direct TV Rec" and access

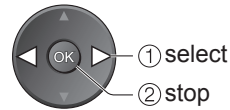
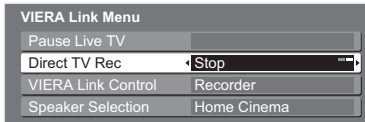

● You can also stop recording directly.



You can pause the live TV programme and resume later.

Live TV programme will be recorded on HDD of the connected DIGA Recorder.

- This function is available with DIGA Recorder which has HDD and "HDAVI Control 3" function.
- Connect DIGA Recorder with both HDMI and SCART cables to use this function.
- If you cannot operate, check the settings and the equipment → "Preparations" (p. 46)

Access and pause the live TV programme

Pause Live TV programme (HDAVI Control 3 and Recorder with HDD)

Pause Live TV



① Display "VIERA Link Menu"



② Select "Pause Live TV" and pause

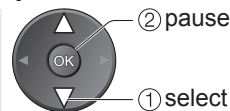
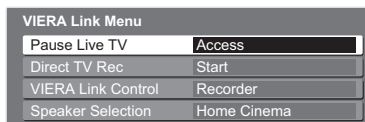

The TV picture will be paused.

- Live TV programme is recorded on HDD from where it was paused.
- If the paused TV picture disappears after a few minutes → OPTION (the paused picture will be restored)
- Follow the operation guide to operate Pause Live TV function.

■ To operate Pause Live TV

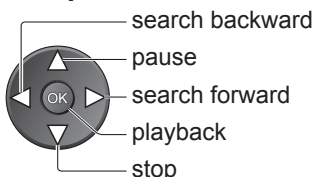

● Operations may be different depending on the recorder. In this case, follow the operation guide or read the manual of the recorder.

- If you stop playback, the recorded programme will be deleted from HDD.

■ To return to Live TV

(stop playback of Pause Live TV / cancel pause)

Select "Yes"

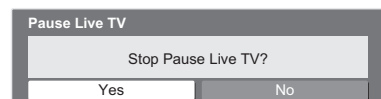

- If you stop playback or cancel pause, the recorded programme will be deleted from HDD.

Link Functions (Q-Link VIERA Link)

■ Features available (Using VIERA Link Menu)

You can control some functions of the connected equipment with this TV remote control (point the remote control at the TV's signal receiver).

- This function is available with the equipment which has "HDAVI Control 2" or "HDAVI Control 3" function.
- If you cannot operate, check the settings and the equipment → "Preparations" (p. 46)

Access and operate the menu of the equipment

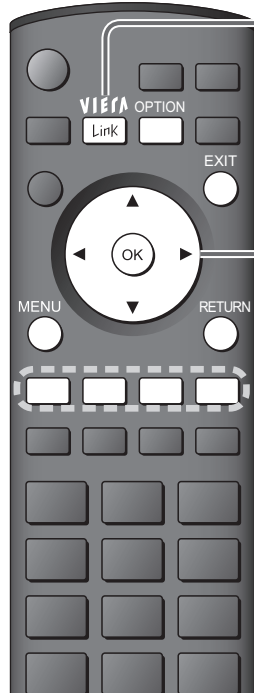

① Display "VIERA Link Menu"



② Select "VIERA Link Control"



③ Select the equipment you want to access

- "Home Cinema" means Player theatre, Recorder theatre and Amplifier.

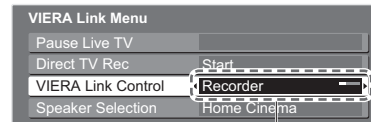

Recorder / Player / Home Cinema / Video Camera

The type of the connected equipment is displayed. Select the type of the equipment and access.

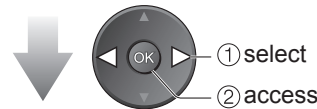

The menu of the accessed equipment (Input mode will be changed automatically)

④ Operate the menu of the equipment

- Available VIERA remote control buttons (depending on the connected equipment):

	Move the cursor / select the menu
	Move the cursor / access / adjust
	Store / set / access
	Return to the previous menu
	Exit the menu
	Display the operation guide for the equipment / The same functions with the OPTION button of the equipment
	Access when the key words are displayed on colour bar

- About the operations for the equipment, read the manual of the equipment.

Control the menu of the connected equipment by VIERA remote control

(HDAVI Control 2)
(HDAVI Control 3)

VIERA Link Control

■ If you access the invalid equipment

When the equipment with "HDAVI Control" function is connected

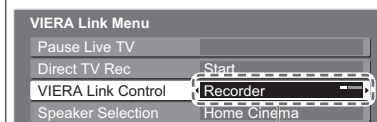

Recorder / Player / Home Cinema / Video Camera

The type of the connected equipment is displayed. But you cannot access it. Use its own remote control to operate the equipment.

When the equipment of other types or manufacturers is connected

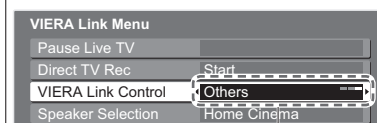

Others

"Others" is displayed. You cannot access it. Use its own remote control to operate the equipment.

■ Features available (Using VIERA Link Menu)

You can control the theatre speaker with this TV remote control (point the remote control at the TV's signal receiver).

- This function is available with the Amplifier or Player theatre which has "HDAVI Control" function.
- If you cannot operate, check the settings and the equipment → "Preparations" (p. 46)

Access and control the speaker volume

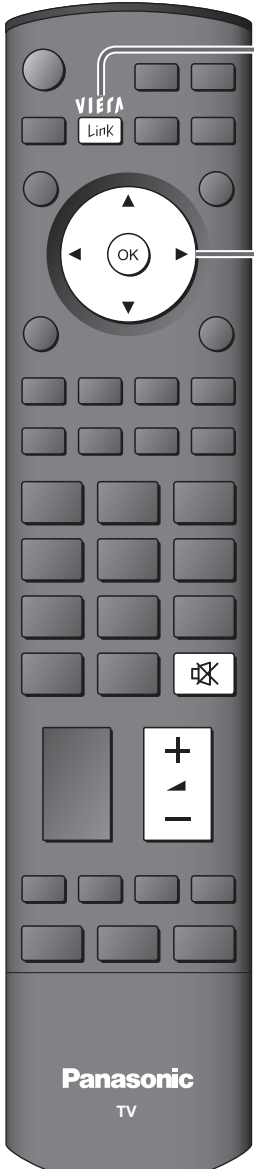

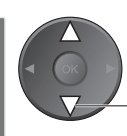

① Display "VIERA Link Menu" 

② Select "Speaker Selection"  select

VIERA Link Menu	
Pause Live TV	
Direct TV Rec	Start
VIERA Link Control	Recorder
Speaker Selection	Home Cinema

③ Set to "Home Cinema" or "TV"  set

■ **Home Cinema**
Amplifier or Player theatre will be automatically turned on if it is in Standby mode and the sound is from theatre speakers connected to the equipment.

- Volume up / down → 
- Mute → 
- The sound of TV speakers is mute.
- When the equipment is turned off, TV speakers will be active.

■ **TV**
TV speakers are active.

Speaker control

Speaker Selection

Note



- This function may not work properly depending on the connected equipment.
- Image or sound may not be available for the first few seconds when the playback starts.
- Image or sound may not be available for the first few seconds when Input mode is switched.
- Volume function will be displayed when adjusting the volume of the equipment.
- Easy playback is also available by using the remote control for Amplifier or Player theatre. Read the manual of the equipment.
- About HDMI cable for connecting Panasonic HD Video Camera, read the manual of the equipment.
- If more than one equipment of the same type are connected to the TV by HDMI cables, for example two DIGA Recorders to HDMI1 and HDMI2, VIERA Link will only be available for the lower terminal number, in this case HDMI1.
- "HDAVI Control 3" is the newest standard (current as of December, 2007) for HDAVI Control compatible equipment. This standard is compatible with conventional HDAVI equipment.
- To confirm this TV's version of HDAVI Control → "System Information" (p. 27)

External Equipment

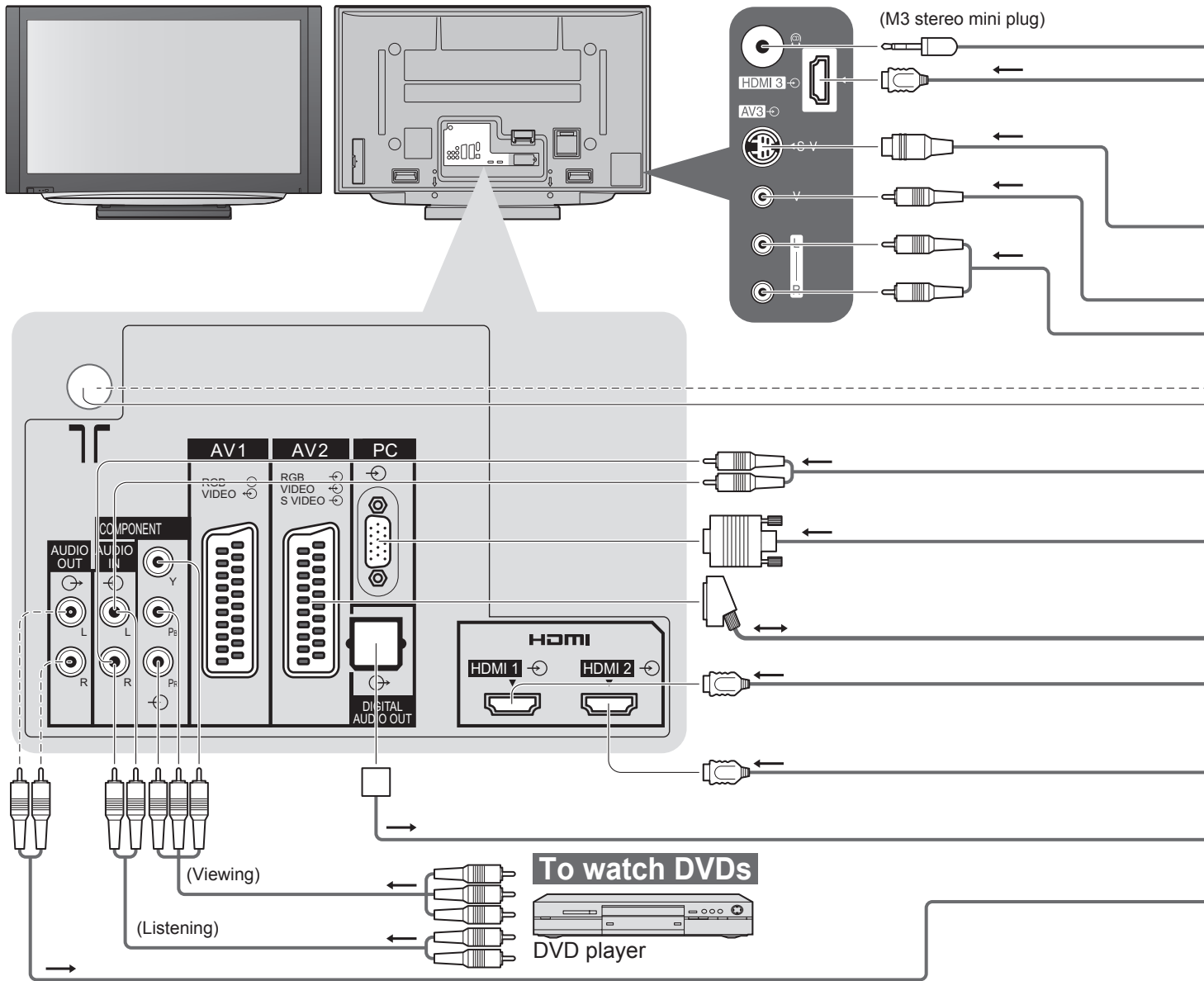
These diagrams show our recommendations for connection of your TV to various pieces of equipment. For other connections, consult the instructions for each piece of equipment, the table below, and the specifications (p. 59).



Types of connectable equipment to each terminal

Terminal	AV1 	AV2 	AV3 (Side of TV) 
Recording / Playback (equipment)			
To record / playback videocassettes / DVDs (VCR / DVD recorder)	○	○	
To watch DVDs (DVD player)	○	○	○
To watch camcorder images (Video camera)	○	○	○
To watch satellite broadcasts (Set top box)	○	○	○
To play games (Game equipment)	○	○	○
To use amplifier with speaker system			
Q-Link	○	○	
VIERA Link	○ (with HDMI)	○ (with HDMI)	
Direct TV Recording	○	○	

○: Recommended Connection

Headphones

■ To adjust volume

→ “Headphone Volume” in the Sound Menu (p. 26)



Camcorder / HDMI equipment

Fully wired HDMI compliant cable

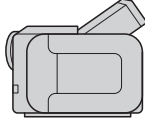

Camcorder / Game equipment

(S-VIDEO)
or
(VIDEO)

(AUDIO)

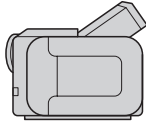

(Listening)

(Viewing)

Conversion adapter
(if necessary)

PC



Computer

HDMI equipment

Fully wired HDMI compliant cable

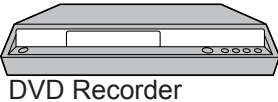

DVD Recorder

Optical digital audio cable

or

RCA cable

To listen with speakers

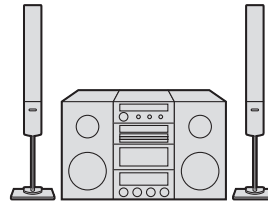

Amplifier with speaker system

To record / playback

DVD Recorder / VCR

To watch satellite broadcasts

HD Satellite receiver

RF cable

or

SCART cable

SCART cable

Fully wired HDMI compliant cable

COMPONENT	AUDIO OUT	DIGITAL AUDIO OUT	HDMI		
			1	2	3
			<input type="checkbox"/>	<input type="checkbox"/>	<input type="checkbox"/>
<input type="checkbox"/>	<input type="checkbox"/>	<input type="checkbox"/>	<input type="checkbox"/>	<input type="checkbox"/>	<input type="checkbox"/>
<input type="checkbox"/>	<input type="checkbox"/>	<input type="checkbox"/>	<input type="checkbox"/>	<input type="checkbox"/>	<input type="checkbox"/>
<input type="checkbox"/>	<input type="checkbox"/>	<input type="checkbox"/>	<input type="checkbox"/>	<input type="checkbox"/>	<input type="checkbox"/>
<input type="checkbox"/>	<input type="checkbox"/>	<input type="checkbox"/>	<input type="checkbox"/>	<input type="checkbox"/>	<input type="checkbox"/>
<input type="checkbox"/>	<input type="checkbox"/>	<input type="checkbox"/>	<input type="checkbox"/>	<input type="checkbox"/>	<input type="checkbox"/>

Technical Information

Auto Aspect

The optimum size and aspect can be chosen, and you can enjoy finer images. (p. 16)

■ Auto

Auto aspect determines the best aspect ratio to use to fill your screen. It does this using a four step process to determine if the picture being viewed is a widescreen picture.

If Auto aspect detects a widescreen signal it switches into the appropriate 16:9 or 14:9 widescreen mode. If Auto aspect does not detect a widescreen signal then this advanced TV enhances the picture for optimum viewing pleasure.

The text shown on the screen indicates how Auto aspect determined which ratio to use:

“WIDE” appears in the top left of the screen if a widescreen identification signal (WSS) is found or a signal found through a SCART or HDMI terminal. Auto aspect switches to the appropriate 16:9 or 14:9 widescreen ratio. This function will also work in any aspect mode. “Auto” appears in the top left of the screen if black stripes above and below the picture are detected. Auto aspect chooses the best ratio and expands the picture to fill the screen.

This process can take several minutes, depending on the darkness of the picture.

Signal name	Aspect Control Signal									
	Widescreen signal (WSS)					Control signal through SCART (pin 8) or HDMI terminal				
	TV	AV1	AV2	AV3	COMPONENT	AV1	AV2	HDMI1	HDMI2	HDMI3
PAL	○	○	○	○	/	○	○	/	/	/
PAL 525/60	-	-	-	-		○	○			
DVB	○	-	-	-		-	-			
M.NTSC	-	-	-	-		○	○			
NTSC (AV input only)	-	-	-	-		○	○			
SD	525(480)/60i	/	/	/	-	/	/	○	○	○
	525(480)/60p				-			○	○	○
	625(576)/50i				○			○	○	○
	625(576)/50p				○			○	○	○
HD	750(720)/50p	/	/	/	-	/	/	○	○	○
	750(720)/60p				-			○	○	○
	1125(1080)/50i				-			○	○	○
	1125(1080)/60i				-			○	○	○
	1125(1080)/50p				-			○	○	○
	1125(1080)/60p				-			○	○	○
	1125(1080)/24p				-			○	○	○

Note

- The ratio varies depending on the programme, etc. If the ratio is greater than the standard “16:9”, black bands may appear at the top and bottom of the screen.
- If the screen size looks unusual when a widescreen-recorded programme is played back on a VCR, adjust the tracking of the VCR. (See the VCR manual.)

HDMI connection

HDMI (high-definition multimedia interface) allows you to enjoy high-definition digital images and high-quality sound by connecting the TV and the equipment.

HDMI-compatible equipment (*1) with an HDMI or DVI output terminal, such as a set top box or a DVD player, can be connected to the HDMI terminal using an HDMI compliant (fully wired) cable.

About connections, see “External Equipment” (p. 50).

Note

- HDMI is the world’s first complete digital consumer AV interface complying with a non-compression standard.
- If the external equipment has only a DVI output, connect to the HDMI1 / 3 terminal via a DVI to HDMI adapter cable (*2).
- When the DVI to HDMI adapter cable is used, connect the audio cable to the audio input terminal (HDMI1: use COMPONENT-AUDIO terminals / HDMI3: use AV3 audio terminals).
- Audio settings can be made on the “HDMI1 / 3 Input” menu screen. (p. 26)
- Applicable audio signal sampling frequencies (2ch L.PCM): 48 kHz, 44.1 kHz, 32 kHz
- HDMI2 terminal is for digital audio signal only.
- Use with a PC is not assumed.
- If the connected equipment has an aspect adjustment function, set the aspect ratio to “16:9”.
- These HDMI connectors are “type A”.
- These HDMI connectors are compatible with HDCP (High-Bandwidth Digital Content Protection) copyright protection.
- An equipment having no digital output terminal may be connected to the input terminal of either “COMPONENT”, “S-VIDEO”, or “VIDEO” to receive analogue signals.
- The HDMI input terminal can be used with only the following image signals: 480i, 480p, 576i, 576p, 720p, 1080i and 1080p. Match the output setting of the digital equipment.
- For details of the applicable HDMI signals, see p. 54.
- This TV incorporates HDMI™ (Version 1.3 with x.v.Color™) technology.

(*1): The HDMI logo is displayed on HDMI-compliant equipment.
 (*2): Enquire at your local digital equipment retailer shop.

Updating the DVB software

From time to time, a new version of software for DVB mode may become available for download to enhance the performance or operations of the TV.

A notification banner will appear when you tune to one of the BBC channels, or you can search for a new version software by using the "System Update Search Now" function (p. 31).

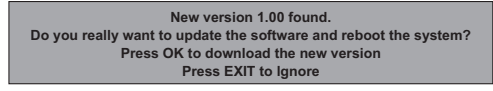

To start downloading press "OK", this may take up to 20 minutes to complete.

To ignore the new software press "EXIT", but this banner will keep appearing during the period of new software availability, usually 2 to 3 days.

To download any new software automatically, ensure that the "Auto Update Search in Standby" function in the System Update menu is set to "On" (p. 31).

The TV will then download new software automatically at night if it is left in standby without any timer programme in progress.

Note

- During software download and update, DO NOT switch off the TV.

Data format for Card browsing

Photo : Still images recorded with digital still cameras compatible with JPEG files of DCF* and EXIF standards

Data format : Baseline JPEG (Sub-sampling 4:4:4, 4:2:2 or 4:2:0)

Max. number of files : 9,999

Image resolution : 160 × 120 to 10,000,000

- Compliant card type (maximum capacity): SDHC Card (16 GB), SD Card (2 GB), Multi Media Card (128 MB), miniSD Card (1 GB) (requiring miniSD adapter)

- If miniSD Card is used, insert / remove it together with the adapter.

- Check the latest information on the card type at the following website. (English only)

<http://panasonic.co.jp/pavc/global/cs/>

*DCF (Design rule for camera file system): Unified standard established by Japan Electronics and Information Technology Industries Association (JEITA).

Note

- A JPEG image modified with a PC may not be displayed.
- Images imported from a PC must be compatible with EXIF (Exchangeable Image File) 2.0, 2.1, and 2.2.
- Partly degraded files might be displayed at a reduced resolution.
- Only ".JPG" extension can be read by this TV.
- The folder and file names may be different depending on the digital camera used.
- Do not use two-byte characters or other special codes.
- The card may become unusable with this TV if the file or folder names are changed.

SCART, S-VIDEO and HDMI terminal information

■ AV1 SCART terminal (RGB, VIDEO, Q-Link)

Suitable inputs for AV1 include RGB (Red / Green / Blue).

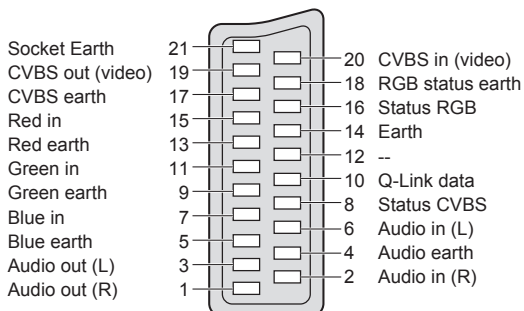

■ AV2 SCART terminal (RGB, VIDEO, S-VIDEO, Q-Link)

AV2 - Pins 15 and 20 are dependent on AV2 S-VHS / VIDEO switching.

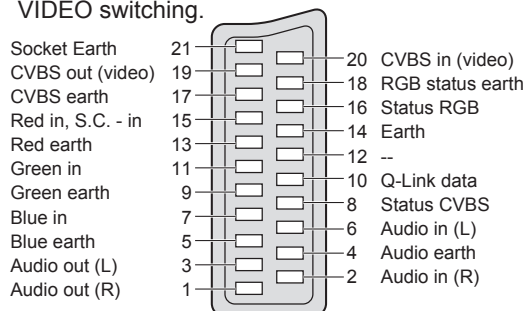

■ AV3 S-VIDEO 4 pin terminal

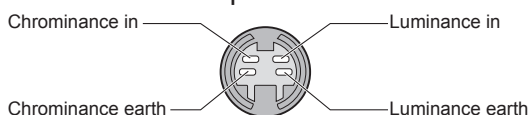

■ HDMI terminal

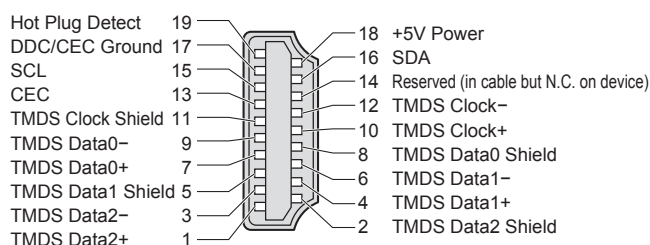

Technical Information

PC connection

A PC may be connected to this TV so that the PC screen is displayed and sound is heard from the TV.

- PC signals that can be inputted: Horizontal scanning frequency 31 to 69 kHz; vertical scanning frequency 59 to 86 Hz (more than 1,024 signal lines could result in incorrect display of the image).
- A PC adapter is not necessary for the DOS/V-compliant D-sub 15-pin connector.

Note

- Some PC models cannot be connected to this TV.
- When using PC, set the colour display quality of PC to the highest position.
- For details of the applicable PC signals, see below.
- Max. display resolution

Aspect	4:3	1,440 × 1,080 pixels
	16:9	1,920 × 1,080 pixels

- D-sub 15-pin connector signal

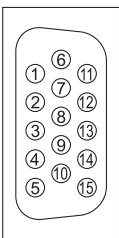

Pin No.	Signal Name	Pin No.	Signal Name	Pin No.	Signal Name
①	R	⑥	GND (Ground)	⑪	NC (not connected)
②	G	⑦	GND (Ground)	⑫	NC (not connected)
③	B	⑧	GND (Ground)	⑬	HD
④	NC (not connected)	⑨	NC (not connected)	⑭	VD
⑤	GND (Ground)	⑩	GND (Ground)	⑮	NC (not connected)

Input signal that can be displayed

COMPONENT (Y, P_B, P_R), HDMI

* Mark: Applicable input signal

Signal name	COMPONENT	HDMI
525 (480) / 60i	*	*
525 (480) / 60p	*	*
625 (576) / 50i	*	*
625 (576) / 50p	*	*
750 (720) / 60p	*	*
750 (720) / 50p	*	*
1,125 (1,080) / 60i	*	*
1,125 (1,080) / 50i	*	*
1,125 (1,080) / 60p		*
1,125 (1,080) / 50p		*
1,125 (1,080) / 24p		*

PC (D-sub 15P)

Signal name	Horizontal frequency (kHz)	Vertical frequency (Hz)
640 × 400 @70 Hz	31.47	70.07
640 × 480 @60 Hz	31.47	59.94
640 × 480 @75 Hz	37.50	75.00
800 × 600 @60 Hz	37.88	60.32
800 × 600 @75 Hz	46.88	75.00
800 × 600 @85 Hz	53.67	85.06
852 × 480 @60 Hz	31.44	59.89
1,024 × 768 @60 Hz	48.36	60.00
1,024 × 768 @70 Hz	56.48	70.07
1,024 × 768 @75 Hz	60.02	75.03
1,024 × 768 @85 Hz	68.68	85.00
1,280 × 1,024 @60 Hz	63.98	60.02
1,366 × 768 @60 Hz	48.39	60.04
Macintosh13" (640 × 480)	35.00	66.67
Macintosh16" (832 × 624)	49.73	74.55
Macintosh21" (1,152 × 870)	68.68	75.06

Note

- Signals other than above may not be displayed properly.
- The above signals are reformatted for optimal viewing on your display.
- Applicable input signal for PC is basically compatible to VESA standard timing.
- PC signal is magnified or compressed for display, so that it may not be possible to show fine detail with sufficient clarity.

FAQs

Before requesting service or assistance, please follow these simple guides to resolve the problem. If the problem still persists, please contact your local Panasonic dealer or Panasonic Customer Care Centre for assistance. For details (p. 60)

White spots or shadow images (noise)

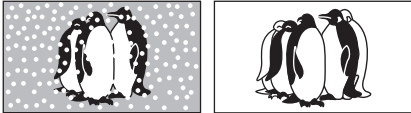

- Check the position, direction, and connection of the aerial.

Neither image nor sound is produced

- Is the TV in "AV mode"?
- Is the mains lead plugged into the socket outlet?
- Is the TV turned On?
- Check Picture Menu (p. 26) and volume.
- Check all required SCART cables and connections are firmly in place.

Auto aspect

- Auto aspect is designed to provide you with the best aspect ratio to use to fill your screen. For user control please see p. 52.

S-Video / black and white picture

- Using AV button please confirm your selection is S-Video i.e. AV2/S (p. 22).

No programmes shown on TV Guide

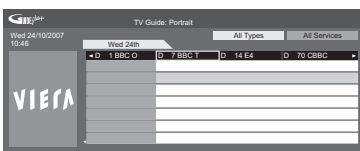

- Check the DVB transmitter.
- Adjust the direction of the aerial to another transmitter installed nearby.
- Check the analogue broadcast. If the image quality is poor, check the aerial and consult your nearest dealer.

On Screen messages - i.e. EC/AV1

- You can simply clear these →  Press again to redisplay.



Q-Link function does not work

- Please confirm SCART cable and connection. Also please set "AV1 / AV2 out" in the Setup Menu (p. 27).

"VIERA Link" function does not work and an error message appears

- Confirm the connection.
- Turn the connected equipment on and then switch the TV on. (p. 46)

Recording does not start immediately

- Check the settings of the recorder. For details, read the manual of the recorder.

Permanently lit spots on screen

- Due to production process involved in this technology this may result in some pixels which are permanently lit or unlit. This is not a malfunction.

Contrast is reduced

- Contrast is lowered in the following conditions without any user operation for a few minutes:
 - no signal in DVB or AV mode
 - selected locked programme
 - selected invalid programme
 - selected radio service
 - displayed menu
 - Digital teletext (no video contents)
 - Thumbnail or still picture in SD Card mode

FAQs

	Problem	Actions
Screen	Chaotic image, noisy	<ul style="list-style-type: none"> ● Set "P-NR" in the Picture Menu (to remove noise). (p. 26) ● Check nearby electrical products (car, motorcycle, fluorescent lamp).
	No image can be displayed	<ul style="list-style-type: none"> ● Is "Colour" or "Contrast" in the Picture Menu set to the minimum? (p. 26)
	Blurry or distorted image (no sound or low volume)	<ul style="list-style-type: none"> ● Reset programmes. (p. 35)
	Unusual image is displayed	<ul style="list-style-type: none"> ● Turn off the TV with Mains power On / Off switch, then turn it On again.
Sound	No sound is produced	<ul style="list-style-type: none"> ● Is "Sound mute" active? (p. 9) ● Is the volume set to the minimum?
	Sound level is low or sound is distorted	<ul style="list-style-type: none"> ● Sound signal reception may be deteriorated. ● Set "NICAM" (p. 26) in the Sound Menu to "Off". (Analogue only)
	Whirling sound is heard	<ul style="list-style-type: none"> ● The sound is from built-in cooling fan (not a sign of faulty operation).
DVB	<ul style="list-style-type: none"> ● Due to the digital reception technologies involved, quality of the DTV signals may be relatively low in some cases, despite good reception of analogue programmes. 	
	Interference or frozen / disappearing image in DVB	<ul style="list-style-type: none"> ● Check "DVB Signal Condition". (p. 35) ● If "Signal Quality" or "Signal Strength" are displayed in red, check aerial. ● If problem persists, consult your local Panasonic dealer. ● Turn the TV off with the Mains power On / Off switch, then turn it On again.
HDMI	Sound is unusual	<ul style="list-style-type: none"> ● Set the sound setting of the connected equipment to "2ch L.PCM". ● Check the "HDMI1 / 3 Input" setting in the Sound Menu. (p. 26) ● If digital sound connection has a problem, select analogue sound connection. (p. 52)
	Pictures from external equipment are unusual when the equipment is connected via HDMI	<ul style="list-style-type: none"> ● Is the HDMI cable connected properly? (p. 50) ● Turn Off the TV and equipment, then turn them On again. ● Check an input signal from the equipment. (p. 54) ● Use an equipment compliant with EIA/CEA-861/861B.
Other	TV goes into "Standby mode"	<ul style="list-style-type: none"> ● Off Timer function is activated. ● The TV enters "Standby mode" about 30 mins. after analogue broadcasting ends.
	The remote control does not work	<ul style="list-style-type: none"> ● Are the batteries installed correctly? (p. 6) ● Has the TV been switched On?
	An error message appears	<ul style="list-style-type: none"> ● Follow the message's instructions. ● If the problem persists, contact the authorized Service Centre.

On screen messages

Message	Meaning / Action
All tuning data will be erased	▶ ● "Shipping Condition" will erase all tuning data (p. 36).
Are you sure ?	▶ ● Confirm correct operation.
Are you sure you want to delete this timer ? Press OK to delete timer Press RETURN to return	▶ ● Confirm correct operation.
Bad Signal	▶ ● The signal is weak. Check the aerial.
Child Lock is active ! Press OK to enter PIN	▶ ● The selected programme is locked in Child Lock (p. 33).
Feature not available	▶ ● It is not possible to record these sources (COMPONENT / HDMI / PC).
Invalid operation - Please check settings and connections	▶ ● Check the Q-Link or VIERA Link connection and setting (p. 44 - 46).
Invalid system time. Please exit !	▶ ● Cannot get the time information. Check the connection of the RF cable.
Max. number of Timers already set !	▶ ● The maximum number of timer programming events is 15.
New DVB Service Found! Press OK start Auto Setup Press EXIT to Ignore. Selecting Auto Setup will delete current Profile and Childlock settings	▶ ● There is a new DVB service or programme.
New version 1.90 found. Do you really want to update the software and reboot the system ? Press OK to download the new version Press EXIT to Ignore	▶ ● There is a new software available.
No DVB Service found Please check aerial or local DVB service availability. Press OK to start Auto Setup	▶ ● Please follow the message. If it is still failed, consult your local Panasonic dealer.
No module inserted	▶ ● Check the CI module inserted completely (p. 31).
No Recording - Check media	▶ ● The tape or disc may be "write protected", missing or damaged.
No Recording - Already recording	▶ ● The equipment may already be recording.
No Recording - Unknown reason	▶ ● The recording may not be performed. Check the equipment. ● Disc or tape may be full.
No Service	▶ ● The broadcaster has stopped the service.
No Signal	▶ ● Check the connection of the RF cable.
PIN incorrect !	▶ ● The PIN number you entered is wrong.
Please check settings and connections on HDMI devices.	▶ ● Communication error in VIERA Link function (p. 46).
Please wait.	▶ ● A function is in progress.
Recording this service now	▶ ● The recorder is recording the programme signal from its own tuner. You can turn the TV off and leave the equipment recording in the normal way.
Sending Preset Data Please wait !	▶ ● Q-Link or VIERA Link programme download is in progress.
Shipping condition completed. TV can now be switched off.	▶ ● "Auto Setup" will automatically start when Mains power On / Off switch is next turned On. (p. 12)
Software successfully updated Press EXIT to continue	▶ ● The software updating is finished.
Software Update failed. Please try again later. Press EXIT to continue	▶ ● Perform "System Update Search Now" in System Update (p. 31). If this is still unsuccessful, there may not be any new software available.
Timer already expired !	▶ ● Starting time in Timer Programming is already past. Set correctly (p. 41).
Timer Event Due to Start DVB 1: BBC1 has been Programmed for recording at 20:00	▶ ● This message will appear 2 minutes before timer programming event due to start.
Timer incorrect !	▶ ● Set Start and End times in Timer Programming correctly (p. 41).
Tuner Locked Please stop recording to operate	▶ ● If you want to unlock, cancel Direct TV Recording (p. 45 and p. 47) or Timer Programming (p. 40).
Unable to download, Check Equipment	▶ ● The tape or disc is active. Stop the equipment and try again.

Glossary

- **DVB**
Digital Video Broadcasting
- **DVD**
Digital Versatile Disc
- **DVI**
Digital Visual Interface
- **EPG**
Electronic Programme Guide
- **HDMI**
High-Definition Multimedia Interface
- **NTSC**
National Television System Committee
One of the television signals used in USA, etc.
- **RF**
Radio Frequency - Signal received from terrestrial aerial
- **RGB / S-Video / Video**
Choose between these three video formats depending on personal preference and equipment requirement (RGB - Red, Green and Blue)
- **SCART**
21 pin connection used for video, audio and switching signals (Also known as Euro SCART and Peritel)
- **VCR**
Video Cassette Recorder

Index

- A** Accessories 6
 - Add New DVB Services 35
 - Analogue Manual Tuning 35
 - Aspect 16, 52
 - Audio Description 15, 26
 - Auto Setup 12, 35
 - AV1 / AV2 out 27, 45
- B** Banner Display Timeout 27
- C** Category list 20
 - Child Lock 33
 - CI module 31
 - Clamper 8
 - COMPONENT 50, 54
 - Connection 10, 44, 50
- D** Direct TV Recording 45, 47
 - Download to equipment 12, 27
 - D-sub 15-pin 54
 - DVB Manual Tuning 35
 - DVB Profile Edit 32
 - DVB Settings 30
 - DVB Signal Condition 35
 - DVI 52
 - DVDs 10, 22
- E** EPG 20
 - External equipment 10, 22, 50
 - External input 22, 39
 - Event recording 21
- F** FAQs 55, 56
 - Free input menu 25
- G** GUIDE Plus+ Settings 27
- H** HDMI 52-54
 - Hold 14, 19
 - Home Cinema 44, 49
- I** Information banner 15
 - Input Labels 38
 - Input signal 54
 - Intelligent Frame Creation 27
- L** Licence 59
- M** Mains Lead 10
 - Mains power On / Off switch 9, 12
 - Maintenance 5
 - Menu Functions 24-29
 - Mode 26
 - Multi Audio 15
- N** New Service Message 35
 - NICAM 26
 - NTSC 28, 59
- O** Off Timer 16, 27
 - Optional accessories 6
 - Owner ID 12, 37
- P** PAL 59
 - PC 39, 54
 - Pedestal 7
 - Photo View 42
 - Picture Overscan 27
 - PIN number 12, 33, 37
 - P-NR 26
 - Power LED 9, 12
- Q** Q-Link 27, 44, 45
 - Quick Start Guide 6-13
- R** Remote control 6, 9
 - Reset to Default 26
 - RGB 59
- S** Sales and Support Information 60
 - Satellite receiver 11, 22, 50
 - SCART 10, 44, 53
 - SD Card 42, 53
 - Shipping Condition 36
 - Slide show 43
 - Specifications 59
 - Split Programme 21
 - Subtitles 14, 19
 - Surround 26
 - S-Video 50, 53
 - System Update 31, 53
- T** Teletext 17-19
 - Timer LED 9, 21, 41
 - Timer Programming 40
 - Tuning Menu 34
 - TV Guide 20
 - TV speaker 49
 - Type list 20
- U** Update the software 31, 53
 - User input 38
- V** Video 22, 50
 - VIERA Link 44, 46-49
 - Viewing Mode 26
 - Volume Correction 26
- W** WSS 52
- Z** Zoom 16

Licence

- DVB is a trademark of the DVB Digital Video Broadcasting Project (1991 to 1996).
- VGA is a trademark of International Business Machines Corporation.
- Macintosh is a registered trademark of Apple Inc., USA.
- S-VGA is a registered trademark of the Video Electronics Standard Association.
- Even if no special notation has been made of company or product trademarks, these trademarks have been fully respected.
- SDHC Logo is a trademark.
- HDMI, the HDMI Logo and High-Definition Multimedia Interface are trademarks or registered trademarks of HDMI Licensing LLC.
- HDAVI Control™ is a trademark of Matsushita Electric Industrial Co., Ltd.
- Manufactured under license from BBE Sound, Inc.
Licensed by BBE Sound, Inc. under one or more of the following US patents: 5510752, 5736897.
BBE and BBE symbol are registered trademarks of BBE Sound, Inc.
- GUIDE Plus+ is (1) a registered trademark or trademark of, (2) manufactured under license from and (3) subject of various international patents and patent applications owned by, or licensed to, Gemstar-TV Guide International, Inc. and/or its related affiliates.

GEMSTAR-TV GUIDE INTERNATIONAL, INC. AND/OR ITS RELATED AFFILIATES ARE NOT IN ANY WAY LIABLE FOR THE ACCURACY OF THE PROGRAM SCHEDULE INFORMATION PROVIDED BY THE GUIDE PLUS+ SYSTEM. IN NO EVENT SHALL GEMSTAR-TV GUIDE INTERNATIONAL, INC. AND/OR ITS RELATED AFFILIATES BE LIABLE FOR ANY AMOUNTS REPRESENTING LOSS OF PROFITS, LOSS OF BUSINESS, OR INDIRECT, SPECIAL, OR CONSEQUENTIAL DAMAGES IN CONNECTION WITH THE PROVISION OR USE OF ANY INFORMATION, EQUIPMENT, OR SERVICES RELATING TO THE GUIDE PLUS+ SYSTEM.

<http://www.europe.guideplus.com/>

Specifications

		TH-42PZ85B	TH-46PZ85B	
Power Source		AC 220-240 V, 50 / 60 Hz		
Power Consumption	Average use	385 W	470 W	
	Standby condition	0.4 W (Without monitor out recording) 20 W (With monitor out recording)		
Display panel	Aspect Ratio	16:9		
	Visible screen size	106 cm (diagonal) 922 mm (W) × 518 mm (H)	117 cm (diagonal) 1,019 mm (W) × 573 mm (H)	
	Number of pixels	2,073,600 (1,920 (W) × 1,080 (H)) [5,760 × 1,080 dots]		
Sound	Speaker	160 mm × 42 mm × 2 pcs, 6 Ω		
	Audio Output	20 W (10 W + 10 W), 10% THD		
	Headphones	M3 (3.5 mm) stereo mini Jack × 1		
PC signals		VGA, SVGA, XGA SXGA (compressed) Horizontal scanning frequency 31 - 69 kHz Vertical scanning frequency 59 - 86 Hz		
Receiving Systems / Band name		PAL I : UHF E21-68 PAL 525/60 : Playback of NTSC tape from some PAL Video recorders (VCR) or NTSC disc playback from DVD player and recorder. DVB : Digital terrestrial services via UHF aerial input. M.NTSC : Playback from M.NTSC Video recorders (VCR). NTSC (AV input only) : Playback from NTSC Video recorders (VCR).		
Aerial - Rear		UHF		
Operating Conditions		Temperature : 0 °C - 35 °C Humidity : 20 % - 80 % RH (non-condensing)		
Connection Terminals	AV1 (Scart terminal)		21 Pin terminal (Audio/Video in, Audio/Video out, RGB in, Q-Link)	
	AV2 (Scart terminal)		21 Pin terminal (Audio/Video in, Audio/Video out, RGB in, S-Video in, Q-Link)	
	AV3	VIDEO	RCA PIN Type × 1	1.0 V[p-p] (75 Ω)
		S-VIDEO	Mini DIN 4-pin	Y:1.0 V[p-p] (75 Ω) C:0.286 V[p-p] (75 Ω)
		AUDIO L - R	RCA PIN Type × 2	0.5 V[rms]
	COMPONENT	VIDEO	Y	1.0 V[p-p] (including synchronization)
		AUDIO L - R	P_B, P_R	±0.35 V[p-p]
	Others	HDMI1 / 2 / 3		TYPE A Connectors ● This TV supports "HDAVI Control 3" function.
		PC		HIGH-DENSITY D-SUB 15PIN R,G,B/0.7 V[p-p] (75 Ω) HD, VD/TTL Level 2.0 - 5.0 V[p-p] (high impedance)
		Card slot		SD Card slot × 1
Output	AUDIO L - R	RCA PIN Type × 2	0.5 V[rms] (high impedance)	
	DIGITAL AUDIO OUT	PCM, Fiber optic		
Dimensions (W × H × D)		1,064 mm × 723 mm × 327 mm (With Pedestal) 1,064 mm × 674 mm × 92 mm (TV only)	1,168 mm × 792 mm × 387 mm (With Pedestal) 1,168 mm × 737 mm × 93 mm (TV only)	
Mass		34.0 kg Net (With Pedestal) 30.0 kg Net (TV only)	39.0 kg Net (With Pedestal) 35.0 kg Net (TV only)	

- Design and Specifications are subject to change without notice. Mass and Dimensions shown are approximate.
- This equipment complies with the EMC standards listed below.
EN55013, EN61000-3-2, EN61000-3-3, EN55020, EN55022, EN55024.

Information on Disposal for Users of Waste Electrical & Electronic Equipment (private households)



This symbol on the products and/or accompanying documents means that used electrical and electronic products should not be mixed with general household waste.

For proper treatment, recovery and recycling, please take these products to designated collection points, where they will be accepted on a free of charge basis. Alternatively, in some countries you may be able to return your products to your local retailer upon the purchase of an equivalent new product.

Disposing of this product correctly will help to save valuable resources and prevent any potential negative effects on human health and the environment which could otherwise arise from inappropriate waste handling. Please contact your local authority for further details of your nearest designated collection point. Penalties may be applicable for incorrect disposal of this waste, in accordance with national legislation.

For business users in the European Union

If you wish to discard electrical and electronic equipment, please contact your dealer or supplier for further information.

Information on Disposal in other Countries outside the European Union

This symbol is only valid in the European Union.

If you wish to discard this product, please contact your local authorities or dealer and ask for the correct method of disposal.

Sales and Support Information

Customer Care Centre

- For customers within the UK : **0844 844 3852**
- For customers within the Republic of Ireland: **01 289 8333**
- Visit our website for product information **www.panasonic.co.uk**
- E-mail: **customer.care@panasonic.co.uk**

Direct Sales at Panasonic UK

- Order accessory and consumable items for your product with ease and confidence by phoning our Customer Care Centre Monday – Thursday 9:00am – 5:30pm, Friday 9:30am – 5:30pm (Excluding public holidays).
- Or go on line through our Internet Accessory ordering application at **www.panasonic.co.uk**.
- Most major credit and debit cards accepted.
- All enquiries transactions and distribution facilities are provided directly by Panasonic UK Ltd.
- It couldn't be simpler!
- Also available through our Internet is direct shopping for a wide range of finished products, take a browse on our website for further details.

Interested in purchasing an extended guarantee?

Please call 0870 240 6284 or visit www.panasonic.co.uk/guarantee.



Trade Mark of the DVB Digital Video Broadcasting Project (1991 to 1996)
TH-42PZ85B Declaration of Conformity No. 5273, 9 January 2008
TH-46PZ85B Declaration of Conformity No. 5272, 9 January 2008

Customer's Record

The model number and serial number of this product may be found on its rear panel. You should note this serial number in the space provided below and retain this book, plus your purchase receipt, as a permanent record of your purchase to aid in identification in the event of theft or loss, and for Warranty Service purposes.

Model Number _____

Serial Number _____

Panasonic (U. K.) Ltd.

Willoughby Road, Bracknell, Berks RG12 8FP Web Site : <http://www.panasonic-europe.com>

© 2008 Matsushita Electric Industrial Co., Ltd. All Rights Reserved.