

# Panasonic®

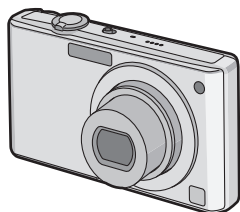

## Operating Instructions

Digital Camera

Model No. **DMC-FX37**



Before use, please read these instructions completely.



Web Site: <http://www.panasonic-europe.com>

**Dear Customer,**

We would like to take this opportunity to thank you for purchasing this Panasonic Digital Camera. Please read these Operating Instructions carefully and keep them handy for future reference.

## Information for Your Safety

**WARNING:**

**TO REDUCE THE RISK OF FIRE, ELECTRIC SHOCK OR PRODUCT DAMAGE,**

- **DO NOT EXPOSE THIS APPARATUS TO RAIN, MOISTURE, DRIPPING OR SPLASHING AND THAT NO OBJECTS FILLED WITH LIQUIDS, SUCH AS VASES, SHALL BE PLACED ON THE APPARATUS.**
- **USE ONLY THE RECOMMENDED ACCESSORIES.**
- **DO NOT REMOVE THE COVER (OR BACK); THERE ARE NO USER SERVICEABLE PARTS INSIDE. REFER SERVICING TO QUALIFIED SERVICE PERSONNEL.**

Carefully observe copyright laws.

Recording of pre-recorded tapes or discs or other published or broadcast material for purposes other than your own private use may infringe copyright laws. Even for the purpose of private use, recording of certain material may be restricted.

- Please note that the actual controls and components, menu items, etc. of your Digital Camera may look somewhat different from those shown in the illustrations in these Operating Instructions.
- SDHC Logo is a trademark.
- Microsoft product screen shot(s) reprinted with permission from Microsoft Corporation.
- Other names, company names, and product names printed in these instructions are trademarks or registered trademarks of the companies concerned.

THE SOCKET OUTLET SHALL BE INSTALLED NEAR THE EQUIPMENT AND SHALL BE EASILY ACCESSIBLE.

**CAUTION**

Danger of explosion if battery is incorrectly replaced. Replace only with the same or equivalent type recommended by the manufacturer. Dispose of used batteries according to the manufacturer's instructions.

**Warning**



Risk of fire, explosion and burns. Do not disassemble, heat above 60 °C or incinerate.

Product Identification Marking is located on the bottom of units.

## Caution for AC mains lead

For your safety, please read the following text carefully.

This appliance is supplied with a moulded three pin mains plug for your safety and convenience.

A 5-ampere fuse is fitted in this plug. Should the fuse need to be replaced please ensure that the replacement fuse has a rating of 5-ampere and that it is approved by ASTA or BSI to BS1362. Check for the ASTA mark  or the BSI mark  on the body of the fuse.

If the plug contains a removable fuse cover you must ensure that it is refitted when the fuse is replaced.

If you lose the fuse cover the plug must not be used until a replacement cover is obtained.

A replacement fuse cover can be purchased from your local dealer.

### CAUTION!

IF THE FITTED MOULDED PLUG IS UNSUITABLE FOR THE SOCKET OUTLET IN YOUR HOME THEN THE FUSE SHOULD BE REMOVED AND THE PLUG CUT OFF AND DISPOSED OF SAFELY. THERE IS A DANGER OF SEVERE ELECTRICAL SHOCK IF THE CUT OFF PLUG IS INSERTED INTO ANY 13-AMPERE SOCKET.

If a new plug is to be fitted please observe the wiring code as stated below. If in any doubt please consult a qualified electrician.

### ■ IMPORTANT

The wires in this mains lead are coloured in accordance with the following code: Blue: Neutral, Brown: Live.

As these colours may not correspond with the coloured markings identifying the terminals in your plug, proceed as follows: The wire which is coloured Blue must be connected to the terminal which is marked with the letter N or coloured Black or Blue. The wire which is coloured Brown must be connected to the terminal which is marked with the letter L or coloured Brown or Red.

**WARNING: DO NOT CONNECT EITHER WIRE TO THE EARTH TERMINAL WHICH IS MARKED WITH THE LETTER E, BY THE EARTH SYMBOL  $\perp$  OR COLOURED GREEN OR GREEN/YELLOW.**

**THIS PLUG IS NOT WATERPROOF—KEEP DRY.**

### ■ Before use

Remove the connector cover.

### ■ How to replace the fuse

The location of the fuse differ according to the type of AC mains plug (figures A and B). Confirm the AC mains plug fitted and follow the instructions below.

Illustrations may differ from actual AC mains plug.

1. Open the fuse cover with a screwdriver.

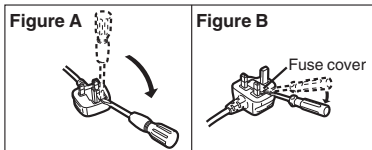

2. Replace the fuse and close or attach the fuse cover.

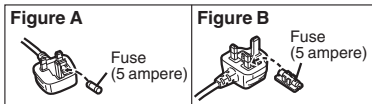

### Information for Users on Collection and Disposal of Old Equipment and used Batteries



These symbols on the products, packaging, and/or accompanying documents mean that used electrical and electronic products and batteries should not be mixed with general household waste. For proper treatment, recovery and recycling of old products and used batteries, please take them to applicable collection points, in accordance with your national legislation and the Directives 2002/96/EC and 2006/66/EC.

By disposing of these products and batteries correctly, you will help to save valuable resources and prevent any potential negative effects on human health and the environment which could otherwise arise from inappropriate waste handling.

For more information about collection and recycling of old products and batteries, please contact your local municipality, your waste disposal service or the point of sale where you purchased the items.

Penalties may be applicable for incorrect disposal of this waste, in accordance with national legislation.



#### For business users in the European Union

If you wish to discard electrical and electronic equipment, please contact your dealer or supplier for further information.

#### [Information on Disposal in other Countries outside the European Union]

These symbols are only valid in the European Union. If you wish to discard these items, please contact your local authorities or dealer and ask for the correct method of disposal.



#### Note for the battery symbol (bottom two symbol examples):

This symbol might be used in combination with a chemical symbol. In this case it complies with the requirement set by the Directive for the chemical involved.

Cd

### ■ About the battery charger

#### CAUTION!

- DO NOT INSTALL OR PLACE THIS UNIT IN A BOOKCASE, BUILT-IN CABINET OR IN ANOTHER CONFINED SPACE. ENSURE THE UNIT IS WELL VENTILATED. TO PREVENT RISK OF ELECTRIC SHOCK OR FIRE HAZARD DUE TO OVERHEATING, ENSURE THAT CURTAINS AND ANY OTHER MATERIALS DO NOT OBSTRUCT THE VENTILATION VENTS.
- DO NOT OBSTRUCT THE UNIT'S VENTILATION OPENINGS WITH NEWSPAPERS, TABLECLOTHS, CURTAINS, AND SIMILAR ITEMS.
- DO NOT PLACE SOURCES OF NAKED FLAMES, SUCH AS LIGHTED CANDLES, ON THE UNIT.
- DISPOSE OF BATTERIES IN AN ENVIRONMENTALLY FRIENDLY MANNER.

- The battery charger is in the standby condition when the AC power supply cord is connected. The primary circuit is always "live" as long as the power cord is connected to an electrical outlet.



### ■ About the battery pack

- Do not heat or expose to flame.
- Do not leave the battery(ies) in an automobile exposed to direct sunlight for a long period of time with doors and windows closed.

### ■ Care of the camera

#### • Do not strongly shake or bump the camera by dropping it etc.

This unit may malfunction, recording pictures may no longer be possible or the lens or the LCD monitor may be damaged.

- We strongly recommend you do not leave the camera in your trousers pocket when you sit down or forcefully insert it into a full or tight bag etc. Damage to the LCD monitor or personal injury may result.

#### • Be particularly careful in the following places as they may cause this unit to malfunction.

- Places with a lot of sand or dust.
- Places where water can come into contact with this unit such as when using it on a rainy day or on a beach.

#### • Do not touch the lens or the sockets with dirty hands. Also, be careful not to allow liquids, sand and other foreign matter to get into the space around the lens, buttons etc.

- If water or seawater splashes on the camera, use a dry cloth to wipe the camera body carefully.



### ■ About Condensation (When the lens is fogged up)

- Condensation occurs when the ambient temperature or humidity changes. Be careful of condensation since it causes lens stains, fungus and camera malfunction.
- If condensation occurs, turn the camera off and leave it for about 2 hours. The fog will disappear naturally when the temperature of the camera becomes close to the ambient temperature.

### ■ Read together with the “Cautions for Use”. (P100)

# Contents



## Before Use

Information for Your Safety .....	2
Quick Guide .....	8
Accessories .....	9
Names of the Components .....	10

## Preparation

































Charging the Battery .....	12
About the Battery (charging/number of recordable pictures) .....	13
Inserting and Removing the Card (optional)/the Battery .....	14
About the Built-in Memory/the Card .....	15
Setting Date/Time (Clock Set) .....	16
• Changing the clock setting .....	17
Setting the Menu .....	17
• Setting menu items .....	18
• Using the quick menu .....	19
About the Setup Menu .....	20
Selecting the [REC] Mode .....	24

## Basic

Taking pictures using the automatic function	
(  : Intelligent Auto Mode) .....	25
• Scene detection .....	26
• AF Tracking Function .....	26
• About the flash .....	27
• Settings in Intelligent auto mode .....	27
Taking pictures with your favourite settings (  : Normal picture mode) .....	28
• Focusing .....	28
• When the subject is not in focus (such as when it is not in the centre of the composition of the picture you want to take) .....	29
• Preventing jitter (camera shake) .....	29
• Direction detection function .....	29
Taking Pictures with the Zoom .....	30
• Using the Optical Zoom/ Using the Extra Optical Zoom (EZ)/ Using the Digital Zoom .....	30
Playing back Pictures	
([NORMAL PLAY]) .....	31
• Displaying Multiple Screens (Multi Playback) .....	32
• Using the Playback Zoom .....	32
• Switching the [PLAYBACK] mode .....	33

Deleting Pictures .....	33
• To delete a single picture .....	33
• To delete multiple pictures (up to 50) or all the pictures .....	34

## Advanced (Recording pictures)

About the LCD Monitor .....	35
Taking Pictures using the Built-in Flash .....	37
• Switching to the appropriate flash setting .....	37
Taking Close-up Pictures .....	40
Taking Pictures with the Self-timer .....	41
Compensating the Exposure .....	42
Taking Pictures using Auto Bracket .....	43
Taking pictures that match the scene being recorded (  : Scene mode) .....	44
•  [PORTRAIT] .....	44
•  [SOFT SKIN] .....	45
•  [TRANSFORM] .....	45
•  [SELF PORTRAIT] .....	45
•  [SCENERY] .....	46
•  [SPORTS] .....	46
•  [NIGHT PORTRAIT] .....	46
•  [NIGHT SCENERY] .....	46
•  [FOOD] .....	47
•  [PARTY] .....	47
•  [CANDLE LIGHT] .....	47
•  [BABY1]/  [BABY2] .....	47
•  [PET] .....	48
•  [SUNSET] .....	48
•  [HIGH SENS.] .....	48
•  [HI-SPEED BURST] .....	49
•  [FLASH BURST] .....	49
•  [STARRY SKY] .....	50
•  [FIREWORKS] .....	50
•  [BEACH] .....	50
•  [SNOW] .....	51
•  [AERIAL PHOTO] .....	51
•  [PIN HOLE] .....	51
•  [FILM GRAIN] .....	52
•  [UNDERWATER] .....	52
Motion Picture Mode .....	53
Useful Functions at Travel Destinations .....	55
• Recording which Day of the Vacation You Take the Picture .....	55
• Recording Dates/Times at Overseas Travel Destinations (World Time) .....	56
Using the [REC] Mode Menu .....	58
•  [PICTURE SIZE] .....	58
•  [QUALITY] .....	59
•  [ASPECT RATIO] .....	59
•  [INTELLIGENT ISO] .....	59
•  [SENSITIVITY] .....	60
•  [WHITE BALANCE] .....	60

•  [AF MODE] .....	62
•  [QUICK AF] .....	63
•  [BURST] .....	64
•  [I.EXPOSURE] .....	64
•  [DIGITAL ZOOM] .....	65
•  [COLOR MODE] .....	65
•  [STABILIZER] .....	65
•  [MIN. SHTR SPEED] .....	66
•  [AUDIO REC.] .....	66
•  [AF ASSIST LAMP] .....	66
•  [CLOCK SET] .....	67
Taking and viewing clipboard pictures	
[Clipboard mode] .....	68
• Taking clipboard pictures .....	68
• Viewing clipboard pictures .....	69

## Advanced (Playback)

Playing Back Pictures in Sequence		
(Slide Show) .....	71	
Selecting Pictures and Playing them Back ([CATEGORY PLAY]/[FAVORITE PLAY]) .....		73
• [CATEGORY PLAY] .....	73	
• [FAVORITE PLAY] .....	74	
Playing Back Motion Pictures/ Pictures with Audio .....		74
• Motion pictures .....	74	
• Pictures with audio .....	75	
Creating still pictures from a motion picture .....		75
Using the [PLAYBACK] mode menu .....		76
•  [CALENDAR] .....	76	
•  [TITLE EDIT] .....	77	
•  [TEXT STAMP] .....	78	
•  [RESIZE] .....	80	
•  [TRIMMING] .....	81	
•  [LEVELING] .....	82	
•  [ASPECT CONV.] .....	82	
•  [ROTATE]/ [ROTATE DISP.] .....	83	
•  [FAVORITE] .....	84	
•  [DPOF PRINT] .....	85	
•  [PROTECT] .....	86	
•  [AUDIO DUB.] .....	87	
•  [COPY] .....	88	

## Connecting to other equipment

Connecting to a PC .....		89
Printing the Pictures .....		92
• Selecting a single picture and printing it .....		93
• Selecting multiple pictures and printing them .....		93
• Print Settings .....		94

Playing Back Pictures on a TV Screen ... 96	
• Playing back pictures using the AV cable (supplied) .....	96
• Playing back pictures on a TV with an SD Memory Card slot .....	96
• Playing back on the TV with component socket .....	97

## Others

Screen Display .....	98	
Cautions for Use .....	100	
Message Display .....	103	
Functions that cannot be set or will not work under some conditions ....		105
Troubleshooting .....	107	
Number of Recordable Pictures and Available Recording Time .....		114
Specifications .....	117	

## Sales and Support Information

### Customer Care Centre

- For customers within the UK:  
0844 844 3852
- For customers within the Republic of  
Ireland: 01 289 8333
- Visit our website for product information
- E-mail: [customer.care@panasonic.co.uk](mailto:customer.care@panasonic.co.uk)

### Technical Support for AV Software

- For customers within the UK: 0844 844 3869
- For customers within the Republic of Ireland:  
01 289 8333

### Direct Sales at Panasonic UK

- For customers: 0844 844 3856
  - Order accessory and consumable items for  
your product with ease and confidence by  
phoning our Customer Care Centre  
Monday – Thursday 9.00 a.m. – 5.30 p.m.,  
Friday 9.30 a.m. – 5.30 p.m.  
(Excluding public holidays)
  - Or go on line through our Internet Accessory  
ordering application at  
[www.panasonic.co.uk](http://www.panasonic.co.uk).
  - Most major credit and debit cards accepted.
  - All enquiries transactions and distribution  
facilities are provided directly by Panasonic  
UK Ltd.
  - It couldn't be simpler!
  - Also available through our Internet is direct  
shopping for a wide range of finished  
products, take a browse on our website for  
further details.
- Interested in purchasing an extended  
guarantee?  
Please call 0870 240 6284 or visit our website  
[www.panasonic.co.uk/guarantee](http://www.panasonic.co.uk/guarantee).*

## Quick Guide

This is an overview of how to record and play back pictures with the camera. For each step, be sure to refer to the pages indicated in brackets.

### 1 Charge the battery. (P12)

- The battery is not charged when the camera is shipped. Charge the battery before use.

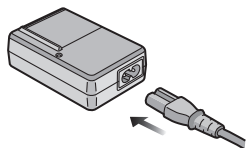

### 2 Insert the battery and the card. (P14)

- When you do not use the card, you can record or play back pictures on the built-in memory. (P15) Refer to P15 when you use a card.

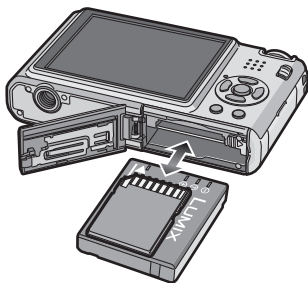

### 3 Turn the camera on to take pictures.

- 1 Slide the [REC]/[PLAYBACK] selector switch to [RECORD].
- 2 Press the shutter button to take pictures. (P25)

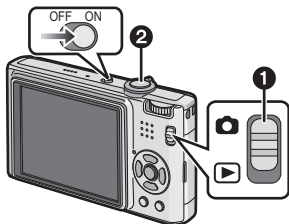

### 4 Play back the pictures.

- 1 Slide the [REC]/[PLAYBACK] selector switch to [PLAYBACK].
- 2 Select the picture you want to view. (P31)

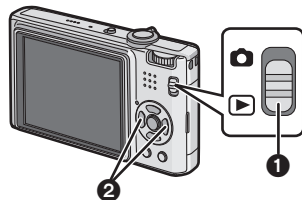

## Accessories

Check that all the accessories are included before using the camera.

- 1 Battery Pack  
(Indicated as **battery** in the text)  
Charge the battery before use.
- 2 Battery Charger  
(Indicated as **charger** in the text)
- 3 AC Mains Lead
- 4 USB Connection Cable
- 5 AV Cable
- 6 CD-ROM
  - Software:  
Use it to install the software to your PC.
- 7 Strap
- 8 Battery Carrying Case

• SD Memory Card, SDHC Memory Card and MultiMediaCard are indicated as **card** in the text.

• **The card is optional.**

**You can record or play back pictures on the built-in memory when you are not using a card.**

• Consult the dealer or your nearest Service Centre if you lose the supplied accessories. (You can purchase the accessories separately.)

### ■ Optional Accessories

- Battery Pack  
DMW-BCE10E
- Soft Case  
DMW-CS5
- Leather Case  
DMW-CXA1
- Semi Hard Case  
DMW-CHFX30
- Marine Case  
DMW-MCFX35
- AC Adaptor  
DMW-AC5EB
- Component Cable  
DMW-HDC2
- SDHC Memory Card
  - 32 GB: RP-SDV32GE1K
  - 16 GB: RP-SDV16GE1K
  - 8 GB: RP-SDV08GE1K
  - 4 GB: RP-SDM04GE1K/RP-SDV04GE1K
- SD Memory Card
  - 2 GB: RP-SDM02GE1A/RP-SDV02GE1A
  - 1 GB: RP-SDR01GE1A/RP-SDV01GE1A
- CardBus PC Card Adapter  
BN-SDPC3E

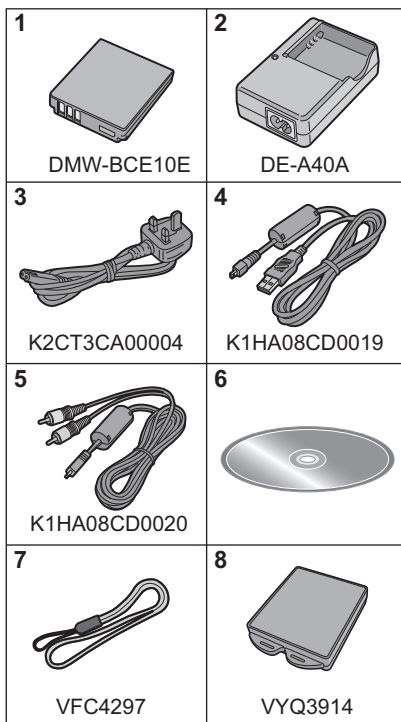

Some optional accessories may not be available in some countries.

## Names of the Components

- 1 Flash (P37)
- 2 Lens (P5, 101)
- 3 Self-timer indicator (P41)  
AF assist lamp (P66)

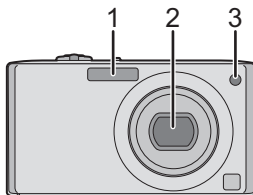

- 4 LCD monitor (P35, 98)
- 5 Status indicator (P14, 21, 25)
- 6 [MENU/SET] button (P16)
- 7 [DISPLAY] button (P35)
- 8 [Q.MENU] (P19)/Delete (P33) button
- 9 [REC]/[PLAYBACK] selector switch (P17)

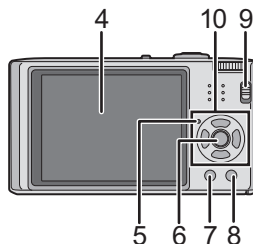

### 10 Cursor buttons

- Ⓐ: ▲/Exposure compensation (P42)/  
Auto bracket (P43)/White balance  
fine adjustment (P61)
- Ⓑ: ▼/Macro mode (P40)  
AF Tracking (P26, 63)
- Ⓒ: ◀/Self-timer button (P41)
- Ⓓ: ▶/Flash setting button (P37)

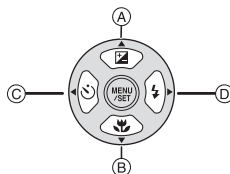

In these operating instructions, the cursor buttons are described as shown in the figure below or described with ▲/▼/◀/▶.  
e.g.: When you press the ▼ (down) button

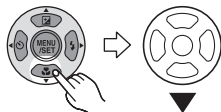

or

**Press ▼**

- 11 Camera ON/OFF switch (P16)
- 12 Zoom lever (P30)
- 13 Speaker (P74)
- 14 Microphone (P53, 66, 87)
- 15 Shutter button (P25, 53)
- 16 Mode dial (P24)

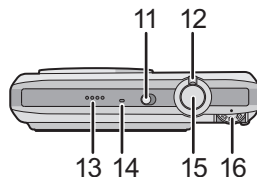

- 17 Strap eyelet
- 18 Lens barrel
- 19 [COMPONENT OUT] socket (P97)
- 20 [AV OUT/DIGITAL] socket (P89, 92, 96)
- 21 [DC IN] socket (P89, 92)

- Be sure to attach the strap when using the camera to ensure that you will not drop it.

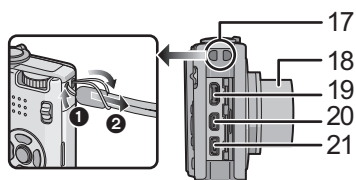

- Always use a genuine Panasonic AC adaptor (DMW-AC5E; optional).
- This camera cannot charge the battery even when the AC adaptor (DMW-AC5E; optional) is connected to it.

- 22 Tripod receptacle
- 23 Card/Battery door (P14)
- 24 Release lever (P14)

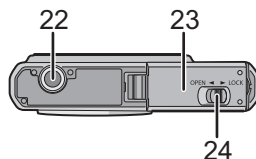

## Charging the Battery

- Use the dedicated charger and battery.
- The battery is not charged when the camera is shipped. Charge the battery before use.
- Charge the battery with the charger indoors.
- Charge the battery in a temperature between 10 °C to 35 °C (50 °F to 95 °F). (The battery temperature should also be the same.)

### 1 Attach the battery with attention to the direction of the battery.

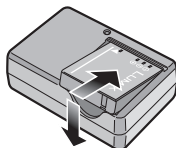

### 2 Connect the AC mains lead.

- The AC mains lead does not fit entirely into the AC input terminal. A gap will remain as shown below.
- Charging starts when the [CHARGE] indicator (A) lights green.
- Charging is complete when the [CHARGE] indicator (A) turns off (after approx. 120 min maximum).

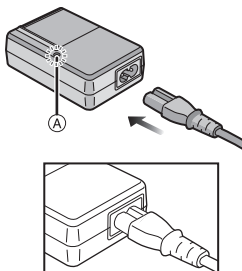

### 3 Detach the battery after charging is completed.

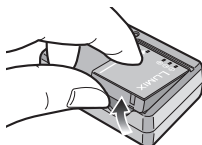

#### ■ When the [CHARGE] indicator flashes

- The battery temperature is excessively high or low. The charging time will be longer than normal. Also, charging may not be completed.
- The terminals of the charger or the battery are dirty. In this case, wipe them with a dry cloth.

#### 🔑 Note

- After charging is completed, be sure to disconnect the power supply device from the electrical outlet.
- The battery becomes warm after using it and during and after charging. The camera also becomes warm during use. This is not a malfunction.
- The battery will be exhausted if left for a long period of time after being charged.
- The battery can be recharged even when it still has some charge left, but it is not recommended that the battery charge be frequently topped up while the battery is fully charged. (The battery has characteristics that will reduce its operating duration and cause the battery to swell up.)
- When the operating time of the camera becomes extremely short even after properly charging the battery, the life of the battery may have expired. Buy a new battery.
- Do not leave any metal items (such as clips) near the contact areas of the power plug. Otherwise, a fire and/or electric shocks may be caused by short-circuiting or the resulting heat generated.



## About the Battery (charging/number of recordable pictures)

### ■ Battery indication

The battery indication is displayed on the LCD monitor.

[It does not appear when you use the camera with the AC adaptor (DMW-AC5E; optional) connected.]



• The indication turns red and blinks if the remaining battery power is exhausted. (The status indicator blinks when the LCD monitor turns off.) Recharge the battery or replace it with a fully charged battery.

### ■ The battery life

<b>Number of recordable pictures</b>	<b>Approx. 310 pictures</b>	By CIPA standard in normal picture mode
<b>Recording time</b>	<b>Approx. 150 min</b>	

### Recording conditions by CIPA standard

- CIPA is an abbreviation of [Camera & Imaging Products Association].
- Temperature: 23 °C (73.4 °F)/Humidity: 50% when LCD monitor is on.\*
- Using a Panasonic SD Memory Card (32 MB).
- Using the supplied battery.
- Starting recording 30 seconds after the camera is turned on. (When the optical image stabilizer function is set to [AUTO].)
- **Recording once every 30 seconds** with full flash every second recording.
- Rotating the zoom lever from Tele to Wide or vice versa in every recording.
- Turning the camera off every 10 recordings and leaving it until the temperature of the battery decreases.

\* The number of recordable pictures decreases in Auto Power LCD mode and Power LCD mode. (P21)

**The number of recordable pictures varies depending on the recording interval time. If the recording interval time becomes longer, the number of recordable pictures decreases. [e.g. When recording once every 2 minutes, the number of recordable pictures decreases to about 77.]**

<b>Playback time</b>	<b>Approx. 400 min</b>
----------------------	------------------------

The number of recordable pictures and playback time will vary depending on the operating conditions and storing condition of the battery.

### ■ Charging

<b>Charging time</b>	<b>Approx. 120 min maximum</b>
----------------------	--------------------------------

Charging time and **number of recordable pictures** with the optional battery pack (DMW-BCE10E) are the same as above.

The **charging time** will vary slightly depending on the status of the battery and the conditions in the charging environment.

When the charging has been completed successfully, the [CHARGE] indicator turns off.

### ● Note

- The battery may swell and its operating time may become shorter as the number of times it is charged increases. For long term battery use, we recommend you do not frequently charge the battery before it is exhausted.
- The performance of the battery may temporarily deteriorate and the operating time may become shorter in low temperature conditions (e.g. skiing/snowboarding).

## Inserting and Removing the Card (optional)/the Battery

- Check that this unit is turned off.
- We recommend using a Panasonic card.

**1** Slide the release lever in the direction of the arrow and open the card/battery door.

- Always use genuine Panasonic batteries (DMW-BCE10E).
- If you use other batteries, we cannot guarantee the quality of this product.

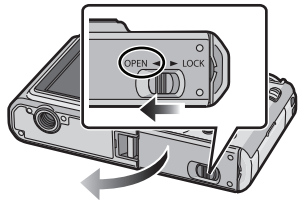

**2** **Battery:** Insert it fully being careful about the direction you insert it. Pull the lever **A** in the direction of the arrow to remove the battery.

**Card:** Push it fully until it clicks being careful about the direction you insert it. To remove the card, push the card until it clicks, then pull the card out upright.

- B:** Do not touch the connection terminals of the card.
- The card may be damaged if it is not fully inserted.

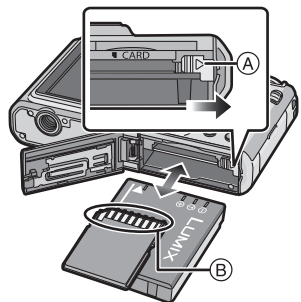

**3** **1:** Close the card/battery door.

**2:** Slide the release lever in the direction of the arrow.

- If the card/battery door cannot be completely closed, remove the card, check its direction and then insert it again.

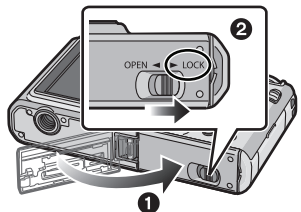

### Note

- Remove the battery after use. Store the removed battery in the battery carrying case (supplied).
- Do not remove the battery until the LCD monitor and the status indicator (green) turn off as the settings on the camera may not be stored properly.
- The supplied battery is designed only for the camera. Do not use it with any other equipment.
- Before removing the card or battery, turn the camera off, and wait until the status indicator has gone off completely. (Otherwise, this unit may no longer operate normally and the card itself may be damaged or the recorded pictures may be lost.)



## About the Built-in Memory/the Card

The following operations can be performed using this unit.

- **When a card has not been inserted:** Pictures can be recorded in the built-in memory and played back.
- **When a card has been inserted:** Pictures can be recorded on the card and played back.

- Clipboard pictures (P68) are stored on the built-in memory even if a card is inserted.

- **When using the built-in memory**

 →  (access indication \*)

- **When using the card**

 (access indication \*)

- \* The access indication lights red when pictures are being recorded on the built-in memory (or the card).

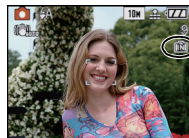

### Built-in Memory

- **Memory size: Approx. 50 MB**
- **Recordable motion pictures: QVGA (320×240 pixels) only**
- The built-in memory can be used as a temporary storage device when the card being used becomes full.
- You can copy the recorded pictures to a card. (P88)
- The access time for the built-in memory may be longer than the access time for a card.

### Card

The following types of cards can be used with this unit.

(These cards are indicated as **card** in the text.)

Type of card	Characteristics
<b>SD Memory Card (8 MB to 2 GB)</b> (Formatted using the FAT12 or FAT16 format in compliance with the SD standard)	<ul style="list-style-type: none"> <li>• Fast recording and writing speed</li> <li>• Write-Protect switch (A) provided (When this switch is set to the [LOCK] position, no further data writing, deletion or formatting is possible. The ability to write, delete and format data is restored when the switch is returned to its original position.)</li> </ul> 
<b>SDHC Memory Card (4 GB, 8 GB, 16 GB, 32 GB)*</b> (Formatted using the FAT32 format in compliance with the SD standard)	
<b>MultiMediaCard</b>	<ul style="list-style-type: none"> <li>• Still pictures only.</li> </ul>

- \* The SDHC Memory Card is a memory card standard decided by the SD Association in 2006 for high capacity memory cards more than 2 GB.

- \* You can use an SDHC Memory Card in equipment that is compatible with SDHC Memory Cards however you cannot use an SDHC Memory Card in equipment that is only compatible with SD Memory Cards. (Always read the operating instructions for the equipment being used.)

- You can only use cards with SDHC logo (indicating compliance with the SD standard) if using cards with 4 GB or more capacity.

- Please confirm the latest information on the following website.

<http://panasonic.co.jp/pavc/global/cs>

(This Site is English only.)

### Note

- Do not turn this unit off, remove its battery or card or disconnect the AC adaptor (DMW-AC5E; optional) when the access indication is lit [when pictures are being read or deleted or the built-in memory or the card is being formatted (P23)]. Furthermore, do not subject the camera to vibration or impact. The card or the data on the card may be damaged, and this unit may no longer operate normally.
- The data on the built-in memory or the card may be damaged or lost due to electromagnetic waves, static electricity or breakdown of the camera or the card. We recommend storing important data on a PC etc.
- Do not format the card on your PC or other equipment. Format it on the camera only to ensure proper operation. (P23)
- Keep the Memory Card out of reach of children to prevent swallowing.

## Setting Date/Time (Clock Set)

- The clock is not set when the camera is shipped.

### 1 Turn the camera on.

- The [PLEASE SET THE CLOCK] message appears. (This message does not appear in [PLAYBACK] mode.)

- (A) [MENU/SET] button
- (B) Cursor buttons

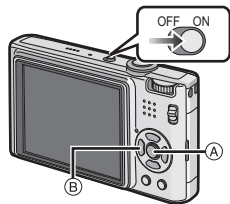

### 2 Press [MENU/SET].

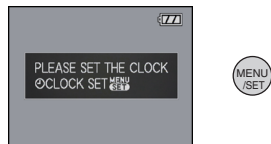

### 3 Press ◀/▶ to select the items (year, month, day, hour, minute, display sequence or time display format), and press ▲/▼ to set.

- (A): Time at the home area
- (B): Time at the travel destination (P56)
- ⏏: Cancel without setting the clock.
- Select either [24HRS] or [AM/PM] for the time display format.
- AM/PM is displayed when [AM/PM] is selected.

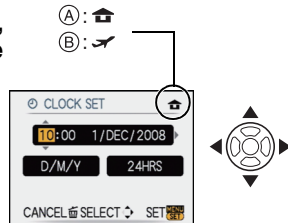

### 4 Press [MENU/SET] to set.

- After completing the clock settings, turn the camera off. Then turn the camera back on, switch to recording mode, and check that the display reflects the settings that were performed.
- When [MENU/SET] has been pressed to complete the settings without the clock having been set, set the clock correctly by following the "Changing the clock setting" procedure below.

## Changing the clock setting

Select **[CLOCK SET]** in the **[REC]** or **[SETUP]** menu, and press **▶**. (P18)

- It can be changed in steps 3 and 4 to set the clock.
- The clock setting is maintained for 3 months using the built-in clock battery even without the battery. (Leave the charged battery in the unit for 24 hours to charge the built-in battery.)**

### Note

- The clock is displayed when **[DISPLAY]** is pressed several times during recording.
- You can set the year from 2000 to 2099.
- If the clock is not set, the correct date cannot be printed when you stamp the date on the pictures with **[TEXT STAMP]** (P78) or order a photo studio to print the pictures.
- If the clock is set, the correct date can be printed even if the date is not displayed on the screen of the camera.

## Setting the Menu

The camera comes with menus that allow you to set the settings for taking pictures and playing them back just as you like and menus that enable you to have more fun with the camera and use it more easily.

In particular, the **[SETUP]** menu contains some important settings relating to the camera's clock and power. Check the settings of this menu before proceeding to use the camera.

### [MODE] playback mode menu (P31, 71 to 74)

- This menu lets you select the setting of the playback methods such as playback or slide show of only the pictures set as **[FAVORITE]**.

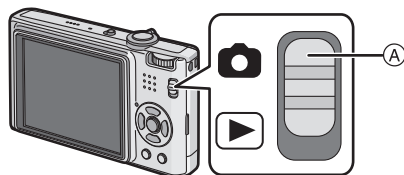
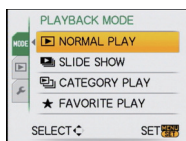

A [REC]/[PLAYBACK] selector switch

### ▶ [PLAYBACK] mode menu (P76 to 88)

- This menu lets you make the rotation, protection, trimming or DPOF settings, etc. of recorded pictures.

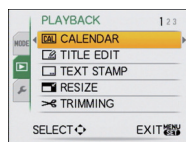

### 📷 [REC] mode menu (P58 to 67)

- This menu lets you set the colouring, sensitivity, aspect ratio, number of pixels and other aspects of the pictures you are recording.



### ⚙️ [SETUP] menu (P20 to 23)

- This menu lets you perform the clock settings, select the operating beep tone settings and set other settings which make it easier for you to operate the camera.
- The **[SETUP]** menu can be set from either the **[REC MODE]** or **[PLAYBACK MODE]**.

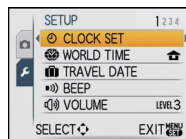

## ■ Functions that cannot be set or will not work under some conditions

Due to the camera's specifications, it may not be possible to set some of the functions or some functions may not work in some of the conditions under which the camera is used. For details, refer to P105.

### Setting menu items

This section describes how to select the normal picture mode settings, and the same setting can be used for the [PLAYBACK] menu and [SETUP] menu as well.

Example: Setting [AF MODE] from [□] to [👤] in the normal picture mode

#### 1 Turn the camera on.

- (A) [MENU/SET] button
- (B) [REC]/[PLAYBACK] selector switch
- (C) Mode dial

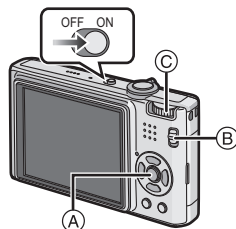

#### 2 Slide the [REC]/[PLAYBACK] selector switch to [📷].

- When selecting the [PLAYBACK] mode menu settings, set the [REC]/[PLAYBACK] selector switch to [▶], and proceed to step 4.

#### 3 Set the mode dial to [📷].

#### 4 Press [MENU/SET] to display the menu.

- You can switch menu screens from any menu item by rotating the zoom lever.



### Switching to the [SETUP] menu

#### 1 Press ◀.



#### 2 Press ▼ to select the [SETUP] menu icon [⚙️].

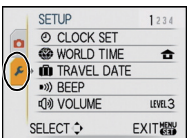

#### 3 Press ▶.

- Select a menu item next and set it.



## 5 Press ▲/▼ to select [AF MODE].

- Select the item at the very bottom, and press ▼ to move to the second screen.

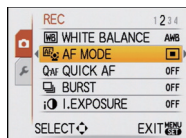

## 6 Press ►.

- Depending on the item, its setting may not appear or it may be displayed in a different way.

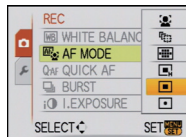

## 7 Press ▲/▼ to select [Q.AF].

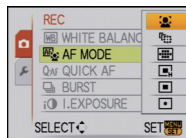

## 8 Press [MENU/SET] to set.

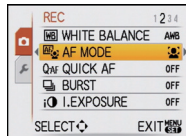

## 9 Press [MENU/SET] to close the menu.

### Using the quick menu

By using the quick menu, some of the menu settings can be easily found.

- Some of the menu items cannot be set by the modes.
- When [DISPLAY] is pressed while [STABILIZER] (P65) is selected, [JITTER, SUBJ. MOVE DEMO.] can be displayed.

## 1 Press and hold [Q.MENU] when recording.

## 2 Press ▲/▼/◀/▶ to select the menu item and the setting and then press [MENU/SET] to close the menu.

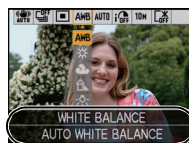

Q.MENU



A

- Ⓐ The items to be set and the settings are displayed.

Perform these settings if you need to.

## About the Setup Menu



[CLOCK SET], [ECONOMY] and [AUTO REVIEW] are important items. Check their settings before using them.

- In the Intelligent auto mode, only [CLOCK SET], [WORLD TIME], [TRAVEL DATE], [BEEP] and [LANGUAGE] can be set.

For details on how to select the [SETUP] menu settings, refer to P18.

 [CLOCK SET]	Setting Date/Time.
--	--------------------













- Refer to P16 for details.

 [WORLD TIME]	Set the time in your home area and travel destination.	
	 [DESTINATION]: Travel destination area   [HOME]: Your home area	

- Refer to P56 for details.

 [TRAVEL DATE]	Set the departure date and the return date of the vacation.	
	[TRAVEL SETUP] [OFF]/[SET]	[LOCATION] [OFF]/[SET]

- Refer to P55 for details.



 [BEEP]	This allows you to set the beep and shutter sound.	
	 [BEEP LEVEL]:  (Muted)  (Low)  (High)	 [SHUTTER VOL.]:  (Muted)  (Low)  (High)
	 [BEEP TONE]: 	 [SHUTTER TONE]: 

 [VOLUME]	Adjust the volume of the speaker to any of 7 levels.
---	--



- When you connect the camera to a TV, the volume of the TV speakers does not change.

 [MONITOR]	Adjust the brightness of the LCD monitor in 7 steps.
--	--





 <b>[LCD MODE]</b>	These menu settings make it easier to see the LCD monitor when you are in bright places.	
	<p><b>[OFF]</b></p> <p> <b>[AUTO POWER LCD]:</b> The brightness is adjusted automatically depending on how bright it is around the camera.</p> <p> <b>[POWER LCD]:</b> The LCD monitor becomes brighter and easier to see even when taking pictures outdoors.</p>	

- The brightness of the pictures displayed on the LCD monitor is increased so some subjects may appear differently from actuality on the LCD monitor. However, this does not affect the recorded pictures.
- The LCD monitor automatically returns to normal brightness after 30 seconds when recording in Power LCD mode. Press any button to make the LCD monitor bright again.
- If the screen is difficult to see because of sunlight etc. shining on it, use your hand or another object to block the light.
- The number of recordable pictures decreases in Auto Power LCD mode and Power LCD mode.

 <b>[GUIDE LINE]</b>	Set the pattern of the guide lines displayed when taking pictures. You can also set whether or not to have the recording information displayed when the guide lines are displayed. (P35)	
	<b>[REC. INFO.]:</b> <b>[OFF]/[ON]</b>	<b>[PATTERN]:</b>  / 

- The [PATTERN] setting is fixed to  in the Intelligent auto mode and the clipboard mode.

 <b>[HISTOGRAM]</b>	This allows you to set either to display or not display the histogram. (P36)	
	<b>[OFF]/[ON]</b>	

<b>ECO [ECONOMY]</b>	You can conserve the battery life by setting these menus. Also, it will turn off the LCD monitor automatically when not in use to prevent discharge of the battery.	
	<p> <b>[POWER SAVE]:</b> The camera is automatically turned off if the camera has not been used for the time selected on the setting. <b>[OFF]/[2MIN.]/[5MIN.]/[10MIN.]</b></p>	
	<p> <b>[AUTO LCD OFF]:</b> The LCD monitor is automatically turned off if the camera has not been used for the time selected on the setting. <b>[OFF]/[15SEC.]/[30SEC.]</b></p>	

- Press the shutter button halfway or turn the camera off and on to cancel [POWER SAVE].
- [POWER SAVE] is set to [5MIN.] in the Intelligent auto mode and the clipboard mode.
- [POWER SAVE] is fixed to [2MIN.] when [AUTO LCD OFF] is set to [15SEC.] or [30SEC.].
- The status indicator lights while the LCD monitor is turned off. Press any button to turn on the LCD monitor again.
- [AUTO LCD OFF] does not work while operating menu or playback zoom.

 <b>[AUTO REVIEW]</b>	Set the length of time that the picture is displayed after taking it.
	<b>[OFF]</b> <b>[1SEC.]</b> <b>[2SEC.]</b> <b>[HOLD]:</b> The pictures are displayed until one any of the buttons is pressed. <b>[ZOOM]:</b> The picture is displayed for 1 second and then enlarged 4× and displayed for 1 more second.





- The auto review function is activated regardless of its setting when using auto bracket (P43), [HI-SPEED BURST] (P49) and [FLASH BURST] (P49) in scene mode, burst mode (P64) and when recording still pictures with audio (P66). (The pictures cannot be enlarged.)
- In Intelligent auto mode, the auto review function is fixed to [2SEC.]

 <b>[NO.RESET]</b>	Reset the file number of the next recording to 0001.
--	--

- The folder number is updated and the file number starts from 0001. (P91)
- A folder number between 100 and 999 can be assigned.  
When the folder number reaches 999, the number cannot be reset. We recommend formatting the card (P23) after saving the data on a PC or elsewhere.
- To reset the folder number to 100, format the built-in memory or the card first and then use this function to reset the file number.  
A reset screen for the folder number will then appear. Select [YES] to reset the folder number.

 <b>[RESET]</b>	The [REC] or [SETUP] menu settings are reset to the initial settings.
---	---

- When the [RESET] setting is selected during recording, the operation that resets the lens is also performed at the same time. You will hear the sound of the lens operating but this is normal and not indicative of malfunctioning.
- When [SETUP] menu settings are reset, the following settings are also reset. In addition, [ROTATE DISP.] (P83) is set to [ON], and [FAVORITE] (P84) is set to [OFF] in [PLAYBACK] mode menu.
  - The birthday and name settings for [BABY1]/[BABY2] (P47) and [PET] (P48) in scene mode.
  - The settings of [TRAVEL DATE] (P55) (departure date, return date, location)
  - The [WORLD TIME] (P56) setting.
- The folder number and the clock setting are not changed.

 <b>[USB MODE]</b>	Select the USB communication system after or before connecting the camera to your PC or your printer with the USB connection cable (supplied).
	 <b>[SELECT ON CONNECTION]:</b> Select either [PC] or [PictBridge(PTP)] if you connected the camera to a PC or a printer supporting PictBridge.  <b>[PictBridge(PTP)]:</b> Set after or before connecting to a printer supporting PictBridge.  <b>[PC]:</b> Set after or before connecting to a PC.

- When [PC] is selected, the camera is connected via the “USB Mass Storage” communication system.
- When [PictBridge(PTP)] is selected, the camera is connected via the “PTP (Picture Transfer Protocol)” communication system.

 [VIDEO OUT]	Set to match the colour television system in each country. (Playback mode only)
	<b>[NTSC]:</b> Video output is set to NTSC system. <b>[PAL]:</b> Video output is set to PAL system.

- This will work when the AV cable is connected.

 [TV ASPECT]	Set to match the type of TV. (Playback mode only)
	<b>[16:9]:</b> When connecting to a 16:9 screen TV. <b>[4:3]:</b> When connecting to a 4:3 screen TV.

- This will work when the AV cable is connected.

 [SCENE MENU]	Set the screen that will appear when a scene mode has been selected.
	<b>[OFF]:</b> The recording screen in the currently selected scene mode appears. <b>[AUTO]:</b> The [SCENE MODE] menu screen appears.

 [FORMAT]	The built-in memory or card is formatted. Formatting irretrievably deletes all the data so check the data carefully before formatting.
--	--

- Use a battery with sufficient battery power or the AC adaptor (DMW-AC5E; optional) when formatting. Do not turn the camera off during formatting.
- If a card has been inserted, only the card is formatted. To format the built-in memory, remove the card.
- If the card has been formatted on a PC or other equipment, format it on the camera again.
- It may take longer to format the built-in memory than the card.
- If you cannot format, contact the dealer or your nearest Service Centre.

 [LANGUAGE]	Set the language displayed on the screen.
	<b>[ENGLISH]/[DEUTSCH]/[FRANÇAIS]/[ESPAÑOL]/[ITALIANO]/[日本語]</b>

- If you set a different language by mistake, select  from the menu icons to set the desired language.

 [DEMO MODE]	Select this to display [JITTER, SUBJ. MOVE DEMO.] or the camera's features.
	<b>[JITTER, SUBJ. MOVE DEMO.]</b> <b>[AUTO DEMO]:</b> The camera's features are displayed as a slide show.

- (A) Jitter detection demonstration
- (B) Movement detection demonstration

- In playback mode, [JITTER, SUBJ. MOVE DEMO.] cannot be displayed.
- Press [DISPLAY] to close [JITTER, SUBJ. MOVE DEMO.]. Press [MENU/SET] to close [AUTO DEMO].
- [JITTER, SUBJ. MOVE DEMO.] is an approximation.
- [AUTO DEMO] has no TV output capability.



## Mode switching

## Selecting the [REC] Mode

When the [REC] mode is selected, the camera can be set to the Intelligent auto mode in which the optimal settings are established in line with the subject to be recorded and the recording conditions, or to the scene mode which enables you to take pictures that match the scene being recorded.

### 1 Turn the camera on.

- (A) [REC]/[PLAYBACK] selector switch
- (B) Mode dial

### 2 Slide the [REC]/[PLAYBACK] selector switch to [RECORDING].

### 3 Switching the mode by rotating the mode dial.

Align a desired mode with part (C).

- Rotate the mode dial slowly and surely to adjust to each mode. (The part where there is no mode will not turn.)

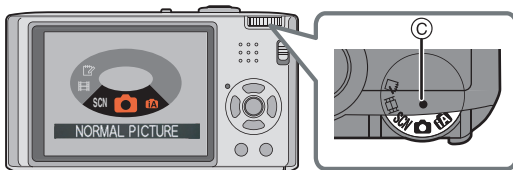
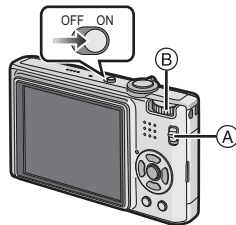

#### ■ List of [REC] modes

##### Intelligent auto mode (P25)

The subjects are recorded using settings automatically selected by the camera.

##### Normal picture mode (P28)

The subjects are recorded using your own settings.

##### SCN Scene mode (P44)

This allows you to take pictures that match the scene being recorded.

##### Motion picture mode (P53)

This mode allows you to record motion pictures with audio.

##### Clipboard mode (P68)

Record as a memo.

[REC] mode: **[iA]**

## Taking pictures using the automatic function

(**[iA]**: Intelligent Auto Mode)

The camera will set the most appropriate settings to match the subject and the recording conditions so we recommend this mode for beginners or those who want to leave the settings to the camera and take pictures easily.

- The following functions are activated automatically.
  - Scene detection/[STABILIZER]/[INTELLIGENT ISO]/Face detection/[QUICK AF]/[I.EXPOSURE]/Digital Red-eye Correction/Backlight Compensation
- The status indicator **3** lights when you turn this unit on **2**. (It turns off after about 1 second.)
- 1**: Shutter button

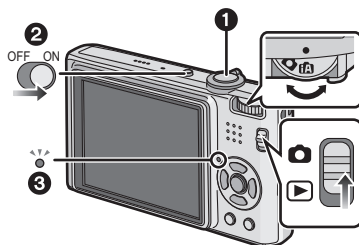

**1** Slide the [REC]/[PLAYBACK] selector switch to **[📷]**.

**2** Set the mode dial to **[iA]**.

**3** Hold this unit gently with both hands, keep your arms still at your side and stand with your feet slightly apart.

- (A) Flash
- (B) AF assist lamp

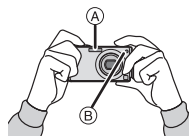

**4** Press the shutter button halfway to focus.

- The focus indication **1** (green) lights when the subject is focused.
- The AF area **2** is displayed around the subject's face by the face detection function. In other cases, it is displayed at the point on the subject which is in focus.
- The focus range is 5 cm (0.17 feet) (Wide)/1 m (3.28 feet) (Tele) to ∞.

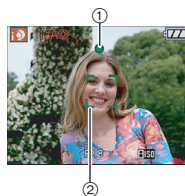

**5** Press the shutter button fully (push it in further), and take the picture.

- The access indication (P15) lights red when pictures are being recorded on the built-in memory (or the card).



## ■ When taking pictures using the flash (P37)

## ■ When taking pictures using the zoom (P30)



### Note

- Be careful not to move the camera when you press the shutter button.
- Do not cover the flash or the AF assist lamp with your fingers or other objects.
- Do not touch the front of the lens.

## Scene detection

When the camera identifies the optimum scene, the icon of the scene concerned is displayed in blue for 2 seconds, after which its colour changes to the usual red.

iA →		[i- PORTRAIT]	
		[i- SCENERY]	
		[i- MACRO]	
		[i- NIGHT PORTRAIT]	• Only when [4A] is selected
		[i- NIGHT SCENERY]	• Only when [4] is selected

- [iA] is set if none of the scenes are applicable, and the standard settings are set.
- If a tripod is used, for instance, and the camera has judged that camera shake is minimal when the scene mode has been identified as [i-SCENERY], the shutter speed will be set to a maximum of 8 seconds. Take care not to move the camera while taking pictures.
- An optimum scene for the specified subject will be chosen when set to AF tracking (P63).

## ■ Face detection

When [i-SCENERY] or [i- PORTRAIT] is selected, the camera automatically detects a person's face, and it will adjust the focus and exposure (P62).



### Note

- Due to conditions such as the ones below, a different scene may be identified for the same subject.
  - Subject conditions: When the face is bright or dark, The size of the subject, The distance to the subject, The contrast of the subject, When the subject is moving, When zoom is used
  - Recording conditions: Sunset, Sunrise, Under low brightness conditions, When the camera is shaken
- To take pictures in an intended scene, it is recommended that you take pictures in the appropriate recording mode.

## ■ The Backlight Compensation

Backlight refers to when light comes from the back of a subject.

In this case, the subject will become dark, so this function compensates the backlight by brightening the whole of the picture automatically.

## AF Tracking Function

It is possible to set the focus to the specified subject. Focus will keep following the subject automatically even if it moves. Refer to P63 for details.

- Set the [AF TRACKING] in the [REC] mode menu to [ON]. ([AF TRACKING] is displayed on the screen.)

### Bring the subject to the AF tracking frame, and press ▼ to lock the subject.

- AF tracking frame will turn yellow.
- An optimum scene for the specified subject will be chosen.
- Press ▼ again to release.



## About the flash

- When [iA] is selected, [iA], [iA] or [iS] is set depending on the type of subject and brightness.
- When [iA] or [iS] is set, digital red-eye correction (P38) is enabled, and the flash is activated twice.

## Settings in Intelligent auto mode

- Only the following functions can be set in this mode.

### [REC] mode menu



- [PICTURE SIZE]\* (P58)/[ASPECT RATIO] (P59)/[BURST] (P64)/[COLOR MODE]\* (P65)/[AF TRACKING]

- \* The settings which can be selected are different from when other [REC] modes are used.

### [SETUP] menu

- [CLOCK SET]/[WORLD TIME]/[TRAVEL DATE]/[BEEP]/[LANGUAGE]

- The settings of the following items are fixed.

Item	Settings
[GUIDE LINE] (P21)	 ([REC. INFO.]: [OFF])
[ECONOMY] ([POWER SAVE]) (P21)	[5MIN.]
[AUTO REVIEW] (P22)	[2SEC.]
Focus range	The focus range becomes the same as macro mode. [5 cm (0.17 feet) (Wide)/1 m (3.28 feet) (Tele) to ∞] (P40) • The maximum close-up distance (the shortest distance at which the subject can be taken) differs depending on the zoom magnification.
Self-timer (P41)	10 seconds
[QUALITY] (P59)	 (Set to [.] when picture size is [0.3M] (0.3M))
[INTELLIGENT ISO] (P59)	ISO MAX 800
[WHITE BALANCE] (P60)	[AWB]
[AF MODE] (P62)	 (Set to [AF] when a face cannot be detected)
[QUICK AF] (P63)	[ON]
[I.EXPOSURE] (P64)	[ON]
[STABILIZER] (P65)	[AUTO]
[AF ASSIST LAMP] (P66)	[ON]

- The following functions cannot be used.

- [EXPOSURE]/[AUTO BRACKET]/White balance fine adjustment/[DIGITAL ZOOM]/[AUDIO REC.]/[MIN. SHTR SPEED]/[HISTOGRAM]

- The other items on the [SETUP] menu can be set in a mode such as the normal picture mode. What is set will be reflected in the Intelligent auto mode.

[REC] mode: 

## Taking pictures with your favourite settings

(: Normal picture mode)

Many more menu items can be set and you can take pictures with greater freedom than when you take pictures in the Intelligent auto mode (P25).

- Slide the [REC]/[PLAYBACK] selector switch to .

- (A) Mode dial  
(B) [REC]/[PLAYBACK] selector switch

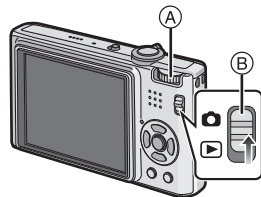

- Set the mode dial to .

- To change the setting while taking pictures, refer to "Using the [REC] Mode Menu" (P58).

- Aim the AF area at the point you want to focus on.

- Press the shutter button halfway to focus.

- The focus indication (green) lights when the subject is focused.
- The focus range is 50 cm (1.64 feet) (Wide)/1 m (3.28 feet) (Tele) to  $\infty$ .
- If pictures are to be taken at an even closer range, refer to "Taking Close-up Pictures" (P40).



- Press the halfway pressed shutter button fully to take a picture.

- The access indication lights (P15) red when pictures are being recorded on the built-in memory (or the card).



- To adjust the exposure and take pictures at times when the image appears too dark (P42)

- To adjust the colours and take pictures at times when the image appears too red (P60)

## Focusing

Aim the AF area at the subject, and then press the shutter button halfway.

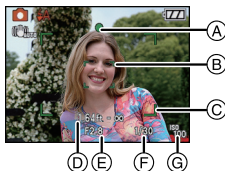

Focus	When the subject is focused	When the subject is not focused
Focus indication	On	Blinks
AF area	White → Green	White → Red
Sound	Beeps 2 times	Beeps 4 times



- (A) Focus indication
  - (B) AF area (normal)
  - (C) AF area (when using the digital zoom or when it is dark)
  - (D) Focus range
  - (E) Aperture value\*
  - (F) Shutter speed\*
  - (G) ISO sensitivity
- \* If correct exposure cannot be achieved, it will be displayed in red.  
(However, it will not be displayed in red when the flash is used.)

### When the subject is not in focus (such as when it is not in the centre of the composition of the picture you want to take)

- 1** Aim the AF area at the subject, and then **press the shutter button halfway** to fix the focus and exposure.
  - 2** **Press and hold the shutter button halfway** while moving the camera as you compose the picture.
- You can repeatedly retry the actions in step **1** before pressing the shutter button fully.

**We recommend that you use the face detection function when taking pictures of people. (P62)**



### ■ Subjects and recording conditions which are difficult to focus

- Fast-moving subjects, extremely bright subjects or subjects without contrast
- When the recordable range display has appeared in red.
- When recording subjects through windows or near shiny objects
- When it is dark or when jitter occurs
- When the camera is too close to the subject or when taking a picture of both distant and near subjects

### Preventing jitter (camera shake)

When the jitter alert ([ⓘ]) appears, use [STABILIZER] (P65), a tripod or the self-timer (P41).

- Shutter speed will be slower particularly in the following cases. Keep the camera still from the moment the shutter button is pressed until the picture appears on the screen. We recommend using a tripod.
  - Slow sync./Red-eye reduction
  - In [NIGHT PORTRAIT], [NIGHT SCENERY], [PARTY], [CANDLE LIGHT], [STARRY SKY] or [FIREWORKS] in scene mode (P44)
  - When the shutter speed is slowed in [MIN. SHTR SPEED]

### Direction detection function

Pictures recorded with the camera held vertically are played back vertically (rotated). (Only when [ROTATE DISP.] (P83) is set to [ON])

- Pictures may not be displayed vertically if they were taken with the camera aimed up or down.
- Motion pictures taken with the camera held vertically are not displayed vertically.

[REC] mode:    

## Taking Pictures with the Zoom

### Using the Optical Zoom/Using the Extra Optical Zoom (EZ)/Using the Digital Zoom

You can zoom-in to make people and objects appear closer or zoom-out to record landscapes in wide angle. To make subjects appear even closer [maximum of 8.9×], do not set the picture size to the highest setting for each aspect ratio (**4:3/3:2/16:9**). Even higher levels of magnification are possible when [DIGITAL ZOOM] is set to [ON] in [REC] menu.

**To make subjects appear closer use (Tele)**

**Rotate the zoom lever towards Tele.**







**To make subjects appear further away use (Wide)**

**Rotate the zoom lever towards Wide.**



#### ■ Types of zooms

Feature	Optical zoom	Extra optical zoom (EZ)	Digital zoom
Maximum magnification	5×	8.9×*1	20× [including optical zoom 5×] 35.6× [including extra optical zoom 8.9×]
Picture quality	No deterioration	No deterioration	The higher the magnification level, the greater the deterioration.
Conditions	None	[PICTURE SIZE] with  (P58) is selected.	[DIGITAL ZOOM] (P65) on the [REC] menu is set to [ON].
Screen display		 A  is displayed.	 B The digital zoom range is displayed. The AF area becomes larger when the shutter button is pressed halfway in the digital zoom range*2.

• When using the zoom function, an estimate of the focus range will appear in conjunction with the zoom display bar. (Example: 0.5 m (1.64 ft.) –∞)

\*1 The magnification level differs depending on [PICTURE SIZE] and [ASPECT RATIO] setting.

\*2 The on-screen zoom indication may momentarily stop moving when you rotate the zoom lever to the extreme Tele position. You can enter the digital zoom range by continuously rotating the zoom lever to Tele or releasing the zoom lever once and then rotating it to Tele again.

## ■ Extra optical zoom mechanism

When you set the picture size to [3M] (3 million pixels), the 10M (10.1 million pixels) CCD area is cropped to the centre 3M (3 million pixels) area, allowing a picture with a higher zoom effect.

### Note

- The digital zoom cannot be set when [A] or [B] has been selected.
- The indicated zoom magnification is an approximation.
- “EZ” is an abbreviation of “Extra optical Zoom”.
- The optical zoom is set to Wide (1×) when the camera is turned on.
- If you use the zoom function after focusing on the subject, focus on the subject again.
- The lens barrel extends or retracts according to the zoom position. Take care not to interrupt the motion of the lens barrel while the zoom lever is rotated.
- When using the digital zoom, [STABILIZER] may not be effective.
- When using the digital zoom, we recommend using a tripod and the self-timer (P41) for taking pictures.

[PLAYBACK] mode: [▶]

## Playing back Pictures ([NORMAL PLAY])

### 1 Slide the [REC]/[PLAYBACK] selector switch (A) to [▶].

- Normal playback is set automatically in the following cases.
  - When the mode was switched from the [REC] to [PLAYBACK].
  - When the camera was turned on while the [REC]/[PLAYBACK] selector switch was at [▶].
- When the mode dial is set to [📷], clipboard will be displayed. Refer to “Viewing clipboard pictures” (P69) for information about playing back the clipboard.

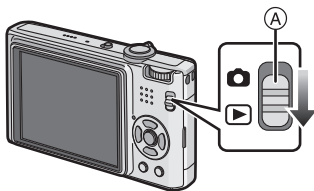

### 2 Press ◀/▶ to select the picture.

- ◀: Play back the previous picture
- ▶: Play back the next picture
- Speed of picture forwarding/rewinding changes depending on the playback status.

## ■ Fast forwarding/Fast rewinding

Press and hold ◀/▶ during playback.

- ◀: Fast rewind
- ▶: Fast forward

- The file number (A) and the picture number (B) only change one by one. Release ◀/▶ when the number of the desired picture appears to play back the picture.
- If you keep pressing ◀/▶, the number of pictures forwarded/rewound increases.

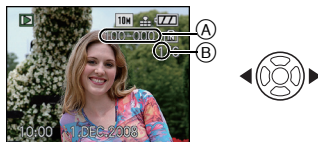

## Displaying Multiple Screens (Multi Playback)

### Rotate the zoom lever towards [W].

1 screen → 12 screens → 30 screens → Calendar screen display (P76)

- Ⓐ Number of the selected picture and the total number of recorded pictures
- Rotate the zoom lever towards [Q] (T) to return to the previous screen.
- Pictures are not rotated for display.

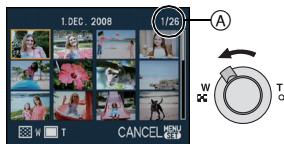

### ■ To return to normal playback

#### 1 Press ▲/▼/◀/▶ to select a picture.

- An icon will be displayed depending on the recorded picture and the settings.

#### 2 Press [MENU/SET].

- The picture that was selected will appear.

## Using the Playback Zoom

### Rotate the zoom lever towards [Q] (T).

1× → 2× → 4× → 8× → 16×

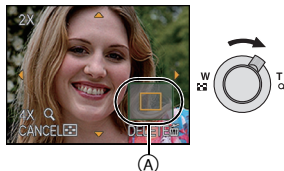

- When you rotate the zoom lever towards [W] (Wide) after enlarging the picture, the magnification becomes lower.
- When you change the magnification, the zoom position indication Ⓐ appears for about 1 second, and the position of the enlarged section can be moved by pressing ▲/▼/◀/▶.
- The more a picture is enlarged, the more its quality deteriorates.
- When you move the position to be displayed, the zoom position indication appears for about 1 second.



### Note

- This camera complies with the DCF standard "Design rule for Camera File system" established by JEITA "Japan Electronics and Information Technology Industries Association" and with Exif "Exchangeable Image File Format". Files which do not comply with the DCF standard cannot be played back.
- The lens barrel retracts about 15 seconds after switching from [REC] mode to [PLAYBACK] mode.
- If you want to save the enlarged picture, use the trimming function. (P81)
- The playback zoom may not operate if pictures have been recorded with other equipment.

## Switching the [PLAYBACK] mode

- 1 Press [MENU/SET] during playback.
- 2 Press .
- 3 Press / to select the item and then press [MENU/SET].

**[NORMAL PLAY] (P31)**

All the pictures are played back.

**[SLIDE SHOW] (P71)**

The pictures are played back in sequence.

**[CATEGORY PLAY] (P73)**

The pictures grouped together in categories are played back.

**[FAVORITE PLAY] (P74)\***

Your favourite pictures are played back.

\* [FAVORITE PLAY] is not displayed when [FAVORITE] has not been set.



[PLAYBACK] mode: 

## Deleting Pictures

**Once deleted, pictures cannot be recovered.**

- Pictures on the built-in memory or the card, which is being played back will be deleted.

## To delete a single picture

- 1 Select the picture to be deleted, and then press .

- (A) [DISPLAY] button  
(B)  button

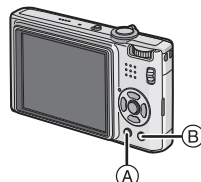

- 2 Press  to select [YES] and then press [MENU/SET].



## To delete multiple pictures (up to 50) or all the pictures

- 1 Press [].
- 2 Press ▲/▼ to select [DELETE MULTI] or [DELETE ALL] and then press [MENU/SET].
  - [DELETE ALL] → step 5.
- 3 Press ▲/▼/◀/▶ to select the picture, and then press [DISPLAY] to set. (Repeat this step.)
  - [] appears on the selected pictures. If [DISPLAY] is pressed again, the setting is cancelled.
- 4 Press [MENU/SET].
- 5 Press ▲ to select [YES] and then press [MENU/SET] to set.

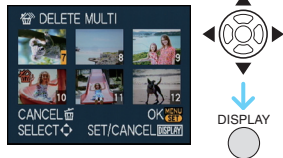

### ■ When [DELETE ALL] has been selected with the [FAVORITE] (P84) setting

The selection screen is displayed again. Select [DELETE ALL] or [ALL DELETE EXCEPT ★], press ▲ to select [YES] and delete the pictures. ([ALL DELETE EXCEPT ★] cannot be selected if no pictures have been set as [FAVORITE].)

#### Note

- Do not turn the camera off while deleting (while [] is displayed). Use a battery with a sufficient power or the AC adaptor (DMW-AC5E; optional).
- If you press [MENU/SET] while deleting pictures using [DELETE MULTI], [DELETE ALL] or [ALL DELETE EXCEPT ★], the deleting will stop halfway.
- Depending on the number of pictures to be deleted, it may take some time to delete them.
- If pictures do not conform to the DCF standard or are protected (P86), they will not be deleted even if [DELETE ALL] or [ALL DELETE EXCEPT ★] is selected.

## About the LCD Monitor

Press [DISPLAY] to change.

- Ⓐ LCD monitor
- Ⓑ [DISPLAY] button

• When the menu screen appears, the [DISPLAY] button is not activated. During playback zoom (P32), while playing back motion pictures (P74) and during a slide show (P71), you can only select "Normal display Ⓕ" or "No display Ⓖ".

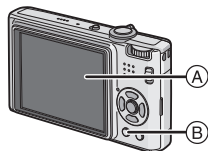

**In recording mode**

- Ⓒ Normal display\*1
- Ⓓ No display
- Ⓔ No display (Recording guide line)\*1, 2

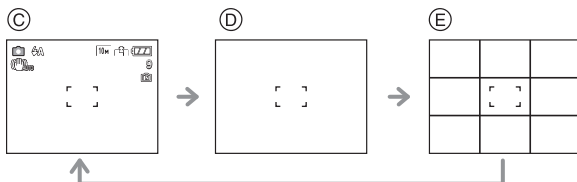

**In playback mode**

- Ⓕ Normal display
- Ⓖ Display with recording information\*1
- Ⓗ No display

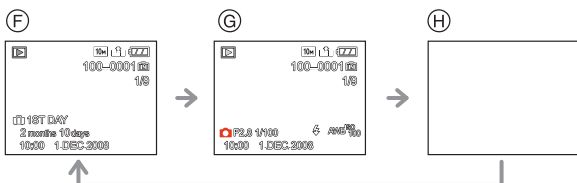

\*1 If the [HISTOGRAM] in [SETUP] menu is set to [ON], histogram will be displayed.

\*2 Set the pattern of the guide lines displayed by setting [GUIDE LINE] in [SETUP] menu. You can also set whether or not to have the recording information displayed when the guide lines are displayed.



### Note

• In [NIGHT PORTRAIT], [NIGHT SCENERY], [STARRY SKY] and [FIREWORKS] in scene mode, the guide line is grey. (P44)

### Recording guide line

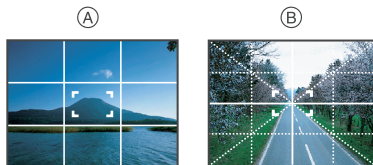
When you align the subject on the horizontal and vertical guide lines or the cross point of these lines, you can take pictures with well-designed composition by viewing the size, the slope and the balance of the subject.



- Ⓐ : This is used when dividing the entire screen into 3×3 for taking pictures with a well-balanced composition.
- Ⓑ : This is used when you want to position the subject at the exact centre of the screen.

## ■ About the Histogram

A histogram is a graph that displays brightness along the horizontal axis (black to white) and the number of pixels at each brightness level on the vertical axis.

It allows you to easily check a picture's exposure.

- ❶ Dark area, mid-tone, and bright area are balanced out evenly, making it suitable to take a picture.
- ❷ The picture will become underexposed with more dark area. The pictures with mostly dark area, such as night scenery, will also have a histogram like this.
- ❸ The picture will become overexposed with more bright area. The pictures with mostly white area will also have a histogram like this.

## Examples of histogram



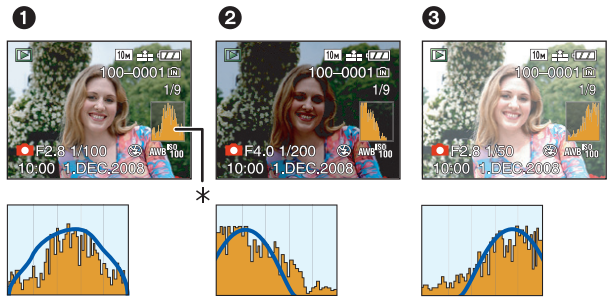

- ❶ Properly Exposed
  - ❷ Under Exposed
  - ❸ Overexposed
- \* Histogram



## Note

- When you take pictures with the flash or in dark places, the histogram is displayed in orange because the recorded picture and the histogram do not match each other.
- The histogram is an approximation in recording mode.
- The histogram of a picture may not match in recording mode and playback mode.
- The histogram displayed in this camera does not match histograms displayed by picture editing software used in PCs etc.



[REC] mode:    

## Taking Pictures using the Built-in Flash

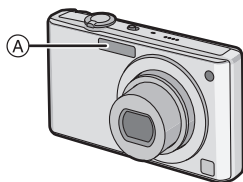

### A Photo flash

Do not cover it with your fingers or other objects.

### Switching to the appropriate flash setting

Set the flash to match the recording.

**1** Press **▶** [].







**2** Press **▲/▼** to select a mode.

- You can also press **▶** [] to select.
- For information about flash settings that can be selected, refer to “Available flash settings by recording mode”. (P38)

**3** Press **[MENU/SET]**.



- You can also press the shutter button halfway to finish.
- The menu screen disappears after about 5 seconds. At this time, the selected item is automatically set.



Item	Description of settings
 <b>AUTO</b>	The flash is automatically activated when the recording conditions make it necessary.
 <b>AUTO/Red-eye reduction*</b>	The flash is automatically activated when the recording conditions make it necessary. It is activated once before the actual recording to reduce the red-eye phenomenon (eyes of the subject appearing red in the picture) and then activated again for the actual recording. • Use this when you take pictures of people in low lighting conditions.
 <b>Forced flash ON</b>  <b>Forced ON/Red-eye reduction*</b>	The flash is activated every time regardless of the recording conditions. • <b>Use this when your subject is back-lit or under fluorescent light.</b> • The flash setting is set to [  ] only when you set <b>[PARTY]</b> or <b>[CANDLE LIGHT]</b> in scene mode. (P44)
 <b>Slow sync./Red-eye reduction*</b>	If you take a picture with a dark background landscape, this feature will slow the shutter speed when the flash is activated so that the dark background landscape will become bright. Simultaneously it reduces the red-eye phenomenon. • <b>Use this when you take pictures of people in front of a dark background.</b>
 <b>Forced flash OFF</b>	The flash is not activated in any recording conditions. • <b>Use this when you take pictures in places where the use of the flash is not permitted.</b>

\* The flash is activated twice. The subject should not move until the second flash is activated. Interval until the second flash depends on the brightness of the subject.

### ■ About the digital red-eye correction





















When the flash is used with the Red-eye reduction ([, [, [) selected, it will automatically detect and correct the red-eye in the image data.





















\* It may not be able to correct the red-eye depending on the recording conditions. It may also correct objects other than red-eye.

### ■ Available flash settings by recording mode

The available flash settings depend on the recording mode.

(○: Available, —: Not available, ●: Scene mode initial setting)

						
	○*	—	—	—	—	○
	○	○	○	○	—	○
	○	●	○	—	—	○
	○	●	○	—	—	○
	○	●	○	—	—	○
	○	●	○	—	—	○
	—	—	—	—	—	●
	●	—	○	—	—	○
	—	—	—	●	—	○
	—	—	—	—	—	●
	○	—	○	—	—	●
	—	—	—	●	○	○
	—	—	—	○	○	●
	○	●	○	—	—	○
	○	●	○	—	—	○

						
	○	—	○	—	—	●
	—	—	—	—	—	●
	○	—	○	—	—	●
	—	—	—	—	—	●
	—	—	●	—	—	—
	—	—	—	—	—	●
	—	—	—	—	—	●
	—	—	●	—	—	○
	●	—	○	—	—	○
	—	—	—	—	—	●
	●	—	○	—	—	○
	●	—	○	—	—	○
	○	—	○	—	—	●
	—	—	—	—	—	○
	○	—	○	—	—	○

\* When [] is selected, [], [] or [] is set depending on the type of subject and brightness.

- The flash setting may change if the recording mode is changed. Set the flash setting again if necessary.
- The flash setting is memorised even if the camera is turned off. However, the scene mode flash setting is reset to the initial setting when the scene mode is changed.

### ■ The available flash range to take pictures

- The available flash range is an approximation.

ISO sensitivity	Available flash range	
	Wide	Tele
<b>AUTO</b>	60 cm (1.97 feet) to 6.0 m (19.7 feet)	1.0 m (3.28 feet) to 2.8 m (9.18 feet)
<b>ISO100</b>	60 cm (1.97 feet) to 1.9 m (6.23 feet)	1.0 m (3.28 feet)
<b>ISO200</b>	60 cm (1.97 feet) to 2.7 m (8.85 feet)	1.0 m (3.28 feet) to 1.2 m (3.94 feet)
<b>ISO400</b>	60 cm (1.97 feet) to 3.8 m (12.5 feet)	1.0 m (3.28 feet) to 1.8 m (5.91 feet)
<b>ISO800</b>	80 cm (2.62 feet) to 5.4 m (17.7 feet)	1.0 m (3.28 feet) to 2.5 m (8.20 feet)
<b>ISO1600</b>	1.15 m (3.77 feet) to 7.7 m (25.3 feet)	1.0 m (3.28 feet) to 3.6 m (11.8 feet)

- In [HIGH SENS.] (P48) in scene mode, the ISO sensitivity automatically switches to between [ISO1600] and [ISO6400] and the available flash range also differs.  
Wide: Approx. 1.15 m (3.77 feet) to approx. 15.4 m (50.5 feet)  
Tele: Approx. 1.0 m (3.28 feet) to approx. 7.3 m (24.0 feet)
- In [FLASH BURST] (P49) in scene mode, the ISO sensitivity automatically switches to between [ISO100] and [ISO3200] and the available flash range also differs.  
Wide: Approx. 60 cm (1.97 feet) to approx. 4.0 m (13.1 feet)  
Tele: Approx. 1.0 m (3.28 feet) to approx. 1.9 m (6.23feet)

## ■ Shutter speed for each flash setting

Flash setting	Shutter speed (Sec.)
	1/30*1 to 1/2000th

Flash setting	Shutter speed (Sec.)
	1*1 to 1/2000th 1 or 1/4th to 1/2000th*2
	1*1 to 1/2000th 1 or 1/4th to 1/2000th*2, 3

\*1 It may vary depending on the [MIN. SHTR SPEED] setting (P66).

\*2 When Intelligent ISO is set (P59)

\*3 [SPORTS], [BABY1]/[BABY2] and [PET] in scene mode (P44)



\*2, 3: The shutter speed becomes a maximum of 1 second in the following cases.

- When the optical image stabilizer is set to [OFF].
- When the camera has determined that there is little jitter when the optical image stabilizer is set to [MODE1], [MODE2] or [AUTO].
- In Intelligent auto mode, shutter speed changes depending on the identified scene.
- There will be differences in the above shutter speeds in the scene modes.
  - [NIGHT PORTRAIT]/[NIGHT SCENERY]: 8 or 1/8th of a second to 1/2000th of a second\*4
  - [CANDLE LIGHT]: 1 or 1/8th of a second to 1/2000th of a second\*4
  - [FLASH BURST]: 1/30th of a second to 1/2000th of a second
  - [STARRY SKY]: 15 seconds, 30 seconds, 60 seconds
  - [FIREWORKS]: 1/4th of a second, 2 seconds\*4
  - All other scene modes: 1/8th of a second to 1/2000th of a second

\*4 The maximum shutter speed is selected when the amount of jitter is minimal while [STABILIZER] is set or when [STABILIZER] is set to [OFF].

### Note

- If you bring the flash too close to an object, the object may be distorted or discoloured by the heat or lighting from the flash.
- When you take a picture beyond the available flash range, the exposure may not be adjusted properly and the picture may become bright or dark.
- When the flash is being charged, the flash icon blinks red, and you cannot take a picture even when you press the shutter button fully.
- The white balance may not be properly adjusted if the flash level is insufficient for the subject.
- When the shutter speed is fast, the flash effect may not be sufficient.
- It may take time to charge the flash if you repeat taking a picture. Take a picture after the access indication disappears.
- The red-eye reduction effect differs between people. Also, if the subject was far away from the camera or was not looking at the first flash, the effect may not be evident.

[REC] mode:  

## Taking Close-up Pictures

This mode allows you to take close-up pictures of a subject, e.g. when taking pictures of flowers. You can take pictures of a subject as close as 5 cm (0.17 feet) from the lens by rotating the zoom lever upmost to Wide (1×).

### 1 Press .

- In macro mode, [AF ] is displayed. To cancel, press  again.

### 2 Take the pictures.





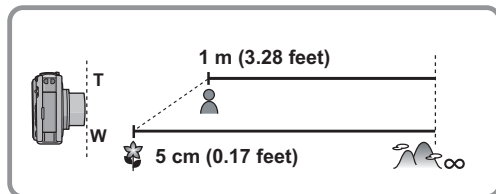

#### ■ Focus range

- \* The focus range changes in steps.



#### Note

- We recommend using a tripod and the self-timer.
- We recommend setting the flash to  when you take pictures at close range.
- If the distance between the camera and the subject is beyond the focus range of the camera, the picture may not be properly focused even if the focus indication lights.
- When a subject is close to the camera, the effective focus range is significantly narrowed. Therefore, if the distance between the camera and the subject is changed after focusing on the subject, it may become difficult to focus on it again.
- Macro mode gives priority to a subject close to the camera. Therefore, if the distance between the camera and the subject is more than 1 m (3.28 feet) it takes longer to focus on it.
- When you take pictures at close range, the resolution of the periphery of the picture may decrease slightly. This is not a malfunction.

[REC] mode:   

## Taking Pictures with the Self-timer

**1** Press ◀ [ON].

**2** Press ▲/▼ to select a mode.

- You can also press ◀ [ON] to select.

**3** Press [MENU/SET].

- You can also press the shutter button halfway to finish.
- The menu screen disappears after about 5 seconds. At this time, the selected item is automatically set.



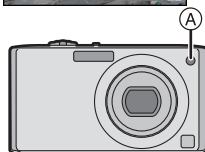

**4** Press the shutter button halfway to focus and then press it fully to take the picture.

- The self-timer indicator (A) blinks and the shutter is activated after 10 seconds (or 2 seconds).
- If you press [MENU/SET] while the self-timer is set, the self-timer setting is cancelled.



### Note

- When using a tripod etc., setting the self-timer to 2 seconds is a convenient way to avoid the jitter caused by pressing the shutter button.
- When you press the shutter button once fully, the subject is automatically focused just before recording. In dark places, the self-timer indicator will blink and then may turn on brightly operating as an AF assist lamp (P66) to allow the camera to focus on the subject.
- We recommend using a tripod when recording with the self-timer.
- The number of pictures which can be taken in [BURST] is fixed to 3.
- The number of pictures which can be taken in [FLASH BURST] in scene mode is fixed to 5.
- Self-timer cannot be set to 2 seconds in Intelligent auto mode.
- Self-timer cannot be set to 10 seconds in [SELF PORTRAIT] in scene mode or clipboard mode.
- Self-timer cannot be used while in [HI-SPEED BURST] or [UNDERWATER] in scene mode.

[REC] mode:    

## Compensating the Exposure

Use this function when you cannot achieve appropriate exposure due to the difference in brightness between the subject and the background. Look at the following examples.

### Under exposed

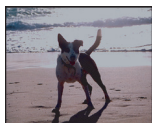

Compensate the exposure towards positive.

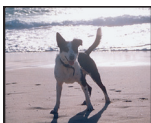

### Properly exposed



### Overexposed



Compensate the exposure towards negative.

- 1 Press   until [EXPOSURE] appears, compensate the exposure with  / .

- Select [0 EV] to return to the original exposure.

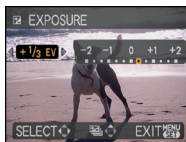

- 2 Press [MENU/SET] to finish.

- You can also press the shutter button halfway to finish.

### Note

- EV is an abbreviation of [Exposure Value]. It refers to the amount of light given to the CCD by the aperture value and the shutter speed.
- The exposure compensation value appears on the lower left of the screen.
- The set exposure value is memorised even if the camera is turned off.
- The compensation range of the exposure will be limited depending on the brightness of the subject.

[REC] mode: 

## Taking Pictures using Auto Bracket

In this mode, 3 pictures are automatically recorded in the selected exposure compensation range each time the shutter button is pressed. You can select the picture with the desired exposure from the 3 pictures with different exposures.

### With auto bracket $\pm 1$ EV

1st picture

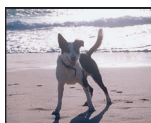

±0 EV

2nd picture

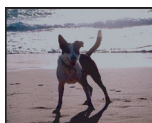

-1 EV

3rd picture

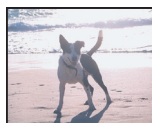

+1 EV

- 1 Press   until [AUTO BRACKET] appears, set the compensation range of the exposure with  / .

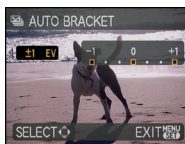

- When you do not use auto bracket, select [OFF] (0).



- 2 Press [MENU/SET] to finish.

- You can also press the shutter button halfway to finish.

### Note

- When setting auto bracket,  appears on the screen.
- When taking pictures using auto bracket after setting the exposure compensation range, the pictures taken are based on the selected exposure compensation range. When the exposure is compensated, the exposure compensation value appears on the lower left of the screen.
- The auto bracket setting is cancelled if you turn the camera off or [POWER SAVE] is activated.
- When auto bracket is set, the auto review function is activated regardless of the auto review setting. (The picture is not enlarged.) You cannot set the auto review function in the [SETUP] menu.
- The exposure may not be compensated with auto bracket depending on the brightness of the subject.
-  is set for the flash when auto bracket is set.
- Burst is cancelled when auto bracket is set.

[REC] mode: **SCN**

## Taking pictures that match the scene being recorded (SCN: Scene mode)

When you select a scene mode to match the subject and recording situation, the camera sets the optimal exposure and hue to obtain the desired picture.

**1** Slide the [REC]/[PLAYBACK] selector switch to [📷].

**2** Set the mode dial to [SCN].

**3** Press ▲/▼/◀/▶ to select the scene mode.

- You can switch menu screens from any menu item by rotating the zoom lever.

**4** Press [MENU/SET] to set.

- The menu screen is switched to the recording screen in the selected scene mode.

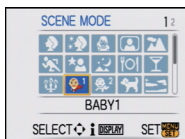

### ■ About the information ⓘ

- If you press [DISPLAY] when selecting a scene mode in step 3, explanations about each scene mode are displayed. (If you press [DISPLAY] again, the screen returns to the scene mode menu.)

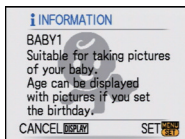

### 📌 Note

- To change the scene mode, press [MENU/SET] and then press ▶, and return to step 3 above.
- Refer to P39 for information about the shutter speed.
- The scene mode flash setting is reset to the initial setting when the scene mode is changed.
- When you take a picture with a scene mode that is not adequate for the purpose, the hue of the picture may differ from the actual scene.
- The following items cannot be set in scene mode because the camera automatically adjusts them to the optimal setting.
  - [INTELLIGENT ISO]/[SENSITIVITY]/[EXPOSURE]/[COLOR MODE]/[MIN. SHTR SPEED]
- [EXPOSURE] is activated automatically in the following scene modes.
  - [PORTRAIT]/[SOFT SKIN]/[TRANSFORM]/[SELF PORTRAIT]/[SCENERY]/[SPORTS]/[NIGHT PORTRAIT]/[PARTY]/[CANDLE LIGHT]/[BABY1]/[BABY2]/[SUNSET]/[HIGH SENS.]

## 📷 [PORTRAIT]

When taking pictures of people outdoors during the daytime, this mode allows you to improve the appearance of the persons concerned and make their skin tones look healthier.

### ■ Technique for Portrait mode

To make this mode more effective:

- Rotate the zoom lever as far as possible to Tele.
- Move close to the subject to make this mode more effective.

### 📌 Note

- The initial setting for [AF MODE] is [👤].



## [SOFT SKIN]

When taking pictures of people outdoors during the daytime, this mode enables the texture of their skin to appear even softer than with [PORTRAIT]. (It is effective when taking pictures of people from the chest up.)

### ■ Technique for Soft skin mode

To make this mode more effective:

- 1 Rotate the zoom lever as far as possible to Tele.
- 2 Move close to the subject to make this mode more effective.

### Note

- If a part of the background etc. is a colour close to skin colour, this part is also smoothed.
- This mode may not be effective when there is insufficient brightness.
- The initial setting for [AF MODE] is .

## [TRANSFORM]

Subject can be recorded either slim or stretched, and at the same time, skin can be recorded smoothly.



### 1 Press / to select the setting, and then press [MENU/SET].

- It can be set from the quick menu (P19).

### 2 Take pictures.



### Note

- [SOFT SKIN] is activated when recording. It becomes harder to detect the [SOFT SKIN] when the level of [SLIM HIGH] or [STRETCH HIGH] is selected.
- [QUALITY] is automatically fixed to .
- You can take pictures suitable for 4"×6"/10×15 cm printing.
- The initial setting for [AF MODE] is .
- It cannot be used without notifying the copyright owner, except when enjoying in private.
- Do not use the material against the public order and morals, or to offend someone.
- Do not use the material against the object's interest.

## [SELF PORTRAIT]

Select this to take pictures of yourself.

### ■ Technique for Self portrait mode

- Press the shutter button halfway to focus. The self-timer indicator lights up when you are brought into focus. Making sure you hold the camera still, press the shutter button fully to take the picture.
- The subject is not focused when the self-timer indicator is blinking. Make sure to press the shutter button halfway again to focus.
- The recorded picture automatically appears on the LCD monitor for reviewing.
- If the picture is blurry due to the slow shutter speed, we recommend using the 2 second self-timer.



### Note

- The focus range is about 30 cm (0.99 feet) to 70 cm (2.29 feet) (Wide).
- You can take a picture of yourself with audio (P66). If you do this, the self-timer indicator will light up while recording the audio.

- The zoom magnification is automatically moved to Wide (1×).
- The self-timer can only be set to off or 2 seconds. If it is set to 2 seconds, this setting will remain until the camera is turned off, the scene mode is changed or [REC] mode or [PLAYBACK] mode is selected.
- The stabilizer function mode is fixed to [MODE2]. (P65)
- The initial setting for [AF MODE] is [AF-ON].

## [SCENERY]

This allows you to take pictures of a wide landscape.



### Note

- The focus range is 5 m (16.4 feet) to ∞.

## [SPORTS]

Set here when you want to take pictures of sports scenes or other fast-moving events.



### Note

- This mode is suitable for taking pictures of subjects at distances of 5 m (16.4 feet) or more.
- [INTELLIGENT ISO] is activated, and maximum ISO sensitivity level becomes [ISO800].

## [NIGHT PORTRAIT]

This allows you to take pictures of a person and the background with near real-life brightness.

### ■ Technique for Night portrait mode

- **Use the flash. (You can set to [Flash On].)**
- Since the shutter speed becomes slower, we recommend using a tripod and the self-timer for taking pictures.
- Ask the subject not to move while taking a picture.
- We recommend rotating the zoom lever to Wide (1×) and being about 1.5 m (4.92 feet) from the subject when taking a picture.



### Note

- The focus range is 0.8 m (2.62 feet) (Wide)/1.2 m (3.94 feet) (Tele) to 5 m (16.4 feet).
- The shutter may remain closed (max. about 8 sec.) after taking the picture because of signal processing. This is not a malfunction.
- Noise may become visible when you take pictures in dark places.
- The initial setting for [AF MODE] is [AF-ON].

## [NIGHT SCENERY]

This allows you to take vivid pictures of the night scene.

### ■ Technique for Night scenery mode

- When the camera is set to [STABILIZER] and there is very little jitter, or if [STABILIZER] is set to [OFF], shutter speed may slow down up to 8 seconds. We recommend using the tripod and the self-timer for taking picture.



### Note

- The focus range is 5 m (16.4 feet) to ∞.
- The shutter may remain closed (max. about 8 sec.) after taking the picture because of signal processing. This is not a malfunction.

- Noise may become visible when you take pictures in dark places.

## [FOOD]

This mode allows you to take pictures of food with a natural hue without being affected by the ambient light in restaurants etc.

### Note

- The focus range becomes the same as macro mode. [5 cm (0.17 feet) (Wide)/1 m (3.28 feet) (Tele) to ∞]

## [PARTY]

Select this when you want to take pictures at a wedding reception, an indoor party etc. This allows you to take pictures of people and the background with near real-life brightness.

### ■ Technique for Party mode

- **Use the flash. (You can set to [⚡⊕] or [⚡⊙].)**
- We recommend using a tripod and the self-timer for taking pictures.
- We recommend rotating the zoom lever to Wide (1×) and being about 1.5 m (4.92 feet) from the subject when taking pictures.

### Note

- The initial setting for [AF MODE] is [⊙].

## [CANDLE LIGHT]

This mode allows you to take pictures with a candle-lit atmosphere.

### ■ Technique for Candle light mode

- This is more effective when taking pictures without using the flash.
- We recommend using a tripod and the self-timer for taking pictures.

### Note

- The focus range becomes the same as macro mode. [5 cm (0.17 feet) (Wide)/1 m (3.28 feet) (Tele) to ∞]
- The initial setting for [AF MODE] is [⊙].

## [BABY1]/ [BABY2]

This takes pictures of a baby with a healthy complexion. When you use the flash, the light from it is weaker than usual.

It is possible to set different birthdays and names for [BABY1] and [BABY2]. You can select to have these appear at the time of playback, or have them stamped on the recorded image using [TEXT STAMP] (P78).

### ■ Birthday/Name setting

- 1 Press ▲/▼ to select [AGE] or [NAME] and then press ►.
- 2 Press ▲/▼ to select [SET] and then press [MENU/SET].
- 3 Enter the birthday or name.

Birthday:

◀/▶: Select the items (year/month/day).

▲/▼: Setting.

[MENU/SET]: Exit.

Name: For details on how to enter characters, read the [TITLE EDIT] section on P77.

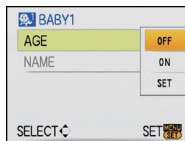

- When the birthday or name is set, [AGE] or [NAME] is automatically set to [ON].
- If [ON] is selected when the birthday or name has not been registered, the setting screen appears automatically.

#### 4 Press [MENU/SET] to finish.

##### ■ To cancel [AGE] and [NAME]

Select the [OFF] setting in step **2** of the “Birthday/Name setting” procedure.



##### Note

- The age and name can be printed out using the “PHOTOfunSTUDIO-viewer-” bundled software on the CD-ROM (supplied).
- If [AGE] or [NAME] is set to [OFF] even when the birthday or name has been set, the age or name will not be displayed. Before taking pictures, set [AGE] or [NAME] to [ON].
- The focus range becomes the same as macro mode. [5 cm (0.17 feet) (Wide)/1 m (3.28 feet) (Tele) to ∞]
- [INTELLIGENT ISO] is activated, and maximum ISO sensitivity level becomes [ISO400].
- If the camera is turned on with [BABY1]/[BABY2] set, the age and name are displayed at the lower left of the screen for about 5 seconds, along with the current date and time.
- If the age is not properly displayed, check the clock and birthday settings.
- The birthday setting and name setting can be reset with [RESET].
- The initial setting for [AF MODE] is [A].

#### [PET]

Select this when you want to take pictures of a pet such as a dog or a cat.

You can set your pet’s birthday and name. You can select to have these appear at the time of playback, or have them stamped on the recorded image using [TEXT STAMP] (P78).

For information about [AGE] or [NAME], refer to [BABY1]/[BABY2] on P47.



##### Note

- The initial setting for the AF assist lamp is [OFF].
- [INTELLIGENT ISO] is activated, and maximum ISO sensitivity level becomes [ISO800].
- The initial setting for [AF MODE] is [A].
- The focus range becomes the same as macro mode. [5 cm (0.17 feet) (Wide)/1 m (3.28 feet) (Tele) to ∞]
- Refer to [BABY1]/[BABY2] for other information about this mode.

#### [SUNSET]

Select this when you want to take pictures of sunset view. This allows you to take vivid pictures of the red colour of the sun.

#### [HIGH SENS.]

This mode minimises the jitter of the subjects, and enables you to take pictures of these subjects in dimly lit rooms. (Select this for high-sensitivity processing. The sensitivity automatically switches to between [ISO1600] and [ISO6400].)

##### ■ Picture size and aspect ratio

Press ▲/▼ to select the picture size and aspect ratio and then press [MENU/SET] to set.

- 3M (4:3), 2.5M (3:2) or 2M (16:9) is selected as the picture size.

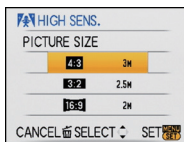

**Note**

- [QUALITY] is automatically fixed to [..].
- You can take pictures suitable for 4"×6"/10×15 cm printing.
- The focus range becomes the same as macro mode. [5 cm (0.17 feet) (Wide)/1 m (3.28 feet) (Tele) to ∞]

**[HI-SPEED BURST]**

This is a convenient mode for shooting rapid movement or a decisive moment.

**Picture size and aspect ratio**

**1 Press ▲/▼ to select the picture size and aspect ratio and then press [MENU/SET] to set.**

- 3M (4:3), 2.5M (3:2) or 2M (16:9) is selected as the picture size.

**2 Take pictures.**

- Still pictures are taken continuously while the shutter button is pressed fully.

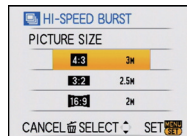

<b>Maximum Burst speed</b>	approx. 6 pictures/second
<b>Number of recordable pictures</b>	approx. 15 (built-in memory)/approx. 15 to 100* (card) * the maximum is 100.

- The burst speed changes according to the recording conditions.
- The number of burst recording pictures are limited by the picture-taking conditions and the type and/or status of the card used.
- The number of burst recording pictures increase immediately after formatting.

**Note**

- [QUALITY] is automatically fixed to [..].
- You can take pictures suitable for 4"×6"/10×15 cm printing.
- The shutter speed becomes 1/8th of a second to 1/2000th of a second.
- The focus range becomes the same as macro mode. [5 cm (0.17 feet) (Wide)/1 m (3.28 feet) (Tele) to ∞]
- The focus, zoom, exposure, white balance, shutter speed and ISO sensitivity are fixed to the settings for the first picture.
- The ISO sensitivity automatically switches to between [ISO500] and [ISO800]. However, the ISO sensitivity is increased to make the shutter speed become high-speed.

**[FLASH BURST]**

Still pictures are taken continuously with flash. It is convenient to take continuous still pictures in dark places.

**Picture size and aspect ratio**

**1 Press ▲/▼ to select the picture size and aspect ratio and then press [MENU/SET] to set.**

- 3M (4:3), 2.5M (3:2) or 2M (16:9) is selected as the picture size.

**2 Take pictures.**

- Still pictures are taken continuously while the shutter button is pressed fully.

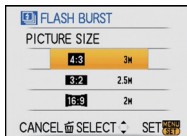

<b>Number of recordable pictures</b>	max. 5 pictures
--------------------------------------	-----------------

**Note**

- [QUALITY] is automatically fixed to [..].
- You can take pictures suitable for 4"×6"/10×15 cm printing.

- The focus range becomes the same as macro mode. [5 cm (0.17 feet) (Wide)/1 m (3.28 feet) (Tele) to  $\infty$ ]
- The focus, zoom, exposure, shutter speed, ISO sensitivity, and flash level are fixed to the settings for the first picture.
- [INTELLIGENT ISO] is activated, and maximum ISO sensitivity level becomes [ISO3200].
- See the Note on P39 when using the flash.

## [STARRY SKY]

This allows you to take vivid pictures of a starry sky or a dark subject.

### ■ Setting the shutter speed

Select a shutter speed of [15 SEC.], [30 SEC.] or [60 SEC.].

#### 1 Press $\blacktriangle/\blacktriangledown$ to select the number of seconds and then press [MENU/SET].

- It is also possible to change the number of seconds using the quick menu. (P19)

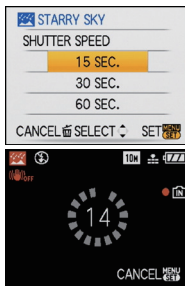

#### 2 Take pictures.

- Press the shutter button fully to display the countdown screen. Do not move the camera after this screen is displayed. When countdown finishes, [PLEASE WAIT...] is displayed for the same length of time as the set shutter speed for signal processing.
- Press [MENU/SET] to stop taking the picture while the countdown screen is displayed.

### ■ Technique for Starry sky mode

- The shutter opens for 15, 30 or 60 seconds. Be sure to use a tripod. We also recommend taking pictures with the self-timer.



#### Note

- The optical image stabilizer function is fixed to [OFF].
- ISO sensitivity is fixed to [ISO100].

## [FIREWORKS]

This mode allows you to take beautiful pictures of fireworks exploding in the night sky.

### ■ Technique for Fireworks mode

- Since the shutter speed becomes slower, we recommend using a tripod.



#### Note

- This mode is most effective when the subject is 10 m (32.8 feet) or more away.
- The shutter speed becomes the following.
  - Image stabiliser function [OFF]: 2 seconds
  - When [AUTO], [MODE1] or [MODE2] is set on the optical image stabilizer function: 1/4th of a second or 2 seconds (The shutter speed becomes 2 seconds only when the camera has determined that there is little jitter such as when using a tripod etc.)
  - You can change the shutter speed by compensating the exposure.
- The AF area is not displayed.
- ISO sensitivity is fixed to [ISO100].

## [BEACH]

This allows you to take even more vivid pictures of the blue colour of the sea, sky etc. It also prevents under exposure of people under strong sunlight.

**Note**

- The initial setting for [AF MODE] is [AF-ON].
- Do not touch the camera with wet hands.
- Sand or seawater will cause the camera to malfunction. Make sure that sand or seawater does not get into the lens or the terminals.

 [SNOW]

This allows you to take pictures that show the snow as white as possible at a ski resort or a snow-covered mountain.

 [AERIAL PHOTO]

This mode allows you to take pictures through an airplane window.

**■ Technique for Aerial photo mode**

- We recommend using this technique if it is difficult to focus when taking pictures of clouds etc. Aim the camera at something with high contrast, press the shutter button halfway to fix the focus and then aim the camera at the subject and press the shutter button fully to take the picture.

**Note**

- The focus range is 5 m (16.4 feet) to  $\infty$ .
- **Turn the camera off when taking off or landing.**
- **When using the camera, follow all instructions from the cabin crew.**
- Be careful about the reflection from the window.

 [PIN HOLE]

Picture is taken darker and with soft focus around the subjects.

**■ Picture size and aspect ratio**

Press  $\blacktriangle/\blacktriangledown$  to select the picture size and aspect ratio and then press [MENU/SET] to set.

- 3M (4:3), 2.5M (3:2) or 2M (16:9) is selected as the picture size.

**Note**

- [QUALITY] is automatically fixed to [L].
- You can take pictures suitable for 4"×6"/10×15 cm printing.
- The focus range becomes the same as macro mode. [5 cm (0.17 feet) (Wide)/1 m (3.28 feet) (Tele) to  $\infty$ ]
- Face detection may not operate normally in the dark areas around the edges of the screen.

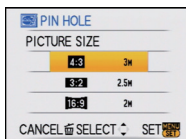

 [FILM GRAIN]

Picture is taken with a grainy texture as though blasted with sand.

### Picture size and aspect ratio

Press **▲/▼** to select the picture size and aspect ratio and then press **[MENU/SET]** to set.

- 3M (4:3), 2.5M (3:2) or 2M (16:9) is selected as the picture size.

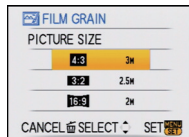

### Note

- [QUALITY] is automatically fixed to [L+].
- You can take pictures suitable for 4"×6"/10×15 cm printing.
- ISO sensitivity is fixed to [ISO1600].
- The focus range becomes the same as macro mode. [5 cm (0.17 feet) (Wide)/1 m (3.28 feet) (Tele) to ∞]

 [UNDERWATER]

Use the marine case (DMW-MCFX35; optional). This allows you to take pictures with a natural colour.

### Fixing the focus underwater (AF Lock)

You can fix the focus before taking a picture with AF lock. This is useful if you want to take pictures of a fast moving subject etc.

- 1 Aim the AF area at the subject.**
- 2 Press ◀ to fix the focus.**

- The AF lock icon (A) appears when the subject is focused.
- Press ◀ again to cancel AF lock.
- When you rotate the zoom lever, the AF lock is cancelled. In this case, focus on the subject and fix the focus again.
- You cannot set to AF lock when [AF MODE] is set to [AF-ON].

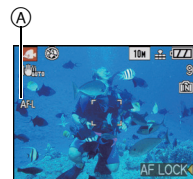

### White balance fine adjustment

You can adjust the hue to match the water depth and the weather.

- 1 Press ▲ [WB] three times to display [WB+] [WB ADJUST].**
- 2 Press ◀/▶ to adjust the white balance.**

◀ [RED]: Press when the hue is bluish.

▶ [BLUE]: Press when the hue is reddish.

- Select [0] if you do not want to finely adjust the white balance.

- 3 Press [MENU/SET] to close the menu.**

- If you adjust the white balance, [AWB] appears on the screen in red or blue.

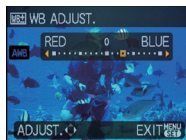

### Note

- The focus range becomes the same as macro mode. [5 cm (0.17 feet) (Wide)/1 m (3.28 feet) (Tele) to ∞]



[REC] mode: 

## Motion Picture Mode

**1** Slide the [REC]/[PLAYBACK] selector switch to .

**2** Set the mode dial to .

**3** Press the shutter button halfway to focus and then press it fully to start recording.

**A** Audio recording

- The available recording time **B** is displayed on the top right and the elapsed recording time **C** is displayed on the bottom right of the screen.
- After pressing the shutter button fully, release it straight away. If the button is held down, the sound will not be recorded for a few seconds when recording starts.
- When the subject is focused, the focus indication lights.
- The focus and zoom are fixed to the setting when recording starts (the first frame).
- The audio is also recorded simultaneously from the built-in microphone on this unit. (Motion pictures cannot be recorded without audio.)

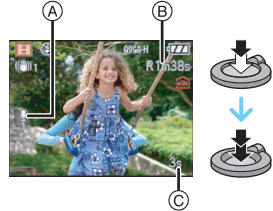

**4** Press the shutter button fully to stop recording.

- If the built-in memory or the card becomes full in the middle of recording, the camera stops recording automatically.

## Changing the settings for the picture quality

- When you set the picture quality to [HD], [WVGA] or [VGA], we recommend using a high-speed card with "10MB/s" or greater displayed on the package.

**1** Press [MENU/SET].

**2** Press ▲/▼ to select [PICTURE MODE] and then press ►.

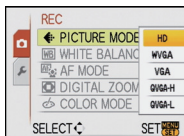

**3** Press ▲/▼ to select the item and then press [MENU/SET].

Item	Picture size	fps	Aspect ratio
HD *	1280×720 pixels	30	16:9
WVGA *	848×480 pixels	30	
VGA *	640×480 pixels	30	
QVGA-H	320×240 pixels	30	4:3
QVGA-L		10	





- fps "frames per second"; This refers to the number of frames used in 1 second.
- You can record smoother motion pictures with "30 fps".
- You can record longer motion pictures with "10 fps" although the picture quality is lower.
- [HD] can be enjoyed on the TV as high quality motion picture by using the component cable (DMW-HDC2; optional). Refer to "Playing back on the TV with component socket" (P97) for details.
- The file size with [QVGA-L] is small so it is suitable for e-mails.
- \*Cannot be recorded in the built-in memory.

**4** Press [MENU/SET] to close the menu.

- You can also press the shutter button halfway to close the menu.

### Note

- Refer to P116 for information about the available recording time.
- The available recording time displayed on the screen may not decrease regularly.
- Depending on the type of the card, the card access indication may appear for a while after recording motion pictures. This is not a malfunction.
- Motion pictures can be recorded continuously for up to 15 minutes. Also, continuous recording exceeding 2 GB is not possible. (Example: [8m 20s] with [HD]) Remaining time for continuous recording is displayed on the screen.
- When motion pictures recorded with the camera are played back on other equipment, the quality of the picture and sound may deteriorate and it may not be possible to play them back. Also the recording information may not be displayed correctly.
- LUMIX models sold after August 2008 have improved sound quality, so motion picture cannot be played back on previous models.
- In motion picture mode, the following functions cannot be used.
  - [ZOOM] and [RECALL] in [AF MODE]/Direction detection function/[AUTO] and [MODE2] on the optical image stabilizer function
- This unit does not support recording motion pictures on MultiMediaCards.

[REC] mode:    

## Useful Functions at Travel Destinations

### Recording which Day of the Vacation You Take the Picture

For details on the [SETUP] menu settings, refer to P18.

If you set the departure date or the travel destination of the vacation in advance, the number of days that have passed since the departure date (which day of the vacation it is) is recorded when you take the picture. You can display the number of days that have passed when playing back the pictures and stamp it on the recorded pictures with [TEXT STAMP] (P78).

• The number of days that have passed since the departure date can be printed out using the "PHOTOfunSTUDIO-viewer-" bundled software on the CD-ROM (supplied).

• Select [CLOCK SET] to set the current date and time in advance. (P16)

- 1 Select [TRAVEL DATE] from the [SETUP] menu, and then press .

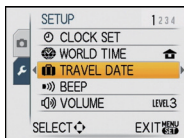

- 2 Press  to select [TRAVEL SETUP] and then press .

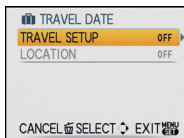

- 3 Press  to select [SET] and then press [MENU/SET].

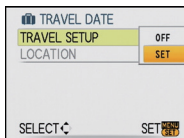

- 4 Press  to set the departure date (year/month/day), and then press [MENU/SET].

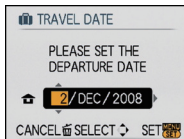

- 5 Press  to set the return date (year/month/day), and then press [MENU/SET].

• If you do not want to set the return date, press [MENU/SET] while the date bar is displayed.

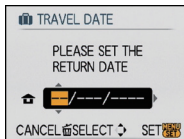

**6** Press **▼** to select [LOCATION] and then press **▶**.

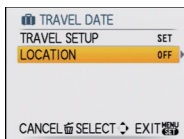

**7** Press **▼** to select [SET] and then press [MENU/SET].

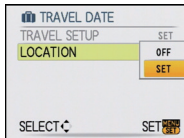

**8** Enter the location.

- For details on how to enter characters, read the [TITLE EDIT] section on P77.

**9** Press [MENU/SET] twice to close the menu.

**10** Take a picture.

- The number of days that have passed since the departure date is displayed for about 5 seconds if this unit is turned on etc. after setting the travel date or when the travel date is set.
- When the travel date is set,  appears on the lower right of the screen.

#### ■ Cancelling the travel date

The travel date is automatically cancelled if the current date is after the return date. If you want to cancel the travel date before the end of the vacation, select [OFF] on the screen shown in step 3 or 7 and then press [MENU/SET] twice. If the [TRAVEL SETUP] is set to [OFF] in step 3, [LOCATION] will be also set to [OFF].

#### Note

- The travel date is calculated using the date in the clock setting and the departure date you set. If you set [WORLD TIME] (P56) to the travel destination, the travel date is calculated using the date in the clock setting and the travel destination setting.
- The travel date setting is memorised even if the camera is turned off.
- If [TRAVEL DATE] is set to [OFF], the number of days that have passed since the departure date will not be recorded even if you set the travel date or the return date. Even if [TRAVEL DATE] is set to [SET] after taking the pictures, which day of the vacation you took them is not displayed.
- If you set a departure date and then take a picture on a date before this departure date, [-] (minus) is displayed in orange and the day of the vacation that you took the picture is not recorded.
- If the travel date is displayed as [-] (minus) in white, there is a time difference that involves date change between the [HOME] and [DESTINATION]. (It will be recorded)
- The text set as [LOCATION] can be edited later with [TITLE EDIT].
- The names for [BABY1]/[BABY2] and [PET] will not be recorded when [LOCATION] is set.
- [LOCATION] cannot be recorded when taking motion pictures.

### Recording Dates/Times at Overseas Travel Destinations (World Time)

For details on the [SETUP] menu settings, refer to P18.

You can display the local times at the travel destinations and record them on the pictures you take.

- Select [CLOCK SET] to set the current date and time in advance. (P16)

### 1 Select [WORLD TIME] from the [SETUP] menu, and then press ►.

- When first using the camera after purchasing it, the [PLEASE SET THE HOME AREA] message appears. Press [MENU/SET], and set the home area on the screen in step 3.



### 2 Press ▼ to select [HOME], and then press [MENU/SET].

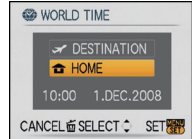

### 3 Press ◀/▶ to select the home area, and then press [MENU/SET].

- (A) Current time
- (B) Time difference from GMT (Greenwich Mean Time)
- If daylight saving time [☀/🌙] is used at the home area, press ▲. Press ▲ again to return to the original time.
- The daylight saving time setting for the home area does not advance the current time. Advance the clock setting by one hour.

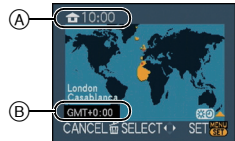

### 4 Press ▲ to select [DESTINATION] and then press [MENU/SET] to set.

- (C) Depending on the setting, the time at the travel destination area or the home area is displayed.

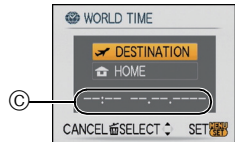

### 5 Press ◀/▶ to select the area the travel destination is in and then press [MENU/SET] to set.

- (D) Current time of the destination area
- (E) Time difference
- If daylight saving time [☀/🌙] is used at the travel destination, press ▲. (The time advances by one hour.) Press ▲ again to return to the original time.



### 6 Press [MENU/SET] to close the menu.

#### Note

- Return the setting to [HOME] when the vacation is finished by performing steps 1, 2 and 3.
- If [HOME] is already set, change only the travel destination, and use.
- If you cannot find the travel destination in the areas displayed on the screen, set by the time difference from the home area.
- The travel destination icon [✈] appears when playing back pictures taken at the travel destination.

## Using the [REC] Mode Menu

### 📷 [PICTURE SIZE]

For details on [REC] mode menu settings, refer to P18.

Set the number of pixels. The higher the numbers of pixels, the finer the detail of the pictures will appear even when they are printed onto large sheets.

Applicable modes: [A] [O] [SCN]

■ When the aspect ratio is [4:3].

\* This item cannot be set in the Intelligent auto mode.

10M (10M)	3648×2736 pixels
7M (7M [EZ])*	3072×2304 pixels
5M (5M [EZ])	2560×1920 pixels
3M (3M [EZ])	2048×1536 pixels
2M (2M [EZ])*	1600×1200 pixels
0.3M (0.3M [EZ])	640×480 pixels

■ When the aspect ratio is [3:2].

9M (9M)	3648×2432 pixels
6M (6M [EZ])*	3072×2048 pixels
4.5M (4.5M [EZ])	2560×1712 pixels
2.5M (2.5M [EZ])	2048×1360 pixels

■ When the aspect ratio is [16:9].

7.5M (7.5M)	3648×2056 pixels
5.5M (5.5M [EZ])*	3072×1728 pixels
3.5M (3.5M [EZ])	2560×1440 pixels
2M (2M [EZ])	1920×1080 pixels



#### Note

- “EZ” is an abbreviation of “Extra optical Zoom”.
- A digital picture is made of numerous dots called pixels. The higher the numbers of pixels, the finer the picture will be when it is printed on a large piece of paper or displayed on a PC monitor.

(A) Many pixels (Fine)

(B) Few pixels (Rough)

\* These pictures are examples to show the effect.

- If you change the aspect ratio, set the picture size again.
- The extra optical zoom does not work in [TRANSFORM], [HIGH SENS.], [HI-SPEED BURST], [FLASH BURST], [PIN HOLE] or [FILM GRAIN] in scene mode so the picture size for [EZ] is not displayed.
- Pictures may appear mosaic depending on the subject and the recording conditions.
- Refer to P114 for information about the number of recordable pictures.

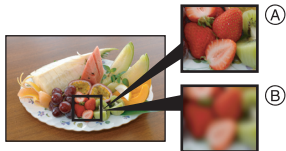

## 📷 [QUALITY]

For details on [REC] mode menu settings, refer to P18.

Set the compression rate at which the pictures are to be stored.

Applicable modes: 📷 SCN

📷: Fine (when giving priority to the picture quality)

📷: Standard (when using the standard picture quality and increasing the number of pictures to be recorded without changing the number of pixels)

### Note

- Refer to P114 for information about the number of recordable pictures.

## 📏 [ASPECT RATIO]

For details on [REC] mode menu settings, refer to P18.

This allows you to select the aspect ratio of the pictures to suit printing or the playback method.

Applicable modes: 📷 SCN

4:3: [ASPECT RATIO] of a 4:3 TV

3:2: [ASPECT RATIO] of a 35 mm film camera

16:9: [ASPECT RATIO] of a high-definition TV, etc.

4:3

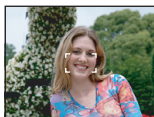

3:2

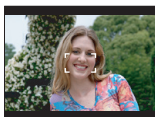

16:9



### Note

- The ends of the recorded pictures may be cut at printing so check before printing. (P112)

## ISO [INTELLIGENT ISO]

For details on [REC] mode menu settings, refer to P18.

The camera automatically sets the optimum ISO sensitivity and shutter speed to suit the movement of the subject and brightness of the scene to minimise the jitter of the subject.

Applicable modes: 📷

[OFF]/[<sup>ISO MAX</sup> 400]/[<sup>ISO MAX</sup> 800]/[<sup>ISO MAX</sup> 1600]

- The upper limit of the ISO sensitivity can be set.
- The higher the value set for the ISO sensitivity, the more the jitter is reduced but the greater the amount of picture noise.

### Note

- Depending on the brightness and how fast the subject is moving, jitter may not be avoided.
- Movements may not be detected when a moving subject is small, when a moving subject is at the edge of the screen or when a subject has moved at the very moment when the shutter button was pressed fully.
- To avoid picture noise, we recommend decreasing maximum ISO sensitivity level or setting [COLOR MODE] to [NATURAL]. (P65)

**ISO [SENSITIVITY]**

For details on [REC] mode menu settings, refer to P18.

This allows the sensitivity to light (ISO sensitivity) to be set. Setting to a higher figure enables pictures to be taken even in dark places without the resulting pictures coming out dark.

Applicable modes: 

[AUTO]/[100]/[200]/[400]/[800]/[1600]

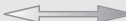
ISO sensitivity	100  1600	
Recording location (recommended)	When it is light (outdoors)	When it is dark
Shutter speed	Slow	Fast
Noise	Less	Increased

**Note**

- When setting to [AUTO], the ISO sensitivity is automatically adjusted to a maximum of [ISO400] according to the brightness. (It can be adjusted to a maximum of [ISO1000] when using the flash.)
- The setting is not available when [INTELLIGENT ISO] is being used. ([ISO] is displayed.)
- To avoid picture noise, we recommend that you either reduce the maximum ISO sensitivity level or set [COLOR MODE] to [NATURAL], and then take pictures. (P65)

**WB [WHITE BALANCE]**

For details on [REC] mode menu settings, refer to P18.

In sunlight, under incandescent lights or in other such conditions where the colour of white takes on a reddish or bluish tinge, this item adjusts to the colour of white which is closest to what is seen by the eye in accordance with the light source.

Applicable modes:   

[AWB]: Automatic adjustment

: When taking pictures outdoors under a clear sky

: When taking pictures outdoors under a cloudy sky

: When taking pictures outdoors in the shade

: When taking pictures under incandescent lights

: Value set by using  [SET]

 [SET]: Set manually

**Note**

- The optimal white balance will differ depending on the type of halogen lighting being recorded under so use [AWB] or  [SET].
- The white balance setting is memorised even if the camera is turned off. (However, the white balance setting for a scene mode returns to [AWB] when the scene mode is changed.)



## ■ Setting the white balance manually

- 1 Select [WB SET] and then press [MENU/SET].
- 2 Aim the camera at a sheet of white paper etc. so that the frame in the centre is filled by the white object only and then press [MENU/SET].



## ■ Finely adjusting the white balance [WB±]

You can finely adjust the white balance when you cannot acquire the desired hue by setting the white balance.

- Set the white balance to [☀]/[☁]/[🏠]/[🌅]/[🌃].

- 1 Press ▲ [WB±] several times until [WB ADJUST.] appears and then press ◀▶ to adjust the white balance.



◀ [RED]: Press when the hue is bluish.

▶ [BLUE]: Press when the hue is reddish.

- Select [0] to return to the original white balance.
- 2 Press [MENU/SET] to finish.

- You can also press the shutter button halfway to finish.
- The white balance icon on the screen turns red or blue.
- You can finely adjust the white balance independently for each white balance item.
- The white balance fine adjustment setting is reflected in the picture when using the flash.
- The white balance fine adjustment setting is memorised even if the camera is turned off.
- The white balance fine adjustment level in [WB SET] returns to [0] when you reset the white balance using [WB SET].
- In the [UNDERWATER] in scene mode, the white balance is fixed at [AWB], but it can be finely adjusted.

## ■ Auto white balance

Depending on the conditions prevailing when pictures are taken, the pictures may take on a reddish or bluish tinge. Furthermore, when a multiple number of light sources are being used or there is nothing with a colour close to white, auto white balance may not function properly. In a case like this, set the white balance to a mode other than [AWB].

- 1 Auto white balance will work within this range.
  - 2 Blue sky
  - 3 Cloudy sky (Rain)
  - 4 Shade
  - 5 TV screen
  - 6 Sunlight
  - 7 White fluorescent light
  - 8 Incandescent light bulb
  - 9 Sunrise and sunset
  - 10 Candlelight
- K=Kelvin colour Temperature

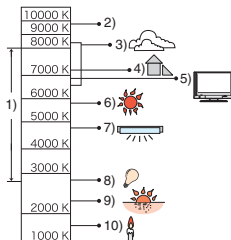







## AF MODE [AF MODE]

For details on [REC] mode menu settings, refer to P18.











This allows the focusing method that suits the positions and number of the subjects to be selected.

Applicable modes: 

 : Face detection	The camera automatically detects the person's face. The focus and exposure can then be adjusted to fit that face no matter what portion of the picture it is in. (max. 15 areas)
 : AF Tracking	Focus can be adjusted to a specified subject. Focus will keep on following the subject even if it moves. (Dynamic tracking)
 : 11-area-focusing	The camera focuses on any of 11 focus areas. This is effective when the subject is not in the centre of the screen.
 : 1-area-focusing (High speed)	The camera quickly focuses on the subject in the AF area on the centre of the screen.
 : 1-area-focusing	The camera focuses on the subject in the AF area on the centre of the screen.
 : Spot-focusing	The camera focuses on a limited narrow area in the screen.



### Note

- The camera is focusing on all the AF areas when multiple AF areas (max. 11 areas) light at the same time in . If you want to determine the focus position to take pictures, switch the AF mode to ,  or .
- If the AF mode is set to , the AF area is not displayed until the picture is brought into focus.
- Switch the AF mode to  or  if it is difficult to focus using .
- The camera may detect the subjects other than a person as the face. In this case, switch the AF mode to any modes other than  and then take a picture.
- The AF mode cannot be set in [FIREWORKS] in scene mode.
- It is not possible to set  in the following cases.
  - In [NIGHT SCENERY], [FOOD], [STARRY SKY], [AERIAL PHOTO] and [UNDERWATER] in scene mode.
  - In motion picture mode.

### About

The following AF area frames are displayed when the camera detects the faces.

Yellow:

When the shutter button is pressed halfway, the frame turns green when the camera is focused.

White:

Displayed when more than one face is detected. Other faces that are the same distance away as faces within the yellow AF areas are also focused.

- Under certain picture-taking conditions including the following cases, the facial recognition function may fail to work, making it impossible to detect faces. [AF MODE] is switched to .
  - When the face is not facing the camera
  - When the face is at an angle
  - When the face is extremely bright or dark
  - When there is little contrast on the faces
  - When the facial features are hidden behind sunglasses, etc.
  - When the face appears small on the screen



- When there is rapid movement
- When the subject is other than a human being
- When the camera is shaking
- When digital zoom is used

### ■ About [AF]

- You can focus on the subject more quickly than in other AF modes.
- The picture may stop moving for a moment before being brought into focus when you press the shutter button halfway. This is not a malfunction.

### ■ Setting up [AF] (AF Tracking)

#### 1 Bring the subject to the AF tracking frame, and press ▼ to lock the subject

- AF tracking frame will continuously focus on the subject's movement once the subject is recognised.
- AF tracking is turned off when ▼ is pressed again.

Before locking



Locked



#### 2 Take the picture

##### Note

- Dynamic tracking function may fail to lock, lose the subject in AF tracking, or track different subject depending on the recording conditions such as the ones below.
  - When the subject is too small
  - When the recording location is too dark
  - When the subject is moving too fast
  - When the background has the same or similar colour to the subject.
  - When jitter is occurring
  - When using the zoom
- If it fails to lock, AF area will flash in red, and disappear. Press ▼ again.
- AF Tracking will not operate when the subject is not specified, the subject is lost, or has failed to be tracked. The picture will be taken with [AF] in [AF MODE] in that case.
- [QUICK AF] will not operate during AF tracking.
- It is not possible to set [AF] in [STARRY SKY], [FIREWORKS], [PIN HOLE], [FILM GRAIN], or in the motion picture mode.
- It is not possible to set [AF] in [B/W], [SEPIA], [COOL], or [WARM] in [COLOR MODE].
- The focus range becomes the same as macro mode. [5 cm (0.17 feet) (Wide)/1 m (3.28 feet) (Tele) to ∞]

### Q<sub>AF</sub> [QUICK AF]

For details on [REC] mode menu settings, refer to P18.

As long as the camera is held steady, the camera will automatically adjust the focus and focus adjustment will then be quicker when the shutter is pressed. This is useful at times when, for instance, you do not want to miss a picture-taking opportunity.

Applicable modes: SCN

[OFF]/[ON]

##### Note

- When [ON] is set, [Q<sub>AF</sub>] is displayed on the screen.
- It does not operate during AF tracking.





 [BURST]

For details on [REC] mode menu settings, refer to P18.

Pictures are taken continuously while the shutter button is pressed.

Select the ones you really like from among the pictures you have taken.

Applicable modes:  

		[OFF]		
Burst speed (pictures/second)		—	2.5*	approx. 2
Number of recordable pictures		—	max. 3	Depends on the remaining capacity of the built-in memory/card.
		—	max. 5	

\* The burst speed is constant regardless of the transfer speed of the card.

The burst speed values given above apply when the shutter speed is 1/60 or faster and when the flash is not activated.



**Note**

• When the burst mode setting is set to **Unlimited**

– The burst speed becomes slower halfway. The exact timing of this depends on the type of card, the picture size and the quality.

– You can take pictures until the capacity of the built-in memory or the card is full.

• The focus is fixed when the first picture is taken.

• When the burst speed is set to , the exposure and white balance are fixed at the settings used for the first picture for the subsequent pictures as well. When the burst speed is set to , they are adjusted each time you take a picture.

• When the self-timer is used, the number of recordable pictures in burst mode is fixed to 3.

• If you are following a moving subject while taking pictures in a place (landscape) indoors, outdoors etc. where there is a large difference between the light and shade, it may take time until the exposure is stable. If burst is used at this time, the exposure may not become optimal.

• The burst speed (pictures/second) may become slower depending on the recording environment such as in dark places, if the ISO sensitivity is high etc.

• Burst mode is not cancelled when the camera is switched off.

• If you take pictures in burst mode with the built-in memory, it will take time to write the picture data.

•  is set for the flash when burst is set.

• Auto bracket is cancelled when burst is set.

 [I.EXPOSURE]

For details on [REC] mode menu settings, refer to P18.

Contrast and exposure will be adjusted automatically when there is a big difference in brightness between the background and subject, to bring the image close to how you see.

Applicable modes: 

[OFF]/[ON]

**Note**

• When [ON] is set,  is displayed on the screen.

• Even when the [SENSITIVITY] is set to [ISO100], [SENSITIVITY] may be set higher than [ISO100] if the picture is taken with [I.EXPOSURE] set to valid.

• Compensation effect may not be achieved depending on the conditions.

•  in the screen turns to yellow when [I.EXPOSURE] is in effect.

## [DIGITAL ZOOM]

For details on [REC] mode menu settings, refer to P18.

This can enlarge subjects even more than the optical zoom or extra optical zoom.

Applicable modes:   

[OFF]/[ON]

### Note

- Refer to P30 for details.
- If camera shake (jitter) is a problem during zooming, it is recommended that [STABILIZER] be set to [AUTO] or [MODE 1].

## [COLOR MODE]

For details on [REC] mode menu settings, refer to P18.

Using these modes, the pictures can be made sharper or softer, the colours of the pictures can be turned into sepia colours or other colour effects can be achieved.

Applicable modes:   

[STANDARD]: This is the standard setting.

[NATURAL]: The picture becomes softer.

[VIVID]: The picture becomes sharper.

[B/W]: The picture becomes black and white.

[SEPIA]: The picture becomes sepia.

[COOL]: The picture becomes bluish.

[WARM]: The picture becomes reddish.

### Note

- When you take pictures in dark places, noise may become visible. To avoid noise, we recommend setting to [NATURAL].
- You cannot set [COOL] or [WARM] in Intelligent auto mode. Also, you cannot set [NATURAL] or [VIVID] in motion picture mode.
- Different colour modes can be set in different [REC] modes.

## [STABILIZER]

For details on [REC] mode menu settings, refer to P18.

Using one of these modes, jitter during picture taking is detected, and the camera automatically compensates the jitter, enabling jitter-free images to be taken.

Applicable modes:   

[OFF]

[AUTO]: The optimum jitter compensation is selected depending on the condition.

[MODE1]: Jitter is always compensated during [REC] mode.

[MODE2]: The jitter is compensated for when the shutter button is pressed.

### Note

- The stabilizer function may not be effective in the following cases.

- When there is a lot of jitter.
  - When the zoom magnification is high.
  - In digital zoom range.
  - When taking pictures while following a moving subject.
  - When the shutter speed becomes slower to take pictures indoors or in dark places.
- Be careful of camera jitter when you press the shutter button.
- The setting is fixed to [MODE2] with [SELF PORTRAIT] in scene mode and to [OFF] in [STARRY SKY] in scene mode.
  - In motion picture mode, [AUTO] or [MODE2] cannot be set.



### [MIN. SHTR SPEED]

For details on [REC] mode menu settings, refer to P18.

You can take a picture brightly in dark places by setting [MIN. SHTR SPEED] slower. Also, you can set it faster to reduce the blur of the subject.



Applicable modes: 

[1/250], [1/125], [1/60], [1/30], [1/15], [1/8], [1/4], [1/2], [1]

Minimum shutter speed setting	1/250-			1-
Brightness	Darker			Brighter
Jitter	Less			More



#### Note

- This should usually be set to [1/8] to take pictures. (When you select a minimum shutter speed other than [1/8],  appears on the screen.)
- Setting [MIN. SHTR SPEED] to slower speed might increase the chance of jitter, so we recommend using a tripod and the self-timer for taking pictures.
- Setting [MIN. SHTR SPEED] to faster speed might make the picture darker, so we recommend recording the picture in well-lit area. If correct exposure cannot be achieved,  will flash in red when the shutter button is pressed halfway.

### [AUDIO REC.]

For details on [REC] mode menu settings, refer to P18.

Audio can be recorded simultaneously with the image. You can record the conversation during the shooting or the situation as a memo.

Applicable modes:  

[OFF]: Audio will not be recorded.

[ON]:  is displayed on the screen.  
Audio will be recorded as soon as the image is recorded.  
(It will stop in 5 seconds)

- If you press [MENU/SET] during audio recording, the audio recording is cancelled.



#### Note

- The sound is set separately from [AUDIO REC.] (P68) in the clipboard mode.
- Audio is recorded from the built-in microphone on the camera.
- Audio recorded with this unit may not playback on other equipment.

### AF\* [AF ASSIST LAMP]

For details on [REC] mode menu settings, refer to P18.

Illuminating the subject makes it easier for the camera to focus when recording in low light conditions that make focusing difficult.

Applicable modes:   

**[OFF]:** The AF assist lamp does not turn on.

**[ON]:** When taking pictures in dark places, the AF assist lamp lights while the shutter button is pressed halfway. (Larger AF areas are now displayed.)

 **Note**

- The effective range of the AF assist lamp is 1.5 m (4.92 feet).
- When you do not want to use the AF assist lamp  (e.g. when taking pictures of animals in dark places), set the [AF ASSIST LAMP] to [OFF]. In this case, it will become more difficult to focus on the subject.

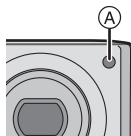

 **[CLOCK SET]**

**For details on [REC] mode menu settings, refer to P18.**

To set the year, month, day and time.

It functions in exactly the same way as [CLOCK SET] in the [SETUP] menu.

Mode dial: 

## Taking and viewing clipboard pictures

: Clipboard mode)

This setting is useful when taking pictures of timetables, route maps or other information instead of taking notes. **Regardless of whether a card is present or not, the data is stored in the dedicated clipboard folder of the built-in memory** so it can be differentiated from the regular taken pictures and made available for immediate viewing. Clipboard pictures can be recorded, played back and deleted only when the mode dial is set to .

### Taking clipboard pictures

**1** Slide the [REC]/[PLAYBACK] selector switch to .

**2** Set the mode dial to .

**3** Take the pictures.



- Number of recordable pictures when using the built-in memory solely for clipboard pictures

Picture size	2M 	1M 
Number of recordable pictures	97	146



– If the built-in memory contains pictures recorded in another recording mode, fewer pictures can be recorded than the figures given above.

### Clipboard recording menu

The menu screen appears when [MENU/SET] is pressed during clipboard picture recording.

**1** Press / to select the menu item and then press .



Item	Description of setting
[PICTURE SIZE]	Used to change the picture size. 2M  : initial setting (Prefer quality) 1M  : prefer quantity
[AUDIO REC.]	Used to record sound (5 seconds) together with the pictures. * This setting is not reflected in [AUDIO REC.] (P66) in the [REC] mode menu.
[LCD MODE]	This has same function as the [LCD MODE] in the [SETUP] menu. (P21)
[CLOCK SET]	Used to set the clock.



**2** Press ▲/▼ to select the setting and then press [MENU/SET].

**3** Press [MENU/SET] to close the menu.

### Viewing clipboard pictures

**1** Slide the [REC]/[PLAYBACK] selector switch to [▶].

**2** Set the mode dial to [📷].

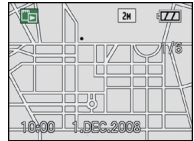

**3** Press ◀/▶ to move the picture.

◀: Play back the previous picture.

▶: Play back the next picture.

- When the zoom lever is turned to [📷] (W), a screen showing 12 pictures appears. To return to the full-screen display, turn the zoom lever to [Q] (T).

#### ■ Deleting clipboard pictures

The steps taken are the same as for normal deletion. Refer to P33.

- When a picture with a zoom mark is deleted, it will no longer be possible to view the picture prior to zooming either.
- Zoomed pictures can also be deleted.

### Enlarging clipboard pictures and storing them in the memory (zoom marks)

This function is useful for enlarging parts of maps, for instance, and storing them in the memory. For details on how to enlarge pictures, refer to "Using the Playback Zoom" on P32.

**1** Select the position to record by zoom lever and ▲/▼/◀/▶.

**2** Press [MENU/SET].

- The zoom mark [📷] (A) now appears on the picture stored in the memory.
- To change the zoom magnification or position, repeat the steps above.
- To exit the zoom mark setting, return the zoom magnification to [📷] (W) (1×).

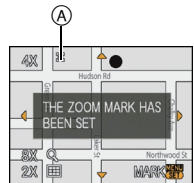

#### ■ Viewing pictures stored in the memory

**1** Press ◀/▶ to display the picture with the zoom mark [📷].

**2** Rotate the zoom lever to [Q] (T).



## Clipboard playback menu

When [MENU/SET] is pressed during clipboard playback, the menu screen appears. (The steps taken are the same as for the "Clipboard recording menu" (P68).)



Item	Description of setting
[CANCEL MARK]	Used to release the zoom position. <b>1 Press ◀/▶ to select a clipboard pictures with zoom mark [Z].</b> <b>2 Press [MENU/SET] to cancel.</b>
[AUDIO DUB.]	Used to add sound after the clipboard pictures are recorded. <b>1 Press ◀/▶ to select the picture.</b> <b>2 Press [MENU/SET] to start/stop recording.</b>
[COPY]	Used to copy clipboard pictures onto a card one at a time. *Zoom marks are not copied. <b>1 Press ◀/▶ to select the picture and then press [MENU/SET].</b> <b>2 Press ▲ to select [YES] and then press [MENU/SET].</b>
[LCD MODE]	This has same function as the [LCD MODE] in the [SETUP] menu. (P21)

## Settings During Clipboard

• Following functions are fixed.

Item	Description of settings
[GUIDE LINE] ([REC. INFO.])	[OFF]
[GUIDE LINE] ([PATTERN])	
[ECONOMY] ([POWER SAVE])	5 minutes
[ECONOMY] ([AUTO LCD OFF])	[OFF]
[SELFTIMER]	2 seconds
[QUALITY]	

Item	Description of settings
[ASPECT RATIO]	4:3
[SENSITIVITY]	[AUTO]
[WHITE BALANCE]	[AWB]
[AF MODE]	
[AF ASSIST LAMP]	[ON]

- In the clipboard mode, the following functions cannot be used.
  - [AUTO BRACKET]/White balance fine adjustment/[INTELLIGENT ISO]/[QUICK AF]/[BURST]/[I.EXPOSURE]/[DIGITAL ZOOM]/[COLOR MODE]/[MIN. SHTR SPEED]/[HISTOGRAM]/[SLIDE SHOW]/[CATEGORY PLAY]/[FAVORITE PLAY]
- The [STABILIZER] (P65) setting in [REC] mode is also reflected in clipboard mode.
- Other items in the [SETUP] menu can be set in the normal picture mode, etc. Setting will be reflected to the clipboard mode.

**Note**

- **Please bear copyrights and other such matters in mind. (P2)**
- The [PLAYBACK] mode menu (P76) function cannot be used.
- When the pictures recorded in another recording mode have been rotated (P83) and copied (P88) as clipboard pictures, the pictures prior to rotation will be shown.
- You cannot print while playing clipboard. (Clipboard image copied to card can be printed.)

[PLAYBACK] mode: 

## Playing Back Pictures in Sequence (Slide Show)

You can play back the pictures you have taken in synchronisation with music, and you can do this in sequence while leaving a fixed interval between each of the pictures.

Furthermore, you can play back the pictures grouped together by category or play back only those pictures you have set as favourites as a slide show.

This playback method is recommended when you have connected the camera to a TV set to view the pictures you have taken.



- Slide the [REC]/[PLAYBACK] selector switch to , and then press [MENU/SET].

- Set the mode dial to anything except .



- Press .

- Press / to select [SLIDE SHOW], and then press [MENU/SET].

- Press / to select the item and then press [MENU/SET].

- [FAVORITE] can be selected only when [FAVORITE] on the [PLAYBACK] menu (P84) is at [ON] and there are pictures already set as favourites.

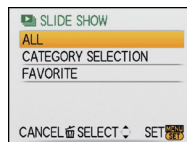

When [ALL] or [FAVORITE] has been selected in step 4

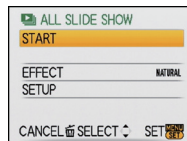

- Press  to select [START] and then press [MENU/SET].



- Press  to finish the slide show.

- Normal playback resumes after the slide show finishes.

When [CATEGORY SELECTION] has been selected in step 4

- Press /// to select the category to play back and then press [MENU/SET] to set.

- For details on categories, refer to P73.



## 6 Press ▲ to select [START] and then press [MENU/SET].

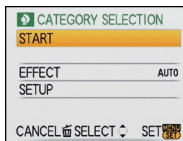

## 7 Press ▼ to finish the slide show.

- Normal playback resumes after the slide show finishes.

### ■ Operations performed during slide show

The cursor displayed during playback is the same as ▲/▼/◀/▶.

- The menu screen is restored when [EXIT] is pressed.

- (A) Play/Pause
- (B) Stop
- (C) Back to previous picture\*
- (D) Ahead to next picture\*

\* These operations can be performed only in the pause mode.

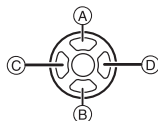

- (E) Reduce volume level
- (F) Increase volume level

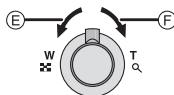

### ■ Changing the slide show settings

You can change the settings for slide show playback by selecting [EFFECT] or [SETUP] on the slide show menu screen.

#### [EFFECT]

This allows you to select the screen effects or music effects when switching from one picture to the next.

[NATURAL], [SLOW], [SWING], [URBAN], [OFF], [AUTO]

- When [URBAN] has been selected, the picture may appear in black and white as a screen effect.
- [AUTO] can be used only when [CATEGORY SELECTION] has been selected. The pictures are played back with the recommended effects in each category.

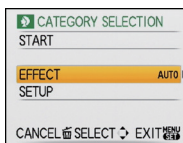

#### [SETUP]

[DURATION] or [REPEAT] can be set.

Item	Settings
[DURATION]	1SEC./2SEC./3SEC./5SEC.
[REPEAT]	ON/OFF
[MUSIC]/[AUDIO]	ON/OFF

- [DURATION] can be set only when [OFF] has been selected as the [EFFECT] setting.
- [AUDIO] will be displayed only when the [EFFECT] is set to [OFF]. Audio will be played along with the still picture with audio by setting the [AUDIO] to [ON].

#### Note

- Motion pictures cannot be played back as a slide show.
- It is not possible to add new music effects.

[PLAYBACK] mode: 

## Selecting Pictures and Playing them Back

([CATEGORY PLAY]/[FAVORITE PLAY])



### [CATEGORY PLAY]



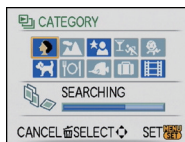



This mode allows you to search images by scene mode or other categories (such as [PORTRAIT], [SCENERY] or [NIGHT SCENERY]) and sort the pictures into each of the categories. You can then play back the pictures in each category.

- 1 Perform steps 1 and 2 on page 71.
- 2 Press **▲/▼** to select [CATEGORY PLAY], and then press [MENU/SET].
- 3 Press **▲/▼/◀/▶** to select the category and then press [MENU/SET] to set.



- If a picture is found in a category, the category icon turns blue.
- It may take time to search the picture files if there are a lot on the card or the built-in memory.
- If you press [MENU] while searching, the searching will stop halfway.
- Pictures are sorted into the categories shown below.

[CATEGORY]	Recording information e.g. scene modes
	[PORTRAIT], [i-PORTRAIT], [SOFT SKIN], [TRANSFORM], [SELF PORTRAIT], [NIGHT PORTRAIT], [i-NIGHT PORTRAIT], [BABY1]/[BABY2]
	[SCENERY], [i-SCENERY], [SUNSET], [AERIAL PHOTO]
	[NIGHT PORTRAIT], [i-NIGHT PORTRAIT], [NIGHT SCENERY], [i-NIGHT SCENERY], [STARRY SKY]

[CATEGORY]	Recording information e.g. scene modes
	[SPORTS], [PARTY], [CANDLE LIGHT], [FIREWORKS], [BEACH], [SNOW], [AERIAL PHOTO]
	[BABY1]/[BABY2]
	[PET]
	[FOOD]
	[UNDERWATER]
	[TRAVEL DATE]*
	[MOTION PICTURE]

\*The travel dates of images in the clipboard folder are not categorized.

- Still pictures created from a motion picture cannot be played back from the motion pictures category in category playback.

## [FAVORITE PLAY]

You can play back the pictures you have set as [FAVORITE] (P84) (Only when [FAVORITE] is set to [ON] and there are pictures which have been set to [FAVORITE]).

**1** Perform steps 1 and 2 on page 71.

**2** Press ▲/▼ to select [FAVORITE PLAY], and then press [MENU/SET].

 **Note**

- You can use only [ROTATE], [ROTATE DISP.], [DPOF PRINT], [PROTECT] or [AUDIO DUB.] in the [PLAYBACK] menu.

[PLAYBACK] mode: 

## Playing Back Motion Pictures/Pictures with Audio

### Motion pictures

Press ◀/▶ to select a picture with a motion picture icon (such as [QVGA-H]), and then press ▲ to play back.

- (A) The motion picture recording time
- (B) Motion picture icon
- (C) Motion picture playback icon

- After playback starts, the elapsed playback time is displayed on the upper right of the screen.

For example, 8 minutes and 30 seconds is displayed as [8m30s].

#### ■ Operations performed during motion picture playback

The cursor displayed during playback is the same as ▲/▼/◀/▶.

- (A) Play/Pause
  - (B) Stop
  - (C) Fast rewind, Frame-by-frame rewind\*
  - (D) Fast forward, Frame-by-frame forward\*
- \* These operations can be performed only in the pause mode.

- (E) Reduce volume level
- (F) Increase volume level

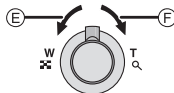
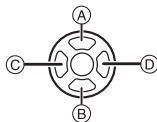
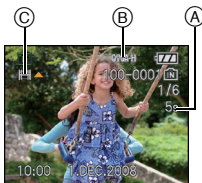

## Pictures with audio

Press ◀▶ to select a picture with the audio icon [ ] and then press ▲ to play back.

(A) Audio icon

- Refer to [AUDIO REC.] (P66) and [AUDIO DUB.] (P87) for information about how to create still pictures with audio.



### Note

- Sound can be heard through the speaker. Refer to [VOLUME] (P20) for information about how to adjust the volume in the [SETUP] menu.
- The file format that can be played back with this camera is QuickTime Motion JPEG.
- Please note that the bundled software includes QuickTime to play back motion picture files created with the camera on the PC.
- Some QuickTime Motion JPEG files recorded by a PC or other equipment may not play back on the camera.
- If you play back motion pictures that have been recorded with other equipment, the picture quality may deteriorate or the pictures may not play back.
- Pictures with audio recorded with other equipment may not playback on this unit.
- When using a high capacity card, it is possible that fast rewinding may be slower than usual.

[PLAYBACK] mode: [ ]

## Creating still pictures from a motion picture

You can create a single still picture (with 1 screen or 9 screens) from a recorded motion picture. This is effective in moving scenes when you want to look carefully at the movement of a sportsperson etc.

### 1 Press ▲ to pause motion picture playback.

- To save the displayed image as 1 picture → go to step 3
- To save the motion picture as 1 picture with 9 screens → go to step 2

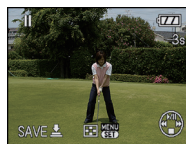

### 2 Press [MENU/SET] to display the 9 screens playback screen.

(A): 30 frames: Display image every 1/30 second as picture

**To advance frame-by-frame**

▲/▼: Advance every 3 frames

◀▶: Advance every 1 frames

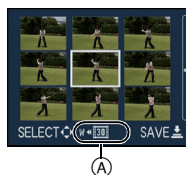

### Change the number of frame rate per second

Turn the zoom lever toward [ ] (W)

Quality	Frame rate per second
HD/WVGA/VGA/QVGA-H	30→15→10→5
QVGA-L	10→5

### To end 9 screen display

Press [MENU/SET]

**3** Press the shutter button.

**4** Press **▲** to select [YES] and then press [MENU/SET].

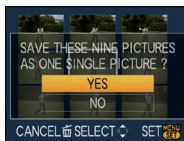

### Picture size

Item	1 picture	9 pictures
HD/WVGA	2 M	2 M
VGA	0.3 M	2 M
QVGA-H/QVGA-L	0.3 M	1 M

• [QUALITY] is fixed to [..].

#### Note

• You may not be able to save still pictures from a motion picture taken on other equipment.

[PLAYBACK] mode:

## Using the [PLAYBACK] mode menu

You can use various functions in playback mode to rotate pictures, set protection for them etc.

• With [TEXT STAMP], [RESIZE], [TRIMMING], [LEVELING] or [ASPECT CONV.], a new edited picture is created. A new picture cannot be created if there is no free space on the built-in memory or the card so we recommend checking that there is free space and then editing the picture.

### CAL [CALENDAR]

You can display pictures by recording date.

**1** Select [CALENDAR] on the [PLAYBACK] mode menu. (P18)

• You can also rotate the zoom lever several times towards (W) to display the calendar screen. (P32)

**2** Press **▲/▼/◀/▶** to select the date to be played back.

▲/▼: Select the month

◀/▶: Select the date

• If there were no pictures recorded during a month, the month is not displayed.





### 3 Press [MENU/SET] to display the pictures that were recorded on the selected date.

- Press [RECALL] to return to the calendar screen.



### 4 Press ▲/▼/◀/▶ to select a picture and then press [MENU/SET].

- The picture that was selected will appear.

#### Note

- The recording date of the picture selected in the playback screen becomes the date selected when the calendar screen is first displayed.
- If there are multiple pictures with the same recording date, the first picture recorded on that day is displayed.
- You can display the calendar between January 2000 and December 2009.
- If the date is not set in the camera, the recording date is set as the 1st January, 2008.
- If you take pictures after setting the travel destination in [WORLD TIME], the pictures are displayed by the dates at the travel destination in calendar playback.

## [TITLE EDIT]

You can add text (comments) to pictures. After text has been registered, it can be included in prints using [TEXT STAMP] (P78). (Only alphabetic characters and symbols can be entered.)

### 1 Select [TITLE EDIT] on the [PLAYBACK] mode menu. (P18)

### 2 Press ▲/▼ to select [SINGLE] or [MULTI] and then press [MENU/SET].

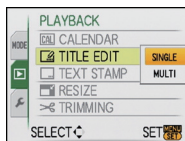

[SINGLE]

[MULTI]

### 3 Select the picture, and then press [MENU/SET] to set.

- [TITLE EDIT] is displayed for pictures that have already been recorded with text in [BABY1]/[BABY2] or [PET] name settings in scene mode, [LOCATION] in travel date or [TITLE EDIT].



Press ◀/▶ to select the picture.



Press ▲/▼/◀/▶ to select the pictures.

#### [MULTI] setting

Press [DISPLAY] to set (repeat), and then press [MENU/SET] to set.

- The setting is cancelled when [DISPLAY] is pressed again.

#### 4 Press ▲/▼/◀/▶ to select text and then press [MENU/SET] to register.

- Press [DISPLAY] to switch text between [A] (capitals), [a] (small case) and [&/1] (special characters and numbers).
- The cursor at the entry position can be moved to the left with [◀], and to the right with [▶].
- To enter a blank, move the cursor to [SPACE] or to delete an entered character, move the cursor to [DELETE], and press [MENU/SET].
- To stop editing at any time during text entry, press [⏏].
- A maximum of 30 characters can be entered.

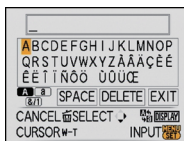

#### 5 Press ▲/▼/◀/▶ to move the cursor to [EXIT] and then press [MENU/SET] to end text input.

#### 6 Press [⏏] to return to the menu screen.\*

- \*The menu screen is automatically restored when [MULTI] is selected.
- Press [MENU/SET] to close the menu.

#### ■ Delete the title

##### [SINGLE] setting

- 1 In step 4 when [SINGLE] (P78) is selected, delete all the texts, select [EXIT], and press [MENU/SET].
- 2 Press [⏏].
- 3 Press [MENU/SET] to close the menu.

##### [MULTI] setting

- 1 In step 4, delete all the texts, select [EXIT], and press [MENU/SET].
- 2 Press [MENU/SET] to close the menu.

#### Note

- Text can be scrolled if all of the registered text does not fit on the screen.
- The name setting of [BABY1]/[BABY2] or [PET] in scene mode or [LOCATION] in travel date can also be registered by using the operation in steps 4 and following.
- The name setting of [BABY1]/[BABY2] or [PET] in scene mode, [LOCATION] in travel date and [TITLE EDIT] cannot be registered at the same time.
- You can print out texts (comments) using the "PHOTOfunSTUDIO-viewer-" bundled software on the CD-ROM (supplied).
- You can set up to 50 pictures at one time with [MULTI].
- You cannot use titles edit for pictures taken with other equipment.

#### [TEXT STAMP]

You can stamp the recording date/time, age, travel date or title onto the recorded pictures. It is suitable for regular size printing. (Pictures with a picture size larger than [3M]) will be resized when stamping the date etc. on them.)

#### 1 Select [TEXT STAMP] on the [PLAYBACK] mode menu. (P18)

- 2** Press **▲/▼** to select **[SINGLE]** or **[MULTI]** and then press **[MENU/SET]**.

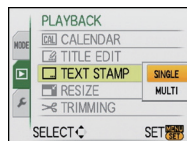

[SINGLE]

[MULTI]

- 3** Select the picture, and then press **[MENU/SET]** to set.

- appears on screen if the picture is stamped with text.

#### [MULTI] setting

Press **[DISPLAY]** to set (repeat), and then press **[MENU/SET]** to set.

- The setting is cancelled when **[DISPLAY]** is pressed again.

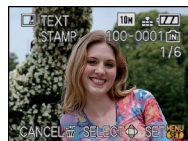

Press **◀/▶** to select the picture.

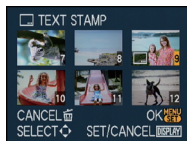

Press **▲/▼/◀/▶** to select the pictures.

- 4** Press **▲/▼/◀/▶** to select **[SHOOTING DATE]**, **[AGE]**, **[TRAVEL DATE]** or **[TITLE]** and then press **[MENU/SET]** to set each item.

#### [SHOOTING DATE]

**[W/OTIME]:** Stamp the year, month and date.

**[WITHTIME]:** Stamp the year, month, day, hour and minutes.

#### [AGE] (P47)

If this is set to **[ON]**, **[AGE]** is stamped on the pictures.

#### [TRAVEL DATE]

If this is set to **[ON]**, **[TRAVEL DATE]** is stamped on the pictures.

#### [TITLE]

Text is printed together with the image for pictures that have already been recorded with text in **[BABY1]/[BABY2]** or **[PET]** name settings in scene mode, **[LOCATION]** in travel date or **[TITLE EDIT]**.

- 5** Press **[MENU/SET]**.

- If you set **[TEXT STAMP]** for a picture with a picture size larger than **[3M]**, the picture size will become smaller as shown below.

Aspect ratio setting	Picture size
<b>4:3</b>	<b>10M / 7M / 5M → 3M</b>
<b>3:2</b>	<b>9M / 6M / 4.5M → 2.5M</b>
<b>16:9</b>	<b>7.5M / 5.5M / 3.5M → 2M</b>

- The picture becomes slightly rougher.

- 6** Press **▲** to select **[YES]** and then press **[MENU/SET]**.

- The message **[SAVE NEW PICTURES?]** appears if the picture was recorded with a picture size **[3M]** or less.



## 7 Press [RECALL] to return to the menu screen.\*

- \*The menu screen is automatically restored when [MULTI] is selected.
- Press [MENU/SET] to close the menu.

### Note

- When you print pictures stamped with text, the date will be printed over the stamped text if you specify printing of the date at the photo shop or on the printer.
- You can set up to 50 pictures at one time in [MULTI].
- Depending on the printer being used, some characters may be cut at printing. Check before printing.
- When text is stamped onto the [0.3M] pictures, it is difficult to read it.
- Text and dates cannot be stamped on the pictures taken with other equipment.

## [RESIZE] Reducing the picture size (number of pixels)

We recommend resizing to [0.3M] if you want to attach a picture to an e-mail or use it on a website. (Pictures set to the minimum number of pixels for [ASPECT RATIO] cannot be further reduced in size.)

## 1 Select [RESIZE] on the [PLAYBACK] mode menu. (P18)

## 2 Press ▲/▼ to select [SINGLE] or [MULTI] and then press [MENU/SET].

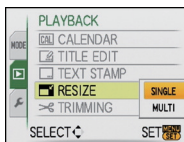

## 3 Select the picture and size. [SINGLE] setting

- 1 Press ◀/▶ to select the picture, and then press [MENU/SET].
- 2 Press ◀/▶ to select the size\*, and then press [MENU/SET].

- \* Only the sizes to which the pictures can be resized is displayed.

### [MULTI] setting

- 1 Press ▲/▼ to select the size, and then press [MENU/SET].
  - When [DISPLAY] is pressed, an explanation of resizing is displayed.
- 2 Press ▲/▼/◀/▶ to select the picture, and then press [DISPLAY].
  - Repeat this step for each picture, and press [MENU/SET] to set.

### [SINGLE]



### [MULTI]

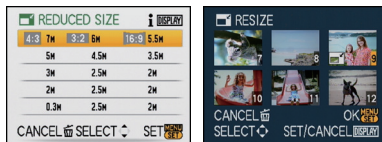

## 4 Press ▲ to select [YES] and then press [MENU/SET].

## 5 Press [RECALL] to return to the menu screen.\*

- \*The menu screen is automatically restored when [MULTI] is selected.
- Press [MENU/SET] to close the menu.

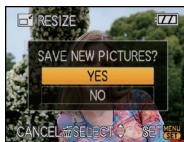

**Note**

- You can set up to 50 pictures at one time in [MULTI].
- The picture quality of the resized picture will deteriorate.
- It may not be possible to resize pictures recorded with other equipment.

## ✂ [TRIMMING]

You can enlarge and then clip the important part of the recorded picture.

**1** Select [TRIMMING] on the [PLAYBACK] mode menu. (P18)

**2** Press ◀/▶ to select the picture, and then press [MENU/SET].



**3** Use the zoom lever and press ▲/▼/◀/▶ to select the parts to be trimmed.



Zoom lever (T): Enlargement  
 Zoom lever (W): Reduction  
 ▲/▼/◀/▶: Move

Reduction



Enlargement



Move the position



**4** Press [MENU/SET].

**5** Press ▲ to select [YES] and then press [MENU/SET].

**6** Press [EXIT] to return to the menu screen.

- Press [MENU/SET] to close the menu.

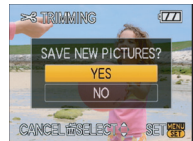
**Note**

- Depending on the cut size, the picture size of the trimmed picture may become smaller than that of the original picture.
- The picture quality of the trimmed picture will deteriorate.
- It may not be possible to trim pictures recorded with other equipment.

## [LEVELING]

Minute tilting of the image can be adjusted.

**1** Select [LEVELING] on the [PLAYBACK] mode menu. (P18)

**2** Press ◀/▶ to select the picture, and then press [MENU/SET].

**3** Press ◀/▶ to adjust the tilting, and press [MENU/SET].

▶ : clockwise

◀ : counter-clockwise

• Up to 2 ° can be adjusted.



**4** Press ▲ to select [YES] and then press [MENU/SET].

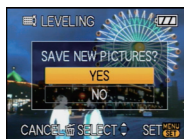

**5** Press [EXIT] to return to the menu screen.

• Press [MENU/SET] to close the menu.

### Note

- Quality of image may become coarse when levelling is performed.
- Recorded pixels may decrease compared to original image when levelling is performed.
- Levelling may not be performed on images recorded with other equipment.

## [ASPECT CONV.]

You can convert pictures taken with a [16:9] aspect ratio to a [3:2] or a [4:3] aspect ratio.

**1** Select [ASPECT CONV.] on the [PLAYBACK] mode menu. (P18)

**2** Press ▲/▼ to select [3:2] or [4:3] and then press [MENU/SET].



**3** Press ◀/▶ to select a picture taken with [16:9] aspect ratio, and then press [MENU/SET].



- 4** Press ◀/▶ to determine the horizontal position, and press [MENU/SET] to set.
- Use ▲/▼ to set the frame position for pictures rotated vertically.



- 5** Press ▲ to select [YES] and then press [MENU/SET].

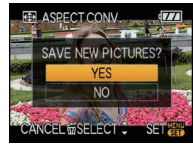

- 6** Press [⏪] to return to the menu screen.
- Press [MENU/SET] to close the menu.

**Note**

- After converting the aspect ratio, the picture size may become larger than that of the original picture.
- You may not be able to convert pictures taken on other equipment.

## 🔄 [ROTATE]/🔄A [ROTATE DISP.]

This mode allows you to automatically display pictures vertically if they were recorded holding the camera vertically or rotate pictures manually in 90° steps.

### Rotate (The picture is rotated manually)

- 1** Select [ROTATE] on the [PLAYBACK] mode menu. (P18)
- The [ROTATE] function is disabled when [ROTATE DISP.] is set to [OFF].

- 2** Press ◀/▶ to select the picture and then press [MENU/SET].
- Motion pictures and protected pictures cannot be rotated.



- 3** Press ▲/▼ to select the direction to rotate the picture and then press [MENU/SET].

➡: The picture rotates clockwise in steps of 90°.

⬅: The picture rotates counter-clockwise in steps of 90°.

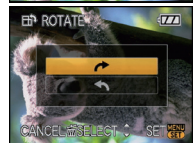

- 4** Press [⏪] to return to the menu screen.
- Press [MENU/SET] to close the menu.

## Rotate display (The picture is automatically rotated and displayed)

**1** Select [ROTATE DISP.] on the [PLAYBACK] mode menu. (P18)

**2** Press ▼ to select [ON] and then press [MENU/SET].

- The pictures are displayed without being rotated when you select [OFF].
- Refer to P31 for information about how to play back pictures.

**3** Press [MENU/SET] to close the menu.



### Note

- When you play back pictures on a PC, they cannot be displayed in the rotated direction unless the OS or software is compatible with Exif. Exif is a file format for still pictures which allows recording information etc. to be added. It was established by "JEITA (Japan Electronics and Information Technology Industries Association)".
- It may not be possible to rotate pictures that have been recorded with other equipment.

## ★ [FAVORITE]

You can do the following if a mark has been added to pictures and they have been set as favourites.

- Play back only the pictures set as favourites. ([FAVORITE PLAY])
- Play back the pictures set as favourites only as a slide show.
- Delete all the pictures not set as favourites. ([ALL DELETE EXCEPT★])

**1** Select [FAVORITE] on the [PLAYBACK] mode menu. (P18)

**2** Press ▼ to select [ON] and then press [MENU/SET].

- You cannot set pictures as favourites if [FAVORITE] is set to [OFF]. Also [★] will not appear when [FAVORITE] is set to [OFF] even if it was previously set to [ON].

**3** Press [MENU/SET] to close the menu.



**4** Press ◀/▶ to select the picture and then press ▼.

- Repeat the above procedure.
- If ▼ is pressed again, the favourite setting is cancelled.



### ■ Cancelling all the [FAVORITE] settings

**1** Select [CANCEL] on the screen shown in step 2 and then press [MENU/SET].

**2** Press ▲ to select [YES] and then press [MENU/SET].

**3** Press [MENU/SET] to close the menu.

- You cannot select [CANCEL] if not even one picture has been set as a favourite.



**Note**

- You can set up to 999 pictures as favourites.
- When printing pictures at a photo printing store, [ALL DELETE EXCEPT ★] (P34) is useful so only the pictures you want to be printed remain on the card.
- You may not be able to set pictures taken with other equipment as favourites.
- You can perform, check and cancel the settings of images as favourites using the “PHOTOfunSTUDIO-viewer-” bundled software on the CD-ROM (supplied).

**DPOF PRINT**

DPOF “Digital Print Order Format” is a system that allows the user to select which pictures to print, how many copies of each picture to print and whether or not to print the recording date on the pictures when using a DPOF compatible photo printer or photo printing store. For details, ask at your photo printing store.

When you want to use a photo printing store to print pictures recorded on the built-in memory, copy them to a card (P88) and then set the DPOF setting.

**1** Select [DPOF PRINT] on the [PLAYBACK] mode menu. (P18)

**2** Press ▲/▼ to select [SINGLE] or [MULTI] and then press [MENU/SET].



**3** Select the picture, and then press [MENU/SET].

[SINGLE]

[MULTI]



Press ◀/▶ to select the picture.

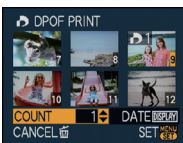

Press ▲/▼/◀/▶ to select the pictures.

**4** Press ▲/▼ to set the number of prints, and then press [MENU/SET] to set.

- When [MULTI] has been selected, repeat steps 3 and 4 for each picture. (It is not possible to use the same setting for a multiple number of pictures.)

**5** Press [EXIT] to return to the menu screen.

- Press [MENU/SET] to close the menu.

**■ Cancelling all the [DPOF PRINT] settings**

**1** Select [CANCEL] on the screen shown in step 2 and then press [MENU/SET].

**2** Press ▲ to select [YES] and then press [MENU/SET].

**3** Press [MENU/SET] to close the menu.

- You cannot select [CANCEL] if not even one picture has been set for DPOF printing.

## ■ To print the date

After setting the number of prints, set/cancel printing with the recording date by pressing [DISPLAY].

- When you go to a photo printing store for digital printing, be sure to order the printing of the date additionally if required.
- Depending on the photo printing store or the printer, the date may not be printed even if you set to print the date. For further information, ask at your photo printing store or refer to the operating instructions for the printer.
- The date cannot be printed on pictures stamped with text.



### Note

- The number of prints can be set from 0 to 999.
- With a printer supporting PictBridge, the date print settings of the printer may take precedence so check if this is the case.
- It may not be possible to use the DPOF print settings with other equipment. In this case, cancel all the settings, and reset the settings.
- If the file is not based on the DCF standard, the DPOF print setting cannot be set.

## ON [PROTECT]

You can set protection for pictures you do not want to be deleted by mistake.

### 1

Select [PROTECT] on the [PLAYBACK] mode menu. (P18)

### 2

Press ▲/▼ to select [SINGLE] or [MULTI] and then press [MENU/SET].



[SINGLE]

[MULTI]

### 3

Select the picture, and then press [MENU/SET].

When [MULTI] has been selected

- Repeat these steps for each picture.
- The settings are cancelled when [MENU/SET] is pressed again.

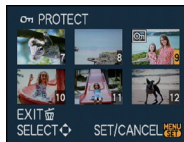

Press ◀▶ to select the picture.

Press ▲/▼/◀▶ to select the pictures.

### 4

Press [EXIT] to return to the menu screen.

- Press [MENU/SET] to close the menu.

## ■ Cancelling all the [PROTECT] settings

**1** Select [CANCEL] on the screen shown in step 2 and then press [MENU/SET].

**2** Press ▲ to select [YES] and then press [MENU/SET].

**3** Press [MENU/SET] to close the menu.

- If you press [MENU/SET] while cancelling protection, the cancelling will stop halfway.

**Note**

- The protect setting may not be effective on other equipment.
- Even if you protect pictures in the built-in memory or a card, they will be deleted if the built-in memory or the card is formatted.
- Even if you do not protect pictures on an SD Memory Card or an SDHC Memory Card, they cannot be deleted when the card's Write-Protect switch is set to [LOCK].

**[AUDIO DUB.]**

You can add the audio after taking a picture.

**1 Select [AUDIO DUB.] on the [PLAYBACK] mode menu. (P18)****2 Press ◀/▶ to select the picture and then press [MENU/SET] to start audio recording.**

- The message [OVERWRITE AUDIO DATA?] screen appears when audio has already been recorded. Press ▲ to select [YES] and then press [MENU/SET] to start audio recording. (The original audio is overwritten.)
- Audio is recorded from the built-in microphone on the camera.
- If you press [🗑️], the audio dubbing is cancelled.

**3 Press [MENU/SET] to stop recording.**

- It will automatically stop after recording about 10 seconds without pressing [MENU/SET].

**4 Press [🗑️] to return to the menu screen.**

- Press [MENU/SET] to close the menu.

**Note**



- Audio dubbing may not work properly on pictures recorded by other equipment.

 [COPY]

You can copy data of pictures you have shot from the built-in memory onto a card, from a card into the built-in memory or from a card into the dedicated clipboard folder.

### 1 Select [COPY] on the [PLAYBACK] mode menu. (P18)

### 2 Press ▲/▼ to select the copy destination and then press [MENU/SET].

- : All the picture data in the built-in memory are copied onto the card at one time. → step 4.
- : One picture at a time is copied from the card to the built-in memory. → step 3.
- : The images are copied from the card to the dedicated clipboard folder (built-in memory) one at a time. (Motion pictures cannot be copied.) → Step 3.  
– When copying clipboard pictures onto a card, select [COPY] on the clipboard playback menu. (P70)



### 3 Press ◀▶ to select the picture and then press [MENU/SET].

### 4 Press ▲ to select [YES], and then press [MENU/SET].

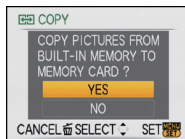

- If you press [MENU/SET] while copying pictures from the built-in memory to the card, the copying will stop halfway.
- Do not turn the camera off at any point during the copying process.



### 5 Press [TOP] to return to the menu screen.

- Press [MENU/SET] to close the menu.
- If you copy from the built-in memory to a card, all the pictures are copied and then the screen automatically returns to the playback screen.

#### Note

- If you copy picture data from the built-in memory to a card which does not have sufficient free space, the picture data will only be copied halfway. We recommend using a card which has more free space than the built-in memory (about 50 MB).
- If a picture exists with the same name (folder number/file number) as the picture to be copied in the copy destination when  is selected, a new folder is created and the picture is copied. If a picture exists with the same name (folder number/file number) as the picture to be copied in the copy destination when  is selected, that picture is not copied. (P103)
- It may take time to copy the picture data.
- Only pictures recorded with a Panasonic digital camera (LUMIX) will be copied. (Even if the pictures were recorded with a Panasonic digital camera, you may not be able to copy them if they were edited with a PC.)
- DPOF settings on the original picture data will not be copied. Set the DPOF settings again after copying is finished.

## Connecting to a PC

You can acquire recorded pictures to a PC by connecting the camera and the PC.

- You can easily print out or mail the pictures you have imported. Use of the “PHOTOfunSTUDIO-viewer-” bundled software on the CD-ROM (supplied) is a convenient way of doing this.
- Read the separate operating instructions for the supplied software for more information about the software in the CD-ROM (supplied) and how to install it.

Preparations:

Turn on the camera and the PC.

Remove the card before using the pictures in the built-in memory.

### 1 Connect the camera to a PC via the USB connection cable (A) (supplied).

- Do not use any other USB connection cables except the supplied one.  
Use of cables other than the supplied USB connection cable may cause malfunction.

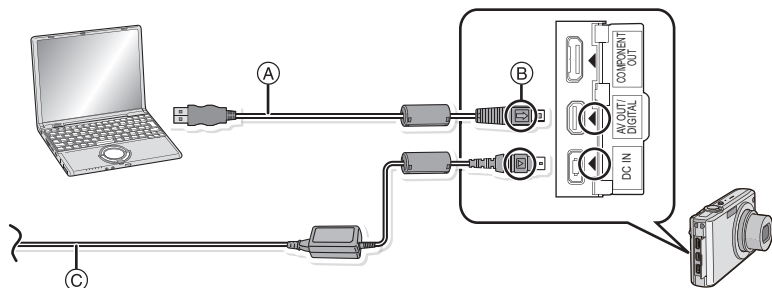

(A) USB connection cable (supplied)

- Check the directions of the connectors, and plug them straight in or unplug them straight out. (Otherwise the connectors may be bent out of shape which will cause trouble.)

(B) Align the marks, and insert.

(C) AC adaptor (DMW-AC5E; optional)

- Use a battery with sufficient battery power or the AC adaptor (DMW-AC5E; optional). If the remaining battery power becomes low while the camera and the PC are communicating, the status indicator blinks and the alarm beeps.

Refer to “Disconnecting the USB connection cable safely” (P90) before disconnecting the USB connection cable. Otherwise, data may be destroyed.

## 2 Press ▲/▼ to select [PC], and then press [MENU/SET].

- If [USB MODE] (P22) is set to [PC] in the [SETUP] menu in advance, the camera will be automatically connected to the PC without displaying the [USB MODE] selection screen. Since there is no need to set this each time you connect to the PC, it is convenient.
- When the camera has been connected to the PC with [USB MODE] set to [PictBridge(PTP)], a message may appear on the PC's screen. Select [Cancel] to close the screen, and disconnect the camera from the PC. Then set [USB MODE] to [PC] again.

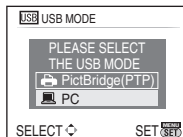

## 3 Double-click on [Removable Disk] in [My Computer].

- When using a Macintosh, the drive is displayed on the desktop. ("LUMIX", "NO\_NAME" or "Untitled" is displayed.)

## 4 Double-click [DCIM] folder.

## 5 Using a drag-and-drop operation, move the pictures you want to acquire or the folder storing those pictures to any different folder on the PC.

- Data from the PC can not be written to the camera using the USB connection cable.

### ■ Disconnecting the USB connection cable safely

- Proceed with the hardware removal using "Safely Remove Hardware" on the task tray of the PC. If the icon is not displayed, check that [ACCESS] is not displayed on the LCD monitor of the digital camera before removing the hardware.

### Note

- Turn the camera off before connecting or disconnecting the AC adaptor (DMW-AC5E; optional).
- Before inserting or removing a card, turn the camera off and disconnect the USB connection cable. Otherwise, data may be destroyed.
- With the Mac OS X v10.2 or an earlier operating system, set the Write-Protect switch of the SDHC memory card to the [LOCK] position when importing pictures from an SDHC memory card.
- If the camera is connected in clipboard mode, the built-in memory data is displayed even if a card is inserted.

## ■ Viewing the contents of the built-in memory or card using the PC (folder composition)

- Built-in memory
- Card

- ① Folder number
  - ② File number
  - ③
- |           |                    |
|-----------|--------------------|
| JPG:      | Pictures           |
| MOV:      | Motion pictures    |
| MISC:     | DPOF print         |
|           | Favourite          |
| PRIVATE1: | Clipboard pictures |
- (Built in memory only)

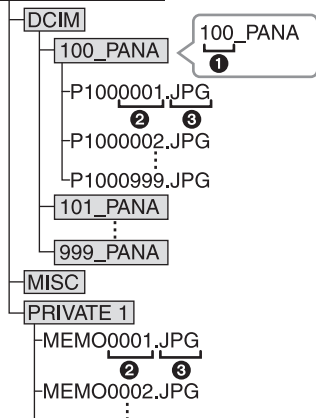

A new folder is created when pictures are taken in the following situations.

- After [NO.RESET] (P22) in the [SETUP] menu has been executed
- When a card containing a folder with the same folder number has been inserted (Such as when pictures were taken using another make of camera)
- When there is a picture with file number 999 inside the folder

## ■ Connection in the PTP mode (Windows® XP, Windows Vista® and Mac OS X only)

Set [USB MODE] to [PictBridge(PTP)].

Data can now be read only from the card into the PC.

- When there are 1000 or more pictures on a card, the pictures may not be imported in the PTP mode.

## Printing the Pictures

If you connect the camera to a printer supporting PictBridge, you can select the pictures to be printed out and instruct that printing be started on the camera's LCD monitor.

Preparations:

Turn on the camera and the printer.

Remove the card before printing the pictures in the built-in memory.

Perform the print quality and other settings at the printer before printing the pictures.

Set the mode dial to anything except [M].

### 1 Connect the camera to a printer via the USB connection cable (A) (supplied).

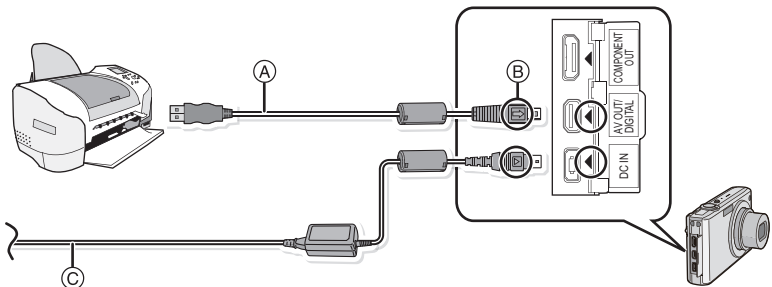

(A) USB connection cable (supplied)

• Check the directions of the connectors, and plug them straight in or unplug them straight out. (Otherwise the connectors may be bent out of shape which will cause trouble.)

(B) Align the marks, and insert.

(C) AC adaptor (DMW-AC5E; optional)

• Use a battery with a sufficient battery power or the AC adaptor (DMW-AC5E; optional). If the remaining battery power becomes low while the camera and the printer are connected, the status indicator blinks and the alarm beeps. If this happens during printing, stop printing at once. If not printing, disconnect the USB connection cable.

• When the camera is connected to the printer, the cable disconnect prohibit icon [⊘] appears. Do not disconnect the USB cable while [⊘] is displayed.

### 2 Press ▲/▼ to select [PictBridge(PTP)], and then press [MENU/SET].

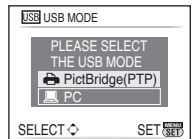

#### Note

- Do not use any other USB connection cables except the supplied one. Use of cables other than the supplied USB connection cable may cause malfunction.
- Turn the camera off before connecting or disconnecting the AC adaptor (DMW-AC5E; optional).
- Before inserting or removing a card, turn the camera off, and disconnect the USB connection cable.



- You cannot switch between the built-in memory and the card while the camera is connected to the printer. Disconnect the USB connection cable, insert (or remove) the card and then connect the USB connection cable to the printer again.
- The pictures recorded in clipboard mode, copy them onto a card (P70), and then print them out.

## Selecting a single picture and printing it

- 1 Press **◀/▶** to select the picture and then press **[MENU/SET]**.

- The message disappears in about 2 seconds.

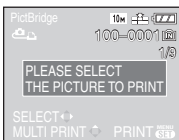

- 2 Press **▲** to select **[PRINT START]** and then press **[MENU/SET]**.

- Refer to P94 for the items which can be set before starting to print the pictures.
- Press **[MENU/SET]** to cancel printing halfway.
- Disconnect the USB connection cable after printing.

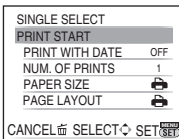

## Selecting multiple pictures and printing them

- 1 Press **▲**.

- 2 Press **▲/▼** to select an item and then press **[MENU/SET]**.

- If the print check screen has appeared, select **[YES]**, and print the pictures.

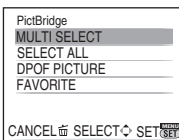

Item	Description of settings
<b>[MULTI SELECT]</b>	Multiple pictures are printed at one time. • Press <b>▲/▼/◀/▶</b> to select the pictures, and then When <b>[DISPLAY]</b> is pressed, <b>[P]</b> appears on the pictures to be printed. (When <b>[DISPLAY]</b> is pressed again, the setting is cancelled.) • After the pictures have been selected, press <b>[MENU/SET]</b> .
<b>[SELECT ALL]</b>	Prints all the stored pictures.
<b>[DPOF PICTURE]</b>	Prints the pictures set in <b>[DPOF PRINT]</b> only. (P85)
<b>[FAVORITE]*</b>	Prints the pictures set as favourites only. (P84)

\* Only when **[FAVORITE]** is at **[ON]** and when there are pictures set as favourites. (P84)

- 3 Press **▲** to select **[PRINT START]** and then press **[MENU/SET]**.

- Refer to P94 for the items which can be set before starting to print the pictures.
- Press **[MENU/SET]** to cancel printing.
- Disconnect the USB connection cable after printing.

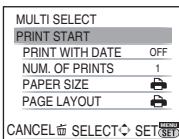

## Print Settings

Select and set the items both on the screen in step 2 of the “Selecting a single picture and printing it” and in step 3 of the “Selecting multiple pictures and printing them” procedures.

- When you want to print pictures in a paper size or a layout which is not supported by the camera, set [PAPER SIZE] or [PAGE LAYOUT] to  and then set the paper size or the layout on the printer. (For details, refer to the operating instructions of the printer.)
- When [DPOF PICTURE] has been selected, the [PRINT WITH DATE] and [NUM. OF PRINTS] items are not displayed.

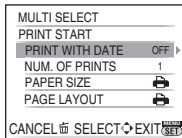

### [PRINT WITH DATE]

Item	Description of settings
[OFF]	Date is not printed.
[ON]	Date is printed.

- If the printer does not support date printing, the date cannot be printed on the picture.
- Since the printer's settings may take precedence over the print with date setting, check the printer's print with date setting as well.



#### Note

When asking the photo shop to print the pictures

- By stamping the date using [TEXT STAMP] (P78) or setting date printing at the time of the [DPOF PRINT] (P85) setting before going to a photo shop, the dates can be printed at the photo shop.

### [NUM. OF PRINTS]





You can set the number of prints up to 999.

### [PAPER SIZE]

Item	Description of settings
	Settings on the printer are prioritised.
[L/3.5"×5"]	89 mm×127 mm
[2L/5"×7"]	127 mm×178 mm
[POSTCARD]	100 mm×148 mm
[16:9]	101.6 mm×180.6 mm
[A4]	210 mm×297 mm
[A3]	297 mm×420 mm
[10×15cm]	100 mm×150 mm
[4"×6"]	101.6 mm×152.4 mm
[8"×10"]	203.2 mm×254 mm
[LETTER]	216 mm×279.4 mm
[CARD SIZE]	54 mm×85.6 mm

- Paper sizes not supported by the printer will not be displayed.

**[PAGE LAYOUT] (Layouts for printing that can be set with this unit)**

Item	Description of settings
	Settings on the printer are prioritised.
	1 picture with no frame on 1 page
	1 picture with a frame on 1 page
	2 pictures on 1 page
	4 pictures on 1 page

- An item cannot be selected if the printer does not support the page layout.

**■ Layout printing****When printing a picture several times on 1 sheet of paper**

For example, if you want to print the same picture 4 times on 1 sheet of paper, set [PAGE LAYOUT] to  and then set [NUM. OF PRINTS] to 4 for the picture that you want to print.

**When printing different pictures on 1 sheet of paper**

For example, if you want to print 4 different pictures on 1 sheet of paper, set [PAGE LAYOUT] to  and then set [NUM. OF PRINTS] to 1 for each of the 4 pictures.

**Note**

- The camera is receiving an error message from the printer when the  indication lights orange during printing. After finishing printing, make sure there are no problems with the printer.
- If the number of prints is high, the pictures may be printed several times. In this case, the remaining number of prints indicated may differ from the number set.

[PLAYBACK] mode: 

## Playing Back Pictures on a TV Screen

### Playing back pictures using the AV cable (supplied)

Preparations:

Set the [TV ASPECT]. (P23)

Turn this unit and the TV off.

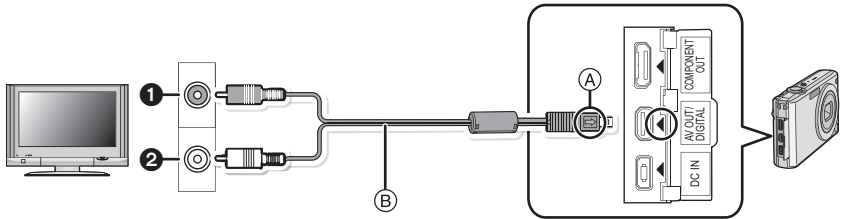

① Yellow: to the video input socket

② White: to the audio input socket

Ⓐ Align the marks, and insert.

Ⓑ AV cable (supplied)

• Check the directions of the connectors, and plug them straight in or unplug them straight out. (Otherwise the connectors may be bent out of shape which will cause trouble.)

**1** Connect the AV cable Ⓑ (supplied) to the video input and the audio input sockets on the TV.

**2** Connect the AV cable to the [AV OUT] socket on the camera.

**3** Turn the TV on and select external input.

**4** Turn the camera on.

#### Note

- Depending on the [ASPECT RATIO], black bands may be displayed on the top and bottom or the left and right of the pictures.
- Do not use any other AV cables except the supplied one.
- Read the operating instructions for the TV.
- When you play back a picture vertically, it may be blurry.
- You can view pictures on TVs in other countries (regions) which use the NTSC or PAL system when you set [VIDEO OUT] in the [SETUP] menu.

### Playing back pictures on a TV with an SD Memory Card slot

Still pictures recorded on an SD Memory Card can be played back on a TV with an SD Memory Card slot.

#### Note

- Depending on the TV model, pictures may not be displayed on the full screen.

- Motion pictures cannot be played back. To play back motion pictures, connect the camera to the TV with the AV cable (supplied).
- You cannot play back pictures on SDHC cards if the TV does not support these cards.
- You may not be able to play back MultiMediaCards.

## Playing back on the TV with component socket

You can enjoy high quality pictures and motion pictures on the TV by connecting the camera with the TV using component cable (DMW-HDC2: optional).

Component output is output as 1080i. Connect with a TV compatible with the 1080i.

Preparations: Turn this unit and the TV off.

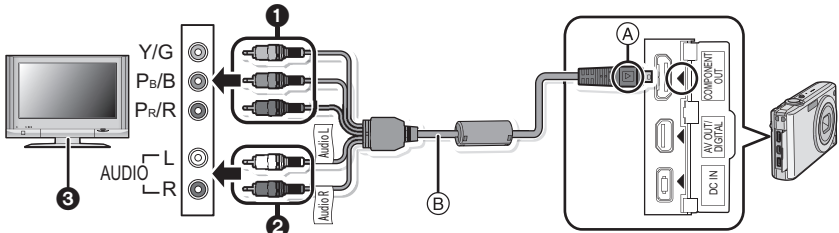

- 1 Component Plugs: Connect the plugs to the component video input sockets on the TV with same colour. (Indication on the TV might be different.)
  - 2 Audio Pin Plugs: to the audio input socket
  - 3 TV with component socket
- (A) Align the marks, and insert.
- (B) Component cable (DMW-HDC2: optional)
- Check the directions of the connectors, and plug them straight in or unplug them straight out. (Otherwise the connectors may be bent out of shape which will cause trouble.)

**1** Connect the component cable (B) (DMW-HDC2; optional) to the component input and the audio input sockets on the TV.

**2** Connect the component cable to the [COMPONENT OUT] socket on the camera.

**3** Turn on the TV and switch to component input.

**4** Turn the camera on.

- Play back the pictures. (Except clipboard)

### Note

- Depending on the [ASPECT RATIO], bands may be displayed on the top and bottom or the left and right of the pictures.
- Do not use any other cables except a genuine Panasonic component cable (DMW-HDC2; optional).
- Audio will be output as monaural.
- When you play back a picture vertically, it may be blurry.
- Image is not displayed on the LCD monitor when the component cable is connected.
- There are some playback menus that cannot be used while the component cable is connected. (P107)
- When pictures are displayed, they may not be displayed properly depending on the type of TV.
- Read the operating instructions for the TV.

# Screen Display

## ■ In recording

### Recording in normal picture mode (📷) (Initial setting)

- 1 Recording mode
- 2 Flash mode (P37)
- 3 AF area (P28)
- 4 Focus (P28)
- 5 Picture size (P58)
- 6 Quality (P59)
- 7 Battery indication (P13)
- 8 Number of recordable pictures (P114)
- 9 Built-in memory (P15)
- 📄: Card (P15) (displayed only during recording)
- 10 Recording state
- 11 ISO sensitivity (P60)
- 12 Shutter speed (P28)
- 13 Aperture value (P28)
- 14 Optical image stabilizer (P65)/([📵]): Jitter alert (P29)

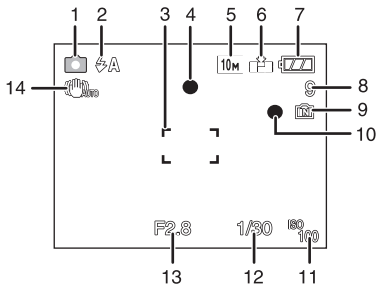

## ■ In recording (after settings)

- 15 AF Tracking (P63)
- 16 White balance (P60)
- 17 ISO sensitivity (P60)
- maximum ISO sensitivity level (P59)
- 18 Colour mode (P65)
- 19 Picture mode (P54)
- 20 Available recording time (P53): R8m30s
- 21 Spot AF area (P62)
- 22 Name\*1 (P47)
- 23 Histogram (P36)
- 24 Travel date (P55)
- 25 Elapsed recording time (P53)
- AF TRACKING ▾: AF tracking operation (P26, 63)
- ISO: Intelligent ISO (P59)
- 26 Current date and time/✈️: Travel destination setting\*2 (P56)
- EZ W [ ] T 1 X: Zoom/Extra optical zoom (P30)/Digital zoom (P30, 65)
- 27 Minimum shutter speed
- 28 Age\*1 (P47)
- Location\*2 (P55)
- 29 Exposure compensation (P42)
- 30 Power LCD (P21)
- A\*: Auto Power LCD (P21)
- 31 Intelligent Exposure (P64)
- 32 Burst (P64)/[ ]: Auto bracket (P43)/[ ]: Audio recording (P66)
- 33 Quick AF (P63)/AF-L: AF Lock (P52)/AF\*: AF assist lamp (P66)

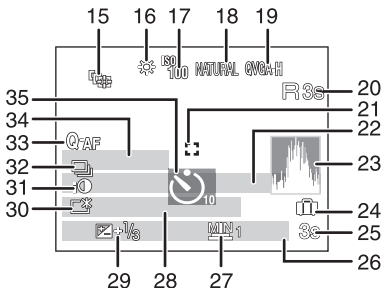

- 34 Number of days that have passed since the travel date (P55)  
 35 Self-timer mode (P41)  
 \*1 This is displayed for about 5 seconds when this unit is turned on in [BABY1]/[BABY2] or [PET] in scene mode.  
 \*2 This is displayed for about 5 seconds when the camera is turned on, after setting the clock and after switching from playback mode to recording mode.

### ■ In playback

- 1 Playback mode (P31)  
 2 Protected picture (P86)  
 3 Favourites (P84)  
 4 Stamped with text indication (P78)  
 5 Picture size (P58)  
 6 Motion picture icon (P74)  
 7 Quality (P59)  
 8 Battery indication (P13)  
 9 Folder/File number (P91)  
 10 Built-in memory (P15)  
 11 Elapsed playback time (P74): 8m30s  
 12 Picture number/Total pictures  
 13 Motion picture recording time (P74): 8m30s  
 14 Histogram (P36)  
 15 Exposure compensation (P42)  
 16 Recording information (P35)  
 17 Favourites settings (P84)  
 18 Recorded date and time/Travel destination setting (P56)/Name (P47)/Location (P55)/Title (P77)  
 19 Age (P47)  
 20 Number of days that have passed since the travel date (P55)  
 21 Power LCD (P21)  
 22 Number of DPOF prints (P85)  
 23 Audio playback (P74)  
 24 Motion picture playback (P74)  
 25 Cable disconnection warning icon (P92)

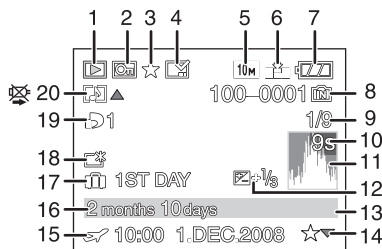

## Cautions for Use

### Optimal use of the camera

**Take care not to drop or knock the unit or put a lot of pressure on it.**

- Take care not to knock or drop the bag/case that you inserted the camera in as the shock may cause damage to the camera, lens or LCD monitor.
- Do not attach any other items to the wrist strap that's included with your camera. While being stored, that item can rest against the LCD monitor and damage it.
- Do not use a paper bag as it can easily rip causing the camera to fall and be damaged.
- We strongly recommend you purchase a good camera bag/case from your local dealer to protect your camera.

**Keep the camera as far away as possible from electromagnetic equipment (such as microwave ovens, TVs, video games etc.).**

- If you use the camera on top of or near a TV, the pictures and sound on the camera may be disrupted by electromagnetic wave radiation.
- Do not use the camera near cell phones because doing so may result in noise adversely affecting the pictures and sound.
- Recorded data may be damaged, or pictures may be distorted, by strong magnetic fields created by speakers or large motors.
- Electromagnetic wave radiation generated by microprocessors may adversely affect the camera, disturbing the pictures and sound.
- If the camera is adversely affected by electromagnetic equipment and stops functioning properly, turn the camera off and remove the battery or disconnect AC adaptor (DMW-AC5E; optional). Then reinsert the battery or reconnect AC adaptor and turn the camera on.

**Do not use the camera near radio transmitters or high-voltage lines.**

- If you record near radio transmitters or high-voltage lines, the recorded pictures and sound may be adversely affected.

**Always use the supplied cords and cables. If you use optional accessories, use the cords and the cables supplied with them.****Do not extend the cords or the cables.****Do not spray the camera with insecticides or volatile chemicals.**

- If the camera is sprayed with such chemicals, the body of the camera may be damaged and the surface finish may peel off.
- Do not keep rubber or plastic products in contact with the camera for a long period of time.

### Cleaning

**Before cleaning the camera, remove the battery or disconnect the power plug from the outlet. Then wipe the camera with a dry soft cloth.**

- When the camera is soiled badly, it can be cleaned by wiping the dirt off with a wrung wet cloth, and then with a dry cloth.
- Do not use solvents such as benzine, thinner, alcohol, kitchen detergents, etc., to clean the camera, since it may deteriorate the external case or the coating may peel off.
- When using a chemical cloth, be sure to follow the accompanying instructions.

### About the LCD monitor

- Do not press the LCD monitor with excessive force. Uneven colours may appear on the LCD monitor and it may malfunction.



- If the camera is cold when you turn it on, the picture on the LCD monitor will be slightly darker than usual at first. However, the picture will return to normal brightness when the internal temperature of the camera increases.

Extremely high precision technology is employed to produce the LCD monitor screen. However, there may be some dark or bright spots (red, blue or green) on the screen. This is not a malfunction. The LCD monitor screen has more than 99.99% effective pixels with a mere 0.01% of the pixels inactive or always lit. The spots will not be recorded on pictures on the built-in memory or a card.

### About the Lens

- Do not press the lens with excessive force.
- Do not leave the camera with the lens facing the sun as rays of light from the sun may cause it to malfunction. Also, be careful when placing the camera outside or near a window.

### Battery

**The battery is a rechargeable lithium ion battery. Its ability to generate power comes from the chemical reaction that takes place inside it. This reaction is susceptible to the surrounding temperature and humidity. If the temperature is too high or too low, the operating time of the battery will become shorter.**

**Always remove the battery after use.**

- Store the removed battery in the battery carrying case (supplied).

**If you drop the battery accidentally, check to see if the body of the battery and the terminals are damaged.**

- Inserting a damaged battery in the camera will damage the camera.

**Bring charged spare batteries when going out.**

- Be aware that the operating time of the battery becomes shorter in low temperature conditions such as at a ski resort.
- When you travel, do not forget to bring the battery charger (supplied) so that you can charge the battery in the country that you are travelling in.

**Dispose of unusable battery.**

- The battery has a limited life.
- Do not throw the battery into fire because it may cause an explosion.

**Do not allow battery terminals to come into contact with metal objects (such as necklaces, hairpins etc.).**

- This can cause short circuiting or heat generation and you may be badly burned if you touch a battery.

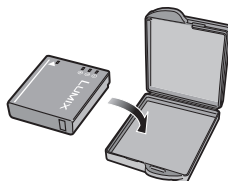

### Charger

- If you use the battery charger near a radio, the radio reception may be disturbed.
- Keep the charger 1 m (3.28 feet) or more away from radios.
- The charger may generate whirring sounds when it is being used. This is not a malfunction.
- After use, be sure to disconnect the power supply device from the electrical outlet. (A very small amount of current is consumed if it is left connected.)
- Keep the terminals of the charger and battery clean.

### Card

**Do not leave the card where the temperature is high, where electromagnetic waves or static electricity are easily generated or exposed to direct sunlight.**

**Do not bend or drop the card.**

- The card may be damaged or the recorded content may be damaged or deleted.
- Put the card in the card case or the storage bag after use and when storing or carrying the card.
- Do not allow dirt, dust or water to get into the terminals on the back of the card and do not touch the terminals with your fingers.

### When not using the camera for a long period of time

- Store the battery in a cool and dry place with a relatively stable temperature: [Recommended temperature: 15 °C to 25 °C (59 °F to 77 °F), Recommended humidity: 40% to 60%]
- Always remove the battery and the card from the camera.
- If the battery is left inserted in the camera, it will discharge even if the camera is turned off. If the battery continues to be left in the camera, it will discharge excessively and may become unusable even if charged.
- When storing the battery for a long period of time, we recommend charging it once a year. Remove the battery from the camera and store it again after it has completely discharged.
- We recommend storing the camera with a desiccant (silica gel) when you keep it in a closet or a cabinet.

### About the picture data

- Recorded data may be damaged or lost if the camera breaks down due to inappropriate handling. Panasonic will not be liable for any damage suffered due to loss of recorded data.

### About tripods

- When you use a tripod, make sure the tripod is stable when this unit is attached to it.
- You may not be able to remove the card or the battery when using a tripod.
- Make sure that the screw on the tripod is not at an angle when attaching or detaching the camera. You may damage the screw on the camera if you use excessive force when turning it. Also, the camera body and the rating label may be damaged or scratched if the camera is attached too tightly to the tripod.
- Read the operating instructions for the tripod carefully.

## Message Display

Confirmation messages or error messages will be displayed on the screen in some cases. The major messages are described below as examples.

### [THIS MEMORY CARD IS LOCKED]

- The Write-Protect switch on the SD Memory Card and the SDHC Memory Card are moved to [LOCK]. Move the switch back to unlock it. (P15)

### [NO VALID PICTURE TO PLAY]

- Record a picture or insert a card with a recorded picture and then play it.

### [THIS PICTURE IS PROTECTED]

- Delete the picture after cancelling the protect setting. (P86)

### [THIS PICTURE CANNOT BE DELETED]/[SOME PICTURES CANNOT BE DELETED]

- Pictures not based on the DCF standard cannot be deleted.
  - If you want to delete some pictures, format the card after saving necessary data on a PC etc. (P23)

### [NO ADDITIONAL SELECTIONS CAN BE MADE]

- The number of pictures, which can be set at one time when [MULTI] has been selected for [DELETE MULTI] (P34), [FAVORITE] (P84), [TITLE EDIT] (P77), [TEXT STAMP] (P78) or [RESIZE] (P80) has been exceeded.
  - Reduce the number of pictures set, and then repeat the operation.
- More than 999 favourites have been set.

### [CANNOT BE SET ON THIS PICTURE]

- [TITLE EDIT], [TEXT STAMP] or [DPOF PRINT] cannot be set for pictures not based on the DCF standard.

### [NOT ENOUGH SPACE ON BUILT-IN MEMORY]/[NOT ENOUGH MEMORY ON THE CARD]

- There is no space left on the built-in memory or the card.
  - When you copy pictures from the built-in memory to the card (batch copy), the pictures are copied until the capacity of the card becomes full.

### [SOME PICTURES CANNOT BE COPIED]/[COPY COULD NOT BE COMPLETED]

- The following pictures cannot be copied.
  - When a picture with the same name as the picture to be copied exists in the copy destination. (Only when copying from a card to the built-in memory.)
  - Files not based on the DCF standard.
- Moreover, pictures recorded or edited by other equipment may not be copied.

### [BUILT-IN MEMORY ERROR FORMAT BUILT-IN MEMORY?]

- This message will be displayed when you formatted the built-in memory on a PC.
  - Format the built-in memory on the camera again. (P23) The data on the built-in memory will be deleted.

**[MEMORY CARD ERROR  
FORMAT THIS CARD?]**

- This card has a format which is not recognised by the camera.  
→ Format the card again with the camera after saving necessary data on a PC etc. (P23)

**[PLEASE TURN CAMERA OFF AND THEN ON AGAIN]/[SYSTEM ERROR]**

- This message appears when the camera is not operating properly.  
→ Turn the camera off and on. If the message persists, contact the dealer or your nearest Service Centre.

**[MEMORY CARD PARAMETER ERROR]**

- Use a card compatible with this unit. (P15)
- You can only use an SDHC Memory Card if using cards with 4 GB or more capacity.

**[MEMORY CARD ERROR  
PLEASE CHECK THE CARD]**

- An error has occurred accessing the card.  
→ Insert the card again.  
→ Insert a different card.

**[READ ERROR/WRITE ERROR  
PLEASE CHECK THE CARD]**

- It has failed to read or write data.  
→ Remove the card after turning the power [OFF]. Insert the card again, turn the power on, and try to read or write the data again.
- The card may be broken.  
→ Insert a different card.

**[MOTION RECORDING WAS CANCELLED DUE TO THE LIMITATION OF THE  
WRITING SPEED OF THE CARD]**

- When you set the picture quality to [HD], [WVGA] or [VGA], we recommend using a high-speed card with "10MB/s" or greater displayed on the package.
- Depending on the type of SD Memory Card or SDHC Memory Card, motion picture recording may stop in the middle.

**[A FOLDER CANNOT BE CREATED]**

- A folder cannot be created because there are no remaining folder numbers that can be used. (P91)  
→ Format the card after saving necessary data on a PC etc. (P23) If you execute [NO.RESET] in the [SETUP] menu after formatting, the folder number is reset to 100. (P22)

**[PICTURE IS DISPLAYED FOR 4:3 TV]/[PICTURE IS DISPLAYED FOR 16:9 TV]**

- The AV cable is connected to the camera.  
→ Press [MENU/SET] if you want to delete this message at once.  
→ Select [TV ASPECT] in the [SETUP] menu if you want to change the TV aspect. (P23)
- This message also appears when the USB connection cable is connected to the camera only. In this case, connect the other end of the USB connection cable to a PC or a printer. (P89, 92)

















**[PRINTER BUSY]/[PLEASE CHECK THE PRINTER]**

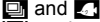

























































- The printer cannot print.  
→ Check the printer.

## Functions that cannot be set or will not work under some conditions

Due to the camera's specifications, it may not be possible to set some of the functions or some functions may not work in some of the conditions under which the camera is used. The table below lists these functions and the corresponding conditions.

- For the functions which cannot be set or will not work in the Intelligent auto mode, refer to "Settings in Intelligent auto mode" (P27).
- For the functions which cannot be set or will not work in the clipboard mode, refer to "Settings During Clipboard" (P70).

Functions that cannot be set or will not work	Main conditions in which the functions cannot be set or will not work
[AUTO POWER LCD] (P21)	<ul style="list-style-type: none"> <li>•  mode</li> </ul>
[POWER SAVE] (P21)	<ul style="list-style-type: none"> <li>• When using the AC adaptor</li> <li>• When connecting to a PC or a printer</li> <li>• When recording or playing back motion pictures</li> <li>• During a slide show</li> <li>• [AUTO DEMO]</li> </ul>
[AUTO LCD OFF] (P21)	<ul style="list-style-type: none"> <li>• When using the AC adaptor</li> <li>• While the menu screen is displayed</li> <li>• While the self-timer is set</li> <li>• While recording motion pictures</li> <li>• When connecting to a PC or a printer</li> </ul>
[AUTO REVIEW] (P22)	<ul style="list-style-type: none"> <li>•  mode</li> </ul>
Extra Optical Zoom (P30)	<ul style="list-style-type: none"> <li>•  in [SCENE MODE]</li> <li>•  mode</li> </ul>
[DIGITAL ZOOM] (P30)	<ul style="list-style-type: none"> <li>•  in [SCENE MODE]</li> <li>• When Intelligent ISO is set</li> </ul>
[HISTOGRAM] (P36)	<ul style="list-style-type: none"> <li>•  mode</li> <li>• During multi playback</li> <li>• During playback zoom</li> <li>• [CALENDAR]</li> </ul>
[FLASH] (P37)	<ul style="list-style-type: none"> <li>• When auto bracket has been set</li> <li>• When the burst mode is set</li> <li>•  in [SCENE MODE]</li> <li>•  mode</li> </ul>
[SELFTIMER] (P41)	<ul style="list-style-type: none"> <li>•  and  in [SCENE MODE]</li> <li>•  mode</li> </ul>
[EXPOSURE] (P42)	<ul style="list-style-type: none"> <li>•  in [SCENE MODE]</li> </ul>
[AUTO BRACKET] (P43)	<ul style="list-style-type: none"> <li>•  in [SCENE MODE]</li> <li>•  mode</li> </ul>
[PICTURE SIZE] (P58)	<ul style="list-style-type: none"> <li>•  in [SCENE MODE]</li> <li>•  mode</li> </ul>

<b>[QUALITY] (P59)</b>	<ul style="list-style-type: none"> <li>• , , , ,  and  in [SCENE MODE]</li> <li>•  mode</li> </ul>
<b>[ASPECT RATIO] (P59)</b>	<ul style="list-style-type: none"> <li>• , , ,  and  in [SCENE MODE]</li> </ul>
<b>[INTELLIGENT ISO] (P59)</b>	<ul style="list-style-type: none"> <li>• [SCENE MODE]</li> <li>•  mode</li> </ul>
<b>[SENSITIVITY] (P60)</b>	<ul style="list-style-type: none"> <li>• [SCENE MODE]</li> <li>•  mode</li> <li>• When Intelligent ISO is set</li> </ul>
<b>[WHITE BALANCE] (P60)</b>	<ul style="list-style-type: none"> <li>• , , , , , , , , , , , , , , , , , ,  and  in [SCENE MODE]</li> </ul>
<b>[WB ADJUST.] (P61)</b>	<ul style="list-style-type: none"> <li>• [B/W], [SEPIA], [COOL] or [WARM] in [COLOR MODE] is set</li> </ul>
<b>[QUICK AF] (P63)</b>	<ul style="list-style-type: none"> <li>• , ,  and  in [SCENE MODE]</li> <li>•  mode</li> </ul>
<b>[BURST] (P64)</b>	<ul style="list-style-type: none"> <li>• , , , ,  and  in [SCENE MODE]</li> <li>•  mode</li> <li>• [AUDIO REC.]</li> </ul>
<b>[I.EXPOSURE] (P64)</b>	<ul style="list-style-type: none"> <li>• [SCENE MODE]</li> <li>•  mode</li> </ul>
<b>[COLOR MODE] (P65)</b>	<ul style="list-style-type: none"> <li>• [SCENE MODE]</li> </ul>
<b>[MIN. SHTR SPEED] (P66)</b>	<ul style="list-style-type: none"> <li>• [SCENE MODE]</li> <li>•  mode</li> <li>• When Intelligent ISO is set</li> </ul>
<b>[AUDIO REC.] (P66)</b>	<ul style="list-style-type: none"> <li>• [AUTO BRACKET]</li> <li>• [BURST]</li> <li>• ,  and  in [SCENE MODE]</li> <li>•  mode</li> </ul>
<b>[AF ASSIST LAMP] (P66)</b>	<ul style="list-style-type: none"> <li>• , , , , ,  and  in [SCENE MODE]</li> </ul>
<b>Playback Zoom (P32)</b>	<ul style="list-style-type: none"> <li>• When playing back motion pictures</li> <li>• Still pictures with audio (when playing back audio)</li> </ul>
<b>[TITLE EDIT] (P77)</b>	<ul style="list-style-type: none"> <li>• Motion pictures</li> <li>• Protected pictures</li> </ul>
<b>[TEXT STAMP] (P78)</b>	<ul style="list-style-type: none"> <li>• Pictures recorded without setting the clock or title</li> <li>• Motion pictures</li> <li>• Still pictures with audio</li> <li>• Pictures stamped with [TEXT STAMP]</li> </ul>
<b>[RESIZE] (P80)</b>	<ul style="list-style-type: none"> <li>• Motion pictures</li> <li>• Still pictures with audio</li> <li>• Pictures stamped with [TEXT STAMP]</li> </ul>
<b>[TRIMMING] (P81)</b>	<ul style="list-style-type: none"> <li>• Motion pictures</li> <li>• Still pictures with audio</li> <li>• Pictures stamped with [TEXT STAMP]</li> </ul>
<b>[LEVELING] (P82)</b>	<ul style="list-style-type: none"> <li>• Motion pictures</li> <li>• Still pictures with audio</li> <li>• Pictures stamped with [TEXT STAMP]</li> </ul>

<b>[ASPECT CONV.] (P82)</b>	<ul style="list-style-type: none"> <li>• Pictures taken with <b>3:2</b> or <b>4:3</b></li> <li>• Motion pictures</li> <li>• Still pictures with audio</li> <li>• Pictures stamped with [TEXT STAMP]</li> </ul>
<b>[ROTATE] (P83)</b>	<ul style="list-style-type: none"> <li>• Motion pictures</li> <li>• Protected pictures</li> </ul>
<b>[ROTATE DISP.] (P83)</b>	<ul style="list-style-type: none"> <li>• Multi playback</li> <li>• [CALENDAR]</li> </ul>
<b>PRINT WITH DATE</b>	<ul style="list-style-type: none"> <li>• Pictures stamped with [TEXT STAMP]</li> </ul>
<b>[AUDIO DUB.] (P87)</b>	<ul style="list-style-type: none"> <li>• Motion pictures</li> <li>• Protected pictures</li> </ul>

### ■ Functions that cannot be used when the component cable is connected

[LCD MODE]/[HISTOGRAM]/[TITLE EDIT]/[TEXT STAMP]/[RESIZE]/[TRIMMING]/[LEVELING]/[ASPECT CONV.]/[AUDIO DUB.]/[COPY]/[MULTI] settings of [DPOF PRINT]/[MULTI] settings of [PROTECT]/[DELETE MULTI]/Creation of still pictures from motion pictures

## Troubleshooting

First, try out the following procedures (P107–113).

If the problem is not resolved, it may be improved by selecting **[RESET] (P22)** on the **[SETUP]** menu when taking pictures.

### Battery and power source

#### The camera cannot be operated even when it is turned on.

- The battery is not inserted correctly. (P14)
- The battery is exhausted.

#### The LCD monitor turns off while the camera is turned on.

- Is [AUTO LCD OFF] (P21) of the [ECONOMY] mode active?  
→ Press the shutter button halfway to cancel these modes.
- The battery is exhausted.

#### The camera turns off immediately after it is turned on.

- The battery is exhausted.
- If you leave the camera on, the battery will be exhausted.  
→ Turn the camera off frequently by using the [ECONOMY] mode etc. (P21)

#### The [CHARGE] lamp flashes.

- Is the temperature of the battery excessively high or low? If it is, it will take longer than usual to charge the battery or charging may remain incomplete.
- Are the terminals of the charger or battery dirty?  
→ Wipe off the dirt using a dry cloth.

## Recording

### The picture cannot be recorded.

- Is the [REC]/[PLAYBACK] selector switch at the  setting? (P24)
- Is the mode dial correctly set?
- Is there any memory remaining on the built-in memory or the card?
  - Delete the pictures which are not necessary to increase the available memory. (P33)

### The recorded picture is whitish.

- The picture can become whitish if there is dirt e.g. fingerprints on the lens.
  - If the lens is dirty, turn on the camera, eject the lens barrel (P11) and gently wipe the lens surface with a soft dry cloth.

### The area around where the pictures were taken becomes dark.

- Was this picture taken with the flash at the close range when the zoom is near [W] (1×)?
  - Zoom in a little, and then take the pictures. (P30)
- Is this a picture taken in [PIN HOLE] in scene mode?

### The recorded picture is too bright or dark.

- Check that the exposure is correctly compensated. (P42)
- Setting the [MIN. SHTR SPEED] to faster speed might make the picture darker.
  - Set the [MIN. SHTR SPEED] to slower speed.

### 2 or 3 pictures are taken at one time.

- Set auto bracket (P43), [HI-SPEED BURST] (P49), [FLASH BURST] (P49) in scene mode or [BURST] (P64) of the [REC] mode menu to [OFF].

### The subject is not focused properly.

- The focus range varies depending on the recording mode.
  - Set to the proper mode for the distance to the subject.
- The subject is beyond the focus range of the camera. (P28)
- There is camera shake (jitter) or the subject is moving slightly. (P29)

### The recorded picture is blurred.

#### The optical image stabilizer is not effective.

- The shutter speed becomes slower when pictures are taken in dark places so hold the camera firmly with both hands to take the pictures. (P25)
- When taking pictures at a slow shutter speed, use the self-timer. (P41)

### Taking pictures using auto bracket is not possible.

- Is the number of recordable pictures 2 or less?

### The recorded picture looks rough.

#### Noise appears on the picture.

- Is the ISO sensitivity high or the shutter speed slow? (ISO sensitivity is set to [AUTO] when the camera is shipped. Therefore, when taking pictures indoors etc. noise will appear.)
  - Decrease the ISO sensitivity. (P60)



- Set [COLOR MODE] to [NATURAL]. (P65)
- Take pictures in bright places.
- Has [HIGH SENS.] or [HI-SPEED BURST] in the scene mode been set? If so, the resolution of the recorded picture decreases slightly because of high sensitivity processing, but this is not a malfunction.

### **The brightness or the hue of the recorded picture is different from the actual scene.**

- If recording under fluorescent light, the brightness or the hue may change slightly when the shutter speed becomes fast. This occurs due to the characteristics of fluorescent light. It is not a malfunction.

### **A reddish vertical line (smear) appears on the LCD monitor during picture-taking.**

- This is a characteristic of CCDs, and it appears when the subject has a bright part. Some unevenness may occur in the surrounding areas, but this is not a malfunction.
- It is recorded in motion pictures but is not recorded on still pictures.
- It is recommended that you take pictures while taking care not to expose the screen to sunlight or any other source of strong light.

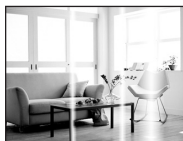

### **Motion picture recording stops in the middle.**

- Are you using a MultiMediaCard? This unit does not support MultiMediaCards.
  - When you set the picture quality to [HD], [WVGA] or [VGA], we recommend using a high-speed card with "10MB/s" or greater displayed on the package.
- Depending on the type of the card, recording may stop in the middle.

### **The subject cannot be locked. (AF track fails)**

- If the subject has different colours as the periphery, set the AF area to those colours specific to the subject by aligning that area with the AF area. (P63)

## **Lens**

### **Recorded image may be warped, or nonexistent colour is surrounding the subject.**

- It is possible that the subject may be warped slightly, or the borders get coloured, depending on the zoom magnification, due to the characteristics of the lens. Also, the peripherals of the image might look warped because the perspective is enhanced when the wide angle is used. This is not a malfunction.

## **LCD monitor**

### **The LCD monitor turns off although the camera is turned on.**

- The LCD monitor turns off and the status indicator lights when [AUTO LCD OFF] (P21) is selected for the [ECONOMY] mode.
  - [This does not happen when using the AC adaptor (DMW-AC5E; optional).]
 If the remaining battery power is low, it may take longer for the flash to be charged, and the time during which the LCD monitor is turned off may become longer.

**The LCD monitor becomes darker or brighter for a moment.**

- This phenomenon appears when you press the shutter button halfway to set the aperture value and does not affect the recorded pictures.
- This phenomenon also appears when the brightness changes when the camera is zoomed or when the camera is moved. This is because of operation of the automatic aperture of the camera, and it is not a malfunction.

**The LCD monitor flickers indoors.**

- The LCD monitor may flicker for a few seconds after turning the camera on indoors under fluorescent light. This is not a malfunction.

**The LCD monitor is too bright or dark.**

- Adjust the brightness of the screen. (P20)
- [POWER LCD] is activated. (P21)

**Black, red, blue and green dots appear on the LCD monitor.**

- This is not a malfunction.  
These pixels do not affect the recorded pictures.

**Noise appears on the LCD monitor.**

- In dark places, noise may appear to maintain the brightness of the LCD monitor. This does not affect the pictures you are recording.

**Flash****The flash is not activated.**

- Is the flash setting set to ?  
→ Change the flash setting. (P37)
- Flash mode is not available when auto bracket (P43) or [BURST] (P64) in [REC] mode menu has been set.

**Flash is activated several times.**

- The flash is activated twice when red-eye reduction (P37) has been set.
- Has [FLASH BURST] (P49) in scene mode been set?

**Playback****The picture being played back is rotated and displayed in an unexpected direction.**

- [ROTATE DISP.] (P83) is set to [ON].
- You can rotate pictures with the [ROTATE] function. (P83)

### The picture is not played back.

- Is the [REC]/[PLAYBACK] selector switch set to [▶]? (P31)
- Is there a picture on the built-in memory or the card?
  - The pictures on the built-in memory appear when a card is not inserted. The picture data on the card appears when a card is inserted.
- Is this a picture whose file name has been changed in the PC? If it is, it cannot be played back by this unit.

### The recorded pictures are not displayed.

- Has [CATEGORY PLAY] or [FAVORITE PLAY] been set for playback?
  - Change to [NORMAL PLAY]. (P31)

### The folder number and the file number are displayed as [—] and the screen turns black.

- Is this a non-standard picture, a picture which has been edited using a PC or a picture which was taken by another make of digital camera?
- Did you remove the battery immediately after picture-taking or did you take the picture using a battery with a low remaining charge?
  - Format the data to delete the pictures mentioned above. (P23)  
(Other pictures will be deleted as well and it will not be possible to restore them. Therefore, check well before formatting.)

### With a calendar search, pictures are displayed on dates differing from the actual dates on which the pictures were taken.

- Is the clock in the camera set properly? (P16)
- When pictures edited using a PC or pictures taken by other equipment are searched, they may be displayed on dates differing from the actual dates on which the pictures were taken.

### White round spots like soap bubbles appear on the recorded picture.

- If you take a picture with the flash in a dark place or indoors, white round spots may appear on the picture caused by the flash reflecting of particles of dust in the air. This is not a malfunction. A characteristic of this is that the number of round spots and their position differ in every picture.



### [THUMBNAIL IS DISPLAYED] appears on the screen.

- Is it a picture that has been recorded with other equipment? In such cases, these pictures may be displayed with a deteriorated picture quality.

### A clicking sound is recorded in the motion pictures.

- This unit automatically adjusts the aperture during motion picture recording. At such times, a clicking sound is heard, and this sound may be recorded on the motion pictures. This is not a malfunction.

## TV, PC and printer

### The picture does not appear on the television.

- Is the camera connected to the TV correctly?  
→ Set the TV input to external input mode.
- Output from the [COMPONENT OUT] socket is not possible when it is connected to the PC or the printer.  
→ Connect it only to the TV.

### The display areas on the TV screen and the camera's LCD monitor are different.

- Depending on the TV model, the pictures may be extended horizontally or vertically or they may be displayed with their edges cut off.

### The motion pictures cannot be played back on a TV.

- Are you trying to play back the motion pictures by directly inserting the card in the card slot of the TV?  
→ Connect the camera to the TV with the AV cable (supplied), or with the component cable (DMW-HDC2; optional), and then play back the motion pictures on the camera. (P96, 97)



### The picture is not displayed fully on the TV.

- Check [TV ASPECT] setting. (P23)

### The picture cannot be transferred when the camera is connected to a PC.

- Is the camera connected to the PC correctly?
- Is the camera recognised by the PC correctly?  
→ Set to [PC] in [USB MODE]. (P22, 89)

### The card is not recognised by the PC. (The built-in memory is recognised.)

- Disconnect the USB connection cable. Connect it again while the card is inserted in the camera.
- When the mode dial is set to , contents of the built-in memory will be displayed.  
→ Set the mode dial to anything except .

### The picture cannot be printed when the camera is connected to a printer.



- Pictures cannot be printed using a printer which does not support PictBridge.  
→ Set to [PictBridge(PTP)] in [USB MODE]. (P22, 92)

### The ends of the pictures are cut at printing.

- When using a printer with a trimming or borderless printing function, cancel this function before printing. (For details, refer to the operating instructions for the printer.)
- When you order photo studios to print pictures, ask the photo studio if the pictures can be printed with both ends.

## Others

### An unreadable language was selected by mistake.

- Press [MENU/SET], select the [SETUP] menu icon  and then select the  icon to set the desired language. (P23)

**A red lamp sometimes turns on when the shutter button is pressed halfway.**

- In dark places, the AF assist lamp (P66) lights red to make it easier to focus on a subject.

**The AF assist lamp does not turn on.**

- Is [AF ASSIST LAMP] on the [REC] mode menu set to [ON]? (P66)
- The AF assist lamp does not turn on in bright places.

**The camera becomes warm.**

- The surface of the camera may become warm during use. This does not affect the performance or quality of the camera.

**The lens clicks.**

- When the brightness changes due to zoom or camera movement etc., the lens may click and the picture on the screen may drastically change. However, the picture is not affected. The sound is caused by the automatic adjustment of the aperture. This is not a malfunction.

**The clock is reset.**

- If you do not use the camera for a long time, the clock may be reset.  
→ When the message [PLEASE SET THE CLOCK] appears, set the clock again. When you take a picture before setting the clock, [0:00 0. 0. 0] is recorded. (P16)

**When pictures are taken using the zoom, they are slightly distorted and the areas around the subject contain colours which are not actually present.**

- It is possible that the subject may be warped slightly, or the borders get coloured, depending on the zoom magnification, due to the characteristics of the lens, but this is not a malfunction.

**Zooming stops instantaneously.**

- When using the extra optical zoom, the zooming action will stop temporarily near [W]. This is not a malfunction.

**The file numbers are not recorded consecutively.**

- When you perform an operation after taking a certain action, the pictures may be recorded in folders with different numbers from the ones used prior to the operation. (P91)

**The file numbers are recorded in ascending order.**

- If the battery was inserted or removed without first turning the camera's power off, the folder and file numbers for the pictures taken will not be stored in the memory. When the power is then turned back on and pictures are taken, they may be stored under file numbers which should have been assigned to previous pictures.

**[AGE] is not displayed correctly.**

- Check the clock (P16) and birthday settings (P47).

**The lens barrel is retracted.**

- The lens barrel retracts about 15 seconds after switching from [REC] mode to [PLAYBACK] mode.

## Number of Recordable Pictures and Available Recording Time

- The number of recordable pictures and the available recording time are an approximation. (These vary depending on the recording conditions and the type of card.)
- The number of recordable pictures and the available recording time varies depending on the subjects.

### ■ Number of recordable pictures

Aspect ratio		4:3							
Picture size		10M (10M): (3648×2736)		7M (7M $\overline{E}$ ): (3072×2304)		5M (5M $\overline{E}$ ): (2560×1920)		3M (3M $\overline{E}$ ): (2048×1536)	
Quality									
Built-in Memory (Approx. 50 MB)		9	20	14	28	20	40	32	62
Card	32 MB	5	11	7	16	11	23	18	36
	64 MB	11	24	16	34	24	48	38	75
	128 MB	24	49	35	69	50	99	78	150
	256 MB	48	97	68	135	98	190	150	290
	512 MB	97	190	135	270	195	380	300	590
	1 GB	195	380	270	540	390	770	600	1180
	2 GB	390	770	550	1090	790	1530	1220	2360
	4 GB	770	1520	1090	2150	1560	3010	2410	4640
	8 GB	1580	3100	2230	4380	3180	6130	4910	9440
	16 GB	3180	6250	4490	8820	6410	12350	9880	19000
32 GB	6390	12540	9010	17700	12870	24780	19820	38120	

Aspect ratio		4:3			
Picture size		2M (2M $\overline{E}$ ): (1600×1200)		0.3M (0.3M $\overline{E}$ ): (640×480)	
Quality					
Built-in Memory (Approx. 50 MB)		51	97	240	400
Card	32 MB	29	56	145	230
	64 MB	61	115	290	480
	128 MB	125	230	600	970
	256 MB	240	460	1170	1900
	512 MB	480	910	2320	3770
	1 GB	970	1830	4640	7550
	2 GB	1920	3610	8780	12290
	4 GB	3770	7090	17240	24130
	8 GB	7670	14440	35080	49120
	16 GB	15440	29070	70590	98840
32 GB	30970	58310	141620	198270	

Aspect ratio		3:2							
Picture size		9M (9M): (3648×2432)		6M (6M EZ): (3072×2048)		4.5M (4.5M EZ): (2560×1712)		2.5M (2.5M EZ): (2048×1360)	
Quality		■■■		■■■		■■■		■■■	
Built-in Memory (Approx. 50 MB)		11	22	15	32	22	45	36	69
Card	32 MB	6	12	8	18	13	26	20	40
	64 MB	13	27	19	38	27	54	43	83
	128 MB	27	55	39	78	56	110	88	165
	256 MB	54	105	77	150	110	210	170	330
	512 MB	105	210	150	300	210	430	340	650
	1 GB	210	430	300	600	440	860	680	1310
	2 GB	440	870	620	1220	890	1700	1360	2560
	4 GB	870	1720	1230	2410	1740	3350	2680	5020
	8 GB	1770	3500	2500	4910	3550	6820	5450	10230
	16 GB	3580	7050	5040	9880	7160	13720	10980	20590
32 GB	7180	14160	10110	19820	14360	27530	22020	41300	

Aspect ratio		16:9							
Picture size		7.5M (7.5M): (3648×2056)		5.5M (5.5M EZ): (3072×1728)		3.5M (3.5M EZ): (2560×1440)		2M (2M EZ): (1920×1080)	
Quality		■■■		■■■		■■■		■■■	
Built-in Memory (Approx. 50 MB)		13	26	18	37	27	53	47	92
Card	32 MB	7	15	10	21	15	30	27	53
	64 MB	15	32	22	45	32	63	57	105
	128 MB	33	65	46	92	66	125	115	220
	256 MB	65	125	91	180	130	250	220	430
	512 MB	125	250	180	350	250	500	450	860
	1 GB	250	510	360	710	520	1000	900	1720
	2 GB	520	1020	730	1420	1040	1980	1800	3410
	4 GB	1030	2010	1450	2800	2040	3890	3540	6700
	8 GB	2090	4090	2950	5710	4160	7920	7220	13640
	16 GB	4220	8230	5950	11490	8370	15940	14530	27450
32 GB	8470	16520	11940	23050	16800	31970	29150	55070	

### ■ Available recording time (when recording motion pictures)

Picture quality setting		HD	WVGA	VGA	QVGA-H	QVGA-L
Built-in Memory (Approx. 50 MB)		–	–	–	1 min 38 s	4 min 20 s
Card	32 MB	4 s	14 s	17 s	56 s	2 min 35 s
	64 MB	12 s	33 s	39 s	1 min 58 s	5 min 20 s
	128 MB	29 s	1 min 10 s	1 min 22 s	4 min 00 s	10 min 50 s
	256 MB	59 s	2 min 15 s	2 min 40 s	7 min 50 s	21 min 10 s
	512 MB	2 min 00 s	4 min 30 s	5 min 20 s	15 min 40 s	42 min 00 s
	1 GB	4 min 00 s	9 min 20 s	10 min 50 s	31 min 20 s	1 h 24 min
	2 GB	8 min 20 s	19 min 00 s	22 min 10 s	1 h 4 min	2 h 51 min
	4 GB	16 min 30 s	37 min 30 s	43 min 40 s	2 h 5 min	5 h 36 min
	8 GB	33 min 40 s	1 h 16 min	1 h 28 min	4 h 15 min	11 h 23 min
	16 GB	1 h 8 min	2 h 33 min	2 h 59 min	8 h 35 min	22 h 55 min
	32 GB	2 h 16 min	5 h 8 min	5 h 59 min	17 h 13 min	46 h 00 min

- \* Motion pictures can be recorded continuously for up to 15 minutes. Also, continuous recording exceeding 2 GB is not possible. (Example: [8m 20s] with [HD])  
Remaining time for continuous recording is displayed on the screen.



#### Note

- The number of recordable pictures and the available recording time displayed on the screen may not decrease in order.
- This unit does not support recording motion pictures on MultiMediaCards.
- The extra optical zoom does not work in [TRANSFORM], [HIGH SENS.], [HI-SPEED BURST], [FLASH BURST], [PIN HOLE] or [FILM GRAIN] in scene mode so the picture size for [7] is not displayed.



## Specifications

**Digital Camera:** Information for your safety

<b>Power Source:</b>	DC 5.1 V
<b>Power Consumption:</b>	1.4 W (When recording) 0.6 W (When playing back)

**Camera effective pixels:** 10,100,000 pixels

**Image sensor:** 1/2.33" CCD, total pixel number 10,700,000 pixels, Primary colour filter

**Lens:** Optical 5× zoom, f=4.4 mm to 22 mm (35 mm film camera equivalent: 25 mm to 125 mm)/F2.8 to F5.9

**Digital zoom:** Max. 4×

**Extra optical zoom:** Max. 8.9×

**Focus:** Normal/Macro/Face detection/AF Tracking/11-area-focusing/1-area-focusing (High speed)/1-area-focusing/Spot-focusing

**Focus range:** Normal: 50 cm (1.64 feet) (Wide)/1 m (3.28 feet) (Tele) to ∞  
Macro/Intelligent auto/Clipboard mode:  
5 cm (0.17 feet) (Wide)/1 m (3.28 feet) (Tele) to ∞  
Scene mode: There may be differences in the above settings.

**Shutter system:** Electronic shutter+Mechanical shutter

**Motion picture recording:** 1280×720 pixels (30 frames/second, only when using a Card)/  
848×480 pixels (30 frames/second, only when using a Card)/  
640×480 pixels (30 frames/second, only when using a Card)/  
320×240 pixels (30 frames/second, 10 frame/second)  
With audio

**Burst recording**

**Burst speed:** 2.5 pictures/second (Normal), Approx. 2 pictures/second (Unlimited)

**Number of recordable pictures:** Max. 5 pictures (Standard), max. 3 pictures (Fine), Depends on the remaining capacity of the built-in memory or the card (Unlimited).  
(Performance in burst recording is only with SD Memory Card/SDHC Memory Card. MultiMediaCard performance will be less.)

**Hi-speed burst**

**Burst speed:** Approx. 6 pictures/second  
(3M (4:3), 2.5M (3:2) or 2M (16:9) is selected as the picture size.)

**Number of recordable pictures:** When using the built-in memory:  
Approx. 15 pictures (immediately after formatting)  
When using a Card: Max. 100 pictures (differs depending on the type of Card and the recording conditions)

<b>ISO sensitivity:</b>	AUTO/100/200/400/800/1600 [HIGH SENS.] mode: 1600 to 6400
<b>Shutter speed:</b>	8 seconds to 1/2000th of a second [STARRY SKY] mode: 15 seconds, 30 seconds, 60 seconds
<b>White balance:</b>	Auto white balance/Daylight/Cloudy/Shade/Incandescent lights/ White set
<b>Exposure (AE):</b>	Programme AE Exposure compensation (1/3 EV Step, -2 EV to +2 EV)
<b>Metering mode:</b>	Multiple
<b>LCD monitor:</b>	2.5" TFT LCD (Approx. 230,000 dots) (field of view ratio about 100%)
<b>Flash:</b>	Flash range: [ISO AUTO] Approx. 60 cm (1.97 feet) to 6.0 m (19.7 feet) (Wide) AUTO, AUTO/Red-eye reduction, Forced flash ON (Forced ON/ Red-eye reduction), Slow sync./Red-eye reduction, Forced flash OFF
<b>Microphone:</b>	Monaural
<b>Speaker:</b>	Monaural
<b>Recording media:</b>	Built-in Memory (Approx. 50 MB)/SD Memory Card/SDHC Memory Card/MultiMediaCard (Still pictures only)
<b>Picture size</b>	
<b>Still picture:</b>	When the aspect ratio setting is [4:3] 3648×2736 pixels, 3072×2304 pixels, 2560×1920 pixels, 2048×1536 pixels, 1600×1200 pixels, 640×480 pixels When the aspect ratio setting is [3:2] 3648×2432 pixels, 3072×2048 pixels, 2560×1712 pixels, 2048×1360 pixels When the aspect ratio setting is [16:9] 3648×2056 pixels, 3072×1728 pixels, 2560×1440 pixels, 1920×1080 pixels
<b>Motion pictures:</b>	1280×720 pixels (Only when using a Card) 848×480 pixels (Only when using a Card) 640×480 pixels (Only when using a Card) 320×240 pixels
<b>Quality:</b>	Fine/Standard
<b>Recording file format</b>	
<b>Still Picture:</b>	JPEG (based on "Design rule for Camera File system", based on "Exif 2.21" standard)/DPOF corresponding
<b>Pictures with audio:</b>	JPEG (based on "Design rule for Camera File system", based on "Exif 2.21" standard)+ "QuickTime" (pictures with audio)
<b>Motion pictures:</b>	"QuickTime Motion JPEG" (motion pictures with audio)
<b>Interface</b>	
<b>Digital:</b>	"USB 2.0" (High Speed)
<b>Analogue video/     audio:</b>	NTSC/PAL Composite (Switched by menu), Component Audio line output (monaural)
<b>Terminal</b>	
<b>[COMPONENT OUT]:</b>	Dedicated jack (10 pin)
<b>[AV OUT/DIGITAL]:</b>	Dedicated jack (8 pin)
<b>[DC IN]:</b>	Dedicated jack (2 pin)

<b>Dimensions:</b>	Approx. 94.7 mm (W)×51.9 mm (H)×22.0 mm (D) [3 3/4" (W)×2 1/16"(H)×7/8" (D)] (excluding the projecting parts)
<b>Mass:</b>	Approx. 125 g/4.41 oz (excluding card and battery) Approx. 146 g/5.15 oz (with card and battery)
<b>Operating temperature:</b>	0 °C to 40 °C (32 °F to 104 °F)
<b>Operating humidity:</b>	10% to 80%

**Battery Charger (Panasonic DE-A40A):**

Information for your safety

<b>Input:</b>	110 V to 240 V ~ 50/60 Hz, 0.2 A
<b>Output:</b>	CHARGE 4.2 V --- 0.8 A

**Battery Pack (lithium-ion) (Panasonic DMW-BCE10E):**

Information for your safety

<b>Voltage:</b>	3.6 V
-----------------	-------

EU



QuickTime and the QuickTime logo are trademarks or registered trademarks of Apple Inc., used under license therefrom.

**B**

VQT1R99

F0708MG0 ( 5000 (A) )

©



**Matsushita Electric Industrial Co., Ltd.**

Web Site: <http://panasonic.net>

Pursuant to at the directive 2004/108/EC, article 9(2)  
Panasonic Testing Centre  
Panasonic Marketing Europe GmbH  
Winsbergring 15, 22525 Hamburg, Germany