

Panasonic®

Operating Instructions Plasma Television

Model No. **TX-PF42G10**
TX-PF46G10
TX-PF50G10

VIERA

VIERA
Link

 VIERA
IMAGE VIEWER

 Q-Link

DVB®

 DOLBY
DIGITAL PLUS

 dts
Digital Out

AVCHD™

 SD
HG

FULL
HD
1920x1080p

HD
TV
1080p

HDMI™
HIGH-DEFINITION MULTIMEDIA INTERFACE

Please read these instructions before operating your set and retain them for future reference.
The images shown in this manual are for illustrative purposes only.

Please refer to Pan European Guarantee Card if you need to contact your local Panasonic dealer for assistance.

English



TQB0E0802U

Turn your own living room into a movie theatre!

Experience an amazing level of multi-



Notice for DVB functions

- Any functions related to DVB (Digital Video Broadcasting) will work in areas where DVB-T (MPEG2 and MPEG4-AVC(H.264)) digital terrestrial broadcasting are received or where DVB-C (MPEG2 and MPEG4-AVC(H.264)) digital cable services are supplied.

Consult your local dealer with coverage areas or your cable provider to access.

- DVB functions may not be available in some countries.
- Some functions may not be available in some countries.
- Some functions may not be available with some cable provider.
- This TV has the capability for DVB specifications. But future DVB services cannot be guaranteed.

media excitement

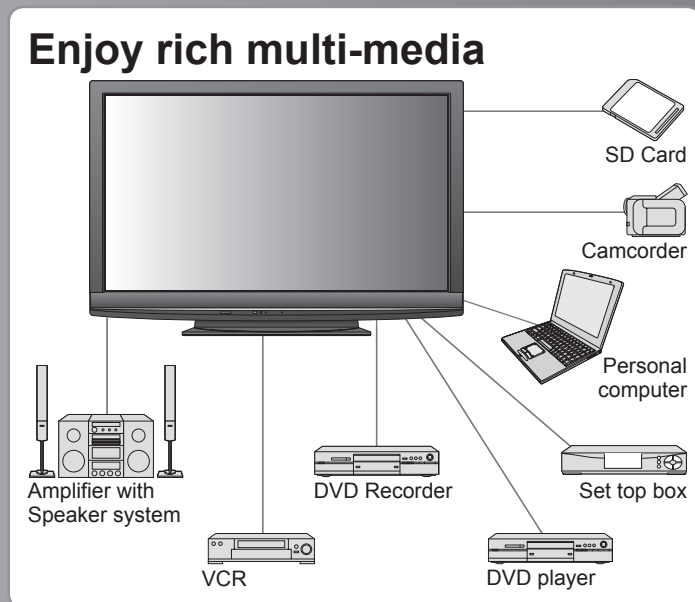

Contents

Be Sure to Read

- Safety Precautions 4
(Warning / Caution)
- Notes 5
- Maintenance 5

Quick Start Guide

- Accessories / Options 6
- Identifying Controls 8
- Basic Connection 10
- Auto Setup 12

Enjoy your TV!

Basic Features

- Watching TV 14
- Using TV Guide 18
- Viewing Teletext 20
- Watching External inputs 22
- How to Use Menu Functions 24
(picture, sound quality, etc.)

Advanced Features

- Retuning from Setup Menu 30
- Tuning and Editing Channels (DVB) 32
- Tuning and Editing Channels (Analogue) 34
- Child Lock 36
- Using Common Interface 37
- Shipping Condition 38
- Updating the TV Software 39
- Input Labels 40
- How to Use VIERA TOOLS 41
- Viewing from SD Card 42
(VIERA IMAGE VIEWER)
- Displaying PC Screen on TV 45
- Link Functions 46
(Q-Link / VIERA Link)
- External Equipment 54

FAQs, etc.

- Technical Information 56
- FAQs 61
- Specifications 63
- Licence 64

Up to 100,000 hours Plasma Panel Lifetime

The Plasma display panel used in the 2009 VIERA TV range is rated for up to 100,000 hours.*

*This measurement is based on the time taken for the brightness of the panel to reduce to half of its maximum level.

The time taken to reach this level may vary depending on the image content and the environment where the TV is used.

Image retention and malfunctions are not taken into account.

Safety Precautions

Warning

Handling the mains plug and lead

- Insert the mains plug fully into the socket outlet. (If the mains plug is loose, it could generate heat and cause fire.)
- Ensure that the mains plug is easily accessible.
- Ensure the earth pin on the mains plug is securely connected to prevent electrical shock.
 - An apparatus with CLASS I construction shall be connected to a mains socket outlet with a protective earthing connection.
- Do not touch the mains plug with a wet hand. (This may cause electrical shock.)
- Do not use any mains lead other than that provided with this TV. (This may cause fire or electrical shock.)
- Do not damage the mains lead. (A damaged lead may cause fire or electrical shock.)
 - Do not move the TV with the lead plugged in the socket outlet.
 - Do not place a heavy object on the lead or place the lead near a high-temperature object.
 - Do not twist the lead, bend it excessively, or stretch it.
 - Do not pull on the lead. Hold onto the mains plug body when disconnecting lead.
 - Do not use a damaged mains plug or socket outlet.

If you find any abnormality, remove the mains plug immediately!

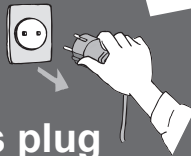

AC 220-240 V
50 / 60 Hz



Power source

- This TV is designed to operate on 220-240 V, 50 / 60 Hz AC.

Do not remove covers NEVER modify the TV yourself

(High-voltage components may cause serious electrical shock.)

- Do not remove the rear cover as live parts are accessible when it is removed. There are no user serviceable parts inside.
- Have the TV checked, adjusted, or repaired at your local Panasonic dealer.

Do not expose to rain or excessive moisture

- To prevent damage which might result in electric shock or fire, do not expose this TV to rain or excessive moisture. This TV must not be exposed to dripping or splashing water and objects filled with liquid, such as vases, must not be placed on top of or above the TV.

Do not expose to direct sunlight and other sources of heat

- Avoid exposing the TV to direct sunlight and other sources of heat. To prevent fire never place any type of candle or naked flame on top or near the TV.

Do not place foreign objects inside the TV

- Do not allow any objects to drop into the TV through the air vents (fire or electrical shock may result).

Do not place the TV on sloped or unstable surfaces

- The TV may fall off or tip over.

Use only the dedicated pedestals / mounting equipment

- Using an unapproved pedestal or other fixtures may make the TV unstable, risking injury. Be sure to ask your local Panasonic dealer to perform setup.
- Use approved pedestals / mounts (p. 6).

Do not allow children to handle SD Card

- As with a small object, SD Card can be swallowed by young children. Please remove SD Card immediately after use.

Caution

■ When cleaning the TV, remove the mains plug

- Cleaning an energized TV may cause electrical shock.

■ When the TV is not going to be used for a long period of time, remove the mains plug

- This TV will still consume some power even in the Off mode, as long as the mains plug is still connected to a live socket outlet.

■ Transport only in upright position

- Transporting the TV with its display panel facing upright or downward may cause damage to the internal circuitry.

■ Allow sufficient space around the TV for radiated heat

Minimum distance

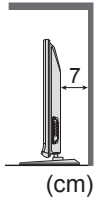
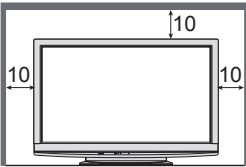

- When using the pedestal, keep the space between the bottom of the TV and the surface where the TV is set.
- In case of using Wall-hanging bracket, follow the manual of it.

■ Do not block the rear air vents

- Blocked ventilation by newspapers, table cloths, curtains, etc. may cause overheating, fire or electrical shock.

■ Do not expose your ears to excessive volume from the headphones

- Irreversible damage can be caused.

■ The TV is heavy. Handle the TV by 2 or more people. Support as shown to avoid injury by the TV tipping or falling.

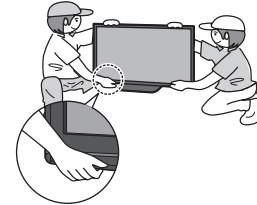

Notes

Do not display a still picture for a long time

This causes the image to remain on the plasma screen ("image retention").

This is not considered a malfunction and is not covered by the warranty.

Typical still images

- Channel number and other logos
- Image displayed in 4:3 mode
- Video game
- Computer image



To prevent image retention, contrast is lowered automatically after a few minutes if no signals are sent or no operations are performed. (p. 61)

■ Auto power standby function

- If no signal is received and no operation is performed in Analogue TV mode for 30 minutes, the TV will automatically go to standby mode.

■ Keep the TV away from these types of equipment

- Electronic equipment
In particular, do not place video equipment near the TV (electromagnetic interference may distort images / sound).
- Equipment with an infrared sensor
This TV also emits infrared rays (this may affect operation of other equipment).

Maintenance

First, remove the mains plug from the socket outlet.

Display panel

Regular care: Gently wipe the surface clean of dirt by using a soft cloth.

Major contamination: Wipe the surface clean using a soft cloth dampened with clean water or diluted neutral detergent (1 part detergent to 100 parts water). Then, using a soft dry cloth, evenly wipe the surface clean until it is dry.

Caution

- The surface of the display panel has been specially treated and may be easily damaged. Do not tap or scratch the surface with your fingernail or other hard object.
- Take care not to subject the surface to insect repellent, solvent, thinner, or other volatile substances (this may degrade surface quality).

Cabinet, Pedestal

Regular care: Wipe the surface clean using a soft dry cloth.

Major contamination: Dampen a soft cloth with clean water or water containing a small amount of neutral detergent. Then, wring the cloth and wipe the surface clean with it. Finally, wipe the surface clean with a dry cloth.

Caution

- Take care not to subject the TV's surfaces to detergent (a liquid inside the TV could lead to product failure).
- Take care not to subject surfaces to insect repellent, solvent, thinner, or other volatile substances (this may deteriorate the surface by peeling the paint).
- Do not allow the cabinet and pedestal to make contact with a rubber or PVC substance for a long time.

Mains plug

Wipe the mains plug with a dry cloth at regular intervals. (Moisture and dust may lead to fire or electrical shock.)

Accessories / Options

Standard accessories

- Remote Control
- N2QAYB000354



- Batteries for the Remote Control (2)
- R6 (UM3)



- Clamper
- ➔ p. 8

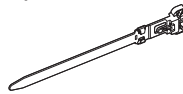

- Mains Lead
- ➔ p. 11



- Operating Instructions

- Cleaning cloth



- Pedestal
- ➔ p. 7

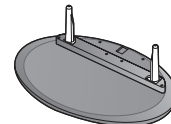

- Pan European Guarantee Card

- This product contains possibly dangerous parts (such as plastic bags), that can be breathed in or swallowed by young children accidentally. Keep these parts out of reach of young children.

Optional accessories

- Wall-hanging bracket
- TY-WK4P1RW

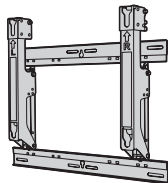

Caution

- In order to maintain the unit's performance and safety, be absolutely sure to ask your dealer or a licenced contractor to secure the wall-hanging brackets.
- Carefully read the instructions accompanying the pedestal, and be absolutely sure to take steps to prevent the TV from tipping over.
- Handle the TV carefully during installation since subjecting it to impact or other forces may cause product damage.
- Take care when fixing wall brackets to the wall. Always ensure that there are no electrical cables or pipes in the wall before hanging bracket.
- To prevent fall and injury, remove the TV from its fixed wall position when it is no longer in use.

Installing / removing remote's batteries

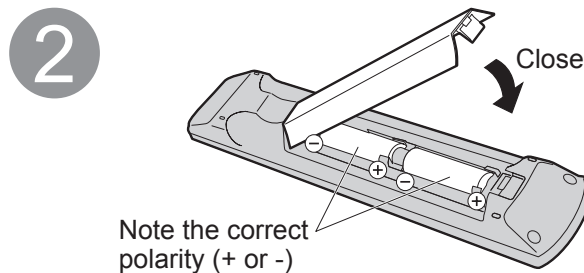
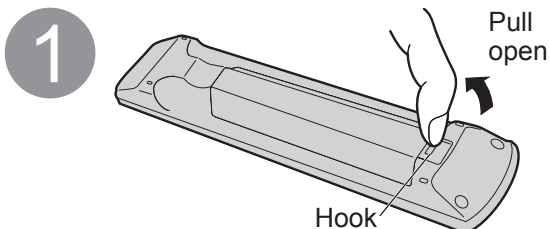

Caution

- Incorrect installation may cause battery leakage and corrosion, resulting in damage to the remote control.
 - Do not mix old and new batteries.
 - Do not mix different battery types (such as alkaline and manganese batteries).
 - Do not use rechargeable (Ni-Cd) batteries.
 - Do not burn or breakup batteries.
- Batteries must not be exposed to excessive heat such as sunshine, fire or the like.

Attaching the pedestal

Warning

Do not disassemble or modify the pedestal.

- Otherwise the TV may fall over and become damaged, and personal injury may result.

Caution

Do not use any other TV and displays.

- Otherwise the TV may fall over and become damaged, and personal injury may result.

Do not use the pedestal if it becomes warped or physically damaged.

- If you use the pedestal while it is physically damaged, personal injury may result. Contact your nearest Panasonic dealer immediately.

During set-up, make sure that all screws are securely tightened.

- If insufficient care is taken to ensure screws are properly tightened during assembly, the pedestal will not be strong enough to support the TV, and it might fall over and become damaged, and personal injury may result.

Ensure that the TV does not fall over.

- If the TV is knocked or children climb onto the pedestal with the TV installed, the TV may fall over and personal injury may result.

Two or more people are required to install and remove the TV.

- If two or more people are not present, the TV may be dropped, and personal injury may result.

(A) Assembly screw (4)
(silver)

- XYN5+F18FN

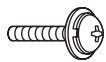

M5 × 18

(B) Assembly screw (4)
(black)

- THEL062N (TX-PF42G10)
- THEL060N (TX-PF46G10) (TX-PF50G10)

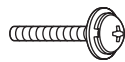

M5 × 25

(C) Pole (2)

- R: TBLA3689 (TX-PF42G10) TBLA3679 (TX-PF46G10) (TX-PF50G10)
- L: TBLA3690 (TX-PF42G10) TBLA3680 (TX-PF46G10) (TX-PF50G10)

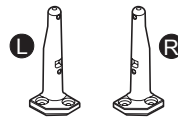

(D) Base

- TBLX0099 (TX-PF42G10)
- TBLX0095 (TX-PF46G10) (TX-PF50G10)

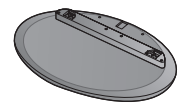

■ Assembling the pedestal

Use the four assembly screws (A) to fasten the left and right poles to the base securely.

- Make sure that the screws are securely tightened.
- Forcing the assembly screws the wrong way will strip the threads.
- “L” or “R” mark is stamped on the bottom of the pole.

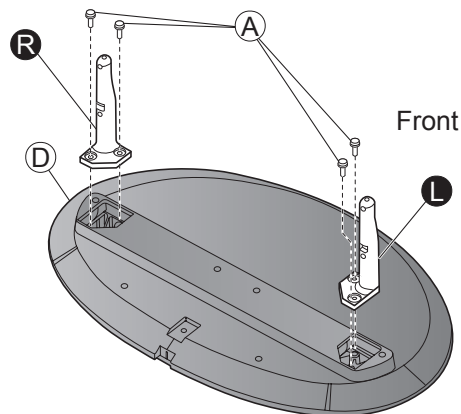

■ Securing the TV

Use the assembly screws (B) to fasten securely.

- Make sure that the screws are securely tightened.
- Carry out the work on a horizontal and level surface.

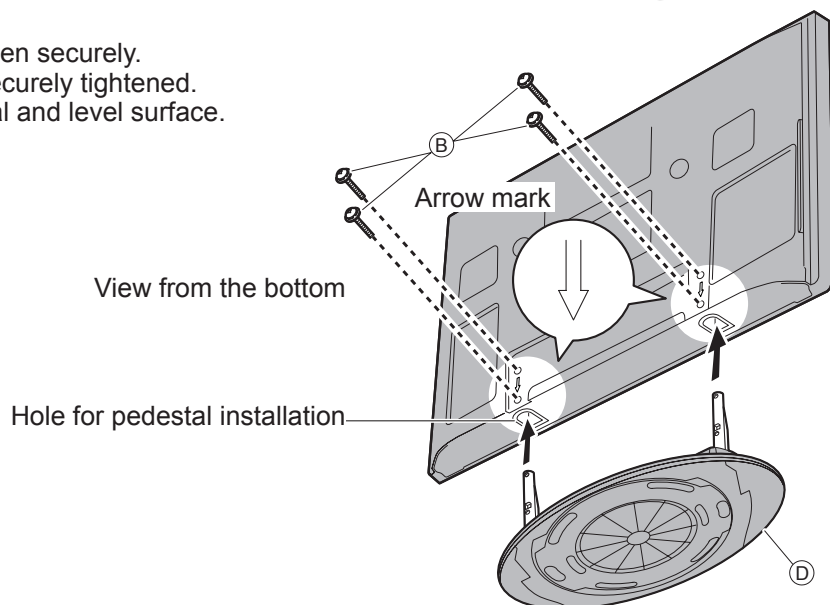

Accessories / Options

Adjust the panel to your desired angle

- Ensure that the pedestal does not hang over the edge of the base even if the TV swivels to the full rotation range.
- Do not place any objects or hands within the full rotation range.

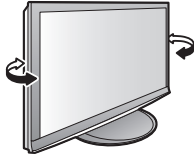

- TX-PF42G10
a: 520 mm / b: 354 mm / c: 15°
- TX-PF46G10, TX-PF50G10
a: 528 mm / b: 407 mm / c: 10°

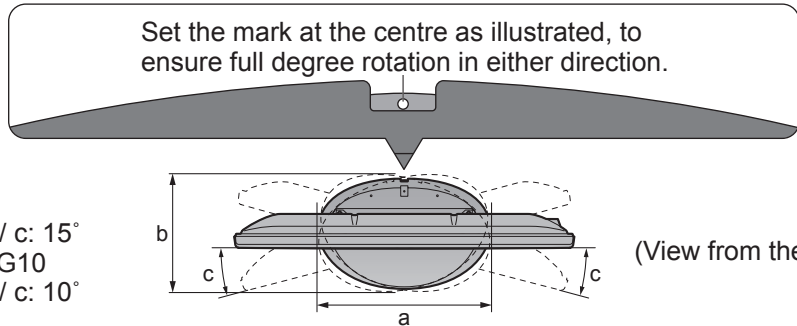

(View from the top)

Using the clammer

Rear of the TV

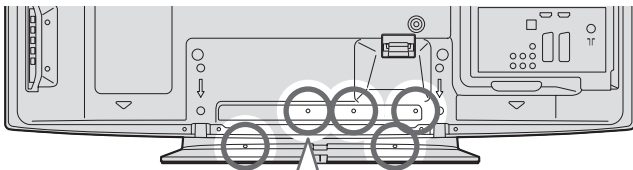

- Do not bundle the RF cable and mains lead together (could cause distorted image).
- Fix cables with clammers as necessary.
- When using the optional accessory, follow the option's assembly manual to fix cables.

■ Attach the clammer

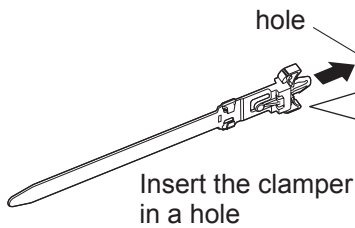

To remove from the TV:

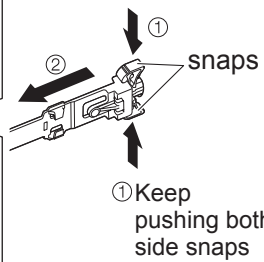

■ Bundle the cables

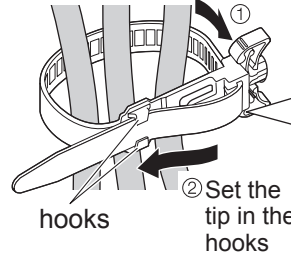

To loosen:

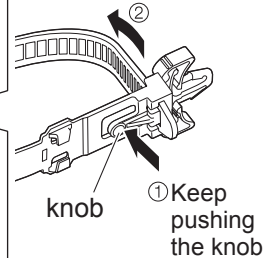

Identifying Controls

TV

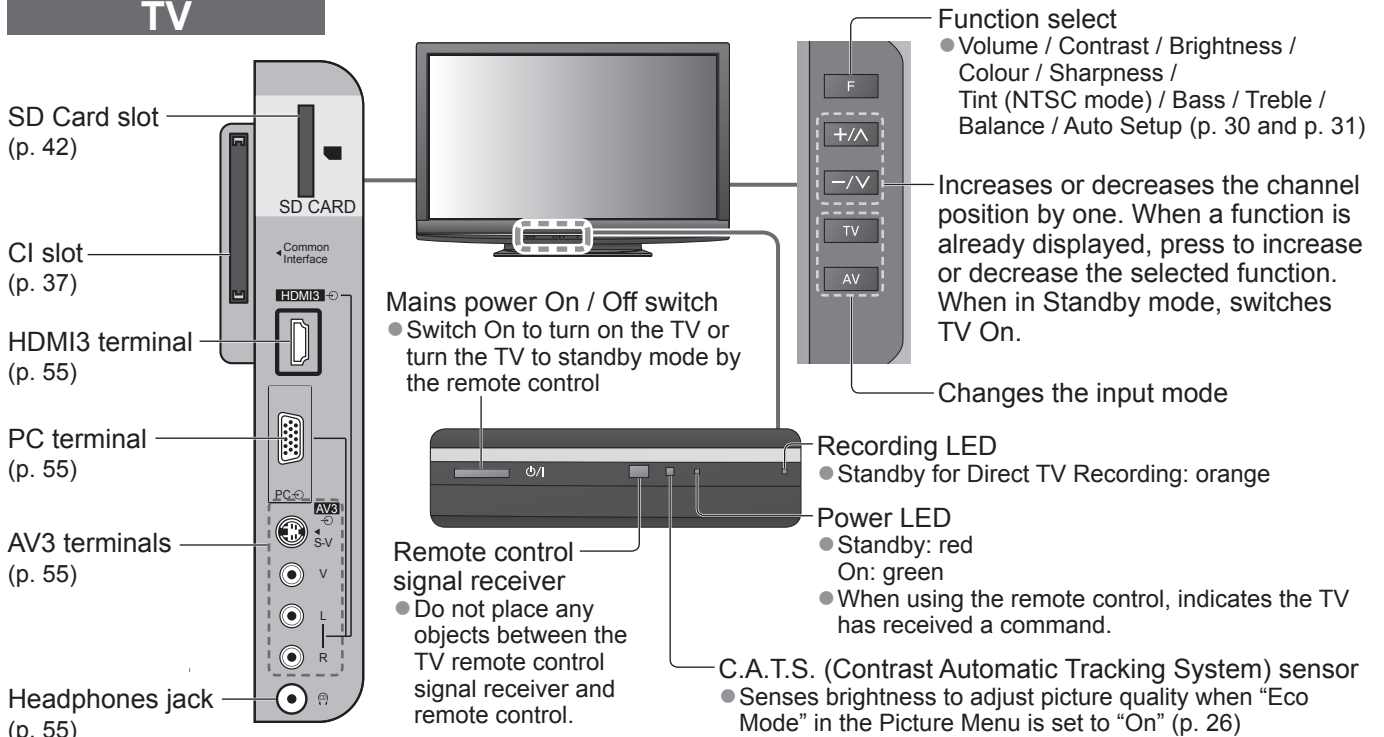

Identifying Controls

Remote Control

VIERA IMAGE VIEWER (p. 42)

- Switches to SD Card viewing mode

Standby On / Off switch

- Switches TV On or Off standby

Aspect (p. 16)

- Changes aspect ratio from Aspect Selection list
- Also possible by pressing this button repeatedly until you reach the desired aspect

Main Menu (p. 24)

- Press to access Picture, Sound and Setup Menus

Channel / Programme Information (p. 15)

- Displays channel and programme information

VIERA Link Menu (p. 50)

- Accesses VIERA Link Menu

OK

- Confirms selections and choices
- Press after selecting channel positions to quickly change channel

Option Menu (p. 17)

- Easy setting for viewing and sound options

Coloured buttons

- Used for the selection, navigation and operation of various functions

Teletext (p. 20)

- Switches to teletext mode

Subtitles (p. 16)

- Displays subtitles

Numeric buttons

- Changes channel and teletext pages
- Sets characters
- When in Standby mode, switches TV On

Sound Mute

- Switches sound mute On or Off

Volume Up / Down

Input mode selection

- TV - switches DVB-C / DVB-T / Analogue mode (p. 14)
- AV - switches to AV input mode from Input Selection list (p. 22)

Direct TV Recording (p. 48 and p. 50)

- Records programme immediately in DVD Recorder / VCR with Q-Link or VIERA Link connection

Normalise (p. 24)

- Resets picture and sound settings to their default levels

Exit

- Returns to the normal viewing screen

VIERA TOOLS (p. 41)

- Displays some special feature icons and accesses easily

Guide (p. 18)

- Displays TV Guide

Cursor buttons

- Makes selections and adjustments

Return

- Returns to the previous menu / page

Hold

- Freeze / unfreeze picture (p. 15)
- Holds the current teletext page (teletext mode) (p. 20)

Index (p. 21)

- Returns to the teletext index page (teletext mode)

Surround (p. 27)

- Switches Surround sound

Channel Up / Down

- Selects channel in sequence

Connected equipment operations (p. 23 and p. 52)



Basic Connection

External equipment and cables shown are not supplied with this TV.

Please ensure that the unit is disconnected from the mains socket before attaching or disconnecting any leads. When disconnecting the mains lead, be absolutely sure to disconnect the mains plug at the socket outlet first.

Example 1 Connecting aerial

TV only

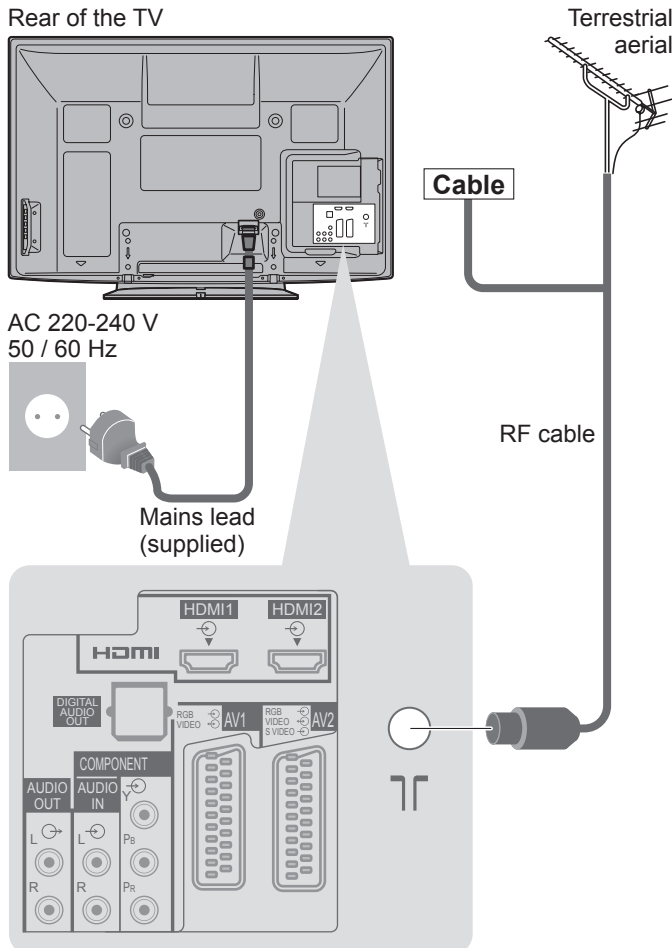

Example 2 Connecting DVD Recorder / VCR

TV, DVD Recorder or VCR

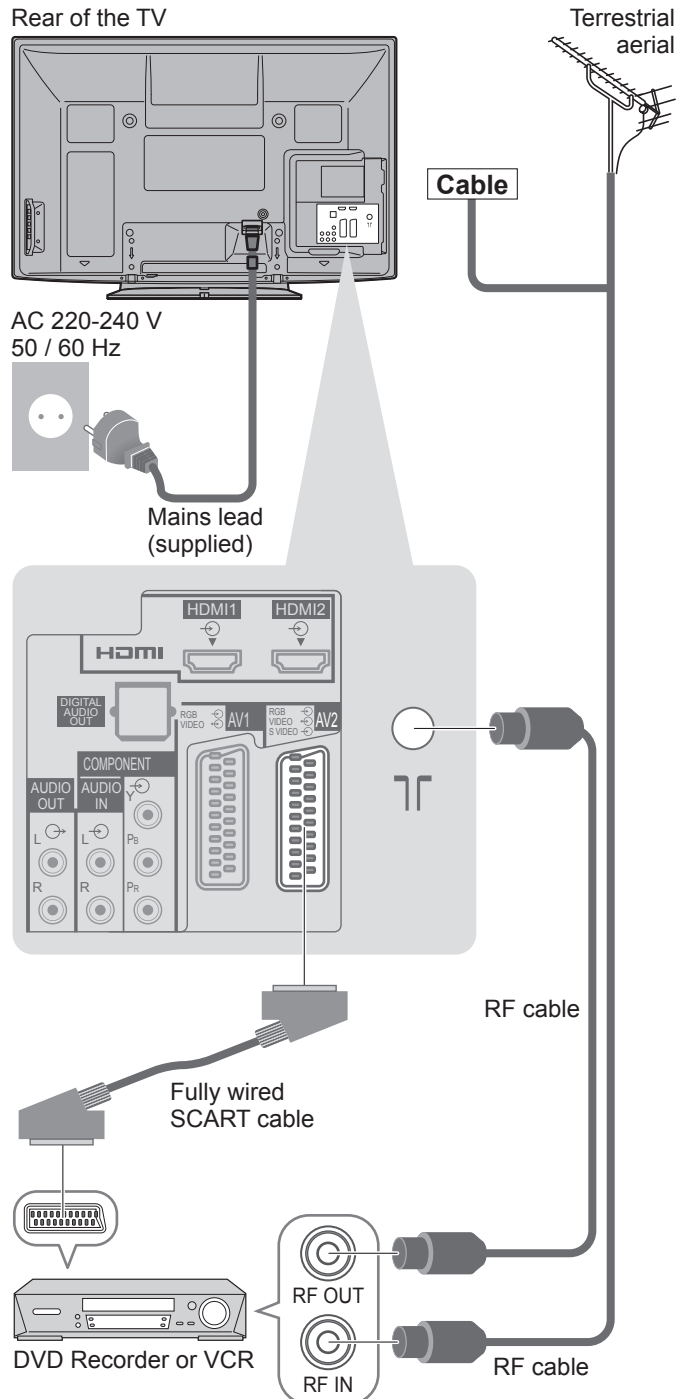

Note

- Connect to the TV's AV1 / AV2 for a DVD Recorder / VCR supporting Q-Link (p. 48).
- For HDMI-compatible equipment, possible to connect to HDMI terminals (HDMI1 / HDMI2 / HDMI3) by using HDMI cable (p. 54).
- Q-Link connection → p. 46
- VIERA Link connection → p. 46 and p. 47
- Read the manual of the equipment too.

Example 3 Connecting DVD Recorder / VCR and Set top box

TV, DVD Recorder / VCR and Set top box

Rear of the TV

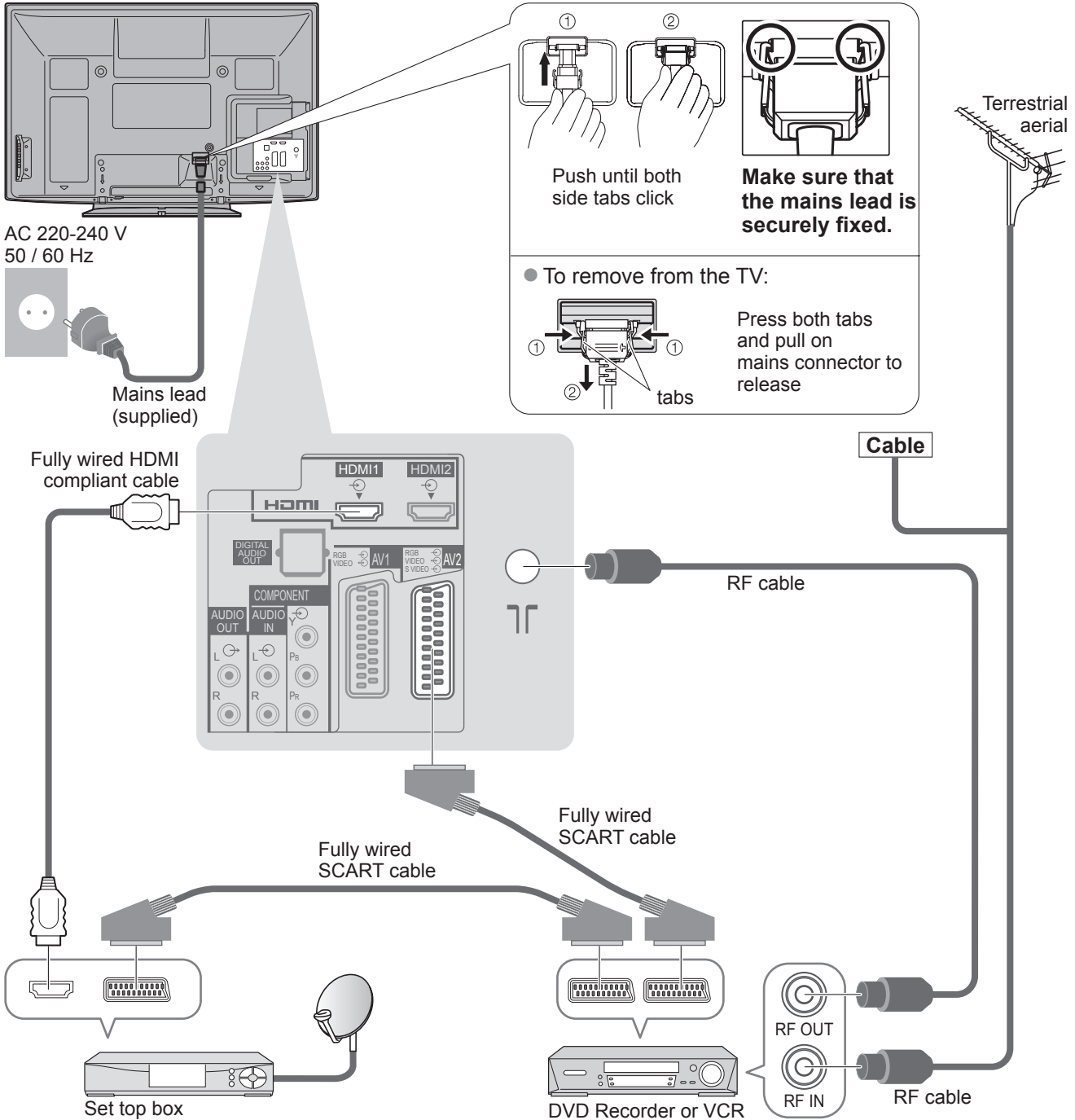

Auto Setup

Search and store TV channels automatically.

- These steps are not necessary if the setup has been completed by your local dealer.
- Please complete connections (p. 10 and p. 11) and settings (if necessary) of the connected equipment before starting Auto Setup. For details of settings for the connected equipment, read the manual of the equipment.

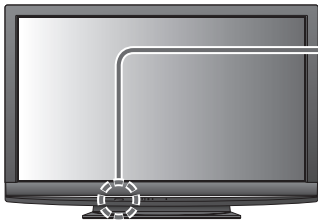

1 Plug the TV into mains socket and switch On (Takes a few seconds to be displayed)



2 Select the language

Menüsprache			
Deutsch	Dansk	Polski	Srpski
English	Svenska	čeština	Hrvatski
Français	Norsk	Magyar	Slovenščina
Italiano	Suomi	Slovenčina	Latviešu
Español	Türkçe	Български	eesti keel
Português	Ελληνικά	Română	Lietuvių
Nederlands			

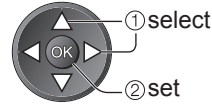

3 Select your country

Country		
Germany	Denmark	Poland
Austria	Sweden	Czech
France	Norway	Hungary
Italy	Finland	Slovakia
Spain	Luxembourg	Slovenia
Portugal	Belgium	Estonia
Switzerland	Netherlands	Lithuania
Malta	Turkey	E. Eu
Andorra	Greece	

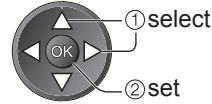

Auto Setup starts

- Auto Setup will start to search for TV channels and store them. The sorted channel order depends upon the TV signal, the broadcasting system and reception conditions.

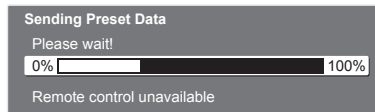

- If Q-Link, VIERA Link or similar technology (p. 48) compatible recorder is connected, channel, language, country / region settings are automatically downloaded to the recorder.
- If downloading has failed, you can download later by the menu item. ➔ "Download" (p. 28)

4 Select "Home"

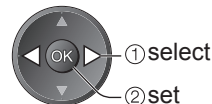
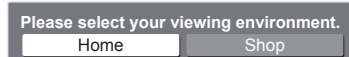

Auto Setup is now complete and your TV is ready for viewing.



- To check channel list at-a-glance ➔ "Using TV Guide" (p. 18 and p. 19)
- To edit channels ➔ "Tuning and Editing Channels" (p. 32 - 35)

Using the On Screen Displays

Many features available on this TV can be accessed via the On Screen Display menu.

How to use remote control



Move the cursor / select the menu item



Move the cursor / adjust levels / select from a range of options



Access the menu / store settings after adjustments have been made or options have been set



Return to the previous menu



Open the main menu



Exit the menu system and return to the normal viewing screen

ON SCREEN HELP Instructions box - Operation guide

(example: Sound Menu)

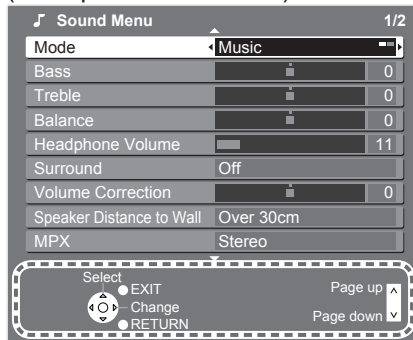

Operation guide will help you.

Note

- If tuning has failed → "Auto Setup" (p. 30 and p. 31)
- To initialize all settings → "Shipping Condition" (p. 38)
- If you turned the TV Off during Standby mode last time, the TV will be in Standby mode when you turn the TV On with Mains power On / Off switch.

Auto Setup varies depending on the country you select

- Favourite Network Selection (if you select "Sweden")

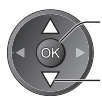
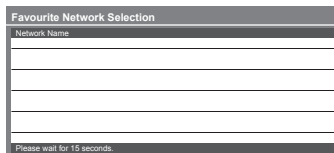

② set
① select network

- Region Selection (if you select "Finland")

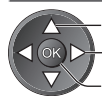

① select region
② set

- Search Mode (if you select "Sweden" or "Finland")



① select mode
② set

- Analogue Auto Setup

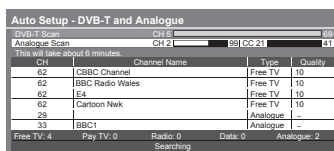

- DVB-T Auto Setup (if you select a country except "Portugal", "Poland", "Hungary" and "E.Eu")

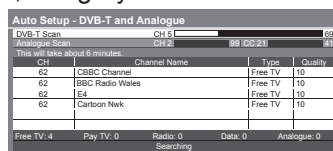

- DVB-C Auto Setup (if you select "Sweden" or "Finland")

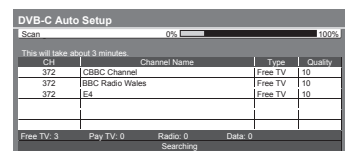

If you select "Shop" by mistake

Return to viewing environment selection by pressing the RETURN button.



Select "Home"



Auto Setup is complete

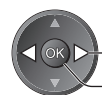

① select
② set

- If you set to "Off" or "On" in this menu the TV will be in "Shop" viewing environment. To return to "Home" viewing environment initialise all settings by accessing Shipping Condition. → "Shipping Condition" (p. 38)

Watching TV



1 Turn power on (Press for about 1 second)

- Mains power On / Off switch should be On. (p. 8)

2 Select the mode

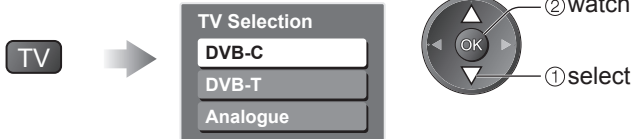

- The selectable modes vary depending on the country you select (p. 12).
- If "TV Selection" menu is not displayed, press the TV button to switch the mode.

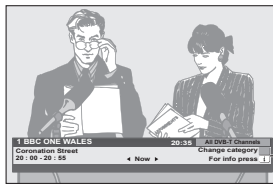

Information banner appears whenever you select a channel

- For details → p. 15

- Also possible to select the mode pressing the TV button repeatedly on the remote control or side panel of the TV. (p. 8)

3 Select a channel

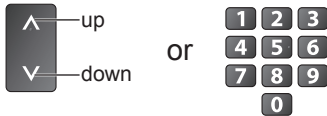

- To select a more than two-digit channel position number, e.g. 399
→ **3** → **9** → **9**

- To select from the Channel List

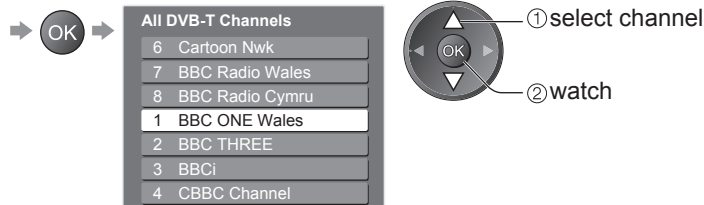

Note

- To watch pay-TV
→ "Using Common Interface" (p. 37)

■ Select a channel using Information banner (p. 15)

Possible to confirm the channel name and programme before changing channels. Display Information banner if it is not displayed

While the banner is displayed, select the channel



- Possible to set display timeout in "Banner Display Timeout" (p. 29).

■ Select a channel using TV Guide (p. 18)

Possible to confirm the TV Guide (EPG or Channel List) before changing channels.

- This function may not be available in some countries.

Display TV Guide

Select the channel

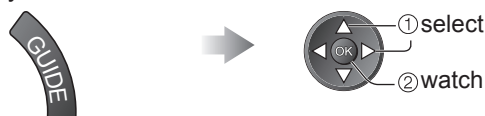

Other useful functions

Hold

Freeze / unfreeze picture



Display Information banner

Display Information banner

- Also appears when changing a channel

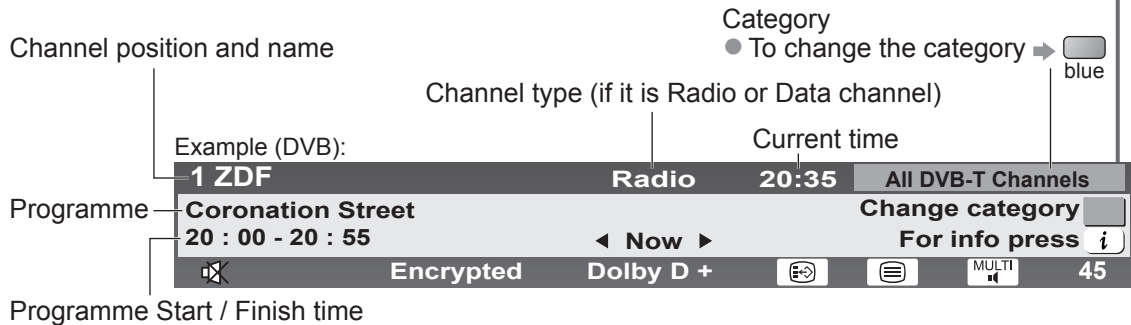

Example (Analogue):



- To confirm another tuned channel name →
- To watch the channel listed in the banner →
- Information on the next programme (DVB) →
- To hide →
- Extra information (DVB) → (press again to hide the banner)
- To set display timeout → "Banner Display Timeout" (p. 29)

Features available / Message meanings



Sound mute On

Bad signal

Poor TV signal quality

Encrypted

Scrambled programme

Dolby D +, Dolby D

Dolby Digital Plus or Dolby Digital audio track



Subtitle service available



Teletext service available



Multiple audio available



Multiple video available

Stereo, Mono

Audio mode

1 - 90

Off Timer remaining time

- For settings → p. 17

Watching TV

Other useful functions

Display subtitles

Display / hide subtitles (if available)

- To change the language for DVB (if available)
 - ➔ “Preferred Subtitles” (p. 29)



Note

- If you press the STTL button in Analogue mode, it switches to teletext service and calls up a favourite page (p. 21). Press the EXIT button to return to TV mode.

Aspect

Change the aspect ratio (image size)



Enjoy viewing the image at its optimum size and aspect.

Normally programmes have the Aspect Control Signal (Widescreen signal, etc.), and the TV will choose the aspect ratio automatically according to the Aspect Control Signal (p. 56).

■ If you would like to change the aspect ratio manually

Display Aspect Selection list

While the list is displayed, select the mode

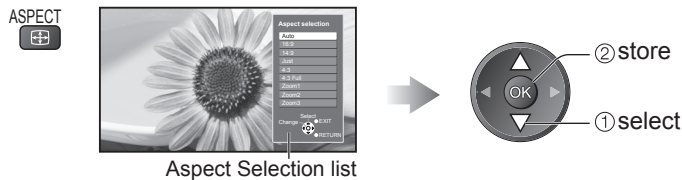

Aspect Selection list

- To change the mode using the ASPECT button only
 - ➔ ASPECT (Press repeatedly until you reach the desired mode)

Auto



The best ratio is chosen and the image expanded to fill the screen.
For details ➔ p. 56

16:9



Directly displays the image at 16:9 without distortion (anamorphic).

4:3 Full



Displays a 4:3 image enlarged horizontally to fit the screen.
● HD signal only

14:9



Displays the image at the standard 14:9 without distortion.

Zoom1



Displays a 16:9 letterbox or 4:3 image without distortion.

Just



Displays a 4:3 image full-screen. Stretching is only noticeable at the left and right edges.

Zoom2

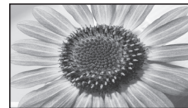

Displays a 16:9 letterbox (anamorphic) image full-screen without distortion.

4:3



Displays the image at the standard 4:3 without distortion.

Zoom3



Displays a 2.35:1 letterbox (anamorphic) image full-screen without distortion. At 16:9, displays the image at its maximum (with slight enlargement).

Note

- Only “16:9” and “4:3 Full” are available in HD channels.
- Only “16:9” and “4:3” are available in PC input mode.
- Not available when the subtitle function is active.
- Not available in teletext service.
- Aspect mode can be memorized separately for SD (Standard definition) and HD (High definition) signals.

Other useful functions

Display the selectable settings for the current programme

Check or change the current programme status instantly



- To change

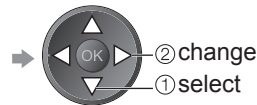

Multi Video (DVB mode)

Allows you to select the image (if available)

Teletext Character Set

Sets the teletext language

➔ Setup Menu (p. 29)

Multi Audio (DVB mode)

Allows you to select between alternative language for sound tracks (if available)

Teletext Language (DVB mode)

Allows you to select between alternative language for teletext (if available)

Sub Channel (DVB mode)

Allows you to select the multifeed programme - sub channel (if available)

MPX (Analogue mode)

➔ Sound Menu (p. 27)

Subtitle Language (DVB mode)

Allows you to select the language in which subtitles should appear (if available)

Volume Correction

Adjusts volume of individual channel or input mode

Note

- Also possible to change the settings in Menu list (p. 26 - 29).

Off Timer

Turn the TV off automatically after a fixed period

Display the menu



Select "Setup"

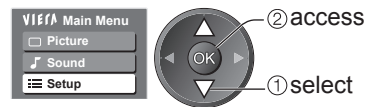

Select "Off Timer" and set the time



- To cancel ➔ Set to "Off" or turn the TV off.
- To display the remaining time ➔ Information banner (p. 15)

Note

- When the remaining time is within 3 minutes, the remaining time will flash on the screen.

Using TV Guide

TV Guide—Electronic Programme Guide (EPG) provides an on-screen listing of the programmes currently broadcast and the forthcoming broadcasts over the next seven days (depending on the broadcasters).

- This function varies depending on the country you select (p. 12).
- DVB-T and Analogue channels are displayed on the same TV Guide screen. Analogue channels will be listed after DVB-T channels but there will be no programme listings. “D” means DVB-T channel and “A” means Analogue channel.
- When this TV is turned on for the first time, or the TV is switched off for more than a week, it may take some time before the TV Guide is completely shown.



1 Select the mode

→ p. 14



2 View TV Guide



- To change the layout (Landscape / Portrait) view “Landscape” to see many channels view “Portrait” to see one channel at a time

TV Guide time

Example: Current date and time

TV Guide date	Programme
Wed 24th	All Types All Channels
1 BBC ONE	20:00 - 20:30 DIY SOS: We open in the Battersbys
D 1 BBC ONE	Emmerdal, Coronation Street
D 7 BBC THREE	Hot Wars, The Bill
D 14 E4	10 O' clock News BBC, Pepsi Char.
D 70 BBC FOUR	Panorama, Spring watch
D 72 BBC 2W	I'm A Celebrity, Pop Idol
D 105 BBC1	Rugby, 15 To 1
D 719 BBC Radi	The Bill

Advertisement Landscape (Displays by channel) Channel position and name

Example:

TV Guide: Portrait
Wed 24th
19:30-20:00 Eastender
20:00-20:30 DIY SOS
20:30-21:00 The Bill
21:00-22:00 Red Cap
22:30-23:00 Live junction
23:00-23:30 POP 100
23:00-00:00 Rugby

Portrait (Displays by time)

To the previous day (DVB mode)



To the next day (DVB mode)



To watch the programme

Select the programme or channel

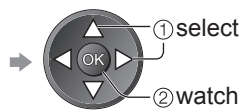

To view details of the programme (DVB mode)

Select the programme



To return to TV



To view a channel list of the selected type (DVB mode)



Prog.Type
All Types
Movie
News
...
...

(Type list)

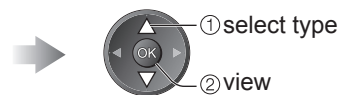

To view a channel list of the selected category



Category
All Channels
All DVB-T Channels
All Analogue Channels
Free Channels
Pay Channels
TV
Radio
Favourites1
Favourites2
Favourites3
Favourites4

(Category list)

Only Analogue channels are listed

To list favourite channels → p. 33

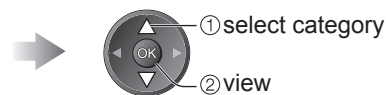

■ **Depending on the country you select, this TV supports the GUIDE Plus+ system in DVB-T or Analogue mode**

The postcode entry or update is required. Follow the message's instructions.

- Also possible to setup manually from the Setup Menu
 - ➔ "Update" / "Postcode" in "GUIDE Plus+ Settings" (p. 29)
- Enter your postcode when using this function for the first time. If you enter an incorrect postcode for your area, or no postcodes are entered, advertisement may not be displayed correctly.

Display advertisement information

OPTION



- To change advertisements ➔



- To return to TV Guide ➔



- To display the latest advertisement ➔ "Update" in "GUIDE Plus+ Settings" (p. 29)

Note

- To update the information continuously, the TV must be left in Standby mode at night.

■ **Depending on the country you select, TV Guide may not be supported**

In this case, Channel List will appear.

All Analogue Channels	
6	Cartoon Nwk
7	BBC Radio Wales
8	BBC Radio Cymru
1	BBC ONE Wales
2	BBC THREE
3	BBCi
4	CBBC Channel

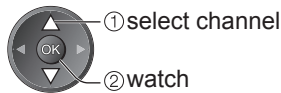

Viewing Teletext

Teletext services are the text information provided by the broadcasters. The features may vary depending on the broadcasters.



What is FLOF (FASTTEXT) mode?

In FLOF mode, four differently coloured subjects are situated at the bottom of the screen. To access more information about one of these subjects, press the appropriately coloured button. This facility enables fast access to information on the subjects shown.

What is TOP mode? (in case of TOP text broadcasting)

TOP is a particular improvement of the standard teletext service that results in an easier search and effective guide.

- Fast overview of the teletext information available
- Easy to use step-by-step selection of the topical subject
- Page status information at the bottom of the screen

Available page up / down →  
red green

To select among subject blocks → 
blue

To select next subject within the subject block
(After the last subject, it moves to the next subject block.) → 
yellow

What is List mode?

In List mode, four differently coloured page numbers are situated at the bottom of the screen. Each of these numbers can be altered and stored in the TV's memory. ("Store frequently viewed pages", p. 21)

■ To change mode → "Teletext" in the Setup Menu (p. 29)



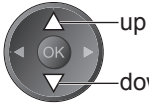

1 Switch to Teletext
 ● Displays the index page (content varies depending on the broadcasters)

2 Select the page
 or  up/down

■ To adjust contrast →  (Press three times) →

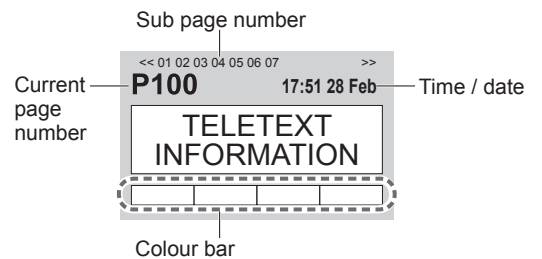
■ To return to TV → 



or    
 (Corresponds to the colour bar)

As the blue bar is displayed



Reveal hidden data

Reveal hidden words e.g. quiz page answers

 →  ● To rehide → 

FULL / TOP / BOTTOM

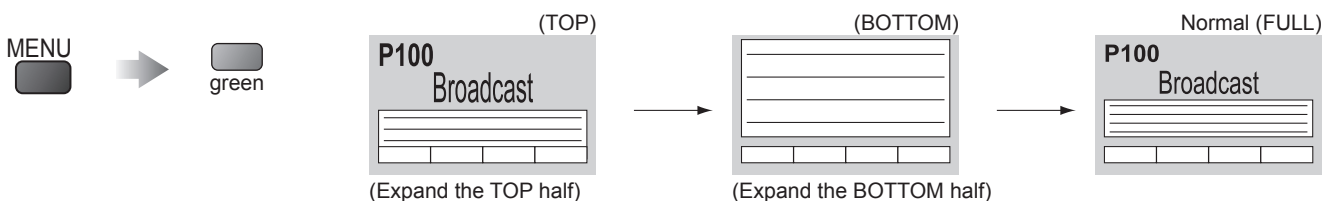

HOLD

Stop automatic updating

(If you wish to hold the current page without updating)

 ● To resume → 

INDEX

Return to the main index page



Call up a favourite page

View a favourite page stored



- Call up the page stored on the blue button (List mode).
- Factory setting is "P103".

View in multi window

Watch TV and Teletext in two windows at once



(press twice)



Select Picture and text On or Off



- Operations can be made only in Teletext screen.

Store frequently viewed pages

Store frequently viewed pages in the colour bar

(List mode only)

As page is displayed



Corresponding coloured button



press and hold

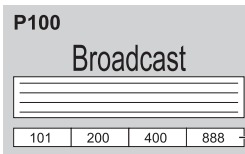

The number changes to white.

■ To change stored pages



Coloured button you want to change



Enter new page number



press and hold

View sub page

View sub page (Only when teletext is more than one page)

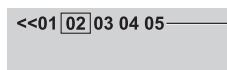

Appears at top of the screen

■ To view specific sub page



blue



Enter the 4-digit number
example: P6

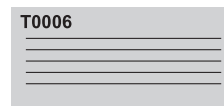

- Sub pages:
The number of sub pages varies depending on the broadcasters (up to 79 pages).
It may take some time for searching, during which time you can watch TV.

Watch TV while waiting for update

View the TV picture while searching for a teletext page

Teletext automatically updates itself when new information becomes available.

Changes to TV screen temporarily

View the updated page



yellow



Appears when updating is completed



(You cannot change the channel.)

- The news page provides a function that indicates arrival of latest news ("News Flash").

Watching External inputs

Connect the external equipment (VCRs, DVD equipment, etc.) and you can watch the input.

● To connect the equipment → p. 10, 11 and 54

The Remote Control is capable of operating some functions of selected external equipment.

1 Turn the TV on

- **When connecting with SCART as example 2 or 3** (p. 10 and p. 11)
 - Receives input signals automatically when playback starts
 - Input signals are automatically identified by the SCART (pin 8) terminal.
 - This function is also available for HDMI connections (p. 54).
- **If input mode is not switched automatically**
 - Perform ② and ③
 - Check the setup of the equipment.

2 Display the Input select menu

AV

3 Select the input mode connected to the equipment

Input Selection
AV1
AV2/S
AV3/S
COMPONENT
PC
HDMI1
HDMI2
HDMI3
TV

① select
② watch

- You can also select the input using the AV button on the remote control or the side panel of the TV. Press the button repeatedly until the desired input is selected.
- In order to switch between AV2/AV3 and AV2S/AV3S, move the indicator by pressing left and right cursor button.
- You can label or skip each input mode → “Input Labels” (p. 40) Skipped inputs will not be displayed when the AV button is pressed.

4 View

Displays the selected mode

AV2

■ **To return to TV**









→ TV

Note

- If the external equipment has an aspect adjustment function, set to “16:9”.
- For details, see the manual of the equipment or ask your local dealer.



Operating the equipment with the TV remote control



The equipment connected to the TV can be directly operated with the below buttons of this TV remote control.

	Selection Switch for operating the connected equipment Select "DVD/VCR" to operate Panasonic DVD Recorder, DVD Player, Player theatre, Blu-ray Disc theatre or VCR → "How to change the code for the type of the equipment" (see below) Select "TV" to operate the connected equipment in VIERA Link → "VIERA Link Control" (p. 52)
	Standby Set to Standby mode / Turn on
	Play Playback videocassette / DVD
	Stop Stop the operations
	Rewind / Skip / Search VCR: Rewind, view the picture rapidly in reverse DVD: Skip to the previous track or title Press and hold to search backward
	Fast-forward / Skip / Search VCR: Fast-forward, view the picture rapidly forward DVD: Skip to the next track or title Press and hold to search forward
	Pause Pause / Resume DVD: Press and hold to play at slow speed
	Channel Up / Down Select channel
	Record Start recording

■ How to change the code for the type of the equipment

Each type of the Panasonic equipment has its own remote control code. Please change the code according to the equipment you want to operate.

- Set the position to "DVD/VCR" 
- Press and hold  during the following operations

Enter the appropriate code,  → Press 
 see table below

Type of the equipment	Code
DVD Recorder, DVD Player	70 (default)
Player theatre, Blu-ray Disc theatre	71
VCR	72

Note

- Confirm if the remote control works correctly after changing the code.
- The codes may be reset to default values if batteries are replaced.
- Some operations may not be possible on some equipment models.

How to Use Menu Functions

Various menus allow you to make settings for the picture, sound, and other functions.



1 Display the menu
 MENU
 • Displays the functions that can be set (varies according to the input signal)

2 Select the menu

 (example: Picture Menu)
 ② access
 ① select

3 Select the item

 (example: Picture Menu)
 select

4 Adjust or select

 (example: Picture Menu)
 ① change
 ② store or access (Required by some functions)

■ **To return to TV at any time**
 EXIT

■ **To return to the previous screen**
 BACK/RETURN

■ **To change menu pages**
 up
 down

■ **Choose from among alternatives**

Number and positions of alternatives

 Changed

■ **Adjust using the slide bar**

Moved

■ **Go to the next screen**

Displays the next screen

■ **Enter characters by free input menu**

You can enter names or numbers freely for some items.

Set characters one by one
 ① select
 ② set

Store
 BACK/RETURN

- You can set characters by using numeric buttons.
 ➔ "Characters table for numeric buttons" (p. 58)

Overview

● How to operate → p. 24

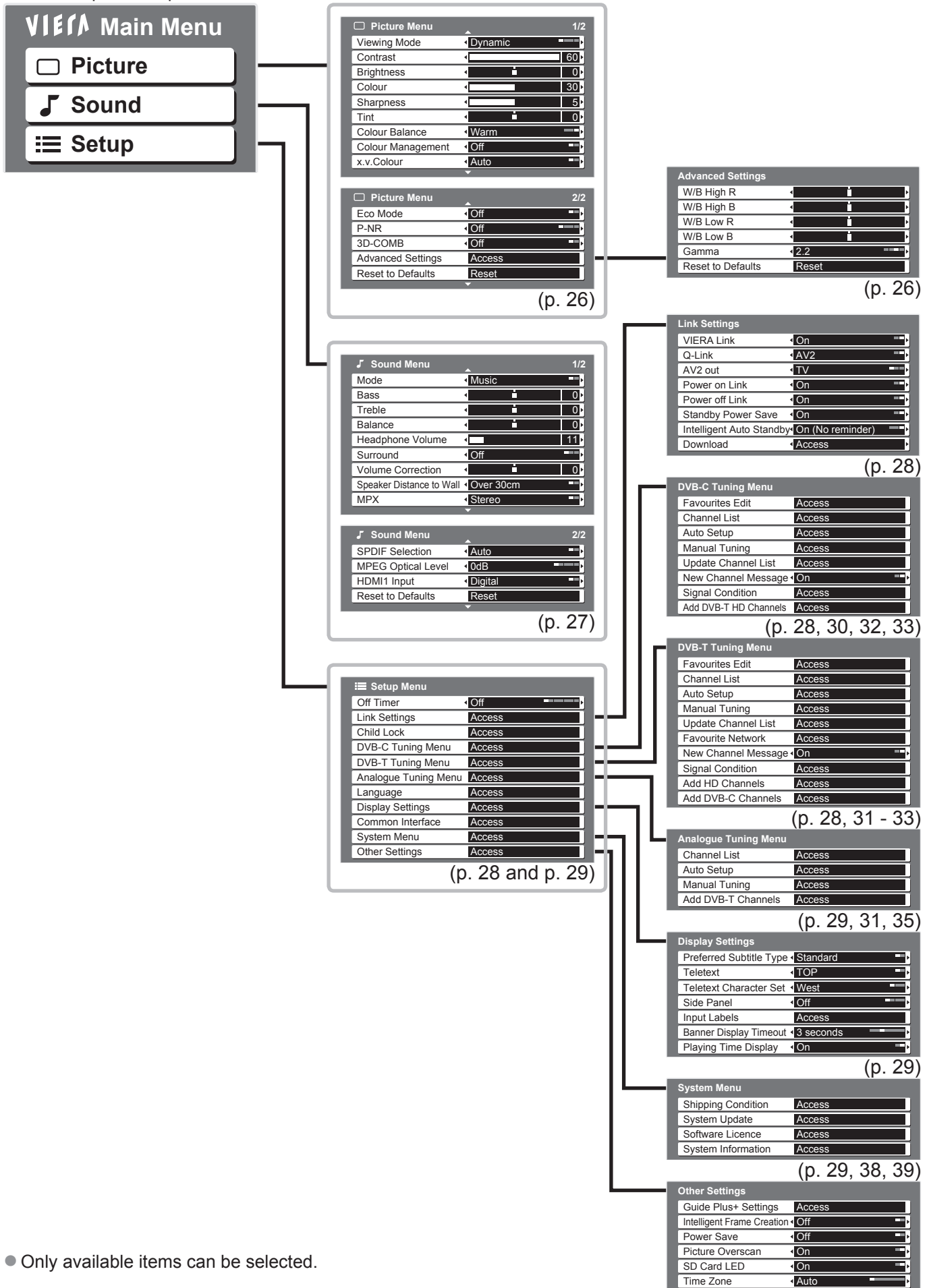

● Only available items can be selected.

How to Use Menu Functions

■ Menu list

Menu	Item	Adjustments / Configurations (alternatives)
Picture	Viewing Mode	Basic picture mode (Dynamic / Normal / Cinema / Game) <ul style="list-style-type: none"> ● Set for each input signal Dynamic : Provides enhanced picture contrast and sharpness when viewing in a bright room Normal : Recommended for viewing under normal ambient room lighting conditions Cinema : For watching movies in a darkened room producing a cinema-like picture Game : Fast response signal specifically to provide suitable images for playing games <ul style="list-style-type: none"> ● Not valid on TV mode ● A continuous record of time spent using Game mode can be displayed in the top right of the screen. <ul style="list-style-type: none"> ➔ "Playing Time Display" (p. 29)
	Contrast, Brightness, Colour, Sharpness	Increases or decreases the levels of these options according to your personal preference
	Tint	With an NTSC signal source connected to the TV, the picture hue can be adjusted to suit your taste <ul style="list-style-type: none"> ● For NTSC signal reception only
	Colour Balance	Allows you to set the overall colour tone of the picture (Cool / Normal / Warm)
	Colour Management	Automatically adjusts colours to vivid ones (Off / On) <ul style="list-style-type: none"> ● Not valid on PC signal
	x.v.Colour	Increases the colour gradations (Off / Auto) <ul style="list-style-type: none"> ● This is effective when watching HD moving pictures from an external equipment. ● HDMI input mode or Movie View Mode (p. 44) only
	Eco Mode	Adjusts picture settings automatically dependent on ambient lighting conditions (Off / On)
	P-NR	Picture Noise Reduction Automatically reduces unwanted picture noise and flicker noise in the contoured parts of a picture (Off / Min / Mid / Max) <ul style="list-style-type: none"> ● Not valid on PC signal
	3D-COMB	Occasionally, whilst viewing still or slow moving pictures, colour patterning may be seen Set to "On" to display sharper and more accurate colours (Off / On) <ul style="list-style-type: none"> ● For PAL or NTSC signal reception only ● Not valid on RGB, S-Video, Component, PC, HDMI and SD Card
	Advanced Settings	W/B High R
W/B High B		White balance of bright blue area <ul style="list-style-type: none"> ● For PC input mode or when "Viewing Mode" is set to "Normal" / "Cinema"
W/B Low R		White balance of dark red area <ul style="list-style-type: none"> ● For PC input mode or when "Viewing Mode" is set to "Normal" / "Cinema"
W/B Low B		White balance of dark blue area <ul style="list-style-type: none"> ● For PC input mode or when "Viewing Mode" is set to "Normal" / "Cinema"
Gamma		Switches the gamma curve (S Curve / 2.0 / 2.2 / 2.5) <ul style="list-style-type: none"> ● For PC input mode or when "Viewing Mode" is set to "Normal" / "Cinema"
Reset to Defaults		Press the OK button to reset to the default Advanced Settings <ul style="list-style-type: none"> ● For PC input mode or when "Viewing Mode" is set to "Normal" / "Cinema"
Reset to Defaults	Press the OK button to reset the present Picture Viewing Mode to the default settings	

①

① and ② repeatedly adjusted

②

Menu	Item	Adjustments / Configurations (alternatives)
Sound	Mode	Basic sound mode (Music / Speech)
	Bass	Increases or decreases level to enhance or minimise lower, deeper sound output
	Treble	Increases or decreases level to enhance or minimise sharper, higher sound output
	Balance	Adjusts volume level of right and left speakers
	Headphone Volume	Adjusts the volume of the headphones
	Surround	Surround sound settings (Off / V-Audio / V-Audio Surround) V-Audio: Provides a dynamic enhancer of width to simulate improved spatial effects V-Audio Surround: Provides a dynamic enhancer of width and depth to simulate improved spatial effects ● Switching is also possible by the Surround button on the remote control (p. 9).
	Volume Correction	Adjusts the volume of individual channel or input mode
	Speaker Distance to Wall	Adjusts the low frequency sound (Over 30cm / Up to 30cm) ● If the back space between the TV and wall is over 30 cm, "Over 30cm" is recommended. ● If the back space between the TV and wall is within 30 cm, "Up to 30cm" is recommended.
	MPX	Select stereo / monaural (Mono / Stereo) ● Normally: Stereo ● Stereo signal cannot be received: Mono ● M1 / M2: Available while mono signal is transmitted ● Analogue mode only
	SPDIF Selection	Selects the initial setting for digital audio output signal from DIGITAL AUDIO OUT terminal (Auto / PCM) Auto : Dolby Digital Plus and Dolby Digital are output as Dolby Digital Bitstream. HE-AAC (48 kHz) is output as DTS. MPEG is output as PCM. PCM : Digital output signal is fixed to PCM. ● DVB mode or Movie View Mode (p. 44) only
MPEG Optical Level	Normally, MPEG sound is larger comparing with the other types of audio track You can adjust the audio level of MPEG output from DIGITAL AUDIO OUT terminal as the initial setting (0 / -2 / -4 / -6 / -8 / -10 / -12dB) ● DVB mode only	
HDMI1 / 3 Input	Select to fit the input signal (Digital / Analogue) (p. 59) Digital : HDMI cable connection Analogue : HDMI-DVI adapter cable connection ● HDMI input mode only ● HDMI2 terminal is for digital signal only ● No setting for HDMI2 available	
Reset to Defaults	Press the OK button to reset the present Sound Mode to the default settings	

- A different menu will be displayed while PC or SD Card is used. (p. 43 - 45)
- Only available items can be selected.

How to Use Menu Functions

■ Menu list

Menu	Item	Adjustments / Configurations (alternatives)	
Setup	Off Timer	Sets the time the TV automatically turns Off (Off / 15 / 30 / 45 / 60 / 75 / 90 minutes)	
	Link Settings	VIERA Link	Sets to use VIERA Link functions (Off / On) (p. 49)
		Q-Link	Selects which AV terminal is to be used for data communication between this TV and a compatible recorder (AV1 / AV2) (p. 48) ● Select the connected terminal to the recorder even it is not compatible with Q-Link.
		AV1 / AV2 out	Chooses the signal to be transmitted from the TV to Q-Link (TV / AV1 / AV2 / AV3 / Monitor) ● Monitor: Image displayed on screen ● Component, PC and HDMI signals cannot be outputted.
		Power on Link	Sets to use Power on Link function (Off / On) (p. 48 and p. 49)
		Power off Link	Sets to use Power off Link function (Off / On) (p. 48 and p. 49)
		Standby Power Save	Controls the power consumption in Standby mode of the connected equipment to reduce the consumption (Off / On) (p. 50) ● This function is available when "VIERA Link" is set to "On" and "Power off Link" is set to "On".
		Intelligent Auto Standby	Makes non-watched or non-used connected equipment go into Standby mode to reduce the power consumption (Off / On (With reminder) / On (No reminder)) (p. 50) ● This function is available when "VIERA Link" is set to "On".
		Download	Downloads channel, language, country / region settings to a Q-Link or VIERA Link compatible equipment connected to the TV ● DVB-C channel setting cannot be downloaded.
	Child Lock	Locks a channel / AV input to prevent access to it (p. 36)	
	DVB-C Tuning Menu	Favourites Edit	Creates list of favourite DVB-C channels (p. 33)
		Channel List	Skips the unwanted DVB-C channels or edits DVB-C channels (p. 33)
		Auto Setup	Automatically sets the DVB-C channels supplied (p. 30)
		Manual Tuning	Sets the DVB-C channels manually (p. 33)
		Update Channel List	Updates DVB-C Channel List with keeping your settings (p. 32)
		New Channel Message	Selects whether to give a notification message when a new DVB-C channel is found (p. 32)
		Signal Condition	Checks the DVB-C signal condition (p. 32)
		Add DVB-T HD Channels	Retunes all TV channels to add DVB-T HD channels ● All the previous tuning settings are erased. ● Use this function if DVB-T HD services start in your area.
	DVB-T Tuning Menu	Favourites Edit	Creates list of favourite DVB-T channels (p. 33)
		Channel List	Skips the unwanted DVB-T channels or edits DVB-T channels (p. 33)
		Auto Setup	Automatically sets the DVB-T channels received in the area (p. 31)
		Manual Tuning	Sets the DVB-T channels manually (p. 33)
		Update Channel List	Updates DVB-T Channel List with keeping your settings (p. 32)
		Favourite Network	Selects your favourite network for each broadcasters
		New Channel Message	Selects whether to give a notification message when a new DVB-T channel is found (p. 32)
		Signal Condition	Checks the DVB-T signal condition (p. 32)
		Add HD Channels	Retunes all TV channels to add HD channels ● All the previous tuning settings are erased. ● Use this function if HD services start in your area.
Add DVB-C Channels		Retunes all TV channels to add DVB-C channels ● All the previous tuning settings are erased. ● Use this function if DVB-C services supply.	

Menu	Item	Adjustments / Configurations (alternatives)		
Setup	Analogue Tuning Menu	Channel List	Skips the unwanted Analogue channels or edits Analogue channels (p. 35)	
		Auto Setup	Automatically sets the Analogue channels received in the area (p. 31)	
		Manual Tuning	Sets the Analogue channels manually (p. 35)	
		Add DVB-T Channels	Retunes all TV channels to add DVB-T channels <ul style="list-style-type: none"> ● All the previous tuning settings are erased. ● Use this function if DVB-T services start in your area. 	
	Language	OSD Language	Changes language for on-screen displays	
		Preferred Audio 1 / 2	Selects the first and second preferred language for DVB multi audio (depending on the broadcaster)	
		Preferred Subtitles 1 / 2	Selects the first and second preferred language for DVB subtitles (depending on the broadcaster) <ul style="list-style-type: none"> ● To display subtitles → p. 16 	
		Preferred Teletext	Selects the preferred language for DVB teletext service (depending on the broadcaster)	
	Display Settings	Preferred Subtitle Type	Selects the preferred subtitle type (Standard / Hard of Hearing) <ul style="list-style-type: none"> ● “Hard of Hearing” provides aids in understanding and enjoyment with DVB subtitles (depending on the broadcaster). ● “Preferred Subtitles 1 / 2” in “Language” are given priority. 	
		Teletext	Teletext display mode (TOP (FLOF) / List) (p. 20)	
		Teletext Character Set	Selects teletext language (West / East1 / East2) <ul style="list-style-type: none"> ● West: English, French, German, Greek, Italian, Spanish, Swedish, Turkish, etc. ● East1: Czech, English, Estonian, Lettish, Rumanian, Russian, Ukrainian, etc. ● East2: Czech, Hungarian, Lettish, Polish, Rumanian, etc. 	
		Side Panel	Increases the brightness of the side panel (Off / Low / Mid / High) <ul style="list-style-type: none"> ● The recommended setting is “High” to prevent panel “image retention”. 	
		Input Labels	Labels or skips each input terminal (p. 40)	
		Banner Display Timeout	Sets how long the Information banner (p. 15) stays on screen (0 (No display) / 1 / 2 / 3 / 4 / 5 / 6 / 7 / 8 / 9 / 10 seconds)	
		Playing Time Display	Set to “On” to display a continuous record of time spent using Game mode (Off / On) <ul style="list-style-type: none"> ● This function is available when “Game” is selected in “Viewing Mode” (p. 26). 	
		Common Interface	Uses include to watch pay-TV (p. 37)	
	System Menu	Shipping Condition	Resets all settings, for example, when moving house (p. 38)	
		System Update	Downloads new software to TV (p. 39)	
		Software Licence	Displays the software licence information	
		System Information	Displays the system information of this TV	
	Other Settings	AV Colour System	Selects optional colour system based on video signals in AV mode (Auto / PAL / SECAM / M.NTSC / NTSC)	
		GUIDE Plus+ Settings	Update	Performs the update of the GUIDE Plus+ schedule and advertising informations for the GUIDE Plus+ system (p. 19)
			Postcode	Sets your postcode to display advertisements in the GUIDE Plus+ system (p. 19)
			System Information	Displays the system information of the GUIDE Plus+ system
		Intelligent Frame Creation	Automatically compensates the picture frame rate to make the image smooth (Off / On)	
		Power Save	Reduces brightness of picture to economise on power consumption (Off / On)	
		Picture Overscan	Selects the screen area displaying the image (Off / On) On : Enlarged the image to hide the edge of the image. Off : Displayed the image in the original size. <ul style="list-style-type: none"> ● Set to “On” if noise is generated on the edge of the screen. ● This function is available when aspect is set to Auto (16:9 signal only) or 16:9. ● This function can be memorized separately for SD (Standard definition) and HD (High definition) signals. 	
SD Card LED		Lights blue LED while SD Card is inserted (Off / On) (p. 42)		
Time Zone		Adjusts the time data <ul style="list-style-type: none"> ● The time data will be corrected based on GMT. ● Set to “Auto” to adjust the time automatically according to your area. 		

- A different menu will be displayed while PC or SD Card is used. (p. 43 - 45)
- Only available items can be selected.

Viewing

● How to Use Menu Functions (picture, sound quality, etc.)

Retuning from Setup Menu

Auto Setup retunes all channels automatically.

DVB-C channels

Automatically retune all the DVB-C channels supplied.

- This function is available if DVB-C channel tuning is already performed.
- Only DVB-C channels are retuned.
- All the previous tuning settings are erased.
- If a Child Lock PIN number (p. 36) has been set, it must be entered.



- Select DVB-C**
→ p. 14
TV
- Display the menu**
MENU
- Select "Setup"**

VII f	Main Menu
□	Picture
♪	Sound
≡	Setup

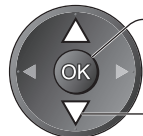
- Select "DVB-C Tuning Menu"**

≡	Setup Menu
Off Timer	Off
Link Settings	
Child Lock	
DVB-C Tuning Menu	Access
Language	
Display Settings	
Common Interface	
System Menu	
Other Settings	

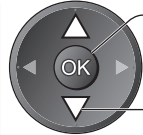

To return to TV
EXIT

For Auto Setup, using the buttons on the side panel of the TV (p. 8)

- Press repeatedly until "Auto Setup" appears
F
- Access "Auto Setup"
TV
- Set the search mode and scan mode
+/ **-/** (select the item)
TV (set)
- Start "Auto Setup"
AV

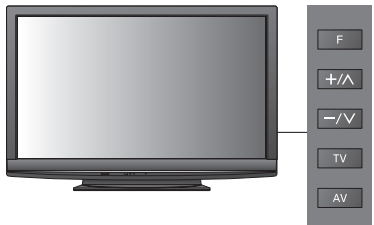

• To return to TV → **F**

- Select "Auto Setup"**

≡	DVB-C Tuning Menu
Favourites Edit	
Channel List	
Auto Setup	Access
Manual Tuning	
Update Channel List	
New Channel Message	On
Signal Condition	

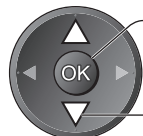

- Set the search mode and scan mode**

DVB-C Auto Setup Settings	
Search Mode	Free Channels
Scan Mode	Quick
Frequency	Auto
Symbol Rate	Auto
Network ID	Auto

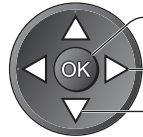

Full: scans the whole frequency range

Quick: scans the suitable frequency in your country

- Normally set Frequency, Symbol Rate and Network ID "Auto".

- Start Auto Setup**

DVB-C Auto Setup

All DVB-C tuning data will be erased **OK**

DVB-C Auto Setup				
Scan 0% 100%				
This will take about 3 minutes.				
CH	Channel Name	Type	Quality	
372	CBBC Channel	Free TV	10	
372	BBC Radio Wales	Free TV	10	
372	E4	Free TV	10	
Free TV: 3 Pay TV: 0 Radio: 0 Data: 0				
Searching				

Settings are made automatically

- Depending on the country you select (p. 12), "Favourite Network Selection" or "Region Selection" is required → p. 13

When the operation is completed, the channel at the lowest position will be displayed.

DVB-T or Analogue channels

- Automatically retune all DVB-T or Analogue channels received in the area.
- DVB-T Auto Setup is available if DVB-T channel tuning is already performed.
- Only DVB-T channels are retuned in DVB-T mode.
- Only Analogue channels are retuned in Analogue mode.
- All the previous tuning settings are erased.
- If a Child Lock PIN number (p. 36) has been set, it must be entered.



1 Select DVB-T or Analogue

→ p. 14

TV

2 Display the menu

MENU

3 Select "Setup"

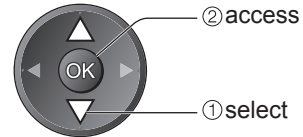
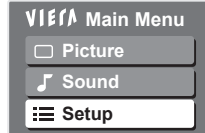

4 Select "DVB-T Tuning Menu" or "Analogue Tuning Menu"

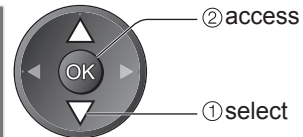
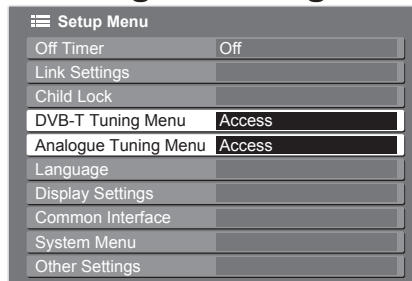

- "DVB-T Tuning Menu" is available in DVB-T mode only.
- "Analogue Tuning Menu" is available in Analogue mode only.

5 Select "Auto Setup"

DVB-T:

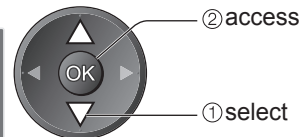
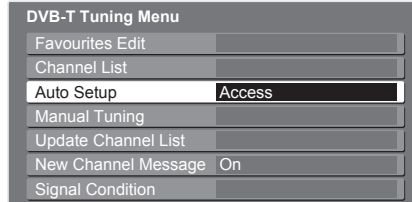

Analogue:

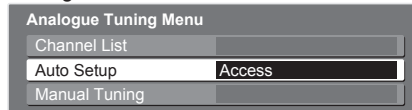

6 Start Auto Setup

DVB-T:

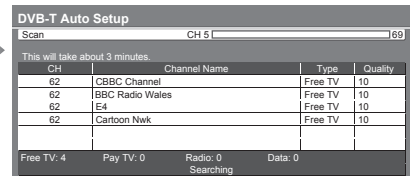
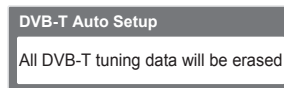

Analogue:

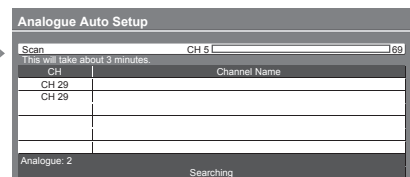
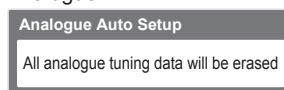

Settings are made automatically

- The channel, language, country / region settings are downloaded to a Q-Link or VIERA Link compatible equipment connected to the TV.

When the operation is completed, the channel at channel position "1" will be displayed.

To return to TV

EXIT



For Auto Setup, using the buttons on the side panel of the TV (p. 8)

- 1 Press repeatedly until "Auto Setup" appears

F

- 2 Access "Auto Setup"

TV

- 3 Start "Auto Setup"

TV

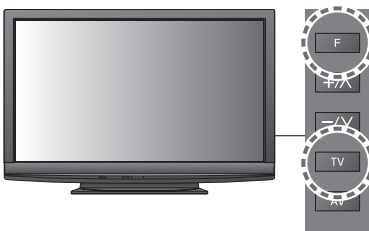

- To return to TV → **F**

Note

- If tuning has not been done completely → "Manual Tuning" (p. 33 and p. 35)

Tuning and Editing Channels

(DVB)

You can retune channels or make your favourite channel lists, skip unwanted channels, etc.



1 Select DVB-C or DVB-T

→ p. 14



2 Display the menu

MENU



3 Select "Setup"

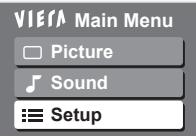

4 Select "DVB-C Tuning Menu" or "DVB-T Tuning Menu"

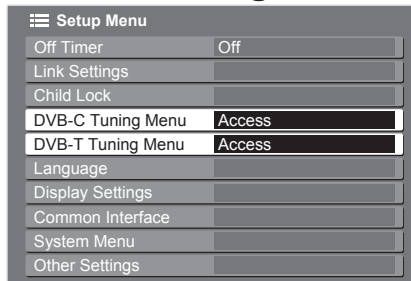

- "DVB-C Tuning Menu" is available in DVB-C mode only.
- "DVB-T Tuning Menu" is available in DVB-T mode only.

5 Select one of the following functions and set

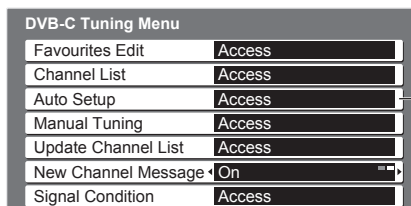

- The function items vary depending on the country you select (p. 12).
- "Retuning from Setup Menu" (p. 30 and p. 31)

To return to TV

EXIT



Update DVB channel automatically Update Channel List

You can add new channels, delete removed channels, update channel name and position automatically to Channel List.



- Channel List is updated with keeping your settings in Favourites Edit, Channel List, Child Lock, etc.

Display a notification message New Channel Message

Selects whether to give a notification message when a new DVB channel is found. (Off / On)



- Selecting OK will perform "Update Channel List".

Check DVB signal Signal Condition

Selects a channel and checks the DVB signal condition.

- To change the channel →

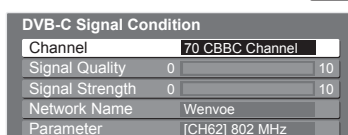

A good Signal Strength is not an indication of suitable signal for DVB reception. Please use the Signal Quality indicator as follows:

Signal Quality:

- Green bar → Good
- Yellow bar → Poor
- Red bar → Bad (Check the Terrestrial aerial or cable)

List favourite DVB channels **Favourites Edit**

Create your favourite channel lists from various broadcasters (up to 4: Favourites1 to 4).

The DVB Favourites lists are available from "Category" in the Information banner (p. 15) and the TV Guide (p. 18).

① Select a channel to list

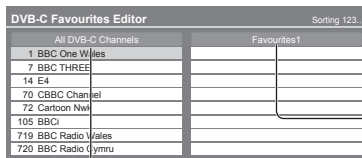

- To sort channel names in alphabetical order → blue

- To display other Favourites → green

- To change the category → red

② Add it to the Favourites list

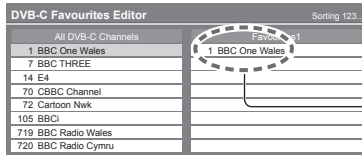

A channel is added

- To add all channels to the list → yellow

Note

- Channel position numbers can be swapped in Channel List.

■ To edit Favourites list



Select the field of Favourites to edit and:

- To name the Favourites → red

Set characters one by one

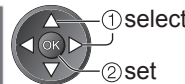

You can set characters by using numeric buttons.
→ "Characters table for numeric buttons" (p. 58)

- To move the channel → green

Select the new position → Confirm → green

③ Store



Skip unwanted DVB channels, Edit DVB Channels **Channel List**

You can hide unwanted DVB channels.

The hidden channels cannot be displayed except in this function. Use this function to skip unwanted channels.

Select a channel and reveal / hide

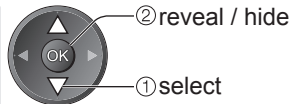

: reveal
 : hide (skip)

- To reveal all channels → yellow

■ To edit channels

You can also edit each channel in Channel List.

- To change the category → red

- To swap the channel position (if available) → green → Enter the new position number → Store → green

- To move the channel position (if available) → green → Select the new position → Store → green

- To sort channel names in alphabetical order → blue

Set DVB channel manually **Manual Tuning**

Normally use "Auto Setup" or "Update Channel List" to retune DVB channels.

If tuning has not been done completely or for adjusting the direction of the aerial, use this function.

- All channels found will be added to the Channel List.

DVB-C:

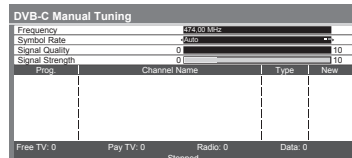

Enter the frequency



Search



DVB-T:

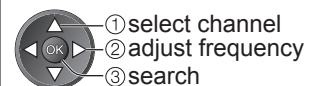
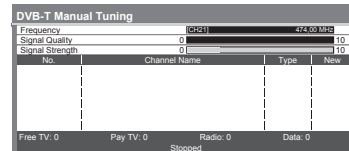

Set Symbol Rate, and then perform this function.

- Normally set Symbol Rate "Auto".

Set where the level of "Signal Quality" becomes the maximum.

Tuning and Editing Channels

(Analogue)

You can retune channels or skip unwanted channels, edit channels etc.



1 Select Analogue

→ p. 14



2 Display the menu



3 Select "Setup"

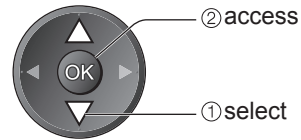
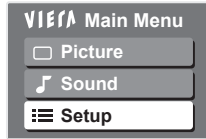

4 Select "Analogue Tuning Menu"

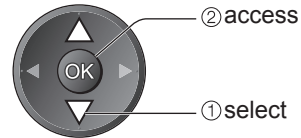
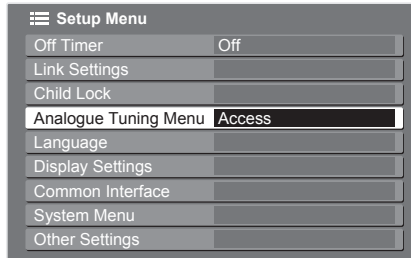

5 Select one of the following functions

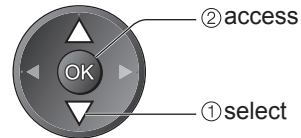
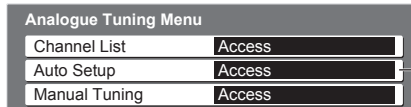

● The function items vary depending on the country you select (p. 12).

→ "Retuning from Setup Menu" (p. 31)

■ To return to TV

EXIT



6 Set

Skip unwanted Analogue channels, Edit Analogue channels Channel List

You can hide unwanted Analogue channels.
The hidden channels cannot be displayed except in this function. Use this function to skip unwanted channels.

Select a channel and reveal / hide

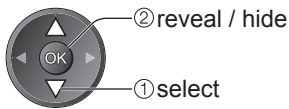
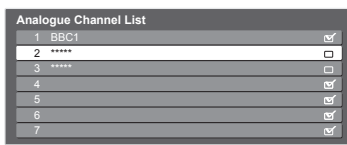

: reveal
 : hide (skip)

● To reveal all channels
→ yellow

To edit channels

You can also edit each channel in Channel List.



Select a channel to edit and:

● To retune each channel (Manual Tuning) → red (see below)

● To move the channel position → green → Select the new position → Store green

● To rename the channel name → blue → Set characters one by one → Store BACK/RETURN

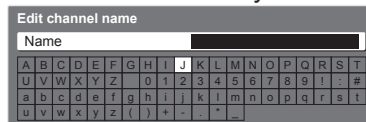

(maximum: five characters)

● You can set characters by using numeric buttons.
→ "Characters table for numeric buttons" (p. 58)

Note

● If a VCR is connected only with the RF cable, edit "VCR".

Set Analogue channel manually Manual Tuning

Fine Tuning

Use to make small adjustments to the tuning of an individual programme (affected by weather conditions, etc.)

Manual Tuning

Set Analogue channel manually after Auto Setup.

- Set Sound System and Colour System, and then perform this function.
Normally set Colour System "Auto".
- If a VCR is connected only with the RF cable, select channel position "0".

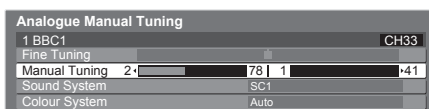

SC1: PAL B, G, H / SECAM B, G
SC2: PAL I
SC3: PAL D, K / SECAM D, K
F: SECAM L, L'

Select the channel position



Select the channel



Search and store

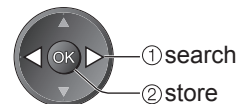

Child Lock

You can lock specific channels / AV input terminals and control who watches them. When the locked channel / input is selected, a message appears; by entering the PIN number, you can watch it.

1 Display the menu
MENU

2 Select "Setup"
VIERA Main Menu
Picture
Sound
Setup

3 Select "Child Lock"
Setup Menu
Off Timer Off
Link Settings
Child Lock Access
DVB-T Tuning Menu
Language
Display Settings
Common Interface
System Menu
Other Settings

4 Set
EXIT

② access
① select

② access
① select

Control channel audience **Child Lock**

① Enter the PIN number (4 digits)

Child Lock-PIN Entry
Please enter new PIN
PIN

1 2 3
4 5 6
7 8 9
0

- Enter the PIN number twice at first setting.
- Make a note of the PIN number in case you forget it.
- "0000" may be stored as the default PIN number which depends on the country you select (p. 12).

② Select "Child Lock List"

Child Lock
Change PIN
Child Lock List Access
Parental Rating No Limit

② access
① select

③ Select the channel / input to be locked

Child Lock List - TV and AV

Name	Input	Type	Lock
101 BBC 1 Wales	DVB-C	FreeTV	
7 BBC THREE	DVB-T	FreeTV	🔒
14 EA	DVB-T	FreeTV	
VCR	Analogue	Analogue	
1 BBC1	Analogue	Analogue	
2	External	Analogue	
AV1	External	AV	
AV2S	External	AV	

② lock
① select

- To cancel → Select the locked channel / input → OK
- To jump to the top of the next input → red
- To lock all → green
- To cancel all locks → yellow
- To sort channel names in alphabetical order → blue

Appears when the channel / input is locked

To change the PIN number
Select "Change PIN"

Child Lock
Change PIN Access
Child Lock List
Parental Rating No Limit

② access
① select

Enter a new PIN number twice

1 2 3
4 5 6
7 8 9
0

To set Parental Rating

- The availability of this function depends on the country you select (p. 12).

If the DVB programme has the rated information for over the selected age, you have to enter the PIN number to watch (depending on the broadcaster).

Select "Parental Rating" and set an age for the restriction of programmes.

Child Lock
Change PIN
Child Lock List
Parental Rating No Limit

② set
① select

Note

- Setting "Shipping Condition" (p. 38) erases the PIN number and all settings.

Using Common Interface

The Common Interface Module menu provides access to software contained on Common Interface (CI) Modules.

● This function may not be available in some countries or regions.

Although CI module may enable you to view some services, this TV does not guarantee all services (e.g. pay-TV).

Please use only the approved CI module by the broadcaster.

Consult your local Panasonic dealer or broadcasters for more information and conditions of the services.

Caution

- Turn Off Mains power On / Off switch whenever inserting or removing the CI module.
- If a view card and a card reader come as a set, first insert the card reader, then insert the view card into the card reader.
- Insert the module in the correct direction.

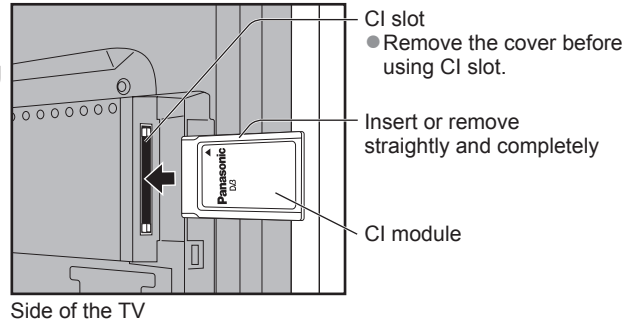

Insert the CI module (optional)

- The features that appear on screen are dependent on the contents of the selected CI module.
- Normally pay-TV channels will appear. Follow the on screen operation guide. If pay-TV channel does not appear, perform below.
- For more details, see the manual of the CI module, or check with the broadcaster.



1 Select DVB-C or DVB-T

→ p. 14



2 Display the menu



3 Select "Setup"

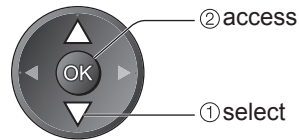
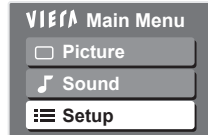

4 Select "Common Interface"

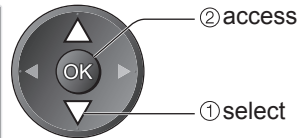
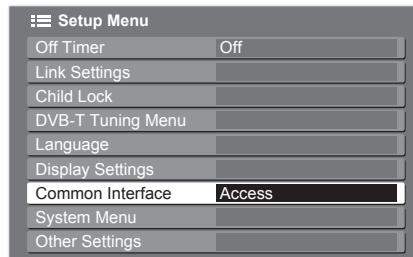

5 Access Common Interface

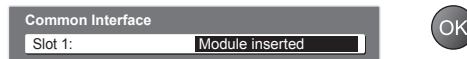

6 Follow the on screen operation guide

For example: select, go → OK



Coloured characters → red green yellow blue

To return to TV

EXIT



- On screen operation guide may not correspond to the remote control buttons.

Shipping Condition

Resets the TV to its original condition, i.e. no channels tuned in. All settings are reset (channels, picture, sound settings, etc.).



1 Display the menu



2 Select "Setup"

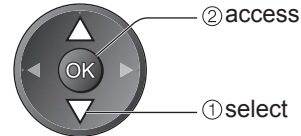
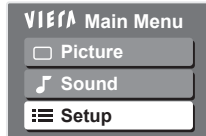

3 Select "System Menu"

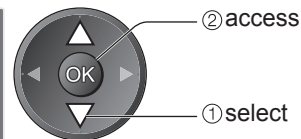
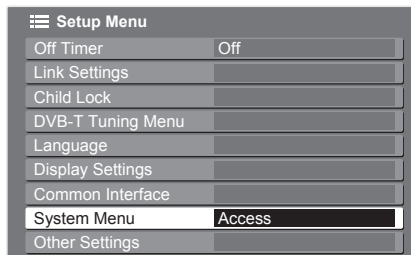

4 Select "Shipping Condition"

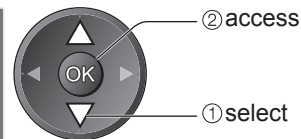
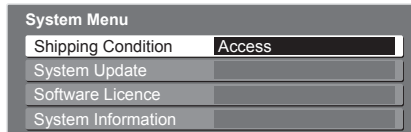

5 Set

■ To return to TV



Restore Settings Shipping Condition

① Check the message and initialise

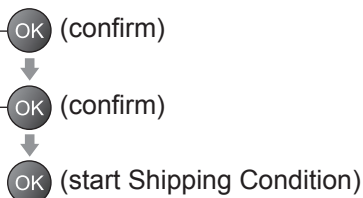
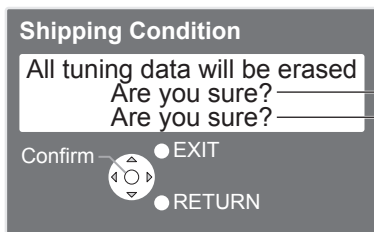

② Follow the on-screen instructions



● "Auto Setup" will automatically start when Mains power On / Off switch is next turned On. (p. 12)

■ To retune TV channels only, e.g. after moving house

➔ "Retuning from Setup Menu" (p. 30 and p. 31)

Updating the TV Software

From time to time, a new version of software may become available for download to enhance the performance or operations of the TV.
If there is an update available, a notification banner is displayed when the channel has the update information.

- To download →
- If you choose not to download →

You can update any new software automatically or update manually.

- 1 Display the menu**
MENU
- 2 Select "Setup"**

VIERA Main Menu	
Picture	
Sound	
Setup	
- 3 Select "System Menu"**

Setup Menu	
Off Timer	Off
Link Settings	
Child Lock	
DVB-T Tuning Menu	
Language	
Display Settings	
Common Interface	
System Menu	Access
Other Settings	
- 4 Select "System Update"**

System Menu	
Shipping Condition	
System Update	Access
Software Licence	
System Information	
- 5 Set**

■ To return to TV



Update TV's software system **System Update**

■ To update automatically

Select "Auto Update Search in Standby"

System Update	
Auto Update Search in Standby	Off
System Update Search Now	

- Every time you set, the TV automatically performs a search in standby and downloads an update, if any software updates are available.
- The automatic updating is performed under the following conditions:
 - Standby (TV turned Off with the remote control)
 - Recording is not in progress.

**If System Update is performed, the software will be updated (it may change TV functions).
If you do not wish to do so, set "Auto Update Search in Standby" to "Off".**

■ To update immediately

Select "System Update Search Now"

System Update	
Auto Update Search in Standby	Off
System Update Search Now	Access

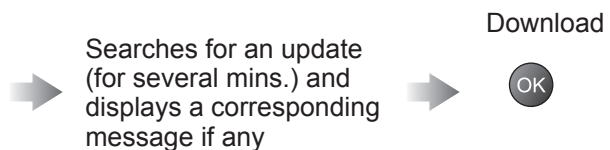

Note

- Download may take for about 60 mins.
- During software download and update, DO NOT switch Off the TV.
- The message might be the notification beforehand. In this case, the schedule information (the date that the new version can be used) will appear. You can set the reservation for update. The update will not start when the TV is set to Off.

Input Labels

For easier identification and selection of the input mode, you can label each input mode or skip terminal that is not connected to any equipment.

- To select the input mode → p. 22



1 Display the menu



2 Select "Setup"

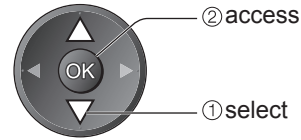
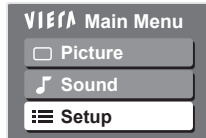

3 Select "Display Settings"

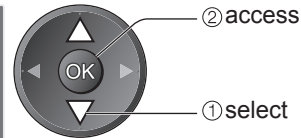
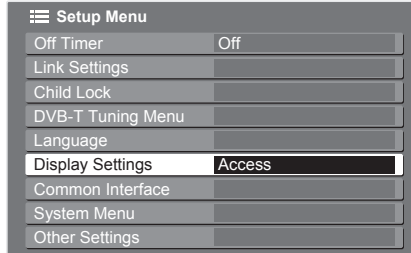

4 Select "Input Labels"

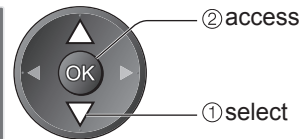
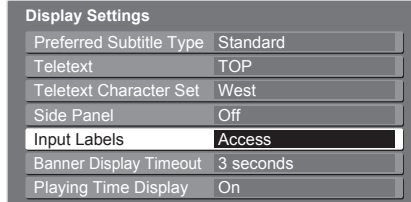

5 Select a input terminal and set

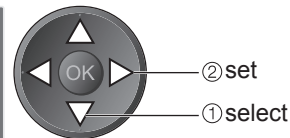
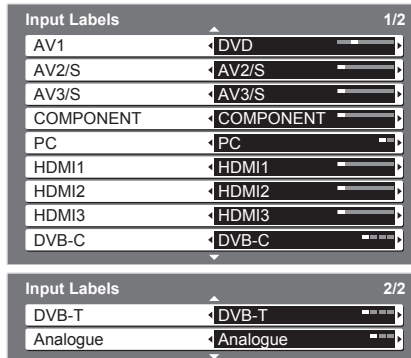

■ To return to TV
EXIT
→

The labels you set will be displayed in "Input Selection" menu (p. 22), "TV Selection" menu (p. 14) or banner.

- If "Skip" is selected, you cannot select the mode.

■ User input

You can name each input mode freely.

Select "User input"

Set characters one by one

Store

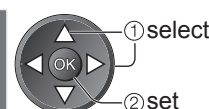
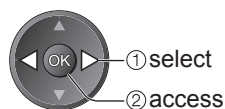

(maximum: ten characters)

- You can set characters by using numeric buttons.
→ "Characters table for numeric buttons" (p. 58)

How to Use VIERA TOOLS

You can access some special features easily by using the VIERA TOOLS function.



1 Display icons of the feature

2 Select a feature

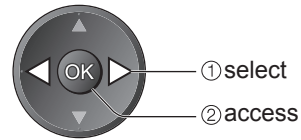

3 Follow the operations of each feature

- VIERA Link Control → "VIERA Link Control" (p. 52)



When more than two pieces of compatible equipment are connected a selection screen will be displayed. Please select the correct description and access.

- Pause Live TV → "Pause Live TV" (p. 51)



- Slideshow → "Slideshow" (p. 43)



Slideshow will use all of the photos on the SD Card.

- Photos → "Photo View" (p. 42)



- Movies → "Movie View" (p. 44)



■ To return to TV



Viewing from SD Card

(VIERA IMAGE VIEWER)

Photo View: Still images recorded by digital cameras will be displayed.

Movie View: Moving pictures recorded by digital video cameras will be played back.

- During the operation, sound signal is output from AV1, AV2, AUDIO OUT and DIGITAL AUDIO OUT terminals. But no video signals are output.
- "Date" shows the date on which the recording was made by the digital camera or digital video camera. The file without record of the date is shown "***/**/****".
- For details on SD Cards → p. 57

■ To insert the SD Card

Label surface

Push until a click is heard

■ To remove the SD Card

Press the centre of the card

Blue LED

- Blue LED lights while SD Card is inserted if "SD Card LED" is set to "On" in the Setup Menu (p. 29).

Photo View



- 1 **Insert the SD Card**
- 2 **Select "Photo View"**

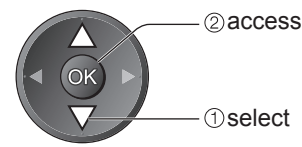
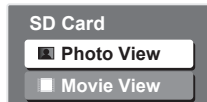

- You can also access directly by using VIERA TOOLS → "How to Use VIERA TOOLS" (p. 41)

- 3 **Select the folder to display the thumbnail**

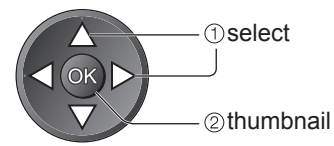

- The files which are not into a folder will be collected to the folder named "I".

- 4 **Select the file from the thumbnail to be viewed**

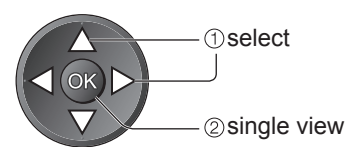
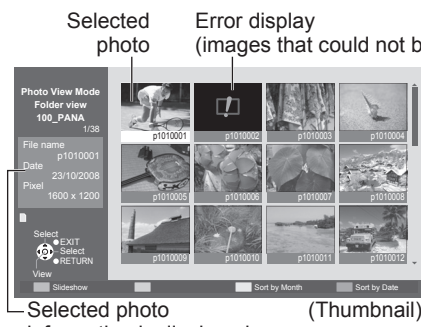

- Slideshow → p. 43

■ To return to TV
 EXIT or

■ To return to the previous screen
 BACK/RETURN →

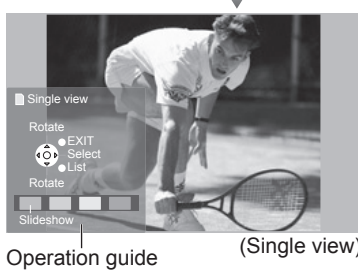

Displayed one at a time
 • To display / hide the operation guide

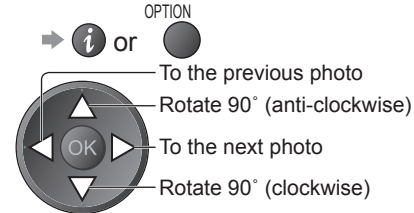

- To return to thumbnail →

Slideshow

Start Slideshow (operate in step 4)

Select the photo for the first view

Start Slideshow



Note

- Slideshow is done within the thumbnail.
- You can also start slideshow directly by using VIERA TOOLS → “How to Use VIERA TOOLS” (p. 41)

Slideshow settings (operate in Photo View Mode)

Display the menu



Select “Viewing Setup”

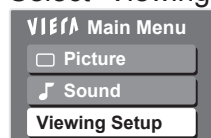

Select the items and set

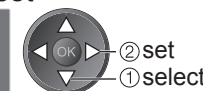
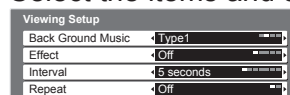

• Other Items → p. 26 and p. 27

Menu	Item	Adjustments / Configurations (alternatives)
Viewing Setup	Back Ground Music	Selects the back ground music during the slideshow (Off / Type1 / Type2 / Type3)
	Effect	Selects the effect for switching the photo during the slideshow (Off / Fade / Slide / Dissolve / Random) Fade : The next photo fades in gradually Slide : The next photo slides and appears from the left side Dissolve : The photo is replaced by an indefinite block unit Random : Selects each effect at random
	Interval	Selects slideshow interval (5 / 10 / 15 / 30 / 60 / 90 / 120 seconds)
	Repeat	Slideshow repeat (Off / On)

To display all the photos

Display the thumbnail of all the photos in SD Card.



(Folder view)

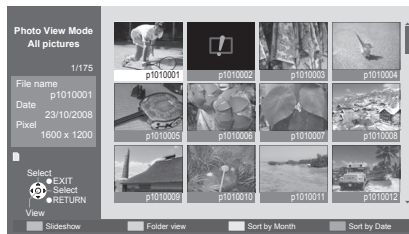

(Thumbnail - All pictures)



To sort by date or month recorded

Display the list of groups sorted by the same date or the same month.

- The group of the photos without record of the date is shown as “Unknown”.



(Thumbnail)



(Sort by Month)

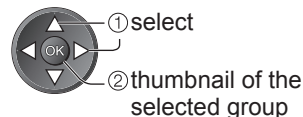

(Sort by Date)

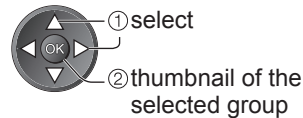

Viewing from SD Card

(VIERA IMAGE VIEWER)

Movie View



1 Insert the SD Card

2 Select "Movie View"

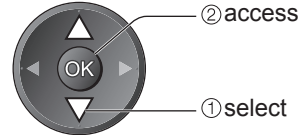
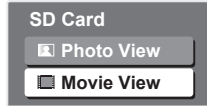

- You can also access directly by using VIERA TOOLS
- "How to Use VIERA TOOLS" (p. 41)

3 Select the file to be viewed



- File format: Only AVCHD or MPEG2 are supported.
- For details → p. 57

Selected movie

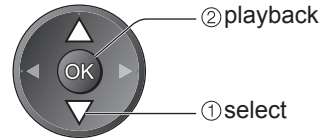

To return to TV

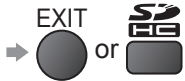

To return to the previous screen



Operation guide information banner →

- To return to list → (stop)
- To change aspect ratio (only for the 4:3 movie content) → ASPECT

Playback will start

- To display the operation guide



- To hide the operation guide →

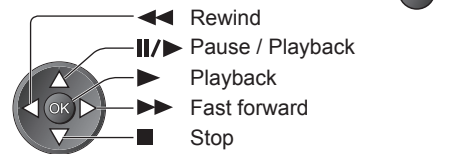

- To the previous movie → red
- To the next movie → green

Audio Settings

You can enjoy the multi-channel sound via an amplifier connected to DIGITAL AUDIO OUT terminal.

To confirm or change the current sound status (during playback)

Display the Option menu

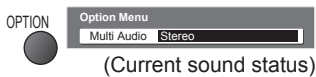

Change the sound (if the movie has multiple audio signals)



- It may take several seconds to change the sound.

Audio output settings (operate in step 3)

Display the menu



Select "Sound"



- Other items → p. 26 - 29

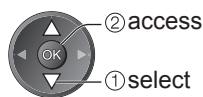

Select "SPDIF Selection" and set

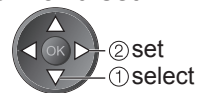
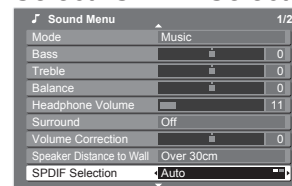

Menu	Item	Adjustments / Configurations (alternatives)
Sound	SPDIF Selection	SPDIF : A standard audio transfer file format Selects the initial setting for digital audio output signal from DIGITAL AUDIO OUT terminal (Auto / PCM) Auto: Dolby Digital is output as Dolby Digital Bitstream. MPEG is output as PCM. PCM: Digital output signal is fixed to PCM.

Displaying PC Screen on TV

The screen of the PC connected to the TV can be displayed on the TV.
You can also listen to PC sound with the audio cable connected.

- To connect PC → p. 54



1 Select the external input
[AV]

2 Select "PC"

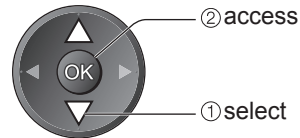
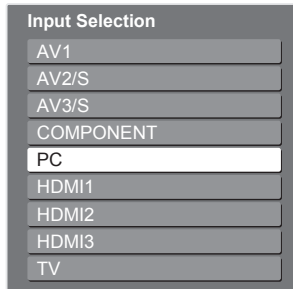



- Corresponding signals → p. 60
- If "H-freq." or "V-freq." is shown in red, the signals may not be supported.

■ To return to TV

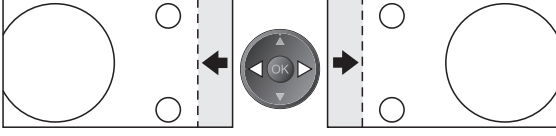

■ PC menu setting (changed as desired)

- To make settings → "How to Use Menu Functions" ① to ④ (p. 24)

Menu	Item	Adjustments / Configurations (options)	
Setup	PC Setup	Input Resolution Switches to a wide view ● VGA (640 × 480 pixels), WVGA (852 × 480 pixels), XGA (1,024 × 768 pixels), WXGA (1,280 × 768 pixels, 1,366 × 768 pixels) ● Options change depending on signals	
		Clock Set to the minimum level if noise occurs	
		H-pos Adjusts horizontal position	
		V-pos Adjusts vertical position	
		Clock Phase Eliminates flicker and distortion ● Adjust after Clock adjustment ● Set to the minimum level if noise occurs	
		Sync Chooses another synchronous signal if the image is distorted (H & V / On Green) ● H & V : by the horizontal and vertical signals from your PC On Green: by the green signal from your PC (if available)	
		Reset to Defaults Press the OK button to reset to the default PC Setup settings	

- Other items → p. 26 - 29

Note

- For HDMI-compatible PC, possible to connect to HDMI terminals (HDMI1 / HDMI2 / HDMI3) by using HDMI cable (p. 59).

● Viewing from SD Card (VIERA IMAGE VIEWER)
● Displaying PC Screen on TV

Advanced

Link Functions (Q-Link VIERA Link)

Q-Link connects the TV and DVD Recorder / VCR, and enables easy recording, playback, etc. (p. 48)
 VIERA Link (HDAVI Control™) connects the TV and the equipment with VIERA Link function, and enables easy control, convenient recording, playback, energy saving, creating home theatre, etc., without complicated setting. (p. 49 - 53)

You can use Q-Link and VIERA Link functions together.

- This TV supports "HDAVI Control 4" function. But available features are depending on the connected equipment's version of HDAVI Control. Please refer to the manual of the equipment to confirm the version.

Summary of Q-Link and VIERA Link features

■ Q-Link (SCART connection only)

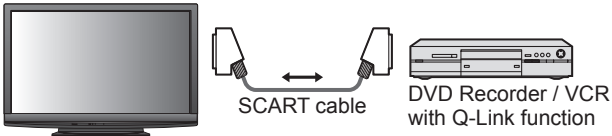
Features	Connected equipment DVD Recorder / VCR with Q-Link connection	Connection
Preset download	○	 <p>● Use fully wired SCART cable. ● Connect the DVD Recorder / VCR supporting Q-Link to the TV's AV1 or AV2 terminal via a SCART cable.</p>
Easy playback	○	
Power on link	○	
Power off link	○	
Direct TV Recording	○	

■ VIERA Link (HDMI connection only)

Features	Connected equipment DIGA Recorder with VIERA Link function	DVD Player / Blu-ray Disc Player with VIERA Link function	HD Video Camera / LUMIX Camera with VIERA Link function
Preset download	○*2	—	—
Easy playback	○	○	○
Power on link	○	○	○
Power off link	○	○	○
Reduce unnecessary power consumption in standby	○*3	○*3	—
Auto standby for unnecessary equipment	○*1	○*1	—
Pause Live TV programme	○*2 *4	—	—
Direct TV Recording	○*2	—	—
Control the menu of the connected equipment by VIERA remote control	○*1	○*1	○*1
Speaker control	—	—	—

Connection

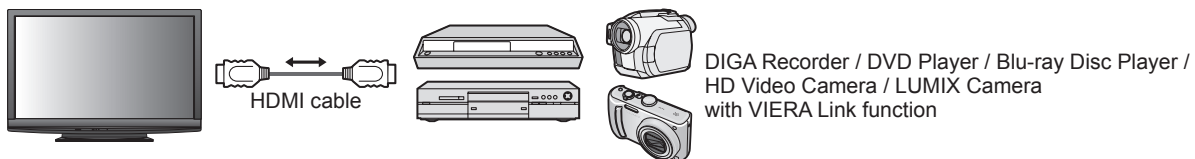

- Use fully wired HDMI compliant cable.
- Connect the equipment supporting VIERA Link to the TV's HDMI1, HDMI2 or HDMI3 terminal via an HDMI cable.
- About HDMI cable for connecting Panasonic HD Video Camera or LUMIX Camera, read the manual of the equipment.

■ VIERA Link (HDMI and SCART connections)

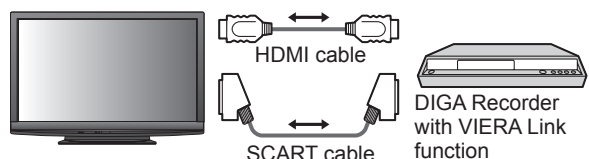
Features	Connected equipment DIGA Recorder with VIERA Link function	Connection
Preset download	○	 <p>● Use fully wired HDMI compliant cable. ● Connect the equipment supporting VIERA Link to the TV's HDMI1, HDMI2 or HDMI3 terminal via an HDMI cable. ● Use fully wired SCART cable. ● Connect the equipment supporting VIERA Link to the TV's AV1 or AV2 terminal via a SCART cable.</p>
Easy playback	○	
Power on link	○	
Power off link	○	
Reduce unnecessary power consumption in standby	○*3	
Auto standby for unnecessary equipment	○*1	
Pause Live TV programme	○*2 *4	
Direct TV Recording	○*2	
Control the menu of the connected equipment by VIERA remote control	○*1	
Speaker control	—	

■ VIERA Link (HDMI and Audio out connections)

Features	Connected equipment	Player theatre with VIERA Link function	Blu-ray Disc theatre with VIERA Link function	Amplifier with VIERA Link function
Preset download		—	—	—
Easy playback		○*5	○*5	—
Power on link		○	○	—
Power off link		○	○	○
Reduce unnecessary power consumption in standby		—	○*3	—
Auto standby for unnecessary equipment		○*1 *6	○*1 *6	○*1
Pause Live TV programme		—	—	—
Direct TV Recording		—	—	—
Control the menu of the connected equipment by VIERA remote control		○*1	○*1	—
Speaker control		○	○	○

Connection

● To use Player theatre / Blu-ray Disc theatre:

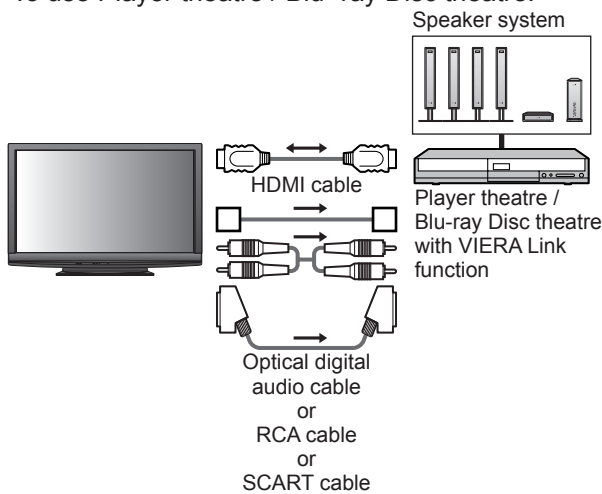

● To use Amplifier:

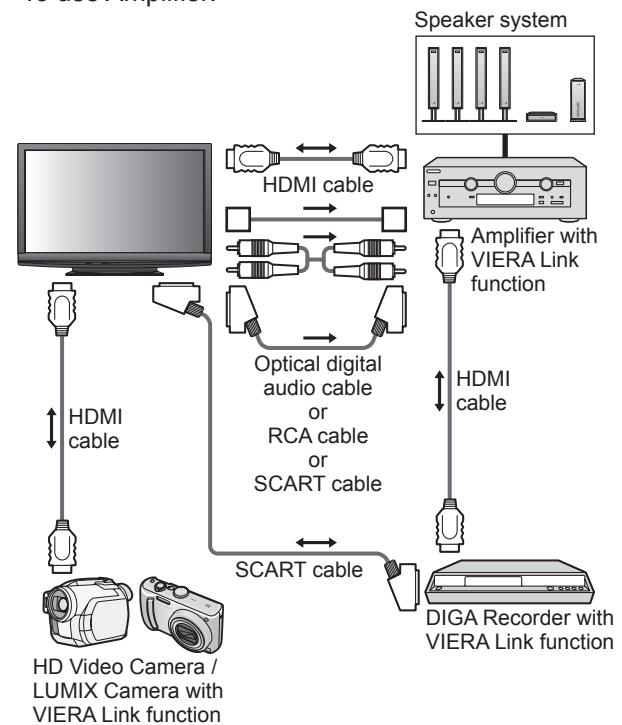

- Use fully wired HDMI compliant cable.
- Connect the equipment supporting VIERA Link to the TV's HDMI1, HDMI2 or HDMI3 terminal via an HDMI cable.
- Use fully wired SCART cable.
- Connect the equipment supporting VIERA Link to the TV's AV1 or AV2 terminal via a SCART cable.
- Use any one of the optical digital audio cable, RCA cable and SCART cable for audio output from the TV.

*1: Available with the equipment which has "HDAVI Control 2 or later" function.

*2: Available with the equipment which has "HDAVI Control 3 or later" function.

*3: Available with the equipment which has "HDAVI Control 4" function.

*4: Available with DIGA Recorder which has HDD.

*5: while playingback a disc

*6: except for watching a disc

Note

- VIERA Link features may be available even with other manufacturers' equipment supporting HDMI CEC.

Link Functions (Q-Link VIERA Link)

Q-Link

■ Preparations

- Connect the DVD Recorder / VCR with the following logos:
“Q-Link”, “NEXTVIEWLINK”, “DATA LOGIC”, “Easy Link”, “Megalogic” or “SMARTLINK”
- Q-Link connection → p. 46
- Use fully wired SCART cable.
- Set up the DVD Recorder / VCR. Read the manual of the recorder.
- Q-Link terminal setup in the Setup Menu → “Q-Link” (p. 28), “AV1 / AV2 out” (p. 28)
- Download preset - channel, language, country / region settings → “Preset download” (see below)

■ Features available

Preset download

Channel, language, country / region settings can be downloaded to the recorder.

- DVB-C channel setting cannot be downloaded.
- To download settings → “Download” (p. 28) or “Auto Setup” (p. 31) or “Auto Setup” - when first using the TV (p. 12)

Direct TV Recording - What you see is What you record

Recording the current programme in DVD Recorder / VCR immediately.



- Available conditions:

Current mode	Using tuner	How to record
Analogue	TV	TV monitor out
	Recorder	Recorder's tuner
DVB	TV	TV monitor out
AV (watching recorder's tuner)	Recorder	Recorder's tuner
AV (watching recorder's external input)	-	Recorder's external input
AV (watching TV's external input)	-	TV monitor out

- When Direct TV Recording is performed, the recorder is automatically turned on if it is in Standby mode.
- Changing channel or turning off the TV is available while the recorder is recording from its own tuner.
- Changing channel is not available while the recorder is recording from the TV tuner.

■ To stop recording

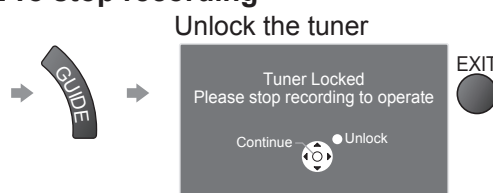

Power on link and Easy playback

Set Power on Link “On” in the Setup Menu to use this function → “Power on Link” (p. 28)

When DVD Recorder / VCR starts playback or direct navigator / function menu for the equipment are activated, the TV is turned on and input mode is switched automatically so that you can view the content. (Only when the TV is in Standby mode.)

Power off link

Set Power off Link “On” in the Setup Menu to use this function → “Power off Link” (p. 28)

When TV is set to Standby mode, the recorder is also automatically set to Standby. (Only when the videocassette or disc is not active.)

- This function will work even if the TV enters standby mode automatically by Off Timer function or auto power standby function.

- “DATA LOGIC” (a trademark of Metz Corporation)
- “Easy Link” (a trademark of Philips Corporation)

- “Megalogic” (a trademark of Grundig Corporation)
- “SMARTLINK” (a trademark of Sony Corporation)

Note

- Some recorders are not applicable. Read the manual of the recorder.

VIERA Link “HDAVI Control™”*

*Enjoy additional HDMI Inter-Operability with Panasonic products which have “HDAVI Control” function. This TV supports “HDAVI Control 4” function.

Connections to the equipment (DIGA Recorder, HD Video Camera, Player theatre, Amplifier, etc.) with HDMI and SCART cables allow you to interface them automatically (p. 46 and p. 47).

These features are limited to models incorporating “HDAVI Control” and “VIERA Link”.

- Some functions are not available depending on the equipment’s version of HDAVI Control. Please confirm the connected equipment’s version of HDAVI Control.
- VIERA Link “HDAVI Control”, based on the control functions provided by HDMI which is an industry standard known as HDMI CEC (Consumer Electronics Control), is a unique function that we have developed and added. As such, its operation with other manufacturers’ equipment that supports HDMI CEC cannot be guaranteed.
- Please refer to individual manuals for other manufacturers’ equipment supporting VIERA Link function.
- About applicable Panasonic equipment, consult your local Panasonic dealer.

■ Preparations

- Connect the equipment supporting VIERA Link.
- VIERA Link connection → p. 46 and p. 47
- Use fully wired HDMI compliant cable. Non-HDMI-compliant cables cannot be utilized.
Recommended Panasonic’s HDMI cable part number:
 - RP-CDHG10 (1.0 m)
 - RP-CDHG15 (1.5 m)
 - RP-CDHG20 (2.0 m)
 - RP-CDHG30 (3.0 m)
 - RP-CDHG50 (5.0 m)
- Use fully wired SCART cable.
- Set up the connected equipment. Read the manual of the equipment.
- For optimal recording, the settings of the recorder may need to be changed. For details, read the manual of the recorder.
- Download preset - channel, language, country / region settings → “Preset download” (see below)
- Set VIERA Link On in the Setup Menu → “VIERA Link” (p. 28)
- Set up the TV
 - **After connection, turn the equipment on and then switch the TV on.**
Select the input mode to HDMI1, HDMI2 or HDMI3 (p. 22), and make sure that an image is displayed correctly.
This setup should be done each time when the following conditions occur:
 - for the first time
 - when adding or reconnecting equipment
 - when changing setup

■ Features available

Preset download

Channel, language, country / region settings can be downloaded to the recorder.

- DVB-C channel setting cannot be downloaded.
- To download settings → “Download” (p. 28) or “Auto Setup” (p. 31) or “Auto Setup” - when first using the TV (p. 12)

Easy playback

Automatic Input switching - When the connected equipment is operated, input mode is switched automatically. When it is stopped operating, input mode is returned.

Power on link

Set Power on Link “On” in the Setup Menu to use this function → “Power on Link” (p. 28)
When the connected equipment starts playback or direct navigator / function menu for the equipment are activated, the TV is automatically turned on. (Only when the TV is in Standby mode.)

Power off link

Set Power off Link “On” in the Setup Menu to use this function → “Power off Link” (p. 28)
When the TV is set to Standby mode, the connected equipment is also automatically set to Standby.

- This function will work even if the TV enters standby mode automatically by Off Timer function or auto power standby function.

Link Functions (Q-Link VIERA Link)

■ Features available

Reduce unnecessary power consumption in standby **Standby Power Save**

Set Standby Power Save “On” in the Setup Menu to use this function

→ “Standby Power Save” (p. 28)

The power consumption in Standby mode of the connected equipment is controlled higher or lower in synchronization with the TV On / Off state to reduce the consumption.

When the TV is set to Standby mode, the connected equipment is automatically set to Standby and the power consumption in Standby mode of the connected equipment is automatically minimized.

When the TV is turned on, the connected equipment is still in Standby mode, but the power consumption is increased to make startup time early.

- This function is effective if the connected equipment can change the power consumption in Standby mode and is set to higher consumption.
- This function will work when “Power off Link” is set to “On”.

Auto standby for unnecessary equipment **Intelligent Auto Standby**

Set Intelligent Auto Standby “On (With reminder)” or “On (No reminder)” in the Setup Menu to use this function

→ “Intelligent Auto Standby” (p. 28)

When the TV is On, non-watched or non-used connected equipment goes into Standby mode automatically to reduce the power consumption. For example, when the input mode is switched from HDMI, when Speaker Selection is changed to “TV” (except for watching a disc).

- If you select “On (With reminder)”, the on screen message will be displayed to be noticed before working this function.
- This function may not work properly depending on the connected equipment. If required, set to “Off”.

■ Features available (Using VIERA Link Menu)

Direct TV Recording - What you see is What you record **Direct TV Rec**

Recording the current programme in DIGA Recorder immediately.

- If you connect a variety of recorders including other manufacturers’ recorders at the same time, please connect DIGA Recorder to the TV’s lower HDMI terminal number. For example, if you use HDMI1 and HDMI2 for two recorders, in this case connect DIGA Recorder to HDMI1.
- If you cannot operate, check the settings and the equipment
 - “Summary of Q-Link and VIERA Link features” (p. 46 and p. 47), “Preparations” (p. 49)
- SCART connection is required to record the DVB-C programme.
- Changing channel or turning off the TV is available while the recorder is recording from its own tuner.
- Changing channel is not available while the recorder is recording from the TV tuner.

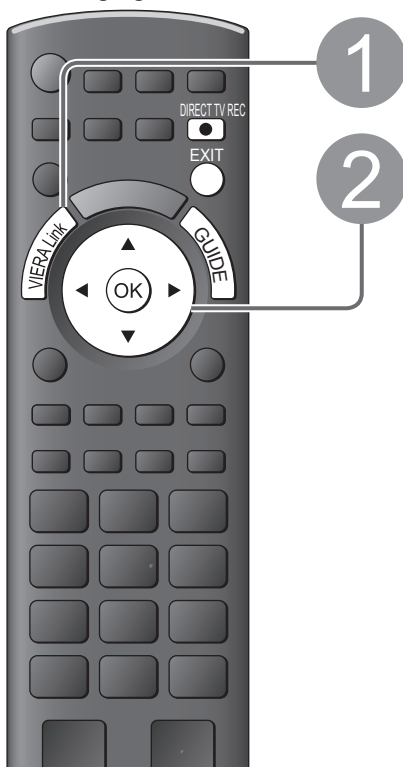

1 Display “VIERA Link Menu”

2 Select “Direct TV Rec” and start recording

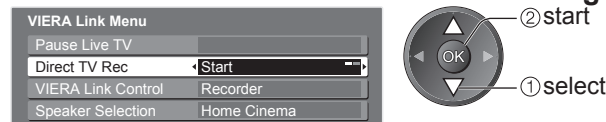

- You can also start recording directly →

■ To stop recording

Select “Stop” in “Direct TV Rec” and access

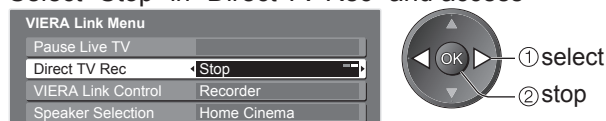

- You can also stop recording directly.

Unlock the tuner

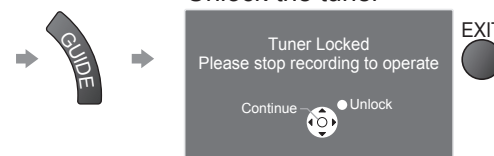

■ Features available (Using VIERA Link Menu)

Pause Live TV programme **Pause Live TV**

You can pause the live TV programme and resume later.

Live TV programme will be recorded on HDD of the connected DIGA Recorder.

- This function is available with DIGA Recorder which has HDD.
- If you connect a variety of recorders including other manufacturers' recorders at the same time, please connect DIGA Recorder which has HDD to the TV's lower HDMI terminal number. For example, if you use HDMI1 and HDMI2 for two recorders, in this case connect DIGA Recorder which has HDD to HDMI1.
- If you cannot operate, check the settings and the equipment
 - ➔ "Summary of Q-Link and VIERA Link features" (p. 46 and p. 47), "Preparations" (p. 49)

Access and pause the live TV programme



1
2

Display "VIERA Link Menu"



Select "Pause Live TV" and pause

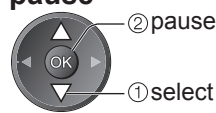
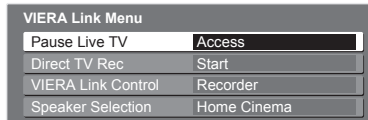

The TV picture will be paused.

- You can also pause directly by using VIERA TOOLS
 - ➔ "How to Use VIERA TOOLS" (p. 41)
- Live TV programme is recorded on HDD from where it was paused.
- If the paused TV picture disappears after a few minutes
 - ➔  (the paused picture will be restored)
- Follow the operation guide to operate Pause Live TV function.

■ **To operate Pause Live TV**

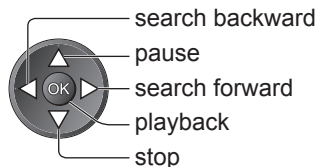

- Operations may be different depending on the recorder. In this case, follow the operation guide or read the manual of the recorder.

- If you stop playback, the recorded programme will be deleted from HDD.

■ **To return to Live TV**

(stop playback of Pause Live TV / cancel pause)

Select "Yes"

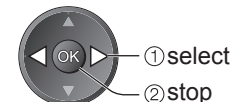
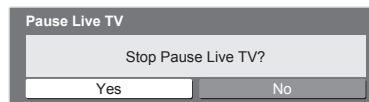

- If you stop playback or cancel pause, the recorded programme will be deleted from HDD.

Link Functions (Q-Link VIERA Link)

■ Features available (Using VIERA Link Menu)

Control the menu of the connected equipment by VIERA remote control

VIERA Link Control

You can control some functions of the connected equipment with this TV remote control (point the remote control at the TV's signal receiver).

- If you cannot operate, check the settings and the equipment
 - ➔ "Summary of Q-Link and VIERA Link features" (p. 46 and p. 47), "Preparations" (p. 49)
- For details of the operations for the connected equipment, read the manual of the equipment.

Access and operate the menu of the equipment



1

Display "VIERA Link Menu"

2

Select "VIERA Link Control"

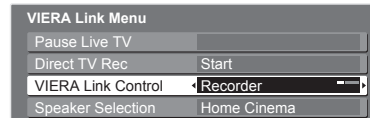

3

Select the equipment you want to access

The type of the connected equipment is displayed. Select the type of the equipment and access.

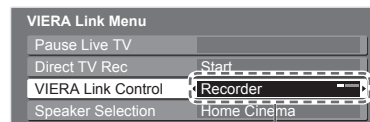

■ If multiple recorders or players are connected

You can connect up to three recorders or players at the same time.

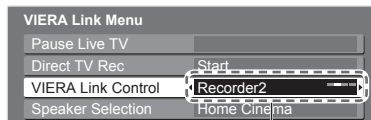

Recorder1-3 / Player1-3

The number is given from the TV's lower HDMI terminal number connected to the same type equipment. For example, two recorders to HDMI2 and HDMI3, in this case the recorder connected to HDMI2 is displayed as "Recorder1", and the recorder connected to HDMI3 is displayed as "Recorder2".

■ If you access non-VIERA Link equipment

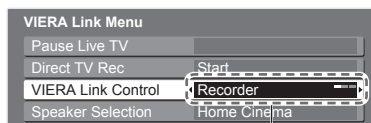

The type of the connected equipment is displayed. You can access the menu of the equipment. But you cannot operate it. Use its own remote control to operate the equipment.

Recorder / Player / Home Cinema / Video Camera / LUMIX / Other

- You can also access directly by using VIERA TOOLS
 - ➔ "How to Use VIERA TOOLS" (p. 41)
- "Home Cinema" means Player theatre, Blu-ray Disc theatre or Recorder theatre.
- "Other" means Tuner set top box.

The menu of the accessed equipment
(Input mode will be changed automatically)

4

Operate the menu of the equipment

Available VIERA remote control buttons:
(depending on the connected equipment)



① Set the position to "TV"



② Follow the operation guide

- To display the operation guide ➔ OPTION
 - If other manufacturers' equipment is accessed, Setup / Contents Selection menu may be displayed.
- When the key words are displayed on colour bar
 - ➔ red green yellow blue

Note

- Some operations may not be available depending on the equipment. In this case use its own remote control to operate the equipment.

■ Features available (Using VIERA Link Menu)

Speaker control **Speaker Selection**

You can control the theatre speaker with this TV remote control (point the remote control at the TV's signal receiver).

- If you cannot operate, check the settings and the equipment
 - ➔ "Summary of Q-Link and VIERA Link features" (p. 46 and p. 47), "Preparations" (p. 49)

Access and control the speaker volume

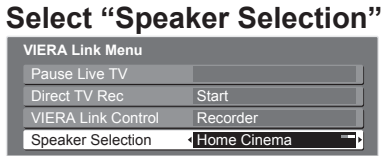
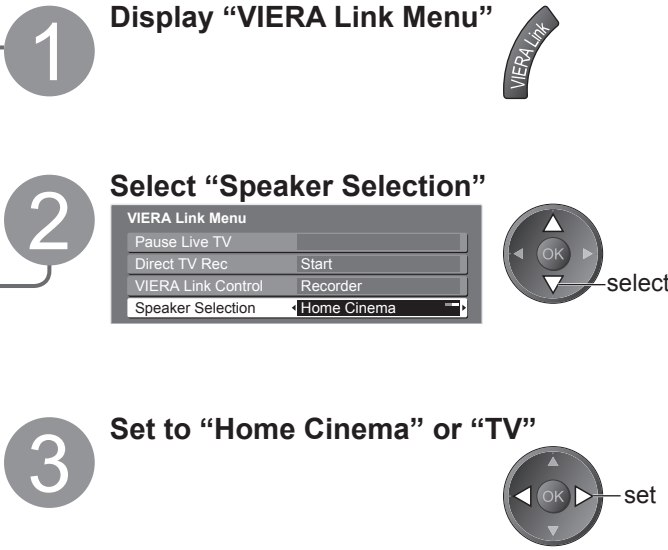
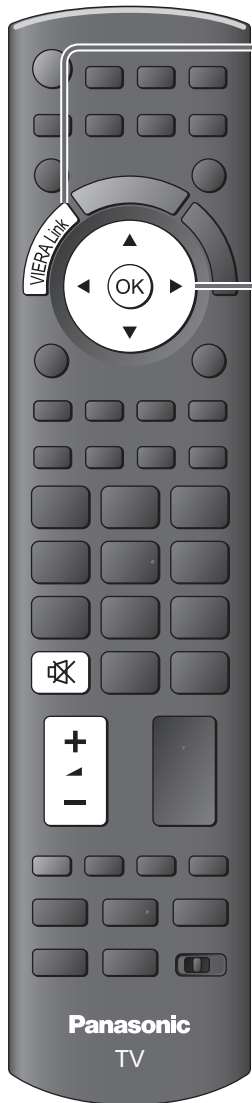

■ **Home Cinema**
 Player theatre, Blu-ray Disc theatre or Amplifier will be automatically turned on if it is in Standby mode and the sound is from theatre speakers connected to the equipment.

- Volume up / down
 ➔ (Volume slide bar will be displayed when adjusting the volume of the equipment.)
- Mute ➔
- The sound of TV speakers is mute.
- When the equipment is turned off, TV speakers will be active.

■ **TV**
 TV speakers are active.

Note

- If you wish to enjoy the multi-channel sound (e.g. Dolby Digital 5.1ch) via an Amplifier, connect with HDMI cable and Optical digital audio cable (p. 47), and then select "Home Cinema". To enjoy the sound from the DIGA Recorder in multi-channel sound, connect an HDMI cable from the DIGA Recorder to the Amplifier (p. 47).

- Note**
- These functions may not work properly depending on the connected equipment.
 - Image or sound may not be available for the first few seconds when Input mode is switched.
 - Easy playback may be available by using the remote control for Player theatre, Blu-ray Disc theatre or Amplifier. Read the manual of the equipment.
 - "HDAVI Control 4" is the newest standard (current as of December, 2008) for HDAVI Control compatible equipment. This standard is compatible with conventional HDAVI equipment.
 - To confirm this TV's version of HDAVI Control ➔ "System Information" (p. 29)

● Link Functions
 (Q-Link / VIERA Link)





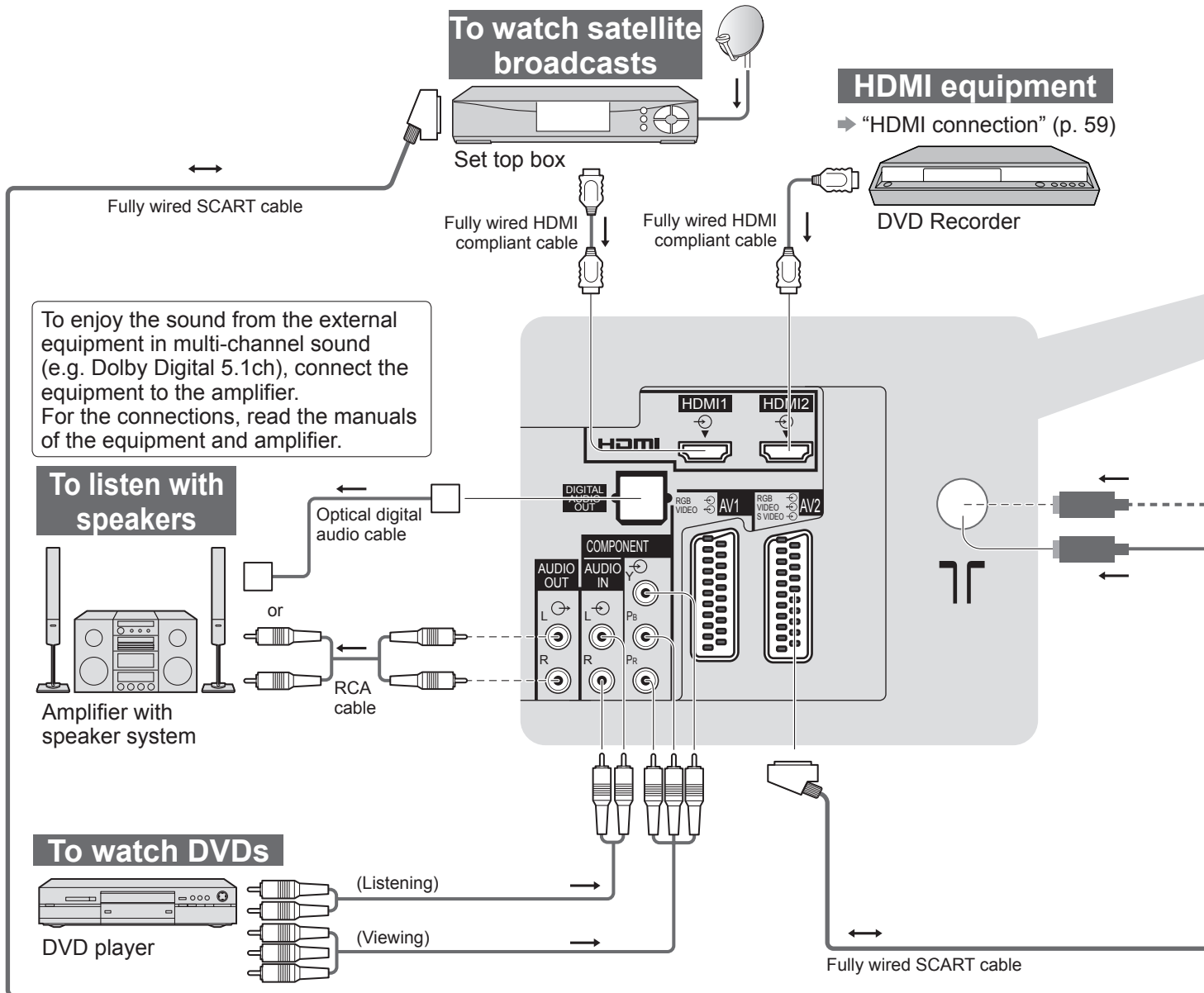

Advanced

External Equipment

These diagrams show our recommendations for connection of your TV to various pieces of equipment. For other connections, consult the instructions for each piece of equipment, the table below, and the specifications (p. 63).



Types of connectable equipment to each terminal

Terminal	AV1	AV2	AV3 (Side panel of TV)	   
Recording / Playback (equipment)				
To record / playback videocassettes / DVDs (VCR / DVD recorder)	<input type="radio"/>	<input type="radio"/>		
To watch DVDs (DVD player)	<input type="radio"/>	<input type="radio"/>	<input type="radio"/>	
To watch camcorder images (Video camera)	<input type="radio"/>	<input type="radio"/>	<input type="radio"/>	
To watch satellite broadcasts (Set top box)	<input type="radio"/>	<input type="radio"/>	<input type="radio"/>	
To play games (Game equipment)	<input type="radio"/>	<input type="radio"/>	<input type="radio"/>	
To use amplifier with speaker system	<input type="radio"/>	<input type="radio"/>		
Q-Link	<input type="radio"/>	<input type="radio"/>		
VIERA Link	<input type="radio"/>	<input type="radio"/>		
Direct TV Recording	<input type="radio"/>	<input type="radio"/>		

○: Recommended Connection

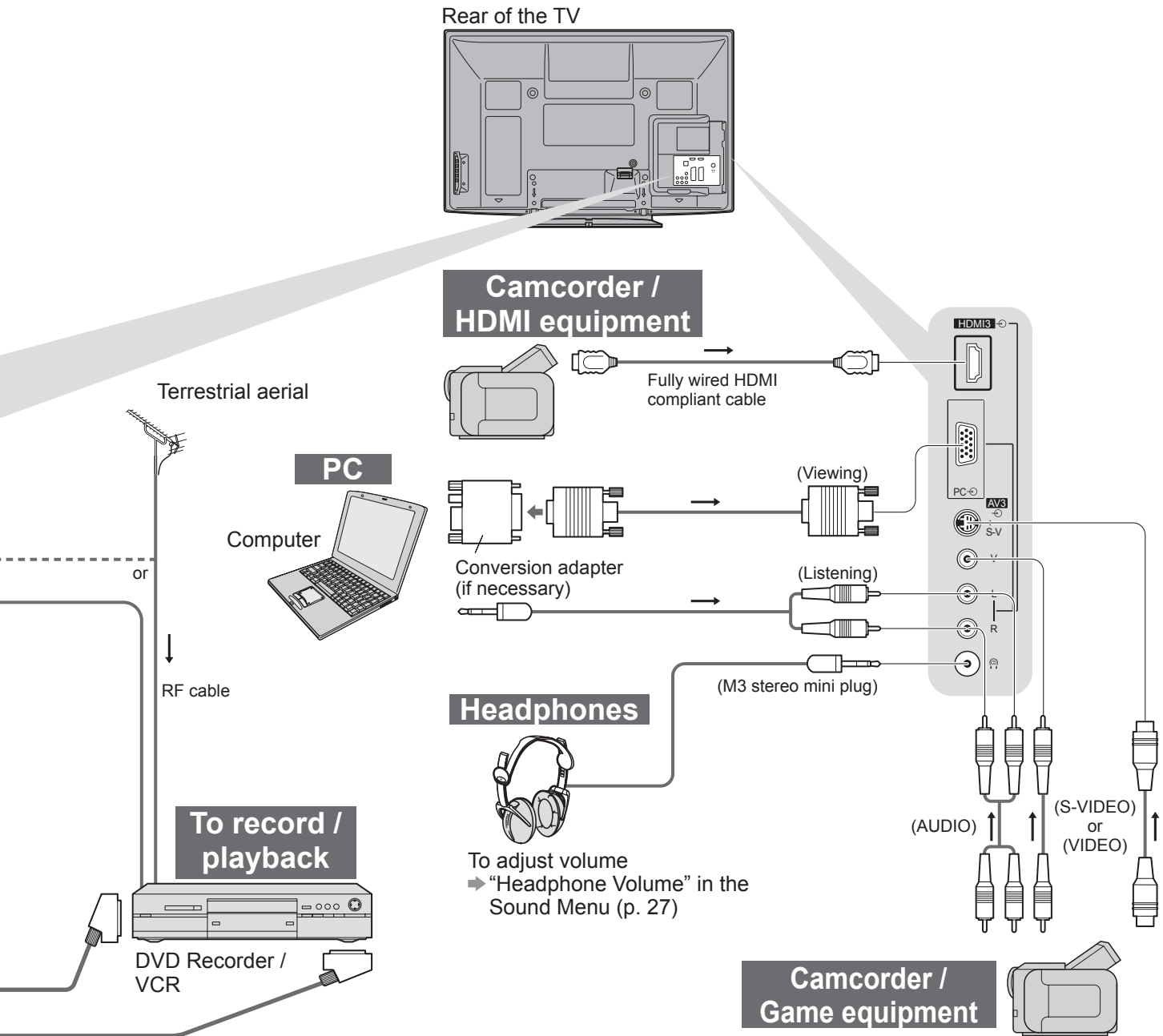

External Equipment

Advanced

COMPONENT	AUDIO OUT	DIGITAL AUDIO OUT	HDMI		
			1	2	3
			<input type="checkbox"/>	<input type="checkbox"/>	<input type="checkbox"/>
<input type="checkbox"/>			<input type="checkbox"/>	<input type="checkbox"/>	<input type="checkbox"/>
			<input type="checkbox"/>	<input type="checkbox"/>	<input type="checkbox"/>
	<input type="checkbox"/>	<input type="checkbox"/>			
			<input type="checkbox"/>	<input type="checkbox"/>	<input type="checkbox"/>
			<input type="checkbox"/>	<input type="checkbox"/>	<input type="checkbox"/>

Technical Information

Auto Aspect

The optimum size and aspect can be chosen automatically, and you can enjoy finer images. (p. 16)

■ Aspect Control Signal

“WIDE” will appear in the top left of the screen if a Widescreen signal (WSS) or a Control signal through SCART / HDMI terminal is found.

The aspect will switch to the appropriate 16:9 or 14:9 widescreen ratio.

This function will work in any aspect mode.

Input terminal	Input signal format	Aspect Control Signal	
		Widescreen signal (WSS)	Control signal through SCART (pin8) / HDMI terminal
RF Cable	DVB-T	○	
	PAL B, G, H, I	○	
	PAL D, K	○	
	SECAM B, G	○	
	SECAM L, L'	○	
	SECAM D, K	○	
	PAL 525/60 6.5 MHz	—	
	PAL 525/60 6.0 MHz	—	
	PAL 525/60 5.5 MHz	—	
	M.NTSC 6.5 MHz	—	
	M.NTSC 6.0 MHz	—	
	M.NTSC 5.5 MHz	—	
DVB-C	○		
AV1 (Composite) AV2 (Composite or S-Video) AV3	PAL	○	○
	SECAM	○	○
	PAL 525/60	—	○
	M.NTSC	—	○
	NTSC	—	○
COMPONENT	525 (480) / 60i	—	
	525 (480) / 60p	—	
	625 (576) / 50i	○	
	625 (576) / 50p	○	
	750 (720) / 60p	—	
	750 (720) / 50p	—	
	1,125 (1,080) / 60i	—	
	1,125 (1,080) / 50i	—	
HDMI1 HDMI2 HDMI3	525 (480) / 60i	—	○
	525 (480) / 60p	—	○
	625 (576) / 50i	—	○
	625 (576) / 50p	—	○
	750 (720) / 60p	—	○
	750 (720) / 50p	—	○
	1,125 (1,080) / 60i	—	○
	1,125 (1,080) / 50i	—	○
	1,125 (1,080) / 60p	—	○
	1,125 (1,080) / 50p	—	○
1,125 (1,080) / 24p	—	○	

■ Auto mode

Auto mode determines the best aspect ratio to fill the screen. It does this using a four step process (WSS, Control signal through SCART / HDMI terminal, Letterbox detection, or Justify to fill the screen) to determine. This process may take several minutes, depending on the darkness of the image.

Letterbox detection: If black bands at the top and bottom of the screen are detected, Auto mode chooses the best ratio and expands the image to fill the screen.

If no aspect signals are detected, Auto mode enhances the image for optimum viewing pleasure.

Note

- The ratio varies depending on the programme, etc. If the ratio is out of the standard 16:9, black bands at the top and bottom of the screen may appear.
- If the screen size looks unusual when a widescreen-recorded programme is played back on a VCR, adjust the tracking of the VCR. Read the manual of the VCR.

SD Card

■ Cautions in handling SD Card

- Do not remove the card while the TV is accessing data (this can damage card or TV).
- Do not touch the pins on the back of the card.
- Do not subject the card to a high pressure or impact.
- Insert the card in the correct direction (otherwise, card may be damaged).
- Electrical interference, static electricity, or erroneous operation may damage the data or card.
- Back up the recorded data at regular intervals in case of deteriorated or damaged data or erratic operation of the TV. (Panasonic is not liable for any deterioration or damage of recorded data.)

■ Data format for Card browsing

- Photo: Still images recorded with digital still cameras compatible with JPEG files of DCF* and EXIF standards
Data format - Baseline JPEG (Sub-sampling 4:4:4, 4:2:2 or 4:2:0)
Max. number of files - 9,999
Image resolution - 160 × 120 to 10,000,000
- Movie: SD-Video Standard Ver. 1.2 [MPEG-2 (PS format)] and AVCHD Standard compatible files with an audio format that is either MPEG-1/Layer-2 format or Dolby Digital format
(A modified data with a PC may not be displayed correctly.)
- Compliant card type (maximum capacity): SDHC Card (32 GB), SD Card (2 GB), miniSD Card (2 GB)
(requiring miniSD adapter)
- If miniSD Card is used, insert / remove it together with the adapter.
- Check the latest information on the card type at the following website. (English only)
<http://panasonic.co.jp/pavc/global/cs/>

*DCF (Design rule for camera file system): Unified standard established by Japan Electronics and Information Technology Industries Association (JEITA).

Note

- Format the card with the recording equipment.
- The picture may not appear correctly on this TV depending on the recording equipment used.
- Display may take some time when there are many files and folders.
- This function cannot display Motion JPEG and still image not DCF formatted (i.e. TIFF, BMP).
- A data modified with a PC may not be displayed.
- Images imported from a PC must be compatible with EXIF (Exchangeable Image File) 2.0, 2.1, and 2.2.
- Partly degraded files might be displayed at a reduced resolution.
- All ".JPG" extension datas in the card will be read in Photo View Mode.
- The folder and file names may be different depending on the digital camera used.
- Do not use two-byte characters or other special codes.
- The card may become unusable with this TV if the file or folder names are changed.

■ On screen messages

Message	Meaning / Action
Cannot read file	<ul style="list-style-type: none"> ● The file is broken or unreadable. ● The TV does not support the format. (For the applicable formats and data, see above.)
No SD card inserted	<ul style="list-style-type: none"> ● Confirm SD Card is inserted correctly.
No valid file to play	<ul style="list-style-type: none"> ● The card has no data.
Over 9999 pictures found (max. is 9999)	<ul style="list-style-type: none"> ● Maximum valid number of photos is 9,999.
Please confirm the SD card is OK	<ul style="list-style-type: none"> ● The inserted SD Card has a problem.
This operation is not possible	<ul style="list-style-type: none"> ● Your operation is not available.

Technical Information

Characters table for numeric buttons

You can enter characters by using numeric buttons for free input items.

Press the numeric button repeatedly until you reach the desired character.

- 1 2 3 • The character is set automatically if you leave for one second.
- 4 5 6 • You can also set the character by pressing the OK button or other numeric buttons within one second.
- 7 8 9
- 0



Characters table:

Numeric buttons	The number of times to press										
	1	2	3	4	5	6	7	8	9	10	11
1	.	1	!	:	#	+	-	*	_	()
2	a	b	c	2	A	B	C				
3	d	e	f	3	D	E	F				
4	g	h	i	4	G	H	I				
5	j	k	l	5	J	K	L				
6	m	n	o	6	M	N	O				
7	p	q	r	s	7	P	Q	R	S		
8	t	u	v	8	T	U	V				
9	w	x	y	z	9	W	X	Y	Z		
0	Space	0									

SCART, S-VIDEO and HDMI terminal information

AV1 SCART terminal (RGB, VIDEO, Q-Link)

Suitable inputs for AV1 include RGB (Red / Green / Blue).

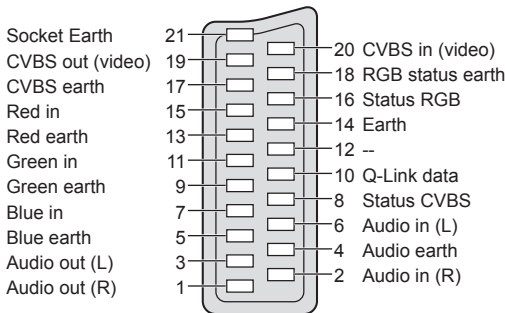

AV2 SCART terminal (RGB, VIDEO, S-VIDEO, Q-Link)

AV2 - Pins 15 and 20 are dependent on AV2 S-VHS / VIDEO switching.

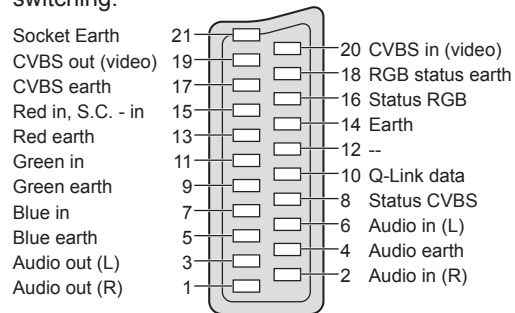

AV3 S-VIDEO 4 pin terminal

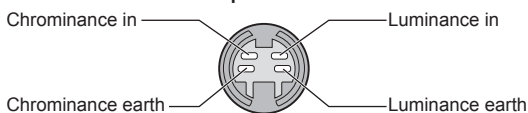

HDMI terminal

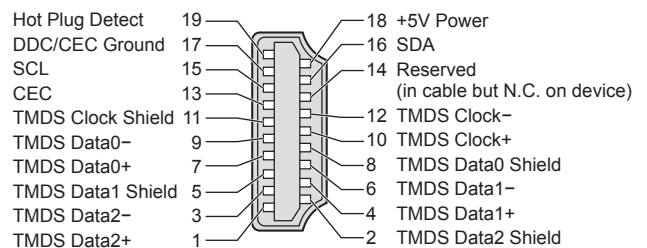

HDMI connection

HDMI (high-definition multimedia interface) is the world's first complete digital consumer AV interface complying with a non-compression standard.

HDMI allows you to enjoy high-definition digital images and high-quality sound by connecting the TV and the equipment.

HDMI-compatible equipment (*1) with an HDMI or DVI output terminal, such as a set top box or a DVD player, can be connected to the HDMI terminal using an HDMI compliant (fully wired) cable.

About connections, see "External Equipment" (p. 54).

■ Applicable HDMI features

- Input audio signal : 2ch Linear PCM (sampling frequencies - 48 kHz, 44.1 kHz, 32 kHz)
- Input video signal : 480i, 480p, 576i, 576p, 720p, 1080i and 1080p
 - ➔ "Input signal that can be displayed" (p. 60)
 - Match the output setting of the digital equipment.
- Input PC signal : ➔ "Input signal that can be displayed" (p. 60)
 - Match the output setting of the PC.
- VIERA Link (HDAVI Control 4): ➔ "VIERA Link" (p. 49)
- x.v.Colour™

■ DVI connection

If the external equipment has only a DVI output, connect to the HDMI1 / 3 terminal via a DVI to HDMI adapter cable (*2).

When the DVI to HDMI adapter cable is used, connect the audio cable to the audio input terminal (HDMI1: use COMPONENT-AUDIO terminals / HDMI3: use AV3 audio terminals).

Note

- Audio settings can be made on the "HDMI1 / 3 Input" in the Sound Menu. (p. 27)
- HDMI2 terminal is for digital audio signal only.
- If the connected equipment has an aspect adjustment function, set the aspect ratio to "16:9".
- These HDMI connectors are "type A".
- These HDMI connectors are compatible with HDCP (High-Bandwidth Digital Content Protection) copyright protection.
- An equipment having no digital output terminal may be connected to the input terminal of either "COMPONENT", "S-VIDEO", or "VIDEO" to receive analogue signals.
- This TV incorporates HDMI™ (Version 1.3a with x.v.Colour™) technology.

(*1): The HDMI logo is displayed on HDMI-compliant equipment.

(*2): Enquire at your local digital equipment retailer shop.

PC connection

A PC may be connected to this TV so that the PC screen is displayed and sound is heard from the TV.

- PC signals that can be inputted: Horizontal scanning frequency 31 to 69 kHz; vertical scanning frequency 59 to 86 Hz (more than 1,024 signal lines could result in incorrect display of the image).
- A PC adapter is not necessary for the DOS/V-compliant D-sub 15-pin connector.

Note

- Some PC models cannot be connected to this TV.
- When using PC, set the colour display quality of PC to the highest position.
- For details of the applicable PC signals
 - ➔ "Input signal that can be displayed" (p. 60)
- Max. display resolution

Aspect	4:3	1,440 × 1,080 pixels
	16:9	1,920 × 1,080 pixels

- D-sub 15-pin connector signal

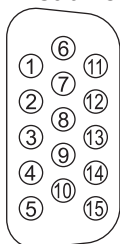

Pin No.	Signal Name	Pin No.	Signal Name	Pin No.	Signal Name
①	R	⑥	GND (Ground)	⑪	NC (not connected)
②	G	⑦	GND (Ground)	⑫	NC (not connected)
③	B	⑧	GND (Ground)	⑬	HD
④	NC (not connected)	⑨	NC (not connected)	⑭	VD
⑤	GND (Ground)	⑩	GND (Ground)	⑮	NC (not connected)

Technical Information

Input signal that can be displayed

COMPONENT (Y, P_B, P_R), HDMI

* Mark: Applicable input signal

Signal name	COMPONENT	HDMI
525 (480) / 60i	*	*
525 (480) / 60p	*	*
625 (576) / 50i	*	*
625 (576) / 50p	*	*
750 (720) / 60p	*	*
750 (720) / 50p	*	*
1,125 (1,080) / 60i	*	*
1,125 (1,080) / 50i	*	*
1,125 (1,080) / 60p		*
1,125 (1,080) / 50p		*
1,125 (1,080) / 24p		*

PC (from D-sub 15P)

Applicable input signal for PC is basically compatible to VESA standard timing.

Signal name	Horizontal frequency (kHz)	Vertical frequency (Hz)
640 × 400 @70 Hz	31.47	70.07
640 × 480 @60 Hz	31.47	59.94
640 × 480 @75 Hz	37.50	75.00
800 × 600 @60 Hz	37.88	60.32
800 × 600 @75 Hz	46.88	75.00
800 × 600 @85 Hz	53.67	85.06
852 × 480 @60 Hz	31.44	59.89
1,024 × 768 @60 Hz	48.36	60.00
1,024 × 768 @70 Hz	56.48	70.07
1,024 × 768 @75 Hz	60.02	75.03
1,024 × 768 @85 Hz	68.68	85.00
1,280 × 768 @60 Hz	47.70	60.00
1,280 × 1,024 @60 Hz	63.98	60.02
1,366 × 768 @60 Hz	48.39	60.04
Macintosh13" (640 × 480)	35.00	66.67
Macintosh16" (832 × 624)	49.73	74.55
Macintosh21" (1,152 × 870)	68.68	75.06

PC (from HDMI terminal)

Applicable input signal for PC is basically compatible to HDMI standard timing.

Signal name	Horizontal frequency (kHz)	Vertical frequency (Hz)
640 × 480 @60 Hz	31.47	60.00
750 (720) / 60p	45.00	60.00
1,125 (1,080) / 60p	67.50	60.00

Note

- Signals other than above may not be displayed properly.
- The above signals are reformatted for optimal viewing on your display.
- PC signal is magnified or compressed for display, so that it may not be possible to show fine detail with sufficient clarity.

FAQs

Before requesting service or assistance, please follow these simple guides to resolve the problem. If the problem still persists, please contact your local Panasonic dealer for assistance.

White spots or shadow images (noise)

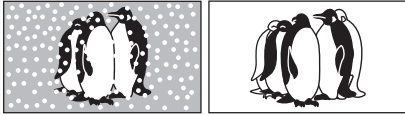

- Check the position, direction, and connection of the aerial.

Neither image nor sound is produced

- Is the TV in AV mode?
- Check the correct AV input mode is selected.
- Check the mains lead is plugged into the socket outlet.
- Has the TV been turned On?
- Check the Picture Menu (p. 26) and volume.
- Check all required SCART cables and connections are firmly in place.

Auto aspect

- Auto aspect is designed to provide you with the best ratio to fill the screen. (p. 56)
- Press the ASPECT button if you would like to change the aspect ratio manually (p. 16).

S-Video / black and white picture

- Check that the output of the external equipment matches the input of the TV. If the output of the external equipment is set to S-Video, the TV must also be set to S-Video (p. 22).

No programmes shown on TV Guide

- Check the digital transmitter.
- Adjust the direction of the aerial to another transmitter installed nearby.
- Check the analogue broadcast. If the image quality is poor, check the aerial and consult your nearest dealer.

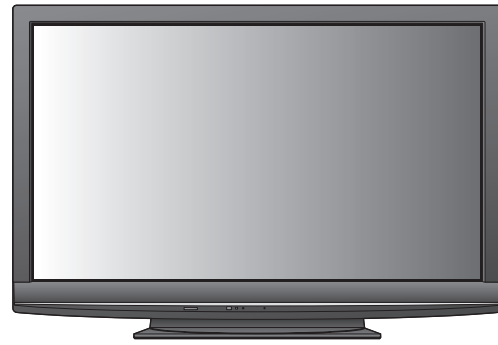

Remains channel number, input mode, etc. on the TV screen -i.e. EC/AV1

- Press the **i** button to clear these. Press again to redisplay.

Q-Link function does not work

- Confirm SCART cable and connection. Also set "AV1 / AV2 out" in the Setup Menu (p. 28).

"VIERA Link" function does not work and an error message appears

- Confirm the connection. (p. 46 and p. 47)
- Turn the connected equipment on and then switch the TV on. (p. 49)

Recording does not start immediately

- Check the settings of the recorder. For details, read the manual of the recorder.

Permanently lit spots on screen

- Due to production process involved in this technology this may result in some pixels which are permanently lit or unlit. This is not a malfunction.

Contrast is reduced

- Contrast is lowered in the following conditions without any user operation for a few minutes:
 - no signal in DVB or AV mode
 - selected locked channel
 - selected invalid channel
 - selected radio channel
 - displayed menu
 - Thumbnail, list or still picture in SD Card mode

FAQs

	Problem	Actions
Screen	Chaotic image, noisy	<ul style="list-style-type: none"> ● Set "P-NR" in the Picture Menu (to remove noise). (p. 26) ● Check nearby electrical products (car, motorcycle, fluorescent lamp).
	No image can be displayed	<ul style="list-style-type: none"> ● Is "Colour" or "Contrast" in the Picture Menu set to the minimum? (p. 26)
	Blurry or distorted image (no sound or low volume)	<ul style="list-style-type: none"> ● Reset channels. (p. 30 and p. 31)
	Unusual image is displayed	<ul style="list-style-type: none"> ● Turn the TV Off with Mains power On / Off switch, then turn it On again. ● If the problem persists, perform "Shipping Condition" (p. 38).
Sound	No sound is produced	<ul style="list-style-type: none"> ● Is "Sound mute" active? (p. 9) ● Is the volume set to the minimum?
	Sound level is low or sound is distorted	<ul style="list-style-type: none"> ● Sound signal reception may be deteriorated. ● Set "MPX" (p. 27) in the Sound Menu to "Off". (Analogue only)
Digital Channel	<ul style="list-style-type: none"> ● Due to the digital reception technologies involved, quality of the digital signals may be relatively low in some cases, despite good reception of analogue channels. 	
	Interference or frozen / disappearing image in DVB mode	<ul style="list-style-type: none"> ● Check "Signal Condition" (p. 32). If "Signal Quality" or "Signal Strength" are displayed in red, the signal is weak. ● Check aerial or cable. If problem persists, consult your local dealer. ● Weather conditions will affect signal reception (heavy rain, snow, etc.), in particular in poor reception areas. Even during good weather the high pressure can cause poor reception of some channels. ● Turn the TV off with the Mains power On / Off switch, then turn it On again.
	Some channels cannot be tuned	<ul style="list-style-type: none"> ● Check the aerial or cable. ● Consult your local dealer.
HDMI	Sound is unusual	<ul style="list-style-type: none"> ● Set the sound setting of the connected equipment to "2ch L.PCM". ● Check the "HDMI1 / 3 Input" setting in the Sound Menu. (p. 27) ● If digital sound connection has a problem, select analogue sound connection. (p. 59)
	Pictures from external equipment are unusual when the equipment is connected via HDMI	<ul style="list-style-type: none"> ● Check the HDMI cable is connected properly. (p. 54) ● Turn the TV and equipment Off, then turn them On again. ● Check an input signal from the equipment. (p. 60) ● Use an equipment compliant with EIA/CEA-861/861B.
Other	The TV does not switch On	<ul style="list-style-type: none"> ● Check the mains lead is plugged into the socket outlet.
	The TV goes into "Standby mode"	<ul style="list-style-type: none"> ● Off Timer function is activated. ● The TV enters "Standby mode" about 30 mins. after analogue broadcasting ends.
	The remote control does not work or is intermittent	<ul style="list-style-type: none"> ● Are the batteries installed correctly? (p. 6) ● Has the TV been switched On? ● The batteries may be running low. Replace them. ● Point the remote control directly at the front of the TV (within a 30 degree angle of the front of the TV). ● Situate the TV away from sunshine or other sources of bright light not to shine on the TV's remote control signal receiver.
	An error message appears	<ul style="list-style-type: none"> ● Follow the message's instructions. ● If the problem persists, contact the authorized Service Centre.

Specifications

		TX-PF42G10	TX-PF46G10	TX-PF50G10	
Power Source		AC 220-240 V, 50 / 60 Hz			
Power Consumption		340 W	400 W	425 W	
Power Consumption in Standby mode		0.4 W (Without monitor out recording) 17 W (With monitor out recording)			
Display panel	Aspect Ratio	16:9			
	Visible screen size	106 cm (diagonal) 921 mm (W) × 518 mm (H)	117 cm (diagonal) 1,019 mm (W) × 573 mm (H)	127 cm (diagonal) 1,105 mm (W) × 622 mm (H)	
	Number of pixels	2,073,600 (1,920 (W) × 1,080 (H)) [5,760 × 1,080 dots]			
Sound	Speaker	160 mm × 40 mm × 2 pcs, 6 Ω			
	Audio Output	20 W (10 W + 10 W), 10% THD			
	Headphones	M3 (3.5 mm) stereo mini Jack × 1			
PC signals		VGA, SVGA, WVGA, XGA SXGA, WXGA (compressed) Horizontal scanning frequency 31 - 69 kHz Vertical scanning frequency 59 - 86 Hz			
Receiving Systems / Band name		PAL B, G, H, I, SECAM B, G, SECAM L, L' VHF E2 - E12 VHF H1 - H2 (ITALY) VHF A - H (ITALY) UHF E21 - E69 CATV (S01 - S05) CATV S1 - S10 (M1 - M10) CATV S11 - S20 (U1 - U10) CATV S21 - S41 (Hyperband) PAL D, K, SECAM D, K VHF R1 - R2 VHF R3 - R5 VHF R6 - R12 UHF E21 - E69 PAL 525/60 Playback of NTSC tape from some PAL Video recorders (VCR) DVB-T Digital terrestrial services DVB-C Digital cable services M.NTSC Playback from M. NTSC Video recorders (VCR) NTSC (AV input only) Playback from NTSC Video recorders (VCR) ● TV signals may not be received in some areas.			
Aerial input		VHF / UHF			
Operating Conditions		Temperature : 0 °C - 35 °C Humidity : 20 % - 80 % RH (non-condensing)			
Connection Terminals	AV1 (SCART terminal)	21 Pin terminal (Audio/Video in, Audio/Video out, RGB in, Q-Link)			
	AV2 (SCART terminal)	21 Pin terminal (Audio/Video in, Audio/Video out, RGB in, S-Video in, Q-Link)			
	AV3	VIDEO	RCA PIN Type × 1	1.0 V[p-p] (75 Ω)	
		S-VIDEO	Mini DIN 4-pin	Y:1.0 V[p-p] (75 Ω)	C:0.286 V[p-p] (75 Ω)
		AUDIO L - R	RCA PIN Type × 2	0.5 V[rms]	
	COMPONENT	VIDEO	Y	1.0 V[p-p] (including synchronization)	
		AUDIO L - R	P_B, P_R	±0.35 V[p-p]	
	Others	HDMI 1 / 2 / 3	TYPE A Connectors	HDMI™ (Version 1.3a with x.v.Colour™)	
		PC	HIGH-DENSITY D-SUB 15PIN	R,G,B/0.7 V[p-p] (75 Ω)	HD, VD/TTL Level 2.0 - 5.0 V[p-p] (high impedance)
		Card slot	SD Card slot × 1		
Output		AUDIO L - R	RCA PIN Type × 2	0.5 V[rms] (high impedance)	
	DIGITAL AUDIO OUT	PCM / Dolby Digital / DTS, Fiber optic			
Dimensions (W × H × D)		1,029 mm × 704 mm × 334 mm (With Pedestal) 1,029 mm × 661 mm × 106 mm (TV only)	1,132 mm × 767 mm × 401 mm (With Pedestal) 1,132 mm × 722 mm × 106 mm (TV only)	1,218 mm × 814 mm × 401 mm (With Pedestal) 1,218 mm × 769 mm × 106 mm (TV only)	
Mass		28.0 kg Net (With Pedestal) 25.0 kg Net (TV only)	32.0 kg Net (With Pedestal) 29.0 kg Net (TV only)	35.0 kg Net (With Pedestal) 32.0 kg Net (TV only)	

Note

- Design and Specifications are subject to change without notice. Mass and Dimensions shown are approximate.
- This equipment complies with the EMC standards listed below.
EN55013, EN61000-3-2, EN61000-3-3, EN55020, EN55022, EN55024.
- Pedestal: ST-42CS3WG / ST-50CS3WG (For safety approval)

This product is licensed under the AVC patent portfolio license for the personal and non-commercial use of a consumer to (i) encode video in compliance with the AVC Standard ("AVC Video") and/or (ii) decode AVC Video that was encoded by a consumer engaged in a personal and non-commercial activity and/or was obtained from a video provider licensed to provide AVC Video. No license is granted or shall be implied for any other use. Additional information may be obtained from MPEG LA, LLC. See <http://www.mpegla.com>.



Trade Mark of the DVB Digital Video Broadcasting Project (1991 to 1996)
 TX-PF42G10 Declaration of Conformity No. 6373, 8 January 2009
 TX-PF46G10 Declaration of Conformity No. 6374, 8 January 2009
 TX-PF50G10 Declaration of Conformity No. 6375, 8 January 2009

Information for Users on Collection and Disposal of Old Equipment and used Batteries



These symbols on the products, packaging, and/or accompanying documents mean that used electrical and electronic products and batteries should not be mixed with general household waste. For proper treatment, recovery and recycling of old products and used batteries, please take them to applicable collection points, in accordance with your national legislation and the Directives 2002/96/EC and 2006/66/EC.

By disposing of these products and batteries correctly, you will help to save valuable resources and prevent any potential negative effects on human health and the environment which could otherwise arise from inappropriate waste handling.

For more information about collection and recycling of old products and batteries, please contact your local municipality, your waste disposal service or the point of sale where you purchased the items.

Penalties may be applicable for incorrect disposal of this waste, in accordance with national legislation.



For business users in the European Union

If you wish to discard electrical and electronic equipment, please contact your dealer or supplier for further information.

[Information on Disposal in other Countries outside the European Union]

These symbols are only valid in the European Union. If you wish to discard these items, please contact your local authorities or dealer and ask for the correct method of disposal.



Note for the battery symbol (bottom two symbol examples):

This symbol might be used in combination with a chemical symbol. In this case it complies with the requirement set by the Directive for the chemical involved.

Cd

Licence

Even if no special notation has been made of company or product trademarks, these trademarks have been fully respected.

- DVB is a trademark of the DVB Digital Video Broadcasting Project (1991 to 1996).
- VGA is a trademark of International Business Machines Corporation.
- Macintosh is a registered trademark of Apple Inc., USA.
- S-VGA is a registered trademark of the Video Electronics Standard Association.
- SDHC Logo is a trademark.
- HDMI, the HDMI Logo and High-Definition Multimedia Interface are trademarks or registered trademarks of HDMI Licensing LLC.
- HDAVI Control™ is a trademark of Panasonic Corporation.
- "AVCHD" and the "AVCHD" logo are trademarks of Panasonic Corporation and Sony Corporation.
- x.v.Colour™ is a trademark.
- Manufactured under license from Dolby Laboratories.
Dolby and the double-D symbol are trademarks of Dolby Laboratories.
- Manufactured under license under U.S. Patent #: 5,451,942 & other U.S. and worldwide patents issued & pending.
DTS and DTS Digital Out are registered trademarks and the DTS logos and Symbol are trademarks of DTS, Inc.
© 1996-2008 DTS, Inc. All Rights Reserved.
- GUIDE Plus+ is (1) a registered trademark or trademark of, (2) manufactured under license from and (3) subject of various international patents and patent applications owned by, or licensed to, Gemstar-TV Guide International, Inc. and/or its related affiliates.

GEMSTAR-TV GUIDE INTERNATIONAL, INC. AND/OR ITS RELATED AFFILIATES ARE NOT IN ANY WAY LIABLE FOR THE ACCURACY OF THE PROGRAM SCHEDULE INFORMATION PROVIDED BY THE GUIDE PLUS+ SYSTEM. IN NO EVENT SHALL GEMSTAR-TV GUIDE INTERNATIONAL, INC. AND/OR ITS RELATED AFFILIATES BE LIABLE FOR ANY AMOUNTS REPRESENTING LOSS OF PROFITS, LOSS OF BUSINESS, OR INDIRECT, SPECIAL, OR CONSEQUENTIAL DAMAGES IN CONNECTION WITH THE PROVISION OR USE OF ANY INFORMATION, EQUIPMENT, OR SERVICES RELATING TO THE GUIDE PLUS+ SYSTEM.

<http://www.europe.guideplus.com/>



Customer's Record

The model number and serial number of this product may be found on its rear panel. You should note this serial number in the space provided below and retain this book, plus your purchase receipt, as a permanent record of your purchase to aid in identification in the event of theft or loss, and for Warranty Service purposes.

Model Number _____

Serial Number _____

Panasonic Corporation

Web Site : <http://www.panasonic.net>

© Panasonic Corporation 2009

Printed in Czech Republic