



Panasonic®

Operating Instructions Plasma Television

Model No. **TX-P42G10B**
TX-P46G10B
TX-P50G10B

VIERA

VIERA
Link



VIERA
IMAGE VIEWER



with **freesat HD**

DVB®

GUIDEplus+
GEMSTAR



AVCHD™

DOLBY
DIGITAL PLUS



FULL HD
1920x1080p

HD TV
1080p

HDMI™
HIGH-DEFINITION MULTIMEDIA INTERFACE

Please read these instructions before operating your set and retain them for future reference.
The images shown in this manual are for illustrative purposes only.

U.K. Standard

English



TQB0E0796

Features

■ freesat HD tuner built-in

Receives freesat - free digital satellite broadcasts in the UK

This TV has a built-in freesat HD tuner.

freesat is a brand new free digital TV service which broadcasts via satellite so you can receive TV, radio, interactive TV, and HD TV with crystal clear reception.

You can enjoy sharp pictures, vivid colours, multi-channel sound, and various services with the interactive content.

■ Receives DVB digital terrestrial broadcasts

Select the programme or set Timer Programming easily by using TV Guide. (p. 19 and p. 20)

Register and instantly call up favourite channels with Favourites Edit. (p. 39)

● DVB - Digital Video Broadcasting

■ VIERA TOOLS-Display special feature icons for easy accessibility (p. 14)

VIERA TOOLS is the easy way to access the special features with the VIERA TOOLS button.

■ HD TV 1080p

This TV supports high definition TV signals.

■ Sharp pictures with HDMI connection (p. 70)

Enjoy high-definition digital picture and high-quality sound by using an HDMI cable.

● This TV incorporates HDMI™ (Version 1.3a with x.v.Colour™) technology.

■ Dolby Digital Plus decoder

Possible to decode Dolby Digital Plus audio track (multi-channel sound) and output as Dolby Digital multi-channel sound signal from DIGITAL AUDIO OUT terminal.

■ GUIDE Plus+ (p. 19)

This TV supports Gemstar-TV Guide sent from the GUIDE Plus+ system.

■ Owner ID (p. 51)

Owner ID is an anti-theft function. Entering the PIN number and owner's personal information will help the Police to determine the owner.

■ SDHC Card

This TV supports SDHC Card. SDHC is a high storage capacity card (more than 4 GB).

■ AVCHD

Possible to play the moving pictures recorded in SD Card by AVCHD format.

AVCHD is a high definition recording format. (p. 56)

■ SD Card viewer - VIERA IMAGE VIEWER (p. 54 - 56)

Enjoy your photos or movies recorded in SD Card on the TV screen.

■ Links up and controls the connected equipment with "Q-Link" and "VIERA Link" (p. 58 - 65)

Easy recording and playback, create home theatre without complicated settings, etc.

■ Provides suitable images for playing games (p. 30)

Selecting "Game" in Viewing Mode provides fast response to the input signal and you can enjoy playing games.

■ Supports Audio Description signal (p. 16 and p. 31)

This function can add an additional sound track to describe events on-screen (narration) and aids understanding and enjoyment, particularly for visually-impaired viewers.

You can switch Audio Description service Auto or Off, and adjust the volume of the description sound track.

Digital Switchover for Terrestrial broadcasts

Starting in late 2007 and ending in 2012, TV services in the UK will go completely digital, TV region by TV region.

If you have any questions, please call Digital UK on **08456 50 50 50** or visit www.digitaluk.co.uk Digital Switchover will cover a period of several weeks. When it starts you will lose all Analogue TV channels and some Digital TV channels will be missing.

You will need to retune your TV each time this happens to recover your digital channels.

● To retune your TV → "Auto Setup" in "DVB Tuning Menu"-DVB mode (p. 35)

Users of cable or satellite boxes should still retune the TV to continue to receive Freeview channels via their aerial. (Your Analogue channel for viewing Cable or Satellite services will change to a new position.)

- Due to the digital reception technologies involved, quality of the digital signals may be relatively low in some cases, despite good reception of analogue channels.



FULL HD

This TV uses a high definition panel to produce high definition pictures close to their original resolution.



Neo PDP

Realizes high picture quality and energy efficient panel.



VIERA TOUGH PANEL

A front panel increases the durability of the plasma display. This protects against accidental impacts to the screen surface, and also makes cleaning easier.



Intelligent Frame Creation

This increases the frame count and allows natural frame-to-frame transitions, for flicker-less motion images with high resolution.



Over 2,000,000:1 INFINITE BLACK

A wide contrast ratio will deliver pictures with a deep black level and a brighter white level for greater image depth.



0.001 msec Panel Response Time

Extremely fast response time to minimise picture lag.



Eco Mode

Adjusts picture settings automatically dependent on ambient lighting conditions.



V-Audio Surround

Utilises Panasonic's advanced digital amplification technology.



Lead-free display

All VIERA plasma display panels are lead-free. This reduces the impact on the environment when recycling or disposing of them in the future.



Up to 100,000 hours Plasma Panel Lifetime

The Plasma display panel used in the 2009 VIERA TV range is rated for up to 100,000 hours.*

*This measurement is based on the time taken for the brightness of the panel to reduce to half of its maximum level. The time taken to reach this level may vary depending on the image content and the environment where the TV is used. Image retention and malfunctions are not taken into account.



digital tick

The digital tick logo indicates that a digital tuner is built-in.



Freeview

Freeview is the way to enjoy digital TV for free. There are up to 48 digital TV channels.

Turn your living room into a home theatre!

Enjoy rich multi-media

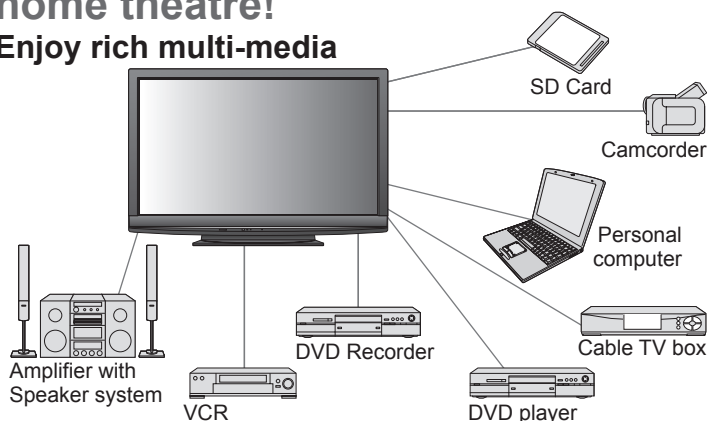

Contents

Be Sure to Read

- Safety Precautions 4
(Warning & Caution)
- Notes 5
- Maintenance 5

Quick Start Guide

- Accessories / Options 6
- Identifying Controls 8
- Basic Connection 10
- Auto Setup 12

Enjoy your TV!

Basic Features

- How to Use VIERA TOOLS 14
- Watching TV 15
- Using TV Guide 18
- Viewing Teletext 21
- Watching External inputs 24
- How to Use Menu Functions 26
(picture, sound quality, etc.)

Advanced Features

- Retuning from Setup Menu 34
- Tuning and Editing Channels (freesat) 36
- Tuning and Editing Channels (DVB) 38
- Tuning and Editing Channels (Analogue) 40
- Tuning and Editing Channels (Other Sat.) 42
- Child Lock 45
- Network Settings 46
- Input Labels 48
- Shipping Condition 49
- Advanced Settings 50
- Recording Controls 52
- Viewing from SD Card 54
(VIERA IMAGE VIEWER)
- Displaying PC Screen on TV 57
- Link Functions 58
(Q-Link / VIERA Link)
- External Equipment 66

FAQs, etc.

- Technical Information 68
- FAQs 73
- On screen messages 76
- Glossary 78
- Licence 78
- Index 78
- Specifications 79

Safety Precautions

Warning & Caution

Handling the mains plug and lead

- Ensure that the mains plug is easily accessible at all times. The On / Off switch on this model does not fully disconnect the TV from the mains supply. Remove the mains plug from the wall socket when the TV is not used for a prolonged period of time.
- Ensure the earth pin on the mains plug is securely connected to prevent electrical shock.
 - An apparatus with CLASS I construction shall be connected to a mains socket outlet with a protective earthing connection.
- Do not use any mains lead other than that provided with this TV. (This may cause fire or electrical shock.)

Do not remove the cover

- Do not remove the rear cover as live parts are accessible when it is removed. There are no user serviceable parts inside.

Do not expose your ears to excessive volume from the headphones

- Irreversible damage can be caused.

Do not expose to direct sunlight and other sources of heat

- Avoid exposing the TV to direct sunlight and other sources of heat. To prevent fire never place any type of candle or naked flame on top or near the TV.

Do not place the TV on sloped or unstable surfaces

- The TV may fall off or tip over.

Power source

- This TV is designed to operate on 220-240 V, 50 / 60 Hz AC.

AC 220-240 V
50 / 60 Hz

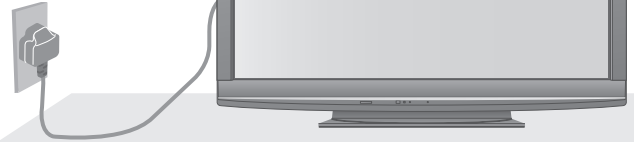

Transport only in upright position

- Transporting the TV with its display panel facing upright or downward may cause damage to the internal circuitry.

The TV is heavy. Handle by 2 or more people. Support as shown to avoid injury by the TV tipping or falling.

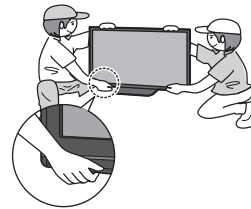

Do not allow children to handle SD Card

- As with a small object, SD Card can be swallowed by young children. Please remove SD Card immediately after use.

IMPORTANT: THE MOULDED MAINS PLUG

FOR YOUR SAFETY, PLEASE READ THE FOLLOWING TEXT CAREFULLY.

This TV is supplied with a moulded three pin mains plug for your safety and convenience. A 10 amp fuse is fitted in this mains plug. Shall the fuse need to be replaced, please ensure that the replacement fuse has a rating of 10 amps and that it is approved by ASTA or BSI to BS1362.

Check for the ASTA mark  or the BSI mark  on the body of the fuse.

If the mains plug contains a removable fuse cover, you must ensure that it is refitted when the fuse is replaced.

If you lose the fuse cover the mains plug must not be used until a replacement cover is obtained.

A replacement fuse cover may be purchased from your local Panasonic dealer.

Do not cut off the mains plug.

Do not use any other type of mains lead except the one supplied with this TV.

The supplied mains lead and moulded plug are designed to be used with this TV to avoid interference and for your safety.

If the socket outlet in your home is not suitable, get it changed by a qualified electrician.

If the plug or mains lead becomes damaged, purchase a replacement from an authorized dealer.

WARNING: – THIS TV MUST BE EARTHED.

How to replace the fuse.

Open the fuse compartment with a screwdriver and replace the fuse.

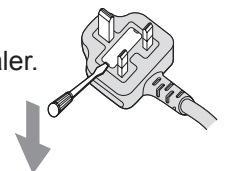

Notes

Do not expose to rain or excessive moisture

- To prevent damage which might result in electric shock or fire, do not expose this TV to rain or excessive moisture.

This TV must not be exposed to dripping or splashing water and objects filled with liquid, such as vases, must not be placed on top of or above the TV.

Do not block the rear ventilation openings

- Ventilation should not be impeded by covering the ventilation openings with items such as newspapers, tablecloths and curtains.

Allow sufficient space around the TV for radiated heat

Minimum distance

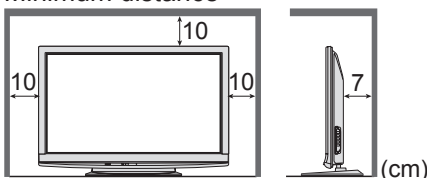

- When using the pedestal, keep the space between the bottom of the TV and the surface where the TV is set.
- In case of using Wall-hanging bracket, follow the manual of it.

Use only the dedicated pedestals / mounting equipment

- Using an unapproved pedestal or other fixtures may make the TV unstable, risking injury. Be sure to ask your local Panasonic dealer to perform setup.
- Use approved pedestals / mounts (p. 6).

Do not display a still picture for a long time

This causes the image to remain on the plasma screen ("image retention").

This is not considered a malfunction and is not covered by the warranty.

Typical still images

- Channel number and other logos
- Image displayed in 4:3 mode
- Video game
- Computer image



To prevent image retention, contrast is lowered automatically after a few minutes if no signals are sent or no operations are performed. (p. 73)

Auto power standby function

- If no signal is received and no operation is performed in Analogue TV mode for 30 minutes, the TV will automatically go to standby mode.

Keep the TV away from these types of equipment

- Electronic equipment
In particular, do not place video equipment near the TV. (Electromagnetic interference may distort images / sound.)
- Equipment with an infrared sensor
This TV also emits infrared rays. (This may affect operation of other equipment.)

Maintenance

First, remove the mains plug from the socket outlet.

Display panel

Regular care: Gently wipe the surface clean of dirt by using a soft cloth.
Major contamination: Wipe the surface clean using a soft cloth dampened with clean water or diluted neutral detergent (1 part detergent to 100 parts water). Then, using a soft dry cloth, evenly wipe the surface clean until it is dry.

Caution

- The surface of the display panel has been specially treated and may be easily damaged.
Do not tap or scratch the surface with your fingernail or other hard object.
- Take care not to subject the surface to insect repellent, solvent, thinner, or other volatile substances (this may degrade surface quality).

Cabinet, Pedestal

Regular care: Wipe the surface clean using a soft dry cloth.
Major contamination: Dampen a soft cloth with clean water or water containing a small amount of neutral detergent. Then, wring the cloth and wipe the surface clean with it. Finally, wipe the surface clean with a dry cloth.

Caution

- Take care not to subject the TV's surfaces to detergent. (A liquid inside the TV could lead to product failure.)
- Take care not to subject surfaces to insect repellent, solvent, thinner, or other volatile substances (this may deteriorate the surface by peeling the paint).
- Do not allow the cabinet and pedestal to make contact with a rubber or PVC substance for a long time.

Mains plug

Wipe the mains plug with a dry cloth at regular intervals. (Moisture and dust may lead to fire or electrical shock.)

Accessories / Options

Standard accessories

- Remote Control
 - N2QAYB000428



Check that you have the accessories and items shown

- Batteries for the Remote Control (2)
 - R6 (UM3)



- Clamper
 - TMME289
 - ➔ p. 8

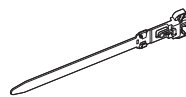

- Mains Lead
 - K2CT3YY00016
 - ➔ p. 10

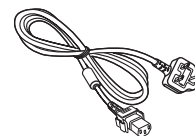

- Operating Instructions

- Ferrite core (2)
 - J0KG00000014

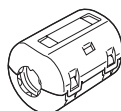

- Cleaning cloth
 - TXFPE01RLTB



- Pedestal
 - TBLX0099
 - TXFBL01DYUU (TX-P42G10B)
 - TBLX0095
 - TXFBL01EQUU (TX-P46G10B)
 - TX-P50G10B
 - ➔ p. 7

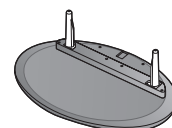

- Pan European Guarantee Card

- CRM (Customer Relationship Management)

- This product contains possibly dangerous parts (such as plastic bags), that can be breathed in or swallowed by young children accidentally. Keep these parts out of reach of young children.

Optional accessories

Please contact your nearest Panasonic dealer to purchase the recommended wall-hanging bracket. For additional details, please refer to the wall-hanging bracket installation manual.

- Wall-hanging bracket
 - TY-WK4P1RW

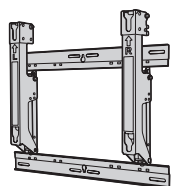

Rear of the TV

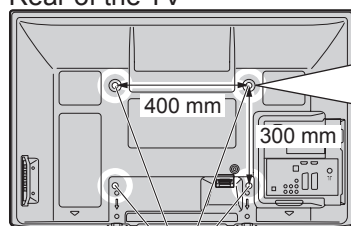

Holes for wall-hanging bracket installation

Screw for fixing the TV onto the wall-hanging bracket (not supplied with the TV)

Depth of screw:
minimum 16 mm, maximum 36 mm

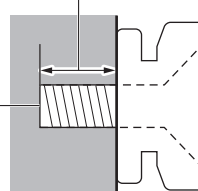

(View from the side)

Caution

- In order to maintain the unit's performance and safety, be absolutely sure to ask your dealer or a licenced contractor to secure the wall-hanging brackets.
- Carefully read the instructions accompanying optional accessories, and be absolutely sure to take steps to prevent the TV from tipping over.
- Handle the TV carefully during installation since subjecting it to impact or other forces may cause product damage.
- Take care when fixing wall brackets to the wall. Always ensure that there are no electrical cables or pipes in the wall before hanging bracket.
- When using the angled-type wall hanging bracket, please ensure that there is sufficient space for the connecting cables not to press against the wall when the TV is tilted forward.
- To prevent fall and injury, remove the TV from its fixed wall position when it is no longer in use.

Installing / removing remote's batteries

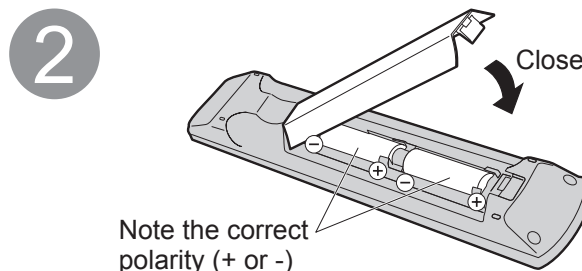
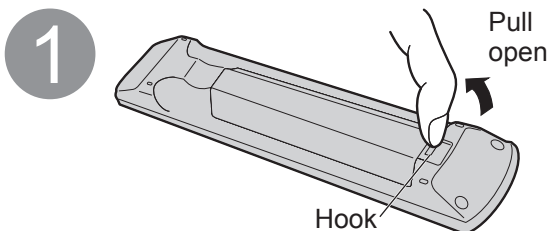

Note the correct polarity (+ or -)

Caution

- Incorrect installation may cause battery leakage and corrosion, resulting in damage to the remote control.
 - Do not mix old and new batteries.
 - Do not mix different battery types (such as alkaline and manganese batteries).
 - Do not use rechargeable (Ni-Cd) batteries.
 - Do not burn or breakup batteries.
- Batteries must not be exposed to excessive heat such as sunshine, fire or the like.

Attaching the pedestal

Warning

Do not disassemble or modify the pedestal.

- Otherwise the TV may fall over and become damaged, and personal injury may result.

Caution

Do not use any other TV and displays.

- Otherwise the TV may fall over and become damaged, and personal injury may result.

Do not use the pedestal if it becomes warped or physically damaged.

- If you use the pedestal while it is physically damaged, personal injury may result. Contact your nearest Panasonic dealer immediately.

During set-up, make sure that all screws are securely tightened.

- If insufficient care is taken to ensure screws are properly tightened during assembly, the pedestal will not be strong enough to support the TV, and it might fall over and become damaged, and personal injury may result.

Ensure that the TV does not fall over.

- If the TV is knocked or children climb onto the pedestal with the TV installed, the TV may fall over and personal injury may result.

Two or more people are required to install and remove the TV.

- If two or more people are not present, the TV may be dropped, and personal injury may result.

A Assembly screw (4)
(silver)

- XYN5+F18FN

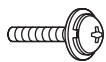

M5 × 18

B Assembly screw (4)
(black)

- THEL062N (TX-P42G10B)
- THEL060N (TX-P46G10B) (TX-P50G10B)

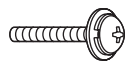

M5 × 25

C Pole (2)

- R: TBLA3689 (TX-P42G10B) TBLA3679 (TX-P46G10B) (TX-P50G10B)
- L: TBLA3690 (TX-P42G10B) TBLA3680 (TX-P46G10B) (TX-P50G10B)

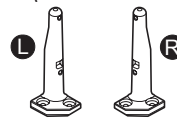

D Base

- TBLX0099 (TX-P42G10B)
- TBLX0095 (TX-P46G10B) (TX-P50G10B)

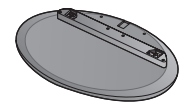

Assembling the pedestal

Use the four assembly screws **A** to fasten the left and right poles to the base securely.

- Make sure that the screws are securely tightened.
- Forcing the assembly screws the wrong way will strip the threads.
- "L" or "R" mark is stamped on the bottom of the pole.

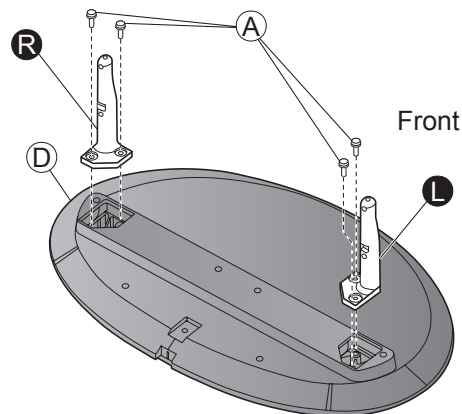

Securing the TV

Use the assembly screws **B** to fasten securely.

- Make sure that the screws are securely tightened.
- Carry out the work on a horizontal and level surface.

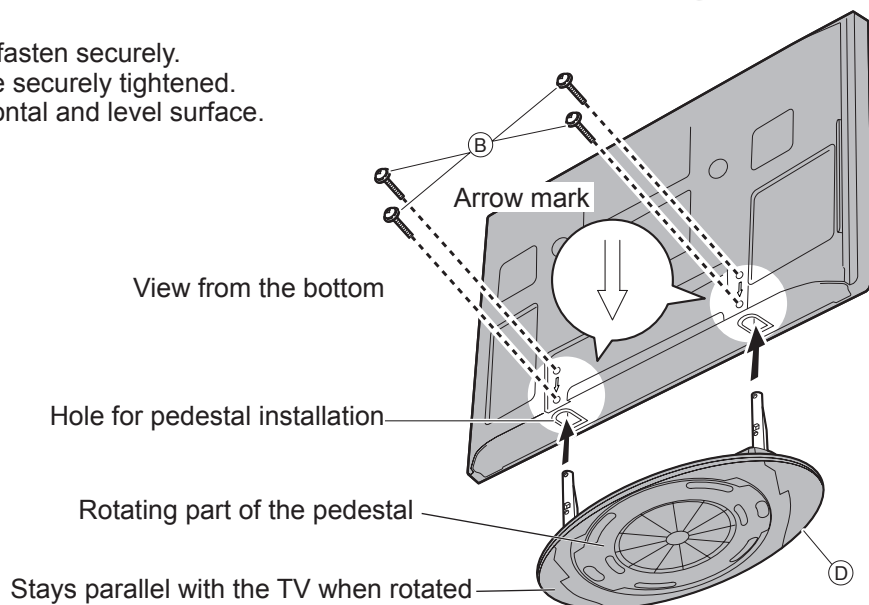

Accessories / Options

Adjust the panel to your desired angle

- Ensure that the pedestal does not hang over the edge of the base even if the TV swivels to the full rotation range.
- Do not place any objects or hands within the full rotation range.

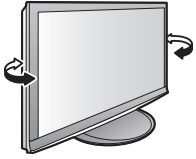

Set the mark at the centre as illustrated, to ensure full degree rotation in either direction.

Note

- Visible part of the pedestal will remain parallel to the TV even when rotated.

- TX-P42G10B
a: 520 mm / b: 354 mm / c: 15°
- TX-P46G10B, TX-P50G10B
a: 528 mm / b: 407 mm / c: 10°

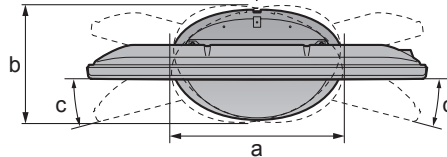

(View from the top)

Using the clammer

Rear of the TV

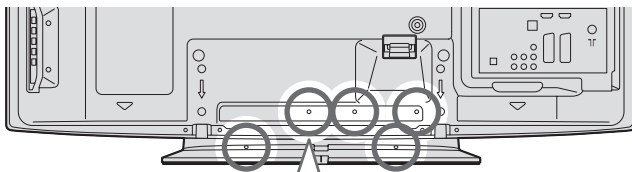

- Do not bundle the RF cable and mains lead together (could cause distorted image).
- Fix cables with clammers as necessary.
- When using the optional accessory, follow the option's assembly manual to fix cables.

■ Attach the clammer

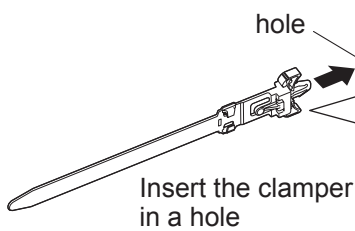

To remove from the TV:

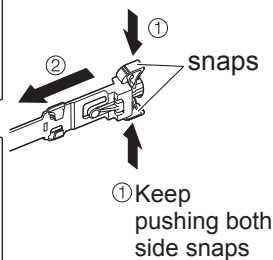

■ Bundle the cables

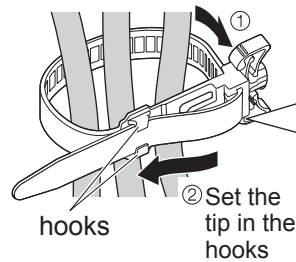

To loosen:

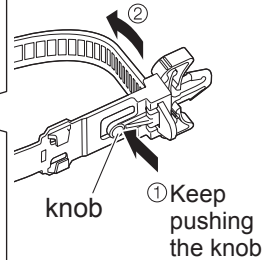

Identifying Controls

TV

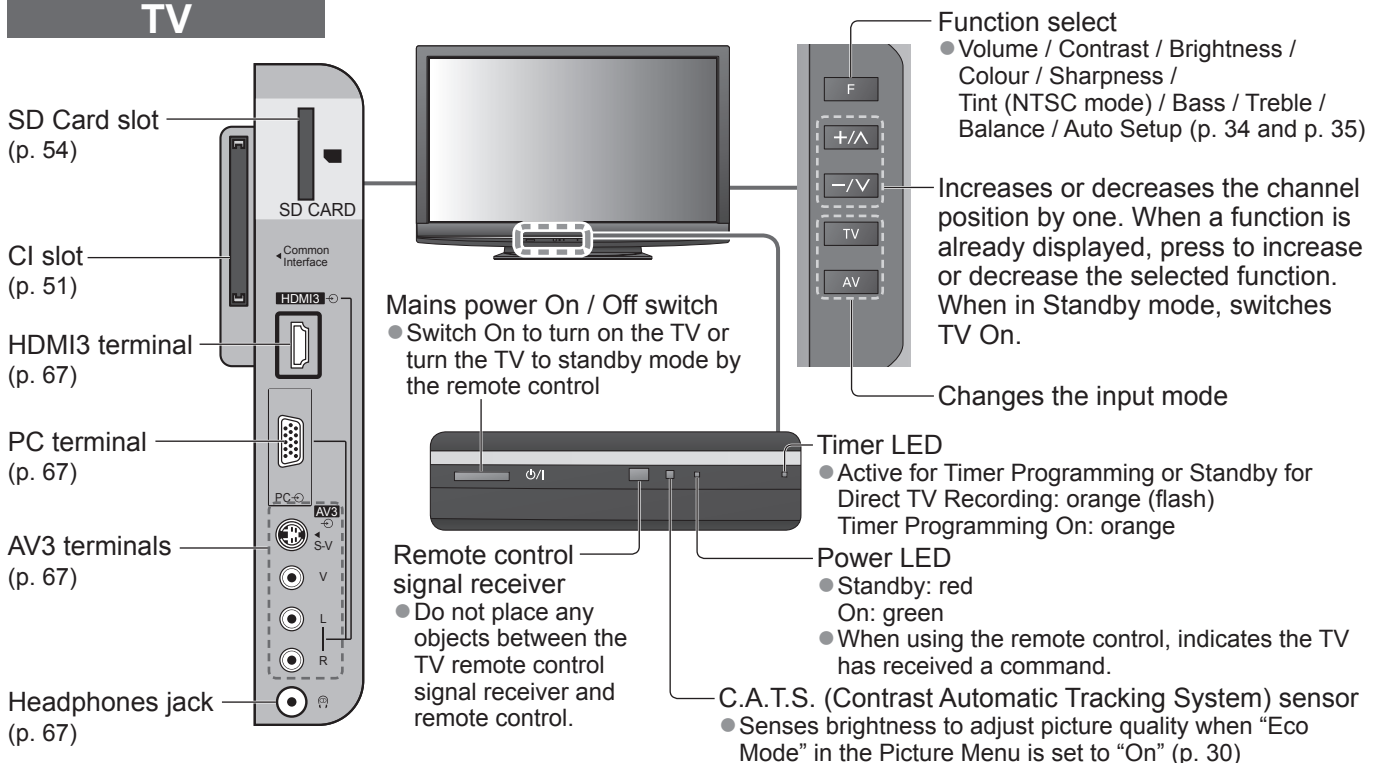

Identifying Controls

Remote Control

VIERA IMAGE VIEWER (p. 54)

- Switches to SD Card viewing mode

Standby On / Off switch

- Switches TV On or Off standby

Aspect (p. 17)

- Changes aspect ratio from Aspect Selection list
- Also possible by pressing this button repeatedly until you reach the desired aspect

Main Menu (p. 26)

- Press to access Picture, Sound and Setup Menus

Channel / Programme Information (p. 16)

- Displays channel and programme information

VIERA Link Menu (p. 62)

- Accesses VIERA Link Menu

OK

- Confirms selections and choices
- Press after selecting channel positions to quickly change channel

Option Menu (p. 17)

- Easy setting for viewing and sound options

Coloured buttons

- Used for the selection, navigation and operation of various functions

Teletext (p. 21)

- Switches to teletext mode / interactive services

Subtitles (p. 16)

- Displays subtitles

Numeric buttons

- Changes channel and teletext pages
- Sets characters
- When in Standby mode, switches TV On

Sound Mute

- Switches sound mute On or Off

Volume Up / Down

Input mode selection

- TV - switches freesat / DVB / Analogue / Other Sat. mode (p. 15)
- AV - switches to AV input mode from Input Selection list (p. 24)

Direct TV Recording (p. 60 and p. 62)

- Records programme immediately in DVD Recorder / VCR with Q-Link or VIERA Link connection

Normalise (p. 26)

- Resets picture and sound settings to their default levels

Exit

- Returns to the normal viewing screen

VIERA TOOLS (p. 14)

- Displays some special feature icons and accesses easily

Guide (p. 18)

- Displays TV Guide

Cursor buttons

- Makes selections and adjustments

Return

- Returns to the previous menu / page

Hold

- Freeze / unfreeze picture (p. 15)
- Holds the current teletext page (teletext mode) (p. 22)

Index (p. 23)

- Returns to the teletext index page (teletext mode)

Surround (p. 31)

- Switches Surround sound

Channel Up / Down

- Selects channel in sequence

Connected equipment operations (p. 25 and p. 64)



Basic Connection

External equipment and cables shown are not supplied with this TV.
Please ensure that the unit is disconnected from the mains socket before attaching or disconnecting any leads.
When disconnecting the mains lead, be absolutely sure to disconnect the mains plug at the socket outlet first.

Example 1 Connecting dish or aerial

TV only

Rear of the TV

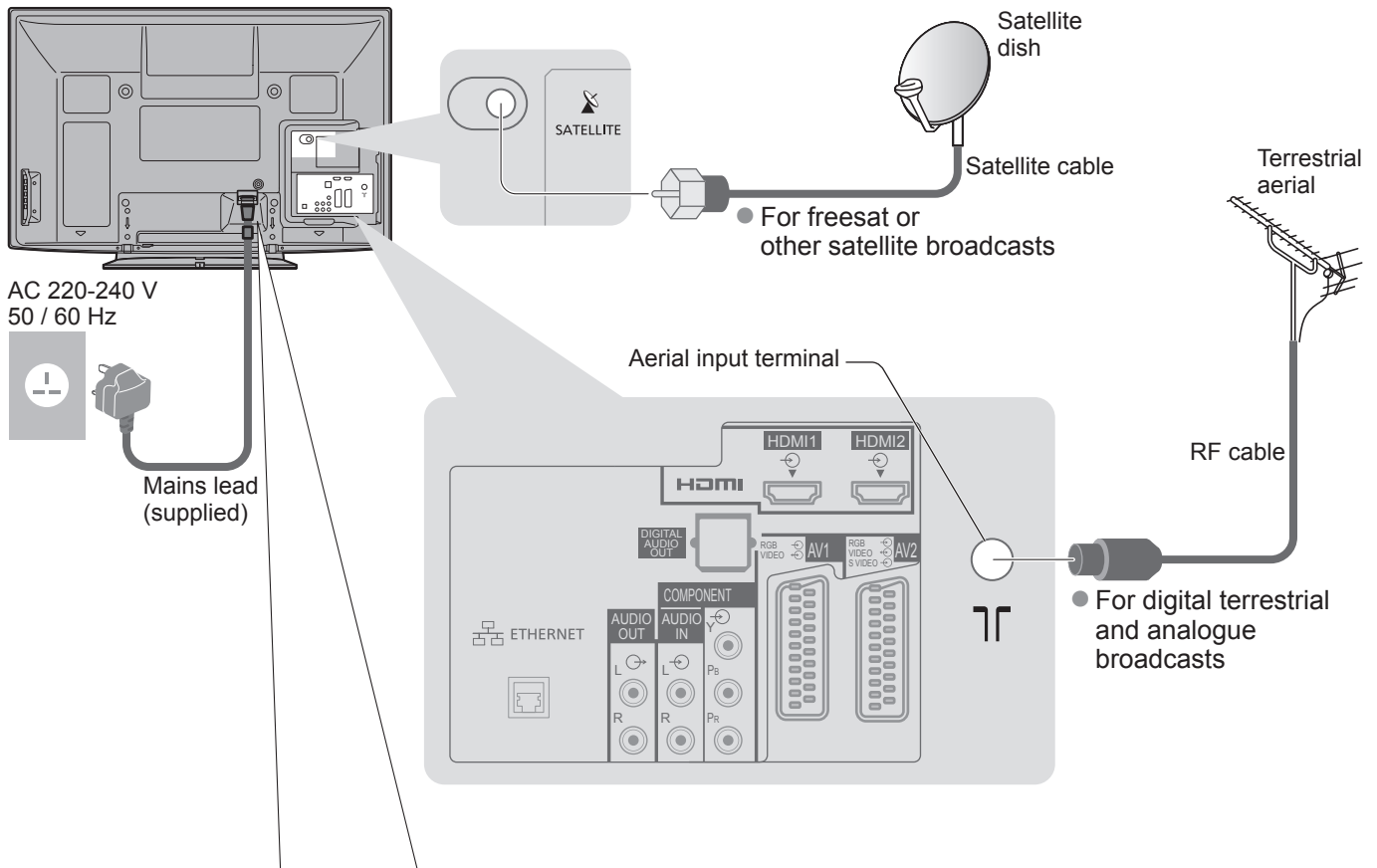

① Push until both side tabs click

② Make sure that the mains lead is securely fixed.

• To remove from the TV:

① Press both tabs and pull on mains connector to release

②

tabs

Note

- The freesat channel uses Astra 2 at 28.2° East, and Eurobird 1 at 28.5° East satellites. To ensure your satellite dish is correctly installed please consult your freesat registered dealer.
- Connect to the TV's AV2 for a DVD Recorder / VCR supporting Q-Link (p. 60).
- Connect to the TV's AV1 for a Cable TV box.
- For HDMI-compatible equipment, possible to connect to HDMI terminals (HDMI1 / HDMI2 / HDMI3) by using HDMI cable (p. 66).
- Q-Link connection → p. 58
- VIERA Link connection → p. 58 and p. 59
- Read the manual of the equipment too.

Example 2 Connecting DVD Recorder / VCR

TV, DVD Recorder or VCR

Rear of the TV

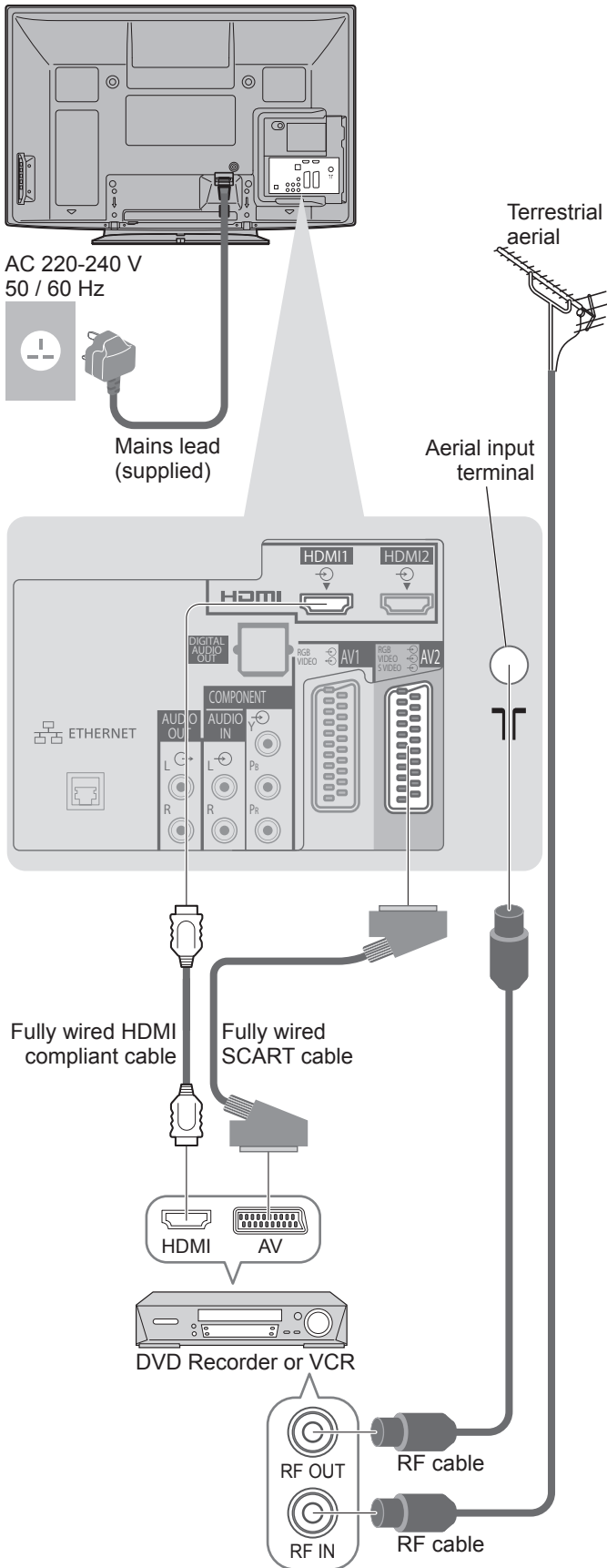

Example 3 Connecting DVD Recorder / VCR and Cable TV box

TV, DVD Recorder / VCR and Cable

Rear of the TV

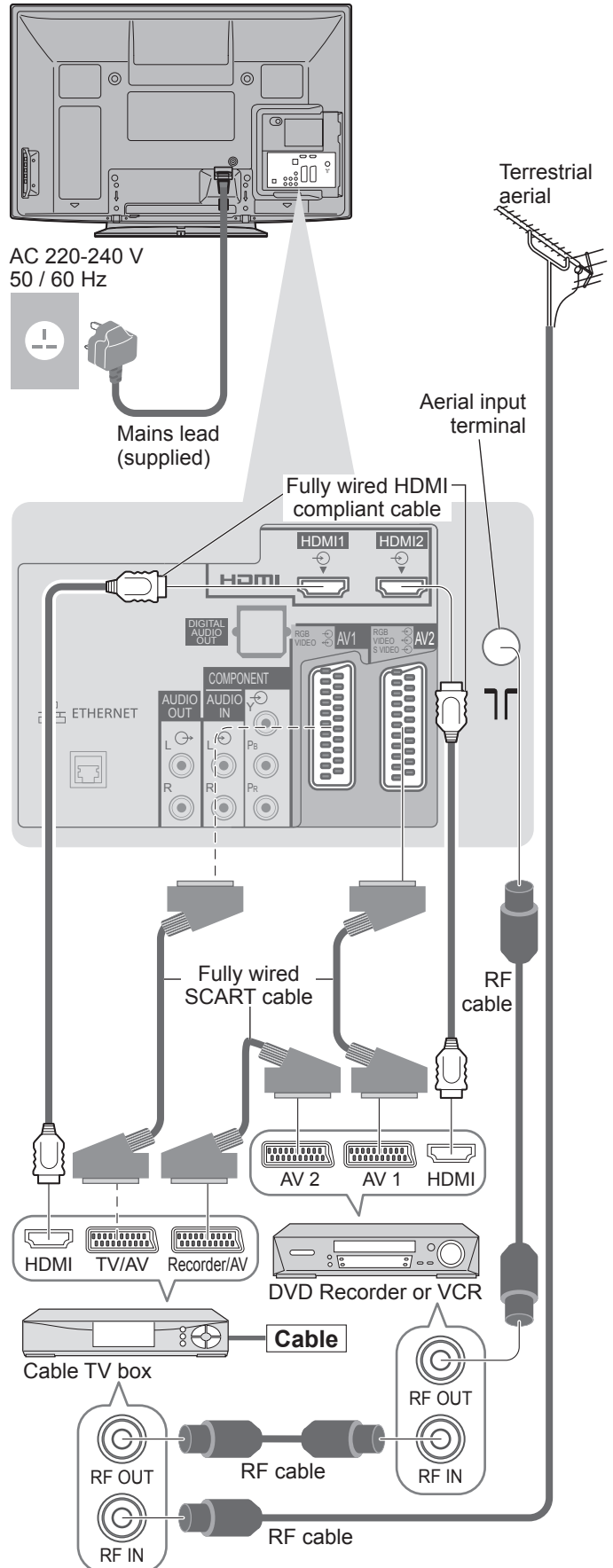

Auto Setup

Search and store TV channels automatically.

- These steps are not necessary if the setup has been completed by your local dealer.
- Please complete connections (p. 10 and p. 11) and settings (if necessary) of the connected equipment before starting Auto Setup. For details of settings for the connected equipment, read the appropriate manual.

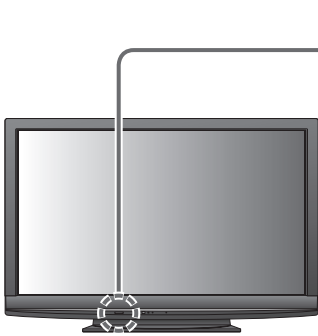

1 Plug the TV into mains socket and switch On (Takes a few seconds to be displayed)



- Auto Setup will start to search for TV channels and store them in the numbered order as specified by the broadcasters.

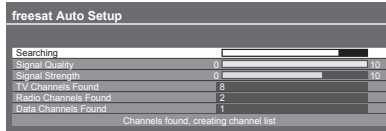

- If "freesat Auto Setup" cannot be done completely
→ "FAQs" (p. 73)

(freesat tuning)

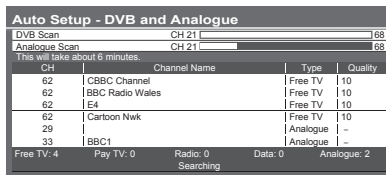

(DVB and Analogue tuning)

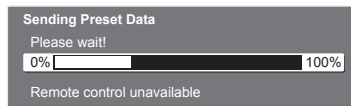

- If Q-Link, or similar technology (p. 60), compatible recorder with analogue tuner is connected, analogue channel setting is automatically downloaded to the recorder. (Digital channel setting is not downloaded.)
- If downloading has failed, you can download later through the Setup Menu.
→ "Q-Link Download" (p. 32)



2 Enter your postcode

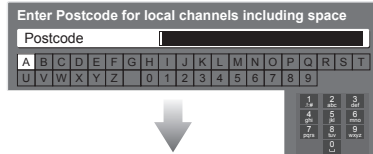

- Your postcode is required to receive local services and sort the channel order. Please ensure to include a space when entering your postcode.
- If you skip this step, the default postcode (central London) will be set.

3 Input Owner ID

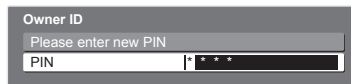

Please enter your own choice of PIN number, name, etc. to help the police to crack crime.

- Make a note of the PIN number in case you forget it.
- You can skip this step and input the Owner ID later.
→ "Owner ID" (p. 51)

4 Select "Home"

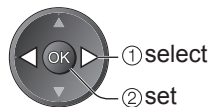
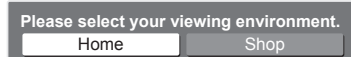

Auto Setup is now complete and your TV is ready for viewing.



- To check channel list at-a-glance
→ "Using TV Guide" (p. 18 and p. 19)
- To edit channels
→ "Tuning and Editing Channels" (p. 36 - 41)

Using the On Screen Displays

Many features available on this TV can be accessed via the On Screen Display menu.

How to use remote control



Move the cursor / select the menu item



Move the cursor / adjust levels / select from a range of options



Access the menu / store settings after adjustments have been made or options have been set



Return to the previous menu



Open the main menu



Exit the menu system and return to the normal viewing screen

ON SCREEN HELP Instructions box - Operation guide

(example: Owner ID)

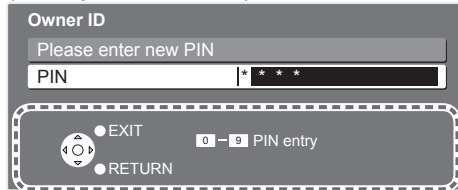

Operation guide will help you.

Note

- If tuning has failed → “Auto Setup” (p. 34 and p. 35)
- If you wish to tune in other satellite channels → “Auto Setup” in “Other Sat. Tuning Menu” (p. 43)
- To initialize all settings → “Shipping Condition” (p. 49)
- If you turned the TV Off during Standby mode last time, the TV will be in Standby mode when you turn the TV On with Mains power On / Off switch.

How to enter the postcode

Set characters one by one

Exit the menu to go to next step

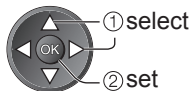

- You can set characters by using numeric buttons.
→ “Characters table for numeric buttons” (p. 69)

How to input Owner ID

Enter the PIN number (4 digits)



- Enter the PIN number twice at first setting.

Select NAME / HOUSE NO / POSTCODE and access the “User input” mode

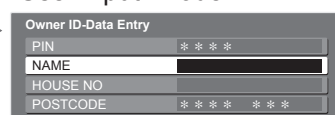

Set characters one by one

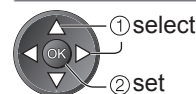
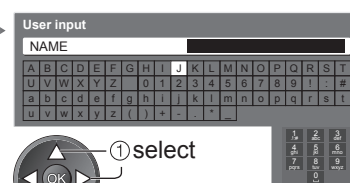

- You can set characters by using numeric buttons.
→ “Characters table for numeric buttons” (p. 69)

Return to select other items



or

Exit the menu to go to next step



“Shop” mode (for shop display use only)

Automatic Demo Off / On selection screen is displayed.

You can change the viewing environment at this stage



(This is not available in “Home” mode)

Select “Home”

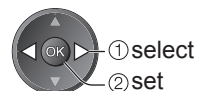
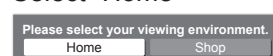

Auto Setup is complete

- If you set to “Off” or “On” in Automatic Demo Off / On selection screen, the TV will be in “Shop” viewing environment (p. 78), and Auto Setup will be complete. The blue LED on the front panel of the TV will light even if SD Card is not inserted. To turn off the LED, set SD Card LED “Off” in the Setup Menu (p. 33).
- To change viewing environment later on, you will need to initialise all settings by accessing Shipping Condition and go through Auto Setup again.
→ “Shipping Condition” (p. 49)

How to Use VIERA TOOLS

You can access some special features easily by using the VIERA TOOLS function.

- For “VIERA Link Control” and “Pause Live TV” functions to operate correctly, ensure the connections and settings are completed.
 ➔ “Summary of Q-Link and VIERA Link features” (p. 58 and p. 59), “Preparations” (p. 61)
 After connection, turn the equipment on and then switch the TV on.



1 Display icons of the feature



2 Select a feature

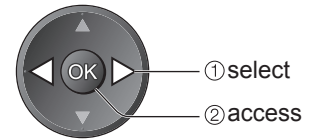

3 Follow the operations of each feature

- VIERA Link Control ➔ “VIERA Link Control” (p. 64)



When more than two pieces of compatible equipment are connected a selection screen will be displayed.
Please select the correct description and access.

- Pause Live TV ➔ “Pause Live TV” (p. 63)



- Slideshow ➔ “Slideshow” (p. 55)



Slideshow will use all of the photos on the SD Card.

- Photos ➔ “Photo View” (p. 54)



- Movies ➔ “Movie View” (p. 56)



■ To return to TV



Watching TV



1 Turn power on
(Press for about 1 second)

- Mains power On / Off switch should be On. (p. 8)

2 Select the mode (freesat, DVB, Analogue or Other Sat.)

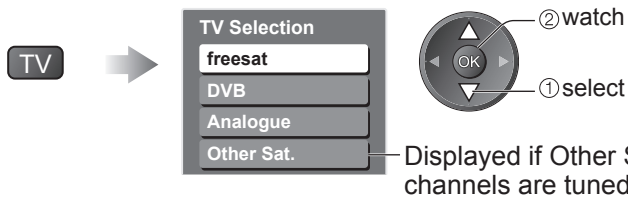

- Also possible by pressing the TV button repeatedly on the remote control or side panel of the TV. (p. 8)

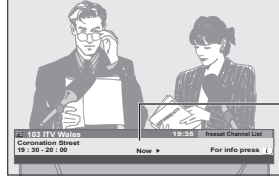

Information banner appears whenever you select a channel
● For details → p. 16

3 Select a channel

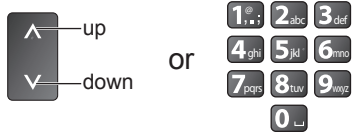

freesat channel position numbers run in the ranges 100 - 999 and 0100 - 0999.

- To select a three-digit channel position number, e.g. 133
→ 1.Ⓜ → 3.ⓓ → 3.ⓓ
- To select a four-digit channel position number, e.g. 0246
→ 0.Ⓛ → 2.ⓐ → 4.ⓖ → 6.Ⓜ

DVB and Other Sat. channel position numbers run from 1 onwards.
Analogue channel position numbers run in the ranges 0 - 99.

- To select a two or three-digit channel position number, e.g. 39
→ 3.ⓓ → 9.Ⓦ

Note
● To watch pay-TV
→ "Common Interface"
(p. 51)

■ **Select a channel using Information banner** (p. 16)
Possible to confirm the channel name and programme before changing channels.
Display Information banner if it is not displayed → While the banner is displayed, select the channel

- Possible to set display timeout in "Banner Display Timeout" (p. 33).

■ **Select a channel using TV Guide** (p. 18)
Possible to confirm the TV Guide (EPG) before changing channels.
Display TV Guide → Select the programme now on the air → Select "View" (freesat or DVB mode)

■ Other useful functions

Hold

Freeze / unfreeze picture

Watching TV

Display Information banner

Display Information banner

- Also appears when changing a channel

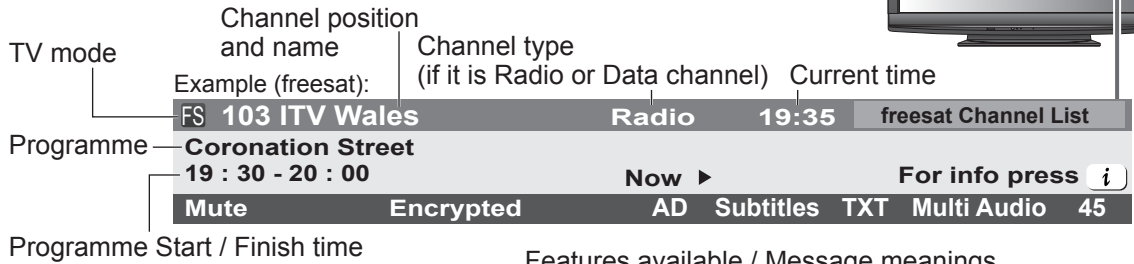

“All DVB Channels” or “Favourites1-4” (p. 39)

- To switch → blue

Example (DVB):



Example (Analogue):



Channel number

“All Other Sat. Channels” or “Favourites1-4” (p. 44)

- To switch → blue

Example (Other Sat.):



Features available / Message meanings

- Mute**
Sound mute On
- Bad signal**
Poor TV signal quality
- Encrypted**
Scrambled programme
- AD**
Audio Description service available
 - This function can aid visually-impaired viewers by adding an additional audio track to describe events on-screen.
 - For settings → p. 31
- Subtitles**
Subtitle service available
- TXT**
Teletext service available
- Multi Audio**
Multiple audio available
- Stereo, Mono, NICAM**
Audio mode
- 1 - 90**
Off Timer remaining time
 - For settings → p. 17

- To confirm another tuned channel name →
- Information on the next programme (freesat, DVB, Other sat.) →
- Extra information → (press again to hide the banner) (freesat, DVB, Other sat.)
- “AD”, “Subtitles”, “TXT”, “Multi Audio” indications are displayed as available on particular programmes, but may not be available for all individual programmes being broadcast. Display the extra information to confirm availability of these functions. →
- To watch the channel listed in the banner →
- To hide →
- To set display timeout → “Banner Display Timeout” (p. 33)

Example:

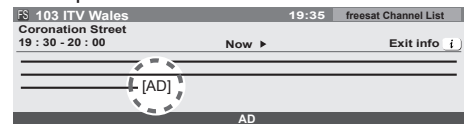

Display subtitles

■ freesat, DVB or Other Sat. mode

Display / hide subtitles (if available)

- To change the language for digital channel (if available) → “Preferred Subtitles” (p. 33)



■ Analogue mode

Display subtitles

- To hide subtitles →



Note

- This is the same as switching to Analogue teletext service and selecting “P888” (subtitle service). (p. 23)
- You cannot change the channel when this function is active.

Change the aspect ratio (image size)

ASPECT



Enjoy viewing the image at its optimum size and aspect.

Normally programmes have the Aspect Control Signal (Widescreen signal, etc.), and the TV will choose the aspect ratio automatically according to the Aspect Control Signal (p. 68).

■ If you would like to change the aspect ratio manually

Display Aspect Selection list

While the list is displayed, select the mode



Aspect Selection list

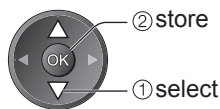

- To change the mode using the ASPECT button only
 ➔ ASPECT (Press repeatedly until you reach the desired mode)



The best ratio is chosen and the image expanded to fill the screen.
For details ➔ p. 68



Directly displays the image at 16:9 without distortion (anamorphic).



Displays the image at the standard 4:3 without distortion.



Displays a 16:9 letterbox (anamorphic) image full-screen without distortion.



Displays the image at the standard 14:9 without distortion.



Displays a 16:9 letterbox or 4:3 image without distortion.



Displays a 2.35:1 letterbox (anamorphic) image full-screen without distortion. At 16:9, displays the image at its maximum (with slight enlargement).

Note

- Only "16:9" and "4:3" are available in PC input mode.
- Not available when the subtitle function is active.
- Not available in teletext service.
- Aspect mode can be memorized separately for SD (Standard definition) and HD (High definition) signals.

Display the selectable settings for the current programme

Check or change the current programme status instantly

OPTION



- To change ➔

Multi Audio / AD (freesat mode)

Allows you to select between alternative language or Audio Description for sound tracks (if available)

- Set Audio Description "Auto" in the Sound Menu (p. 31) to select the audio description sound track. In freesat mode, Audio Description cannot be controlled separately from the audio description sound track.

Multi Audio (DVB or Other Sat. mode)

Allows you to select between alternative language for sound tracks (if available)

Subtitle Language (freesat, DVB or Other Sat. mode)

Allows you to select the language in which subtitles should appear (if available)

NICAM (Analogue mode)

➔ Sound Menu (p. 31)

Volume Correction

Adjusts volume of individual channel or input mode

Audio Description (DVB mode)

Set to "Auto" if the programme has Audio Description service, then you will hear an additional audio track to describe events on-screen

- To adjust the volume for Audio Description
 ➔ "Audio Description Menu" (p. 31)

Note

- Also possible to change the settings in Menu list (p. 30 - 33).

Off Timer

Turn the TV off automatically after a fixed period

Display the menu



Select "Setup"

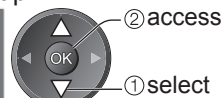

Select "Off Timer" and set the time

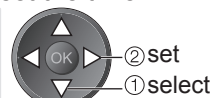
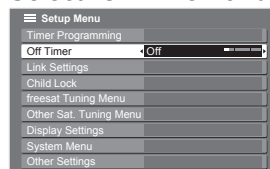

- To cancel ➔ Set to "Off" or turn the TV off.
- To display the remaining time ➔ Information banner (p. 16)

Note

- When the remaining time is within 3 minutes, the remaining time will flash on the screen.

Using TV Guide

TV Guide—Electronic Programme Guide (EPG) provides an on-screen listing of the programmes currently broadcast and the forthcoming broadcasts over the next seven days (depending on the broadcasters).

- When this TV is turned on for the first time, or the TV is switched off for more than a week, it may take some time before the TV Guide is completely shown.

freesat mode



1 Select freesat

→ p. 15



2 Display the Channel Genre selection list



3 Select the genre and view TV Guide

Example:

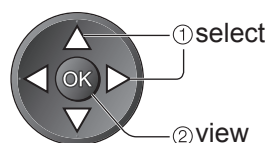
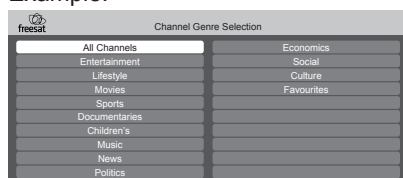

- To change the layout (Landscape / Portrait) view "Landscape" to see many channels view "Portrait" to see one channel at a time

TV Guide date Example: Programme Current date and time

Example: TV Guide: Landscape Wed 24/10/2007 10:46

Time	19:30	20:00	20:30	21:00	21:30
101 BBC ONE	Eastender	DIY SOS	The Bill	Red Cap	
102 BBC 2W	Hot Wars		Holiday Program		World
103 BBC NEWS	Emmerdal.	Coronation Street		The Bill	
104 BBCi	10 O'clock News BBC		Pepsi Char.	Good Bye	Drama
105 BBC THREE	Panorama	The Real Hustle		Eastender	
106 BBC FOUR	I'm A Celebrity	Eastender	Pop Idol	News	
107 BBC Radio	Rugby	15 To 1		The Bill	

Landscape (Displays by channel)

Channel position and name

TV Guide time

Example: TV Guide: Portrait Wed 24/10/2007 10:46

Time	19:30-20:00	20:00-20:30	20:30-21:00	21:00-22:00	22:30-23:00	23:00-23:30	23:00-00:00
101 BBC ONE	Eastender	DIY SOS	The Bill	Red Cap	Live junction	POP 100	Rugby

Portrait (Displays by time)

■ To return to TV



Other Sat. mode

In Other Sat. mode, TV Guide is not available. In stead, Channel List will appear.

- To tune in Other Sat. Channels → p. 43

(in Other Sat. mode)

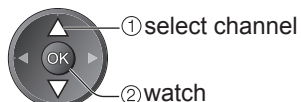

- There might be some programmes displayed as greyed-out in TV Guide. These are the Off-Air programmes (non-running programmes).

■ To the previous day



■ To the next day



■ To view a channel list of the selected type

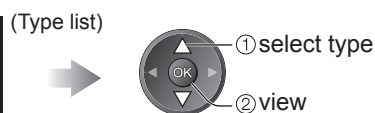
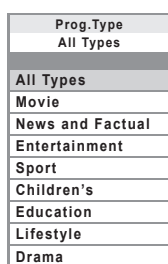

■ To view a channel list of the selected genre



To list favourite channels → p. 37

DVB or Analogue mode

- This TV supports the GUIDE Plus+ system in DVB or Analogue mode.
- The Gemstar branding partner will supply the rating informations in the programme information and the recommended group in the Prog.Type list.
- Analogue channels will be listed after DVB channels but there will be no programme listings. "D" means DVB channel and "A" means Analogue channel.



1 Select DVB or Analogue

→ p. 15



2 View TV Guide



- To change the layout (Landscape / Portrait) view "Landscape" to see many channels view "Portrait" to see one channel at a time

TV Guide time: Wed 24/10/2007 10:46

Current date and time: Wed 24th

Logo of the Gemstar branding partner: RadioTimes

Example: TV Guide: Landscape

Time	19:30	20:00	20:30	21:00
D 1 BBC ONE	Eastender	DIY SOS	The Bill	Red Cap
D 7 BBC THREE	Hot Wars		Holiday Program	
D 14 E4	Emmerdal	Coronation Street	The Bill	
D 70 BBC FOUR	10 O' clock News BBC	Pepsi Char.	Good bye	
D 72 BBC 2W	Panorama	Spring watch	Coast	
D 105 BBC1	I'm A Celebrity	Pop Idol	News	
D 719 BBC Radi	Rugby	15 To 1	The Bill	

Advertisement: VIERA

Landscape (Displays by channel) Channel position and name

Example: TV Guide: Portrait

Time	19:30-20:00	20:00-20:30	20:30-21:00	21:00-22:00	22:30-23:00	23:00-23:30	23:00-00:00
D 1 BBC ONE	Eastender	DIY SOS	The Bill	Red Cap	Live junction	POP 100	Rugby

Portrait (Displays by time)

■ To the previous day (DVB mode)



■ To the next day (DVB mode)



■ To view a channel list of the selected type (DVB mode)



Prog.Type: All Types (Type list)

All Types
Movie
News and Factual
...
...



■ To view a channel list of the selected category



Category: All Channels (Category list)

All Channels
All DVB Channels
All Analogue Channels
Free DVB Channels
TV/Data DVB Channels
Favourites1
Favourites2
Favourites3
Favourites4

Only Analogue channels are listed

To list favourite channels → p. 39

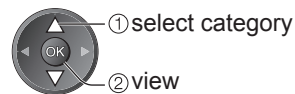

■ To return to TV



View advertisement

Enter your postcode when using this function for the first time

→ "Postcode" in "GUIDE Plus+ Settings" (p. 33)

If you have already entered your postcode in "Auto Setup" - when first using the TV (p. 12), you do not have to enter again.

If you enter an incorrect postcode for your area, or no postcodes are entered, advertisement may not be displayed correctly.

Display advertisement information

- OPTION ● To display the latest advertisement, you will need to update the information.
- To update the information continuously, the TV must be left in Standby mode at night.

■ To change advertisements



■ To return to TV Guide



Note

- Some advertisements are for future programmes. In this case it is possible to use the Guide link recording function (p. 20).
- The advertisements displayed on the TV Guide are sent from the GUIDE Plus+ system so that they cannot be deleted manually or will not be lost even when the TV is turned Off with Mains power On / Off switch.

Using TV Guide

Other useful functions (Operate whilst viewing TV Guide)

Watch the programme

Select the current programme or channel

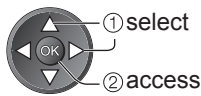

Select "View" (freesat or DVB mode)

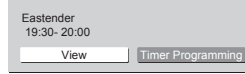

- Timer Programming
- ➔ see below



(TV screen)

View details of the programme (freesat or DVB mode)

Select the programme



View details



Details

To return to the start page



Timer Programming (freesat or DVB mode)

Select the forthcoming programme to output to external recorder

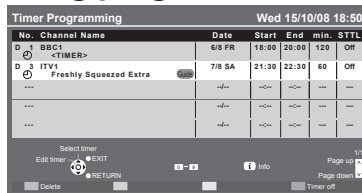
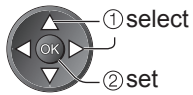

(Timer Programming screen)

Timer LED will turn on if Timer Programming is set.



Timer LED

- Orange Timer LED (Blinking during timer active)

Note

- While recording, you cannot watch any other channels except the one being recorded.
- When recording programmes, you must make the proper settings on the recorder connected to the TV.

If a compatible recorder with Q-Link or similar technologies is connected to the TV (p. 60) and the "Link Settings" (p. 32) are completed, no setting of the recorder is required. Also read the manual of the recorder.

- If you select the current programme, a screen asking you to confirm whether you wish to watch or record it will appear. Select "Timer Programming" to record from the time you finish the Timer Programming setting.

To check / change / cancel a Timer Programming event

➔ "Timer Programming" (p. 53)

To return to TV Guide



Guide link recording (Timer Programming from the TV Guide signal)

Guide link recording is a timer programme controlled by information from the TV Guide.

Programme start and end times may be changed by broadcasters and sent to the TV for timer programme to follow the change.

Split Programme is a programme which is interrupted by one or more other programmes.

Both of the above are subject to signals being sent by broadcasters.

Select the forthcoming programme to output to external recorder

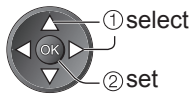

(Timer Programming screen)

"Guide" is displayed if the timer is set from the TV Guide
 "S/P" is displayed if the timer is set from the TV Guide and the programme is a Split Programme

Timer LED will turn on if Timer Programming is set.



"O" will be displayed in the TV Guide if Timer Programming is set.



To check / change / cancel a Guide link recording event

➔ "Timer Programming" (p. 53)

- If you edit the start time or end time of Guide link recording more than 10 minutes after setting to record, it will no longer be performed as Guide link recording. The recording will be performed according to the time setting in Timer Programming.

To return to TV Guide



Note

- Not available in Analogue or Other Sat. mode.
- Whilst making Split Programme recording, it is not possible to record any other programmes between the interrupted programmes.
- The Split Programme recording does not work if the separated parts are broadcast on differing channels.

Viewing Teletext

You can enjoy news, weather forecasts and subtitles, etc. (depending on the broadcaster)

- The availability of teletext services for a programme is indicated by "TXT" in the information banner.

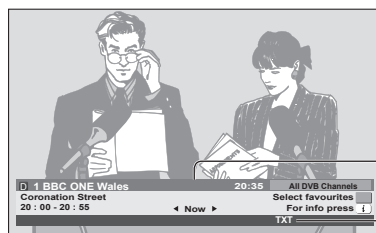

Information banner (p. 16)

Displayed if programme has teletext service

Digital teletext (MHEG)

Digital teletext services

Digital teletext services differ greatly from analogue teletext.

When you switch to a digital teletext service, the images you see can contain graphics and text, laid out and controlled in a manner decided by the broadcaster.

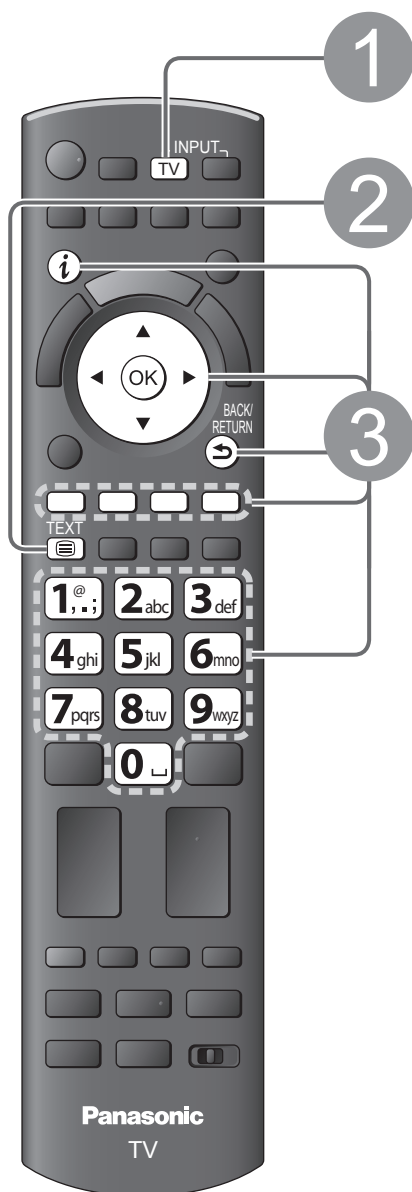

1 Select freesat or DVB

→ p. 15



- freesat and DVB programmes have digital teletext services (MHEG).

2 Switch to Teletext

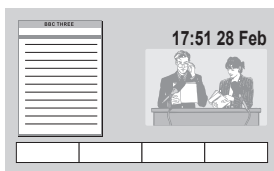

How to use

In all cases, it is possible to navigate the pages using buttons on the remote control, but because the commands available must apply to all manufacturers of digital equipment, some on screen commands may not correspond exactly to the remote control buttons.

For example:

- When "select" or "go" is displayed →
- When "◀", "▶", "▲", "▼" symbol is displayed →
- When "back key" is displayed →
- When the key words are displayed on colour bar →
- When options with numbers are displayed →
- When "i" is displayed → (information)

■ To return to TV →

Note

- As soon as you switch to a digital channel with links to a teletext service, software is downloaded in the background to enable the teletext function. This means that when switching to a digital channel, you should wait for approximately 5 seconds before pressing the TEXT button - this will allow the software to download. If you press the TEXT button before download is complete, there will be a short delay before the text screen is displayed.
- While navigating digital teletext, you will find there is a short delay when moving between pages while the page downloads. There is often a prompt shown somewhere on the page (for example "Loading") to let you know that this is happening.

Viewing Teletext

Analogue teletext

Analogue teletext services

Analogue teletext services are the text information provided by the broadcasters. The features may vary depending on the broadcasters.

What is FASTEXT mode?

In FASTEXT mode, four differently coloured subjects are situated at the bottom of the screen. To access more information about one of these subjects, press the appropriately coloured button. This facility enables fast access to information on the subjects shown.

What is List mode?

In List mode, four differently coloured page numbers are situated at the bottom of the screen. Each of these numbers can be altered and stored in the TV's memory. ("Store frequently viewed pages", p. 23)

■ **To change mode** → "Teletext" in the Setup Menu (p. 33)

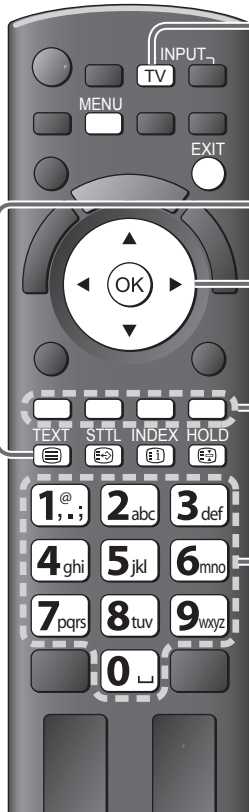

1 Select Analogue or Other Sat.
→ p. 15
TV

- Other Sat. programmes are digital broadcasts. The operations of the teletext services, however, are equal to Analogue teletext service.

2 Switch to Teletext
TEXT

- Displays the index page (content varies depending on the broadcasters)

3 Select the page

1., 2., 3. or up/down arrows
4., 5., 6. or red, green, yellow, blue
7., 8., 9. or (Corresponds to the colour bar)
0. or MENU (Press twice)

As the blue bar is displayed

■ **To adjust contrast** → MENU (Press twice) → OK

■ **To return to TV** → EXIT

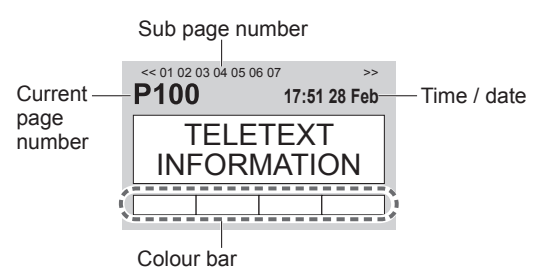

Reveal hidden data

Reveal hidden words e.g. quiz page answers

MENU → red ● To rehide → red

FULL / TOP / BOTTOM

MENU → green

(TOP) → (BOTTOM) → Normal (FULL)

P100 Broadcast

(Expand the TOP half) → (Expand the BOTTOM half)

HOLD

Stop automatic updating

(If you wish to hold the current page without updating)

HOLD → HOLD ● To resume → HOLD

INDEX

Return to the main index page



Subtitles

View a favourite page stored



- Factory setting is "P888" (subtitle service) on the blue button (List mode).

View in multi window

Watch TV and Teletext in two windows at once



- Operations can be made only in Teletext screen.
- Each time pressed: Teletext → TV and Teletext



Store frequently viewed pages

Store frequently viewed pages in the colour bar

(List mode only)

As page is displayed



OK press and hold

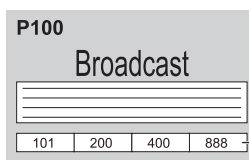

The number changes to white.

- If you wish to use Subtitles, do not change number on blue button.

■ To change stored pages

Enter new page number



Coloured button you want to change



OK press and hold

View sub page

View sub page (Only when teletext is more than one page)



<<01 02 03 04 05 — Appears at top of the screen

■ To view specific sub page



blue



Enter the 4-digit number
example: P6
0 0 0 6

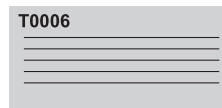

- Sub pages:
The number of sub pages varies depending on the broadcasters (up to 79 pages).
It may take some time for searching, during which time you can watch TV.

Watch TV while waiting for update

View the TV picture while searching for a teletext page

Teletext automatically updates itself when new information becomes available.

Changes to TV screen temporarily

View the updated page



yellow



Appears when updating is completed



yellow

(You cannot change the channel.)

- The news page provides a function that indicates arrival of latest news ("News Flash").

Watching External inputs

Connect the external equipment (VCRs, DVD equipment, etc.) and you can watch through the input.

● To connect the equipment → p. 11 and p. 66

The Remote Control is capable of operating some functions of selected external equipment.

1 Turn the TV on

- **When connecting with SCART as example 2 or 3 (p. 11)**
 - ➔ Receives input signals automatically when playback starts
 - Input signals are automatically identified by the SCART (pin 8) terminal.
 - This function is also available for HDMI connections (p. 66).
- **If input mode is not switched automatically**
 - ➔ Perform ② and ③
 - Check the setup of the equipment.

2 Display the Input select menu

AV

3 Select the input mode connected to the equipment

- You can also select the input using the AV button on the remote control or the side panel of the TV. Press the button repeatedly until the desired input is selected.
- In order to switch between AV2/AV3 and AV2S/AV3S, move the indicator by pressing left and right cursor button.
- You can label or skip each input mode → “Input Labels” (p. 48)
Skipped inputs will not be displayed when the AV button is pressed.

4 View

Displays the selected mode

AV2

■ **To return to TV**

➔ TV

Note

- If the external equipment has an aspect adjustment function, set to “16:9”.
- For details, see the manual of the equipment or ask your local dealer.









Screen display

Terminal	AV1	AV2	AV3	COMPONENT	PC	HDMI1	HDMI2	HDMI3
Manual input (default setting in "Input Labels")	AV1 AV1-RGB	AV2 AV2-S-Video AV2-RGB	AV3 AV3-S-Video	COMPONENT	PC	HDMI1	HDMI2	HDMI3
Auto input (EC mode or VIERA Link)	EC/AV1 EC/AV1-RGB	EC/AV2 EC/AV2-S-Video EC/AV2-RGB	—	—	—	EC/HDMI1 ● Applicable for EC mode and VIERA Link	EC/HDMI2 ● Applicable for VIERA Link	EC/HDMI3 ● Applicable for VIERA Link

- If the above information is permanently displayed on the top left of the screen, press the **i** button to clear.



Operating the equipment with the TV remote control



The equipment connected to the TV can be directly operated with the below buttons of this TV remote control.

	Selection Switch for operating the connected equipment Select "DVD/VCR" to operate Panasonic DVD Recorder, DVD Player, Player theatre, Blu-ray Disc theatre or VCR ➔ "How to change the code for the type of the equipment" (see below) Select "TV" to operate the connected equipment in VIERA Link ➔ "VIERA Link Control" (p. 64)
	Standby Set to Standby mode / Turn on
	Play Playback videocassette / DVD
	Stop Stop the operations
	Rewind / Skip / Search VCR: Rewind, view the picture rapidly in reverse DVD: Skip to the previous track or title Press and hold to search backward
	Fast-forward / Skip / Search VCR: Fast-forward, view the picture rapidly forward DVD: Skip to the next track or title Press and hold to search forward
	Pause Pause / Resume DVD: Press and hold to play at slow speed
	Channel Up / Down Select channel
	Record Start recording

■ How to change the code for the type of the equipment

Each type of the Panasonic equipment has its own remote control code. Please change the code according to the equipment you want to operate.

- ① Set the position to "DVD/VCR" 
- ② Press and hold  during the following operations

Enter the appropriate code,  ➔ Press 

Type of the equipment	Code
DVD Recorder, DVD Player	70 (default)
Player theatre, Blu-ray Disc theatre	71
VCR	72

Note

- Confirm if the remote control works correctly after changing the code.
- The codes may be reset to default values if batteries are replaced.
- Some operations may not be possible on some equipment models.

How to Use Menu Functions

Various menus allow you to make settings for the picture, sound, and other functions.



1 Display the menu
 MENU
 ● Displays the functions that can be set (varies according to the input signal)

2 Select the menu

 (example: Picture Menu)
 ② access
 ① select

3 Select the item

 (example: Picture Menu)
 select

4 Adjust or select

 (example: Picture Menu)
 ① change
 ② store or access (Required by some functions)

■ **To return to TV at any time**
 EXIT

■ **To return to the previous screen**
 BACK/RETURN

■ **To change menu pages**
 up
 down

■ **Choose from among alternatives**

Number and positions of alternatives

 Changed

■ **Adjust using the slide bar**

 Moved

■ **Go to the next screen**

 Displays the next screen

■ **Enter characters by free input menu**

You can enter names or numbers freely for some items.

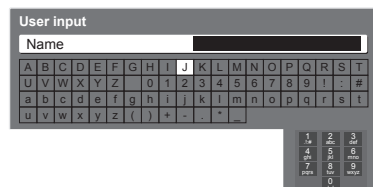

Set characters one by one
 ① select
 ② set

Store
 BACK/RETURN

● You can set characters by using numeric buttons.
 ➔ “Characters table for numeric buttons” (p. 69)

■ Overview (Picture, Sound)

● How to operate → p. 26

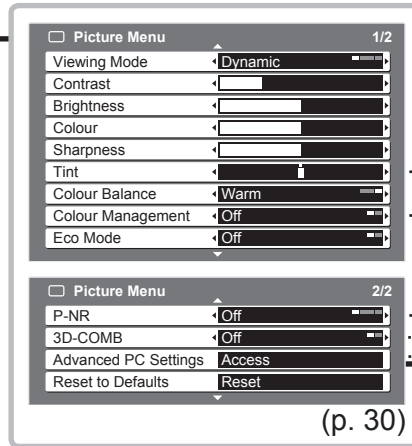
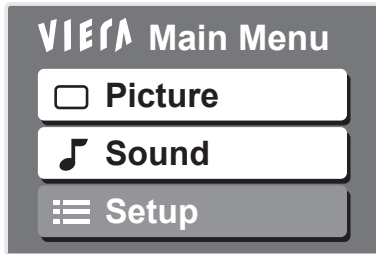

Available in NTSC

Not available in PC

Not available in PC

Available in NTSC / PAL

Available in PC

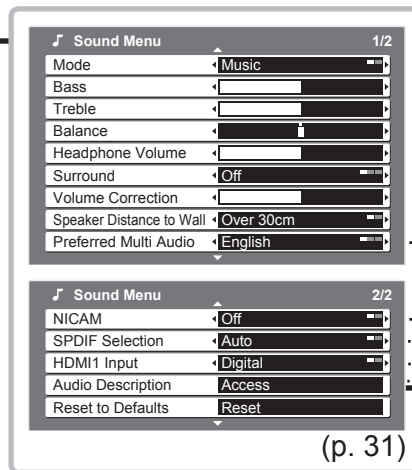
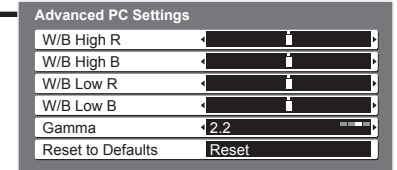

Available in digital

Available in Analogue

Available in Movie View

Available in HDMI

Available in freesat and DVB freesat:

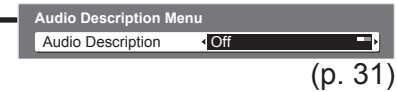

DVB:

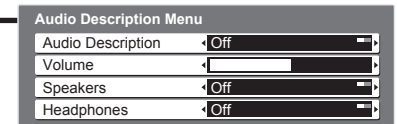

● How to Use Menu Functions (picture, sound quality, etc.)

How to Use Menu Functions

Overview (Setup)

How to operate → p. 26



Available in freesat or Other Sat.

Available in DVB

Available in Analogue

Available in freesat or Other Sat.

Available in DVB or Analogue

Available in DVB or Other Sat.

Available in Analogue

Available in freesat, DVB or Other Sat.

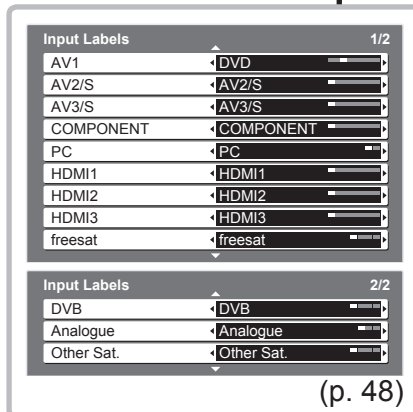
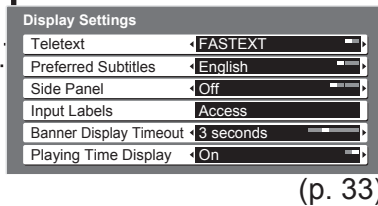
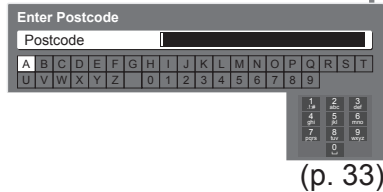
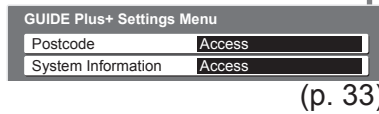
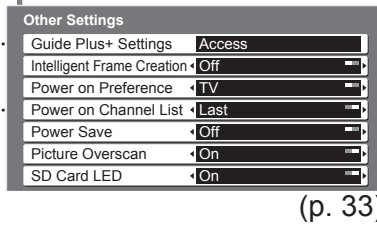
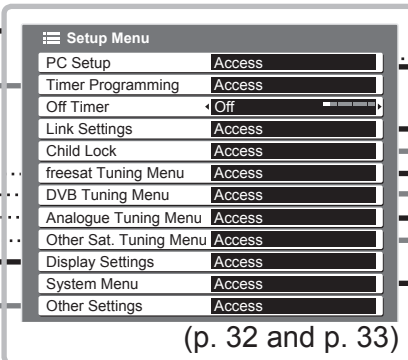

Timer Programming Wed 15/10/08 18:50

No.	Channel Name	Date	Start	End	min.	STTL
1	BBC1 <TIMER>	17/10 FR	18:00	20:50	120	OFF
2	BBC1 Holiday News	18/10 SA	21:30	22:30	60	OFF
3	ITV1 Freshly Squeezed Extra	18/10 SA	22:30	23:30	60	OFF
...

(p. 52)

Available in PC

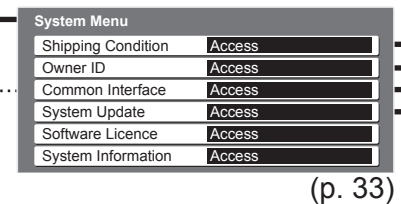
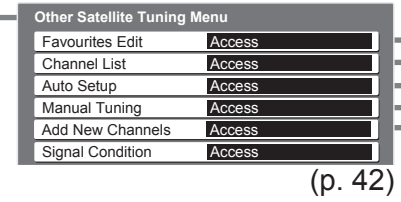
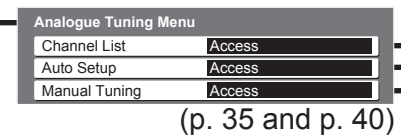
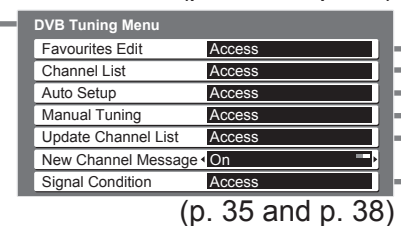
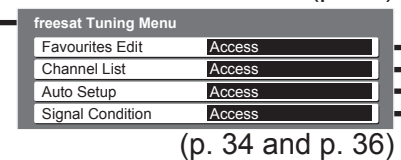
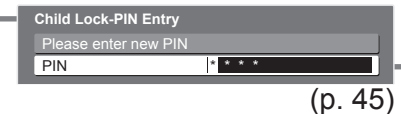
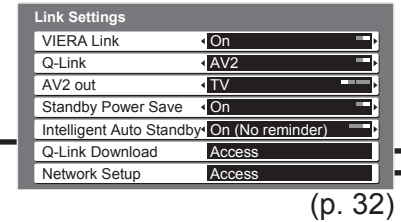
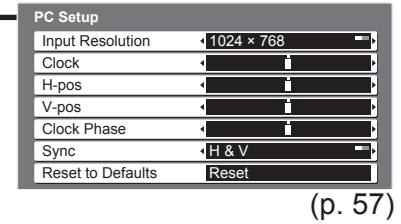

Available in DVB or Other Sat.

Sending Preset Data
Please wait!
0% 100%
Remote control unavailable

(p. 32)

Network Setup Menu 1/2

Connect to Network Access

Acquire IP Address Auto

IP Address

Subnet Mask

Gateway

Acquire DNS Address Auto

Primary DNS

Secondary DNS

Network Setup Menu 2/2

Proxy

Proxy Port

Speed Mode Auto

MAC Address ab-cd-ef-gh-ij-kl

(p. 46)

Child Lock

Change PIN Access

Child Lock List Access

(p. 45)

Child Lock List - TV and AV

Name	Input	Type	Lock
101 BBC 1 Wales	freesat	Free TV	
7 BBC THREE	DVB	Free TV	
14 E4	DVB	Free TV	
VCR	Analogue	Analogue	
1 BBC1	Analogue	Analogue	
2 *****	Analogue	Analogue	
AV1	External	AV	
AV2/S	External	AV	

(p. 45)

freesat Favourites Editor

All freesat Channels	Favourites
101 BBC 1 Wales	
102 BBC 2 Wales	
103 ITV1 WALES	
108 BBC THREE	
109 BBC FOUR	
110 BBC HD	
112 ITV2	
113 ITV2+1	

(p. 37)

freesat Auto Setup

Searching

Signal Quality 0 10

Signal Strength 0 10

TV Channels Found 8

Radio Channels Found 2

Data Channels Found 1

Channels found, creating channel list

(p. 34)

freesat Channel List

101 BBC 1 Scotland	<input type="checkbox"/>
102 BBC 2 Scotland	<input type="checkbox"/>
103 stv	<input type="checkbox"/>
104 stv	<input type="checkbox"/>
108 BBC THREE	<input type="checkbox"/>
109 BBC FOUR	<input type="checkbox"/>
110 BBC HD	<input type="checkbox"/>

(p. 37)

freesat Signal Condition

Channel 101 BBC 1 Wales

Signal Quality 0 10

Signal Strength 0 10

Satellite Astra 28.2° E

Parameter 10847MHz, V, 22000kS/s

(p. 37)

DVB Auto Setup

Scan CH 21

This will take about 3 minutes.

CH	Channel Name	Type	Quality
62	CBBC Channel	Free TV	10
62	BBC Radio Wales	Free TV	10
62	E4	Free TV	10
62	Cartoon Nwk	Free TV	10

Free TV: 4 Pay TV: 0 Radio: 0 Data: 0 Searching

(p. 35)

DVB Channel List

70 CBBC Channel	<input type="checkbox"/>
72 Cartoon Nwk	<input type="checkbox"/>
105 BBC1	<input type="checkbox"/>
719 BBC Radio Wales	<input type="checkbox"/>
720 BBC Radio Cymru	<input type="checkbox"/>
1 BBC ONE Wales	<input type="checkbox"/>
7 BBC THREE	<input type="checkbox"/>

(p. 39)

DVB Favourites Editor

All DVB Channels	Favourites1
1 BBC One Wales	
7 BBC THREE	
14 E4	
70 CBBC Channel	
72 Cartoon Nwk	
105 BBC1	
719 BBC Radio Wales	
720 BBC Radio Cymru	

(p. 39)

DVB Manual Tuning

Frequency 470 MHz

Signal Quality 0 10

Signal Strength 0 10

No.	Channel Name	Type	New

Free TV: 0 Pay TV: 0 Radio: 0 Data: 0 Stopped

(p. 39)

DVB Signal Condition

Channel 70 CBBC Channel

Signal Quality 0 10

Signal Strength 0 10

Network Name Wenvoe

Parameter [CH62] 802 MHz

(p. 38)

Update Channel List

Scan CH 21

This will take about 3 minutes.

CH	Channel Name	Type	Quality

Free TV: 0 Pay TV: 0 Radio: 0 Data: 0 Searching

(p. 38)

Analogue Channel List

1 BBC1	<input type="checkbox"/>
2 *****	<input type="checkbox"/>
3 *****	<input type="checkbox"/>
4	<input type="checkbox"/>
5	<input type="checkbox"/>
6	<input type="checkbox"/>
7	<input type="checkbox"/>

(p. 41)

Analogue Manual Tuning

1 BBC1 CH33

Manual Tuning 21 68

(p. 41)

Analogue Auto Setup

Scan CH 21

This will take about 3 minutes.

CH	Channel Name
CH29	
CH28	

Analogue: 2 Searching

(p. 35)

Other Sat. Favourites Editor

All Other Sat. Channels	Favourites1
1 BBC One Wales	
7 BBC THREE	
14 E4	
70 CBBC Channel	
72 Cartoon Nwk	
105 BBC1	
719 BBC Radio Wales	
720 BBC Radio Cymru	

(p. 44)

Other Satellite Manual Tuning

Transponder Frequency 10773

Polarisation Horizontal

Symbol Rate (Ksym/s) Auto

(p. 42)

Other Sat. Channel List

2 freesatHome	Free TV	<input type="checkbox"/>
3 freesatSSU	Free TV	<input type="checkbox"/>
4 Brit Shorts	Free TV	<input type="checkbox"/>
5 HINRG LOWNRG	Free TV	<input type="checkbox"/>
6 WELL Class	Free TV	<input type="checkbox"/>
7 GROOVE	Free TV	<input type="checkbox"/>
8 -	Unknown	<input type="checkbox"/>

(p. 44)

Other Satellite Auto Setup - Satellite Selection

Satellite Selection Astra2/Eurobird

freesat and other channels

(p. 43)

Search Mode

Free Channels All Channels

(p. 43)

Other Satellite Add New Channels

Satellite Astra2/Eurobird

Progress 0 100%

This may take up to 20 minutes.

No.	Channel Name	Type	Quality

Free TV: 0 Pay TV: 0 Radio: 0 Searching

(p. 43)

Other Satellite Auto Setup

Satellite Astra2/Eurobird

Progress 0 100%

This may take up to 20 minutes.

No.	Channel Name	Type	Quality
1	BBC 1 East (W)	Free TV	10
2	BBC 1 CI	Free TV	10
3	BBC HD	Free TV	10
4	B945	Free TV	10

Free TV: 4 Pay TV: 0 Radio: 0 Searching

(p. 43)

Common Interface

Slot 1: Module inserted

(p. 51)

System Update

Auto Update Search in Standby On

System Update Search Now Access

(p. 50)

Owner ID

Please enter PIN for access

PIN | * * *

(p. 51)

Shipping Condition

All tuning data will be erased

Are you sure?

Are you sure?

(p. 49)

How to Use Menu Functions

■ Menu list

Menu	Item	Adjustments / Configurations (alternatives)
Picture	Viewing Mode	<p>Selects four different screen settings (Dynamic / Normal / Cinema / Game)</p> <p>In each Viewing Mode setting, Contrast, Brightness, Colour, Sharpness, Tint, Colour Balance, Colour Management, Eco Mode and 3D-COMB can be adjusted and stored to suit your particular viewing requirement (e.g., you may require different settings for viewing sports, films, news etc.)</p> <ul style="list-style-type: none"> ● Set for each input signal ● Changes will be stored automatically <p>Dynamic : Provides enhanced picture contrast and sharpness when viewing in a bright room Normal : Recommended for viewing under normal ambient room lighting conditions Cinema : For watching movies in a darkened room producing a cinema-like picture Game : Fast response signal specifically to provide suitable images for playing games</p> <ul style="list-style-type: none"> ● Not valid on TV mode ● A continuous record of time spent using Game mode can be displayed in the top right of the screen. <ul style="list-style-type: none"> ➔ "Playing Time Display" (p. 33)
	Contrast, Brightness, Colour, Sharpness	Increases or decreases the levels of these options according to your personal preference
	Tint	<p>With an NTSC signal source connected to the TV, the picture hue can be adjusted to suit your taste</p> <ul style="list-style-type: none"> ● For NTSC signal reception only
	Colour Balance	Allows you to set the overall colour tone of the picture (Cool / Normal / Warm)
	Colour Management	<p>Automatically adjusts colours to vivid ones (Off / On)</p> <ul style="list-style-type: none"> ● Not valid on PC signal
	Eco Mode	Adjusts picture settings automatically dependent on ambient lighting conditions (Off / On)
	P-NR	<p>Picture Noise Reduction</p> <p>Automatically reduces unwanted picture noise and flicker noise in the contoured parts of a picture (Off / Min / Mid / Max)</p> <ul style="list-style-type: none"> ● Not valid on PC signal
	3D-COMB	<p>Occasionally, whilst viewing still or slow moving pictures, colour patterning may be seen</p> <p>Set to "On" to display sharper and more accurate colours (Off / On)</p> <ul style="list-style-type: none"> ● For PAL or NTSC signal reception only ● Not valid on RGB, S-Video, Component, PC, HDMI and SD Card
	Reset to Defaults	Press the OK button to reset the present Picture Viewing Mode to the default settings

Menu	Item	Adjustments / Configurations (alternatives)
Sound	Mode	Select two different sound settings (Music / Speech) In each Sound Mode setting, Bass and Treble can be adjusted and stored to suit your particular sound requirement <ul style="list-style-type: none"> ● Changes to any settings in a mode will affect all signal sources ● Sound quality can be improved
	Bass	Increases or decreases level to enhance or minimise lower, deeper sound output
	Treble	Increases or decreases level to enhance or minimise sharper, higher sound output
	Balance	Adjusts volume level of right and left speakers
	Headphone Volume	Adjusts the volume of the headphones
	Surround	Surround sound settings (Off / V-Audio / V-Audio Surround) V-Audio: Provides a dynamic enhancer of width to simulate improved spatial effects V-Audio Surround: Provides a dynamic enhancer of width and depth to simulate improved spatial effects <ul style="list-style-type: none"> ● Switching is also possible by the Surround button on the remote control (p. 9).
	Volume Correction	Adjusts the volume of individual channel or input mode
	Speaker Distance to Wall	Adjusts the low frequency sound (Over 30cm / Up to 30cm) <ul style="list-style-type: none"> ● If the back space between the TV and wall is over 30 cm, "Over 30cm" is recommended. ● If the back space between the TV and wall is within 30 cm, "Up to 30cm" is recommended.
	Preferred Multi Audio	Selects the preferred language for digital channel multi audio (depending on the broadcaster)
	NICAM	NICAM (Near Instantaneous Companded Audio Multiplex) A format for digital sound over television Reproduces stereo sound (Off / On) <ul style="list-style-type: none"> ● Off if reception is poor (FM monaural sound) ● Analogue mode only
	HDMI1 / 3 Input	Select to fit the input signal (Digital / Analogue) (p. 70) Digital : HDMI cable connection Analogue : HDMI-DVI adapter cable connection <ul style="list-style-type: none"> ● HDMI input mode only ● HDMI2 terminal is for digital signal only ● No setting for HDMI2 available
Audio Description Menu	Audio Description	Useful for visually-impaired viewers (Off / Auto) Set to "Auto" to activate the description sound track if available <ul style="list-style-type: none"> ● freesat or DVB mode only ● The availability of audio description sound track is indicated by "AD" in the information banner (p. 16).
	Volume	Adjusts the volume for Audio Description <ul style="list-style-type: none"> ● DVB mode only
	Speakers	Set to "On" to activate the description sound track from TV speakers (Off / On) <ul style="list-style-type: none"> ● DVB mode only
	Headphones	Set to "On" to activate the description sound track from headphones (Off / On) <ul style="list-style-type: none"> ● DVB mode only
	Reset to Defaults	Press the OK button to reset the present Sound Mode to the default settings <ul style="list-style-type: none"> ● Effective to Bass, Treble, Balance, Headphone Volume and Surround

- A different menu will be displayed while PC or SD Card is used. (p. 55 - 57)
- Only available items can be selected.

How to Use Menu Functions

■ Menu list

Menu	Item	Adjustments / Configurations (alternatives)	
Setup	Timer Programming	Records forthcoming channels (p. 52)	
	Off Timer	Sets the time the TV automatically turns Off (Off / 15 / 30 / 45 / 60 / 75 / 90 minutes)	
	Link Settings	VIERA Link	Sets to use VIERA Link functions (Off / On) (p. 61)
		Q-Link	Selects which AV terminal is to be used for data communication between this TV and a compatible recorder (AV1 / AV2) (p. 60) ● Select the connected terminal to the recorder even it is not compatible with Q-Link.
		AV1 / AV2 out	Chooses the signal to be transmitted from the TV to Q-Link (TV / AV1 / AV2 / AV3 / Monitor) ● Monitor: Image displayed on screen ● Component, PC and HDMI signals cannot be outputted.
		Standby Power Save	Controls the power consumption in Standby mode of the connected equipment to reduce the consumption (Off / On) (p. 62) ● This function is available when "VIERA Link" is set to "On".
		Intelligent Auto Standby	Makes non-watched or non-used connected equipment go into Standby mode to reduce the power consumption (Off / On (With reminder) / On (No reminder)) (p. 62) ● This function is available when "VIERA Link" is set to "On".
		Q-Link Download	Downloads analogue channel information to a Q-Link compatible equipment connected to the TV
		Network Setup	Sets the network setting to use in your Broadband environment (p. 46)
	freesat Tuning Menu	Child Lock	Locks a channel / AV input to prevent access to it (p. 45)
		Favourites Edit	Creates list of favourite freesat channels (p. 37)
		Channel List	Skips the unwanted freesat channels (p. 37)
		Auto Setup	Automatically sets the freesat channels received in the area (p. 34)
	DVB Tuning Menu	Signal Condition	Checks the freesat signal condition (p. 37)
		Favourites Edit	Creates list of favourite DVB channels (p. 39)
		Channel List	Skips the unwanted DVB channels or edits DVB channels (p. 39)
		Auto Setup	Automatically sets the DVB channels received in the area (p. 35)
		Manual Tuning	Sets the DVB channels manually (p. 39)
		Update Channel List	Updates DVB Channel List with keeping your settings (p. 38)
		New Channel Message	Selects whether to give a notification message when a new DVB channel is found (p. 38)
	Analogue Tuning Menu	Signal Condition	Checks the DVB signal condition (p. 38)
		Channel List	Skips the unwanted Analogue channels or edits Analogue channels (p. 41)
		Auto Setup	Automatically sets the Analogue channels received in the area (p. 35)
	Other Sat. Tuning Menu	Manual Tuning	Sets the Analogue channels manually (p. 41)
		Favourites Edit	Creates list of favourite Other Satellite channels (p. 44)
		Channel List	Skips the unwanted Other Satellite channels or edits Other Satellite channels (p. 44)
		Auto Setup	Automatically sets the Other Satellite channels received in the area (p. 43)
		Manual Tuning	Sets the Other Satellite channels manually (p. 42) ● Please consult the received satellite broadcasting companies for the setting.
Add New Channels		Adds new Other Satellite channels to Channel List (p. 43)	
	Signal Condition	Checks the condition of Other Satellite signals (p. 42)	

Menu	Item	Adjustments / Configurations (alternatives)		
Setup	Display Settings	Teletext	Analogue teletext display mode (FASTEXT / List) (p. 22)	
		Preferred Subtitles	Selects the preferred language for digital channel subtitles (depending on the broadcaster) ● To display subtitles ➔ p. 16	
		Side Panel	Increases the brightness of the side panel (Off / Low / Mid / High) ● The recommended setting is "High" to prevent panel "image retention".	
		Input Labels	Labels or skips each input terminal (p. 48)	
		Banner Display Timeout	Sets how long the Information banner (p. 16) stays on screen (0 (No display) / 1 / 2 / 3 / 4 / 5 / 6 / 7 / 8 / 9 / 10 seconds)	
		Playing Time Display	Set to "On" to display a continuous record of time spent using Game mode (Off / On) ● This function is available when "Game" is selected in "Viewing Mode" (p. 30).	
	System Menu	Shipping Condition	Resets all settings, for example, when moving house (p. 49)	
		Owner ID	Inputs the owner ID (p. 51)	
		Common Interface	Uses include to watch pay-TV (p. 51)	
		System Update	Downloads new software to TV (p. 50)	
		Software Licence	Displays the software licence information	
	Other Settings	GUIDE Plus+ Settings	System Information	Displays the system information of this TV
			Postcode	Sets your postcode to display advertisements in the GUIDE Plus+ system (p. 19)
			System Information	Displays the system information of the GUIDE Plus+ system
		Intelligent Frame Creation	Automatically compensates the picture frame rate to make the image smooth (Off / On)	
		Power on Preference	Automatically selects the input when the TV is turned on (TV / AV) Set to "TV" to view picture from TV tuner. Set to "AV" to view input from an external equipment connected to a SCART terminal, e.g. cable TV box. ● The external equipment must be switched on and sending a control signal for automatic switching at power on to occur.	
		Power on Channel List	Automatically selects All Channels or Favourites list in the Information banner (p. 16) when the TV is turned on (All Channel List / Last) Set to "All Channel List" to display all the channels. Set to "Last" to display the one you selected last time.	
		Power Save	Reduces brightness of picture to economise on power consumption (Off / On)	
		Picture Overscan	Selects the screen area displaying the image (Off / On) On : Enlarged the image to hide the edge of the image. Off : Displayed the image in the original size. ● Set to "On" if noise is generated on the edge of the screen. ● This function is available when aspect is set to Auto (16:9 signal only) or 16:9. ● This function can be memorized separately for SD (Standard definition) and HD (High definition) signals.	
SD Card LED	Lights blue LED while SD Card is inserted (Off / On) (p. 54)			

- A different menu will be displayed while PC or SD Card is used. (p. 55 - 57)
- Only available items can be selected.
- If "Demo Settings" item is displayed in the Setup Menu, the TV is in "Shop" viewing environment (p. 13). To return to "Home" viewing environment initialise all settings by accessing Shipping Condition.
➔ "Shipping Condition" (p. 49)

Retuning from Setup Menu

Auto Setup retunes all channels automatically.

freesat channels

Automatically retune all the freesat channels received in the area.

- Only freesat channels are retuned.
- All the previous tuning settings are erased.
- If a Child Lock PIN number (p. 45) has been set, it must be entered.



- 1 Select freesat**
→ p. 15
TV
- 2 Display the menu**
MENU
- 3 Select "Setup"**

VIIFF Main Menu
Picture
Sound
Setup

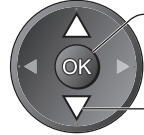
- 4 Select "freesat Tuning Menu"**

Setup Menu	
Timer Programming	
Off Timer	Off
Link Settings	
Child Lock	
freesat Tuning Menu	Access
Other Sat. Tuning Menu	
Display Settings	
System Menu	
Other Settings	

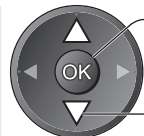

■ To return to TV



■ For Auto Setup, using the buttons on the side panel of the TV (p. 8)

- ① Press repeatedly until "Auto Setup" appears



- ② Access "Auto Setup"



- ③ Start "Auto Setup"

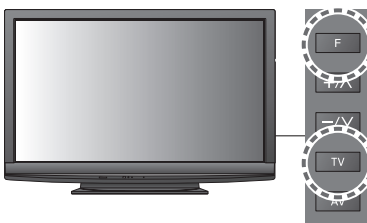

- To return to TV → **F**

Note

- You cannot set the postcode in this operation. The previous postcode setting is not erased.

- 5 Select "Auto Setup"**

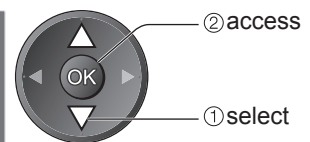
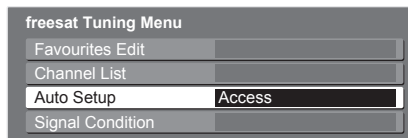

- 6 Start Auto Setup**

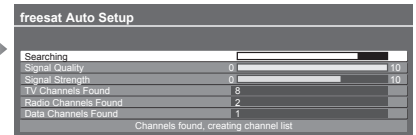
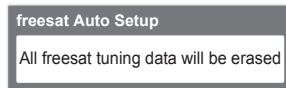

Settings are made automatically

- 7 Enter your postcode**

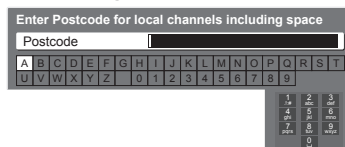

Set characters one by one

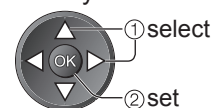

Store



Your postcode is required to receive local services and sort the channel order. Please ensure to include a space when entering your postcode.

- You can set characters by using numeric buttons.
→ "Characters table for numeric buttons" (p. 69)

When the operation is completed, the channel at the lowest position will be displayed.

DVB or Analogue channels

Automatically retune all DVB or Analogue channels received in the area.

- Only DVB channels are retuned in DVB mode.
- Only Analogue channels are retuned in Analogue mode.
- All the previous tuning settings are erased.
- If a Child Lock PIN number (p. 45) has been set, it must be entered.



1 Select DVB or Analogue

→ p. 15



2 Display the menu

MENU



3 Select "Setup"

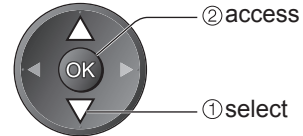
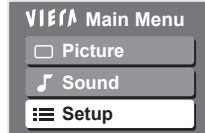

4 Select "DVB Tuning Menu" or "Analogue Tuning Menu"

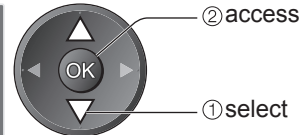
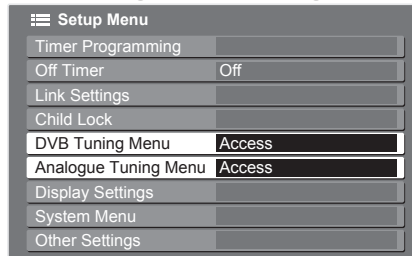

- "DVB Tuning Menu" is available in DVB mode only.
- "Analogue Tuning Menu" is available in Analogue mode only.

5 Select "Auto Setup"

DVB:

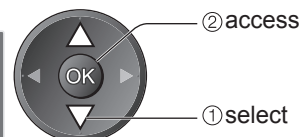
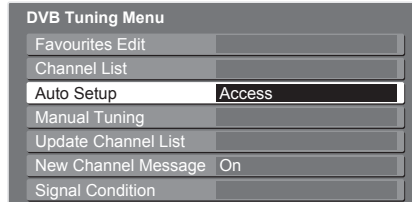

Analogue:

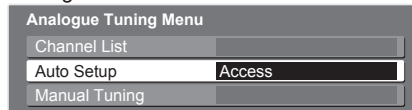

■ To return to TV

EXIT



■ For Auto Setup, using the buttons on the side panel of the TV (p. 8)

- ① Press repeatedly until "Auto Setup" appears



- ② Access "Auto Setup"



- ③ Start "Auto Setup"

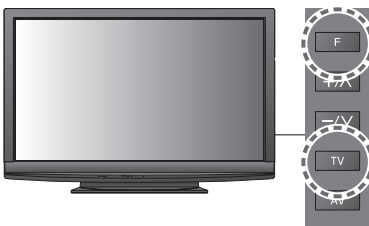

- To return to TV → F

Note

- If tuning has not been done completely
 - "Manual Tuning" (p. 39 and p. 41)

6 Start Auto Setup

DVB:

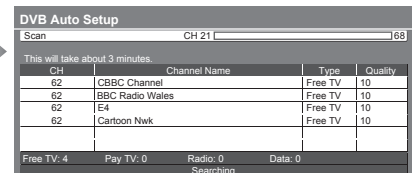
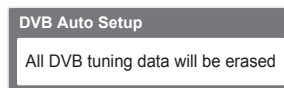

Analogue:

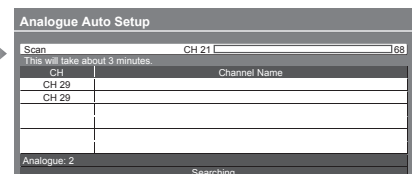
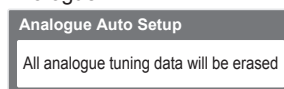

Settings are made automatically

- The analogue settings are downloaded to a Q-Link compatible equipment connected to the TV in Analogue mode.

When the operation is completed, the channel at channel position "1" will be displayed.

Tuning and Editing Channels

(freesat)

You can retune channels or make your favourite channel list, skip unwanted channels, etc.

1 Select freesat
→ p. 15
TV

2 Display the menu
MENU

3 Select "Setup"
Main Menu
Picture
Sound
Setup

4 Select "freesat Tuning Menu"
Setup Menu
Timer Programming
Off Timer Off
Link Settings
Child Lock
freesat Tuning Menu Access
Other Sat. Tuning Menu
Display Settings
System Menu
Other Settings

5 Select one of the following functions
freesat Tuning Menu
Favourites Edit Access
Channel List Access
Auto Setup Access
Signal Condition Access

② access
① select

② access
① select

② access
① select

■ To return to TV



→ "Retuning from Setup Menu" (p. 34)

6 Set

List favourite freesat channels **Favourites Edit**

Create your favourite channel list from various broadcasters. The freesat Favourites list is available from "Channel Genre" in the TV Guide (p. 18).

① Select a channel to list

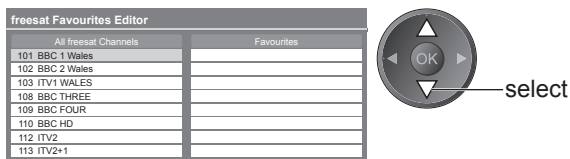

② Add it to the Favourites list

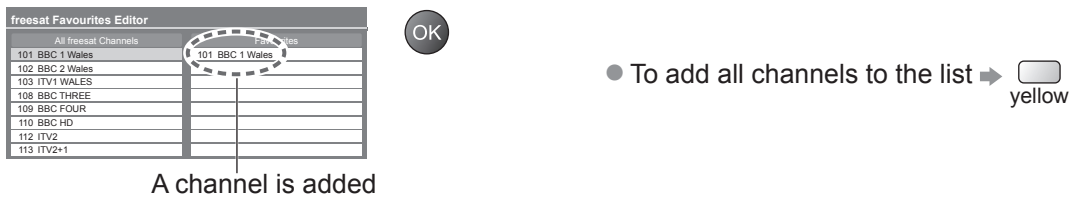

■ To edit Favourites list

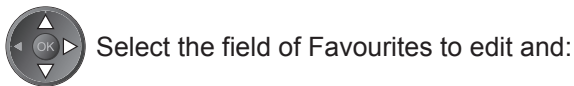

- To delete the channel → OK
- To delete all channels → yellow

Note

- Channel position numbers (known as logical channel numbers) cannot be changed, due to broadcast restrictions.

③ Store



Skip unwanted freesat channels **Channel List**

You can hide unwanted freesat channels. The hidden channels cannot be displayed except in this function. Use this function to skip unwanted channels.

Select a channel and reveal / hide

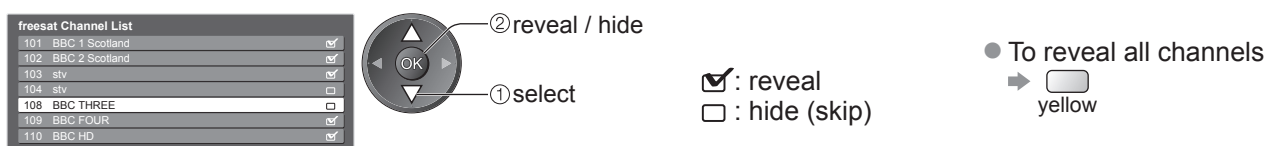

Check freesat signal **Signal Condition**

Selects a channel and checks the freesat signal condition.

- To change the channel →

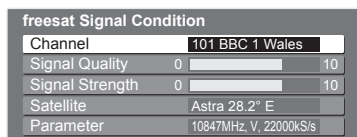

A good Signal Strength is not an indication of suitable signal for freesat reception. Please use the Signal Quality indicator as follows:

Signal Quality:

- Green bar → Good
- Yellow bar → Poor
- Red bar → Bad (Check the Satellite dish)

Tuning and Editing Channels

(DVB)

You can retune channels or make your favourite channel lists, skip unwanted channels, etc.

- 1 Select DVB**
→ p. 15
TV
- 2 Display the menu**
MENU
- 3 Select "Setup"**

Main Menu	
Picture	
Sound	
Setup	
- 4 Select "DVB Tuning Menu"**

Setup Menu	
Timer Programming	
Off Timer	Off
Link Settings	
Child Lock	
DVB Tuning Menu	Access
Display Settings	
System Menu	
Other Settings	
- 5 Select one of the following functions**

DVB Tuning Menu	
Favourites Edit	Access
Channel List	Access
Auto Setup	Access
Manual Tuning	Access
Update Channel List	Access
New Channel Message	On
Signal Condition	Access
- 6 Set**

To return to TV
EXIT

→ "Retuning from Setup Menu" (p. 35)

Update DVB channel automatically **Update Channel List**

You can add new channels, delete removed channels, update channel name and position automatically to Channel List.

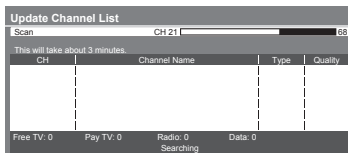

- Channel List is updated with keeping your settings in Favourites Edit, Channel List, Child Lock, Timer Programming, etc.

Display a notification message **New Channel Message**

Selects whether to give a notification message when a new DVB channel is found. (Off / On)



- Selecting OK will perform "Update Channel List".

Check DVB signal **Signal Condition**

Selects a channel and checks the DVB signal condition.

- To change the channel →

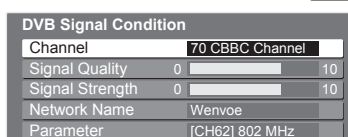

A good Signal Strength is not an indication of suitable signal for DVB reception. Please use the Signal Quality indicator as follows:

Signal Quality:

- Green bar → Good
- Yellow bar → Poor
- Red bar → Bad (Check the Terrestrial aerial)

List favourite DVB channels **Favourites Edit**

Create your favourite channel lists from various broadcasters (up to 4: Favourites1 to 4). The DVB Favourites lists are available for switching in the Information banner (p. 16) and from "Category" in the TV Guide (p. 19).

① Select a channel to list

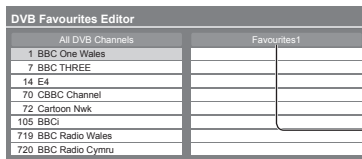

● To display other Favourites → green

② Add it to the Favourites list

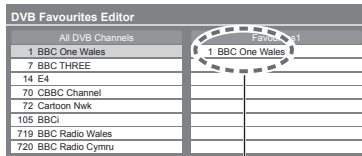

● To add all channels to the list → yellow

A channel is added

■ To edit Favourites list



Select the field of Favourites to edit and:

● To delete the channel → OK

● To delete all channels → yellow

● To name the Favourites → red

Set characters one by one

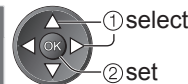
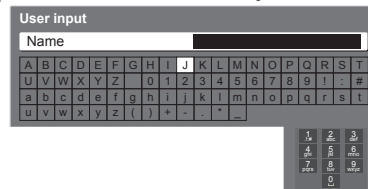

Store
BACK/
RETURN

You can set characters by using numeric buttons.
→ "Characters table for numeric buttons" (p. 69)

● To move the channel → green

Select the new position → Confirm green

③ Store



Skip unwanted DVB channels, Edit DVB Channels **Channel List**

You can hide unwanted DVB channels. The hidden channels cannot be displayed except in this function. Use this function to skip unwanted channels.

Select a channel and reveal / hide

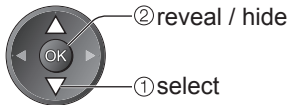

: reveal
 : hide (skip)

● To reveal all channels → yellow

■ To edit channels

You can also edit each channel in Channel List.



Select a channel to edit and:

● To retune each channel (Manual Tuning) → red (see below)

● To swap the channel position → green → Enter the new position number



Set DVB channel manually **Manual Tuning**

Normally use "Auto Setup" or "Update Channel List" to retune DVB channels. If tuning has not been done completely or for adjusting the direction of the aerial, use this function.

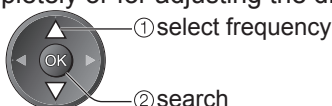
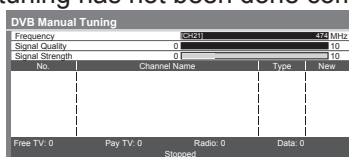

● All channels found will be added to the Channel List.

Tuning and Editing Channels

(Analogue)

You can retune channels or skip unwanted channels, edit channels etc.



1 Select Analogue
→ p. 15
TV

2 Display the menu
MENU

3 Select "Setup"
Main Menu
Picture
Sound
Setup

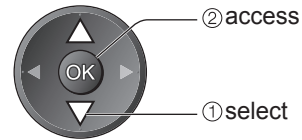

4 Select "Analogue Tuning Menu"
Setup Menu
Timer Programming
Off Timer Off
Link Settings
Child Lock
Analogue Tuning Menu Access
Display Settings
System Menu
Other Settings

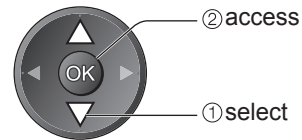

5 Select one of the following functions
Analogue Tuning Menu
Channel List Access
Auto Setup Access
Manual Tuning Access

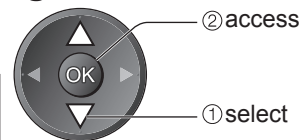

→ "Retuning from Setup Menu" (p. 35)

■ To return to TV
EXIT
→

6 Set

Skip unwanted Analogue channels, Edit Analogue channels Channel List

You can hide unwanted Analogue channels.
The hidden channels cannot be displayed except in this function. Use this function to skip unwanted channels.

Select a channel and reveal / hide

Analogue Channel List

1 BBC1
2 *****
3 *****
4
5
6
7

① select ② reveal / hide

☑ : reveal
☐ : hide (skip)

To reveal all channels
→ yellow

To edit channels

You can also edit each channel in Channel List.

Channel position

Channel name

Select a channel to edit and:

- To retune each channel (Manual Tuning) → red (see below)
- To move the channel position → green → Select the new position → Store green
- To rename the channel name → blue → Set characters one by one (maximum: five characters) → Store BACK/RETURN

1 select
2 set

You can set characters by using numeric buttons.
→ "Characters table for numeric buttons" (p. 69)

Note

- If a VCR is connected only with the RF cable, edit "VCR".

Set Analogue channel manually Manual Tuning

Set Analogue channel manually after Auto Setup.

- If a VCR is connected only with the RF cable, select channel position "0".

Analogue Manual Tuning

1 BBC1 CH33
Manual Tuning 21.68

Select the channel position

Select the channel

Search and store

1 select
2 store

Tuning and Editing Channels

(Other Sat.)

You can tune all receivable digital satellite channels or skip unwanted channels, etc.

- Some of Other Sat. functions may work to differing specifications (depending on the broadcasters).

- 1 Select freesat or Other Sat.**
→ p. 15
- 2 Display the menu**
- 3 Select "Setup"**
- 4 Select "Other Sat. Tuning Menu"**
- 5 Select one of the following functions**
- 6 Set**

■ To return to TV
EXIT
→

Set Other Sat. channel manually **Manual Tuning**

Normally use "Auto Setup" or "Add New Channels" to tune Other Sat. channels.

Other Satellite Manual Tuning	
Transponder Frequency	10773
Polarisation	Horizontal
Symbol Rate (Ksym/s)	Auto

- Please consult the received satellite broadcasting companies for the setting.

Check Other Sat. signal **Signal Condition**

Selects a channel and checks the Other Sat. signal condition.

- To change the channel →

Other Satellite Signal Condition	
Channel Name	1 BBC 1 East (W)
Signal Quality	0
Signal Strength	0
Satellite	Astra 28.2° E
Parameter	10847MHz, H, 22000kS/s

A good Signal Strength is not an indication of suitable signal for Other Sat. reception. Please use the Signal Quality indicator as follows:

Signal Quality:

- Green bar → Good
- Yellow bar → Poor
- Red bar → Bad (Check the Satellite dish)

Set all receivable digital satellite channels Auto Setup

Any receivable digital compliant satellite channels can be tuned.

- Only Other Sat. channels are returned.
- All the previous tuning settings are erased.
- If a Child Lock PIN number (p. 45) has been set, it must be entered.

① Select the satellite

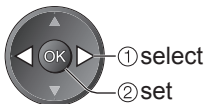

- Selectable satellites are Astra2/Eurobird, Astra1 and Hotbird.
Check the dish alignment for the satellite you want to select
 - Astra2/Eurobird → p. 10
 - Astra1, Hotbird → Please consult the received satellite broadcasting companies.
- If you want to tune from all available satellites, select "Any Satellite".

② Check the signal condition and the message

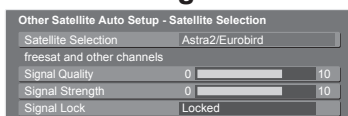

If you select "Any Satellite", this step is skipped.

- It takes a while to check the connection for your selected satellite.
- Ensure that the Signal Lock status is shown as "Locked". If it is not locked, the search cannot be executed.
- If the status is shown as "Not locked" and Signal Quality / Signal Strength have no indications, please check the dish alignment.
If the status is shown as "Not locked" but there are some levels of Signal Quality / Signal Strength indicated, select "Any Satellite" in Satellite Selection and try again.

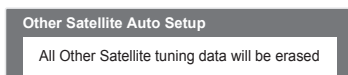

③ Set the search mode and start Auto Setup

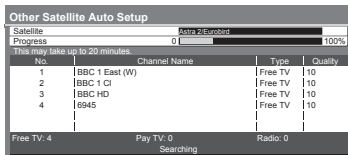
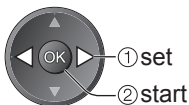

- If you select "Astra2/Eurobird" or "Any Satellite", freesat channels will also be searched. But the channels which have already been tuned in freesat will not be duplicated.

Settings are made automatically

When the operation is completed, the channel at channel position "1" will be displayed.

Add Other Sat. channel automatically Add New Channels

You can add any new channels found automatically to Channel List.

① Check the signal condition

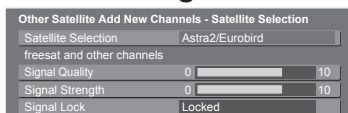

If you selected "Any Satellite" in Auto Setup, this step is skipped.

- It takes a while to check the connection for your selected satellite.
- Ensure that the Signal Lock status is shown as "Locked". If it is not locked, the search cannot be executed.
- If the status is shown as "Not locked" and Signal Quality / Signal Strength have no indications, please check the dish alignment.

② Set the search mode and start Add New Channels

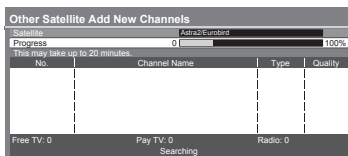
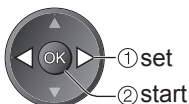

- The new channel is added with the current settings saved as they are.

Tuning and Editing Channels (Other Sat.)

List favourite Other Sat. channels **Favourites Edit**

Create your favourite channel lists from various broadcasters (up to 4: Favourites1 to 4). The Other Sat. Favourites lists are available for switching in the Information banner (p. 16).

① Select a channel to list

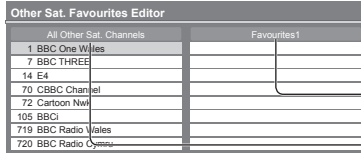

- To display other Favourites → green
- To change the category → red

② Add it to the Favourites list

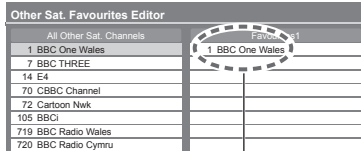

- To add all channels to the list → yellow

A channel is added

■ To edit Favourites list



Select the field of Favourites to edit and:

- To delete the channel → OK
- To name the Favourites → red
- To delete all channels → yellow

Set characters one by one

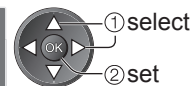
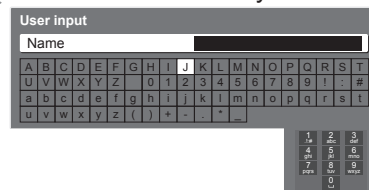

You can set characters by using numeric buttons.
→ "Characters table for numeric buttons" (p. 69)

- To move the channel → green → Select the new position → OK → Confirm → green

③ Store



Skip unwanted Other Sat. channels, Edit Other Sat. Channels **Channel List**

You can hide unwanted Other Sat. channels. The hidden channels cannot be displayed except in this function. Use this function to skip unwanted channels.

Select a channel and reveal / hide

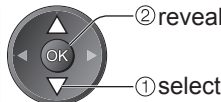

- To reveal all channels → yellow

☑ : reveal
☐ : hide (skip)

A channel cannot be identified is shown as "Unknown"

■ To edit channels

You can also edit each channel in Channel List.



Select a channel to edit and:

- To delete the channel → red
- To swap the channel position → green → Enter the new position number

Channel position



Child Lock

You can lock specific channels / AV input terminals and control who watches them. When the locked channel / input is selected, a message appears; by entering the PIN number, you can watch it.

- 1 Display the menu**
MENU
- 2 Select "Setup"**

VIERA Main Menu
Picture
Sound
Setup
- 3 Select "Child Lock"**

Setup Menu
Timer Programming
Off Timer Off
Link Settings
Child Lock Access
freesat Tuning Menu
Other Sat. Tuning Menu
Display Settings
System Menu
Other Settings
- 4 Set**

● To return to TV
EXIT

● Tuning and Editing Channels (Other Sat.)
● Child Lock

Control channel audience **Child Lock**

1 Enter the PIN number (4 digits)

- Enter the PIN number twice at first setting.
- Make a note of the PIN number in case you forget it.

2 Select "Child Lock List"

3 Select the channel / input to be locked

Name	Input	Type	Lock
101 BBC1 Wales	freesat	Free TV	
7 BBC THREE	DVB	Free TV	🔒
14 E4	DVB	Free TV	
VCR	Analogue	Analogue	
1 BBC1	Analogue	Analogue	
2 ****	Analogue	Analogue	
AV1	External	AV	
AV2/S	External	AV	

- To cancel → Select the locked channel / input → OK
- To jump to the top of the next input → red
- To lock all → green
- To cancel all locks → yellow

Appears when the channel / input is locked

■ To change the PIN number Select "Change PIN"

Enter a new PIN number twice



Note

- Setting "Shipping Condition" (p. 49) erases the PIN number and all settings.

Advanced

Network Settings

Network settings are for applications from broadcasters to enable greater interactivity and added features for freesat services.

- To connect to your network → p. 66 and p. 71



1 Display the menu
MENU



2 Select "Setup"

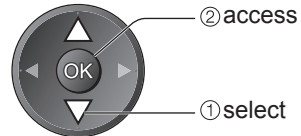

3 Select "Link Settings"

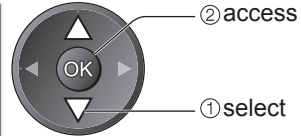
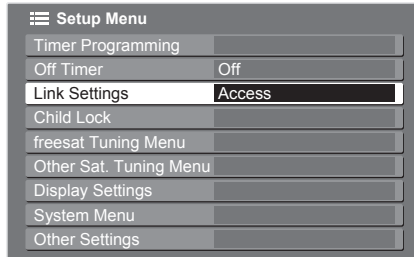

4 Select "Network Setup"

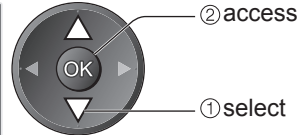
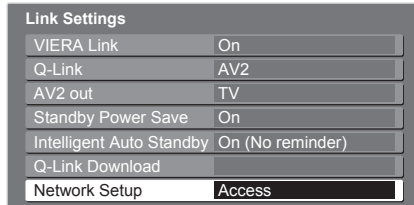

■ To return to TV



5 Set

① Set the network setting items

■ Acquire IP Address

■ Acquire DNS Address

Sets IP Address, Subnet Mask, Gateway, Primary DNS and Secondary DNS.
For most users, the recommended method of connection to your network is by using Auto feature.

Select "Acquire IP Address" and then set to "Auto"

Select "Acquire DNS Address" and then set to "Auto"

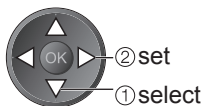
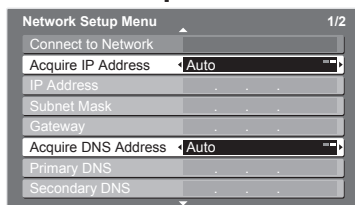

Manual settings

If you wish to set these functions manually, select "Manual".

Select "IP Address", "Subnet Mask", "Gateway", "Primary DNS" or "Secondary DNS"

Move the cursor and enter the number



- The available settings are displayed automatically.

■ Proxy

Sets Proxy address.

- This is the address of the relay server that is connected to the target server instead of the browser and sends data to the browser. Setting is required if specified by the provider.

Select "Proxy"

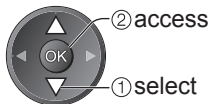
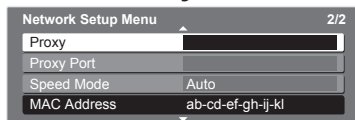

Enter the address

Set characters one by one

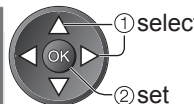
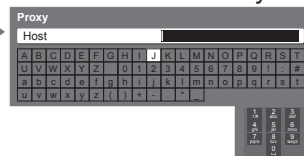

Store



- You can set characters by using numeric buttons.
 - "Characters table for numeric buttons" (p. 69)

■ Proxy Port

Sets Proxy port number.

- This number is also specified by the provider with the Proxy address.

Select "Proxy Port"

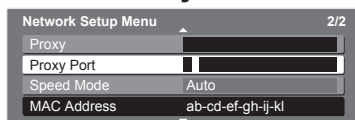

Move the cursor and enter the number



■ Speed Mode (Auto / 10base half / 10base duplex / 100base half / 100base duplex)

Sets the LAN speed setting.

- Set to "Auto" normally.
- If "Connect to Network" test fails, try the other speed modes.

Select "Speed Mode" and then set the speed mode

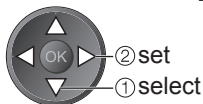
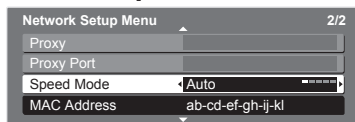

② Select "Connect to Network" and access to test

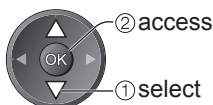
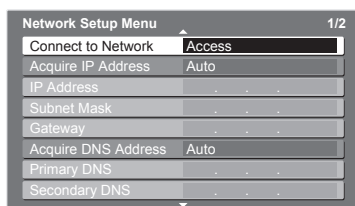

Connected

The test is successful and the network settings become effective.

Not connected

Check the settings and connections, and then perform this function again.

Performs automatic testing of the network connection for the TV.

- It takes a while to test.

Note

MAC Address

- MAC address is a unique address that identifies hardware in the network. (for information only)

Input Labels

For easier identification and selection of the input mode, you can label each input mode or skip terminal that is not connected to any equipment.

- To select the input mode → p. 24



1 Display the menu



2 Select "Setup"

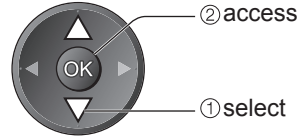
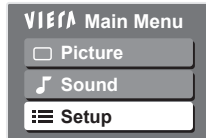

3 Select "Display Settings"

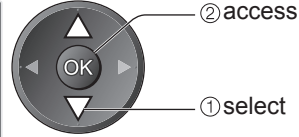
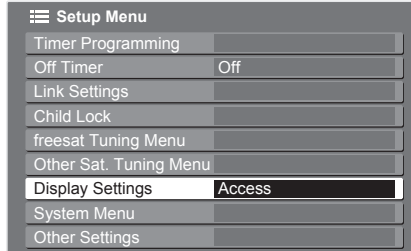

4 Select "Input Labels"

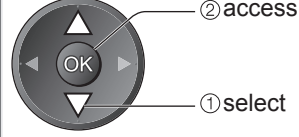
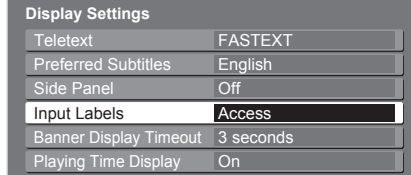

5 Select a input terminal and set

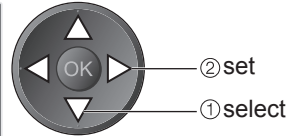
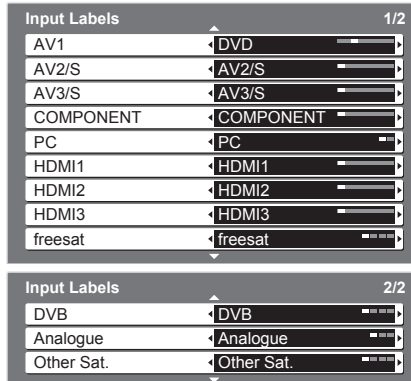

■ To return to TV
EXIT
→

The labels you set will be displayed in "Input Selection" menu (p. 24), "TV Selection" menu (p. 15) or banner.

- If "Skip" is selected, you cannot select the mode.

■ User input

You can name each input mode freely.

Select "User input"

Set characters one by one
(maximum: ten characters)

Store

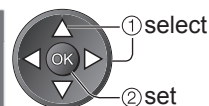
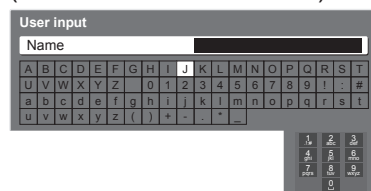

- You can set characters by using numeric buttons.
➔ "Characters table for numeric buttons" (p. 69)

Shipping Condition

Resets the TV to its original condition, i.e. no channels tuned in.
All settings other than "Owner ID" are reset (channels, picture, sound settings, etc.).



1 Display the menu
MENU

2 Select "Setup"

VIEW Main Menu	
Picture	
Sound	
Setup	

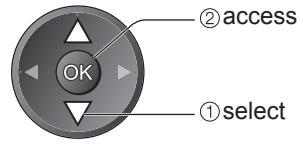

3 Select "System Menu"

Setup Menu	
Timer Programming	
Off Timer	Off
Link Settings	
Child Lock	
freesat Tuning Menu	
Other Sat. Tuning Menu	
Display Settings	
System Menu	Access
Other Settings	

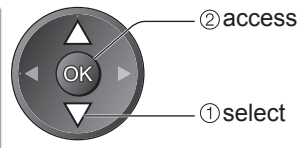

4 Select "Shipping Condition"

System Menu	
Shipping Condition	Access
Owner ID	
Common Interface	
System Update	
Software Licence	
System Information	

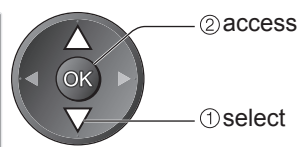

To return to TV
EXIT

5 Set

Restore Settings | **Shipping Condition**

1 Check the message and initialise

Shipping Condition	
All tuning data will be erased	
Are you sure?	
Are you sure?	
Confirm	EXIT
	RETURN

OK (confirm)
 ↓
 OK (confirm)
 ↓
 OK (start Shipping Condition)

2 Follow the on-screen instructions

Reset to Factory Shipping Condition Completed.

Please switch off TV.

● "Auto Setup" will automatically start when Mains power On / Off switch is next turned On. (p. 12)

To retune TV channels only, e.g. after moving house
 → "Retuning from Setup Menu" (p. 34 and p. 35)

Advanced Settings

Advanced Settings provide various features.



1 Select freesat, DVB, Analogue or Other Sat.
→ p. 15
TV

2 Display the menu
MENU

3 Select "Setup"
VIFF Main Menu
Picture
Sound
Setup

4 Select "System Menu"
Setup Menu
Timer Programming
Off Timer Off
Link Settings
Child Lock
freesat Tuning Menu
Other Sat. Tuning Menu
Display Settings
System Menu Access
Other Settings

5 Select one of the following functions
System Menu
Shipping Condition
Owner ID Access
Common Interface Access
System Update Access
Software Licence
System Information

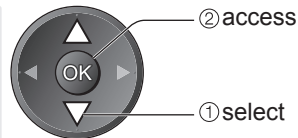
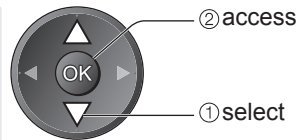
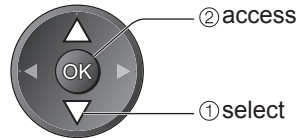

● "Common Interface" is available in DVB or Other Sat. mode only.

■ To return to TV



6 Set

Update TV's software system **System Update**

Download new software to TV.

● For details → p. 71

If System Update is performed, the software will be updated (it may change TV functions). If you do not wish to do so, set "Auto Update Search in Standby" to "Off".

Select "Auto Update Search in Standby" and then set "On" or "Off"

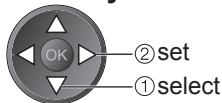

● On: Automatically performs a search in standby and downloads an update, if any software updates are available.

■ To update immediately

Select "System Update Search Now"

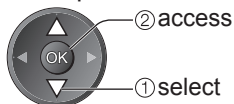

→ Searches for an update (for several mins.) and displays a corresponding message if any →

Download



● Download may take up to 60 mins.

Input owner ID **Owner ID**

Entry of the PIN number and personal information (your name, address and postcode).
In the unfortunate event of theft it will help the Police to determine the owner.

① Enter the PIN number (4 digits)



- Enter the PIN number twice at first setting.
- Make a note of the PIN number in case you forget it.

② Enter your name, address, and postcode, in that order

Select NAME / HOUSE NO / POSTCODE

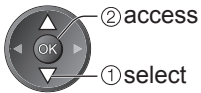
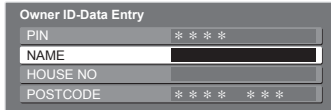

Set characters one by one

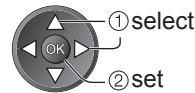
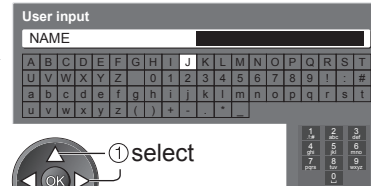

- You can set characters by using numeric buttons.
- ➔ "Characters table for numeric buttons" (p. 69)

Return to select other items



or

Exit the menu



■ To check the personal information stored

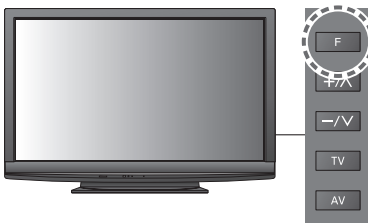

Hold down for about 6 sec.

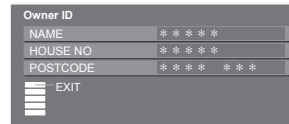

- The PIN number is not displayed.

■ To change the PIN number

Select "PIN"

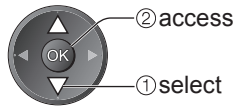
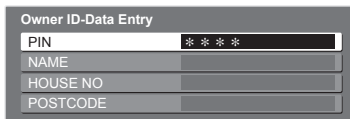

Enter a new PIN number twice



Pay-TV **Common Interface**

The Common Interface Module menu provides access to software contained on Common Interface (CI) Modules.

This TV receiver works only Pay TV modules complying with CI standard.

- This function is not available for BSkyB's Sky channels.

Caution

- Turn Off Mains power On / Off switch whenever inserting or removing the CI module.
- If a view card and a card reader come as a set, first insert the card reader, then insert the view card into the card reader.
- Insert the module in the correct direction.

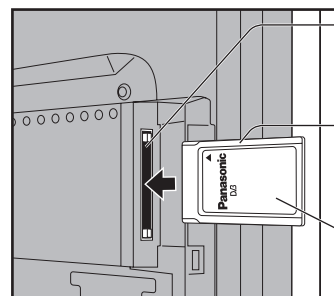

Side of the TV

① Insert the CI module (optional)

- The features that appear on screen are dependent on the contents of the selected CI module.
- Normally pay-TV channels will appear without ② and ③.
- If pay-TV channel does not appear, perform ② and ③.
- For more details, see the manual of the CI module, or check with the broadcaster.

② Access "Common Interface"

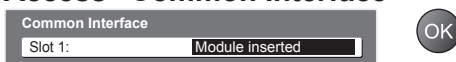

③ Follow the on screen operation guide

For example: select, go → OK



- On screen operation guide may not correspond to the remote control buttons.

Coloured characters → red green yellow blue

Recording Controls

Timer Programming from Menu

The Timer programming menu allows you to choose programmes that you wish to record. At the correct time, the TV will switch on and tune to the correct channel (even if the TV is in Standby mode).

TV Guide may also be used to set timer programming. (p. 20)

- If the recorder is compatible with Q-Link or similar technologies (p. 60), and setup / connection are done completely (p. 58 and p. 60), you do not need to programme the recorder – the TV will control the recording progress.
- If the recorder is not compatible with Q-Link or similar technologies, set “Q-Link” in the Setup Menu (p. 32) to the connected terminal (AV1 or AV2), and make timer programming of the recorder (Read the manual of the recorder).
- Recording is possible in composite video via SCART only - including HD content.
- While recording, you cannot watch any other channels except the one being recorded.

1 Select the mode you want to set a recording
 → p. 15
 TV

2 Display the menu
 MENU

3 Select “Setup”

VIERA Main Menu	
Picture	
Sound	
Setup	

4 Select “Timer Programming”

Setup Menu	
Timer Programming	Access
Off Timer	Off
Link Settings	
Child Lock	
freesat Tuning Menu	
Other Sat. Tuning Menu	
Display Settings	
System Menu	
Other Settings	

5 Set

■ To return to TV



■ To stop recording



Caution

- The TV must either be On or in standby.
- For preparations of a recorder, read the manual of the recorder.
- No other channel can be selected during recording.
- It may not be possible to record an encrypted programme (which is copy-protected).

Set timer programming details Timer Programming

① Start making the settings



② Repeat the operations as below, and set items in the order of ① to ⑤



● ①, ③ and ④ can also be entered with numeric buttons.



FS: freesat

D: DVB

A: Analogue

S: Other Sat.

(you cannot change TV mode within the menu)

Timer recording

Records according to the time setting

Guide: Guide link recording

Records according to the TV Guide signal (p. 20)

S/P: Split Programme (p. 20)

Displayed if the timer programming events are overlapped

Timer Programming		Wed 15/10/08 18:50				
No.	Channel Name	Date	Start	End	min.	STTL
D 7	BBC THREE <TIMER>	17/10 FR	17:00	18:30	90	Off
D 1	BBC1 Holiday News	18/10 FR	18:00	20:00	120	Off
D 3	ITV1 Freshly Squeezed Extra	18/10 SA	21:30	22:30	60	Off
---	---	---	---	---	---	---

⑤ Subtitles (Off / Auto)

● Recording time (automatic display)

Current timer programming event

① Channel name

② Date

● one day ahead

● daily or weekly (press repeatedly)

④ Ending time

③ Starting time

● Daily SU-SA: Sunday to Saturday

● Daily MO-SA: Monday to Saturday

● Daily MO-FR: Monday to Friday

● Weekly SA/FR/TH/WE/TU/MO/SU:
Same time on the same day every week

③ Store



■ To change a timer programming event

→ Select the programme to be changed ② access → Correct as necessary (as above)

■ To cancel a timer programming event

→ Select the programme to be deleted red → OK

■ To cancel a timer programming event temporarily

→ Select the programme to be cancelled blue ● Each time pressed: cancel ↔ stop cancelling

■ To view details of the programming

→ Select the programme to be viewed i ● Press again to return to Timer Programming menu.

■ Guide link recording (Timer Programming from the TV Guide signal) → p. 20

● Not available in Analogue or Other Sat. mode.

Guide link recording is a timer programme controlled by information from the TV Guide.

Programme start and end times may be changed by broadcasters and sent to the TV for timer programme to follow the change.

Split Programme is a programme which is interrupted by one or more programmes.

Both of the above are subject to signals being sent by broadcasters.

■ Direct TV Recording → p. 60 and p. 62

You can record the current programme to DVD Recorder / VCR immediately using Q-Link or VIERA Link.

Note

- Check that the Timer LED (Orange) is lit. If not, timer programmes are not active or not stored.
- "!" will identify any timer programming events that have been set and overlap. If this occurs then the first timer programming event will start and finish as programmed. The next timer programming event can then start.
- 2 mins. before the starting time, a reminder message appears.

(To remove the message → OK; To cancel the programming → EXIT)

- A Timer Programming event will automatically change to the desired channel 10 seconds before the start time.
- To stop Timer Programming event directly prior to the start time, it is necessary to stop the recorder manually.
- Timer Programming will be performed even if the TV is in Pause Live TV recording (p. 63). In this case, Pause Live TV recording will be cancelled.

Viewing from SD Card

(VIERA IMAGE VIEWER)

Photo View: Still images recorded by digital cameras will be displayed.

Movie View: Moving pictures recorded by digital video cameras will be played back.

- During the operation, sound signal is output from AV1, AV2, AUDIO OUT and DIGITAL AUDIO OUT terminals. But no video signals are output.
- "Date" shows the date on which the recording was made by the digital camera or digital video camera. The file without record of the date is shown "***/**/****".
- For details on SD Cards → p. 69

■ To insert the SD Card

Label surface

Push until a click is heard

■ To remove the SD Card

Press the centre of the card

Blue LED

- Blue LED lights while SD Card is inserted if "SD Card LED" is set to "On" in the Setup Menu (p. 33).

Photo View



- 1 Insert the SD Card**
- 2 Select "Photo View"**

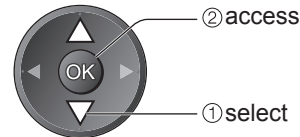
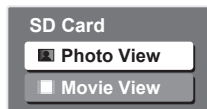

- You can also access directly by using VIERA TOOLS → "How to Use VIERA TOOLS" (p. 14)

- 3 Select the folder to display the thumbnail**

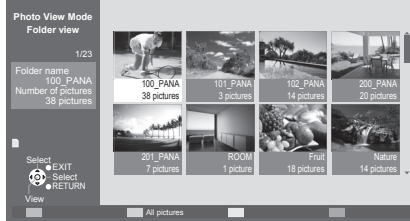

(Folder view)

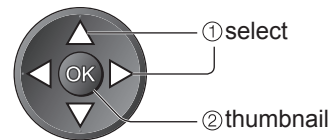

- The files which are not into a folder will be collected to the folder named "I".

- 4 Select the file from the thumbnail to be viewed**

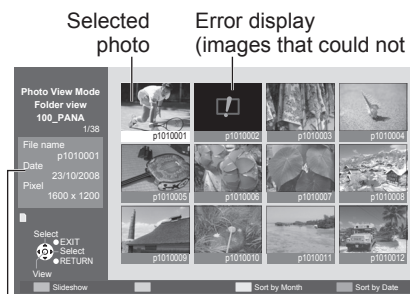

(Thumbnail)

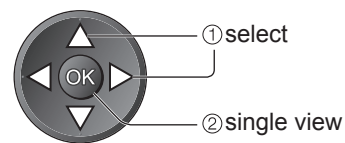

- Slideshow → p. 55

■ To return to TV
EXIT or

■ To return to the previous screen

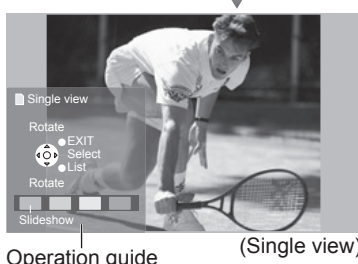

(Single view)

Displayed one at a time
• To display / hide the operation guide

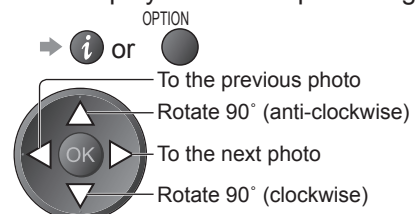

- To return to thumbnail →

Slideshow

Start Slideshow (operate in step 4)

Select the photo for the first view

Start Slideshow



To pause

To return to Single view



Note

- Slideshow is done within the thumbnail.
- You can also start slideshow directly by using VIERA TOOLS → “How to Use VIERA TOOLS” (p. 14)

Slideshow settings (operate in Photo View Mode)

Display the menu



Select “Viewing Setup”

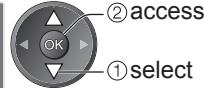
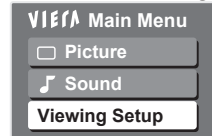

• Other Items → p. 30 and p. 31

Select the items and set

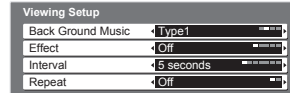

Menu	Item	Adjustments / Configurations (alternatives)
Viewing Setup	Back Ground Music	Selects the back ground music during the slideshow (Off / Type1 / Type2 / Type3)
	Effect	Selects the effect for switching the photo during the slideshow (Off / Fade / Slide / Dissolve / Random) Fade : The next photo fades in gradually Slide : The next photo slides and appears from the left side Dissolve : The photo is replaced by an indefinite block unit Random : Selects each effect at random
	Interval	Selects slideshow interval (5 / 10 / 15 / 30 / 60 / 90 / 120 seconds)
	Repeat	Slideshow repeat (Off / On)

To display all the photos

Display the thumbnail of all the photos in SD Card.

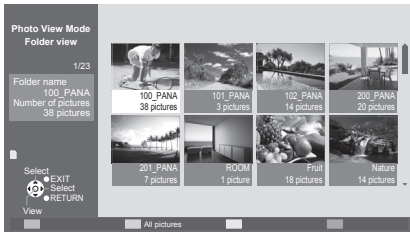

(Folder view)

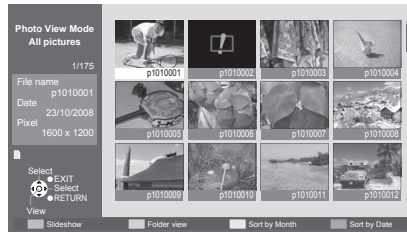

(Thumbnail - All pictures)

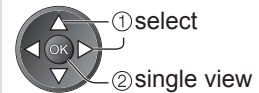

To sort by date or month recorded

Display the list of groups sorted by the same date or the same month.

- The group of the photos without record of the date is shown as “Unknown”.



(Thumbnail)



(Sort by Month)

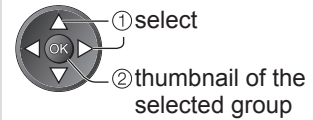

(Sort by Date)

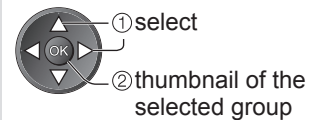

Viewing from SD Card

(VIERA IMAGE VIEWER)

Movie View



1 Insert the SD Card

2 Select "Movie View"

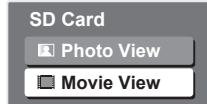

② access

① select

- You can also access directly by using VIERA TOOLS
- "How to Use VIERA TOOLS" (p. 14)

3 Select the file to be viewed

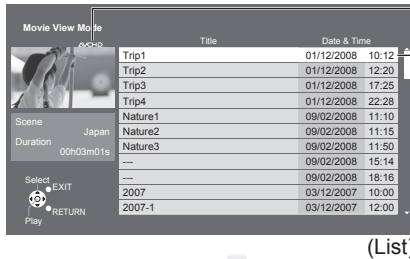

File format:
Only AVCHD or MPEG2 are supported.
● For details → p. 69

Selected movie



② playback

① select



■ To return to TV



■ To return to the previous screen

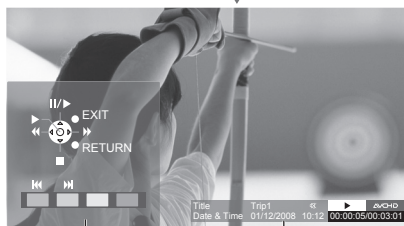

Operation guide (Playback)

information banner → i

- To return to list → (stop)
- To change aspect ratio (only for the 4:3 movie content) → ASPECT

Playback will start

- To display the operation guide



- To hide the operation guide → BACK/RETURN

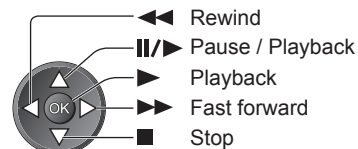

- To the previous movie → red

- To the next movie → green

Audio Settings

You can enjoy the multi-channel sound via an amplifier connected to DIGITAL AUDIO OUT terminal.

■ To confirm or change the current sound status (during playback)

Display the Option menu



(Current sound status)

Change the sound (if the movie has multiple audio signals)



change

- It may take several seconds to change the sound.

■ Audio output settings (operate in step 3)

Display the menu



Select "Sound"

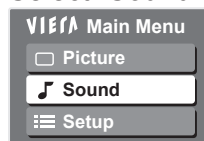

- Other items → p. 30 - 33



② access

① select

Select "SPDIF Selection" and set

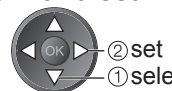
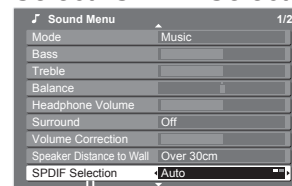

② set

① select

Menu	Item	Adjustments / Configurations (alternatives)
Sound	SPDIF Selection	SPDIF : A standard audio transfer file format
		Selects the initial setting for digital audio output signal from DIGITAL AUDIO OUT terminal (Auto / PCM) Auto: Dolby Digital is output as Dolby Digital Bitstream. MPEG is output as PCM. PCM: Digital output signal is fixed to PCM.

Displaying PC Screen on TV

The screen of the PC connected to the TV can be displayed on the TV.
You can also listen to PC sound with the audio cable connected.

● To connect PC → p. 66



1 Select the external input
AV

2 Select "PC"

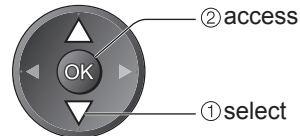
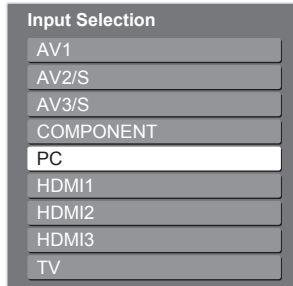

- Corresponding signals → p. 72
- If "H-freq." or "V-freq." is shown in red, the signals may not be supported.

■ To return to TV



■ PC menu setting (changed as desired)

● To make settings → "How to Use Menu Functions" ① to ④ (p. 26)

Menu	Item	Adjustments / Configurations (options)	
Picture	Advanced PC Settings	W/B High R White balance of bright red area	
		W/B High B White balance of bright blue area	
		W/B Low R White balance of dark red area	
		W/B Low B White balance of dark blue area	
		Gamma Switches the gamma curve (S Curve / 2.0 / 2.2 / 2.5)	
	Reset to Defaults	Press the OK button to reset to the default Advanced PC Settings	
Setup	PC Setup	Input Resolution Switches to a wide view ● VGA (640 × 480 pixels), WVGA (852 × 480 pixels), XGA (1,024 × 768 pixels), WXGA (1,280 × 768 pixels, 1,366 × 768 pixels) ● Options change depending on signals	
		Clock Set to the minimum level if noise occurs	
		H-pos Adjusts horizontal position	
		V-pos Adjusts vertical position	
		Clock Phase Eliminates flicker and distortion ● Adjust after Clock adjustment ● Set to the minimum level if noise occurs	
		Sync Chooses another synchronous signal if the image is distorted (H & V / On Green) ● H & V : by the horizontal and vertical signals from your PC On Green: by the green signal from your PC (if available)	
		Reset to Defaults	Press the OK button to reset to the default PC Setup settings

● Other items → p. 30 - 33

Note

● For HDMI-compatible PC, possible to connect to HDMI terminals (HDMI1 / HDMI2 / HDMI3) by using HDMI cable (p. 70).

Link Functions (Q-Link VIERA Link)

Q-Link connects the TV and DVD Recorder / VCR, and enables easy recording, playback, etc. (p. 60)
 VIERA Link (HDAVI Control™) connects the TV and the equipment with VIERA Link function, and enables easy control, convenient recording, playback, energy saving, creating home theatre, etc., without complicated setting. (p. 61 - 65)

You can use Q-Link and VIERA Link functions together.

- This TV supports "HDAVI Control 4" function. But available features are depending on the connected equipment's version of HDAVI Control. Please refer to the manual of the equipment to confirm the version.

Summary of Q-Link and VIERA Link features

■ Q-Link (SCART connection only)

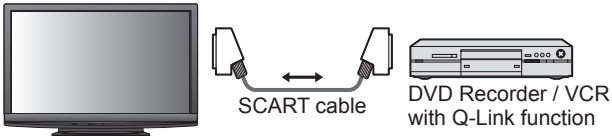
Features	Connected equipment DVD Recorder / VCR with Q-Link function	Connection
Analogue channel download	○	 <p>● Use fully wired SCART cable. ● Connect the DVD Recorder / VCR supporting Q-Link to the TV's AV1 or AV2 terminal via a SCART cable.</p>
Easy playback	○	
Power on link	○	
Power off link	○	
Direct TV Recording	○	

■ VIERA Link (HDMI connection only)

Features	Connected equipment DIGA Recorder with VIERA Link function	DVD Player / Blu-ray Disc Player with VIERA Link function	HD Video Camera / LUMIX Camera with VIERA Link function
Analogue channel download	—	—	—
Easy playback	○	○	○
Power on link	○	○	○
Power off link	○	○	○
Reduce unnecessary power consumption in standby	○*3	○*3	—
Auto standby for unnecessary equipment	○*1	○*1	—
Pause Live TV programme	○*3 *4	—	—
Direct TV Recording	○*3	—	—
Control the menu of the connected equipment by VIERA remote control	○*1	○*1	○*1
Speaker control	—	—	—

Connection

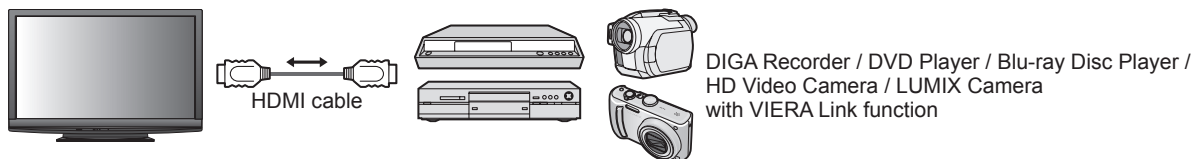

- Use fully wired HDMI compliant cable.
- Connect the equipment supporting VIERA Link to the TV's HDMI1, HDMI2 or HDMI3 terminal via an HDMI cable.
- About HDMI cable for connecting Panasonic HD Video Camera or LUMIX Camera, read the manual of the equipment.

■ VIERA Link (HDMI and SCART connections)

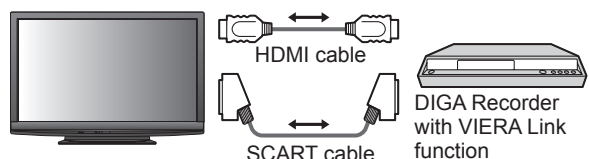
Features	Connected equipment DIGA Recorder with VIERA Link function	Connection
Analogue channel download	○	 <p>● Use fully wired HDMI compliant cable. ● Connect the equipment supporting VIERA Link to the TV's HDMI1, HDMI2 or HDMI3 terminal via an HDMI cable. ● Use fully wired SCART cable. ● Connect the equipment supporting VIERA Link to the TV's AV1 or AV2 terminal via a SCART cable.</p>
Easy playback	○	
Power on link	○	
Power off link	○	
Reduce unnecessary power consumption in standby	○*3	
Auto standby for unnecessary equipment	○*1	
Pause Live TV programme	○*2 *4	
Direct TV Recording	○*2	
Control the menu of the connected equipment by VIERA remote control	○*1	
Speaker control	—	

■ VIERA Link (HDMI and Audio out connections)

Features	Connected equipment	Player theatre with VIERA Link function	Blu-ray Disc theatre with VIERA Link function	Amplifier with VIERA Link function
Analogue channel download		—	—	—
Easy playback		○*5	○*5	—
Power on link		○	○	—
Power off link		○	○	○
Reduce unnecessary power consumption in standby		—	○*3	—
Auto standby for unnecessary equipment		○*1 *6	○*1 *6	○*1
Pause Live TV programme		—	—	—
Direct TV Recording		—	—	—
Control the menu of the connected equipment by VIERA remote control		○*1	○*1	—
Speaker control		○	○	○

Connection

● To use Player theatre / Blu-ray Disc theatre:

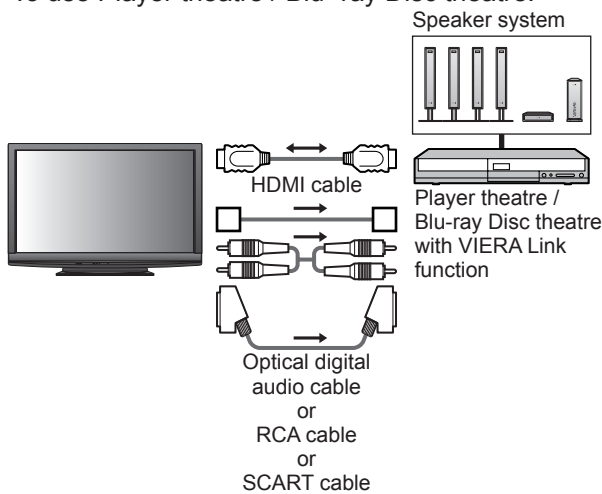

● To use Amplifier:

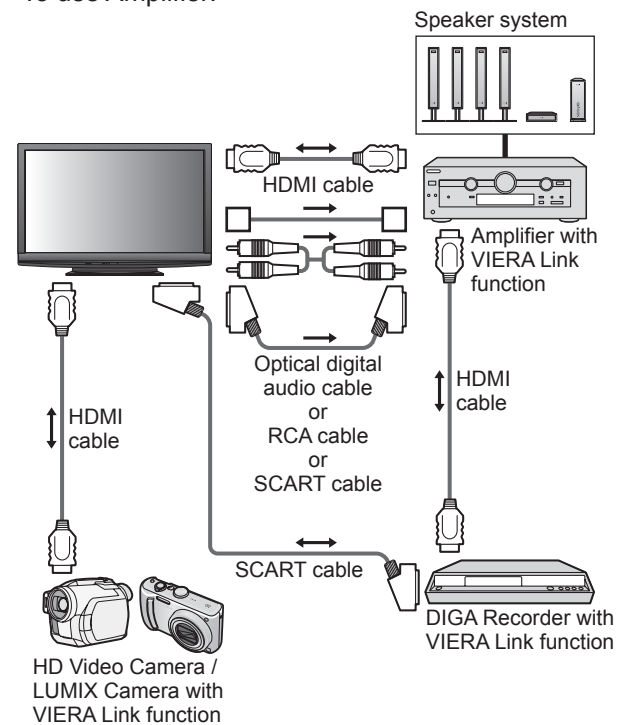

- Use fully wired HDMI compliant cable.
- Connect the equipment supporting VIERA Link to the TV's HDMI2 or HDMI3 terminal via an HDMI cable.
- Use fully wired SCART cable.
- Connect the equipment supporting VIERA Link to the TV's AV1 or AV2 terminal via a SCART cable.
- Use any one of the optical digital audio cable, RCA cable and SCART cable for audio output from the TV.

*1: Available with the equipment which has "HDAVI Control 2 or later" function.

*2: Available with the equipment which has "HDAVI Control 3 or later" function.

*3: Available with the equipment which has "HDAVI Control 4" function.

*4: Available with DIGA Recorder which has HDD.

*5: while playingback a disc

*6: except for watching a disc

Note

- VIERA Link features may be available even with other manufacturers' equipment supporting HDMI CEC.

Link Functions (Q-Link VIERA Link)

Q-Link

■ Preparations

- Connect the DVD Recorder / VCR with the following logos:
“Q-Link”, “NEXTVIEWLINK”, “DATA LOGIC”, “Easy Link”, “Megalogic” or “SMARTLINK”
- Q-Link connection → p. 58
- Use fully wired SCART cable.
- Set up the DVD Recorder / VCR. Read the manual of the recorder.
- Q-Link terminal setup in the Setup Menu → “Q-Link” (p. 32), “AV1 / AV2 out” (p. 32)
- Download Analogue channel setting → “Analogue channel download” (see below)

■ Features available

Analogue channel download

Analogue channel setting can be downloaded to the recorder with analogue tuner. Digital channel setting is not downloaded.

- To download Analogue channel setting → “Q-Link Download” (p. 32) or “Auto Setup” in Analogue mode (p. 35) or “Auto Setup” - when first using the TV (p. 12)

Direct TV Recording - What you see is What you record

Recording the current programme in DVD Recorder / VCR immediately.



- Available conditions:

Picture source	Mode	Recording from
Analogue	TV	TV monitor out
	AV	Recorder's tuner
DVB	TV	TV monitor out
AV (watching recorder's tuner)	AV	Recorder's tuner
AV (watching recorder's external input)	AV	Recorder's external input
AV (watching TV's external input)	AV	TV monitor out

- When Direct TV Recording is performed, the recorder is automatically turned on if it is in Standby mode.
- Changing channel or turning off the TV is available while the recorder is recording from its own tuner.
- Changing channel is not available while the recorder is recording from the TV tuner.

■ To stop recording

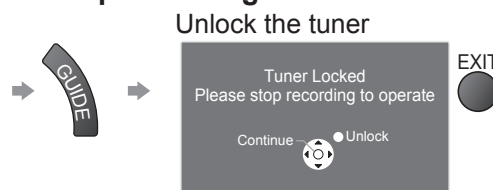

Power on link and Easy playback

When DVD Recorder / VCR starts playback or direct navigator / function menu for the equipment are activated, the TV is turned on and input mode is switched automatically so that you can view the content. (Only when the TV is in Standby mode.)

Power off link

When TV is set to Standby mode, the recorder is also automatically set to Standby. (Only when the videocassette or disc is not active.)

- This function will work even if the TV enters standby mode automatically by Off Timer function or auto power standby function.

- “DATA LOGIC” (a trademark of Metz Corporation)
- “Easy Link” (a trademark of Philips Corporation)

- “Megalogic” (a trademark of Grundig Corporation)
- “SMARTLINK” (a trademark of Sony Corporation)

Note

- Some recorders are not applicable. Read the manual of the recorder.

VIERA Link “HDAVI Control™”*

*Enjoy additional HDMI Inter-Operability with Panasonic products which have “HDAVI Control” function. This TV supports “HDAVI Control 4” function.

Connections to the equipment (DIGA Recorder, HD Video Camera, Player theatre, Amplifier, etc.) with HDMI and SCART cables allow you to interface them automatically (p. 58 and p. 59).

These features are limited to models incorporating “HDAVI Control” and “VIERA Link”.

- Some functions are not available depending on the equipment’s version of HDAVI Control. Please confirm the connected equipment’s version of HDAVI Control.
- VIERA Link “HDAVI Control”, based on the control functions provided by HDMI which is an industry standard known as HDMI CEC (Consumer Electronics Control), is a unique function that we have developed and added. As such, its operation with other manufacturers’ equipment that supports HDMI CEC cannot be guaranteed.
- Please refer to individual manuals for other manufacturers’ equipment supporting VIERA Link function.
- About applicable Panasonic equipment, consult your local Panasonic dealer or refer to the URL: www.panasonic.co.uk

■ Preparations

- Connect the equipment supporting VIERA Link.
- VIERA Link connection → p. 58 and p. 59
- Use fully wired HDMI compliant cable. Non-HDMI-compliant cables cannot be utilized.
Recommended Panasonic’s HDMI cable part number:
 - RP-CDHG10 (1.0 m)
 - RP-CDHG15 (1.5 m)
 - RP-CDHG20 (2.0 m)
 - RP-CDHG30 (3.0 m)
 - RP-CDHG50 (5.0 m)
- Use fully wired SCART cable.
- Set up the connected equipment. Read the manual of the equipment.
- For optimal recording, the settings of the recorder may need to be changed. For details, read the manual of the recorder.
- Download Analogue channel setting → “Analogue channel download” (see below)
- Set VIERA Link On in the Setup Menu → “VIERA Link” (p. 32)
- Set up the TV
 - ➔ **After connection, turn the equipment on and then switch the TV on.**
Select the input mode to HDMI1, HDMI2 or HDMI3 (p. 24), and make sure that an image is displayed correctly.
This setup should be done each time when the following conditions occur:
 - for the first time
 - when adding or reconnecting equipment
 - when changing setup

■ Features available

Analogue channel download

Analogue channel setting can be downloaded to the recorder with analogue tuner. Digital channel setting is not downloaded.

- To download Analogue channel setting → “Q-Link Download” (p. 32) or “Auto Setup” in Analogue mode (p. 35) or “Auto Setup” - when first using the TV (p. 12)

Easy playback

Automatic Input switching - When the connected equipment is operated, input mode is switched automatically. When it is stopped operating, input mode is returned.

Power on link

When the connected equipment starts playback or direct navigator / function menu for the equipment are activated, the TV is automatically turned on. (Only when the TV is in Standby mode.)

Power off link

When the TV is set to Standby mode, the connected equipment is also automatically set to Standby.

- This function will work even if the TV enters standby mode automatically by Off Timer function or auto power standby function.

Link Functions (Q-Link VIERA Link)

■ Features available

Reduce unnecessary power consumption in standby **Standby Power Save**

Set Standby Power Save “On” in the Setup Menu to use this function

→ “Standby Power Save” (p. 32)

The power consumption in Standby mode of the connected equipment is controlled higher or lower in synchronization with the TV On / Off state to reduce the consumption.

When the TV is set to Standby mode, the connected equipment is automatically set to Standby and the power consumption in Standby mode of the connected equipment is automatically minimized.

When the TV is turned on, the connected equipment is still in Standby mode, but the power consumption is increased to make startup time early.

- This function is effective if the connected equipment can change the power consumption in Standby mode and is set to higher consumption.

Auto standby for unnecessary equipment **Intelligent Auto Standby**

Set Intelligent Auto Standby “On (With reminder)” or “On (No reminder)” in the Setup Menu to use this function

→ “Intelligent Auto Standby” (p. 32)

When the TV is On, non-watched or non-used connected equipment goes into Standby mode automatically to reduce the power consumption. For example, when the input mode is switched from HDMI, when Speaker Selection is changed to “TV” (except for watching a disc).

- If you select “On (With reminder)”, the on screen message will be displayed to be noticed before working this function.
- This function may not work properly depending on the connected equipment. If required, set to “Off”.

■ Features available (Using VIERA Link Menu)

Direct TV Recording - What you see is What you record **Direct TV Rec**

Recording the current programme in DIGA Recorder immediately.

- If you connect a variety of recorders including other manufacturers' recorders at the same time, please connect DIGA Recorder to the TV's lower HDMI terminal number. For example, if you use HDMI1 and HDMI2 for two recorders, in this case connect DIGA Recorder to HDMI1.
- If you cannot operate, check the settings and the equipment
→ “Summary of Q-Link and VIERA Link features” (p. 58 and p. 59), “Preparations” (p. 61)
- Changing channel or turning off the TV is available while the recorder is recording from its own tuner.
- Changing channel is not available while the recorder is recording from the TV tuner.



1 Display “VIERA Link Menu”

2 Select “Direct TV Rec” and start recording

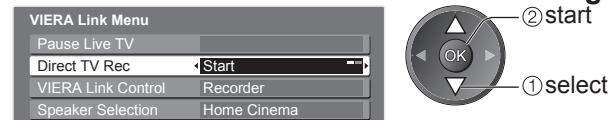

- You can also start recording directly →

■ To stop recording

Select “Stop” in “Direct TV Rec” and access

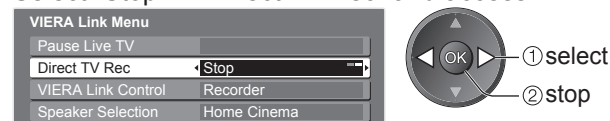

- You can also stop recording directly.

Unlock the tuner

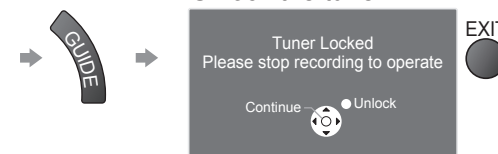

■ Features available (Using VIERA Link Menu)

Pause Live TV programme **Pause Live TV**

You can pause the live TV programme and resume later.

Live TV programme will be recorded on HDD of the connected DIGA Recorder.

- This function is available with DIGA Recorder which has HDD.
- If you connect a variety of recorders including other manufacturers' recorders at the same time, please connect DIGA Recorder which has HDD to the TV's lower HDMI terminal number. For example, if you use HDMI1 and HDMI2 for two recorders, in this case connect DIGA Recorder which has HDD to HDMI1.
- If you cannot operate, check the settings and the equipment
 - ➔ "Summary of Q-Link and VIERA Link features" (p. 58 and p. 59), "Preparations" (p. 61)

Access and pause the live TV programme



1

Display "VIERA Link Menu"



2

Select "Pause Live TV" and pause

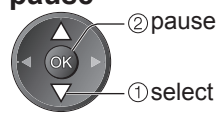
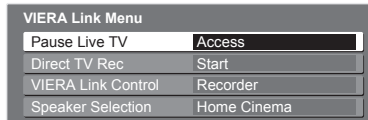

The TV picture will be paused.

- You can also pause directly by using VIERA TOOLS
 - ➔ "How to Use VIERA TOOLS" (p. 14)
- Live TV programme is recorded on HDD from where it was paused.
- If the paused TV picture disappears after a few minutes
 - ➔  (the paused picture will be restored)
- Follow the operation guide to operate Pause Live TV function.

■ To operate Pause Live TV

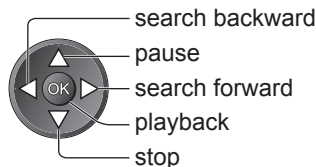

- Operations may be different depending on the recorder. In this case, follow the operation guide or read the manual of the recorder.

- If you stop playback, the recorded programme will be deleted from HDD.

■ To return to Live TV

(stop playback of Pause Live TV / cancel pause)

Select "Yes"

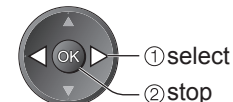
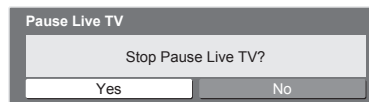

- If you stop playback or cancel pause, the recorded programme will be deleted from HDD.

Link Functions (Q-Link VIERA Link)

■ Features available (Using VIERA Link Menu)

Control the menu of the connected equipment by VIERA remote control

VIERA Link Control

You can control some functions of the connected equipment with this TV remote control (point the remote control at the TV's signal receiver).

- If you cannot operate, check the settings and the equipment
 - ➔ "Summary of Q-Link and VIERA Link features" (p. 58 and p. 59), "Preparations" (p. 61)
- For details of the operations for the connected equipment, read the manual of the equipment.

Access and operate the menu of the equipment



- 1
- 2
- 3

Display "VIERA Link Menu"

Select "VIERA Link Control"

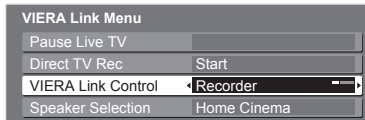

select

Select the equipment you want to access

The type of the connected equipment is displayed. Select the type of the equipment and access.

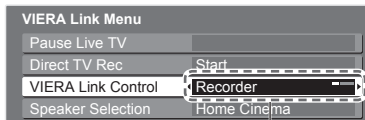

① select

② access

■ If multiple recorders or players are connected

You can connect up to three recorders or players at the same time.

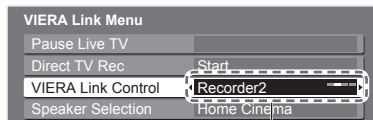

Recorder1-3 / Player1-3

The number is given from the TV's lower HDMI terminal number connected to the same type equipment. For example, two recorders to HDMI2 and HDMI3, in this case the recorder connected to HDMI2 is displayed as "Recorder1", and the recorder connected to HDMI3 is displayed as "Recorder2".

■ If you access non-VIERA Link equipment

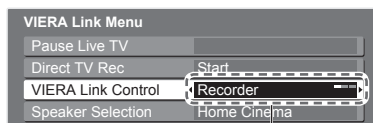

The type of the connected equipment is displayed. You can access the menu of the equipment. But you cannot operate it. Use its own remote control to operate the equipment.

Recorder / Player / Home Cinema / Video Camera / LUMIX / Other

- You can also access directly by using VIERA TOOLS
 - ➔ "How to Use VIERA TOOLS" (p. 14)
- "Home Cinema" means Player theatre, Blu-ray Disc theatre or Recorder theatre.
- "Other" means Tuner set top box.

The menu of the accessed equipment
(Input mode will be changed automatically)

- 4

Operate the menu of the equipment

Available VIERA remote control buttons:
(depending on the connected equipment)



① Set the position to "TV"



② Follow the operation guide

- To display the operation guide ➔ OPTION
 - If other manufacturers' equipment is accessed, Setup / Contents Selection menu may be displayed.
- When the key words are displayed on colour bar
 - ➔ red green yellow blue

Note

- Some operations may not be available depending on the equipment. In this case use its own remote control to operate the equipment.

■ Features available (Using VIERA Link Menu)

Speaker control **Speaker Selection**

You can control the theatre speaker with this TV remote control (point the remote control at the TV's signal receiver).

- If you cannot operate, check the settings and the equipment
 - ➔ "Summary of Q-Link and VIERA Link features" (p. 58 and p. 59), "Preparations" (p. 61)

Access and control the speaker volume

1 Display "VIERA Link Menu"

2 Select "Speaker Selection"

VIERA Link Menu	
Pause Live TV	
Direct TV Rec	Start
VIERA Link Control	Recorder
Speaker Selection	Home Cinema

3 Set to "Home Cinema" or "TV"

■ Home Cinema

Player theatre, Blu-ray Disc theatre or Amplifier will be automatically turned on if it is in Standby mode and the sound is from theatre speakers connected to the equipment.

- Volume up / down

➔ (Volume slide bar will be displayed when adjusting the volume of the equipment.)

- Mute ➔

- The sound of TV speakers is mute.
- When the equipment is turned off, TV speakers will be active.

■ TV

TV speakers are active.

Note

- If you wish to enjoy the multi-channel sound (e.g. Dolby Digital 5.1ch) via an Amplifier, connect with HDMI cable and Optical digital audio cable (p. 59), and then select "Home Cinema". To enjoy the sound from the DIGA Recorder in multi-channel sound, connect an HDMI cable from the DIGA Recorder to the Amplifier (p. 59).

Note

- These functions may not work properly depending on the connected equipment.
- Image or sound may not be available for the first few seconds when Input mode is switched.
- Easy playback may be available by using the remote control for Player theatre, Blu-ray Disc theatre or Amplifier. Read the manual of the equipment.
- "HDAVI Control 4" is the newest standard (current as of December, 2008) for HDAVI Control compatible equipment. This standard is compatible with conventional HDAVI equipment.
- To confirm this TV's version of HDAVI Control ➔ "System Information" (p. 33)

External Equipment

These diagrams show our recommendations for connection of your TV to various pieces of equipment. For other connections, consult the instructions for each piece of equipment, the table below, and the specifications (p. 79).

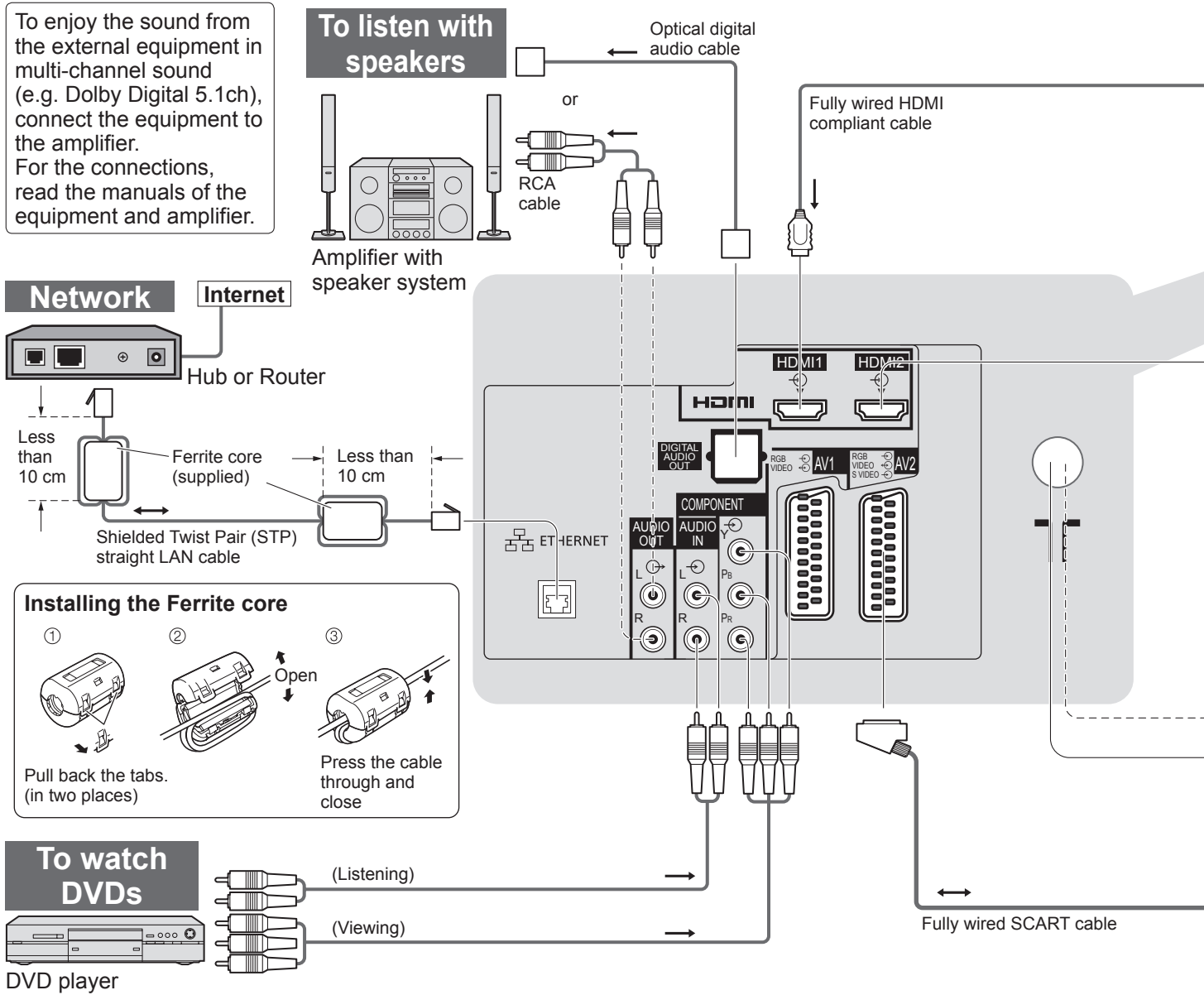

Types of connectable equipment to each terminal

Terminal	AV1	AV2	AV3 (Side panel of TV)
Recording / Playback (equipment)			
To record / playback videocassettes / DVDs (VCR / DVD recorder)	○	○	
To watch DVDs (DVD player)	○	○	○
To watch camcorder images (Video camera)	○	○	○
To watch cable broadcasts (Set top box)	○	○	○
To play games (Game equipment)	○	○	
To use amplifier with speaker system			
To use Network services for freesat			
Q-Link	○	○	
VIERA Link	○ (with HDMI)	○ (with HDMI)	
Direct TV Recording	○	○	

○: Recommended Connection

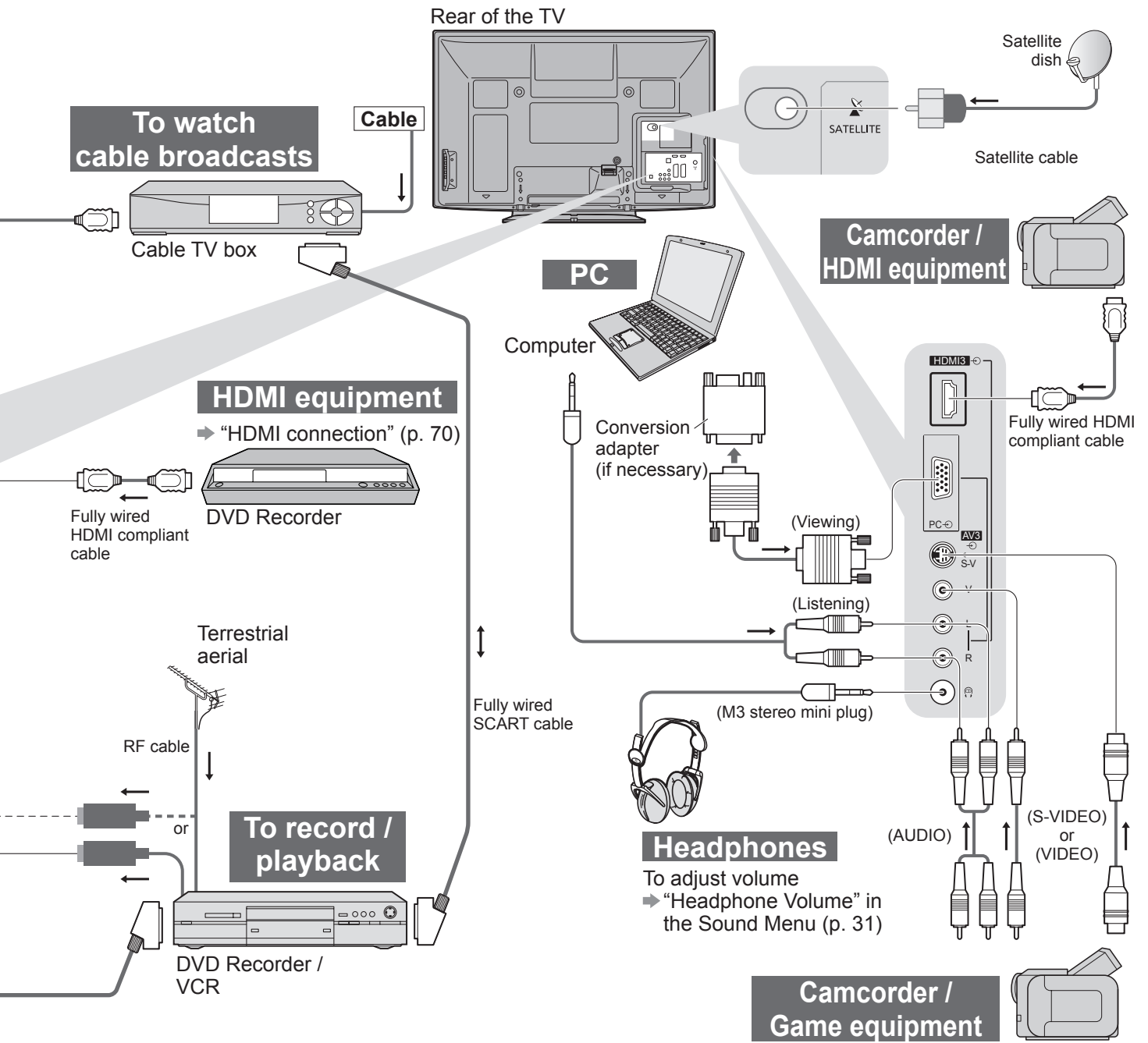

COMPONENT	AUDIO OUT	DIGITAL AUDIO OUT	ETHERNET	HDMI		
				1	2	3
<input type="checkbox"/>				<input type="checkbox"/>	<input type="checkbox"/>	<input type="checkbox"/>
				<input type="checkbox"/>	<input type="checkbox"/>	<input type="checkbox"/>
				<input type="checkbox"/>	<input type="checkbox"/>	<input type="checkbox"/>
	<input type="checkbox"/>					
		<input type="checkbox"/>				
			<input type="checkbox"/>			
				<input type="checkbox"/>	<input type="checkbox"/>	<input type="checkbox"/>
				<input type="checkbox"/>	<input type="checkbox"/>	<input type="checkbox"/>

Technical Information

Auto Aspect

The optimum size and aspect can be chosen automatically, and you can enjoy finer images. (p. 17)

■ Aspect Control Signal

“WIDE” will appear in the top left of the screen if a Widescreen signal (WSS) or a Control signal through SCART / HDMI terminal is found.

The aspect will switch to the appropriate 16:9 or 14:9 widescreen ratio.

This function will work in any aspect mode.

Input terminal	Input signal format	Aspect Control Signal		
		Widescreen signal (WSS)	Control signal through SCART (pin8) / HDMI terminal	
RF	DVB	○		
	PAL I	○		
	PAL 525/60 6.0 MHz	—		
	M.NTSC 6.0 MHz	—		
Satellite	freesat, Other Sat.	○		
AV1 (Composite) AV2 (Composite or S-Video) AV3	PAL	○		○
	PAL 525/60	—		○
	M.NTSC	—		○
	NTSC	—		○
COMPONENT	525 (480) / 60i	—		
	525 (480) / 60p	—		
	625 (576) / 50i	○		
	625 (576) / 50p	○		
	750 (720) / 60p	—		
	750 (720) / 50p	—		
	1,125 (1,080) / 60i	—		
	1,125 (1,080) / 50i	—		
HDMI1 HDMI2 HDMI3	525 (480) / 60i	—	○	
	525 (480) / 60p	—	○	
	625 (576) / 50i	—	○	
	625 (576) / 50p	—	○	
	750 (720) / 60p	—	○	
	750 (720) / 50p	—	○	
	1,125 (1,080) / 60i	—	○	
	1,125 (1,080) / 50i	—	○	
	1,125 (1,080) / 60p	—	○	
	1,125 (1,080) / 50p	—	○	
	1,125 (1,080) / 24p	—	○	

■ Auto mode

Auto mode determines the best aspect ratio to fill the screen. It does this using a four step process (WSS, Control signal through SCART / HDMI terminal, Letterbox detection, or Justify to fill the screen) to determine. This process may take several minutes, depending on the darkness of the image.

Letterbox detection: If black bands at the top and bottom of the screen are detected, Auto mode chooses the best ratio and expands the image to fill the screen.

If no aspect signals are detected, Auto mode enhances the image for optimum viewing pleasure.

Note

- The ratio varies depending on the programme, etc. If the ratio is out of the standard 16:9, black bands at the top and bottom of the screen may appear.
- If the screen size looks unusual when a widescreen-recorded programme is played back on a VCR, adjust the tracking of the VCR. Read the manual of the VCR.

SD Card

■ Cautions in handling SD Card

- Do not remove the card while the TV is accessing data (this can damage card or TV).
- Do not touch the pins on the back of the card.
- Do not subject the card to a high pressure or impact.
- Insert the card in the correct direction (otherwise, card may be damaged).
- Electrical interference, static electricity, or erroneous operation may damage the data or card.
- Back up the recorded data at regular intervals in case of deteriorated or damaged data or erratic operation of the TV. (Panasonic is not liable for any deterioration or damage of recorded data.)

■ Data format for Card browsing

- Photo: Still images recorded with digital still cameras compatible with JPEG files of DCF* and EXIF standards
Data format - Baseline JPEG (Sub-sampling 4:4:4, 4:2:2 or 4:2:0)
Max. number of files - 9,999
Image resolution - 160 × 120 to 10,000,000
- Movie: SD-Video Standard Ver. 1.2 [MPEG-2 (PS format)] and AVCHD Standard compatible files with an audio format that is either MPEG-1/Layer-2 format or Dolby Digital format
(A modified data with a PC may not be displayed correctly.)
- Compliant card type (maximum capacity): SDHC Card (32 GB), SD Card (2 GB), miniSD Card (2 GB)
(requiring miniSD adapter)
- If miniSD Card is used, insert / remove it together with the adapter.
- Check the latest information on the card type at the following website. (English only)
<http://panasonic.co.jp/pavc/global/cs/>

*DCF (Design rule for camera file system): Unified standard established by Japan Electronics and Information Technology Industries Association (JEITA).

Note

- Format the card with the recording equipment.
- The picture may not appear correctly on this TV depending on the recording equipment used.
- Display may take some time when there are many files and folders.
- This function cannot display Motion JPEG and still image not DCF formatted (i.e. TIFF, BMP).
- A data modified with a PC may not be displayed.
- Images imported from a PC must be compatible with EXIF (Exchangeable Image File) 2.0, 2.1, and 2.2.
- Partly degraded files might be displayed at a reduced resolution.
- All “.JPG” extension datas in the card will be read in Photo View Mode.
- The folder and file names may be different depending on the digital camera used.
- Do not use two-byte characters or other special codes.
- The card may become unusable with this TV if the file or folder names are changed.

Characters table for numeric buttons

You can enter characters by using numeric buttons for free input items.

Press the numeric button repeatedly until you reach the desired character.

- The character is set automatically if you leave for one second.
- You can also set the character by pressing the OK button or other numeric buttons within one second.

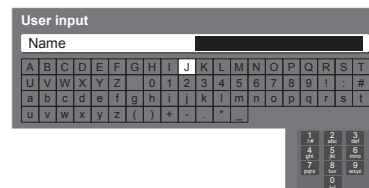

Characters table:

The number of times to press	Numeric buttons										
	1	2	3	4	5	6	7	8	9	10	11
1 ^{•••}	.	1	!	:	#	+	-	*	_	()
2 ^{abc}	a	b	c	2	A	B	C				
3 ^{def}	d	e	f	3	D	E	F				
4 ^{ghi}	g	h	i	4	G	H	I				
5 ^{jkl}	j	k	l	5	J	K	L				
6 ^{mno}	m	n	o	6	M	N	O				
7 ^{pqrs}	p	q	r	s	7	P	Q	R	S		
8 ^{tuv}	t	u	v	8	T	U	V				
9 ^{wxyz}	w	x	y	z	9	W	X	Y	Z		
0 [␣]	Space	0									

Technical Information

HDMI connection

HDMI (high-definition multimedia interface) is the world's first complete digital consumer AV interface complying with a non-compression standard.

HDMI allows you to enjoy high-definition digital images and high-quality sound by connecting the TV and the equipment.

HDMI-compatible equipment (*1) with an HDMI or DVI output terminal, such as a set top box or a DVD player, can be connected to the HDMI terminal using an HDMI compliant (fully wired) cable.

About connections, see "External Equipment" (p. 66).

■ Applicable HDMI features

- Input audio signal : 2ch Linear PCM (sampling frequencies - 48 kHz, 44.1 kHz, 32 kHz)
- Input video signal : 480i, 480p, 576i, 576p, 720p, 1080i and 1080p
 - ➔ "Input signal that can be displayed" (p. 72)
 - Match the output setting of the digital equipment.
- Input PC signal : ➔ "Input signal that can be displayed" (p. 72)
 - Match the output setting of the PC.
- VIERA Link (HDAVI Control 4): ➔ "VIERA Link" (p. 61)
- x.v.Colour™

■ DVI connection

If the external equipment has only a DVI output, connect to the HDMI1 / 3 terminal via a DVI to HDMI adapter cable (*2).

When the DVI to HDMI adapter cable is used, connect the audio cable to the audio input terminal (HDMI1: use COMPONENT-AUDIO terminals / HDMI3: use AV3 audio terminals).

Note

- Audio settings can be made on the "HDMI1 / 3 Input" in the Sound Menu. (p. 31)
- HDMI2 terminal is for digital audio signal only.
- If the connected equipment has an aspect adjustment function, set the aspect ratio to "16:9".
- These HDMI connectors are "type A".
- These HDMI connectors are compatible with HDCP (High-Bandwidth Digital Content Protection) copyright protection.
- An equipment having no digital output terminal may be connected to the input terminal of either "COMPONENT", "S-VIDEO", or "VIDEO" to receive analogue signals.
- This TV incorporates HDMI™ (Version 1.3a with x.v.Colour™) technology.

(*1): The HDMI logo is displayed on HDMI-compliant equipment.

(*2): Enquire at your local digital equipment retailer shop.

PC connection

A PC may be connected to this TV so that the PC screen is displayed and sound is heard from the TV.

- PC signals that can be inputted: Horizontal scanning frequency 31 to 69 kHz; vertical scanning frequency 59 to 86 Hz (more than 1,024 signal lines could result in incorrect display of the image).
- A PC adapter is not necessary for the DOS/V-compliant D-sub 15-pin connector.

Note

- Some PC models cannot be connected to this TV.
- To listen to PC sound from the TV, connect the audio cable to COMPONENT-AUDIO terminals. (p. 66)
- When using PC, set the colour display quality of PC to the highest position.
- For details of the applicable PC signals
 - ➔ "Input signal that can be displayed" (p. 72)
- Max. display resolution

Aspect	4:3	1,440 × 1,080 pixels
	16:9	1,920 × 1,080 pixels

- D-sub 15-pin connector signal

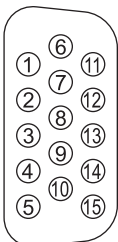

Pin No.	Signal Name	Pin No.	Signal Name	Pin No.	Signal Name
①	R	⑥	GND (Ground)	⑪	NC (not connected)
②	G	⑦	GND (Ground)	⑫	NC (not connected)
③	B	⑧	GND (Ground)	⑬	HD
④	NC (not connected)	⑨	NC (not connected)	⑭	VD
⑤	GND (Ground)	⑩	GND (Ground)	⑮	NC (not connected)

Updating the TV software

From time to time, a new version of software may become available for download to enhance the performance or operations of the TV.

■ To download from a notification banner

A notification banner will appear when you search for a new version software by using the “System Update Search Now” function (p. 50).

In freesat mode, a notification banner will appear when the TV Guide is exited if a new available software is found.

In DVB mode, a notification banner will appear when one of the BBC channels is tuned if a new available software is found.

To start downloading press the OK button, this may take up to 60 minutes to complete.

To ignore the new software press the EXIT button.

You can update later automatically when the TV is in Standby mode

➔ “To download any new software automatically” (see below)

If you do not wish to update, set “Auto Update Search in Standby” to “Off”, but the notification banner will keep appearing during the period of new software availability, usually 2 to 3 days.

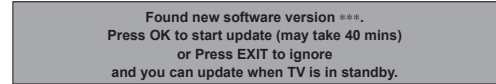

■ To download any new software automatically

Ensure that the “Auto Update Search in Standby” function in the System Update menu is set to “On” (p. 50).

The TV will then download new software automatically at night if it is left in standby without any timer programming in progress.

Note

- During software download and update, DO NOT switch Off the TV.

Network connection (ETHERNET)

If you do not have a Broadband network service, please consult your retailer for assistance.

About connections, see “External Equipment” (p. 66).

■ Preparations

- Confirm the terms and conditions of the contracts with your Internet Service Provider (ISP) or telecommunications company.
- Set up and connect any equipment required for the network environment.
- Ensure that the Broadband routers and hubs are compatible with 10BASE-T / 100BASE-TX.
- If you use the equipment compatible only with 100BASE-TX, category 5 straight LAN cables (STP) are required.
- Read the manual of the network equipment, too.

Note

- Depending on the ISP or telecommunications company, the required equipment and the internet connection procedure are different. Ensure that you use the network equipment that are authorized by your ISP and telecommunications company.
- You cannot make settings for the network equipment on this TV. You may be required to make settings on your computer.
- Depending on the terms and conditions of the contracts with your ISP or telecommunications company, additional fees may be incurred or multiple connections to the internet may be impossible.
- Please contact your ISP or telecommunications company if you require further assistance regarding the network equipment.

SCART, S-VIDEO and HDMI terminal information

■ AV1 SCART terminal (RGB, VIDEO, Q-Link)

Suitable inputs for AV1 include RGB (Red / Green / Blue).

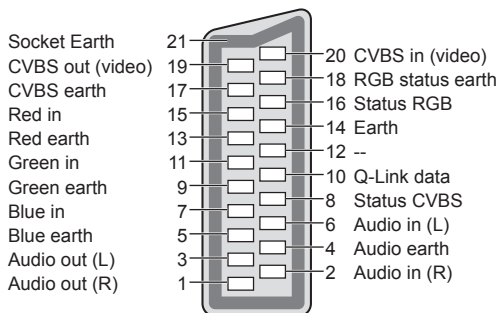

■ AV2 SCART terminal (RGB, VIDEO, S-VIDEO, Q-Link)

AV2 - Pins 15 and 20 are dependent on AV2 S-VHS / VIDEO switching.

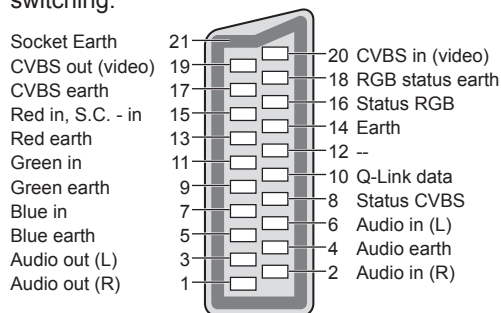

■ AV3 S-VIDEO 4 pin terminal



■ HDMI terminal

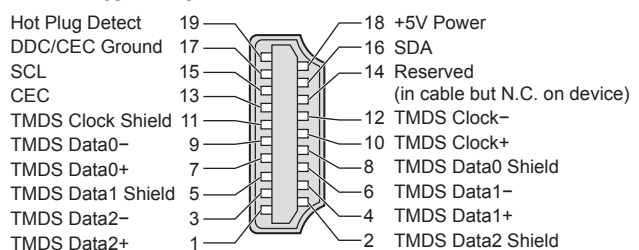

Technical Information

Input signal that can be displayed

COMPONENT (Y, P_B, P_R), HDMI

* Mark: Applicable input signal

Signal name	COMPONENT	HDMI
525 (480) / 60i	*	*
525 (480) / 60p	*	*
625 (576) / 50i	*	*
625 (576) / 50p	*	*
750 (720) / 60p	*	*
750 (720) / 50p	*	*
1,125 (1,080) / 60i	*	*
1,125 (1,080) / 50i	*	*
1,125 (1,080) / 60p		*
1,125 (1,080) / 50p		*
1,125 (1,080) / 24p		*

PC (from D-sub 15P)

Applicable input signal for PC is basically compatible to VESA standard timing.

Signal name	Horizontal frequency (kHz)	Vertical frequency (Hz)
640 × 400 @70 Hz	31.47	70.07
640 × 480 @60 Hz	31.47	59.94
640 × 480 @75 Hz	37.50	75.00
800 × 600 @60 Hz	37.88	60.32
800 × 600 @75 Hz	46.88	75.00
800 × 600 @85 Hz	53.67	85.06
852 × 480 @60 Hz	31.44	59.89
1,024 × 768 @60 Hz	48.36	60.00
1,024 × 768 @70 Hz	56.48	70.07
1,024 × 768 @75 Hz	60.02	75.03
1,024 × 768 @85 Hz	68.68	85.00
1,280 × 768 @60 Hz	47.70	60.00
1,280 × 1,024 @60 Hz	63.98	60.02
1,366 × 768 @60 Hz	48.39	60.04
Macintosh13" (640 × 480)	35.00	66.67
Macintosh16" (832 × 624)	49.73	74.55
Macintosh21" (1,152 × 870)	68.68	75.06

PC (from HDMI terminal)

Applicable input signal for PC is basically compatible to HDMI standard timing.

Signal name	Horizontal frequency (kHz)	Vertical frequency (Hz)
640 × 480 @60 Hz	31.47	60.00
750 (720) / 60p	45.00	60.00
1,125 (1,080) / 60p	67.50	60.00

Note

- Signals other than above may not be displayed properly.
- The above signals are reformatted for optimal viewing on your display.
- PC signal is magnified or compressed for display, so that it may not be possible to show fine detail with sufficient clarity.

FAQs

Before requesting service or assistance, please follow these simple guides to resolve the problem. If the problem still persists, please contact your local Panasonic dealer or Panasonic Customer Care Centre for assistance. For details (p. 80)

White spots or shadow images (noise)

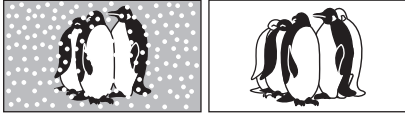

- Check the position, direction, and connection of the aerial.

Neither image nor sound is produced

- Is the TV in AV mode?
- Check the correct AV input mode is selected.
- Check the mains lead is plugged into the socket outlet.
- Has the TV been turned On?
- Check the Picture Menu (p. 30) and volume.
- Check all required SCART cables and connections are firmly in place.

Auto aspect

- Auto aspect is designed to provide you with the best ratio to fill the screen. (p. 68)
- Press the ASPECT button if you would like to change the aspect ratio manually (p. 17).

S-Video / black and white picture

- Check that the output of the external equipment matches the input of the TV. If the output of the external equipment is set to S-Video, the TV must also be set to S-Video (p. 24).

No programmes shown on TV Guide

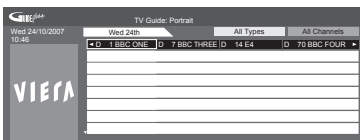

- Reset channels. (p. 34 and p. 35)
- Check the digital transmitter.
- Adjust the direction of the dish or aerial to another transmitter installed nearby.
- Check the analogue broadcast. If the image quality is poor, check the aerial and consult your nearest dealer.

freesat Auto Setup cannot be done completely

- Check connections and dish alignment. The dish needs to be pointing at Astra 2 at 28.2° East, and Eurobird 1 at 28.5° East.
- If the problem persists, consult your freesat registered retailer or call Freesat (UK) Ltd on **0844 881 6700** or visit **www.freesat.co.uk**

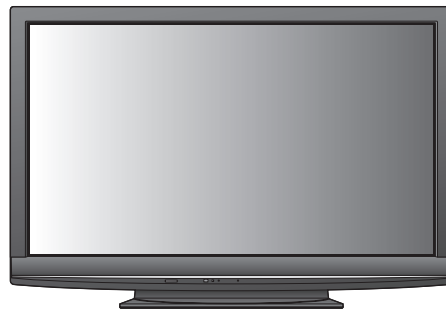

Remains channel number, input mode, etc. on the TV screen -i.e. EC/AV1

- Press the **i** button to clear these. Press again to redisplay.

Q-Link function does not work

- Confirm SCART cable and connection. Also set "AV1 / AV2 out" in the Setup Menu (p. 32).

"VIERA Link" function does not work and an error message appears

- Confirm the connection. (p. 58 and p. 59)
- Turn the connected equipment on and then switch the TV on. (p. 61)

Recording does not start immediately

- Check the settings of the recorder. For details, read the manual of the recorder.
- Timer Programming might be performed.

Contrast is reduced

- Contrast is lowered in the following conditions without any user operation for a few minutes:
 - no signal in freesat, DVB, Other Sat. or AV mode
 - selected locked channel
 - selected invalid channel
 - selected radio channel
 - displayed menu
 - Digital teletext (no video contents)
 - Thumbnail, list or still picture in SD Card mode

FAQs

	Problem	Actions
Screen	Chaotic image, noisy	<ul style="list-style-type: none"> ● Set "P-NR" in the Picture Menu (to remove noise). (p. 30) ● Check nearby electrical products (fluorescent lamp, DECT phones, mobile phones, microwave, etc.).
	No image can be displayed	<ul style="list-style-type: none"> ● Is "Colour" or "Contrast" in the Picture Menu set to the minimum? (p. 30) ● Please also refer to "Neither image nor sound is produced" (p. 73).
	Blurry or distorted image (no sound or low volume)	<ul style="list-style-type: none"> ● Reset channels. (p. 34 and p. 35) ● Please also refer to "Neither image nor sound is produced" (p. 73).
	Unusual image is displayed	<ul style="list-style-type: none"> ● Turn the TV Off with Mains power On / Off switch, then turn it On again. ● If the problem persists, perform "Shipping Condition" (p. 49).
Sound	No sound is produced	<ul style="list-style-type: none"> ● Is "Sound mute" active? (p. 9) ● Is the volume set to the minimum? ● Please also refer to "Neither image nor sound is produced" (p. 73).
	Sound level is low or sound is distorted	<ul style="list-style-type: none"> ● Sound signal reception may be deteriorated. ● Set "NICAM" (p. 31) in the Sound Menu to "Off". (Analogue only) ● Please also refer to "Neither image nor sound is produced" (p. 73).
	Whirring sound is heard	<ul style="list-style-type: none"> ● The sound is from built-in cooling fan (not a sign of faulty operation).
Digital Channel	<ul style="list-style-type: none"> ● Due to the digital reception technologies involved, quality of the digital signals may be relatively low in some cases, despite good reception of analogue channels. 	
	Interference or frozen / disappearing image in freesat, DVB or Other Sat. mode	<ul style="list-style-type: none"> ● Check "Signal Condition" (p. 37, 38 and 42). If "Signal Quality" or "Signal Strength" are displayed in red, the signal is weak. ● Check aerial or dish. ● Check your postcode area is able to receive the Freeview channels at www.freeview.co.uk ● Digital signals may be relatively low to prevent interference with analogue signals for the period of Digital Switchover. Check the plan of Digital Switchover at www.digitaluk.co.uk ● Weather conditions will affect signal reception (heavy rain, snow, etc.), in particular in poor reception areas. Even during good weather the high pressure can cause poor reception of some channels. ● Turn the TV off with the Mains power On / Off switch, then turn it On again. ● Reset channels. (p. 34 and p. 35)
	Some channels cannot be tuned	<ul style="list-style-type: none"> ● Check the aerial or dish.
	Cannot find a channel you have previously watched	<ul style="list-style-type: none"> ● The channel may broadcast for part of the day. ● Check the channel in the TV Guide. (p. 18 and p. 19) ● Channel position numbers may be changed by broadcasters. ● Reset channels. (p. 34 and p. 35)
	In freesat mode, not possible to adjust the volume and set Speakers / Headphones for Audio Description sound track (unlike DVB)	<ul style="list-style-type: none"> ● This is due to broadcast limitations. (p. 31)
	Some freesat channels do not produce the sound in English by default	<ul style="list-style-type: none"> ● This is due to broadcasts even if they have English sound. In this case, press the OPTION button and set "Multi Audio" (p. 17). Please note that this setting cannot be memorized if the TV is turned Off with Mains power On / Off switch.

	Problem	Actions
HDMI	Sound is unusual	<ul style="list-style-type: none"> ● Set the sound setting of the connected equipment to "2ch L.PCM". ● Check the "HDMI1 / 3 Input" setting in the Sound Menu. (p. 31) ● If digital sound connection has a problem, select analogue sound connection. (p. 70)
	Pictures from external equipment are unusual when the equipment is connected via HDMI	<ul style="list-style-type: none"> ● Check the HDMI cable is connected properly. (p. 66) ● Turn the connected equipment on and then switch the TV on. (p. 61) ● Check an input signal from the equipment. (p. 72) ● Use an equipment compliant with EIA/CEA-861/861B.
Other	The TV does not switch On	<ul style="list-style-type: none"> ● Press and hold the standby On / Off switch on the remote control for about 1 second if Power LED is red. ● Check the mains lead is plugged into the socket outlet. ● The fuse in the mains plug may have blown. Replace it with one of an identical rating (p. 4).
	The TV goes into "Standby mode"	<ul style="list-style-type: none"> ● Off Timer function is activated. ● The TV enters "Standby mode" about 30 mins. after analogue broadcasting ends.
	The remote control does not work or is intermittent	<ul style="list-style-type: none"> ● Are the batteries installed correctly? (p. 6) ● Has the TV been switched On? ● The batteries may be running low. Replace them. ● Point the remote control directly at the front of the TV (within a 30 degree angle of the front of the TV). ● Situate the TV away from sunshine or other sources of bright light not to shine on the TV's remote control signal receiver.
	Permanently lit spots on screen	<ul style="list-style-type: none"> ● Due to production process involved in this technology this may result in some pixels which are permanently lit or unlit. This is not a malfunction.
	An error message appears	<ul style="list-style-type: none"> ● Follow the message's instructions. ● If the problem persists, contact the authorized Service Centre.

On screen messages

Message	Meaning / Action
All tuning data will be erased	▶ ● "Shipping Condition" will erase all tuning data (p. 49).
Are you sure ?	▶ ● Confirm correct operation.
Are you sure you want to delete this timer ? Press OK to delete timer Press RETURN to return	▶ ● Confirm correct operation.
Bad signal	▶ ● The signal is weak. Check the aerial is plugged in properly. It may be necessary to have an aerial installer check the signal and aerial alignment. ● Reset channels. (p. 34 and p. 35)
Child Lock is active ! Press OK to enter PIN.	▶ ● The selected channel is locked in Child Lock (p. 45). You must enter the PIN number before the channel will be displayed.
Ethernet cable not connected	▶ ● Check the connection of the LAN cable. If you use a hub, also check the light on the hub is lit. ● The LAN cable might be defective.
Faulty dish	▶ ● The satellite cable might be short-circuited or there might be connection problems of the cable. Check the cable and connection and then turn the TV Off with the Mains power On / Off switch, and turn it On again. ● If the message still persists, it may be necessary to have a dish installer check the dish and cable.
Feature not available	▶ ● It is not possible to record from COMPONENT, HDMI or PC. Connect the recorder to the TV using a fully wired SCART cable for recording from the TV tuner. ● Confirm Q-Link or VIERA Link settings (p. 58 - 61).
Found new software version ***. Press OK to start update (may take 40 mins) or Press EXIT to ignore and you can update when TV is in standby.	▶ ● There is a new software available.
Gateway does not answer. Please confirm connection and setting of router.	▶ ● A connection failure has occurred and the gateway is not responding. Check the settings and connections of the router. ● Turn the TV and the router Off with the Mains power On / Off switch, and turn them On again.
Invalid operation - Please check settings and connections.	▶ ● Check the Q-Link or VIERA Link connection and setting (p. 58 - 61).
Invalid system time. Please exit !	▶ ● Cannot get the time information. Check the connection of the RF cable.
IP address conflict	▶ ● Duplicate IP address has been detected. Check the IP address of other equipment such as computers, routers and ensure that there are no duplicate IP address.
IP address not set	▶ ● An IP address is required to use interactive content through the internet. Enter an IP address.
Manual IP setting not correct	▶ ● The system is unable to set the IP address. Consult your Internet Service Provider or telecommunications company.
Max. number of Timers already set !	▶ ● The maximum number of timer programming events is 15.
New channels found! Press OK to update channel list Press EXIT to ignore.	▶ ● There may be new channels available. ● This message will appear each time a change is made by the broadcasters. This message can be deactivated by setting "New Channel Message" to Off in "DVB Tuning Menu". Selecting OK will perform "Update Channel List".
No channel found. Please check aerial or local signal availability. Press OK to start Auto Setup.	▶ ● Please follow the message. If it is still failed, consult your local Panasonic dealer.
No module inserted	▶ ● Check the CI module inserted completely (p. 51).
No recording - Check media	▶ ● The tape or disc may be "write protected", missing or damaged.
No recording - Already recording	▶ ● The equipment may already be recording.
No recording - Unknown reason	▶ ● The recording may not be performed. Check the equipment. ● Disc or tape may be full.
No service	▶ ● The broadcaster has stopped the service. Check the channel in the TV Guide. (p. 18 and p. 19)
No signal	▶ ● The TV cannot detect the signal. Check the connection of the RF cable.

Message	Meaning / Action
PIN incorrect!	▶ ● The PIN number you entered is wrong.
Please check settings and connections on HDMI devices.	▶ ● Communication error in VIERA Link function (p. 61).
Please choose a frequency between 9750 and 12750 MHz	▶ ● The frequency you entered is out of range. Consult the received satellite broadcasting company. (p. 42)
Please wait.	▶ ● A function is in progress.
Recording this channel now	▶ ● The recorder is recording the programme from its own tuner. You can turn the TV off and leave the equipment recording in the normal way.
Reset to Factory Shipping Condition Completed. Please switch off TV.	▶ ● "Auto Setup" will automatically start when Mains power On / Off switch is next turned On. (p. 12)
Sending Preset Data Please wait!	▶ ● Q-Link or VIERA Link channel download is in progress.
Software successfully updated. Press EXIT to continue.	▶ ● The software updating is finished.
Software update failed. Please try again later. Press EXIT to continue.	▶ ● Perform "System Update Search Now" in System Update (p. 50). If this is still unsuccessful, there may not be any new software available.
This timer will not follow the TV Guide information Press OK to continue, RETURN to restore original timer	▶ ● If you edit the start time or end time of Guide link recording more than 10 minutes, it will no longer be performed as Guide link recording. The recording will be performed according to the time setting.
Timer already expired !	▶ ● Starting time in Timer Programming is already past. Set correctly (p. 53).
Timer Event Due to Start DVB 1: BBC1 has been programmed for recording at **: **: *	▶ ● This message will appear 2 minutes before timer programming event due to start.
Timer incorrect !	▶ ● Set Start and End times in Timer Programming correctly (p. 53).
Timer overlap Press OK to keep, RETURN to edit	▶ ● Timer programming events are overlapped. If you press the OK button, the first timer programming event will start and finish, the next timer programming event can then start.
Tuner Locked Please stop recording to operate	▶ ● If you want to unlock, cancel Direct TV Recording (p. 60 and p. 62) or Timer Programming (p. 53).
Unable to acquire IP address	▶ ● Unable to obtain the IP address. Check the settings and connections of the router.
Unable to download, please check equipment	▶ ● The tape or disc is active. Stop the equipment and try again.
■ SD Card	
Cannot read file	▶ ● The file is broken or unreadable. ▶ ● The TV does not support the format. (For the applicable formats and data → p. 69)
No SD card inserted	▶ ● Confirm SD Card is inserted correctly.
No valid file to play	▶ ● The card has no data.
Over 9999 pictures found (max. is 9999)	▶ ● Maximum valid number of photos is 9,999.
Please confirm the SD card is OK	▶ ● The inserted SD Card has a problem.
This operation is not possible	▶ ● Your operation is not available.

Glossary

- **DVB**
Digital Video Broadcasting
- **DVD**
Digital Versatile Disc
- **DVI**
Digital Visual Interface
- **EPG**
Electronic Programme Guide
- **HDMI**
High-Definition Multimedia Interface
- **MAC Address**
Media Access Control Address

- **NTSC**
National Television System Committee
One of the television signals used in USA, etc.
- **RF**
Radio Frequency - Signal received from terrestrial aerial
- **RGB / S-Video / Video**
Choose between these three video formats depending on personal preference and equipment requirement (RGB - Red, Green and Blue)

- **SCART**
21 pin connection used for video, audio and switching signals (Also known as Euro SCART and Peritel)
- **Shop viewing environment**
Shop viewing environment is the demonstration mode to explain main features of this TV in an easy understandable way. This mode will work if you select "Shop" in "Auto Setup" (p. 12).
- **VCR**
Video Cassette Recorder

Licence

Even if no special notation has been made of company or product trademarks, these trademarks have been fully respected.

- "freesat" is a registered trademark and the "freesat" logo is a trademark of Freesat (UK) Ltd.
- DVB is a trademark of the DVB Digital Video Broadcasting Project (1991 to 1996).
- VGA is a trademark of International Business Machines Corporation.
- Macintosh is a registered trademark of Apple Inc., USA.
- S-VGA is a registered trademark of the Video Electronics Standard Association.
- SDHC Logo is a trademark.
- HDMI, the HDMI Logo and High-Definition Multimedia Interface are trademarks or registered trademarks of HDMI Licensing LLC.
- HDAVI Control™ is a trademark of Panasonic Corporation.
- "AVCHD" and the "AVCHD" logo are trademarks of Panasonic Corporation and Sony Corporation.
- x.v.Colour™ is a trademark.
- Manufactured under license from Dolby Laboratories.
Dolby and the double-D symbol are trademarks of Dolby Laboratories.
- GUIDE Plus+ is (1) a registered trademark or trademark of, (2) manufactured under license from and (3) subject of various international patents and patent applications owned by, or licensed to, Gemstar-TV Guide International, Inc. and/or its related affiliates.

Index

- | | | |
|---|---|---|
| A Accessories 6 | H HDMI 70, 72 | P-NR 30 |
| Analogue Tuning Menu 35, 40 | Hold 15, 22 | Power LED 8 |
| Aspect 17, 68 | Home Cinema 59, 65 | Q Q-Link 32, 58, 60 |
| Astra 1 43 | Hotbird 43 | Q-Link Download 12, 32 |
| Astra 2 10, 43, 73 | I Information banner 16 | Quick Start Guide 6-13 |
| Audio Description 17, 31 | Input Labels 48 | R Remote control 6, 9 |
| Auto Setup 12, 34, 35, 43 | Input signal 72 | Reset to Defaults 30, 31, 57 |
| AV1 / AV2 out 32, 60 | Intelligent Frame Creation 33 | RGB 79 |
| B Banner Display Timeout 33 | L Licence 78 | S Sales and Support Information 80 |
| C Cable TV box 11, 24, 66 | M Mains Lead 10 | SCART 11, 58, 71 |
| Category list 19 | Mains power On / Off switch 8, 12 | SD Card 54, 69 |
| Channel Genre 18 | Maintenance 5 | Shipping Condition 49 |
| Channel List 37, 39, 41, 44 | Manual Tuning 39, 41, 42 | Signal Condition 37, 38, 42 |
| Child Lock 45 | Menu Functions 26-33 | Slideshow 55 |
| CI module 51 | Mode 31 | Specifications 79 |
| Clamper 8 | Movie View 56 | Split Programme 20 |
| COMPONENT 66, 72 | Multi Audio 17 | Subtitles 16, 23 |
| Connection 10, 11, 58, 59, 66 | N Network connection (ETHERNET) 66, 71 | S-Video 66, 71 |
| D Direct TV Recording 60, 62 | Network Setup 46 | System Update 50, 71 |
| Dish alignment 10, 73 | New Channel Message 38 | T Teletext 21-23 |
| D-sub 15-pin 70 | NICAM 31 | Timer LED 8, 20, 53 |
| DVB Tuning Menu 35, 38 | Normalisation 9, 26 | Timer Programming 52 |
| DVI 70 | NTSC 27, 79 | TV Guide 18-20 |
| DVDs 11, 24, 25 | O Off Timer 17, 32 | TV speaker 65 |
| E Eco Mode 30 | Other Sat. Tuning Menu 42 | Type list 18, 19 |
| EPG 18, 19 | Optional accessories 6 | U Update Channel List 38 |
| Eurobird 1 10, 73 | Owner ID 12, 51 | Update the software 50, 71 |
| External equipment 11, 24, 66 | P PAL 79 | V V-Audio Surround 31 |
| External input 24, 57 | PC 57, 70 | VCR 11, 24, 25, 66 |
| F FAQs 73-75 | Pedestal 7 | VIERA Link 58, 59, 61-65 |
| Favourites Edit 37, 39, 44 | Photo View 54 | Viewing Mode 30 |
| Free input menu 26 | Picture Overscan 33 | Volume Correction 31 |
| freesat Tuning Menu 34, 36 | PIN number 12, 45, 51 | W WSS 68 |
| G Guide link recording 20 | Playing Time Display 33 | Z Zoom 17 |
| GUIDE Plus+ Settings 33 | | |

Specifications

		TX-P42G10B	TX-P46G10B	TX-P50G10B	
Power Source		AC 220-240 V, 50 / 60 Hz			
Power Consumption		350 W	410 W	435 W	
Power Consumption in Standby mode		0.4 W (Without monitor out recording) 32 W (With monitor out recording)			
Display panel	Aspect Ratio	16:9			
	Visible screen size	106 cm (diagonal) 921 mm (W) × 518 mm (H)	117 cm (diagonal) 1,019 mm (W) × 573 mm (H)	127 cm (diagonal) 1,105 mm (W) × 622 mm (H)	
	Number of pixels	2,073,600 (1,920 (W) × 1,080 (H)) [5,760 × 1,080 dots]			
Sound	Speaker	160 mm × 40 mm × 2 pcs, 6 Ω			
	Audio Output	20 W (10 W + 10 W), 10% THD			
	Headphones	M3 (3.5 mm) stereo mini Jack × 1			
PC signals		VGA, SVGA, WVGA, XGA SXGA, WXGA (compressed) Horizontal scanning frequency 31 - 69 kHz Vertical scanning frequency 59 - 86 Hz			
Receiving Systems / Band name		DVB-S / S2 (freesat / Other Sat.) : freesat services via Satellite dish input. Receiver frequency range - 950 MHz to 2,150 MHz LNB Power and Polarisation - Vertical: +13 V Horizontal: +18 V Current: Max. 500 mA (overload protection) 22 kHz Tone - Frequency: 22 kHz ± 2 kHz Amplitude: 0.6 V ± 0.2 V Symbol Rate - Max. 30 MS/s FEC Mode - 1/2, 3/5, 2/3, 3/4, 4/5, 5/6, 8/9, 9/10 Demodulation - QPSK, 8PSK Not available for DiSEqC control. DVB-T : Digital terrestrial services via UHF aerial input. PAL I : UHF E21-68 PAL 525/60 : Playback of NTSC tape from some PAL Video recorders (VCR) or NTSC disc playback from DVD player and recorder. M.NTSC : Playback from M.NTSC Video recorders (VCR). NTSC : Playback from NTSC Video recorders (VCR). (AV input only)			
Satellite dish input		Female F-type 75 Ω			
Aerial input		UHF			
Operating Conditions		Temperature : 0 °C - 35 °C Humidity : 20 % - 80 % RH (non-condensing)			
Connection Terminals	AV1 (SCART terminal)	21 Pin terminal (Audio/Video in, Audio/Video out, RGB in, Q-Link)			
	AV2 (SCART terminal)	21 Pin terminal (Audio/Video in, Audio/Video out, RGB in, S-Video in, Q-Link)			
	AV3	VIDEO	RCA PIN Type × 1	1.0 V[p-p] (75 Ω)	
		S-VIDEO	Mini DIN 4-pin	Y: 1.0 V[p-p] (75 Ω)	C: 0.286 V[p-p] (75 Ω)
		AUDIO L - R	RCA PIN Type × 2	0.5 V[rms]	
	COMPONENT	VIDEO	Y	1.0 V[p-p] (including synchronization)	
			P _B , P _R	±0.35 V[p-p]	
		AUDIO L - R	RCA PIN Type × 2	0.5 V[rms]	
	Others	HDMI 1 / 2 / 3	TYPE A Connectors	HDMI™ (Version 1.3a with x.v.Colour™)	
			● This TV supports "HDAVI Control 4" function.		
PC		HIGH-DENSITY D-SUB 15PIN	R, G, B/0.7 V[p-p] (75 Ω)	HD, VD/TTL Level 2.0 - 5.0 V[p-p] (high impedance)	
Card slot		SD Card slot × 1			
Output	ETHERNET	RJ45, IEEE802.3 10BASE-T / 100BASE-TX			
	AUDIO L - R	RCA PIN Type × 2	0.5 V[rms] (high impedance)		
	DIGITAL AUDIO OUT	PCM / Dolby Digital, Fiber optic			
Dimensions (W × H × D)		1,029 mm × 704 mm × 334 mm (With Pedestal) 1,029 mm × 661 mm × 106 mm (TV only)	1,132 mm × 767 mm × 401 mm (With Pedestal) 1,132 mm × 722 mm × 106 mm (TV only)	1,218 mm × 814 mm × 401 mm (With Pedestal) 1,218 mm × 769 mm × 106 mm (TV only)	
Mass		28.0 kg Net (With Pedestal) 25.0 kg Net (TV only)	32.0 kg Net (With Pedestal) 29.0 kg Net (TV only)	35.0 kg Net (With Pedestal) 32.0 kg Net (TV only)	

Note

- Design and Specifications are subject to change without notice. Mass and Dimensions shown are approximate.
- This equipment complies with the EMC standards listed below.
EN55013, EN61000-3-2, EN61000-3-3, EN55020, EN55022, EN55024.
- Pedestal: ST-42CS3WG / ST-50CS3WG (For safety approval)

Information for Users on Collection and Disposal of Old Equipment and used Batteries



These symbols on the products, packaging, and/or accompanying documents mean that used electrical and electronic products and batteries should not be mixed with general household waste. For proper treatment, recovery and recycling of old products and used batteries, please take them to applicable collection points, in accordance with your national legislation and the Directives 2002/96/EC and 2006/66/EC.

By disposing of these products and batteries correctly, you will help to save valuable resources and prevent any potential negative effects on human health and the environment which could otherwise arise from inappropriate waste handling.

For more information about collection and recycling of old products and batteries, please contact your local municipality, your waste disposal service or the point of sale where you purchased the items.

Penalties may be applicable for incorrect disposal of this waste, in accordance with national legislation.



For business users in the European Union

If you wish to discard electrical and electronic equipment, please contact your dealer or supplier for further information.

[Information on Disposal in other Countries outside the European Union]

These symbols are only valid in the European Union. If you wish to discard these items, please contact your local authorities or dealer and ask for the correct method of disposal.



Note for the battery symbol (bottom two symbol examples):

This symbol might be used in combination with a chemical symbol. In this case it complies with the requirement set by the Directive for the chemical involved.

Cd

Sales and Support Information

Customer Care Centre

- For customers within the UK: **0844 844 3852**
- For customers within the Republic of Ireland: **01 289 8333**
- Visit our website for product information www.panasonic.co.uk
- E-mail: customer.care@panasonic.co.uk

Direct Sales at Panasonic UK

- For customers: **0844 844 3856**
- Order accessory and consumable items for your product with ease and confidence by phoning our Customer Care Centre Monday – Thursday 9:00am – 5:30pm, Friday 9:30am – 5:30pm (Excluding public holidays).
- Or go on line through our Internet Accessory ordering application at www.panasonic.co.uk.
- Most major credit and debit cards accepted.
- All enquiries transactions and distribution facilities are provided directly by Panasonic UK Ltd.
- It couldn't be simpler!
- Also available through our Internet is direct shopping for a wide range of finished products, take a browse on our website for further details.

Interested in purchasing an extended guarantee?

Please call 0870 240 6284 or visit www.panasonic.co.uk/guarantee.

This product is licensed under the AVC patent portfolio license for the personal and non-commercial use of a consumer to (i) encode video in compliance with the AVC Standard ("AVC Video") and/or (ii) decode AVC Video that was encoded by a consumer engaged in a personal and non-commercial activity and/or was obtained from a video provider licensed to provide AVC Video. No license is granted or shall be implied for any other use. Additional information may be obtained from MPEG LA, LLC. See <http://www.mpegla.com>.

GEMSTAR-TV GUIDE INTERNATIONAL, INC. AND/OR ITS RELATED AFFILIATES ARE NOT IN ANY WAY LIABLE FOR THE ACCURACY OF THE PROGRAM SCHEDULE INFORMATION PROVIDED BY THE GUIDE PLUS+ SYSTEM. IN NO EVENT SHALL GEMSTAR-TV GUIDE INTERNATIONAL, INC. AND/OR ITS RELATED AFFILIATES BE LIABLE FOR ANY AMOUNTS REPRESENTING LOSS OF PROFITS, LOSS OF BUSINESS, OR INDIRECT, SPECIAL, OR CONSEQUENTIAL DAMAGES IN CONNECTION WITH THE PROVISION OR USE OF ANY INFORMATION, EQUIPMENT, OR SERVICES RELATING TO THE GUIDE PLUS+ SYSTEM.

<http://www.europe.guideplus.com/>



Trade Mark of the DVB Digital Video Broadcasting Project (1991 to 1996)
TX-P42G10B Declaration of Conformity No. 6380, 8 January 2009
TX-P46G10B Declaration of Conformity No. 6381, 8 January 2009
TX-P50G10B Declaration of Conformity No. 6382, 8 January 2009

Customer's Record

The model number and serial number of this product may be found on its rear panel. You should note this serial number in the space provided below and retain this book, plus your purchase receipt, as a permanent record of your purchase to aid in identification in the event of theft or loss, and for Warranty Service purposes.

Model Number

Serial Number

Panasonic (U. K.) Ltd.

Willoughby Road, Bracknell, Berks RG12 8FP

Web Site : <http://www.panasonic.net>

© Panasonic Corporation 2009

Printed in Czech Republic