

# Panasonic®

## Operating Instructions High Definition Video Camera

---

Model No. **HDC-SD200**  
**HDC-HS200**

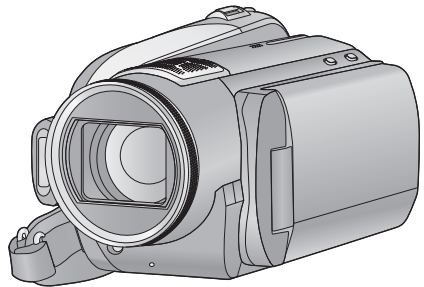
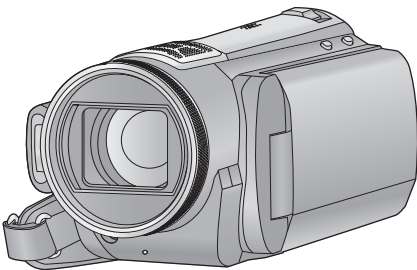

Before use, please read these instructions completely.

**AVCHD**™

**DOLBY**  
DIGITAL  
5.1 CREATOR

**HDMI**™  
HIGH-DEFINITION MULTIMEDIA INTERFACE

**PictBridge**

**SD**  
**HC**  
CLASS 4

**VIERA**  
Link

**LEICA**  
DICOMAR

Web Site: <http://www.panasonic-europe.com>

# Information for Your Safety

## Dear Customer,



We would like to take this opportunity to thank you for purchasing this Panasonic High Definition Video Camera. Please read these Operating Instructions carefully and keep them handy for future reference. Please note that the actual controls and components, menu items, etc. of your High Definition Video Camera may look somewhat different from those shown in the illustrations in these Operating Instructions.

## ■ Caution for AC mains lead

For your safety, please read the following text carefully.

This appliance is supplied with a moulded three pin mains plug for your safety and convenience. A 5-ampere fuse is fitted in this plug.

Should the fuse need to be replaced please ensure that the replacement fuse has a rating of 5-ampere and that it is approved by ASTA or BSI to BS1362.

Check for the ASTA mark  or the BSI mark  on the body of the fuse.

If the plug contains a removable fuse cover you must ensure that it is refitted when the fuse is replaced.

If you lose the fuse cover the plug must not be used until a replacement cover is obtained.

A replacement fuse cover can be purchased from your local dealer.

### CAUTION!

IF THE FITTED MOULDED PLUG IS UNSUITABLE FOR THE SOCKET OUTLET IN YOUR HOME THEN THE FUSE SHOULD BE REMOVED AND THE PLUG CUT OFF AND DISPOSED OF SAFELY. THERE IS A DANGER OF SEVERE ELECTRICAL SHOCK IF THE CUT OFF PLUG IS INSERTED INTO ANY 13-AMPERE SOCKET.

If a new plug is to be fitted please observe the wiring code as stated below.

If in any doubt please consult a qualified electrician.

## IMPORTANT

The wires in this mains lead are coloured in accordance with the following code:

Blue: Neutral, Brown: Live.

As these colours may not correspond with the coloured markings identifying the terminals in your plug, proceed as follows:

The wire which is coloured Blue must be connected to the terminal which is marked with the letter N or coloured Black or Blue.

The wire which is coloured Brown must be connected to the terminal which is marked with the letter L or coloured Brown or Red.

**WARNING: DO NOT CONNECT EITHER WIRE TO THE EARTH TERMINAL WHICH IS MARKED WITH THE LETTER E, BY THE EARTH SYMBOL  $\perp$  OR COLOURED GREEN OR GREEN/YELLOW.**

**THIS PLUG IS NOT WATERPROOF—KEEP DRY.**

## Before use

Remove the connector cover.

## How to replace the fuse

The location of the fuse differ according to the type of AC mains plug (figures A and B).

Confirm the AC mains plug fitted and follow the instructions below.

Illustrations may differ from actual AC mains plug.

1. Open the fuse cover with a screwdriver.

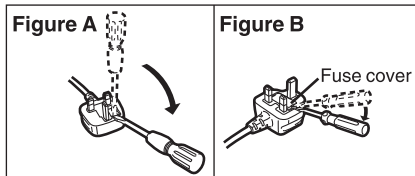

2. Replace the fuse and close or attach the fuse cover.

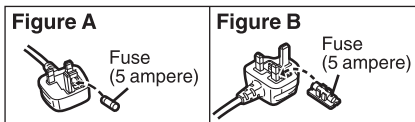

## **WARNING:**

**TO REDUCE THE RISK OF FIRE, ELECTRIC SHOCK OR PRODUCT DAMAGE,**

- **DO NOT EXPOSE THIS APPARATUS TO RAIN, MOISTURE, DRIPPING OR SPLASHING AND THAT NO OBJECTS FILLED WITH LIQUIDS, SUCH AS VASES, SHALL BE PLACED ON THE APPARATUS.**
- **USE ONLY THE RECOMMENDED ACCESSORIES.**
- **DO NOT REMOVE THE COVER (OR BACK); THERE ARE NO USER SERVICEABLE PARTS INSIDE. REFER SERVICING TO QUALIFIED SERVICE PERSONNEL.**

## **CAUTION!**

- **DO NOT INSTALL OR PLACE THIS UNIT IN A BOOKCASE, BUILT-IN CABINET OR IN ANOTHER CONFINED SPACE. ENSURE THE UNIT IS WELL VENTILATED. TO PREVENT RISK OF ELECTRIC SHOCK OR FIRE HAZARD DUE TO OVERHEATING, ENSURE THAT CURTAINS AND ANY OTHER MATERIALS DO NOT OBSTRUCT THE VENTILATION VENTS.**
- **DO NOT OBSTRUCT THE UNIT'S VENTILATION OPENINGS WITH NEWSPAPERS, TABLECLOTHS, CURTAINS, AND SIMILAR ITEMS.**
- **DO NOT PLACE SOURCES OF NAKED FLAMES, SUCH AS LIGHTED CANDLES, ON THE UNIT.**
- **DISPOSE OF BATTERIES IN AN ENVIRONMENTALLY FRIENDLY MANNER.**

The socket outlet shall be installed near the equipment and easily accessible. The mains plug of the power supply cord shall remain readily operable. To completely disconnect this apparatus from the AC Mains, disconnect the power supply cord plug from AC receptacle.

## **Warning**

Risk of fire, explosion and burns. Do not disassemble.

Do not heat the batteries above the following temperatures or incinerate.

**Button-type battery 60 °C**

**Battery pack 60 °C**

## ■ **EMC Electric and magnetic compatibility**

This symbol (CE) is located on the rating plate.

**Use only the recommended accessories.**

- Do not use any other AV cables, Component cable and USB cables except the supplied one.
- When you use the cable which are sold separately, please make sure to use the one whose length is less than 3 metres.
- Keep the Memory Card out of reach of children to prevent swallowing.

**Product Identification Marking is located on the bottom of units.**

## ■ Information for Users on Collection and Disposal of Old Equipment and used Batteries



These symbols on the products, packaging, and/or accompanying documents mean that used electrical and electronic products and batteries should not be mixed with general household waste.

For proper treatment, recovery and recycling of old products and used batteries, please take them to applicable collection points, in accordance with your national legislation and the Directives 2002/96/EC and 2006/66/EC.

By disposing of these products and batteries correctly, you will help to save valuable resources and prevent any potential negative effects on human health and the environment which could otherwise arise from inappropriate waste handling.

For more information about collection and recycling of old products and batteries, please contact your local municipality, your waste disposal service or the point of sale where you purchased the items.

Penalties may be applicable for incorrect disposal of this waste, in accordance with national legislation.



### For business users in the European Union

If you wish to discard electrical and electronic equipment, please contact your dealer or supplier for further information.

### [Information on Disposal in other Countries outside the European Union]

These symbols are only valid in the European Union. If you wish to discard these items, please contact your local authorities or dealer and ask for the correct method of disposal.



### Note for the battery symbol (bottom two symbol examples):

This symbol might be used in combination with a chemical symbol. In this case it complies with the requirement set by the Directive for the chemical involved.

## ■ Indemnity concerning recording content

The manufacturer shall in no event be liable for the loss of recordings due to malfunction or defect of this unit, its accessories or recordable media.

## ■ Carefully observe copyright laws

**Recording of pre-recorded tapes or discs or other published or broadcast material for purposes other than your own private use may infringe copyright laws. Even for the purpose of private use, recording of certain material may be restricted.**

These operating instructions are designed for use with models (HDC-SD200) and (HDC-HS200). Pictures may be slightly different from the original.

- The illustrations used in these operating instructions show model (HDC-SD200), however, parts of the explanation refer to different models.
- Depending on the model, some functions are not available.
- Features may vary, so please read carefully.

## ■ Cards that you can use with this unit

### SD Memory Card and SDHC Memory Card

- 4 GB or more Memory Cards that do not have the SDHC logo are not based on SD Memory Card Specifications.
- Refer to page 24 for more details on SD cards.

## ■ For the purposes of these operating instructions

- SD Memory Card and SDHC Memory Card are referred to as the “SD card”.
- Functions that can be used for motion picture recording/motion picture playback are indicated by **VIDEO** in these operating instructions.
- Functions that can be used for still picture recording/still picture playback are indicated by **PHOTO** in these operating instructions.
- “HD Writer AE 1.0 for HDC” is referred to as the “HD Writer AE 1.0”.
- Pages for reference are indicated by an arrow, for example: → 00

## ■ Licenses

- SDHC Logo is a trademark.
- “AVCHD” and the “AVCHD” Logo are trademarks of Panasonic Corporation and Sony Corporation.
- Manufactured under license from Dolby Laboratories.  
Dolby and the double-D symbol are trademarks of Dolby Laboratories.
- HDMI, the HDMI Logo and the High-Definition Multimedia Interface are the registered trademarks or trademarks of HDMI Licensing LLC.
- HDAVI Control™ is a trademark of Panasonic Corporation.
- “x.v.Colour” is trademark.
- LEICA is a registered trademark of Leica Microsystems IR GmbH and DICOMAR is a registered trademark of Leica Camera AG.
- Microsoft®, Windows®, Windows Vista® and DirectX® are either registered trademarks or trademarks of the Microsoft Corporation in the United States and/or other countries.
- Microsoft product screen shot(s) reprinted with permission from Microsoft Corporation.
- IBM and PC/AT are registered trademarks of International Business Machines Corporation of the U.S.
- Intel®, Core™, Pentium® and Celeron® are the registered trademarks or trademarks of the Intel Corporation in the United States and other countries.
- AMD Athlon™ is a trademark of the Advanced Micro Devices, Inc.
- Apple, Mac OS and iMovie are either registered trademarks or trademarks of Apple Inc. in the United States and/or other countries.
- PowerPC is a trademark of International Business Machines Corporation.
- Other names of systems and products mentioned in these instructions are usually the registered trademarks or trademarks of the manufacturers who developed the system or product concerned.

This product is licensed under the AVC patent portfolio license for the personal and non-commercial use of a consumer to (i) encode video in compliance with the AVC Standard (“AVC Video”) and/or (ii) decode AVC Video that was encoded by a consumer engaged in a personal and non-commercial activity and/or was obtained from a video provider licensed to provide AVC Video. No license is granted or shall be implied for any other use. Additional information may be obtained from MPEG LA, LLC. See <http://www.mpegla.com>.

# Contents

Information for Your Safety .....	2
Accessories.....	9
Features.....	10

## Preparation

### Before using

<b>1 Handling of HDD (Hard disk drive)</b>	
[HDC-HS200] .....	11
<b>2 Parts identification and handling .....</b>	<b>13</b>
[HDC-SD200].....	13
[HDC-HS200].....	16

### Setup

<b>1 Power supply .....</b>	<b>19</b>
Charging the battery .....	19
Inserting/removing the battery .....	20
Charging and recording time .....	21
Connecting to the AC outlet.....	23
<b>2 Preparation of SD cards.....</b>	<b>24</b>
Cards that you can use with this unit...	24
Inserting/removing an SD card .....	25
<b>3 Selecting a mode</b>	
<b>(Turning the unit on/off) .....</b>	<b>26</b>
Turning the power on and off with the LCD monitor .....	27
<b>4 How to use the touch screen.....</b>	<b>28</b>
<b>5 Using the menu screen .....</b>	<b>29</b>
Language selection .....	30
Menu list .....	30
<b>6 Setting date and time .....</b>	<b>34</b>
World time setting (Displaying the time of the travel destination) .....	36
<b>7 Adjusting LCD monitor .....</b>	<b>37</b>
LCD monitor adjustment.....	37
Touch screen calibration.....	38
Changing the picture quality on the LCD monitor .....	38
Recording Yourself .....	38
<b>8 Using with the remote control.....</b>	<b>39</b>
Operation of direction buttons/ OK button .....	40

## Recording

### Recording (Basic)

<b>1 Before recording .....</b>	<b>41</b>
Intelligent auto mode.....	42
Quick start.....	44
Quick power on .....	45
<b>2 Recording motion pictures .....</b>	<b>46</b>
Recording modes/approximate recordable time .....	48
PRE-REC .....	49
Shooting guide .....	49
<b>3 Recording still pictures .....</b>	<b>50</b>
Aspect ratio/picture size .....	52
Picture quality.....	52
Recording still pictures in motion picture recording mode .....	53
Number of recordable pictures.....	54
<b>4 Zoom in/out function .....</b>	<b>57</b>
Digital zoom function.....	57
Extra optical zoom.....	57
<b>5 Optical image stabilizer function.....</b>	<b>58</b>
<b>6 AF tracking .....</b>	<b>59</b>

### Recording (Advanced)

<b>1 Recording functions of operation</b>	
<b>icons.....</b>	<b>60</b>
Operation icons.....	60
<b>2 Recording functions of menus .....</b>	<b>64</b>
<b>3 Manual recording .....</b>	<b>73</b>
White balance .....	74
Manual shutter speed/ iris adjustment.....	75
Manual focus adjustment.....	76
Picture adjustment .....	76

## Playback

### Playback

- 1 Motion picture playback ..... 77**
  - Creating still picture from motion picture ..... 80
  - Highlight&Time frame index..... 80
  - Playing back motion pictures by date..... 81
  - Intelligent scene selection ..... 81
  - Highlight playback ..... 82
  - Repeat playback..... 83
  - Resuming the previous playback..... 83
- 2 Still picture playback..... 84**
  - Playing back still pictures by date..... 86

### Editing

- 1 Deleting scenes/still pictures ..... 87**
- 2 Dividing a scene to delete ..... 89**
- 3 Protecting scenes/still pictures ..... 90**
- 4 DPOF setting..... 91**
- 5 Copying between SD card and HDD [HDC-HS200] ..... 92**
  - Confirming remaining capacity on the copy destination..... 92
  - Copying ..... 93
- 6 Formatting..... 95**

### With a TV

- 1 Watching Video/Pictures on your TV ..... 96**
  - Connecting with a HDMI mini cable..... 98
  - Listening in 5.1 channel sound..... 99
  - Connecting with the component cable ..... 99
- 2 Playback using VIERA Link (HDAVI Control™)..... 100**

## Backup

### With other products

- 1 Connecting a DVD burner to copy to/play back a disc ..... 103**
  - Preparing for copying/playing back... 103
  - Copying to discs..... 105
  - Playing back the copied disc..... 108
  - Managing the copied disc (Formatting, Auto protect, Displaying disc information)..... 109
- 2 Dubbing images onto other video device ..... 110**
- 3 With a printer (PictBridge)..... 111**

### With a PC

#### Before using

- 1 What you can do with a PC ..... 114**
  - End User License Agreement ..... 116
- 2 Operating environment..... 117**

#### Setup

- 1 Installation ..... 119**
- 2 Connecting to a PC ..... 121**
  - About the PC display..... 123

#### Using with a PC

- 1 Starting HD Writer AE 1.0 ..... 124**
  - Reading the operating instructions of the software applications..... 124
- 2 If using Macintosh..... 125**

## Others

#### Indications

- 1 Indications ..... 126**
- 2 Messages ..... 129**
  - About recovery ..... 130

#### Helpful hints

- 1 Functions that cannot be used simultaneously ..... 131**
- 2 Troubleshooting ..... 133**

#### Cautions for use ..... 140

#### Specifications ..... 143

#### Index ..... 146

## ■ Sales and Support Information

### Customer Care Centre

- For customers within the UK: 0844 844 3852
- For customers within the Republic of Ireland: 01 289 8333
- Visit our website for product information
- E-mail: [customer.care@panasonic.co.uk](mailto:customer.care@panasonic.co.uk)

### Technical Support for AV Software

- For customers within the UK: 0844 844 3869
- For customers within the Republic of Ireland: 01 289 8333

### Direct Sales at Panasonic UK

- For customers: 0844 844 3856
- Order accessory and consumable items for your product with ease and confidence by phoning our Customer Care Centre Monday–Thursday 9.00 a.m.–5.30 p.m., Friday 9.30 a.m.– 5.30 p.m. (Excluding public holidays)
- Or go on line through our Internet Accessory ordering application at [www.panasonic.co.uk](http://www.panasonic.co.uk).
- Most major credit and debit cards accepted.
- All enquiries transactions and distribution facilities are provided directly by Panasonic UK Ltd.
- It couldn't be simpler!
- Also available through our Internet is direct shopping for a wide range of finished products, take a browse on our website for further details.

*Interested in purchasing an extended guarantee?*

*Please call 0870 240 6284 or visit our website [www.panasonic.co.uk/guarantee](http://www.panasonic.co.uk/guarantee).*

# Accessories

Check the accessories before using this unit.

**Battery pack**  
VW-VBG130



**AC adaptor**  
VSK0698



**AC cable**  
K2CT3CA00004



**DC cable**  
K2GJYDC00004



**Remote control  
(Battery built-in)**  
N2QAEC000024



**AV cable**  
K2KYYYY00054



**Component cable**  
K1HY10YY0005



**USB cable**  
K1HY04YY0032



**Stylus pen**  
VFC4394



**CD-ROM**



## Optional accessories

Some optional accessories may not be available in some countries.

AC adaptor (VW-AD21EB-K)*1
Battery pack (lithium/VW-VBG130)
Battery pack (lithium/VW-VBG260)
Battery pack (lithium/VW-VBG6)*2
Battery pack holder kit (VW-VH04)
HDMI mini cable (RP-CDHM15, RP-CDHM30)
Tele conversion lens (VW-T4314H)
Wide conversion lens (VW-W4307H)
Filter kit (VW-LF43NE)
Video DC light (VW-LDC103E)*3
Light bulb for video DC light (VZ-LL10E)
Shoe adaptor (VW-SK12E)
DVD burner (VW-BN1)
SD/SDHC Memory Card (Refer to page 24)

\*1 The supplied DC cables cannot be used on this unit.

\*2 The battery pack holder kit VW-VH04 (optional) is necessary.

\*3 The shoe adaptor VW-SK12E (optional) is necessary.

# Features

## ■ Very clear high definition pictures

This unit can record detailed high definition images.



**High definition images (1920×1080)\***

**A** Number of available scan lines 1080

\* If the recording mode is HA/HG/HX.



**Standard images (720×576)**

**B** Number of available scan lines 576

## What is the AVCHD?

This is a format for recording and playing back highly detailed high definition images.

Images are recorded based on the MPEG-4 AVC/H.264 codec for compressing images and audio is recorded with the Dolby Digital 5.1 Creator.

- Since the recording method is different from an ordinary DVD video etc., the data are not compatible.

## ■ Compatibility with other products

With other products	Available function	Picture quality
Watching Video/Pictures on your TV (→ 96 to 102)	Playback with the HDMI mini cable – Playback using VIERA Link (HDAVI Control™) (→ 100)	High definition images
	Playback with the component cable [1080i]	
	Playback with the component cable [576i]	Standard images
	Playback with the AV cable	
Using a DVD burner (→ 103 to 109)	Connecting a DVD burner to copy to/play back a disc – Playing back the copied disc (→ 108)	High definition images
		Standard images
What you can do with a PC (→ 114 to 115)	Copying data to a PC and editing	High definition images
	Writing data to BD/DVD discs and SD cards	
	Converting the motion picture data to MPEG2	Standard images
	Creating a DVD Video disc	
Dubbing images onto other video device (→ 110)	Dubbing images when connecting with the AV cable	Standard images

## Handling of HDD (Hard disk drive) [HDC-HS200]

This unit is equipped with the built-in 80 GB HDD. While the HDD is capable of storing a large amount of data, there are a few things to look out for. When using this component, pay attention to the following points.

### Indemnity about recorded content

Panasonic does not accept any responsibility for damages directly or indirectly due to any type of problems that result in loss of recording or edited content, and does not guarantee any content if recording or editing does not work properly. Likewise, the above also applies in a case where any type of repair is made to the unit (including any other non-HDD related component).

#### ■ Do not expose the HDD to vibrations and shocks.

Due to the environment and handling conditions, the HDD may be subject to partial damages or may not be able to read, record, and play back data. Do not expose the unit to vibrations or shock, and do not turn off the power during recording or playback.

**If the unit is used in a place with loud sounds, such as a club or venue, the recording may stop due to sound vibrations. Recording data on an SD card is recommended in these places.**

#### ■ Back up data periodically.

The HDD is temporary storage. In order to avoid erasing data due to static electricity, electromagnetic waves, breakage, and failures, back up the data to a PC or DVD disc. (→ 103, 114)

#### ■ If the HDD experiences any abnormality, back up data immediately.

Failure in the HDD may produce continuous noise or choppy sound during recording or playing back. Continuous use will cause further deterioration, and may eventually disable the HDD. If these phenomena are observed, copy the data on the HDD to a PC, a DVD disc etc. immediately and contact your dealer.

Once the HDD is out of order, data cannot be restored.

#### ■ Operation may stop in hot or cold environments.

The unit is disabled in order to protect the HDD.

#### ■ Do not use the unit in low atmospheric pressures.

The HDD may fail if it is used at altitudes of 3000 m or higher above sea level.

#### ■ Transportation

When the unit is transported, turn off the power and be careful not to shake, fall, or impact the unit.

#### ■ Falling detection

[  ] is indicated on the screen when it detects a falling state (a weightless state). If the falling state is detected repeatedly, the unit may stop the recording or playback operation in order to protect the HDD.

## ■ HDD access lamp [ACCESS HDD]

**A**

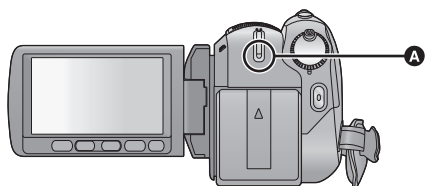

- The lamp illuminates while the HDD is being accessed (initialization, recording, playback, deleting etc.).
- Do not perform the following operations when the lamp illuminates. It may damage the HDD or cause a malfunction in the unit.
  - Turn the unit off
  - Insert and remove the USB cable
  - Expose the unit to vibrations or shock
- About disposing of or giving away this unit.  
(→ 141)

# Parts identification and handling

## [HDC-SD200]

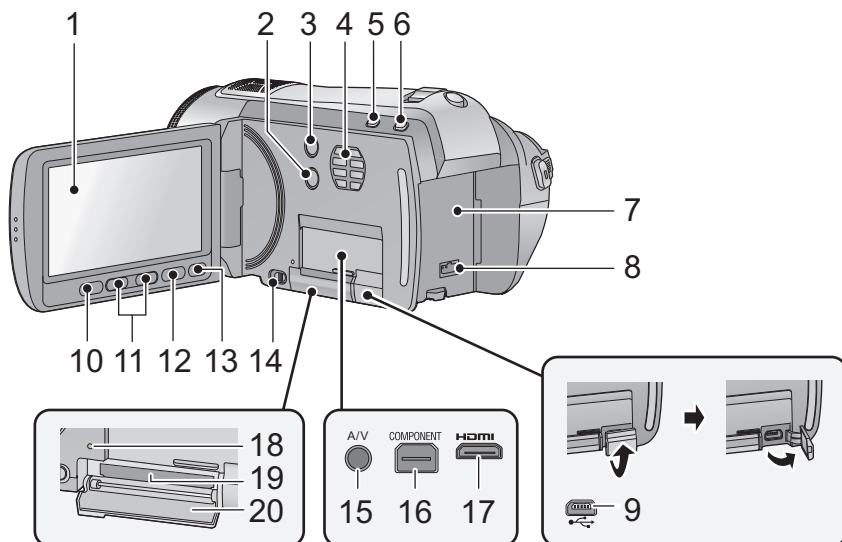

### 1 LCD monitor (Touch screen) (→ 28, 37)

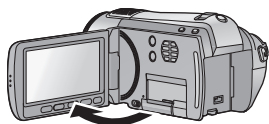

- It can open up to 90°.

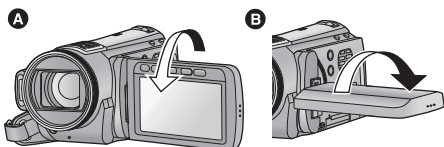

- It can rotate up to 180° **A** towards the lens or 90° **B** towards the opposite direction.

Due to limitations in LCD production technology, there may be some tiny bright or dark spots on the LCD monitor screen. However, this is not a malfunction and does not affect the recorded picture.

### 2 Manual button [MANUAL] (→ 73)

### 3 Optical image stabilizer button [O.I.S.] (→ 58)

### 4 Inlet (cooling fan)

- The cooling fan rotates to prevent the internal temperature rising. Take care not to cover the inlet when using this unit.

### 5 Intelligent auto button [iA] (→ 42)

### 6 PRE-REC button [PRE-REC] (→ 49)

### 7 Battery holder (→ 20)

### 8 DC input terminal [DC IN] (→ 23)

- Always use the supplied AC adaptor or a genuine Panasonic AC adaptor (VW-AD21EB-K; optional).

### 9 USB terminal [ ] (→ 103, 111, 121)

### 10 Sub recording start/stop button (→ 41)

- This button functions in the same manner as the recording start/stop button.

## 11 Zoom buttons (→ 57)

- These buttons function in the same manner as the zoom lever. Changing the thumbnail display and adjusting the volume can be operated.

## 12 Menu button [MENU] (→ 29)

## 13 Delete button [⏏] (→ 87)

## 14 SD card open lever [OPEN] (→ 25)

## 15 Audio-video output terminal [A/V] (→ 96, 110)

- Use the AV cable (only the supplied cable).

## 16 Component terminal [COMPONENT] (→ 96)

## 17 HDMI mini connector [HDMI] (→ 96, 100)

## 18 Access lamp [ACCESS] (→ 25)

## 19 Card slot (→ 25)

## 20 SD card cover (→ 25)

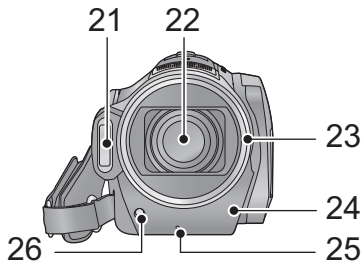



## 21 Built-in flash (→ 62)

## 22 Lens (LEICA DICOMAR)

### Lens cover **A**



- The lens cover opens in  motion picture recording mode or  still picture recording mode. (→ 26)

## 23 Lens hood

Rotate the lens hood counter-clockwise **A** to remove it. In order to attach it, place into slot **B**, and then rotate it clockwise **C**.

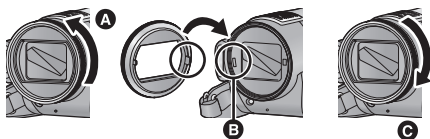

- Attach the MC protector or the ND filter of the Filter Kit (VW-LF43NE; optional) in front of the lens hood.

- When fitting the tele conversion lens (VW-T4314H; optional) or the wide conversion lens (VW-W4307H; optional), first remove the lens hood.

### Be careful about the following.

When 2 lens accessories, such as the ND filter and tele conversion lens, are fitted and the zoom lever is pressed toward the W side, the 4 corners of an image will be darkened. (Vignetting)  
(When fitting 2 lens accessories, first remove the lens hood and then fit them.)

### Attaching the lens cap (Included in the Filter Kit (VW-LF43NE; optional))

- When the filter kit (VW-LF43NE; optional) is used, protect the lens surface while the unit is not used with the lens cap supplied with the filter kit.

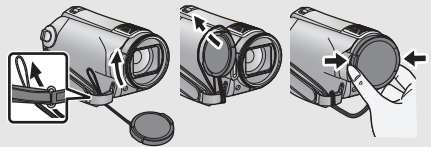



- To attach or remove the lens cap, hold both sides of the lens cap with the tips of your finger and thumb.

## 24 Remote control sensor (→ 40)

## 25 Recording lamp (→ 31)

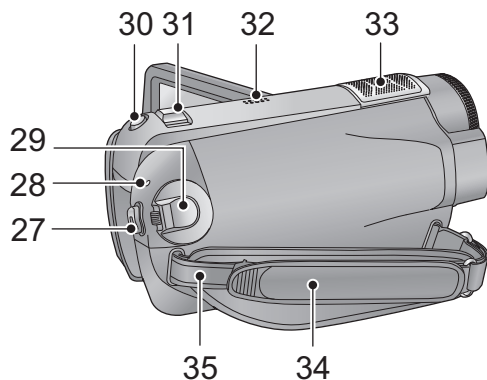
## 26 AF assist lamp (→ 71)



- 27 Recording start/stop button (→ 46)
  - 28 Status indicator (→ 26)
  - 29 Mode dial (→ 26)
  - 30 Photoshot button [  ] (→ 50)
  - 31 Zoom lever [W/T] (In recording mode) (→ 57)
  - Thumbnail display switch/Volume lever [-  /VOL+] (In playback mode) (→ 78)
  - 32 Speaker
  - 33 Internal microphones (5.1 channel support)
  - 34 Grip belt
- Adjust the length of the grip belt so that it fits your hand.

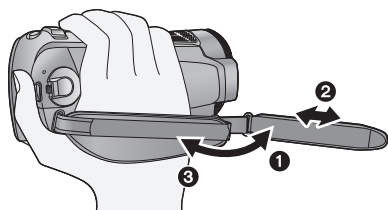

- 1 Flip the belt.
  - 2 Adjust the length.
  - 3 Replace the belt.
- 35 Shoulder strap fixture

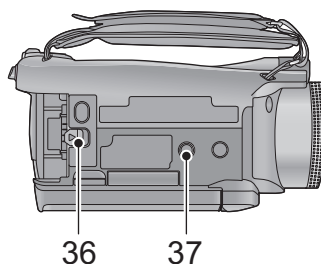

- 36 Battery release lever [BATT] (→ 20)
- 37 Tripod receptacle

This is a hole for attaching the unit to the optional tripod. (For details on mounting the tripod, refer to the operating instructions for the tripod.)

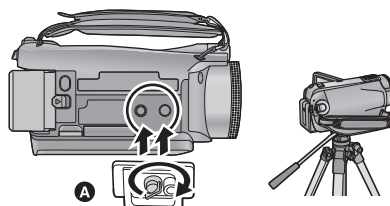

- A Camera base

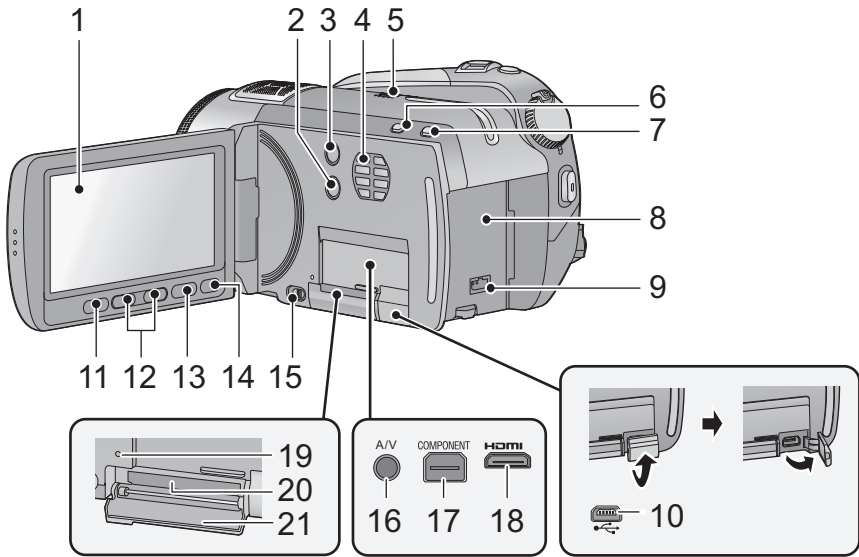

## 1 LCD monitor (Touch screen) (→ 28, 37)

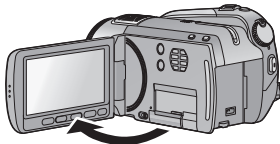

- It can open up to 90°.

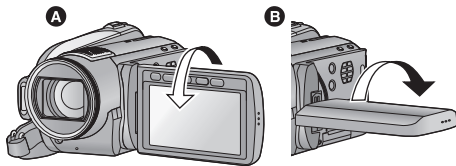

- It can rotate up to 180° **A** towards the lens or 90° **B** towards the opposite direction.

Due to limitations in LCD production technology, there may be some tiny bright or dark spots on the LCD monitor screen. However, this is not a malfunction and does not affect the recorded picture.

- 2 **Manual button [MANUAL] (→ 73)**
- 3 **Optical image stabilizer button [(O.I.S.) (→ 58)]**

## 4 Inlet (cooling fan)

- The cooling fan rotates to prevent the internal temperature rising. Take care not to cover the inlet when using this unit.

## 5 Speaker

## 6 Intelligent auto button [iA] (→ 42)

## 7 PRE-REC button [PRE-REC] (→ 49)

## 8 Battery holder (→ 20)

## 9 DC input terminal [DC IN] (→ 23)

- Always use the supplied AC adaptor or a genuine Panasonic AC adaptor (VW-AD21EB-K; optional).

## 10 USB terminal [↔] (→ 103, 111, 121)

## 11 Sub recording start/stop button (→ 41)

- This button functions in the same manner as the recording start/stop button.

## 12 Zoom buttons (→ 57)

- These buttons function in the same manner as the zoom lever. Changing the thumbnail display and adjusting the volume can be operated.

## 13 Menu button [MENU] (→ 29)

## 14 Delete button [⏏] (→ 87)

- 15 SD card open lever [OPEN] (→ 25)
- 16 Audio-video output terminal [A/V] (→ 96, 110)
  - Use the AV cable (only the supplied cable).
- 17 Component terminal [COMPONENT] (→ 96)
- 18 HDMI mini connector [HDMI] (→ 96, 100)
- 19 Access lamp [ACCESS] (→ 25)
- 20 Card slot (→ 25)
- 21 SD card cover (→ 25)

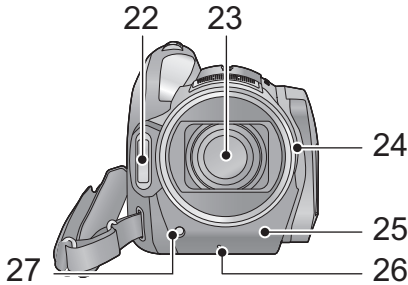

- 22 Built-in flash (→ 62)
- 23 Lens (LEICA DICOMAR)

### Lens cover **A**



- The lens cover opens in motion picture recording mode or still picture recording mode. (→ 26)

### 24 Lens hood

Rotate the lens hood counter-clockwise **A** to remove it. In order to attach it, place into slot **B**, and then rotate it clockwise **C**.

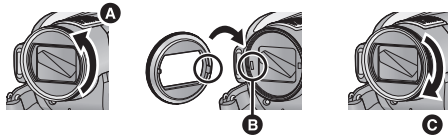

- Attach the MC protector or the ND filter of the Filter Kit (VW-LF43NE; optional) in front of the lens hood.
- When fitting the tele conversion lens (VW-T4314H; optional) or the wide conversion lens (VW-W4307H; optional), first remove the lens hood.

### Be careful about the following.

When 2 lens accessories, such as the ND filter and tele conversion lens, are fitted and the zoom lever is pressed toward the W side, the 4 corners of an image will be darkened. (Vignetting)  
(When fitting 2 lens accessories, first remove the lens hood and then fit them.)

### Attaching the lens cap (Included in the Filter Kit (VW-LF43NE; optional))

- When the filter kit (VW-LF43NE; optional) is used, protect the lens surface while the unit is not used with the lens cap supplied with the filter kit.

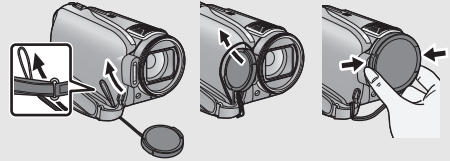

- To attach or remove the lens cap, hold both sides of the lens cap with the tips of your finger and thumb.

- 25 Remote control sensor (→ 40)
- 26 Recording lamp (→ 31)
- 27 AF assist lamp (→ 71)

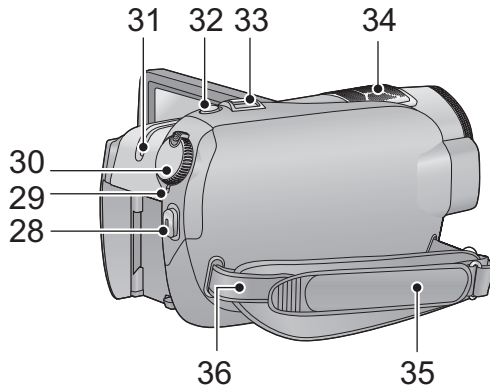

**28** Recording start/stop button (→ 46)

**29** Status indicator (→ 26)

**30** Mode dial (→ 26)

**31** HDD access lamp [ACCESS HDD] (→ 12)

**32** Photoshot button [  ] (→ 50)

**33** Zoom lever [W/T] (In recording mode) (→ 57)

Thumbnail display switch/Volume lever  
[-  /VOL+] (In playback mode) (→ 78)

**34** Internal microphones (5.1 channel support)

**35** Grip belt

Adjust the length of the grip belt so that it fits your hand.

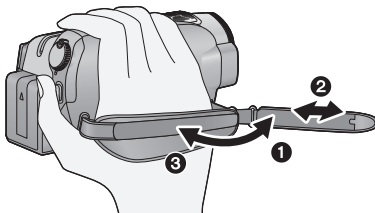

**1** Flip the belt.

**2** Adjust the length.

**3** Replace the belt.

**36** Shoulder strap fixture

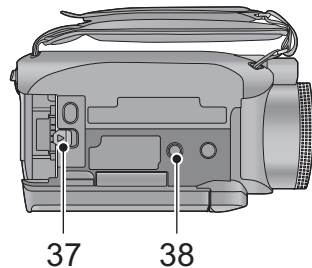

**37** Battery release lever [BATT] (→ 20)

**38** Tripod receptacle

This is a hole for attaching the unit to the optional tripod. (For details on mounting the tripod, refer to the operating instructions for the tripod.)

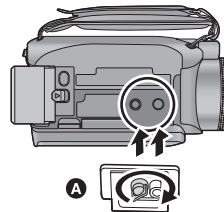

**A** Camera base



### ■ About batteries that you can use with this unit

The battery that can be used with this unit is VW-VBG130/VW-VBG260/VW-VBG6.

- This unit has a function to distinguish the batteries that can be used, and the batteries (VW-VBG130/VW-VBG260/VW-VBG6) are compatible with this function. (The batteries that are not compatible to this function cannot be used.)
- To use the VW-VBG6 for this unit, the battery pack holder kit VW-VH04 (optional) is required.

It has been found that counterfeit battery packs which look very similar to the genuine product are made available to purchase in some markets. Some of these battery packs are not adequately protected with internal protection to meet the requirements of appropriate safety standards. There is a possibility that these battery packs may lead to fire or explosion. Please be advised that we are not liable for any accident or failure occurring as a result of use of a counterfeit battery pack. To ensure that safe products are used we would recommend that a genuine Panasonic battery pack is used.

## Charging the battery

When this unit is purchased, the battery is not charged. Charge the battery before using this unit.

### Important:

If the DC cable is connected to the AC adaptor, then the battery will not charge. Remove the DC cable from the AC adaptor.

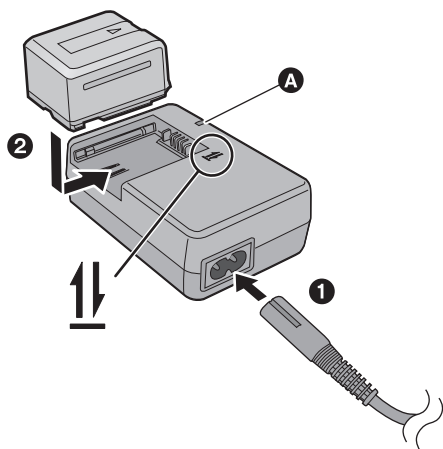

### Charging lamp [CHARGE] **A**

#### Lights up:

Charging (Battery charging time: → 21)

#### Goes off:

Charging completed

#### Flashing:

Make sure that the terminals of the battery or the AC adaptor are not exposed to dirt, foreign objects or dust, then reconnect them properly. (→ 142)

**1** Connect the AC cable to the AC adaptor and the AC outlet.

**2** Insert the battery into the AC adaptor by aligning the arrows.

- We recommend using Panasonic batteries (→ 9, 21).
- If you use other batteries, we cannot guarantee the quality of this product.
- Do not heat or expose to flame.
- Do not leave the battery(ies) in an automobile exposed to direct sunlight for a long period of time with doors and windows closed.

## Inserting/removing the battery

Install the battery by inserting it in the direction shown in the figure.

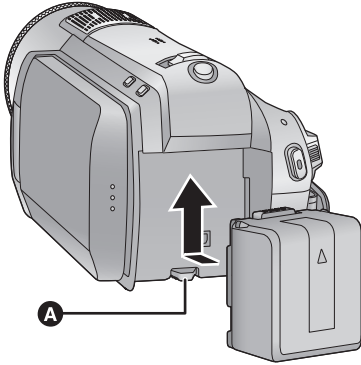

**A** Insert the battery until it clicks and locks.

### Removing the battery

Make sure that the power is off and the status indicator is turned off, and then remove by holding onto it taking care not to drop.

**Move the BATTERY lever in the direction indicated by the arrow and remove the battery when unlocked.**

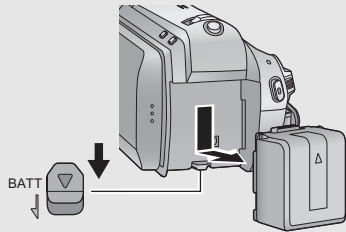

### CAUTION

Danger of explosion if battery is incorrectly replaced. Replace only with the same or equivalent type recommended by the manufacturer. Dispose of used batteries according to the manufacturer's instructions.

## Charging and recording time

### ■ Charging/Recording time

- Temperature: 25 °C/humidity: 60%

HDC-SD200			
Battery model number [Voltage/Capacity (minimum)]	Charging time	Maximum continuously recordable time	Actual recordable time
Supplied battery/ VW-VBG130 (optional) [7.2 V/1250 mAh]	2 h 35 min	1 h 45 min	1 h 5 min
VW-VBG260 (optional) [7.2 V/2500 mAh]	4 h 40 min	3 h 25 min	2 h 5 min
VW-VBG6 (optional)* [7.2 V/5400 mAh]	9 h 25 min	8 h 30 min	5 h 15 min



HDC-HS200					
Battery model number [Voltage/Capacity (minimum)]	Charging time	Recording destination	Recording mode	Maximum continuously recordable time	Actual recordable time
Supplied battery/ VW-VBG130 (optional) [7.2 V/1250 mAh]	2 h 35 min	HDD	HA/HG/HX/ HE	1 h 35 min	1 h
		SD	HA/HG/HX/ HE	1 h 40 min	1 h
VW-VBG260 (optional) [7.2 V/2500 mAh]	4 h 40 min	HDD	HA/HG/HX	3 h 5 min	1 h 55 min
			HE	3 h 10 min	
		SD	HA/HG/HX/ HE	3 h 20 min	2 h
		HDD	HA/HG/HX	7 h 45 min	4 h 45 min
9 h 25 min			HE	7 h 50 min	4 h 50 min
		SD	HA/HG/HX/ HE	8 h 15 min	5 h 5 min

\* The battery pack holder kit VW-VH04 (optional) is necessary.

- These times are approximations.
- The indicated charging time is for when the battery has been discharged completely. Charging time and recordable time vary depending on the usage conditions such as high/low temperature.

- 
- The actual recordable time refers to the recordable time when repeatedly starting/stopping recording, turning the unit on/off, moving the zoom lever etc.
  - The batteries heat up after use or charging. This is not a malfunction.

### Battery capacity indication

- The display changes as the battery capacity reduces.  If there is less than 3 minutes remaining, then  will become red. If the battery discharges, then () will flash.
- The remaining battery capacity is displayed when using the Panasonic battery that you can use for this unit. It may take time to display the remaining battery capacity. The actual time can vary depending on your actual use.
- The maximum amount of remaining battery capacity able to be indicated is 9 hours 59 minutes. If the actual remaining time exceeds 9 hours 59 minutes, the indication will stay green and will not change until the remaining time falls below 9 hours 59 minutes.
- When changing modes, the time indication will turn off momentarily in order to recalculate the remaining battery capacity time.
- When using the AC adaptor or batteries made by other companies, the remaining battery capacity will not be shown.

## Connecting to the AC outlet

The unit is in the standby condition when the AC adaptor is connected. The primary circuit is always “live” as long as the AC adaptor is connected to an electrical outlet.

### Important:

**While the DC cable is connected to the AC adaptor, the battery will not charge.**

- Do not use the AC cable with any other equipment as it is designed only for this unit. Also, do not use the AC cable from other equipment with this unit.

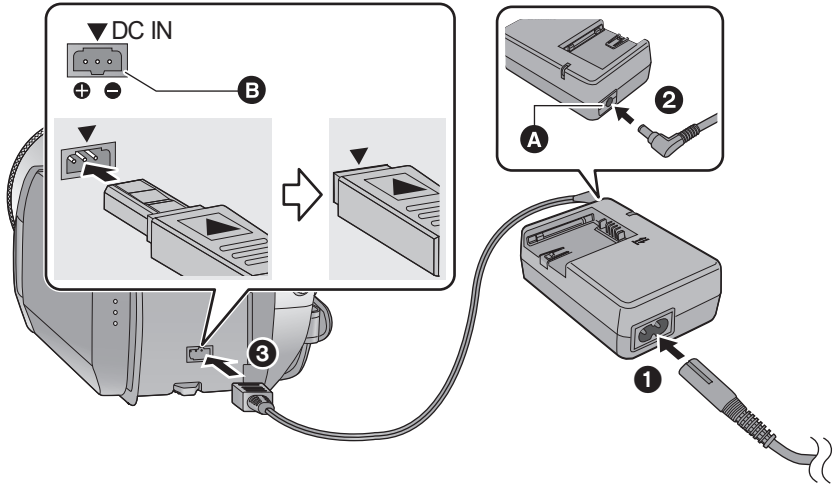

**A** DC output terminal

**B** DC input terminal

Insert the DC cable matching the [▼] mark of the DC input terminal.

**1** Connect the AC cable to the AC adaptor and the AC outlet.

**2** Connect the DC cable to the AC adaptor.

**3** Connect the DC cable to the DC input terminal [DC IN].

- Make sure to set the mode to OFF and the status indicator is turned off when disconnecting the AC adaptor.

## Preparation of SD cards

This unit (an SDHC compatible device) is compatible with both SD Memory Cards and SDHC Memory Cards. When using an SDHC Memory Card on another device, confirm that the device supports the SDHC Memory Card.

## Cards that you can use with this unit

Use SD cards conforming to Class 4 or higher of the SD Speed Class Rating\* for motion picture recording.

Card type	Capacity	Motion picture recording The following models of Panasonic SD cards can be used.	Still picture recording
SD Memory Card	8 MB 16 MB	Cannot be used.	Can be used.
	32 MB 64 MB 128 MB 256 MB 512 MB	Cannot be guaranteed in operation. The recording may suddenly stop during motion picture recording depending on the SD card you use. (→ 134)	
	1 GB	RP-SDV01G	
	2 GB	RP-SDV02G, RP-SDM02G	
	SDHC Memory Card	4 GB	
6 GB		RP-SDM06G	
8 GB		RP-SDV08G	
12 GB		RP-SDM12G	
16 GB		RP-SDV16G	
32 GB		RP-SDV32G	

\* The SD Speed Class Rating is the speed standard for successive writes.

- Please confirm the latest information about SD Memory Cards/SDHC Memory Cards that can be used for motion picture recording on the following website.

[http://panasonic.jp/support/global/cs/e\\_cam](http://panasonic.jp/support/global/cs/e_cam)  
(This website is in English only.)

- 4 GB or more Memory Cards that do not have the SDHC logo are not based on SD Memory Card Specifications.

- When the write-protect switch **A** on SD card is locked, no recording, deletion or editing will be possible on the card.

- Keep the Memory Card out of reach of children to prevent swallowing.

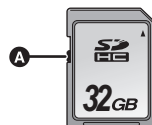

## Inserting/removing an SD card

When using an SD card not from Panasonic, or one previously used on other equipment, for the first time on this unit, format the SD card. (→ 95) When the SD card is formatted, all of the recorded data is deleted. Once the data is deleted, it cannot be restored. Copy valuable data onto a PC, DVD disc etc. before proceeding with the formatting. (→ 103, 114)

### Caution:

When the SD card is removed while the access lamp is lit, this unit may malfunction or the data recorded on the SD card may be lost.

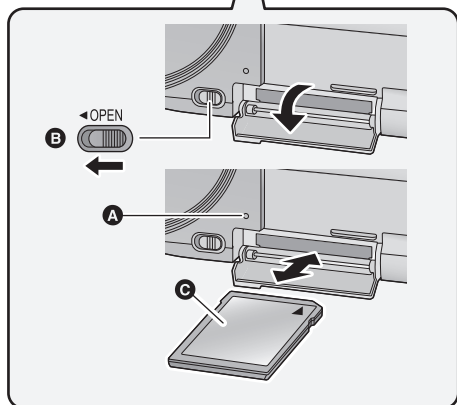
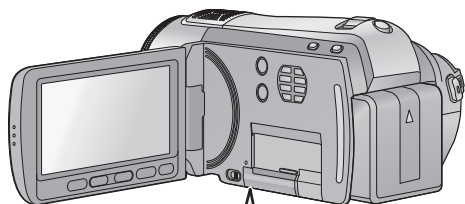

### Access lamp [ACCESS] (A)

- When this unit is accessing the SD card the access lamp lights up.

### 1 Open the LCD monitor.

- Check that the access lamp has gone off.

### 2 Open the SD card cover by sliding the OPEN lever (B).

### 3 Insert/remove the SD card.

- Face the label side (C) in the direction shown in the illustration and press it straight in as far as it will go.
- Press the centre of the SD card and then pull it straight out.

### 4 Securely close the SD card cover.

- Securely close it until it clicks.

- Do not touch the terminals on the back of the SD card.
- Do not apply strong shocks, bend, or drop the SD card.
- Electrical noise, static electricity or the failure of this unit or the SD card may damage or erase the data stored on the SD card.
- When the card access lamp is lit, do not:
  - Remove the SD card
  - Turn the unit off
  - Insert and remove the USB cable
  - Expose the unit to vibrations or shock

Performing the above while the lamp is on may result in damage to data/SD card or this unit.



## Selecting a mode (Turning the unit on/off)

Change the mode to recording, playback or power OFF.

Turn on the power by changing the mode to ,  or  while pressing the lock release button .

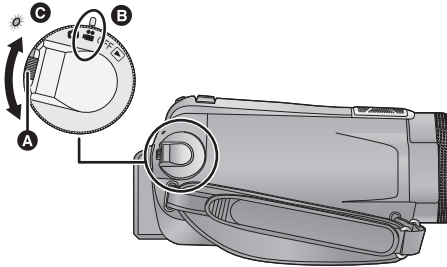
### HDC-SD200



- Rotate the mode dial while at the same time pressing in the lock release button if changing from OFF to another mode.
- Align with the mark .
- Status indicator .

### HDC-HS200

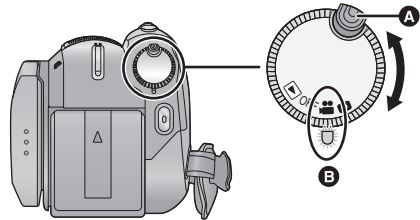



- Rotate the mode dial while at the same time pressing in the lock release button if changing from OFF to another mode.
- Align with the status indicator .

The status indicator lights.



### To turn off the power

Change the mode to OFF.

The status indicator goes off.

	Motion picture recording mode (→ 46)
	Still picture recording mode (→ 50)
	Playback mode (→ 77, 84)
OFF	

## Turning the power on and off with the LCD monitor

When the mode is set to  or  , power is turned on when the LCD monitor is opened, and power is turned off when it is closed.

### ■ To turn on the power

HDC-SD200

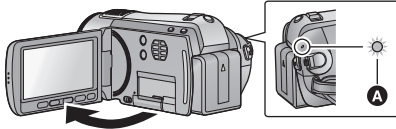

HDC-HS200



**A** The status indicator lights.

### ■ To turn off the power

HDC-SD200

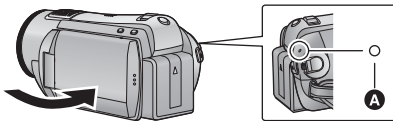

HDC-HS200

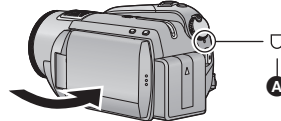

**A** The status indicator goes off.

Change the mode to OFF when this unit is not being used.

# How to use the touch screen

You can operate by directly touching the LCD monitor (touch screen) with your finger.

It is easier to use the stylus pen (supplied) for detailed operation or if it is hard to operate with your fingers.

## ■ Touch

Touch and release the touch screen to select icon or picture.

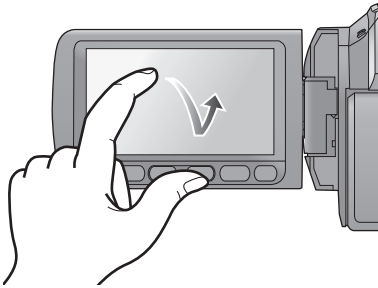

- Touch the centre of the icon.
- Touching the touch screen will not operate while you are touching another part of the touch screen.

## ■ About the Stylus pen

The stylus pen (supplied) can be stored on the unit as shown when it is not being used. Remove the stylus pen from the unit when it is to be used.

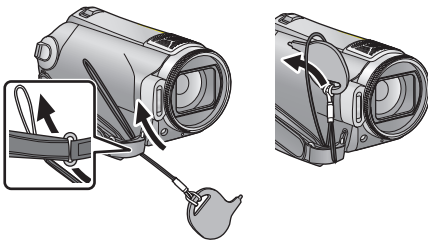

- Only use the supplied stylus pen.
- Do not tuck the stylus pen with the LCD monitor.

## ■ About the operation icons

▲/▼/◀/▶:

These icons are used to switch the menu and thumbnail display page, for item selection and setting etc.

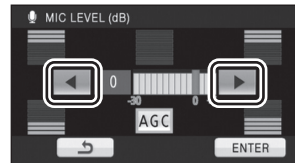
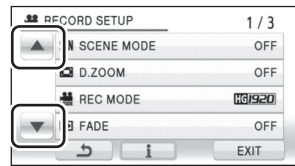

↶:

Touch to return to the previous screen such as when setting menus

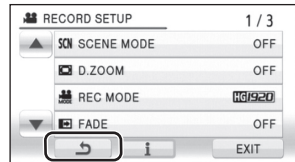

- Wipe the LCD monitor with a soft cloth, such as eye glass cleaner, when it gets dirty with finger prints and others.
- Do not touch the LCD monitor with hard pointed tips, such as ball point pens.
- Do not touch the LCD monitor with your finger nails, or rub or press with strong force.
- It may become hard to see or hard to recognise the touch when the LCD protection sheet is affixed.
- Perform the touch screen calibration when the touch is not recognised or wrong location is recognised. (→ 38)

## Using the menu screen

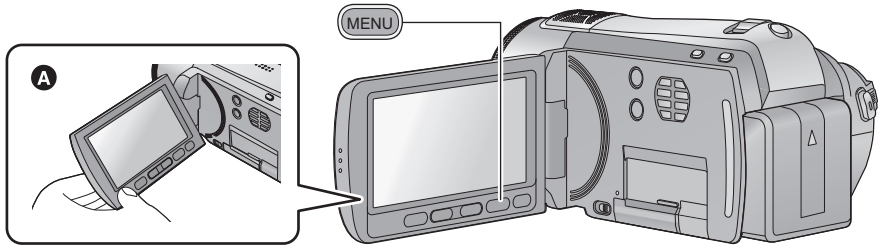

- A** It is recommended to hold the LCD monitor with your thumb and index finger when pressing the buttons on the LCD monitor.

### 1 Press the MENU button.



### 2 Touch the top menu **A**.

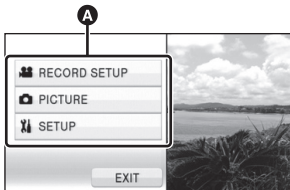

### 3 Touch the submenu **B**.

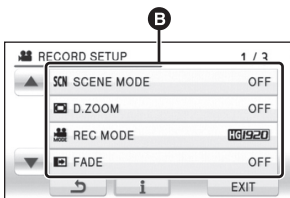

- Next (previous) page can be displayed by touching /.
- Information display setting is completed when is surrounded by yellow after touching it.

### 4 Touch the desired item to enter the setting.

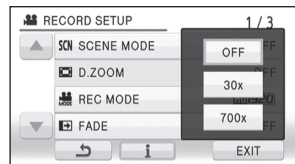

### 5 Touch [EXIT] or press the MENU button to exit the menu setting.

#### ■ About information display setting



An explanation or setting confirmation message of the submenu or item being touched gets displayed in step 3 and 4. Touch the to cancel the information display setting.

## Language selection

You can select the language on the screen display and the menu screen.

**1 Press the MENU button, then touch [SETUP] → [LANGUAGE].**

**2 Touch [English].**

## Menu list

Part of the menu will not be used depending on the used functions. (→ 131)

### Motion picture recording mode

\*1 It is not displayed when the Intelligent auto mode is on.

\*2 These menus are only for **HDC-HS200**.

\*3 **HDC-HS200** When the [MEDIA SELECT] is set to [SD CARD].

\*4 **HDC-HS200** It will be displayed only when the [MEDIA SELECT] is set to [HDD].

\*5 **HDC-HS200** It will not be displayed when the [MEDIA SELECT] is set to [HDD].

### RECORD SETUP

[SCENE MODE]	(→ 64)	[TELE MACRO]	(→ 61)
[D.ZOOM]	(→ 57)	[COLOUR NIGHT VIEW]* <sup>1</sup>	(→ 61)
[GUIDE LINES]* <sup>1</sup>	(→ 65)	[Digital Cinema Colour]* <sup>1</sup>	(→ 67)
[REC MODE]	(→ 48)	[SHOOTING GUIDE]	(→ 49)
[DIGITAL CINEMA]* <sup>1</sup>	(→ 65)	[WIND CUT]* <sup>1</sup>	(→ 68)
[FADE]	(→ 61)	[MIC SETUP]* <sup>1</sup>	(→ 68)
[FADE COLOUR]	(→ 61)	[MIC LEVEL]* <sup>1</sup>	(→ 69)
[AGS]	(→ 66)	[PICTURE ADJUST]* <sup>1</sup>	(→ 76)
[AUTO SLOW SHTR]* <sup>1</sup>	(→ 66)	[MF ASSIST]* <sup>1</sup>	(→ 76)
[FACE FRAMING]	(→ 67)		
[BACKLIGHT COMPENS.]	(→ 61)		
[INTELLIGENT CONTRAST]* <sup>1</sup>	(→ 61)		
[SOFT SKIN MODE]* <sup>1</sup>	(→ 61)		

## PICTURE

[PICTURE SIZE] (→ 52)

[QUALITY] (→ 52)

[HI-SPEED BURST]\*<sup>1</sup> (→ 70)

[SELF TIMER] (→ 62)

[FLASH] (→ 62)

[FLASH LEVEL]\*<sup>1</sup> (→ 62)

[RED EYE]\*<sup>1</sup> (→ 62)

[SHTR SOUND] (→ 71)

## MEDIA SELECT\*<sup>2</sup>

### HDC-HS200

Media to record can be set to [HDD] or [SD CARD].

## SETUP

[DISPLAY]

The screen indications are selected as shown in the illustration below.

[OFF]

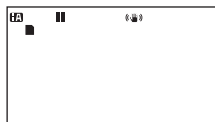

[ON]



[CLOCK SET] (→ 34)

[SET WORLD TIME] (→ 36)

[DATE/TIME] (→ 34)

[DATE FORMAT] (→ 35)

[ECONOMY]

[OFF]:

The power saving function is not activated.

**[5 MINUTES]:**

When about 5 minutes have passed without any operation, this unit automatically turns off to save battery life.

- The power save function will not activate when:
  - connected to AC adaptor
  - using the USB cable for PC, DVD burner, printer etc.
  - PRE-REC is used

[QUICK POWER ON]\*<sup>5</sup> (→ 45)

[QUICK START] (→ 44)

[REMOTE CONTROL] (→ 39)

[REC LAMP]

The recording lamp lights up during recording and flashes when the unit receives a signal from the remote control or when the self-timer is counting down. When this is set to [OFF], it does not light during recording.

---

## [ALERT SOUND]

Touch screen operation, start and stop of recording and power on/off can be confirmed with this sound.

2 Beeps for 4 times

When an error occurs. Check the sentence displayed on the screen. (→ 129)

---

[POWER LCD] (→ 37)

---

[LCD AI]\*<sup>1</sup> (→ 38)

---

[LCD SET] (→ 37)

---

[COMPONENT OUT] (→ 99)

---

[HDMI RESOLUTION] (→ 98)

---

[VIERA Link] (→ 100)

---

[TV ASPECT] (→ 97)

---

## [INITIAL SET]

Set to [YES] for changing the menu settings back to the default condition.

(Settings for [CLOCK SET], [MEDIA SELECT]\*<sup>2</sup> and [LANGUAGE] will not be changed.)

---

[FORMAT CARD]\*<sup>3</sup> (→ 95)

---

[FORMAT HDD]\*<sup>4</sup> (→ 95)

---



[CALIBRATION] (→ 38)

---

---

## [DEMO MODE]

This item is used to start the unit demonstration.

(Only when the mode is at the  or , position)

### [HDC-SD200]

If [DEMO MODE] is switched [ON] when there is no SD card inserted, the demonstration automatically starts.

### [HDC-HS200]

If [DEMO MODE] is switched [ON] when there is no SD card inserted and while this unit is connected to the AC adaptor, the demonstration automatically starts.

If any operation takes place, the demonstration is cancelled. However if no operations take place for approx. 10 minutes, the demonstration automatically starts again. To stop the demonstration, set [DEMO MODE] to [OFF] or insert an SD card.

---

[LANGUAGE] (→ 30)

---

## Still picture recording mode

---

\*1 It is not displayed when the Intelligent auto mode is on.

## RECORD SETUP

---

[I.EXPOSURE]\*<sup>1</sup> (→ 61)

---

## PICTURE

---

[ASPECT RATIO] (→ 52)

---

[FLASH LEVEL] (→ 62)

---

[AF ASSIST LAMP]\*<sup>1</sup> (→ 71)

---

● For any other menus that are not described above, refer to menus with the same names for the motion picture recording mode.

## ▶ Playback mode

- \*1 When the disc playback is selected while a DVD burner (optional) is connected, or when [INTEL. SCENE] (→ 81) is selected, this does not appear.
- \*2 Only when the disc playback is selected while a DVD burner (optional) is connected, this appears.
- \*3 These menus are only for **HDC-HS200**.
- \*4 This appears only when the [VIDEO/SD CARD] or [PICTURE/SD CARD] is selected.
- \*5 **HDC-HS200** This appears only when the [VIDEO/HDD] or [PICTURE/HDD] is selected.

## ( [ ] motion picture playback)

### VIDEO SETUP

[REPEAT PLAY]	(→ 83)
[RESUME PLAY]	(→ 83)
[SCENE PROTECT] <sup>*1</sup>	(→ 90)
[GUIDE LINES]	(→ 65)

### EDIT SCENE<sup>\*1</sup>

[DIVIDE]	(→ 89)
[DELETE]	(→ 88)

### COPY<sup>\*1, \*3</sup>

 (→ 93)	(→ 93)
 (→ 93)	(→ 93)

### DISC SETUP<sup>\*2</sup>

[FORMAT DISC]	(→ 109)
[AUTO PROTECT]	(→ 109)
[DISC STATUS]	(→ 109)

### SETUP

[FORMAT CARD] <sup>*4</sup>	(→ 95)
[CARD STATUS] <sup>*4</sup>	(→ 92)
[FORMAT HDD] <sup>*5</sup>	(→ 95)
[HDD STATUS] <sup>*5</sup>	(→ 92)

- For any other menus that are not described above, refer to menus with the same names for the motion picture recording mode.

## ( [ ] still picture playback)

### PHOTO SETUP<sup>\*1</sup>

[SCENE PROTECT]	(→ 90)
[DPOF SET] <sup>*4</sup>	(→ 91)
[DELETE]	(→ 88)

- For any other menus that are not described above, refer to menus with the same names for the motion picture recording mode and motion picture playback.

# Setting date and time

When the unit is turned on for the first time, a message asking you to set the date and time will appear. Select [YES] and perform steps 2 to 3 below to set the date and time.



◇ Change the mode to  or .

## 1 Select the menu. (→ 29)

[SETUP] → [CLOCK SET] → [YES]

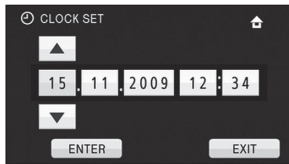
## 2 Touch the date or time to be set, then set the desired value using / .



- The year will change as follows:  
2000, 2001, ..., 2039, 2000, ...
- The 24-hour system is used to display the time.
-  appears on the right top of the screen when [SET WORLD TIME] (→ 36) is set to [HOME], while  appears when it is set to [DESTINATION].

## 3 Touch [ENTER].

- The clock function starts at [00] seconds.
- A message prompting for World time setting may be displayed. Perform the World time setting by touching the screen. (→ 36)
- Touch [EXIT] or press the MENU button to complete the setting.

### Changing the date and time display mode

Select the menu. (→ 29)

[SETUP] → [DATE/TIME] → desired display style

- You can also show or change the date and time display by repeatedly pressing the DATE/TIME button on the remote control.

[DATE]

15. 11. 2009

[D/T]

12:34  
15. 11. 2009

[OFF]

### Changing the date format

Select the menu. (→ 29)

[SETUP] → [DATE FORMAT] → desired display style

Display style	Screen display
[Y/M/D]	2009. 11. 15
[M/D/Y]	11 15 2009
[D/M/Y]	15. 11. 2009

- The date and time function is driven by a built-in lithium battery.
- If the time display becomes [- -], the built-in lithium battery needs to be charged. To recharge the built-in lithium battery, connect the AC adaptor or attach the battery to this unit. Leave the unit as it is for approx. 24 hours and the battery will maintain the date and time for approx. 6 months. (The battery is still being recharged even if the power is off.)

#### **WARNING**

THE LITHIUM BATTERY IN THIS EQUIPMENT MUST ONLY BE REPLACED BY QUALIFIED PERSONNEL. WHEN NECESSARY, CONTACT YOUR LOCAL PANASONIC SUPPLIER.

# World time setting (Displaying the time of the travel destination)

It is possible to display and record the time at the travel destination by selecting your home region and the travel destination.

## 1 Select the menu. (→ 29)

[SETUP] → [SET WORLD TIME] → [YES]

- If the clock is not set, adjust the clock to the current time. (→ 34)
- When the [HOME] (your home region) is not set, the message appears. Touch [ENTER] and proceed to Step 3.

## 2 (Only when setting your home region)

Touch [HOME].

- Touch [ENTER].

## 3 (Only when setting your home region)

Touch ◀/▶ to select your home region and touch [ENTER].

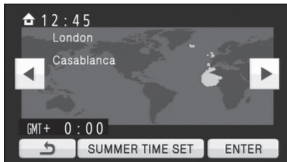

- Touch [SUMMER TIME SET] to set daylight saving time. ☀ appears and the summer time setting is turned on; the clock is set forward by one hour. Touch [SUMMER TIME SET] again to return to the normal time setting.
- The current time appears on the left top of the screen. The time difference from GMT (Greenwich Mean Time) appears on the left bottom of the screen.

## 4 (Only when setting the region of your travel destination)

Touch [DESTINATION].

- Touch [ENTER].
- When the home region is set for the first time, the screen for selecting home/travel destination appears after setting the home region successively. If the home region has already been set once, execute the menu operation for Step 1.

## 5 (Only when setting the region of your travel destination)

Touch ◀/▶ to select your travel destination and touch [ENTER].

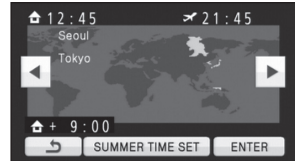

- Touch [SUMMER TIME SET] to set daylight saving time. ☀ appears and the summer time setting is turned on; the clock is set forward by one hour. Touch [SUMMER TIME SET] again to return to the normal time setting.
- The local time at the selected travel destination appears on the right top of the screen. The time difference between the travel destination and the home region appears on the left bottom of the screen.
- Close the setting by pressing the MENU button. ✈ appears and the time of the travel destination is indicated.

### To return the display to the home setting

Set the home region using Step 1 to 3, and close the setting by touching [EXIT] or pressing the MENU button.

- If you cannot find your travel destination in the area shown on the screen, set it by using the time difference from your home region.

- These settings will not affect the images actually recorded.

## LCD monitor adjustment

### ■ POWER LCD

This makes it easier to view the LCD monitor in bright places including outdoors.

Select the menu. (→ 29)

[SETUP] → [POWER LCD] → desired setting

[+2]\*:

Makes even brighter

[+1]\*:

Makes brighter

[0]\*:

Normal

[-1]\*:

Makes less bright

[A]\*:

Brightness of the LCD is automatically adjusted depending on the ambient brightness.

(It is not displayed in the manual mode or in the playback mode.)

- If you use the AC adaptor, the [A]\* indication appears and the screen becomes brighter automatically when the power is turned on.
- The recordable time will become shorter when you use this unit with the LCD monitor lit up.

### ■ Adjusting the brightness and colour level of the LCD monitor

It adjusts brightness and colour density on the LCD monitor.

#### 1 Select the menu. (→ 29)

[SETUP] → [LCD SET] → [YES]

#### 2 Touch the desired setting item.

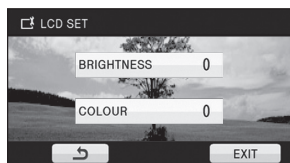

[BRIGHTNESS]:

Brightness of the LCD monitor

[COLOUR]:

Colour level of the LCD monitor

#### 3 Touch ◀/▶ to adjust settings.



- After adjustments are made if no operations are performed for about 2 seconds, the bar will disappear.

#### 4 Touch [ENTER].

- Touch [EXIT] or press the MENU button to exit the menu screen.

## Touch screen calibration

Perform the touch screen calibration if a different object to the one touched is selected.

### 1 Select the menu. (→ 29)

[SETUP] → [CALIBRATION] → [YES]

- Touch [ENTER].

### 2 Touch [+] with the supplied stylus pen and enter in calibration.



- Touch the [+] in the order it is displayed. (5 locations)

### 3 Touch [ENTER].

- Calibration cannot be performed when the LCD monitor is turned 180°.

## Changing the picture quality on the LCD monitor

- The intelligent auto mode is set to off. (→ 42)

### Select the menu. (→ 29)

[SETUP] → [LCD AI] → [DYNAMIC] or [NORMAL]

#### [DYNAMIC]:

The image on the LCD monitor becomes clear and vivid. Optimum contrast and brightness are set depending on the scenes recorded. Clear and brilliant images are presented.

#### [NORMAL]:

Switches to the standard picture quality.

- When the [POWER LCD] is set to  $\square 1^*$  or  $\square 2^*$ , it is set to [DYNAMIC], or when the [POWER LCD] is set to  $\square 1^*$  or  $\square A^*$ , it is set to [NORMAL], and the setting cannot be changed.

## Recording Yourself

- ◇ Change the mode to  or .

### Rotate the LCD monitor towards the lens side.

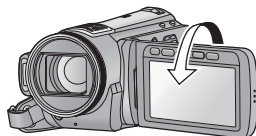

- The image is horizontally flipped as if you see a mirror image. (However the image recorded is the same as a normal recording.)
- Only some indications will appear on the screen. When  appears, return the direction of the LCD monitor to normal position and check the warning/alarm indication. (→ 129)

## 8

## Using with the remote control

## Select the menu. (→ 29)

[SETUP] → [REMOTE CONTROL] → [ON]

- This function's default setting is [ON].
- [REMOTE CONTROL] can be set to [OFF] so the remote control will not be mistakenly used when not in use.

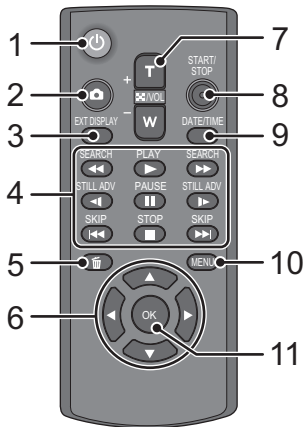

### 1 Power on/off button [⏻]

Power can be turned on/off when the mode is set to anything but OFF.

- Power cannot be turned on by the power on/off button when 36 hours have passed after the power is turned off.
- Power cannot be turned off when it is connected to the PC or the DVD burner.

### 2 Photoshot button [📷]\*

### 3 On-screen display button [EXT DISPLAY] (→ 98)

### 4 Playback operation buttons (→ 78)

These buttons function in the same manner as the corresponding playback operation icon being displayed on screen.

[Excluding skip playback (→ 78)].

### 5 Delete button [🗑️]\*

### 6 Direction buttons [▲, ▼, ◀, ▶]

### 7 Zoom/volume/thumbnaill display switch buttons [T, W, 📐/VOL]\*

### 8 Recording start/stop button [START/STOP]\*

### 9 Date/time button [DATE/TIME] (→ 34)

### 10 Menu button [MENU]\*

### 11 OK button [OK]

- \* means that these buttons function in the same manner as the corresponding buttons on the unit.

## CAUTION

Danger of explosion if battery is incorrectly replaced. Replace only with the same or equivalent type recommended by the manufacturer. Dispose of used batteries according to the manufacturer's instructions.

Remove the insulation sheet **A** before using.

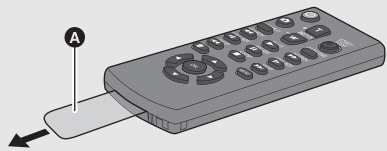

## Replace a button-type battery

- 1 While pressing the stopper **B**, pull out the battery holder.

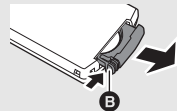

- 2 Set the button-type battery with its (+) mark facing upward and then put the battery holder back in place.

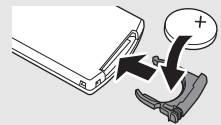

- When the button-type battery runs down, replace it with a new battery (part number: CR2025). The battery should normally last about 1 year, however this depends on how frequently the unit is used.

## Warning

Keep the Button-Type battery out of the reach of children. Never put Button-Type battery in mouth. If swallowed call your doctor.

### ■ Remote control usable range

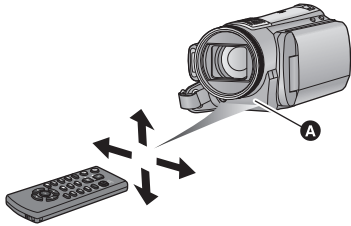

#### A Remote control sensor

Distance: Within approx. 5 m

Angle: Approx. 10° up and 15° down, left, and right

- The remote control is intended for indoor operation. Outdoors or under strong light, the unit may not operate properly even within the usable ranges.

## Operation of direction buttons/OK button

### 1 Press a direction button.

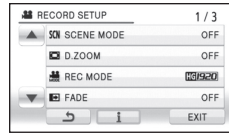

- Selected item will become yellow. If no operation is performed for approximately 5 seconds, the yellow display will disappear.

### 2 Select the item with the direction button.

### 3 Confirm the selection by pressing the OK button.

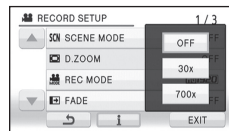

- Selection/confirmation of operation icons, thumbnail display etc. can be operated.
- Wherever you can touch with your finger can be operated by the remote control. (Excluding some functions)

# Before recording

## Basic camera positioning

- When you are outdoors, record pictures with the sunlight behind you. If the subject is backlit, it will become dark in the recording.
- When recording, make sure your footing is stable and there is no danger of colliding with another person or object.

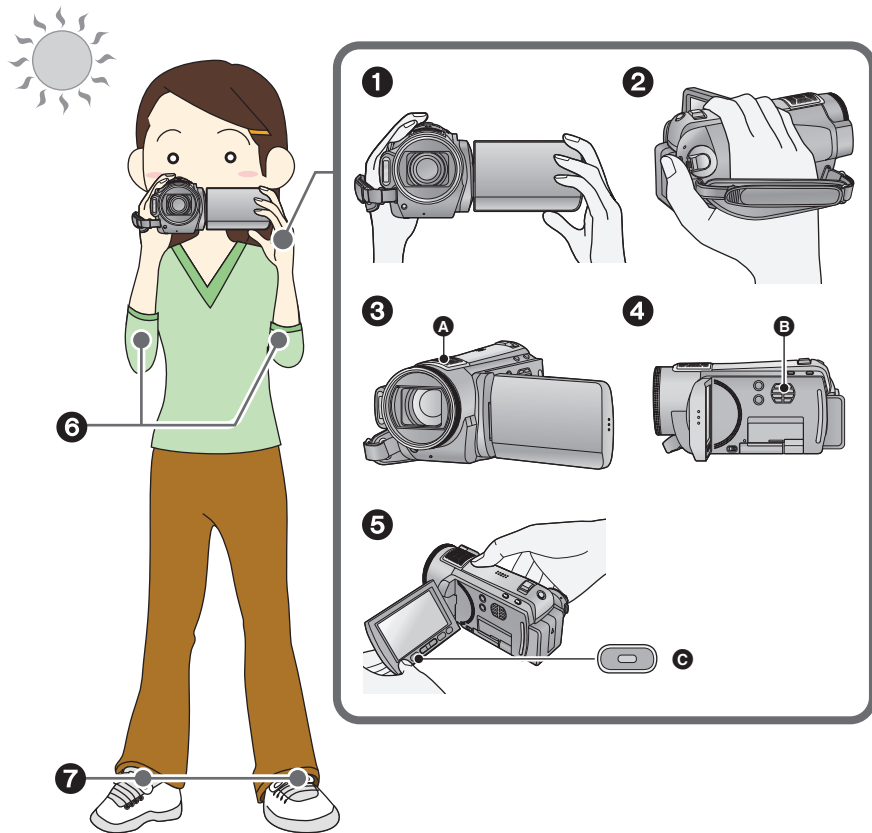

- 1 Hold the unit with both hands.
- 2 Put your hand through the grip belt.
- 3 Do not cover the microphones **A**.
- 4 Do not cover inlet **B** of the cooling fan with your hand as it will prevent heat release.
- 5 It is convenient to use sub recording start/stop button **C** when holding the unit around your waist.
- 6 Keep your arms near your body.
- 7 Separate your legs for better balance.

## Intelligent auto mode





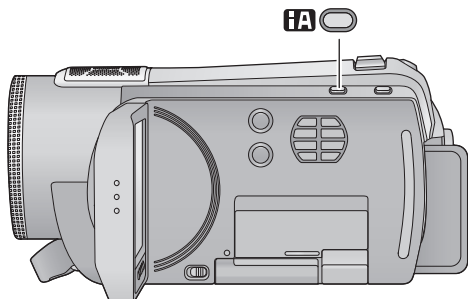



The following modes appropriate for the condition are set just by pointing the unit to what you want to record.







- When this unit is purchased, the Intelligent auto mode is set to on.



### Intelligent auto button

Press this button to switch on/off the intelligent auto mode.

Mode	Scene/Effect
 <b>Portrait</b> 	<b>When the object is a person</b> <hr/> Faces are detected and focused automatically, and the brightness is adjusted so it is recorded clearly.
 <b>Scenery</b> 	<b>Recording outdoors</b> <hr/> The whole landscape will be recorded vividly without whiting out the background sky, which may be very bright.
 <b>Spotlight*<sup>1</sup></b> 	<b>Under a spotlight</b> <hr/> Very bright object is recorded clearly.
 <b>Low light*<sup>1</sup></b> 	<b>Dark room or twilight</b> <hr/> It can record very clearly even in a dark room or twilight.

Mode	Scene/Effect
 <b>Night portrait*<sup>2</sup></b> 	<b>Recording night portrait</b> <hr/> A person and the background are recorded with near real-life brightness.
 <b>Night scenery*<sup>2</sup></b> 	<b>Recording night scenery</b> <hr/> You can record night scenery vividly by slowing the shutter speed.
 <b>Macro*<sup>2</sup></b> 	<b>Recording zooming in on a flower etc.</b> <hr/> This allows recording while going near to the object of recording.
 <b>Normal</b>	<b>Other situations</b> <hr/> Contrast is adjusted automatically for clear image.

\*1 In motion picture recording mode only

\*2 In still picture recording mode only

- Modes are selected automatically by the unit, so it may not choose desired mode depending on the recording conditions.
- Brightness may change suddenly or flicker when set to on.
- In the portrait mode, one that is bigger and close to centre of the screen will be surrounded by an orange frame. (→ 67)
- It is recommended using a tripod in night portrait and night scenery mode.
- Optical image stabilizer function (→ 58) is set to on in all modes.
- In the following case, faces may not be detected in some recording conditions.
  - Faces are not full-faces
  - Faces tilt
  - Faces are not completely exposed (for instance wearing sunglasses)
  - The size of a face is small on the screen.
  - When the digital zoom is used
- The function may not operate properly in some recording conditions, even if faces are detected.

## ■ When Intelligent auto mode is set to off:

When the Intelligent auto mode is set to off, the auto white balance and auto focus operate and automatically adjust the colour balance and focusing.

Depending on the brightness of the subject etc., the aperture and shutter speed are automatically adjusted for an optimum brightness.

- Colour balance and focus may not be adjusted automatically depending on light sources or scenes. If so, manually adjust these settings. (→ 74, 76)

## Automatic white balance

White balance adjustment recognises the colour of light and adjusts so the white colour will become a purer white. The unit determines the hue of light, thereby judging the recording condition, and selects the closest hue setting.

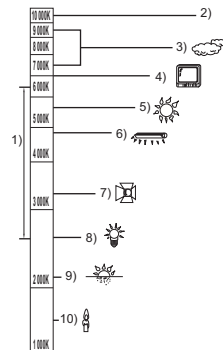

The illustration above shows the range over which the auto white balance functions.

- 1) The effective range of automatic white balance adjustment on this unit
- 2) Blue sky
- 3) Cloudy sky (rain)
- 4) TV screen
- 5) Sunlight
- 6) White fluorescent lamp
- 7) Halogen light bulb
- 8) Incandescent light bulb
- 9) Sunrise or sunset
- 10) Candlelight

Automatic white balance adjustment does not function normally when there are multiple light sources or the light source is other than the stored white balance. In such cases, use the manual white balance adjustment mode.

## Auto focus

The lens is moved forward or backward automatically to bring the subject into focus.

Auto focus has the following characteristics.

- Adjusts so that the vertical lines of a subject are seen more clearly.
- Attempts to bring an object with higher contrast into focus.

Auto focus does not work correctly in the following situations. Record pictures in the manual focus mode.

- Recording distant and close-up objects at the same time
- Recording a subject behind dirty or dusty window
- Recording a subject that is surrounded by objects with glossy surfaces or by highly reflective objects
- Recording a subject in dark surroundings
- Recording a fast-moving subject
- Recording a subject with little contrast

## Quick start

This unit will resume recording pause mode about 0.6 seconds after the LCD monitor is reopened.

- **When in quick start standby mode about 70% of the power used in recording pause mode is being consumed, so the recording time will be reduced.**

◇ Change the mode to  or .

**1** Select the menu. (→ 29)

[SETUP] → [QUICK START] → [ON]

**2** Close the LCD monitor while the mode is set to  or .

HDC-SD200

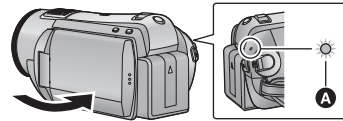

HDC-HS200



The status indicator **A** flashes green and the unit goes into quick start standby mode.

- The lens cover does not close.

### 3 Open the LCD monitor.

HDC-SD200

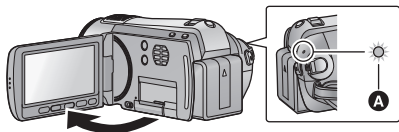

HDC-HS200

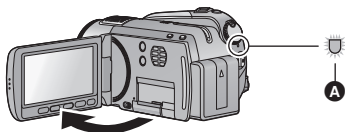

The status indicator **A** lights red and the unit is put into recording pause.

- Quick start standby mode is cancelled if
  - about 5 minutes elapsed
  - mode is set to
  - unit is turned off
- Time for quick start will be more than 0.6 seconds slower when digital cinema is used.
- Depending on the recording conditions, time for quick start may be more than 0.6 seconds slower in still picture recording mode.
- It may take some time for automatic white balance to adjust.
- In the quick start mode, the zoom magnification becomes 1×.
- If [ECONOMY] (→ 31) is set to [5 MINUTES] and the unit automatically goes into quick start standby mode, close the LCD monitor and then open it again.
- Quick start standby mode cannot be released by the remote control. Turn the mode to OFF when powering off.

## Quick power on

(Only when recording to an SD card)

The unit is put into recording pause approx. 1.9 seconds when the mode is set to or from OFF.

- Start time will not shorten if there is no SD card inserted.

◇ Change the mode to or .

1

HDC-HS200

Select SD card as a media to record from the menu. (→ 29)

[MEDIA SELECT] → [SD CARD]

## 2 Select the menu. (→ 29)

[SETUP] → [QUICK POWER ON] → [ON]

- This function's default setting is [ON].
- Depending on the recording conditions, start time may be longer than 1.9 seconds in still picture recording mode.
- In the quick power on mode, the zoom magnification becomes 1×.

## Recording motion pictures

VIDEO

This unit records high definition images that are compatible with the AVCHD format.

Sound is recorded with the Dolby Digital 5.1 Creator.

- Use an SD card that can be used for motion picture recording. (→ 24)

### ■ When selecting media

Select the menu. (→ 29)

**HDC-HS200** :

[MEDIA SELECT] → [HDD] or [SD CARD]

HDC-SD200

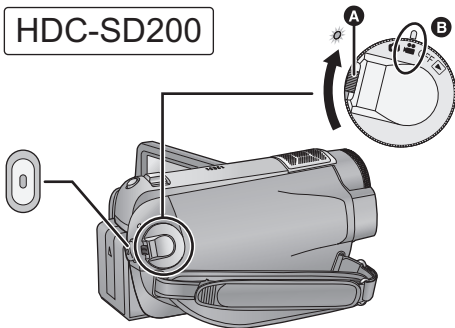

- Rotate the mode dial while at the same time pressing in the lock release button **A** if changing from OFF to another mode.
- Align with the mark **B**.

HDC-HS200

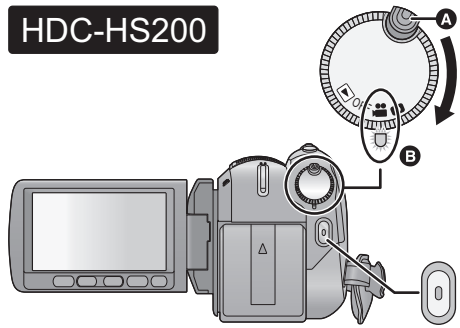

- Rotate the mode dial while at the same time pressing in the lock release button **A** if changing from OFF to another mode.
- Align with the status indicator **B**.

## 1 Change the mode to .

## 2 Open the LCD monitor.

- For users who have **HDC-SD200**, proceed to step 4.

## 3 **HDC-HS200**

### Select the media to record from the menu.

- You cannot set the recording media for motion pictures and still pictures separately.

#### 4 Press the recording start/stop button to start recording.



#### 5 Press the recording start/stop button again to pause recording.

- While recording is in progress, the recording will not stop even if the LCD monitor is closed.

### About the compatibility of the recorded motion pictures

- They are not compatible with devices other than those that support AVCHD. Images cannot be played with equipment that does not support AVCHD (ordinary DVD recorders). Confirm that your equipment supports AVCHD by referring to the operating instructions.
  - There are some cases where the recorded motion pictures cannot be played back, even if the device supports AVCHD. In such cases, play the recorded motion picture with this unit instead.
- 
- **Still pictures can be recorded while recording the motion picture. (→ 53)**
  - The images recorded between pressing the recording start/stop button to start recording and pressing it again to pause recording become one scene.
  - Maximum number of recordable scenes: 3900  
Maximum number of different dates: 200 (→ 81)  
When either of them reaches to the maximum limit, more scenes cannot be recorded.  
(In the case of SD cards it is the maximum number of recordable scenes per card.)
  - A continuous recording of motion picture data that exceeds 4 GB may momentarily stop at every 4 GB of data when played back with another device.

### ■ Screen indications in the recording mode



- A Recording mode**
- B Remaining time left for recording**  
(When the remaining time is less than 1 minute, [R 0h00m] flashes red.)
- C Recording time elapsed**  
Each time the unit is put into recording pause, the counter display will be reset to "0h00m00s".

## Recording modes/approximate recordable time

Switch the picture quality of the motion pictures to be recorded.

Select the menu. (→ 29)

[RECORD SETUP] → [REC MODE] → desired setting

		HA*1	HG*2	HX*3	HE*4
SD card	1 GB	7 min	9 min	14 min	21 min
	2 GB	15 min	20 min	30 min	45 min
	4 GB	30 min	40 min	1 h	1 h 30 min
	6 GB	45 min	1 h	1 h 30 min	2 h 15 min
	8 GB	1 h	1 h 20 min	2 h	3 h
	12 GB	1 h 30 min	2 h	3 h	4 h 30 min
	16 GB	2 h	2 h 40 min	4 h	6 h
32 GB	4 h	5 h 20 min	8 h	12 h	
HDC-HS200 HDD	80 GB	10 h 30 min	13 h 30 min	20 h 30 min	33 h 20 min

**A** Image quality prioritized

**B** Recording time prioritized

\*1 1920×1080: Motion pictures can be recorded with the highest picture quality.\*

\*2 1920×1080: Motion pictures can be recorded with high picture quality.

\*3 1920×1080: Motion pictures can be recorded with normal picture quality.

\*4 1440×1080: Motion pictures can be recorded for a longer time.

\* This means the highest quality for this unit.

● **The recording is in high definition picture quality in all recording modes.**

● Maximum continuously recordable time for one scene: 12 hours

● The recording is paused once when the recording time for one scene exceeds 12 hours, and the recording will automatically resume after a few seconds.

● If a recording with a lot movements is recorded, the recording time is reduced.

● The recordable time may be reduced if recording of short scene is repeated.

● Use time in the row of 4 GB in above table as a guideline for the time that can be copied onto one DVD disc (4.7 GB).

● **Recordable time using the battery (→ 21)**

● Mosaic-pattern noise may appear on a playback image in the following cases.

– When there is a complicated pattern in the background

– When the unit is moved too fast

– When a subject with sharp movements has been recorded  
(Particularly if it has been recorded in HE mode.)

### ■ Back up data periodically.

The HDD is temporary storage. In order to avoid erasing data due to static electricity, electromagnetic waves, breakage, and failures, back up the data to a PC or DVD disc. (→ 103, 114)

## PRE-REC

This prevents you missing a shot.

This allows recording of the pictures and sound to start approximately 3 seconds before the recording start/stop button is pressed.

### 1 Press the PRE-REC button.

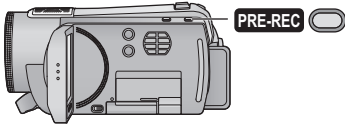

PRE-REC appears on the screen.

- Aim this unit at the subject and position it securely.

### 2 Press the recording start/stop button to start recording.

- There is no beep sound.
- After recording starts, the PRE-REC setting is cancelled.
- PRE-REC is cancelled in the following cases.
  - If you change the mode.
  - If you open the SD card cover.  
**HDC-HS200**  
(If you open the SD card cover when the [MEDIA SELECT] is set to [SD CARD] in recording mode.)
  - If you press the MENU button.
  - If you turn the unit off.
- When the remaining time left for recording motion pictures is less than 1 minute, PRE-REC cannot be set.
- If you start recording less than 3 seconds after pressing the PRE-REC button, or while the PRE-REC indication flashes within about 3 seconds after initiating the quick start operation, motion pictures for 3 seconds cannot be recorded.
- When the recording start/stop button is pressed, image shake and operation sound may be recorded.
- Images displayed on the thumbnail in playback mode will differ from the motion pictures displayed at the start of playback.

## Shooting guide

Message is displayed when this unit is moved rapidly.

Select the menu. (→ 29)

[RECORD SETUP] → [SHOOTING GUIDE]  
→ [ON]

- This function's default setting is [ON].



When "CAMERA PANNING IS TOO FAST." appears, move the unit slowly while recording.

- Set to [OFF] to turn off the message indication.
- Message will not appear while pausing the recording. (Message will appear even if it is pausing the recording if [DEMO MODE] is set to [ON])
- In some recording conditions, messages may not appear.

## Recording still pictures

PHOTO

## HDC-SD200

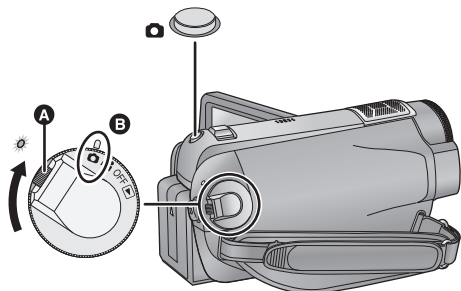

- Rotate the mode dial while at the same time pressing in the lock release button **A** if changing from OFF to another mode.
- Align with the mark **B**.

1 Change the mode to .

## 2 Open the LCD monitor.

- For users who have **HDC-SD200**, proceed to step 4.

3 **HDC-HS200**

## Select the media to record from the menu. (→ 46)

- You cannot set the recording media for motion pictures and still pictures separately.

## HDC-HS200

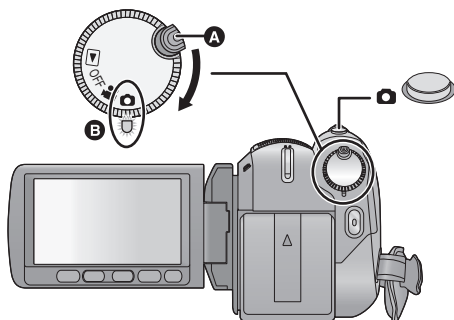



- Rotate the mode dial while at the same time pressing in the lock release button **A** if changing from OFF to another mode.
- Align with the status indicator **B**.

4 Press the  button halfway. (For auto focus only)

Focus indication and focus area appear and the unit focuses on the subject automatically.



- If you set the optical image stabilizer function (→ 58) to  (MODE1), then the image stabilizer function will be more effective. (**MEGA**  (MEGA optical image stabilizer) will be displayed.)
- The AF assist lamp lights in dark places.

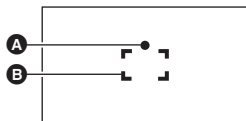

## Focus indication:



- **A** Focus indication
  - (The white lamp flashes.):  
Focusing
  - (The green lamp lights up.):  
When in focus
- No mark:  
When focusing is unsuccessful.
- **B** Focus area (area inside brackets)







## 5 Press the button fully.



- The sound cannot be recorded while recording still pictures.
- If the  button is pressed fully all at once, it may take time to record still pictures.
- It is recommended using a flash or tripod when recording still pictures in dark places because the shutter speed becomes slow.
- The screen will become darker when the  button is pressed halfway if the shutter speed is 1/25 or slower.

## ■ About the screen indications in still picture recording



- : Still picture operation indicator (→ 127)
- : Flash (→ 62)
- : Flash level (→ 62)
- : Red eye reduction (→ 62)
- : MEGA optical image stabilizer (→ 58)
- : Quality of still pictures (→ 52)
- : Size of still pictures

R3000: Remaining number of still pictures (Flashes in red when [0] appears.)

AF\*: AF assist lamp (→ 71)

## ■ About the focus indication

- The focus indication indicates the status of the auto focus.
- The focus indication does not appear in manual focus mode.
- The focus indication does not appear or has difficulty focusing in the following cases.
  - When the zoom magnification is high.
  - When the unit is shaken.
  - When the subject is moving.
  - When the subject stands in front of a light source.
  - When close subjects and far subjects are included in the same scene.
  - When the scene is dark.
  - When there is a bright part in the scene.
  - When the scene is filled with only horizontal lines.
  - When the scene lacks contrast.

## ■ About the focusing area

When there is a contrasting object ahead or behind the subject in the focus area, the subject may not be focused. If so, move the contrasting object out of the focus area.

- Focus area is not displayed in the following conditions.
  - When the intelligent auto (portrait mode) is used.
  - When the digital zoom (more than approx. 12×) is used.
  - When AF tracking is used.
  - When the Extra optical zoom is used.
  - When the unit determines that the AF assist lamp is necessary.

## Aspect ratio/picture size

This allows you to select the aspect ratio of the pictures to suit printing or the playback method. The higher the number of pixels, the higher the clarity of the picture when printing.

(When setting aspect ratio)

**Select the menu. (→ 29)**

[PICTURE] → [ASPECT RATIO] → desired setting

(When setting picture size)

**Select the menu. (→ 29)**

[PICTURE] → [PICTURE SIZE] → desired setting

### Picture size and Maximum zoom ratio

Aspect ratio	Picture size	Extra optical zoom	
4:3	9M	3520×2640	—*
	8M	3264×2448	12.9×
	5M	2560×1920	16.5×
	0.3M	640×480	20×
3:2	10.6M	3984×2656	—*
	7M	3264×2176	14.6×
	4.5M	2592×1728	18.4×
16:9	10M	4224×2376	—*
	6M	3328×1872	15.2×
	3.5M	2560×1440	19.8×

\* Extra optical zoom cannot be used. The maximum zoom magnification is 12×

- Refer to page 57 for Extra optical zoom.

- When the aspect ratio is set to [4:3] or [3:2], black bands may appear on the left and right of the screen.
- The edges of still pictures recorded on this unit with a 16:9 aspect ratio may be cut at printing. Check the printer or photo studio before printing.



- The number of recording pixels that can be set changes depending on selected screen aspect ratio.
- The recording will become longer depending on the recording pixels.

## Picture quality

Selecting the picture quality.

**Select the menu. (→ 29)**

[PICTURE] → [QUALITY] → desired setting

-  : Still pictures with a high picture quality are recorded.
-  : Priority is given to the number of still pictures recorded. Still pictures are recorded in normal picture quality.

- If the [QUALITY] is set to , mosaic-pattern noise may appear on a playback image depending on the picture content.

## Recording still pictures in motion picture recording mode

You can record still pictures even in motion picture recording mode.

◇ Change the mode to .

**1** While pausing the recording, press the  button halfway. (For auto focus only)

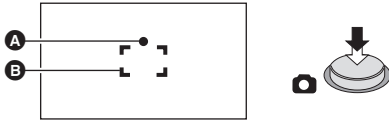

**A** Focus indication

**B** Focus area (area inside brackets)



Focus indication and focus area appear and the unit focuses on the subject automatically.

**2** Press the  button fully.

■ **Picture size in motion picture recording mode**

Select the menu. (→ 29)

[PICTURE] → [PICTURE SIZE] → desired setting

Aspect ratio	Picture size	
16:9		3840×2160
		1920×1080

■ **Simultaneous recording (recording still pictures while recording motion pictures)**

You can record still pictures even while recording motion pictures.

◇ Change the mode to .



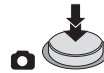





**While recording motion pictures, press the  button fully (press to the bottom) to take the picture.**



- While recording motion pictures or during the PRE-REC operation, the following arrangements are applied so that motion picture recording takes preference over still picture recording.
  - Image quality is different from ordinary still pictures.
  - Pressing the  button halfway is disabled.
  - The remaining usable capacity (number of pictures that can be taken) indication does not appear.

## Number of recordable pictures

(In still picture recording mode)

Aspect ratio		4:3							
Picture size		9M 3520×2640		8M 3264×2448		5M 2560×1920		0.3M 640×480	
Picture quality									
SD card	8 MB	0	0	0	1	1	2	33	52
	16 MB	1	3	2	3	3	6	77	120
	32 MB	3	6	4	7	7	13	145	220
	64 MB	9	15	11	18	19	31	330	510
	128 MB	20	32	23	38	39	62	650	1010
	256 MB	44	70	51	81	84	135	1380	2150
	512 MB	89	140	105	165	170	270	2760	4300
	1 GB	180	290	210	330	340	540	5550	8660
	2 GB	370	590	430	680	700	1110	11320	17650
	4 GB	730	1150	850	1340	1390	2180	22250	34710
	6 GB	1110	1750	1300	2040	2110	3310	33850	52800
	8 GB	1490	2350	1740	2730	2820	4440	45310	70690
	12 GB	2250	3540	2620	4120	4260	6690	68370	106650
16 GB	3010	4720	3500	5490	5680	8930	91200	142280	
32 GB	6030	9480	7010	11020	11400	17920	182990	285460	
HDC-HS200 HDD	80 GB	16340	25680	19010	29870	30900	48550	495770	773400

Aspect ratio		3:2					
Picture size		10.6M 3984×2656		7M 3264×2176		4.5M 2592×1728	
Picture quality							
SD card	8 MB	0	0	0	1	1	2
	16 MB	1	2	2	4	4	7
	32 MB	3	5	5	8	8	14
	64 MB	8	13	13	21	21	34
	128 MB	17	28	26	42	43	68
	256 MB	38	61	58	92	93	145
	512 MB	78	125	115	185	185	300
	1 GB	160	250	240	380	380	600
	2 GB	330	510	490	770	770	1210
	4 GB	640	1010	960	1510	1520	2390
	6 GB	980	1540	1460	2290	2310	3640
	8 GB	1310	2060	1950	3070	3100	4870
	12 GB	1980	3110	2950	4630	4670	7340
16 GB	2640	4150	3930	6180	6240	9800	
32 GB	5300	8320	7890	12400	12510	19660	
HDC-HS200 HDD	80 GB	14350	22550	21380	33600	33910	53260

Aspect ratio		16:9					
Picture size		10M 4224×2376		6M 3328×1872		3.5M 2560×1440	
Picture quality							
SD card	8 MB	0	0	0	1	1	3
	16 MB	1	2	2	5	5	9
	32 MB	3	5	6	10	10	17
	64 MB	8	14	15	24	26	41
	128 MB	18	30	30	49	52	83
	256 MB	41	65	66	105	115	180
	512 MB	83	130	135	210	230	360
	1 GB	170	270	270	430	460	720
	2 GB	340	540	560	870	940	1480
	4 GB	680	1070	1090	1720	1850	2900
	6 GB	1030	1620	1660	2610	2810	4420
	8 GB	1380	2170	2230	3500	3770	5910
	12 GB	2090	3280	3360	5280	5680	8920
16 GB	2780	4370	4480	7050	7580	11910	
32 GB	5580	8780	9000	14140	15210	23890	
HDC-HS200 HDD	80 GB	15130	23780	24370	38300	41200	64720

(In motion picture recording mode)

Aspect ratio		16:9			
Picture size		8.3M 3840×2160		2.1M 1920×1080	
Picture quality					
SD card	8 MB	0	0	4	6
	16 MB	1	3	10	17
	32 MB	4	7	20	32
	64 MB	11	17	47	74
	128 MB	22	36	94	150
	256 MB	49	78	200	320
	512 MB	100	160	410	640
	1 GB	200	320	820	1290
	2 GB	420	660	1670	2630
	4 GB	820	1290	3290	5160
	6 GB	1250	1960	5000	7860
	8 GB	1670	2630	6690	10520
	12 GB	2520	3970	10100	15870
16 GB	3370	5290	13470	21170	
32 GB	6760	10620	27030	42480	
<b>HDC-HS200 HDD</b>	<b>80 GB</b>	18310	28770	73240	115090

- The numbers shown in the table are approximations.
- The number of recordable pictures depends on whether and are used together and on the subject being recorded.
- Maximum number of recordable pictures that can be displayed is 99999.  
If the number of recordable pictures exceeds 99999, the number will not change when the picture is taken until the number of recordable pictures gets less than 99999.
- The memory capacity indicated on the label of an SD card is the total of the capacity for copyright protection and management and the capacity which can be used on the unit, a PC etc.

# Zoom in/out function

The maximum optical zoom ratio is 12×.

◇ Change the mode to  or .

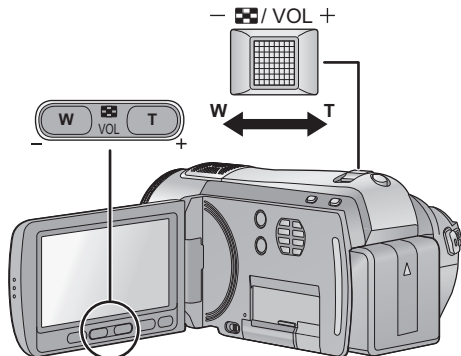

## Zoom lever/Zoom buttons

### T side:

Close-up recording (zoom in)

### W side:

Wide-angle recording (zoom out)

- The zoom speed varies depending on the range over which the zoom lever is moved.

## Digital zoom function

**VIDEO** **PHOTO**

If the zoom magnification exceeds 12× in motion picture recording mode, then the digital zoom function will be activated.

Select the menu. (→ 29)

[RECORD SETUP] → [D.ZOOM] → desired setting

- [OFF]: Optical zoom only (Up to 12×)
- [30×]: Up to 30×
- [700×]: Up to 700×

- The larger the digital zoom magnification, the more the image quality is degraded.

## Extra optical zoom

**PHOTO**

If the number of the recording pixels is set to anything other than the maximum number of recording pixels in still picture recording mode, the still image can be recorded with a zoom ratio of a maximum of 20× without degrading the picture quality.

- Extra optical zoom ratio varies depending on the setting of [ASPECT RATIO] and [PICTURE SIZE]. (→ 52)

### ■ Extra optical zoom mechanism

When you set the picture size to 4.5M, the maximum 10.6M area is cropped to the centre 4.5M area, allowing a picture with a higher zoom effect.

- If you take your finger off the zoom lever during zoom operation, the operation sound may be recorded. When returning the zoom lever to the original position, move it quietly.
- When the zoom magnification is 12×, the subjects are focused at about 1.2 m or more.
- When the zoom magnification is 1×, this unit can focus on a subject approx. 4 cm away from the lens.
- The zoom speed does not vary when operating with the zoom button and the remote control.

# Optical image stabilizer function

VIDEO PHOTO

Optical image stabilizer can stabilize the image without decreasing the image quality as much.

◇ Change the mode to  or .

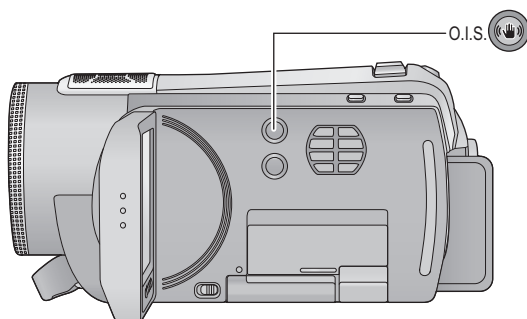

## Optical image stabilizer button

Press this button to switch on/off the image stabilizer function.

In motion picture recording mode,  appears on the screen, and the image stabilizer function works all the time.

In still picture recording mode, each time the button is pressed, the indication changes by one setting in the following order:

 →  → OFF

 (MODE1):

The function works all the time.

 (MODE2):

The function works when the  button is pressed.

**O.I.S.:** Optical Image Stabilizer

- This function's default setting is on.
- Set the intelligent auto mode to off before turning the optical image stabilizer function to off.
- In the following cases, the image stabilizer function may not work effectively.
  - When the unit is shaken greatly
  - When you record a moving subject while tracking it
- When recording yourself in still picture recording mode or using a tripod, we recommend setting this function to  (MODE2).

VIDEO PHOTO

It is possible to set the focus and exposure to the subject specified on the touch screen. The focus and exposure will keep following the subject automatically even if it moves. (Dynamic tracking)



◇ Change the mode to  or .

## ■ About target frame

### 1 Touch .





#### A Target frame

-  will be displayed on the screen.
- The prioritized face framing (orange) will change to the target frame when the Intelligent auto mode is  (Portrait), and it will track the face that was framed.
- Available target lock range will be displayed in red frame when the Intelligent auto mode is set to anything but  (Portrait).

### 2 Touch the object and lock the target.



- When you touch the head of the object, the target frame on the head gets locked and tracking starts.
- Touch the object to be changed again when you want to change the target.
- When the Intelligent auto mode is selected, the setting becomes  (Normal) and touched object is tracked. Selection becomes  (Portrait) when target frame is locked on head.

### 3 Start recording.

- When you touch [CANCEL], the tracking function will be cancelled.



- The frame out assist **B** is displayed when the target frame gets close to framing out.
- When target lock fails, the target frame blinks in red and then disappears. In such cases, touch the object again and lock the target.
- When the  button is pressed halfway, the focus is set to the object that is locked. The target frame turns green when it focuses, and the target cannot be changed.

- This function cannot be used in manual mode.
- This function cannot be used when the scene mode is set to the fireworks mode in still picture recording mode.
- It may track different objects or may not lock the target depending on the recording conditions such as the following:
  - When the object is too large or too small
  - When colour of the object is similar to the background
  - When using zoom
  - When the camera is shaking
  - When more than one object overlaps
  - When the scene is dark
  - When the subject moves quickly
- When the target is locked in still picture recording mode, the screen may become dark or the AF assist lamp may turn on.
- A message will be displayed when an object becomes unable to be tracked half-way through. In such cases, touch the object one more time.
- AF tracking will be cancelled in the following cases.
  - When the mode is changed
  - When the power is turned off
  - When the scene mode is set
  - When the Intelligent auto mode is set on/off
- After setting [DISPLAY] to [OFF] if no operation is performed for about 3 seconds, the operation icon disappears. Touch the screen to display the icon again. When the AF tracking is used, the icon does not disappear.



# Recording functions of operation icons

Select the operation icons to add different effects to the images to be recorded.

◇ Change the mode to  or .

1 Touch  to display the operation icons on the screen.





















- Touch  at the bottom right of the screen to change the page and touch / to display/not-display the operation icon.

2 (e.g. Backlight compensation)  
Select an operation icon.







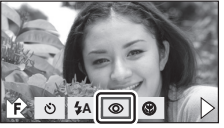

































- Select the operation icon again to cancel the function.
- Refer to the respective pages for cancelling the following functions.
  - Self timer (→ 62)
  - Built-in flash (→ 62)

## Operation icons

 Backlight compensation	 Intelligent contrast control*1, 2	 Intelligent exposure*2, 3	 Fade*1
			
 Soft skin mode*2	 Tele macro	 Colour night view*1, 2	 Self-timer*3
			
 Built-in flash*3	 Red eye reduction*2, 3		
			

- \*1 It is not displayed in still picture recording mode.
- \*2 It is not displayed when the intelligent auto mode is on.
- \*3 It is not displayed in motion picture recording mode.
- If you turn off the power or change the mode to  , colour night view, backlight compensation, self timer and tele macro functions are cancelled.
- If you turn off the power, the fade function is cancelled.
- It is possible to set from the menu. (→ 30)
- After setting [DISPLAY] to [OFF] if no operation is performed for about 3 seconds, the operation icon disappears. Touch the screen to display the icon again.

Function	Effect
 <b>Backlight compensation</b> <div style="text-align: right;"> <span>VIDEO</span> <span>PHOTO</span> </div>	<p>This makes the image brighter to prevent darkening of a backlit subject.</p>
 <b>Intelligent contrast control</b> <div style="text-align: right;"> <span>VIDEO</span> </div>	<p>This brightens parts that are in shadow and difficult to see and suppresses white saturation in bright parts at the same time. Both bright and dark parts can be recorded clearly.</p>
 <b>Intelligent exposure</b> <div style="text-align: right;"> <span>PHOTO</span> </div>	<p>This brightens dark parts so it can be recorded clearly.</p>
 <b>Fade</b> <div style="text-align: right;"> <span>VIDEO</span> </div> <p>(Fade in)</p>  <p>(Fade out)</p> 	<p>When you start recording, the image/audio gradually appears. (Fade in)  When you pause recording, the image/audio gradually disappears. (Fade out)</p> <ul style="list-style-type: none"> <li>● The fade setting is cancelled when the recording stops.</li> </ul> <p>■ To select the colour for fade in/out  Select the menu. (→ 29)  [RECORD SETUP] → [FADE COLOUR] → [WHITE] or [BLACK]</p>
 <b>Soft skin mode</b> <div style="text-align: right;"> <span>VIDEO</span> <span>PHOTO</span> </div>	<p>This makes skin colours appear softer for a more attractive appearance.  This is more effective if you record a person closely from the torso up.</p>
 <b>Tele macro</b> <div style="text-align: right;"> <span>VIDEO</span> <span>PHOTO</span> </div>	<p>More impressive image can be obtained by focusing on the object only in closeup and shading off the background.</p> <ul style="list-style-type: none"> <li>● The unit can focus on the subject at a distance of approx. 60 cm.</li> <li>● If the magnification is 12× or less, then it is automatically set to 12×.</li> </ul>
 <b>Colour night view</b> <div style="text-align: right;"> <span>VIDEO</span> <span>PHOTO</span> </div>	<p>This function allows you to record colour images in very low light situations. (Minimum required illumination: approx. 1 lx)</p>

Function	Effect
<p> <b>Self-timer</b></p> <p><b>PHOTO</b></p>	<p><b>This is for recording still pictures using the timer.</b></p> <hr/> <p>Each time the  icon is selected, the indication changes by one setting in the following order:  10 → 2 → setting cancelled  10: Records after 10 seconds  2: Records after 2 seconds</p> <ul style="list-style-type: none"> <li>• In motion picture recording mode, set this function from the menu.</li> <li>• When the  button is pressed, a still picture is recorded after the 10 or 2 display and the recording lamp flashes for the time which has been set.</li> <li>• After recording, the self-timer is cancelled.</li> <li>• In auto focus mode, if the  button is pressed halfway once and then fully, the lens focuses on the subject when the button is pressed halfway.</li> <li>• If the  button is pressed fully all at once, the lens focuses on the subject just before recording.</li> </ul> <hr/> <p><b>To stop the timer midway through</b>  Press the MENU button.</p>
<p> <b>Built-in flash</b></p> <p><b>PHOTO</b></p>	<p><b>When the  button is pressed, the flash is activated and the picture will be recorded. Use the built-in flash in order to record still pictures in dark places.</b></p> <hr/> <p>Each time the  icon is selected, the indication changes by one setting in the following order:   → A → </p> <p>: ON  A: AUTO  : OFF</p> <ul style="list-style-type: none"> <li>• In motion picture recording mode, set this function from the menu.</li> <li>• This function's default setting is A.</li> <li>• When the  button is pressed halfway, the flash indicator will appear.</li> <li>• The unit automatically determines if the flash is necessary even when it has been set to  by detecting the ambient brightness. (If it determines that the flash is necessary, the  indication lights up in red when the  button is pressed halfway.)</li> </ul> <p>■ <b>To adjust the brightness of the flash</b></p> <ul style="list-style-type: none"> <li>• <b>The intelligent auto mode is set to off in motion picture recording mode. (→ 42)</b>  <b>Select the menu. (→ 29)</b>  <b>[PICTURE] → [FLASH LEVEL] → desired setting</b>  -]: Less brighter  ±0]: Normal  +]: Much brighter</li> </ul>
<p> <b>Red eye reduction</b></p> <p><b>PHOTO</b></p>	<p><b>Reduces the phenomena where human eyes become red from flashes.</b></p> <ul style="list-style-type: none"> <li>• In motion picture recording mode, set this function from the menu.</li> </ul>

### **Intelligent contrast control:**

- If there are extremely dark or bright parts or the brightness is insufficient, the effect may not be clear.

### **Intelligent exposure:**

- If there are extremely dark parts or the brightness is insufficient, the effect may not be clear.

### **Fade:**

- The thumbnails of scenes recorded using fade in become black (or white).

### **Soft skin mode:**

- If the background or anything else in the scene has colours similar to the skin colour, they will also be smoothed.
- If the brightness is insufficient, the effect may not be clear.
- If you record a person in the distance, the face may not be recorded clearly. In this case, cancel soft skin mode or zoom in on the face (close-up) to record.

### **Tele macro:**

- The tele macro function is cancelled when the zoom magnification becomes lower than 12×.



### **Colour night view:**

- **Recorded scene is seen as if frames were missed.**
- If set in a bright place, the screen may become washed out for a while.
- Bright dots that are usually invisible may be seen, but this is not a malfunction.
- Using a tripod is recommended.
- In darker areas, auto focus may focus a bit slower. This is normal.

### **Self-timer:**

- The self-timer standby mode is cancelled when you press the recording start/stop button to start motion picture recording.
- Setting the self-timer to 2 is a good way to prevent image shake when the  button is pressed while using a tripod etc.













### **Built-in flash:**





- Set the flash to  where using a flash is prohibited.
- Do not use the flash with the ND filter (optional) attached.
- If the  indication etc. flashes when the  button is pressed halfway, the flash is not activated.
- The available range of the flash is approx. 1 m to 2.5 m in dark places.
- Using the flash fixes a shutter speed to 1/500 or slower.
- A conversion lens (optional) can block the flash and may cause a vignetting effect.



### **Red eye reduction:**





- The flash is activated 2 times.
- Red eye phenomenon may appear depending on the recording conditions.
- When faces are detected in the Intelligent auto mode, the red eye reduction is set to on.



# Recording functions of menus



Function	Effect/Setting method
<b>Scene mode</b> <div style="border: 1px solid black; display: inline-block; padding: 2px;">VIDEO</div> <div style="border: 1px solid black; display: inline-block; padding: 2px; margin-left: 10px;">PHOTO</div>	<p>When you record images in different situations, this mode automatically sets optimum shutter speeds and apertures.</p> <hr/> <ul style="list-style-type: none"> <li>• Change the mode to  or .</li> </ul> <p><b>Select the menu. (→ 29)</b></p> <p>[RECORD SETUP] → [SCENE MODE] → desired setting</p> <hr/> <p> <b>Sports:</b> To make fast moving scenes less shaky with slow playback and pause of playback</p> <p> <b>Portrait:</b> To make people stand out against the background</p> <p> <b>Spotlight:</b> Improved quality when subject is brightly illuminated.</p> <p> <b>Snow:</b> Improved image quality when shooting on snowy locations.</p> <p> <b>Beach:</b> To make blue in the sea or sky vibrant</p> <p> <b>Sunset:</b> To make red in the sunrise or sunset vibrant</p> <p> <b>Fireworks:</b> To capture the fireworks in the night sky beautifully</p> <p> <b>Scenery:</b> For spatial scenery</p> <p> <b>Low light:</b> For dark scenes, such as at dusk (In motion picture recording mode only)</p> <p> <b>Night scenery:</b> To capture the evening or night scenery beautifully. (In still picture recording mode only)</p> <p> <b>Night portrait:</b> To capture a person and the background brightly. (In still picture recording mode only)</p> <ul style="list-style-type: none"> <li>• Set [SCENE MODE] to [OFF] to cancel the function.</li> </ul>







Function	Effect/Setting method
<p><b>Guide line</b></p> <p>VIDEO PHOTO</p> 	<p>You can check if the image is level while recording or playing back motion pictures and still pictures. The function can also be used to estimate the balance of the composition.</p> <hr/> <ul style="list-style-type: none"> <li>● Change the mode to  or .</li> <li>● The Intelligent auto mode is set to off. (→ 42)</li> </ul> <p><b>Select the menu. (→ 29)</b>  <b>[RECORD SETUP] → [GUIDE LINES] → desired setting</b></p> <p>(When motion picture playback is selected while the mode is set to  . (→ 77))</p> <p><b>[VIDEO SETUP] → [GUIDE LINES] → desired setting</b></p> <ul style="list-style-type: none"> <li>● The guide lines do not appear on the images actually recorded.</li> <li>● Set to [OFF] to cancel the guide line.</li> </ul>
<p><b>Digital cinema</b></p> <p>VIDEO</p>	<p>Use this function to record an image with vivid colour, like an image on a movie film.</p> <hr/> <ul style="list-style-type: none"> <li>● Change the mode to .</li> <li>● The intelligent auto mode is set to off. (→ 42)</li> <li>● Set the recording mode to HA or HG. (→ 48)</li> </ul> <p><b>Select the menu. (→ 29)</b>  <b>[RECORD SETUP] → [DIGITAL CINEMA] → [ON]</b></p> <ul style="list-style-type: none"> <li>● When [DIGITAL CINEMA] is [ON], smooth viewing of the motion pictures may not be possible.</li> <li>● The picture will be recorded as 50i (→ 99) irrespective of the digital cinema mode setting.</li> </ul>

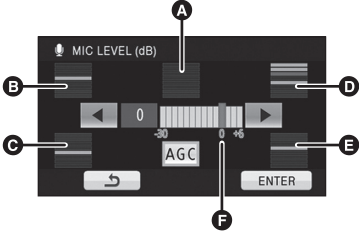
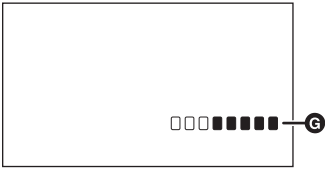

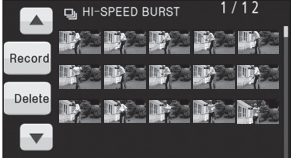
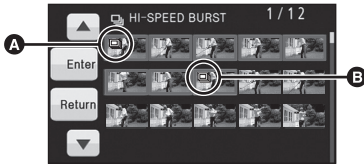

Function	Effect/Setting method
<p><b>Anti-Ground-Shooting (AGS)</b></p> <p>VIDEO</p> 	<p>If the unit continues to be tilted upside down from the normal horizontal position while recording motion pictures, it is automatically put into recording pause.</p> <hr/> <ul style="list-style-type: none"> <li>• Change the mode to  .</li> </ul> <p><b>Select the menu. (→ 29)</b>  [RECORD SETUP] → [AGS] → [ON]</p>
<p><b>Auto slow shutter</b></p> <p>VIDEO PHOTO</p>	<p>You can record bright pictures even in dark places by slowing the shutter speed.</p> <hr/> <ul style="list-style-type: none"> <li>• Change the mode to  .</li> <li>• The intelligent auto mode is set to off. (→ 42)</li> </ul> <p><b>Select the menu. (→ 29)</b>  [RECORD SETUP] → [AUTO SLOW SHTR] → [ON]</p> <ul style="list-style-type: none"> <li>• The shutter speed is set to 1/25 or more depending on the surrounding brightness.</li> </ul>

Function	Effect/Setting method
<p><b>Automatic face framing</b></p> <p style="text-align: right;">VIDEO PHOTO</p> <p><b>[OFF]:</b> Not display</p> <p><b>[PRIMARY]:</b> Only the prioritized face framing is displayed.</p> <p><b>[ALL]:</b> All face detection framings are displayed.</p> 	<p>In the intelligent auto mode, detected faces appear with frames.</p> <hr/> <ul style="list-style-type: none"> <li>• Change the mode to  or .</li> </ul> <p><b>Select the menu. (→ 29)</b></p> <p><b>[RECORD SETUP] → [FACE FRAMING] → desired setting</b></p> <ul style="list-style-type: none"> <li>• This function's default setting is [ALL].</li> <li>• Up to 15 frames are indicated. Larger faces and faces nearer to the centre of the screen take preference over others.</li> </ul> <p>■ <b>Prioritized face framing</b></p> <p>Prioritized face framing is displayed in orange. Focus and adjustment of brightness will be performed against the prioritized face framing.</p> <ul style="list-style-type: none"> <li>• Focus will be set to prioritized face framing when the  button is pressed halfway when recording still pictures. Prioritized face framing will turn to green when the focus is set.</li> </ul>
<p><b>Digital cinema colour</b></p> <p style="text-align: right;">VIDEO</p>	<p>Recording motion pictures with more vivid colours, using x.v.Colour™ technology.</p> <hr/> <ul style="list-style-type: none"> <li>• Change the mode to .</li> <li>• The intelligent auto mode is set to off. (→ 42)</li> </ul> <p><b>Select the menu. (→ 29)</b></p> <p><b>[RECORD SETUP] → [Digital Cinema Colour] → [ON]</b></p> <ul style="list-style-type: none"> <li>• For more realistic colours, use an HDMI mini cable with a TV that supports the x.v.Colour™.</li> <li>• When connecting this unit to a TV with the component cable or A/V cable, the TV cannot detect the digital cinema colour setting on this unit automatically. We recommend connecting this unit to TVs compatible with x.v.Colour™ using an HDMI mini cable.</li> <li>• When viewing on the TV with the digital cinema colour function, turn off the digital cinema colour function on the TV.</li> </ul>

Function	Effect/Setting method
<p><b>Wind noise reduction</b></p> <p style="text-align: right;"><b>VIDEO</b></p>	<p>This is for reducing the wind noise coming into the built-in microphones depending on the wind strength.</p> <hr/> <ul style="list-style-type: none"> <li>● Change the mode to .</li> <li>● The intelligent auto mode is set to off. (→ 42)</li> </ul> <p><b>Select the menu. (→ 29)</b></p> <p>[RECORD SETUP] → [WIND CUT] → [ON]</p> <ul style="list-style-type: none"> <li>● This function's default setting is [ON].</li> </ul>
<p><b>Microphone setup</b></p> <p style="text-align: right;"><b>VIDEO</b></p> <p><b>[SURROUND]:</b> Sound is recorded with 5.1 ch surround microphone.</p> <p><b>[ZOOM MIC]:</b> Directivity of the microphone is interlocked with the zoom operation. Sounds near the front of the unit are recorded more clearly if you zoom in (close-up) and surrounding sounds are recorded more realistically if you zoom out (wide angle).</p> <p><b>[FOCUS MIC]:</b> Directivity of the centre is enhanced for recording audio near the front of the unit more clearly.</p>	<p>Directivity (sound sensitivity direction) of the built-in microphones can be adjusted.</p> <hr/> <ul style="list-style-type: none"> <li>● Change the mode to .</li> <li>● The intelligent auto mode is set to off. (→ 42)</li> </ul> <p><b>Select the menu. (→ 29)</b></p> <p>[RECORD SETUP] → [MIC SETUP] → desired setting</p> <ul style="list-style-type: none"> <li>● This function's default setting is [SURROUND].</li> </ul>



Function	Effect/Setting method
<p><b>Microphone level</b></p> <p style="text-align: right;"><b>VIDEO</b></p> <p><b>[AUTO]:</b> AGC is activated, and the recording level is adjusted automatically.</p> <p><b>[SET+ <b>AGC</b>]/[SET]:</b> The desired recording level can be set.</p> <p><b>AGC: Auto Gain Control</b></p>	<p>When recording, the input level from the built-in microphones can be adjusted.</p> <hr/> <ul style="list-style-type: none"> <li>• Change the mode to .</li> <li>• The intelligent auto mode is set to off. (→ 42)</li> </ul> <p><b>1 Select the menu. (→ 29)</b> [RECORD SETUP] → [MIC LEVEL] → [SET+ <b>AGC</b>]/[SET]</p> <p><b>2 Touch  /  to adjust the microphone input level.</b></p> <div style="text-align: center;">  </div> <ul style="list-style-type: none"> <li><b>A</b> Centre</li> <li><b>B</b> Front left</li> <li><b>C</b> Back left</li> <li><b>D</b> Front right</li> <li><b>E</b> Back right</li> <li><b>F</b> Microphone input level</li> </ul> <ul style="list-style-type: none"> <li>• Touch <b>AGC</b> to activate/disactivate AGC. When AGC is activated, the icon is surrounded by yellow and the amount of sound distortion can be reduced. When AGC is deactivated, natural recording can be performed.</li> <li>• A gain value for each of the 5 direction is displayed. (The input level of the microphones cannot be set individually.)</li> <li>• Adjust the microphone input level so that the last 2 bars of the gain value are not red. (Otherwise, the sound is distorted.) Select a lower setting for microphone input level.</li> </ul> <p><b>3 Touch [ENTER] to determine the microphone input level and then touch [EXIT].</b></p> <div style="text-align: center;">  </div> <ul style="list-style-type: none"> <li><b>G</b> Microphone input level meter</li> </ul>

Function	Effect/Setting method
<p><b>Hi-speed burst shooting</b></p> <p style="text-align: right;"><b>PHOTO</b></p> <p><b>[25 Frames/sec]:</b> 72 still pictures are recorded continuously at the rate of 25 per second. The picture size is <b>2.1M</b> (1920×1080).</p> <p><b>[50 Frames/sec]:</b> 180 still pictures are recorded continuously at the rate of 50 per second. The picture size is <b>0.9M</b> (1280×720).</p>	<p>Recording is done continuously at the rate of 25 or 50 still pictures per second. Use this function to record an object with fast movement. It is recorded in Motion picture recording mode, since still pictures are generated from motion picture.</p> <hr/> <ul style="list-style-type: none"> <li>● Change the mode to .</li> <li>● The intelligent auto mode is set to off. (→ 42)</li> </ul> <p><b>1 Select the menu. (→ 29)</b> [PICTURE] → [HI-SPEED BURST] → desired setting</p> <p><b>2 Press the  button.</b></p> <ul style="list-style-type: none"> <li>●  flashes in red during recording.</li> <li>● First press the  button halfway, then press it fully to set the focus and record. It will automatically focus if you press fully once, so it is convenient when recording objects moving back and forth.</li> </ul> <p><b>3 Touch [Record] or [Delete].</b></p>  <p>[Record]: Pictures are stored. [Delete]: All pictures are deleted.</p> <p><b>4 (Only when [Record] is selected in step 3)</b> <b>Touch [REC ALL] or [SELECT].</b></p> <p>[REC ALL]: All pictures are stored. [SELECT]: Pictures are stored by specifying range.</p> <p><b>5 (Only when [SELECT] is selected in step 4)</b> <b>Touch the range of pictures that will be stored.</b></p>  <ul style="list-style-type: none"> <li><b>A</b> Start point*</li> <li><b>B</b> Finish point</li> <li>● Previous (Next) page is displayed by touching  / .</li> </ul> <p>* Only select the picture for start point if only 1 picture is to be stored.</p> <p>A confirmation message is displayed when [ENTER] is touched after selecting the start point and finish point. Touch [YES] to store the pictures.</p> <ul style="list-style-type: none"> <li>● Set [HI-SPEED BURST] to [OFF] to cancel the function.</li> </ul>

Function	Effect/Setting method
<b>AF assist lamp</b> 	Illuminating the subject makes it easier for the camera to focus when recording in low light conditions that make focusing difficult. <hr/> <ul style="list-style-type: none"> <li>● Change the mode to  .</li> <li>● The intelligent auto mode is set to off. (→ 42)</li> </ul> <b>Select the menu. (→ 29)</b> [PICTURE] → [AF ASSIST LAMP] → [AUTO] <ul style="list-style-type: none"> <li>● This function's default setting is [AUTO].</li> <li>● The available distance of the AF assist lamp is approx. 1.5 m.</li> </ul>
<b>Shutter sound</b> 	You can add a shutter sound when recording still pictures. <hr/> <ul style="list-style-type: none"> <li>● Change the mode to  or  .</li> </ul> <b>Select the menu. (→ 29)</b> [PICTURE] → [SHTR SOUND] → [ON] <ul style="list-style-type: none"> <li>● This function's default setting is [ON].</li> </ul>

### Scene mode:

#### Sports

- During normal playback, the image movement may not look smooth.
- Colour and screen brightness may change under indoor lighting.
- If the brightness is insufficient, the sports mode does not function. The  /  /  display flashes.
- The shutter speed is 1/6 or more in still picture recording mode.

#### Portrait

- Colour and screen brightness may change under indoor lighting.
- The shutter speed is 1/6 or more in still picture recording mode.

#### Spotlight

- The shutter speed is 1/6 or more in still picture recording mode.

#### Snow

- The shutter speed is 1/6 or more in still picture recording mode.

#### Beach

- The shutter speed is 1/6 or more in still picture recording mode.

#### Sunset

- The shutter speed is 1/25 or more.
- Image may get blurry when close object is recorded.
- The shutter speed is 1/6 or more in still picture recording mode.

#### Fireworks

- The shutter speed is 1/25.
- Image may get blurry when close object is recorded.
- Image may get washed out when recorded in bright surrounding.

#### Scenery

- Image may get blurry when close object is recorded.
- The shutter speed is 1/6 or more in still picture recording mode.

#### Low light

- The shutter speed is 1/25 or more.

#### Night scenery

- The shutter speed is 1/2 or more.
- Image may get blurry when close object is recorded.
- It is recommended using a tripod.

#### Night portrait

- The shutter speed is 1/2 or more.
- The flash is set to [ON].
- It is recommended using a tripod.

**Anti-Ground-Shooting (AGS):**

- The AGS function may activate and cause the unit to pause the recording if you are recording a subject right above or right below you.

**Auto slow shutter:**

- When the shutter speed becomes 1/25, the screen may be seen as if frames are missed and afterimages may appear.

**Digital cinema colour:**

- **When motion pictures recorded while this function is turned [ON] are played back with a TV not compatible with x.v.Colour™, colours may not be reproduced properly.**
- To play back images recorded in the digital cinema colour with vivid colours of wider colour ranges, a device compatible with x.v.Colour™ is required. When these images are played back with devices other than ones compatible with x.v.Colour™, it is recommended to record the images after this function is turned [OFF].
- x.v.Colour™ is a name for devices that are compatible with the xvYCC format, an international standard for expanded colour in motion pictures, and that follow the rules for signal transmission.

**Wind noise reduction:**

- When the Intelligent auto mode is set to on, [WIND CUT] is set to [ON], and the setting cannot be changed.
- The sound quality may be changed if this function is activated in strong winds.

**Microphone setup:**

- If you wish to record higher quality sound and maintain realism even when zooming in, for instance recording a music recital, we recommend setting [MIC SETUP] to [SURROUND].

**Microphone level:**

- When the Intelligent auto mode is on, the setting is fixed to [AUTO] and cannot be changed.
- When [MIC SETUP] is [ZOOM MIC], the volume will be different depending on the zoom rate.
- The microphone input level meter shows the largest volume for the microphones.
- You cannot record with the audio completely muted.

**Hi-speed burst shooting:**

- If you turn off the power or change the mode to , this function is cancelled.
- The maximum number of times you can record on a media: 15.  
(In the case of SD cards it is the maximum number of recordable scenes per card.)
- Colour balance and brightness on the screen may change with some light sources such as fluorescent lamps.
- Image quality is different from ordinary still picture recording.

**AF assist lamp:**

- A conversion lens (optional) can block the AF assist lamp, and it will become harder to adjust the focus.
- When the Intelligent auto mode is on, the setting is fixed to [AUTO] and cannot be changed.
- Set to [OFF] when you would not like the AF assist lamp to illuminate in dark environment, such as when you are recording animals in dark. It will become harder to adjust the focus.

# Manual recording

Touch the operation icon to adjust white balance, shutter speed, iris and manual focus.

◇ Change the mode to  or .



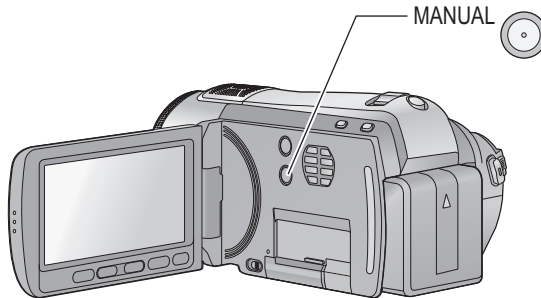

Press the **MANUAL** button.

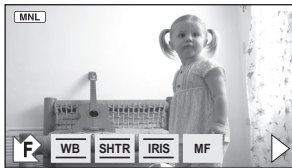

- **MNL** appears on the screen.



Perform the setting by touching the desired item to be set.



-  White balance (→ 74)
-  Manual shutter speed (→ 75)
-  Aperture adjustment (→ 75)
-  Manual focus (→ 76)

- Touch  to change the page and touch  to display/not-display the operation icon.

# White balance

VIDEO PHOTO

The automatic white balance function may not reproduce natural colours depending on the scenes or lighting conditions. If so, you can adjust the white balance manually. The unit can record pictures in a natural hue if it can recognise the reference colour white.

- Press the **MANUAL** button. (→ 73)

## 1 Touch [WB].

## 2 Touch ▲/▼ to select white balance mode.

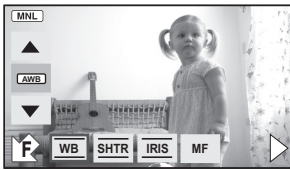

- Select the optimal mode by confirming the colour on the screen.

Icon	Mode/Recording conditions
	<b>Auto white balance adjustment</b>
	<b>Sunny mode</b> Outdoors under a clear sky
	<b>Cloudy mode</b> Outdoors under cloudy sky
	<b>Indoor mode 1</b> Incandescent light, video lights like in the studio, etc.
	<b>Indoor mode 2</b> Colour fluorescent lamps, sodium lamps in gymnasiums etc.
	<b>Manual adjustment mode</b> <ul style="list-style-type: none"> <li>● Mercury-vapor lamps, sodium lamps, some fluorescent lights</li> <li>● Lights used for wedding receptions at hotels, stage spotlights in theaters</li> <li>● Sunrise, sunset, etc.</li> </ul>

- Set the white balance mode to **AWB** or press the **MANUAL** button again to restore to the automatic adjustment.

## ■ To set the white balance manually

- 1 Select , fill the screen with a white subject.

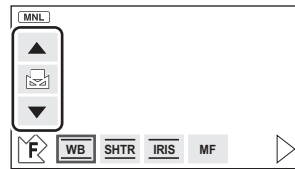

- 2 Touch and set the blinking .

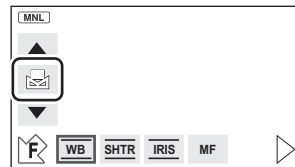

- When the screen turns black instantly and the display stops flashing and then lights constantly, the setting is complete.
- If the display continues flashing, the white balance cannot be set. In this case, use other white balance modes.

- When the display flashes, the manual white balance previously adjusted is stored. Whenever recording conditions change, re-set the white balance.
- When setting both the white balance and the iris/gain, set the white balance first.
- **AWB** is not displayed on the screen when **AWB** is being set.

## Shutter Speed:

Adjust it when recording fast-moving subjects.

## Iris:

Adjust it when the screen is too bright or too dark.

- Press the **MANUAL** button. (→ 73)

### 1 Touch [SHTR] or [IRIS].

### 2 Touch / to adjust settings.



#### **SHTR** : Shutter speed:

##### 1/50 to 1/8000

- If [AUTO SLOW SHTR] is set to [ON], the shutter speed will be set between 1/25 and 1/8000.
- The shutter speed closer to 1/8000 is faster.
- The shutter speed will be set between 1/2 and 1/2000 in still picture recording mode.

#### **IRIS** : Iris/Gain value:

##### CLOSE → (F16 to F2.0) → OPEN → (0dB to 18dB)

- Value closer to [CLOSE] darken the image.
- Value closer to [18dB] brighten the image.
- When the iris value is adjusted to brighter than [OPEN], it changes to the gain value.
- Press the **MANUAL** button again to restore to the automatic adjustment.

- When setting both the shutter speed and the iris/gain value, set the shutter speed and then set the iris/gain value.

## Manual shutter speed adjustment

- When the shutter speed is set lower than 1/12 in the still picture recording mode, it is recommended using a tripod. Also, white balance cannot be set. The shutter speed will be set to 1/25 when the power is turned on again or when the quick start is performed.
- If you increase the shutter speed manually, the noise on the screen may increase.
- You may see a band of light around the object that is shining very bright, or having very high reflection.
- During normal playback, image movement may not look smooth.
- If you record an extremely bright object or record under indoor lighting, colour and screen brightness may change or a horizontal line may appear on the screen. In this case, record in auto mode or set the shutter speed to 1/100 in areas where the power supply frequency is 50 Hz, or 1/125 in areas of 60 Hz.

## Manual iris/gain adjustment

- If the gain value is increased, the noise on the screen increases.
- Depending on the zoom magnification, there are iris values that are not displayed.

## Manual focus adjustment

VIDEO PHOTO

If auto focusing is difficult due to the conditions, then use manual focus.

- Press the **MANUAL** button. (→ 73)

**1** (When MF assist function is used)  
Select the menu. (→ 29)

[RECORD SETUP] → [MF ASSIST] → [ON]

- This function's default setting is [ON].

### 2 Touch [MF] icon.



- In manual focus mode, [AF] icon appears on the screen.

### 3 Adjust the focus by touching MF / + / - .



The centre of the screen is enlarged. The normal screen returns approximately 2 seconds after you finish bringing the subject into focus.

- The centre of the screen is not enlarged when [MF ASSIST] is [OFF].
- To return to auto focus, touch [AF] icon or press the **MANUAL** button again.
- MF assist does not work when the digital zoom is used.
- The part of the screen that is enlarged is not enlarged on the image actually recorded.

## Picture adjustment

VIDEO PHOTO

Adjust the quality of the image while recording. Adjust by outputting to a TV while adjusting the quality of the image.

- Press the **MANUAL** button. (→ 73)

**1** Select the menu. (→ 29)

[RECORD SETUP] → [PICTURE ADJUST]  
→ [YES]

### 2 Touch the desired setting items.

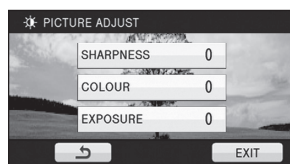

**[SHARPNESS]:**

Sharpness of the edge

**[COLOUR]:**

Depth of the colour of the image

**[EXPOSURE]:**

Brightness of the image

### 3 Touch ◀/▶ to adjust settings.



- After adjustments are made if no operations are performed for about 2 seconds, the bar will disappear.

### 4 Touch [ENTER].

- Touch [EXIT] or press the MENU button to complete the settings. ✱ appears on the screen.

# Motion picture playback

## HDC-SD200

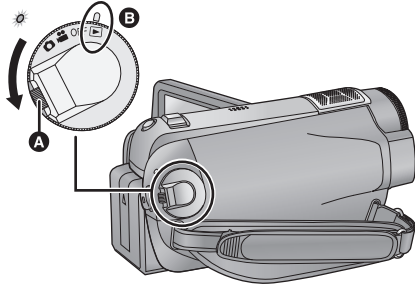

- Rotate the mode dial while at the same time pressing in the lock release button **A** if changing from OFF to another mode.
- Align with the mark **B**.

**1** Change the mode to .

**2** Touch the play mode select icon **C** to select desired media to be played back.



- Touch [VIDEO/SD CARD] to play back the SD card.

### HDC-HS200

Touch [VIDEO/HDD] to play back the HDD.

## VIDEO

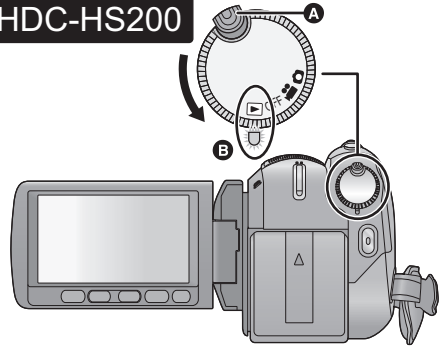

## HDC-HS200



- Rotate the mode dial while at the same time pressing in the lock release button **A** if changing from OFF to another mode.
- Align with the status indicator **B**.

**3** Touch the scene to be played back.



- Next (previous) page can be displayed by touching  / .

## 4 Select the playback operation by touching the operation icon.



- ▶/||: Playback/Pause
- ◀◀: Rewind playback
- ▶▶: Fast forward playback
- : Stops the playback and shows the thumbnails.
- ▶: Displays the direct playback bar (→ 79)
- Operation icon disappears if no playback operation is performed for about 3 seconds. It will be displayed again if you touch the screen.

### Change the thumbnail display

During step 3, the thumbnail display changes in the following order if the zoom lever is operated to + side or - side.

20 scenes ↔ 9 scenes ↔ 1 scene ↔ Highlight&Time frame index

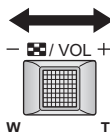

- Refer to page 80 for information about Highlight&Time frame index.
- 9 scenes display returns if the power is turned off or the mode is changed.
- It is possible to operate with the zoom button.

### Speaker volume adjustment

Move the volume lever to adjust the speaker volume during playback.

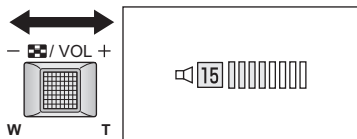

**Towards “+”:**  
Increases the volume

**Towards “-”:**  
Decreases the volume

- It is possible to operate with the zoom button.

### Fast forward/rewind playback

Touch ▶▶ during playback to fast forward.  
(Touch ◀◀ to rewind.)



- The fast forward/rewind speed increases if you touch ▶▶/◀◀ again. (The display on the screen changes from ▶▶ to ▶▶▶.)
- Normal playback is restored when you touch ▶/||.

### Skip playback (to the start of a scene)

(Operation is possible with the remote control only.)

Press the ◀◀ or ▶▶ button during playback.



### Slow-motion playback

- 1 **Pause the playback.**
  - When the operation icon disappears, touch the screen to display the icon again.
- 2 **Continue touching ||▶.**  
(◀|| is for slow rewind playback)  
**Playback is slow while touching.**



- Normal playback is restored when you touch ▶/||.
- When slow-motion pictures are played back in reverse, they will be shown continuously at approximately 2/3<sup>rd</sup> the speed of normal playback (intervals of 0.5 seconds).

## ■ Frame-by-frame playback

The motion picture is advanced one frame at a time.

### 1 Pause the playback.

- When the operation icon disappears, touch the screen to display the icon again.

### 2 Touch .

(Touch  to advance the frames one at a time in the reverse direction.)



- Normal playback is restored when you touch .
- When the frames are advanced one at a time in the reverse direction, they will be shown in intervals of 0.5 seconds.

## ■ Direct playback

1) Touch  to display the direct playback bar.



2) Touch the direct playback bar .



- The playback is paused and the image is skipped until the position you touched.
- Playback starts again when you release the touch screen.
- Touch  to display the operation icon.
- If no operations are performed for about 3 seconds, the bar will disappear. Touch the screen again to display the bar.
- Direct playback bar cannot be operated with the remote control.

## Motion picture compatibility

- This unit is based on the AVCHD format.
- The video signal that can be played back on this unit is 1920×1080/50i or 1440×1080/50i.
- This unit may degrade or not play back motion pictures recorded or created on other products, and other products may degrade or not play back motion pictures recorded on this unit, even if the products support AVCHD.

- Sound will be heard only during normal playback.
- If pause play is continued for 5 minutes, the screen returns to the thumbnails.
- Any scenes where the thumbnails are displayed as  cannot be played back.
- During motion picture playback, the power will not turn off even if the LCD monitor is closed.
- The elapsed time for playback indication will be reset to "0h00m00s" each scene.

## Creating still picture from motion picture

A single frame from the recorded motion picture can be saved as a still picture.

Picture size of the still picture to be recorded is **2.1M** (1920×1080).

### 1 Pause at the scene you want to save as a still picture during playback.

- It is convenient to use slow-motion playback and frame-by-frame playback.

### 2 Press the button fully.

Still picture is recorded.

( **HDC-HS200** )

Still picture is recorded and will be saved on the same media as the motion picture.)

- Date the motion picture was recorded will be registered as date of the still picture.
- Quality will be different from the normal still picture.



## Highlight&Time frame index

An image of one scene is displayed as a thumbnail at set time interval. Scene can be played back from any midway point of the scene you wish to see.

- Move the zoom lever to + side and change over the thumbnail display to **Highlight&Time frame index**. (→ 78)

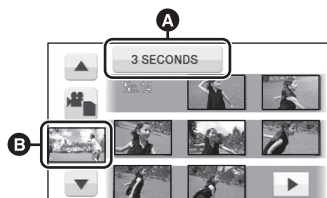
### 1 Touch the set time selection.



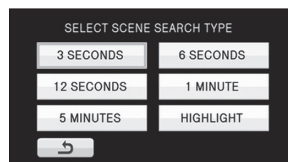

- **A** Set time selection
- **B** Scene selection
- Next (previous) scene can be displayed by touching  / .

### 2 Touch and select time to be set.



- A portion judged to be clearly recorded will be detected and displayed in thumbnail if you select [HIGHLIGHT]. The thumbnail may not be displayed if the part recognised as clearly recorded cannot be detected.

### 3 Touch the thumbnail to be played back.

- Next (previous) thumbnail can be displayed by touching  / .

## Playing back motion pictures by date

Scenes recorded on the same day can be played back in succession.

### 1 Touch the date select icon.

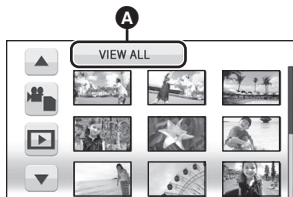

**A** Date select icon

### 2 Touch the playback date.

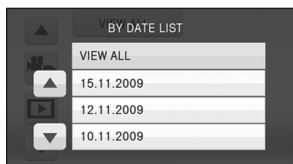

The scenes recorded on the date selected are displayed as thumbnails.

### 3 Touch the scene to be played back.

- Playing back of all the scenes returns if the power is turned off or the mode is changed.
- Even if scenes are recorded on the same day, they are grouped separately in the following cases.

- When the number of scenes exceeds 99
- When the media is repaired
- When the recording mode is changed from HA/HG/HX to HE\* or HE to HA/HG/HX\*

\* -1, -2... is added after the recording date displayed on the screen.

## Intelligent scene selection

Play back the scenes excluding a portion of the scene judged to have failed to shoot due to fast movement of this unit, camera shake, or focus error.

### 1 Touch .



### 2 Touch [INTEL. SCENE].

### 3 Touch the scene to be played back.

- Up to 9 sections can be skipped for a single scene.
- When motion pictures are skipped, the image stops momentarily.
- The position of sections to be skipped may vary depending on the type of recording, with some having no skipped parts.
- Divided scene will not be skipped.
- Playing back all the scenes returns if the power is turned off or the mode is changed.
- For data that are edited with the editing function of HD Writer AE 1.0, the intelligent scene selection is disabled.
- Deletion of scenes cannot be done during the intelligent scene selection.
- Highlight&Time frame index display does not appear.

## Highlight playback

Part that was recognised as clearly recorded is extracted from a long recording, and it can be played back in short time with music added.

### 1 Touch .



### 2 Touch [HIGHLIGHT].

### 3 Touch desired item.

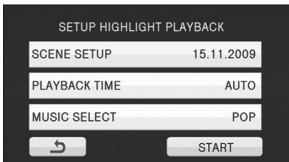

#### [SCENE SETUP]:

Select the scene or date to be played back.

#### [PLAYBACK TIME]:

Select the time to play back. (→ 83)

#### [MUSIC SELECT]:

Select the music to be played on playback.

(→ 83)

### 4 Touch [START].

- The playback time is displayed, and the unit is put into playback pause.

### 5 Select the playback operation. (→ 77)



- When the playback is finished or stopped, the screen to select [REPLAY], [SELECT AGAIN] or [EXIT] is displayed. Touch the desired item.

## ■ Scene setting

- 1) Touch [SELECT SCENES] or [SELECT DATE].



- 2) (When [SELECT SCENES] is selected)  
Touch the scene to be played back.

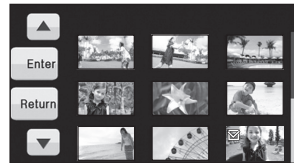

- Up to 99 scenes can be selected in succession.
- When touched, the scene is selected and [✓] is displayed. Touch the scene again to cancel the operation.

(When [SELECT DATE] is selected)

Touch the date to be played back.



- A maximum of 7 days can be selected.
  - When touched, the date is selected and surrounded by red. Touch the date again to cancel the operation.
- 3) Touch [Enter]/[ENTER] to complete the settings.

## ■ Playback time setting

- 1) Touch the playback time to set.

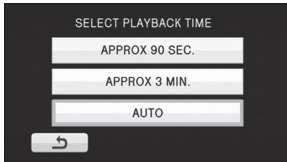

- The playback time of [AUTO] is a maximum of approx. 5 minutes.
- Playback time may become shorter than the setting, or it may not even play back if the part recognised as clearly recorded is short.

## ■ Music setting

- 1) Touch your favorite music.

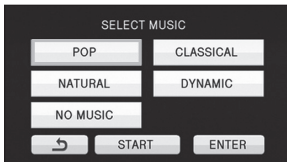

- When [NO MUSIC] is selected, the audio recorded at the time of shooting is played back.
- 2) Touch [ENTER].

### **To test the music audio:**

Touch [START] and start the audio testing.

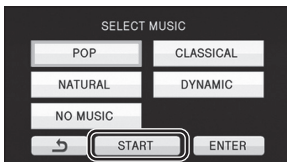

- Touch the other music option to change the music to be tested.
- When you touch [STOP], the music playback stops.
- When you touch [ENTER], the music being tested is set.

- 
- The scene in the vicinity of the split may not play back when the scene is split.
  - Playing back of all the scenes returns if the power is turned off or the mode is changed.

## Repeat playback

Playback of the first scene starts after playback of the last scene finishes.

### **Select the menu. (→ 29)**

[VIDEO SETUP] → [REPEAT PLAY] → [ON]

The  indication appears on the full screen views.

- All the scenes are played back repeatedly. (When playing back motion pictures by date, all the scenes on the selected date are played back repeatedly.)

## Resuming the previous playback

If playback of a scene was stopped halfway, the playback can be resumed from where it was stopped.

### **Select the menu. (→ 29)**

[VIDEO SETUP] → [RESUME PLAY] → [ON]

If playback of a motion picture is stopped,  appears on the thumbnail view of the stopped scene.

- This function's default setting is [ON].

- 
- The memorised resume position is cleared if you turn off the power or change the mode. (The setting of [RESUME PLAY] does not change.)

## Still picture playback

## HDC-SD200

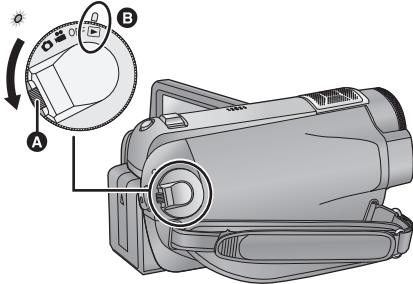

- Rotate the mode dial while at the same time pressing in the lock release button **A** if changing from OFF to another mode.
- Align with the mark **B**.

**1** Change the mode to .

**2** Touch the play mode select icon  to select desired media to be played back.



- Touch [PICTURE/SD CARD] to play back the SD card.
- **HDC-HS200**  
Touch [PICTURE/HDD] to play back the HDD.

PHOTO

## HDC-HS200

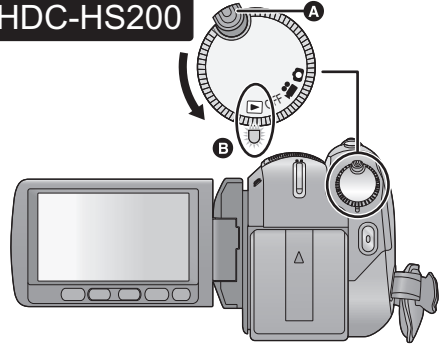



- Rotate the mode dial while at the same time pressing in the lock release button **A** if changing from OFF to another mode.
- Align with the status indicator **B**.

**3** Touch the still picture to be played back.



The selected still picture is played back on the full screen, and the operation icon is automatically displayed on the screen.

- Next (previous) page can be displayed by touching  / .

#### 4 Select the playback operation by touching the operation icon.



- ▶/||: Slide show (playback of the still pictures in numerical order) start/pause.
- ◀||: Plays back the previous picture.
- ||▶: Plays back the next picture.
- : Stops the playback and shows the thumbnails.
- Operation icon disappears if no playback operation is performed for about 3 seconds. It will be displayed again if you touch the screen.

#### Change the thumbnail display

During step 3, the thumbnail display changes in the following order if the zoom lever is operated to + side or - side.

20 still pictures ↔ 9 still pictures ↔ 1 still picture



- 9 still pictures display returns if the power is turned off or the mode is changed.
- It is possible to operate with the zoom button.

#### Changing the playback settings for the slide show

- 1) Touch .



- 2) Touch the interval of playback for the slide show.



**[SHORT]:**

Approx. 1 sec

**[NORMAL]:**

Approx. 5 sec

**[LONG]:**

Approx. 15 sec

- 3) Touch the desired sound.

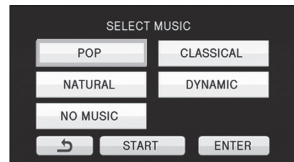

- During slide show or audio testing, the speaker volume can be adjusted by the volume lever. (→ 78)

(To test the music audio)

Touch [START] and start the audio testing.

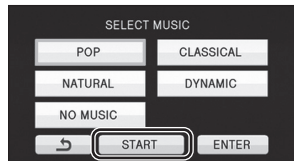

- Touch the other music option to change the music to be tested.
  - When you touch [STOP], the music playback stops.
- 4) Touch [ENTER].

## Still picture compatibility

- This unit is compliant with the unified standard DCF (Design rule for Camera File system) established by JEITA (Japan Electronics and Information Technology Industries Association).
- The file format of still pictures supported by this unit is JPEG. (Not all JPEG formatted files will be played back.)
- This unit may degrade or not play back still pictures recorded or created on other products and other products may degrade or not play back still pictures recorded on this unit.

- Any still pictures where the thumbnails are displayed as  cannot be played back.
- During still picture playback, the power will not turn off even if the LCD monitor is closed.

## Playing back still pictures by date

Still pictures recorded on the same day can be played back in succession.

### 1 Touch the date select icon.

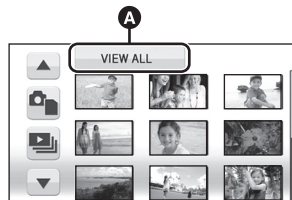

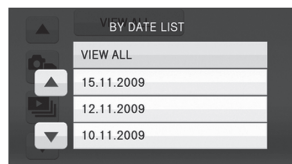

- A** Date select icon

### 2 Touch the playback date.



The still pictures recorded on the date selected are displayed as thumbnails.

### 3 Touch the still picture to be played back.

- Playing back of all the still pictures returns if the power is turned off or the mode is changed.
- Even if still pictures are recorded on the same day, they are grouped separately in the following cases.
  - When the number of still pictures exceeds 999
  - When pictures are recorded in hi-speed burst shooting mode ( is indicated after the date in the list by date).
-  is displayed after the date in the list by date for the still pictures created from the motion picture. (→ 80)

# Deleting scenes/still pictures

VIDEO PHOTO

Deleted scenes/still pictures cannot be restored, so perform appropriate confirmation of the contents before proceeding with deletion.

- ◇ Change the mode to  .

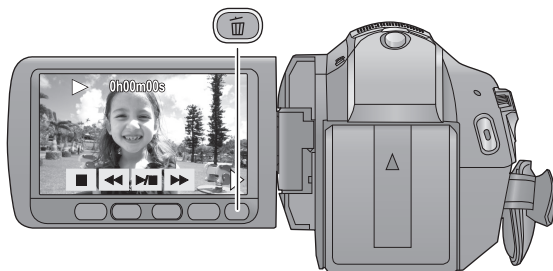

## To delete by confirming images being played back

Press the  button while scenes or still pictures to be deleted are being played back.

- When the confirmation message appears, touch [YES].

## ■ Deleting multiple scenes/still pictures from the thumbnail display

- 1** Press the  button while the thumbnail view screen is displayed.

- 2** Touch [SELECT] or [ALL SCENES].

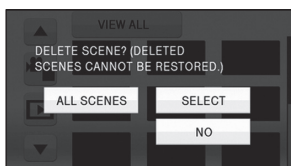

- When [ALL SCENES] is selected, all the scenes or still pictures on the selected media will be deleted. When the confirmation message appears, touch [YES]. (In case of playing back scenes or still pictures by date, all the scenes or still pictures on the selected date will be deleted.)
- Protected scenes/still pictures cannot be deleted.

- 3** (Only when [SELECT] is selected in step 2)  
**Touch the scene/still picture to be deleted.**

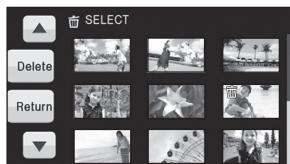

- When touched, the scene/still picture is selected and the  indication appears on the thumbnails. Touch the scene/still picture again to cancel the operation.
- Up to 99 scenes can be selected to be deleted.

- 4** (Only when [SELECT] is selected in step 2)  
**Touch [Delete] or press the  button.**

- When the confirmation message appears, touch [YES].

---

(Only when [SELECT] is selected in step 2)

**To continue deleting other scenes**

Repeat steps 3-4.

**When you stop deleting halfway**

Touch [CANCEL] or press the MENU button while deleting.

- The scenes or still pictures that have already been deleted when the deletion is cancelled cannot be restored.

**To complete editing**

Press the MENU button.

---

- You can also delete scenes by pressing the MENU button, selecting [EDIT SCENE] → [DELETE] → [ALL SCENES] or [SELECT].
- You can also delete still pictures by pressing the MENU button, selecting [PHOTO SETUP] → [DELETE] → [ALL SCENES] or [SELECT].
- When the intelligent scene selection or highlight playback is selected, scenes cannot be deleted.
- To delete an unwanted part of a scene, divide the scene first, and then delete the unnecessary part. (→ 89)
- Scenes/still pictures which cannot be played back (the thumbnails are displayed as ) cannot be deleted.
- In case of [ALL SCENES], the deletion may take time if there are many scenes or still pictures.
- When you delete scenes/still pictures, use a battery with sufficient battery power or use the AC adaptor.
- If you delete scenes recorded on other products or still pictures conforming to DCF standard with this unit, all the data related to the scenes/still pictures may be deleted.
- When still pictures recorded on an SD card by other products are deleted, a still picture (other than JPEG) that cannot be played back on this unit may be erased.

# Dividing a scene to delete

VIDEO

To delete an unnecessary portion of a scene, first divide the scene and then delete the unnecessary portion.

◇ Change the mode to .

**1** Touch the play mode select icon to select desired media to divide a scene. (→ 77)

**2** Select the menu. (→ 29)

[EDIT SCENE] → [DIVIDE] → [SET]

**3** Touch the scene to be divided.

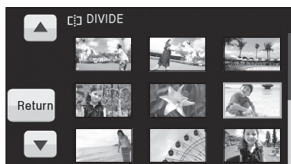

**4** Touch  to set the dividing point.



- Using slow-motion playback or frame-by-frame playback makes it easy to search for the point where you want to divide the scene. (→ 78)
- When the confirmation message appears, touch [YES].
- Touch [YES] to continue dividing the same scene. To continue dividing other scenes, touch [NO] and repeat steps 3-4.

**5** Press the MENU button to complete dividing.

**6** Delete the unnecessary scene. (→ 87)

*To delete all the divided points*

[DIVIDE] → [CANCEL ALL]

- When the confirmation message appears, touch [YES].
- All divided points set on this unit will be cancelled.
- The scenes that were deleted after division cannot be recovered.
- When [INTEL. SCENE] is selected, scenes cannot be divided.
- Scenes cannot be divided if the number of scenes played back on a selected date has reached 99.
- It may not be possible to divide scenes with a short recording time.
- Data that has been recorded or edited on another device cannot be divided and the divided points cannot be deleted.

# Protecting scenes/still pictures

VIDEO PHOTO

Scenes/still pictures can be protected so that they are not deleted by mistake.

**(Even if you protect some scenes/still pictures, formatting the media will delete them.)**

◇ Change the mode to  .

**1** Select the menu. (→ 29)

[VIDEO SETUP] or [PHOTO SETUP] →  
[SCENE PROTECT] → [YES]

**2** Touch the scene/still picture to be protected.



- When touched, the scene/still picture is selected and the **On** indication appears on the thumbnails. Touch the scene/still picture again to cancel the operation.
  - Press the MENU button to complete the settings.
- 
- When [INTEL. SCENE] is selected while playing back motion pictures, scenes cannot be protected.

PHOTO

You can write the data selecting still pictures to be printed and the number of prints (DPOF data) onto the SD card.

◇ **Change the mode to**  **and touch the play mode select icon to select [PICTURE/SD CARD]. (→ 84)**

### ■ What is DPOF?

DPOF (Digital Print Order Format) is a format which allows the user of a digital camera to define which captured images on the SD card are to be printed, together with information on the number of copies they wish to print. (Please note: Not all commercial printing services support this feature at this time.)

### 1 Select the menu. (→ 29)

[PHOTO SETUP] → [DPOF SET] → [SET]

### 2 Touch the still picture to be set.

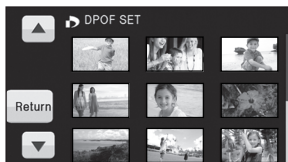

### 3 Touch / to set the number of prints.

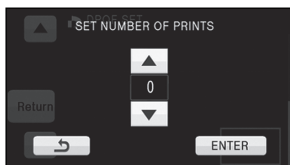

- Up to 999 prints can be selected. (Prints for set number can be printed with a printer that supports DPOF.)
- To cancel the setting, set the number of prints to [0].

### 4 Touch [ENTER].

- To continuously set other still pictures, repeat steps 2-4.
- Press the MENU button to complete the settings.

#### To cancel all DPOF settings

[DPOF SET] → [CANCEL ALL]

- When the confirmation message appears, touch [YES].
- Copy still pictures saved in the HDD to an SD card before setting DPOF.
- You cannot add the recording date to pictures to be printed with the DPOF settings.

**VIDEO** **PHOTO**

Motion pictures or still pictures recorded with this unit can be copied between an SD card inserted in this unit and HDD.

### Confirming remaining capacity on the copy destination

- If the remaining capacity on a single SD card is not enough, you can copy to multiple SD cards following the instruction on the screen.  
In this case, the last scene copied to an SD card is automatically divided to fit the space on the SD card.
- If you divide the scenes (→ 89), and copy by scene selection, it is possible to copy matching the remaining capacity of the media, or only the necessary parts.

#### ■ Media information display

- ◇ Change the mode to  and touch the play mode select icon to select desired media to confirm the media information. (→ 77)

Select the menu. (→ 29)

#### SD card information display

[SETUP] → [CARD STATUS] → [YES]

#### HDD information display

[SETUP] → [HDD STATUS] → [YES]

- Touch [EXIT] or press the MENU button to close the indication.
- 
- The 80 GB built-in HDD requires some space to store information and manage system files, so the actual usable space is slightly less than the indicated value. The usable HDD space is generally calculated as 1 GB=1,000,000,000 bytes. The capacities of this unit, PCs and software are expressed as 1 GB=1,024×1,024×1,024=1,073,741,824 bytes. Therefore, the indicated value of the capacity appears to be smaller.

# Copying

- If there is not much remaining capacity in the SD card, a confirmation message asking to copy after deleting all data on the SD card is displayed. Be aware that deleted data cannot be restored.

## 1 Change the mode to .

- Use a sufficiently charged battery or the AC adaptor.

## 2 Select the menu. (→ 29)

(When copying from HDD to SD card)

[COPY] → [ ↔ ] → [YES]

(When copying from SD card to HDD)

[COPY] → [ ↔ ] → [YES]

## 3 Touch the desired item.

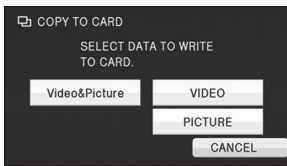

### [Video&Picture]:

All scenes are copied in order of motion pictures, then still pictures.

Proceed to step 7.

### [VIDEO]:

Motion pictures are copied.

### [PICTURE]:

Still pictures are copied.

## 4 (Only when [VIDEO]/[PICTURE] is selected in step 3)

**Touch the desired item.**

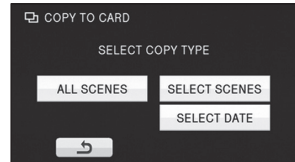

### [ALL SCENES]:

All motion pictures or still pictures are copied. Proceed to step 7.

### [SELECT SCENES]:

Some motion pictures or still pictures are selected for copying.

### [SELECT DATE]:

Copy by selecting the date.

## 5 (Only when [SELECT SCENES] is selected in step 4)

**Touch the scene/still picture to be copied.**

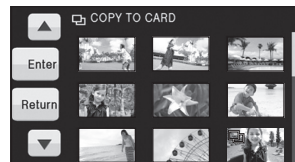

- When touched, the scene/still picture is selected and the  indication appears on the thumbnails. Touch the scene/still picture again to cancel the operation.
- Up to 99 scenes/still pictures can be set in succession.

(Only when [SELECT DATE] is selected in step 4)

### Touch the date to be copied.



- When touched, the date is selected and surrounded by red. Touch the date again to cancel the operation.
- Up to 99 dates can be set in succession.

### 6 (Only when [SELECT SCENES]/[SELECT DATE] is selected in step 4) Touch [Enter]/[ENTER].

### 7 When the confirmation message appears, touch [YES].

- If 2 or more SD cards are necessary to copy, change the card following the instructions on the screen.

### 8 Touch [EXIT] when the copy complete message is displayed.

- The thumbnail view of the copy destination is indicated.

#### *When you stop copying halfway*

Touch [CANCEL] or press the MENU button while copying.

#### **Approximate time for copying**

**To copy a 4 GB SD card with full motion pictures to a HDD:**

10 min to 20 min

**To copy approx. 600 MB still pictures**

**(picture size 10.6M):**

3 min to 5 min

**If you will delete the motion pictures or still pictures after copying is complete, be sure to play back the motion pictures or still pictures to check that they have been copied to correctly before deleting.**

- It is impossible to compress motion pictures or still pictures on the copy source into the capacity that can be accommodated by the usable space on the copy destination.
- Depending on the following conditions, the time it takes for copying may be longer.
  - The number of recorded scenes is large.
  - The temperature of the unit is high.
- If some motion pictures or still pictures have already been recorded to the copy destination, then the same date may be assigned or images may not display by date when the list by date is selected.
- Motion pictures that have been recorded on another device may not be copied. Data recorded on a PC with HD Writer AE 1.0, etc. cannot be copied.
- Protection and DPOF settings will be cleared on the copied motion pictures and still pictures when copying motion pictures and still pictures with protection and DPOF settings.
- The order in which the scenes or still pictures were copied cannot be changed.

Please be aware that if a medium is formatted, then all the data recorded on the medium will be erased and cannot be restored. Back up important data on a PC, DVD disc etc. (→ 103, 114)

◇ Change the mode to ,  or , and select desired media to be formatted. (→ 46, 50, 77)

Select the menu. (→ 29)

Formatting SD cards

[SETUP] → [FORMAT CARD] → [YES]

HDC-HS200

Formatting HDD

[SETUP] → [FORMAT HDD] → [YES]

- When the confirmation message appears, touch [YES].
- When formatting is complete, touch [EXIT] to exit the message screen.

HDC-HS200

- Perform a physical formatting of HDD when this unit is to be disposed/transferred. (→ 141)
- 
- Do not turn this unit off or remove the SD card, while formatting. Do not expose the unit to vibrations or shock.

**Use this unit to format media.**

**Formatting HDD is only available with this unit.**

**Do not format an SD card using any other equipment such as a PC. The card may not be used on this unit.**

# 1

## Watching Video/Pictures on your TV

VIDEO PHOTO

Confirm the terminals on your TV and use a cable compatible with the terminals. Image quality may vary with the connected terminals.

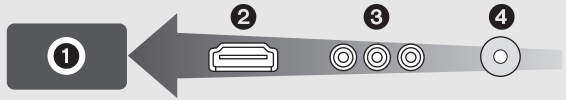

- ① High quality
- ② HDMI terminal
- ③ Component terminal
- ④ Video terminal

- Use the supplied component cable and AV cable. Use of the following Panasonic HDMI mini cables is recommended to connect the unit to the HDMI terminal.

### 1 Connect this unit to a TV.

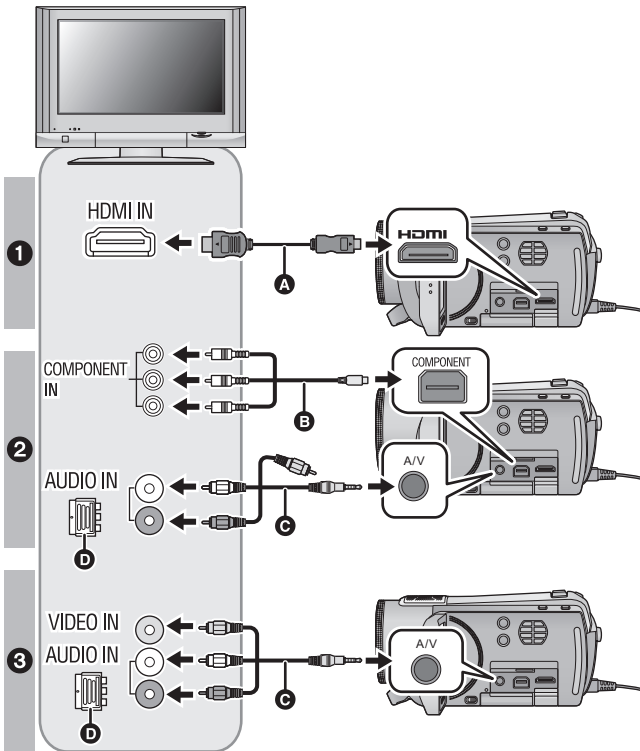

- A HDMI mini cable (optional)
- B Component cable (supplied)
- C AV cable (supplied)

- If your TV is not equipped with AV Input Sockets, the 21-pin Adaptor **D** (optional) is necessary. Consult your dealer.

#### Picture quality

- ① High definition images when connecting to HDMI terminal
- ② High definition images when connecting to component terminal compatible with 1080i Standard images when connecting to component terminal compatible with 576i
- ③ Standard images when connecting to video terminal

- Check that the plugs are inserted as far as they go.
- Do not use any other cables except a genuine Panasonic HDMI mini cable (RP-CDHM15, RP-CDHM30; optional).
- Do not use any other component cables except the supplied one.
- The component terminal is for outputting images only so be sure to also connect the AV cable. (It is not necessary to connect the yellow plug.)
- Do not use any other AV cables except the supplied one.

## 2 Select the video input on the TV.

- Example:  
 Select the [HDMI] channel with a HDMI mini cable.  
 Select the [Component] channel with a component cable.  
 Select the [Video 2] channel with an AV cable.  
 (The name of the channel may differ depending on the connected TV.)

## 3 Change the mode to to play back.

- The image and audio are output on the TV.

Cables	Reference items
<b>A</b> HDMI mini cable (optional)	<ul style="list-style-type: none"> <li>• Connecting with a HDMI mini cable (→ 98)</li> <li>• Listening in 5.1 channel sound (→ 99)</li> <li>• Playback using VIERA Link (HDAVI Control™) (→ 100)</li> </ul>
<b>B</b> Component cable (supplied)	<ul style="list-style-type: none"> <li>• Connecting with the component cable (→ 99)</li> </ul>

### If the image or audio from this unit does not appear on the TV

- Check the connections.
- Check that the plugs are inserted as far as they go.
- **Check the input setting (input switch) and the audio input setting on the TV. (For more information, please read the operating instructions for the TV.)**
- **Check the setting of the unit. (→ 98, 99)**



### ■ To watch images on a regular TV (4:3) or when both sides of the images do not appear on the screen

Change the menu setting to display the images correctly. (Check the TV setting.)

**Select the menu. (→ 29)**

[SETUP] → [TV ASPECT] → [4:3]

Example of images with a 16:9 aspect ratio on a regular TV (4:3)

[TV ASPECT] setting	
[16:9]	[4:3]
	

- If a wide-screen TV is connected, adjust the aspect setting on the TV. (Refer to the operating instructions of the TV for details.)

## ■ To display the on-screen information on the TV

When the EXT DISPLAY button on the remote control is pressed, the information displayed on the screen (operation icon and time code etc.) can be displayed/not displayed on the TV.

- It will not display when the power is turned off.



- When connecting with a HDMI mini cable, be sure to connect to a HDMI input terminal. Do not connect to a HDMI output terminal on other products.
- If the HDMI mini cable, component cable and AV cable are connected at the same time, output will be prioritized in order of the HDMI mini cable, component cable and AV cable.

**Refer to the following support site for information about the Panasonic TVs that you can directly insert an SD card into the SD card slot on the TV and then play it back.**  
<http://panasonic.net/>

- For details on how to play back, please read the operating instructions for the TV.

## Connecting with a HDMI mini cable

### What is HDMI?

HDMI is the interface for digital devices. If you connect this unit to a HDMI compatible high definition TV and then play back the recorded high definition images, you can enjoy them in high resolution with high quality sound.

If you connect this unit to a Panasonic TV compatible with VIERA Link, linked operations (VIERA Link) are possible. (→ 100)

Select the desired method of HDMI output.

### Select the menu. (→ 29)

[SETUP] → [HDMI RESOLUTION] → desired setting

#### [AUTO]:

The output resolution is automatically set based on the information from the connected TV.

Information from the connected TV	Output resolution
720p, 1080i	1080i
Others	576p

#### [1080i]:

The interlace method with 1080 available scan lines is used for output.

#### [576p]:

The progressive method with 576 available scan lines is used for output.

### Interlace method/progressive method

i= interlace scanning is scanning the screen with half of the effective scanning lines every 1/50 seconds, where p= progressive scanning is a high density image signal that is scanning the screen with all the effective scanning lines every 1/50 seconds.

- If the images are not output on the TV when the setting is [AUTO], switch to the method [1080i] or [576p] which enables the images to be displayed on your TV. (Please read the operating instructions for the TV.)

## Listening in 5.1 channel sound

You still can listen to the 5.1 channel sound recorded from the internal microphones when this unit is connected to the 5.1 channel compatible AV amplifier or TV using the HDMI mini cable. Please read the AV amplifier and TV operating instructions for how to connect this unit to the AV amplifier and TV.

- If you connect this unit to a Panasonic AV amplifier and Panasonic TV that are compatible with VIERA Link, linked operations (VIERA Link) become possible. (→ 100)
- The unit cannot be connected to the optical digital cable.

## Connecting with the component cable

Component output setting can be changed.

**Select the menu. (→ 29)**

[SETUP] → [COMPONENT OUT] → **desired setting**

### [576i]:

When connecting to the component terminal on the TV compatible with 576i.  
(Playback is in standard quality.)

### [1080i]:

When connecting to the component terminal on the TV compatible with 1080i.  
(Playback is in high definition quality.)

# Playback using VIERA Link (HDAVI Control™)

VIDEO PHOTO

## What is the VIERA Link?

- This function allows you to use your remote control for the Panasonic TV for easy operations when this unit has been connected to a VIERA Link compatible device using a HDMI mini cable (optional) for automatic linked operations. (Not all operations are possible.)
- VIERA Link is a unique Panasonic function built on a HDMI control function using the standard HDMI CEC (Consumer Electronics Control) specification. Linked operations with HDMI CEC compatible devices made by other companies are not guaranteed. When using devices made by other companies that are compatible with VIERA Link, refer to the operating instructions for the respective devices.
- This unit is compatible with VIERA Link Ver.4. VIERA Link Ver.4 is the newest Panasonic version and is also compatible with existing Panasonic VIERA Link devices. (As of Dec 2008)

◇ Change the mode to .

### 1 Select the menu. (→ 29)

[SETUP] → [VIERA Link] → [ON]

- The default setting is [ON].
- If you are not using VIERA Link, set to [OFF].

### 2 Connect this unit to a Panasonic TV compatible with VIERA Link with a HDMI mini cable.

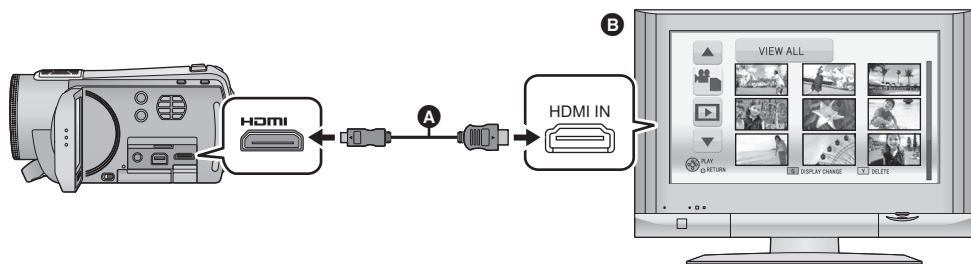

- A** HDMI mini cable (optional)
- B** Panasonic TV compatible with VIERA Link
- It is recommended to connect this unit to an HDMI terminal other than the HDMI1 if there are 2 or more HDMI input terminals on the TV.
- VIERA Link must be activated on the connected TV. (Read the operating instructions of the TV for how to set etc.)
- Do not use any other cables except a genuine Panasonic HDMI mini cable (RP-CDHM15, RP-CDHM30; optional).

### 3 Operate with the remote control for the TV.

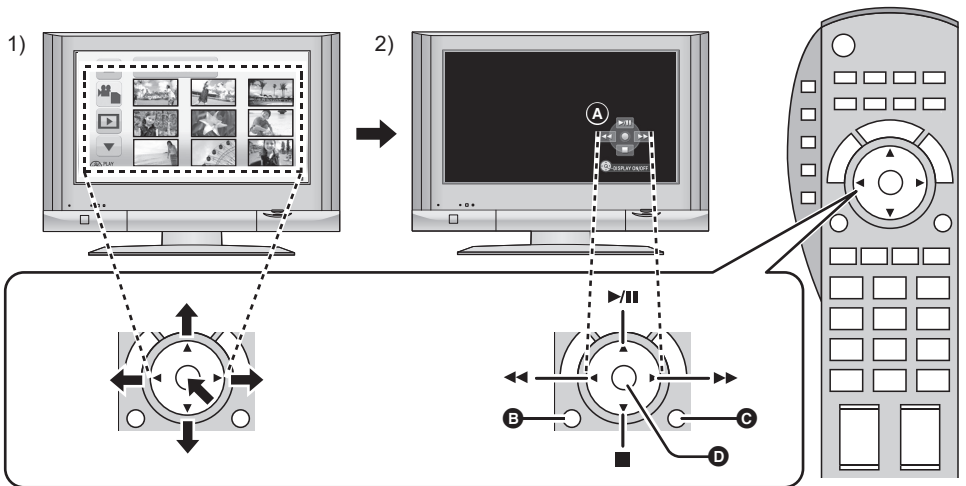

- 1) Press the button up, down, left or right to select a scene or still picture to be played back, and then press the button in the centre to set it.
  - 2) Activate the operation icons that are displayed on TV screen with the remote control for the TV.
- A** Operation icons
  - B** Display operation icons
  - C** Cancel operation icons
  - D** Display/Cancel operation icons
- The following operations are available by pressing the colour buttons on the remote control.
    - Green:  
Switching the number of scenes/still pictures in thumbnail display  
(9 thumbnails → 20 thumbnails → 9 thumbnails.....)
    - Yellow:  
Deleting scenes/still pictures

## ■ Other linked operations

### Turning the power off:

If you use the remote control for the TV to turn off the power, the power on this unit also turns off.

### Automatic input switching:

If you connect with a HDMI mini cable and then turn on the power on this unit, the input channel on the TV automatically switches to this unit's screen. If the TV's power is in standby status, it will turn on automatically (if [Set] has been selected for the TV's [Power on link] setting).

- Depending on the HDMI terminal on the TV, the input channel may not switch automatically. In this case, use the remote control for the TV to switch the input channel.
  - If VIERA Link does not work properly, refer to page 137.
- 

- If you are unsure whether or not the TV and AV amplifier you are using are compatible with VIERA Link, read the operating instructions for the devices.
- Available linked operations between this unit and a Panasonic TV is different depending on the types of Panasonic TVs even if they are compatible with VIERA Link. Refer to the operating instructions of the TV for the operations that support on the TV.
- Operation is not possible with a cable that is not based on the HDMI standard.

# Connecting a DVD burner to copy to/play back a disc

VIDEO PHOTO

Motion pictures or still pictures recorded with this unit can be copied to a DVD disc by connecting a DVD burner VW-BN1 (optional) to this unit using a Mini AB USB Connection Cable (supplied with VW-BN1). The copied DVD disc can also be played back.

- Please read the operating instructions of the DVD burner for how to use it.

## Preparing for copying/playing back

**We recommend using Panasonic DVD burner VW-BN1.**

### ■ About discs that can be used for copying

Disc type*1	DVD-RAM	DVD-RW	DVD-R	DVD-R DL
Copy*2	○	○	○	○
Additional copy*3	○	—	—	—
Format*4	○	○	—	—

\*1 Only 12 cm size disc can be used.

\*2 Use a new disc. You can additionally copy only to a DVD-RAM.

\*3 Only DVD-RAM copied with the DVD burner or HD Writer AE 1.0 can additionally copy.

\*4 Connect this unit and a DVD burner before formatting. If you format a used disc, you can copy on that disc. Please be aware that if a disc is formatted, then all the data recorded on the disc will be erased. (→ 109)

- We recommend using the discs that have been recommended in the operating instructions of the DVD burner. Refer to the operating instructions of the DVD burner for details about recommended discs, disc handling etc.
- The following cannot be copied on the same disc.
  - Motion pictures and still pictures
  - High-definition picture quality and existing standard picture quality

## 1 Connect the AC adaptor (supplied with VW-BN1) to the DVD burner.

- You cannot supply power to the DVD burner from this unit.

## 2 Connect this unit to the AC adaptor and change the mode to .

## 3 Connect this unit to the DVD burner with the Mini AB USB Connection Cable (supplied with VW-BN1).

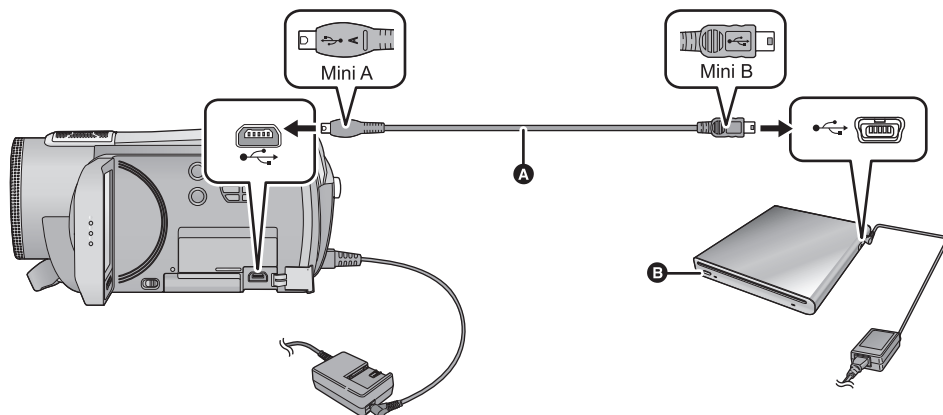

**A** Mini AB USB Connection Cable (supplied with VW-BN1)

**B** DVD burner (optional)

- Insert the plugs as far as they will go.

## 4 Insert the disc in the DVD burner.

- Insert the DVD disc with the recording side down when using the VW-BN1.

## 5 Touch the desired item.

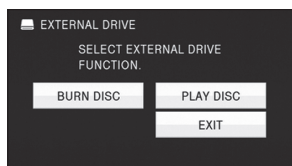

- [BURN DISC]: Refer to page 105 for how to copy discs.
- [PLAY DISC]: Refer to page 108 for how to play back the copied discs.

### ***To terminate the connection with the DVD burner***

Touch [EXIT].

- Disconnect the Mini AB USB Connection Cable from this unit.

## Copying to discs

- You cannot copy from multiple SD cards to 1 disc. (You can additionally copy only to a DVD-RAM.)
- Motion pictures and still pictures cannot both be copied to a single disc.
- Confirm that auto protection is [ON] before copying data. (→ 109)

### 1 Connect this unit to the DVD burner to prepare for copying. (→ 103)

- For users who have [HDC-SD200], proceed to step 3.

### 2 [HDC-HS200] Touch copy source media.



### 3 Touch the desired item to be copied.

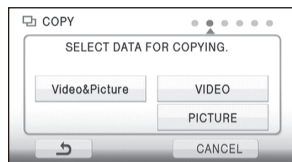

When [Video&Picture] is selected, all scenes are copied in order of motion pictures, then still pictures.

(Since motion pictures and still pictures are copied to separate discs, 2 or more discs are required.)

- It will return to the previous step by touching ↶.

### 4 (Only when [Video&Picture]/[VIDEO] is selected in step 3)

**Touch the recording method for copying.**

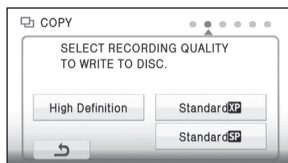

[High Definition]:

The images recorded in high definition picture quality with this unit are copied as they are.

[Standard (XP)]/[Standard (SP)]:

Images are converted into the original standard picture quality and then copied.

Since XP has a higher picture quality compared to SP, the data capacity becomes large so that you may need more discs for copying than SP.

- When [Video&Picture] is selected in step 3, follow the instructions on the screen and touch [NEXT] to proceed to step 8.

- 
- 5** (Only when [VIDEO]/[PICTURE] is selected in step 3)

**Touch the desired item.**

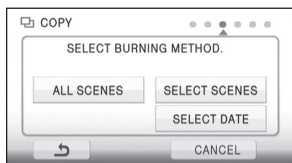

**[ALL SCENES]:**

All motion pictures or still pictures are copied. Touch [NEXT] to proceed to step 8.

**[SELECT SCENES]:**

Some scenes are selected for copying.

**[SELECT DATE]:**

Copy by selecting the date.

- 
- 6** (Only when [SELECT SCENES] is selected in step 5)

**Touch the scene you want to copy.**

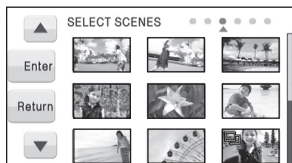

- When touched, the scene is selected and the  indication appears on the thumbnails. Touch the scene again to cancel the operation.
- Up to 99 scenes can be selected in succession.

(Only when [SELECT DATE] is selected in step 5)

**Touch the date you want to copy.**



- When touched, the date is selected and surrounded by red. Touch the date again to cancel the operation.
- Up to 99 dates can be selected in succession.

- 
- 7** (Only when [SELECT SCENES]/[SELECT DATE] is selected in step 5)

**Touch [Enter]/[ENTER].**

- Touch [NEXT].

---

**8 Touch [START].**

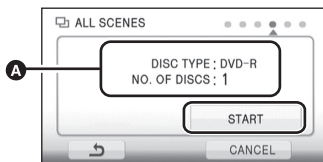

- **A** The number of discs necessary for copying by disc type
- When 2 or more discs are necessary for copying, follow the on-screen instructions to switch discs.
- You may need more discs than displayed number of discs when you are copying additionally to a used DVD-RAM.
- Eject the disc after copying is completed.

**Before you delete the data on the media after copying is complete, be sure to play back the discs to check that they have been copied to correctly. (→ 108)**

## Important Notice

- When connecting an optional DVD burner and this unit for copying a disc, do not insert a disc with recorded motion pictures in high definition picture quality into devices that do not support the AVCHD format. In some cases the disc may get stuck in the device. The disc will not play back on devices that do not support the AVCHD format.
- When inserting a disc containing recorded motion/still pictures into other devices, a message prompting you to format the disc may be displayed. Do not format the disc, since deleted data cannot be restored later.

## About the approximate time it takes for copying to a disc

To copy motion pictures to the full capacity of a disc

Disc type	Copy time		
	[High Definition]	[Standard (XP)]	[Standard (SP)]
DVD-RAM	Approx. 50 min to 80 min	Approx. 90 min to 120 min	Approx. 135 min to 180 min
DVD-RW*	Approx. 35 min to 75 min		
DVD-R*	Approx. 15 min to 45 min		

\* Even if the data capacity to be copied is small, the time it takes for copying may be about the same as the time shown in the table.

- When copying motion pictures in standard picture quality to a disc, the recordable time of [Standard (XP)] is approx. 60 minutes and that of [Standard (SP)] is approx. 120 minutes.

To copy approx. 600 MB still pictures (Picture size  $\frac{10.6m}{1}$ )

Disc type	Copy time
DVD-RAM/DVD-RW/DVD-R	Approx. 10 min to 20 min

- Copy time of DVD-R DL is approximately 2 to 3 times that of DVD-R.
- Depending on the following conditions, the time it takes for copying may be longer than the above times.
  - When the number of recorded scenes is large
  - When the temperature of the DVD burner has become high

- **The disc that was copied to can be played back by connecting this unit and a DVD burner. (→ 108)**
- Do not turn off this unit or the DVD burner or disconnect the Mini AB USB Connection Cable while copying. Also, do not shake this unit or the DVD burner.
- It is impossible to stop copying halfway.
- The order in which the scenes were copied cannot be changed.
- Data that has been recorded on another device may not be copied.
- When 2 or more discs are necessary for copying, the last scene copied to a disc is automatically divided to fit the space on the disc.
- Copying may be completed using less discs than the number displayed if scenes were automatically divided.
- When the disc that was copied to is played back on another device, the picture may momentarily stop at the points where the scenes switch.
- Discs copied in [Standard (XP)]/[Standard (SP)] cannot be used in the intelligent scene selection or highlight playback.

## Playing back the copied disc

- Only discs that have been copied by connecting this unit to the DVD burner or created with HD Writer AE 1.0 can be played back. It may not be possible to play back discs copied/played back on other devices or software.

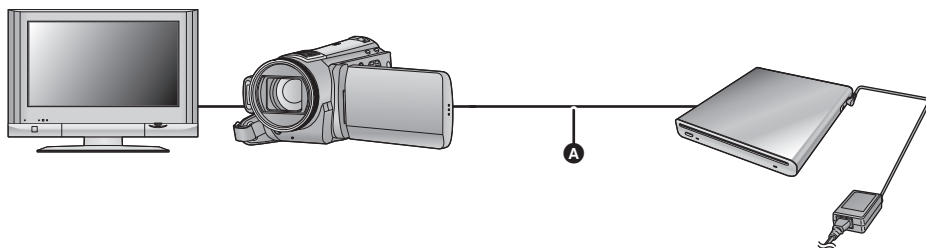

- **A** Mini AB USB Connection Cable (supplied with VW-BN1)

### **1** Connect this unit to the DVD burner to prepare for playback. (→ 103)

- When playing back on a TV, connect this unit to the TV with HDMI mini cable, component cable or AV cable. (→ 96)

### **2** Touch the scene or still picture to be played back and then play it back.

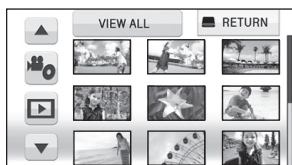

- The playback operation is performed the same as when playing back motion pictures or still pictures. (→ 77, 84)
  - It will return to Step 5 on page 104 when [RETURN] is selected in the thumbnail screen.
- 
- It is also possible to switch the media to play back by touching the play mode select icon. It is possible to select [VIDEO/DISC] or [PICTURE/DISC] when the DVD burner is connected.
  - Black bands may appear on the left and right of the screen when it is played back connected to a TV with 4:3 ratio.

# Managing the copied disc (Formatting, Auto protect, Displaying disc information)

- Connect this unit to the DVD burner and then touch [PLAY DISC]. (→ 103)

## ■ Formatting discs

This is for initializing DVD-RAM and DVD-RW discs.

**Please be aware that if a disc is formatted, then all the data recorded on the disc will be erased. Back up important data on a PC etc.**

**Select the menu. (→ 29)**

[DISC SETUP] → [FORMAT DISC] → [YES]

- When the confirmation message appears, touch [YES].
  - When formatting is complete, touch [EXIT] to exit the message screen.
- 
- Connect this unit and the DVD burner to format discs. You may no longer be able to use the discs if you format them on another device such as a PC etc.

## ■ Auto protect

You can protect (write protect) a DVD-RAM or DVD-RW disc when copying motion pictures or still pictures in high definition picture quality to the disc.

**1 Select the menu. (→ 29)**

[DISC SETUP] → [AUTO PROTECT] → [ON]

- The default setting is [ON].
- If a disc that you copied to is inserted in another device without protecting it, a message may be displayed prompting you to format the disc. We recommend setting [AUTO PROTECT] to [ON] in order to prevent accidental deletion.

**2 Copy to the disc. (→ 105)**

- The copied disc is write protected when it is ejected if [AUTO PROTECT] is [ON].

### *To release the disc protection*

- If you format a disc, the auto protection is released. Please be aware that all the data recorded on the disc is erased and cannot be recovered.
- The disc will need to be re-formatted on the device you will use.

## ■ Displaying disc information

Information such as the type of recorded disc, the number of recorded scenes and whether or not the disc is finalized is displayed.

**Select the menu. (→ 29)**

[DISC SETUP] → [DISC STATUS] → [YES]

- Touch [EXIT] to exit the information screen.

## 2

# Dubbing images onto other video device

VIDEO

Images played back on this unit can be dubbed onto a DVD recorder or video device.

- **Images are dubbed in standard quality.**
- Use the AC adaptor to free you from worrying about the battery running down.

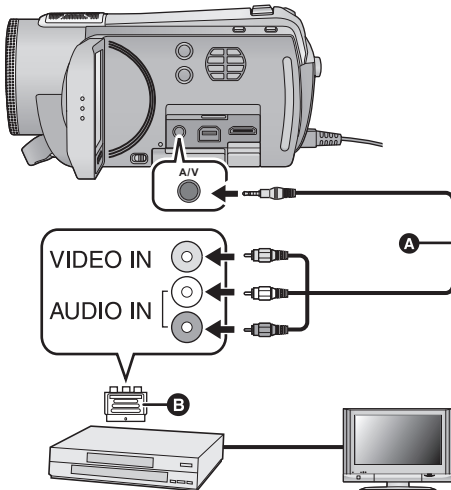

## Change the video input on the video device and TV that this unit is connected to.

- The channel set will differ depending on the terminal to which the unit is connected.
- See the operating instructions of the video device for details.
- Insert the plugs as far as they will go.
- Do not use any other AV cables except the supplied one.
- **A** AV cable (supplied)
- If your recorder is not equipped with AV Input Sockets, the 21-pin Adaptor **B** (optional) is necessary. Consult your dealer.

**1** Connect this unit to a video device and then change the mode to .

**2** Start playback on this unit.

**3** Start recording on the connected device.

- To stop recording (dubbing), stop playback on this unit after stopping recording on the recorder.
- If the date and time display and function indication are not wanted, cancel them before dubbing. (→ 34, 98)

If the dubbed images are played back on a wide-screen TV, the images may be stretched vertically. In this case, refer to the operating instruction of the device you are connecting to or read the operating instructions of the wide-screen TV and set the aspect ratio to 16:9.

# With a printer (PictBridge)

PHOTO

To print pictures by directly connecting this unit to the printer, use a printer compatible with PictBridge. (Read the operating instructions for the printer.) PictBridge is an industry standard from the Camera & Imaging Products Association (CIPA) for direct printing. It allows images to be printed directly from digital cameras to a printer, without having to connect the camera to a PC.

- Use the AC adaptor to free you from worrying about the battery running down.
- **Turn on this unit. (This function is available in all modes.)**

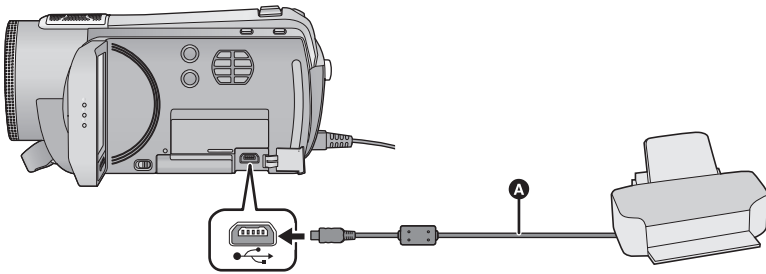

- **A** USB cable (supplied)
- Insert the plugs as far as they will go.

## 1 Connect this unit to a printer.

The USB function selection screen will appear.

- Connect the printer directly to this unit. Do not use a USB hub.
- Do not use any other USB cables except the supplied one. (Operation is not guaranteed with any other USB cables.)

## 2 Touch [PRINTER].

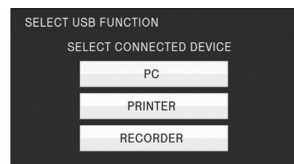

- For users who have **[HDC-SD200]**, proceed to step 4.
- **[HDC-SD200]**  
If the [PictBridge] indication does not appear or continues to flash, disconnect and then reconnect the USB cable.

---

### 3 **HDC-HS200** Select print source media and touch the icon.



- If the [PictBridge] indication does not appear or continues to flash, disconnect and then reconnect the USB cable.

---

### 4 Touch a still picture to be printed.



---

### 5 Touch / to set the number of prints.



- Touch [ENTER] after the number of prints is set.
- You can set up to 9 prints.
- To cancel the setting, set the number of prints to [0].
- Up to 99 files can be set in succession.

---

### 6 Touch .



---

### 7 Touch [DATE PRINT] to select the date print setting.



- If the printer is not capable of date printing, this setting is unavailable.

---

## 8 Touch [PAPER SIZE] to select the paper size setting.

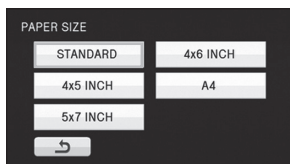

[STANDARD]: Size specific to the printer

[4×5 INCH]: L size

[5×7 INCH]: 2L size

[4×6 INCH]: Postcard size

[A4]: A4 size

- You cannot set paper sizes not supported on the printer.

---

## 9 Touch [PAGE LAYOUT] to select the desired layout setting.

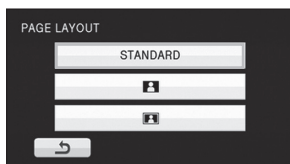

[STANDARD]: Layout specific to the printer

: No frame print

: Frame print

- You cannot set page layouts not supported on the printer.
- Touch .

---

## 10 Touch to print the pictures.

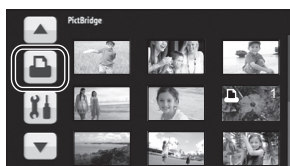

- When the confirmation message appears, touch [START].
  - Exit PictBridge by disconnecting the USB cable (supplied) after the pictures have been printed.
- 

### **When you stop printing halfway**

Touch [CANCEL].

- A confirmation message appears. If [YES] is selected, the number of prints set is cancelled and the screen returns to step 4. If [NO] is selected, all the settings are kept and the screen returns to step 4.
- 
- Avoid the following operations during printing. These operations disable proper printing.
    - Disconnecting the USB cable
    - Opening the SD card cover and removing the SD card
    - Changing the mode
    - Turn the unit off
  - The edges of still pictures recorded in this unit with a 16:9 aspect ratio may be cut off. When using a printer with a trimming or borderless printing function, cancel this function before printing. (Refer to the operating instructions of the printer for details.)
  - When the unit is connected directly to the printer, the DPOF settings cannot be used.

# 1

## What you can do with a PC

You can copy the motion/still picture data to the HDD of PCs or write to media like Blu-ray discs (BD) DVD discs or SD card using HD Writer AE 1.0 for HDC, the software installed in the supplied CD-ROM.

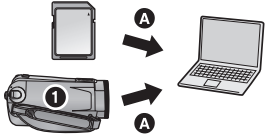
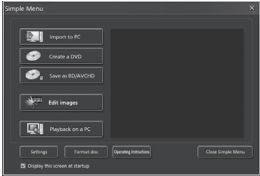
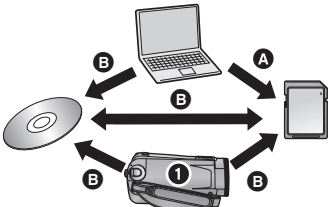
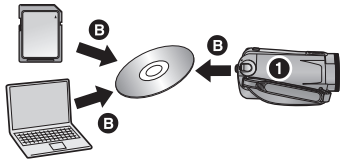
Available function	Data type	Software required
<p><b>Copying data to a PC:</b></p> <p><b>A</b> Motion/Still pictures</p> <p><b>1</b> <b>HDC-HS200</b> Built-in HDD</p> 	<p>Motion picture and still picture</p>	<p><b>CD-ROM (supplied):</b> HD Writer AE 1.0 for HDC*</p> 
<p><b>Copying in BD/AVCHD format:</b></p> <p><b>A</b> Motion/Still pictures</p> <p><b>B</b> Motion pictures</p> <p><b>1</b> <b>HDC-HS200</b> Built-in HDD</p> 		
<p><b>Copying in DVD-Video format:</b></p> <p><b>B</b> Motion pictures</p> <p><b>1</b> <b>HDC-HS200</b> Built-in HDD</p> <ul style="list-style-type: none"> <li>Converted to conventional standard quality (MPEG2 format).</li> </ul> 		
<p><b>Editing:</b></p> <p>Editing motion picture data copied on an HDD of a PC</p> <ul style="list-style-type: none"> <li>Title, Transition, Delete partially, Divide Scene</li> <li>Converting the motion picture data to MPEG2</li> <li>Converting part of motion picture into still picture</li> </ul>	<p>Motion picture</p>	
<p><b>Playing back on a PC:</b></p> <p>Play back the motion picture data in high definition picture quality on a PC.</p>		
<p><b>Formatting discs:</b></p> <p>Depending on the type of disc that you use, formatting is necessary.</p>		

Available function	Data type	Software required
Playing back on a PC	Still picture	HD Writer AE 1.0 or Standard Windows picture viewer or a commercially available picture viewer
Copying still pictures to a PC (→ 123)		Windows Explorer
Refer to page 125 if using a Macintosh.		

\* Refer to the operating instructions of HD Writer AE 1.0 (PDF file) for details on how to use it.

### Important Notice

- **Do not insert a disc recorded in AVCHD format with HD Writer AE 1.0 in a device that does not support the AVCHD format. In some cases the disc may get stuck in the device. The disc will not play back on devices that do not support the AVCHD format.**
- **When inserting a disc containing recorded motion pictures into other devices, a message prompting you to format the disc may be displayed. Do not format the disc, since deleted data cannot be restored later.**

### ● **HDC-HS200**

It is impossible to write data to the HDD on this unit from a PC.

- **Motion pictures that have been recorded on another device cannot be written to the software supplied with this unit. To write motion picture data recorded with the Panasonic High Definition Video Camera sold previously, use the HD Writer supplied with the unit.**
- We cannot guarantee operation if you use software other than that supplied to read motion picture.
- Do not start the software supplied with this unit and other software at the same time. Close any other software if you start the software supplied with this unit and close the software supplied with this unit if you start any other software.
- Be sure to use the supplied USB cable when connecting this unit and a PC. (Operation is not guaranteed with any other USB cables.)
- We recommend reading the data from SD card or PC by connecting this unit and PC with the supplied USB cable. In some cases, the SDHC memory card might not be compatible with the SD card slot that is built in the PC or the SD card reader/writer that you use. Moreover, the SD card might be damaged if it is inserted anywhere other than the SD card slot. Be sure to insert it in card slot for the SD card.

### ■ **To use the HD Writer AE 1.0**

You will need a high performance PC depending on the functions to be used. It may not properly play back or properly operate depending on the environment of the PC used. Refer to the operating environment and notes on page 117.

- Operation during the playback may become slow if the CPU or memory is not fulfilling the requirements of the operating environment.
- Always use the most current driver for the video card.
- Always make sure there is enough capacity on the HDD in the PC. It may become inoperable or the operation may stop suddenly if the capacity gets low.

# End User License Agreement

Before opening the CD-ROM package, please read the following.

You ("Licensee") are granted a license for the Software defined in this End User License Agreement ("Agreement") on condition that you agree to the terms and conditions of this Agreement. If Licensee does not agree to the terms and conditions of this Agreement, promptly return the Software to Panasonic Corporation ("Panasonic"), its distributors or dealers from which you made the purchase.

## Article 1 License

Licensee is granted the right to use the software, including the information recorded or described on the CD-ROM, instruction manuals, and any other media provided to Licensee (collectively "Software"), but all applicable rights to patents, copyrights, trademarks and trade secrets in the Software are not transferred to Licensee.

## Article 2 Use by a Third Party

Licensee may not use, copy, modify, transfer or allow any third party, whether free of charge or not, to use, copy or modify the Software, except as expressly provided for in this Agreement.

## Article 3 Restrictions on Copying the Software

Licensee may make a single copy of the Software in whole or a part solely for back-up purpose.

## Article 4 Computer

Licensee may use the Software only on one computer, and may not use it on more than one computer.

## Article 5 Reverse Engineering, Decompiling or Disassembly

Licensee may not reverse engineer, decompile, or disassemble the Software, except to the extent either of them is permitted under law or regulation of the country where Licensee resides. Panasonic, or its distributors will not be responsible for any defects in the Software or damage to Licensee caused by Licensee's reverse engineering, decompiling, or disassembly of the Software.

## Article 6 Indemnification

The Software is provided "AS-IS" without warranty of any kind, either expressed or implied, including, but not limited to, warranties of non-infringement, merchantability and/or fitness for a particular purpose. Further, Panasonic does not warrant that the operation of the Software will be uninterrupted or error free. Panasonic or any of its distributors will not be liable for any damage suffered by Licensee arising from or in connection with Licensee's use of the Software.

## Article 7 Export Control

Licensee agrees not to export or re-export to any country the Software in any form without the appropriate export licenses under regulations of the country where Licensee resides, if necessary.

## Article 8 Termination of License

The right granted to Licensee hereunder will be automatically terminated if Licensee contravenes any of the terms and conditions of this Agreement. In this event, Licensee must destroy the Software and related documentation together with all the copies thereof at Licensee's own expense.

# Operating environment

- Even if the system requirements mentioned in these operating instructions are fulfilled, some PCs cannot be used.
- A CD-ROM drive is necessary to install the supplied software applications. (A compatible BD/DVD writer drive and media are necessary for writing to a BD/DVD.)
- Operation is not guaranteed in the following cases.
  - When 2 or more USB devices are connected to a PC, or when devices are connected through USB hubs or by using extension cables.
  - Operation on an upgraded OS.
  - Operation on an OS other than the one pre-installed.
- This software is not compatible with Microsoft Windows 3.1, Windows 95, Windows 98, Windows 98SE, Windows Me and Windows NT.

## ■ Operating environment for HD Writer AE 1.0 for HDC

<b>PC</b>	IBM PC/AT compatible PC
<b>OS</b>	Microsoft Windows 2000 Professional Service Pack 4 Microsoft Windows XP Home Edition Service Pack 2/Service Pack 3 Microsoft Windows XP Professional Service Pack 2/Service Pack 3 Microsoft Windows Vista Home Basic or Service Pack 1 Microsoft Windows Vista Home Premium or Service Pack 1 Microsoft Windows Vista Ultimate or Service Pack 1 Microsoft Windows Vista Business or Service Pack 1
<b>CPU</b>	Intel Pentium III 1.0 GHz or higher (including compatible CPU) <ul style="list-style-type: none"> <li>• Intel Core 2 Duo 2.16 GHz or higher, Intel Pentium D 3.2 GHz or higher or AMD Athlon™ 64 X2 Dual-Core 5200+ or higher is recommended when a playback function or MPEG2 output function is used.</li> <li>• Intel Core 2 Quad 2.6 GHz or higher is recommended when using the editing or seamless conversion function or continuous photo playback function.</li> </ul>
<b>RAM</b>	Windows Vista: 1 GB or more Windows XP/2000: 512 MB or more (1 GB or more recommended)
<b>Display</b>	High Colour (16 bit) or more (32 bit or more recommended) Desktop resolution of 1024×768 pixels or more (1280×1024 pixels or more recommended) Windows Vista: DirectX 9.0c compatible video card (DirectX 10 recommended) with DirectDraw overlay Windows XP/2000: DirectX 9.0c compatible video card Compatible with DirectDraw overlay PCI Express™×16 compatible recommended
<b>Free hard disk drive space</b>	Ultra DMA — 100 or more 450 MB or more (for installing the application) <ul style="list-style-type: none"> <li>• When writing to a DVD/BD/SD, more than double the amount of free space as the disc being created is necessary.</li> </ul>

<b>Necessary software</b>	Windows Vista SP1: DirectX 10.1 (already installed with Windows Vista SP1) Windows Vista: DirectX 10 (already installed with Windows Vista) Windows XP/2000: DirectX 9.0c (already installed with Windows XP SP2) <ul style="list-style-type: none"> <li>• If you install the software on a PC that is not compatible with DirectX 9.0c, the PC may not work properly. If you are unsure whether or not your PC is compatible, contact the maker of your PC.</li> </ul>
<b>Sound</b>	DirectSound Support
<b>Interface</b>	USB port [Hi-Speed USB (USB 2.0)]
<b>Other requirements</b>	Mouse or equivalent pointing device Internet connection

- Supplied CD-ROM is available for Windows only.
- Input is not supported in languages other than English, German, French and Simplified Chinese.
- Operation cannot be guaranteed on all BD/DVD drives.
- Operation is not guaranteed on Microsoft Windows Vista Enterprise, Windows XP Media Center Edition, Tablet PC Edition and not compatible with 64 bit operation systems.
- This software is not compatible with a multi-boot environment.
- This software is not compatible with a multi-monitor environment.
- If using Windows XP/2000, an administrative account user only can use this software. If using Windows Vista, administrative account and standard account users only can use this software. (An administrative account user should install and uninstall this software.)

## ■ Operating environment for the card reader function (mass storage)

<b>PC</b>	IBM PC/AT compatible PC
<b>OS</b>	Microsoft Windows 2000 Professional Service Pack 4 Microsoft Windows XP Home Edition Service Pack 2/Service Pack 3 Microsoft Windows XP Professional Service Pack 2/Service Pack 3 Microsoft Windows Vista Home Basic or Service Pack 1 Microsoft Windows Vista Home Premium or Service Pack 1 Microsoft Windows Vista Ultimate or Service Pack 1 Microsoft Windows Vista Business or Service Pack 1 Microsoft Windows Vista Enterprise or Service Pack 1
<b>CPU</b>	Windows Vista: 32-bit (×86) Intel Pentium III 1.0 GHz or higher processor Windows XP/2000: Intel Pentium III 450 MHz or higher or Intel Celeron 400 MHz or higher
<b>RAM</b>	Windows Vista Home Basic: 512 MB or more Windows Vista Home Premium/Ultimate/Business/Enterprise: 1 GB or more Windows XP/2000: 128 MB or more (256 MB or more recommended)
<b>Interface</b>	USB port
<b>Other requirements</b>	Mouse or equivalent pointing device

- The USB equipment operates with the driver installed as standard in the OS.

When installing the software, log on to your computer as the Administrator or with a user name with equivalent authorization. (If you do not have authorization to do this, consult your manager.)

- Before starting the installation, close all applications that are running.
- Do not perform any other operations on your PC while the software is being installed.

### For Windows Vista:

If [User Account Control] dialogue appears, click [Continue].

## 1 Insert the CD-ROM into the PC.

- If the installation screen does not appear automatically, double-click the CD-ROM drive icon in [My Computer (Computer)].

## 2 Click [Next].

## 3 Select where the application is to be installed, then click [Next].

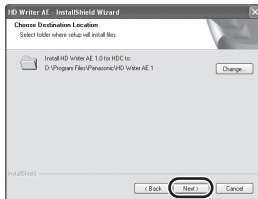

## 4 Select [Yes] or [No] to create shortcut.

## 5 Select the country or region where you live, then click [Next].

- If the country or region cannot be selected, select [PAL Area].



- When the confirmation message appears, click [Yes].

## 6 Click [Install] to start the installation process.



- A message regarding the playback in the environment used may be displayed depending on the performance of the PC used. Click [OK] after confirming.
- If using Windows 2000, Microsoft DirectX 9.0c must be installed in order to operate HD Writer AE 1.0. Depending on the operating environment, you may be required to install DirectX 9.0c. If so, click [Yes], and install it. If you install the software on a PC that is not compatible with DirectX 9.0c, the PC may not work properly. If you are unsure whether or not your PC is compatible, contact the PC manufacturer.

---

**7** When installation is complete, some notes will appear.  
**Check the contents, then close the window.**

---

**8** Select [Yes, I want to restart my computer now.], then click [Finish].



The PC must be rebooted for the application to work.

---

## ■ Uninstalling HD Writer AE 1.0

Follow the steps below to uninstall any software applications that you no longer require.

**1** Select [start] → ([Settings] →) [Control Panel] → [Add or Remove Programs (Applications)] or [Uninstall a program].

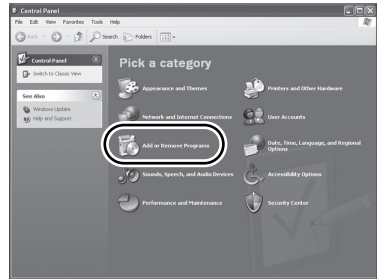

**2** Select [HD Writer AE 1.0 for HDC], then click [Change/Remove] ([Change or Remove] or [Add/Remove]) or [Uninstall].

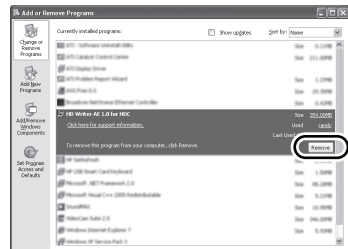

- Proceed with the uninstallation by following the on-screen instructions.
- After uninstalling the software, be sure to reboot the PC.

# Connecting to a PC

- Connect this unit to the PC after the software applications are installed.
- Remove the supplied CD-ROM from your PC.

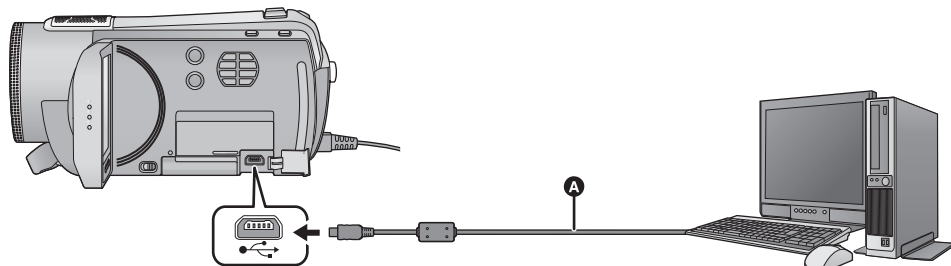

- A** USB cable (supplied)

## 1 Connect this unit to the AC adaptor.

- It is possible to use it connected to the PC with the batteries only.



## 2 Turn on the unit.

- This function is available in all modes.

## 3 Connect this unit to a PC.

The USB function selection screen will appear.

- Insert the USB connectors as far as they will go.
- Do not use any other USB cables except the supplied one. (Operation is not guaranteed with any other USB cables.)

- **When the unit is connected to a PC its power cannot be turned off. Disconnect the USB cable, before turning this unit off.**
- Do not disconnect the USB cable or the AC adaptor while the access lamp is on or card access icon (  ) appears on the unit screen.
- **HDC-HS200**  
Do not disconnect the USB cable or the AC adaptor while the HDD access lamp is on or HDD access icon (  ) appears on the unit screen.

## 4 Touch [PC].

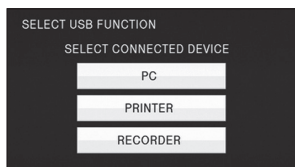

- This unit is automatically recognised as an external drive of the PC. (→ 123)

## ■ If the driver has not been recognised properly

Use the following methods to enable it to be recognised.

### Method 1:

Turn off the unit and your PC once and try verifying again.



### Method 2:

Remove the SD card and try verifying again.

### Method 3:

Try connecting the unit to another USB port on your PC.

## ■ To disconnect USB cable safely

- 1 Double click the  (  ) icon in task tray displayed on the PC.
  - Depending on your PC's settings, this icon may not be displayed.
- 2 Select [USB Mass Storage Device] and click [Stop].
- 3 **HDC-SD200**  
Verify [MATSHITA HDC-SD200/SD USB Device] is selected and click [OK].  
**HDC-HS200**  
Verify [MATSHITA HDC-HS200/SD USB Device] or [MATSHITA HDC-HS200/HDD USB Device] is selected and click [OK].

# About the PC display

When the unit is connected to a PC, it is recognised as an external drive.

- Removable disk (Example:  CAM\_SD (L) ) is displayed in [My Computer (Computer)].

We recommend using HD Writer AE 1.0 to copy motion picture data.

Using Windows Explorer or other programmes on the PC to copy, move or rename files and folders recorded with this unit will result in them being unusable with HD Writer AE 1.0. It is impossible to write data to the HDD on this unit from a PC.

## Example folder structure of an SD card:

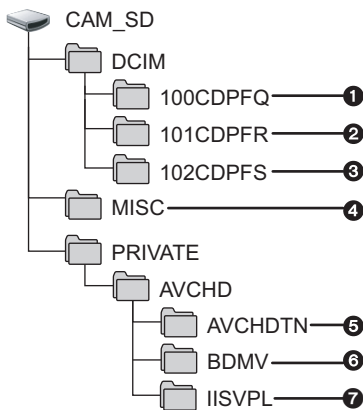

## HDC-HS200

### Example folder structure of HDD:

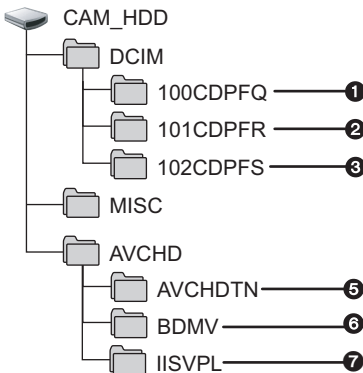

The following data will be recorded.

- 1 Up to 999 still pictures in JPEG format ([IMG0001.JPG] etc.)
- 2 JPEG format still pictures recorded in hi-speed burst shooting mode
- 3 JPEG format still pictures created from the motion picture
- 4 The DPOF setting files
- 5 The motion picture thumbnails
- 6 AVCHD format motion picture files ([00000.MTS] etc.)
- 7 Files for intelligent scene selection playback

## ■ Copying your still pictures to your PC

### Card reader function (mass storage)

Still pictures recorded with this unit can be copied to the PC with Explorer or other programmes.

- 1 Double click the folder that contains the still pictures. ([DCIM] → [100CDPFQ] etc.)
- 2 Drag and drop the still pictures onto the destination folder (on the PC's HDD).

- Do not delete the SD card's folders. Doing so may make the SD card unuseable in this unit.
- When data not supported by this unit has been recorded on a PC, it will not be recognised by this unit.
- Always use this unit to format SD cards.

# Starting HD Writer AE 1.0

- When using HD Writer AE 1.0 on Windows XP/2000, log on to your computer as Administrator (or with a login name equally authorized). If you log on with a login name other than Administrator, you cannot use the applications.
- When using HD Writer AE 1.0 on Windows Vista, log on to your computer as Administrator (or with a login name equally authorized) or with the user name for a standard user account. If you log on with a user name for a guest user account, the software cannot be used.

(On the PC)

**Select [start] → [All Programs (Programs)] → [Panasonic] → [HD Writer AE 1.0] → [HD Writer AE].**



- For details on how to use the software applications, read the PDF operating instructions of the software.

## Reading the operating instructions of the software applications

- You will need Adobe Acrobat Reader 5.0 or later or Adobe Reader 7.0 or later to read the PDF operating instructions.

**Select [start] → [All Programs (Programs)] → [Panasonic] → [HD Writer AE 1.0] → [Operating Instructions].**



# If using Macintosh

- HD Writer AE 1.0 is not available for Macintosh.
- iMovie'08 7.1.2 or later supported. For details about iMovie'08, please contact Apple Inc.

## ■ Operating environment for the card reader function (mass storage)

<b>PC</b>	Mac
<b>OS</b>	Mac OS X 10.4 Mac OS X 10.5
<b>CPU</b>	PowerPC G5 (1.8 GHz or higher) Intel Core Duo Intel Core Solo
<b>RAM</b>	64 MB or more
<b>Interface</b>	USB port

- Even if the system requirements mentioned in these operating instructions are fulfilled, some PCs cannot be used.
- The USB equipment operates with the driver installed as standard in the OS.
- Supplied CD-ROM is available for Windows only.

## ■ Copying still pictures on PC

### 1 Connect this unit to a PC via the supplied USB cable.

- The USB function selection screen will appear.

### 2 Touch [PC].

### 3 Double-click [CAM\_SD] displayed on the desktop.

- [CAM\_SD] and [CAM\_HDD] are displayed on the desktop when using the **HDC-HS200**.
- Files are stored in [100CDPFQ]/[101CDPFR] folder etc. in the [DCIM] folder.

### 4 Using a drag-and-drop operation, move the pictures you want to acquire or the folder storing those pictures to any different folder on the PC.

## ■ To disconnect USB cable safely

Drag [CAM\_SD] disk icon to the [Trash], and then disconnect the USB cable.



- [CAM\_SD] and [CAM\_HDD] are displayed on the desktop when using the **HDC-HS200**.

\* **HDC-HS200** only**■ Recording indications**

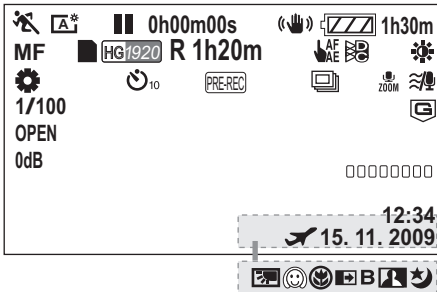
Motion picture recording mode

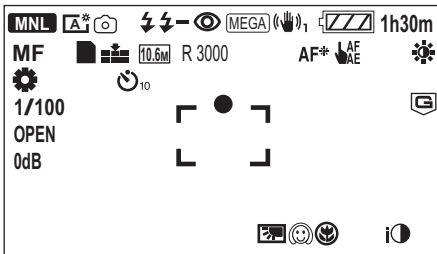

Still picture recording mode

 Remaining battery power  
(→ 22)

**1h30m** Remaining battery time (→ 22)

**R 1h20m** Remaining time for motion  
picture recording (→ 47)

**0h00m00s** Elapsed recording time (→ 47)

**15. 11. 2009** Date indication (→ 34)

**12:34** Time indication (→ 34)

World time setting (→ 36)

Motion picture recording mode  
(→ 48)

HA mode



HG mode



HX mode



HE mode



HDD recording possible status\*



(White) Card recording possible status

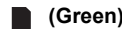

(Green) Recognising the card



Recording



Recording pause



PRE-REC (→ 49)



Manual mode (→ 73)

Intelligent auto mode (→ 42)



Normal mode



Portrait mode



Scenery mode



Spotlight mode



Low light mode



Night scenery mode



Night portrait mode



Macro mode



Manual focus (→ 76)

White balance (→ 74)



Auto white balance



Sunny mode



Cloudy mode



Indoor mode 1



Indoor mode 2



Manual adjustment mode

**1/100** Shutter speed (→ 75)













**OPEN, F2.0** Iris value (→ 75)

**0dB** Gain value (→ 75)



	Scene mode (→ 64)
	Sports mode
	Portrait mode
	Spotlight mode
	Snow mode
	Beach mode
	Sunset mode
	Fireworks mode
	Scenery mode
	Low light mode
	Night scenery mode
	Night portrait mode
	Power LCD (→ 37)
	Image stabilizer (→ 58)
	AF tracking (→ 59)
	Picture adjustment (→ 76)
	Digital cinema (→ 65)
	High-speed burst shooting (→ 70)
	Digital cinema colour (→ 67)
	AF assist lamp (→ 71)
	Zoom magnification indication (→ 57)
	Zoom microphone (→ 68)
	Focus microphone (→ 68)
	Wind noise reduction (→ 68)
	Microphone level (→ 69)
	Backlight compensation (→ 61)
	Soft skin mode (→ 61)
	Tele macro (→ 61)
	Fade (White), Fade (Black) (→ 61)
	Colour night view function (→ 61)

	Intelligent contrast control (→ 61)
	Intelligent exposure (→ 61)
	Focus indication (→ 50)
	Self-Timer recording (→ 62)
	Flash (→ 62)
	Flash level (→ 62)
	Red eye reduction (→ 62)
	Picture quality (→ 52)
	Number of recording pixels for still pictures (→ 52, 53, 70, 80)
	3520×2640
	3264×2448
	2560×1920
	640×480
	3984×2656
	3264×2176
	2592×1728
	4224×2376
	3840×2160
	3328×1872
	2560×1440
	1920×1080
	1280×720
	In playback mode, the picture size is not displayed for still pictures recorded with other products that have different picture sizes from the sizes shown above.
<b>R3000</b>	Remaining number of still pictures (→ 51)
	Still picture recording possible status
	Recording still picture
	MEGA OIS (→ 51)
	HDD Falling detection (→ 11)*



## ■ Playback indications

	Playback (→ 78, 85)
	Pause (→ 78, 85)
	Fast forward/rewind playback (→ 78)
	Last/first scene paused
	Skip playback (→ 78)
	Slow motion playback (→ 78)
	Frame-by-frame playback (→ 79) Next/Previous still picture (→ 85)
<b>0h00m00s</b>	Playback time
	Intelligent scene selection (→ 81)
<b>No.10</b>	Scene number
	Volume adjustment (→ 78)
	Repeat playback (→ 83)
	Resume playback (→ 83)
<b>100-0001</b>	Still picture folder/file name
<b>PictBridge</b>	When a printer compatible with PictBridge is connected (→ 111)
 <b>1</b>	DPOF already set (to more than 1) (→ 91)
	Protected motion pictures/still pictures (→ 90)









## ■ PC connection indications

	Accessing the card (When connected to a PC) (→ 121)
	Accessing the HDD (When connected to a PC) (→ 121)*

## ■ Confirmatory indications

<b>-- (Time display)</b>	The built-in battery is low. (→ 35)
	The warning/alarm indication appears when LCD monitor is rotated towards the lens side. Return the direction of the LCD monitor to normal position and check the warning/alarm indication.
	No SD card is inserted/unusable card.

## ■ Confirmatory indications when a DVD burner is connected

	Disc playback (→ 108)
	Scene copied in [Standard (XP)]
	Scene copied in [Standard (SP)]
	Disc type (→ 103)
	DVD-RAM
	DVD-RW
	DVD-R
	DVD-R DL (Dual layer on single side)
	Unusable disc

Major confirmation/error messages to be indicated on the screen in text.

**RECOMMEND DATA BACK UP PERIODICALLY.\***

We recommend backing up important recorded motion pictures and still pictures periodically to a PC, DVD disc etc. to protect it. This message does not indicate that there is a problem with this unit.

**HDD BACKUP RECOMMENDED.\***

There is a possible problem with the HDD. Copy the motion pictures and still pictures stored on the HDD to a PC or a DVD disc immediately (→ 103, 114), and detach the power and contact your dealer.

**HDD ERROR OCCURRED. PLEASE TURN UNIT OFF, THEN TURN ON AGAIN.\***

Access to HDD failed. Turn on the power again. Make sure not to give a strong shock or impact to the unit.

**CANNOT OPERATE DUE TO LOW TEMPERATURE.\***

The internal temperature of this unit is extremely low so it cannot be operated.

If "Please Wait." appears after this message, wait a while without turning the unit off. It may take time until the unit can be used.

**CHECK CARD.**

This card is not compatible or it cannot be recognised by the unit.

If this message appears even though motion pictures and still pictures are recorded on an SD card, the card may be unstable. Reinsert the SD card, then turn the power off and then on again.

**THIS BATTERY CANNOT BE USED.**

- Use a battery that is compatible with this unit. (→ 19)  
If using a Panasonic battery compatible with this unit, remove the battery and then insert it again. If the message appears even after repeating this several times, this unit needs repair. Detach the power and consult the dealer who you purchased this unit from. Do not attempt to repair it by yourself.
- You are attempting to connect an AC adaptor not compatible with this unit. Use the supplied AC adaptor. (→ 23)

**CANNOT CHECK CONNECTED DEVICE. DISCONNECT THE USB CABLE FROM THIS UNIT.**

- The DVD burner is not correctly connected.  
Disconnect and then reconnect the Mini AB USB Connection Cable.
- Connect a DVD burner that is compatible with this unit. (→ 103)

**PLEASE CHECK EXTERNAL DRIVE OR DISC.**

A disc that cannot be used when connecting the unit to the DVD burner has been inserted, or the DVD burner is not recognised properly. Connect the Mini AB USB Connection Cable again and insert a disc to copy the data. (→ 103)

## DISCONNECT USB CABLE.

The unit cannot correctly establish the connection to the PC, printer. Disconnect and then reconnect the USB cable.

\* **HDC-HS200** only

## About recovery



If faulty management information is found, one of the following messages may appear. Be sure to follow the messages. (Repairing may take time depending on the error.)

**CONTROL DATA ERROR HAS BEEN DETECTED. (SD CARD)**

**CONTROL DATA ERROR HAS BEEN DETECTED. (HDD)\***

**THUMBNAIL DATA ERROR IS DETECTED.**

\* **HDC-HS200** only

- The following message is displayed when abnormal management information is detected when the scenes are displayed in thumbnail. To perform the repair, touch the scene with  in the thumbnail, and start the playback. Please be aware that if the repair fails, scenes with  will be deleted.

**SOME SCENES NEED REPAIRING. PLAY SCENES TO BE REPAIRED. (IRREPARABLE SCENES WILL BE DELETED.)**

- Use a sufficiently charged battery or the AC adaptor.
- Depending on the condition of the data, it may not be possible to completely repair the data.
- When data recorded on another device is recovered, it may not be possible to play back the data on this unit or the other device.
- If recovery fails, turn the power of the unit off and on again after waiting a while. If recovery fails repeatedly, format a media on the unit. Please be aware that if a media is formatted, then all the data recorded on the media will be erased.
- If the thumbnail information is recovered, displaying the thumbnails may become slower.

# Functions that cannot be used simultaneously

Some functions in this unit are disabled or cannot be selected due to the unit's specifications.

Functions	Conditions which disable the functions
<b>Motion picture recording</b>	<ul style="list-style-type: none"> <li>• When the hi-speed burst shooting mode is on</li> </ul>
<b>PRE-REC</b>	<ul style="list-style-type: none"> <li>• When the hi-speed burst shooting mode is on</li> </ul>
<b>Intelligent auto mode</b>	<ul style="list-style-type: none"> <li>• In manual mode</li> <li>• When the colour night view function is used</li> <li>• When the digital cinema is used</li> <li>• When the hi-speed burst shooting mode is on</li> </ul>
<b>AF tracking</b>	<ul style="list-style-type: none"> <li>• When the digital cinema is used</li> <li>• When the scene mode is used in motion picture recording mode</li> <li>• When the fireworks mode of scene mode is used in still picture recording mode</li> </ul>
<b>Scene mode</b>	<ul style="list-style-type: none"> <li>• When the colour night view function is used</li> <li>• When the hi-speed burst shooting mode is on</li> </ul>
<b>Digital zoom</b>	<ul style="list-style-type: none"> <li>• When the digital cinema is used</li> <li>• When the hi-speed burst shooting mode is on</li> </ul>
<b>Guide lines</b>	<ul style="list-style-type: none"> <li>• When the Intelligent auto mode is on.</li> <li>• When the AF tracking is used</li> </ul>
<b>Change of recording mode</b>	<ul style="list-style-type: none"> <li>• When the hi-speed burst shooting mode is on</li> </ul>
<b>Digital cinema</b>	<ul style="list-style-type: none"> <li>• When the motion picture recording mode is HX/HE</li> <li>• When the digital zoom is set to [30×] or [700×]</li> <li>• When the hi-speed burst shooting mode is on</li> <li>• When the AF tracking is used</li> <li>• When the Intelligent auto mode is on</li> </ul>
<b>Fade</b>	<ul style="list-style-type: none"> <li>• When PRE-REC is used</li> <li>• When the hi-speed burst shooting mode is on</li> </ul>
<b>AGS</b>	<ul style="list-style-type: none"> <li>• When the hi-speed burst shooting mode is on</li> </ul>
<b>Auto slow shutter</b>	<ul style="list-style-type: none"> <li>• When the hi-speed burst shooting mode is on</li> <li>• When the scene mode is used</li> <li>• In still picture recording mode</li> </ul>
<b>Backlight compensation</b>	<ul style="list-style-type: none"> <li>• When the colour night view function is used</li> <li>• When the iris/gain is set</li> </ul>
<b>Intelligent contrast control</b>	<ul style="list-style-type: none"> <li>• When the colour night view function is used</li> <li>• When the iris/gain is set</li> </ul>
<b>Intelligent exposure</b>	<ul style="list-style-type: none"> <li>• When the scene mode is used</li> <li>• When the iris/gain is set</li> </ul>
<b>Soft skin mode</b>	<ul style="list-style-type: none"> <li>• When the Intelligent auto mode is on</li> </ul>

<b>Functions</b>	<b>Conditions which disable the functions</b>
<b>Tele macro</b>	<ul style="list-style-type: none"> <li>● When the sunset, fireworks, night scenery or scenery mode of scene mode is used</li> </ul>
<b>Colour night view</b>	<ul style="list-style-type: none"> <li>● When the hi-speed burst shooting mode is on</li> <li>● When the digital cinema is used</li> <li>● When the AF tracking is used</li> <li>● In still picture recording mode</li> </ul>
<b>Soft skin mode (Set and cancel)</b>	<ul style="list-style-type: none"> <li>● While recording</li> <li>● When PRE-REC is used</li> </ul>
<b>Tele macro (Set and cancel)</b>	
<b>Colour night view (Set and cancel)</b>	
<b>Digital cinema colour</b>	
<b>Digital cinema colour</b>	<ul style="list-style-type: none"> <li>● When the colour night view function is used</li> <li>● When the hi-speed burst shooting mode is on</li> </ul>
<b>Shooting guide</b>	<ul style="list-style-type: none"> <li>● When the AF tracking is used</li> </ul>
<b>Wind noise reduction</b>	<ul style="list-style-type: none"> <li>● When the hi-speed burst shooting mode is on</li> </ul>
<b>Microphone setup</b>	
<b>Microphone level</b>	
<b>MF assist function</b>	
<b>Hi-speed burst shooting mode</b>	<ul style="list-style-type: none"> <li>● When the digital zoom is set to [30×] or [700×]</li> <li>● When the AF tracking is used</li> <li>● When the Intelligent auto mode is on</li> </ul>
<b>Flash</b>	<ul style="list-style-type: none"> <li>● While recording motion pictures</li> <li>● When PRE-REC is used</li> <li>● When the colour night view function is used</li> <li>● When the hi-speed burst shooting mode is on</li> <li>● When the sunset, fireworks or night scenery mode of scene mode is used.</li> </ul>
<b>AF assist lamp</b>	<ul style="list-style-type: none"> <li>● When the fireworks mode of scene mode is used</li> <li>● In manual focus mode</li> </ul>
<b>Shutter sound</b>	<ul style="list-style-type: none"> <li>● While recording motion pictures</li> <li>● When PRE-REC is used</li> </ul>
<b>Change of white balance</b>	<ul style="list-style-type: none"> <li>● When digital zoom (12× or higher) is used</li> <li>● When the colour night view function is used</li> <li>● When the beach, sunset, fireworks, night scenery or night portrait mode of scene mode is used</li> </ul>
<b>Adjusting the shutter speed, iris/gain</b>	<ul style="list-style-type: none"> <li>● When the colour night view function is used</li> <li>● When the scene mode is used</li> <li>● When the hi-speed burst shooting mode is on</li> </ul>

# Troubleshooting

## Problem

**This unit cannot be turned on.**

**This unit does not stay on long enough.**

**Battery runs down quickly.**

**This unit is turned off automatically.**

**A clicking sound is heard when the unit is shaken about.**

**Remaining battery indication is not displayed properly.**

**The built-in flash does not function.**

## Check points

- Charge the battery using the AC adaptor. (→ 19)
- The battery protection circuit may have operated. Attach the battery to the AC adaptor for 5 to 10 seconds. If the unit still cannot be used, the battery is faulty.
- The battery is affected by ambient temperature. In cold places, the battery using time becomes shorter.
- The battery has a limited life. If the operating time is still too short even after the battery is fully charged, the battery has worn out and needs to be replaced.

- If you connect to a TV compatible with VIERA Link with a HDMI mini cable and turn off the power on the TV with the remote control for the TV, the power on this unit also turns off. If you are not using VIERA Link, set [VIERA Link] to [OFF]. (→ 100)
- When this unit is connected to a DVD burner to copy or play back images (a disc is being accessed), the power turns off automatically if the Mini AB USB Connection Cable is removed.

- This is the sound of the lens moving and is not a defect. This sound will no longer be heard when the unit's power is turned on.

- The remaining battery capacity indication is an approximation. If you think the remaining battery capacity indication is not displayed correctly, fully charge the battery, discharge it and then charge it again. (Even if this operation is performed, it may not be possible to display the remaining battery capacity correctly if the battery was used for a long period of time where the temperature was low or high or if the battery was repeatedly charged.)

- The flash cannot be used while using the battery VW-VBG070. Use the batteries that are compatible with this unit. (→ 19)

## Problem

**This unit cannot be operated though it is turned on.**

**This unit does not operate normally.**

▶▶▶

**Recording does not start although power is supplied to this unit and the SD card is correctly inserted.**

▶▶▶

**Item other than the touched one is selected.**

▶▶▶

**The remote control does not function.**

▶▶▶

**The remaining time indication or the elapsed time indication is not shown.**

▶▶▶

**The unit arbitrarily stops recording.**

▶▶▶

## Check points

- Turn on the power again. If normal conditions are not restored yet, remove the battery or AC adaptor, wait about 1 minute and then reconnect the battery or AC adaptor. Then about 1 minute later, turn on the power again. (Conducting the above operation while the media is being accessed may damage the data on the media.)
- If normal operation is still not restored, detach the power connected, and consult the dealer who you purchased this unit from.





- A message is displayed and you cannot record when the HDD does not operate normally due to the temperature of the unit being too high or low, or when the SD card cover cannot be closed due to failure of the SD card cover. In this case, press the recording start/stop button to display the media change message, allowing you to change the recording media.

- Calibrate the touch screen. (→ 38)

- Remote control cannot be operated when the [REMOTE CONTROL] is set to [OFF].
- The button-type battery of the remote control may be run out. Replace it with a new button-type battery. (→ 39)

- If you set [SETUP] → [DISPLAY] → [OFF], indications other than warnings and date etc. are not displayed. (→ 31)

- Use an SD card that can be used for motion picture recording. (→ 24) When the unit stops while a usable SD card for recording motion pictures (→ 24) is used, the data writing rate has deteriorated. We recommend formatting the SD card being used. (→ 95)
- If [AGS] is [ON], record in the normal horizontal position or set [AGS] to [OFF]. (→ 66)
- **HDC-HS200**  
If the unit is exposed to strong vibrations or shocks while recording on HDD, recording may stop to protect the HDD. If the unit is used in a place with loud sounds, the recording may stop due to sound vibrations. Recording data on an SD card is recommended in these places.
- Many repeated recording and deletion of motion pictures may reduce the usable time for recording on a media you use. In that case, format the media.

Problem	Check points
<p><b>AF tracking does not work when the object is touched.</b></p>	<ul style="list-style-type: none"> <li>• Touch the part of the object that has specific colour such as the part that is different from the surrounding. (→ 59)</li> </ul>
<p><b>Auto focus function does not work.</b></p>	<ul style="list-style-type: none"> <li>• Set to Intelligent auto mode to on or off.</li> <li>• If you are trying to record a scene which is hard to bring into focus in auto focus mode, use the manual focus mode to adjust the focus. (→ 42, 76)</li> </ul>
<p><b>Colour balance of images is strange when recording in a place such as a gymnasium.</b></p>	<ul style="list-style-type: none"> <li>• In a place with multiple light sources, such as a gymnasium or a hall, set the white balance setting to  (Indoor mode2). If you cannot record clearly with the  (Indoor mode2), set it to  (Manual adjustment mode). (→ 74)</li> </ul>
<p><b>Some playback images are skipped automatically.</b></p> <p><b>Scene does not play back to the end.</b></p>	<ul style="list-style-type: none"> <li>• Playback of  (Intelligent scene selection) is set. Return to normal playback. (→ 81)</li> </ul>
<p><b>Although this unit is correctly connected to a TV, images cannot be seen.</b></p> <p><b>The images are squeezed horizontally.</b></p>	<ul style="list-style-type: none"> <li>• Please read the operating instructions of your TV and select the channel that matches the input used for the connection.</li> <li>• Change the [TV ASPECT] setting to match the aspect ratio of the TV.</li> <li>• Change the setting of the unit depending on the cable connecting to the TV. (→ 96, 98)</li> </ul>
<p><b>Scenes cannot be deleted.</b></p>	<ul style="list-style-type: none"> <li>• Release the protect setting. (→ 90)</li> <li>• Any scenes/still pictures where the thumbnails are displayed as  cannot be deleted. If the scenes/still pictures are unnecessary, format the media to erase the data. (→ 95) Please be aware that if a media is formatted then all the data recorded on the media is erased and cannot be recovered. Back up important data on a PC, disc etc.</li> </ul>
<p><b>If the SD card is inserted in this unit, it is not recognised.</b></p>	<ul style="list-style-type: none"> <li>• If the SD card is formatted on a PC, it may not be recognised by this unit. Use this unit to format SD cards. (→ 95)</li> </ul>

## Problem

If the SD card is inserted in another device, it is not recognised.



Colour or brightness of the image changes, or you may see horizontal bars in the image.

The LCD monitor flickers indoors.



Object seems to be warped.



White round spots like soap bubbles appear on the recorded picture.



**“ERROR OCCURRED. PLEASE TURN UNIT OFF, THEN TURN ON AGAIN.”** is displayed.



## Check points

- Check that the device is compatible with the capacity or type of SD card (SD Memory Card/SDHC Memory Card) that you inserted. Refer to the operating instructions of the device for details.

(In motion picture recording mode)

- Colour or brightness of the image may change, or you may see horizontal bars in the image when the object is recorded under fluorescent light, mercury light or sodium light, etc., but this is not a malfunction. Record in auto mode or set the shutter speed to 1/100 in areas where the power supply frequency is 50 Hz, or 1/125 in areas of 60 Hz.

(In still picture recording mode)

- This is a characteristics of the MOS sensor, which is the imaging device of the unit. This is not a malfunction. This will not affect the recorded image.



- Object seems to be warped slightly when the object moves across the image very fast, but this is because the unit is using MOS for the image sensor. This is not a malfunction.

- If you take a picture with the flash in a dark place or indoors, white round spots may appear on the picture caused by the flash reflecting of particles of dust in the air. This is not a malfunction.



A characteristic of this is that the number of round spots and their position differ in every picture.

- The unit has automatically detected an error. Restart the unit by turning off and on the power.
- The power will be turned off in about 1 minute if the power is not turned off and on.
- Repair is needed if it is repeatedly displayed even if it is restarted. Detach the power connected, and consult the dealer who you purchased this unit from. Do not attempt to repair the unit by yourself.

Problem	Check points
<p><b>VIERA Link does not work.</b></p>	<p>[Setting on this unit]</p> <ul style="list-style-type: none"> <li>• Connect with a HDMI mini cable (optional). (→ 100)</li> <li>• Press the MENU button, then touch [SETUP] → [VIERA Link] → [ON]. (→ 100)</li> <li>• Turn the power to the unit off and then back on again.</li> </ul> <p>[Setting on other devices]</p> <ul style="list-style-type: none"> <li>• Depending on HDMI terminal of the TV, the input channel may not switch automatically. In this case, use the remote control for the TV to switch input. (For details on how to switch input, please read the operating instructions for the TV.)</li> <li>• Check the VIERA Link setting on the connected device.</li> <li>• Set the setting to control the VIERA Link of the TV to [Off] once, and the back to [On] again. (Refer to the operating instructions of the TV for details.)</li> </ul>
<p><b>When connected by the USB cable, this unit is not detected by the PC.</b></p>	<ul style="list-style-type: none"> <li>• Select another USB terminal on the PC.</li> <li>• Check the operating environment. (→ 117)</li> <li>• Connect the supplied USB cable again after restarting the PC and turning on this unit again.</li> </ul>
<p><b>When the USB cable is disconnected, an error message will appear on the PC.</b></p>	<ul style="list-style-type: none"> <li>• To disconnect the USB cable safely, double-click the  (  ) icon in the task tray and follow the instructions on the screen.</li> </ul>
<p><b>The power of the DVD burner cannot be turned on.</b></p>	<ul style="list-style-type: none"> <li>• When the unit is connected to the DVD burner, use the respective AC adaptors for both this unit and the DVD burner.</li> </ul>
<p><b>Cannot see the PDF operating instructions for HD Writer AE 1.0.</b></p>	<ul style="list-style-type: none"> <li>• You will need Adobe Acrobat Reader 5.0 or later or Adobe Reader 7.0 or later to read the PDF operating instructions for HD Writer AE 1.0.</li> </ul>
<p><b>Cannot copy scenes on the SD card by connecting to other equipment with the USB cable.</b></p>	<ul style="list-style-type: none"> <li>• Other equipment might have not recognised the SD card. Unplug the USB cable once, and reconnect it.</li> </ul>

## ■ If scenes do not change smoothly when played back on another device

The images may be still for several seconds at the joins between the scenes if the following operations are performed when multiple scenes have been continuously played back using another unit.

- Just how smoothly the scenes will be played back depends on the playback unit. Depending on the unit used, the images may stop moving and become still for a moment even when none of the following conditions are applicable.
- It may not play back smoothly when the editing of scenes was done with the HD Writer AE 1.0, but it will play back smoothly if you set [Seamless settings] in the HD Writer AE 1.0. Refer to the operating instructions for the HD Writer AE 1.0.

---

## ■ When the scenes were recorded on different dates

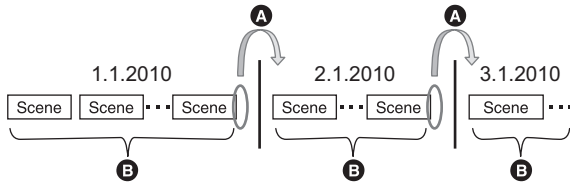

- A** The image will be still for several seconds wherever the date changes.
- B** The images are played back smoothly if the scenes were recorded on the same date.

## ■ When scenes lasting under 3 seconds have been recorded

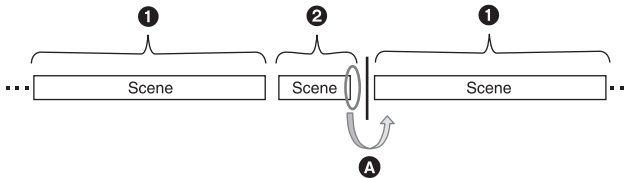

- 1** 3 or more seconds
- 2** Under 3 seconds
- A** The image will be still for several seconds after a scene which lasts under 3 seconds.

## ■ When PRE-REC was used for recording

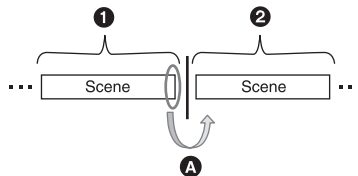

- 1** Normal recording
- 2** PRE-REC recording
- A** The picture momentarily stops at the end of the last scene that was recorded normally before PRE-REC recording.

## ■ When deleting scenes

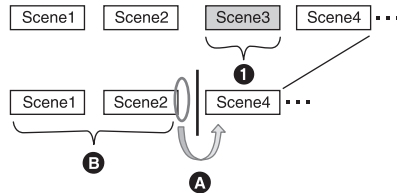

- ❶ Scene to be deleted
- ❷ The image will be still for several seconds wherever a scene was deleted.
- ❸ The images of consecutive scenes where they are no deletions are played back smoothly one after another.

## ■ When selected scenes are copied between an SD card and HDD or when selected scenes are copied to a disc in a connected DVD burner.

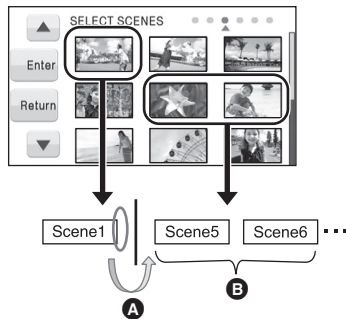

- ❷ If you select a scene other than the next scene, the picture may momentarily stop at the point where the scenes switch.
- ❸ The point where the scenes switch will be played back smoothly if you select the scenes in order.

## ■ Other cases

- If you record more than 99 scenes in the same date, scenes will be still for a few seconds at the switch of the scene per 99 scenes.
- When the recording mode was changed from HA/HG/HX to HE or from HE to HA/HG/HX, the picture momentarily stops where the scenes switch between HA/HG/HX and HE modes.

# Cautions for use

## About this unit

The unit and the SD card become warm during use. This is not a malfunction.

**Keep the High Definition Video Camera as far away as possible from electromagnetic equipment (such as microwave ovens, TVs, video games etc.).**

- If you use the High Definition Video Camera on top of or near a TV, the pictures and sound on the High Definition Video Camera may be disrupted by electromagnetic wave radiation.
- Do not use the High Definition Video Camera near cell phones because doing so may result in noise adversely affecting the pictures and sound.
- Recorded data may be damaged, or pictures may be distorted, by strong magnetic fields created by speakers or large motors.
- Electromagnetic wave radiation generated by microprocessors may adversely affect the High Definition Video Camera, disturbing the pictures and sound.
- If the High Definition Video Camera is adversely affected by electromagnetic equipment and stops functioning properly, turn the High Definition Video Camera off and remove the battery or disconnect AC adaptor. Then reinsert the battery or reconnect AC adaptor and turn the High Definition Video Camera on.

**Do not use the High Definition Video Camera near radio transmitters or high-voltage lines.**

- If you record near radio transmitters or high-voltage lines, the recorded pictures and sound may be adversely affected.

**Make sure to use the supplied cords and cables. If you use optional accessories, use the cords and the cables supplied with them. Do not extend the cords and the cables.**

**Do not spray insecticides or volatile chemicals onto the unit.**

- If the unit is sprayed with such chemicals, its body may be marred and the surface finish may peel off.
- Do not leave rubber or plastic products in contact with the unit for a long time.

**When you use the unit in a sandy or dusty place such as a beach, do not let sand or fine dust get into the body and terminals of the unit.**

**Also, keep the unit away from sea water.**

- Sand or dust may damage the unit. (Care should be taken when inserting and removing a card.)
- If sea water splashes onto the unit, wipe off the water with a well wrung cloth. Then wipe the unit again with a dry cloth.

**When carrying the unit, do not drop or bump it.**

- A strong impact can break the unit's casing, causing it to malfunction.

## Cleaning

- Before cleaning, detach the battery or pull the AC cable from the AC outlet, and then wipe the unit with a soft, dry cloth.
- If the unit is very dirty, dip a cloth in water and squeeze firmly, and then wipe the unit with the damp cloth. Next, dry the unit with a dry cloth.
- Use of benzine, paint thinner, alcohol, or dishwashing liquid may alter the camera body or peel the surface finish. Do not use these solvents.
- When using a chemical dust cloth, follow the instructions that came with the cloth.

**Do not use the unit for surveillance purposes or other business uses.**

- This unit was designed for consumer intermittent use. It was not intended for continuous use, or for any industrial or commercial application resulting in prolonged use.
- In certain situations, continuous use could cause the unit to overheat and cause a malfunction. Such use is strongly discouraged.

## When you are not going to use the unit for an extended time

- When storing the unit in a cupboard or cabinet, it is recommended that you place a desiccant (silica gel) in with it.

### HDC-HS200

## When disposing of or giving away this unit, note that:

- Formatting and deletion simply change the file management information and cannot be used to completely erase the data in HDD of this unit. The data can be recovered using commercially available software or the like.
- We recommend that you physically format the HDD before disposing of or giving away this unit.
- To physically format the HDD, connect the unit via the AC adaptor, select [FORMAT HDD] → [YES] from the menu, and then press and hold the delete button on the screen below for about 3 seconds. When the HDD data deletion screen appears, select [YES], and then follow the on-screen instructions.

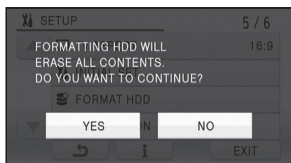

- Please look after the data in your HDD carefully. Panasonic will not be held responsible in the unlikely case that private data is divulged.

## About the battery

The battery used in this unit is a rechargeable lithium-ion battery. It is susceptible to humidity and temperature and the effect increases the more the temperature rises or falls. In cold areas, the full charge indication may not appear or the low battery indication may appear about 5 minutes after starting use. At high temperatures, the protection function may be triggered, making it impossible to use the unit.

### Be sure to detach the battery after use.

- If the battery is left attached, a minute amount of current continues to flow even if the unit's power is off. Keeping the unit in this state may result in over discharge of the battery. This may result in you not being able to use the battery even after it is charged.
- The battery should be stored in the vinyl bag so metal does not come into contact with the terminals.
- The battery should be stored in a cool place free from humidity, with as constant temperature as possible. (Recommended temperature: 15 °C to 25 °C, Recommended humidity: 40% to 60%)
- Extremely high temperatures or low temperatures will shorten the life of the battery.
- If the battery is kept in high-temperature, high-humidity, or oily-smoky places, the terminals may rust and cause malfunctions.
- To store the battery for a long period of time, we recommend you charge it once every year and store it again after you have completely used up the charged capacity.
- Dust and other matter attached to the battery terminals should be removed.

### Prepare spare batteries when going out for recording.

- Prepare batteries appropriate to 3 to 4 times the period you are planning to record for. Cold places such as a ski resort can shorten the period which you can record for.

### If you drop the battery accidentally, check to see if the terminals are damaged.

- Attaching a battery with damaged terminals can damage the unit or AC adaptor.

### **Do not throw old battery into fire.**

- Heating a battery or throwing it into a fire may result in an explosion.

**If the operating time is very short even after the battery has been recharged, the battery has worn out. Please purchase a new battery.**

### **About the AC adaptor**

- If the temperature of the battery is extremely high or extremely low, charging may take time or the battery may not be charged.
- If the charging lamp keeps flashing, make sure that the terminals of the battery or the AC adaptor are not exposed to dirt, foreign objects or dust, then reconnect them properly. Disconnect the AC cable from the AC outlet when you remove dirt, foreign objects or dust on the terminals of the battery or the AC adaptor. If the charging lamp is still flashing, the temperature of the battery may be extremely high or extremely low or something may be wrong with the battery or AC adaptor. Contact your dealer.
- If you use the AC adaptor near a radio, radio reception may be disturbed. Keep the AC adaptor 1 m or more away from the radio.
- When using the AC adaptor, it may generate whirring sounds. However, this is normal.
- After use, be sure to disconnect the AC adaptor. (If it is left connected, a minute amount of current is consumed.)
- Always keep the electrodes of the AC adaptor and battery clean.

### **LCD monitor**

- When the LCD monitor gets dirty, wipe it with a soft cloth, such as eye glass cleaner.
- In a place with drastic temperature changes, condensation may form on the LCD monitor. Wipe it with a soft cloth, such as eye glass cleaner.
- When the unit has become very cold, for example due to storage in a cold area, its LCD monitor will be slightly darker than usual immediately after the power is turned on. The normal brightness will be restored when the unit's internal temperature rises.

Extremely high precision technology is employed to produce the LCD Monitor screen featuring a total of approximately 230,000 pixels. The result is more than 99.99% effective pixels with a mere 0.01% of the pixels inactive or always lit. However, this is not a malfunction and does not affect the recorded picture.

### **About condensation**

When condensation forms on the unit, the lens will cloud up and the unit may not work properly. Make every effort to ensure that condensation does not form. If it does form, take the actions described below.

### **Causes of condensation**

**Condensation takes place when the ambient temperature or humidity is changed as follows.**

- When this unit is brought inside from the cold (e.g. a ski slope) to a warm room.
- When this unit is moved from an air-conditioned car to outside.
- When a cold room has been warmed up quickly.
- When cool wind from an air conditioner is directly blown onto this unit.
- After summer afternoon showers of rain.
- When this unit is in a very humid place where the air is thick with steam. (e.g. a heated swimming pool)

### **Helpful hint**

If, for example, you have used this unit for recording on a ski slope and are taking it into a heated room, place the unit inside a plastic bag, remove as much of the air from inside the bag as possible, then seal the bag. Leave the unit for about an hour in the room so the temperature of the unit is close to the ambient temperature of the room, then use it.

# Specifications

## High Definition Video Camera

Information for your safety

<b>Power source:</b>	DC 9.3 V (When using AC adaptor) DC 7.2 V (When using battery)
<b>Power consumption:</b>	Recording: <div style="border: 1px solid black; padding: 2px; display: inline-block;">HDC-SD200</div> 6.4 W <div style="border: 1px solid black; padding: 2px; display: inline-block;">HDC-HS200</div> 7.4 W

	HDC-SD200	HDC-HS200
<b>Signal system</b>	1080/50i	
<b>Recording format</b>	AVCHD format compliant	
<b>Image sensor</b>	1/4.1" 3MOS image sensor Total: 3050 K×3 Effective pixels: Motion picture: 2070 K×3 (16:9) Still picture: 2320 K×3 (4:3), 2650 K×3 (3:2), 2510 K×3 (16:9)	
<b>Lens</b>	Auto Iris, F1.8 to F2.8 Focal length: 4 mm to 48 mm Macro (Full range AF) 35 mm equivalent: Motion picture: 44.9 mm to 539 mm (16:9) Still picture: 45 mm to 540 mm (4:3) 41.3 mm to 496 mm (3:2) 40.8 mm to 490 mm (16:9) Minimum focus distance: Normal: approx. 4 cm (Wide)/approx. 1.2 m (Tele) Tele macro: approx. 60 cm (Tele) Intelligent auto Macro: approx. 1 cm (Wide)/approx. 60 cm (Tele)	
<b>Filter diameter</b>	43 mm	
<b>Zoom</b>	12× optical zoom, 30×/700× digital zoom	
<b>Monitor</b>	2.7" wide LCD monitor (approx. 230 K pixels)	
<b>Microphone</b>	5.1 channel surround microphone (with a zoom microphone/focus microphone function)	
<b>Speaker</b>	1 round speaker, dynamic type	
<b>White balance adjustment</b>	Auto tracking white balance system	
<b>Standard illumination</b>	1,400 lx	

		HDC-SD200	HDC-HS200
<b>Minimum required illumination</b>		Approx. 1.6 lx (1/25 in low light mode) Approx. 1 lx with the colour night view function	
<b>AV terminal video output level</b>		1.0 Vp-p, 75 Ω, PAL system	
<b>Component terminal video output level</b>		Y: 1.0 Vp-p, 75 Ω Pb: 0.7 Vp-p, 75 Ω Pr: 0.7 Vp-p, 75 Ω	
<b>HDMI mini connector video output level</b>		HDMI™ (V.1.3a with x.v.Colour™) 1125i (1080i)/625p (576p)	
<b>AV terminal audio output level (Line)</b>		316 mV, 600 Ω, 2 ch	
<b>HDMI mini connector audio output</b>		5.1 ch (AC3)/2 ch (Linear PCM)	
<b>USB</b>	<b>SD card</b>	Read only (No copyright protection support)	
	<b>HDD</b>	–	Read only
		Hi-Speed USB (USB 2.0), USB terminal Type Mini AB PictBridge-compliant	
<b>Flash</b>		Available range: Approx. 1.0 m to 2.5 m	
<b>Dimensions</b>		68 mm (W)×68 mm (H)×132 mm (D) (excluding projecting parts)	69 mm (W)×73 mm (H)×128 mm (D) (excluding projecting parts)
<b>Mass</b>		Approx. 335 g [without battery (supplied) and an SD card (optional)]	Approx. 420 g [without battery (supplied)]
<b>Mass in operation</b>		Approx. 397 g [with battery (supplied) and an SD card (optional)]	Approx. 480 g [with battery (supplied)]
<b>Operating temperature</b>		0 °C to 40 °C	
<b>Operating humidity</b>		10% to 80%	
<b>Battery operation time</b>		See page 21	

## Motion pictures

		HDC-SD200	HDC-HS200
Recording media	SD card	<b>SD Memory Card:</b> 1 GB, 2 GB (FAT12 and FAT16 system compliant) <b>SDHC Memory Card:</b> 4 GB, 6 GB, 8 GB, 12 GB, 16 GB, 32 GB (FAT32 system compliant)	
	HDD	–	80 GB
Compression		MPEG-4 AVC/H.264	
Recording mode and transfer rate		HA: Approx. 17 Mbps (VBR) HG: Approx. 13 Mbps (VBR) HX: Approx. 9 Mbps (VBR) HE: Approx. 6 Mbps (VBR) Refer to page 48 for the recordable time.	
Picture size		HA/HG: 1920×1080/50i HX: 1920×1080/50i HE: 1440×1080/50i	
Audio compression		Dolby Digital (Dolby AC3)/5.1 ch	

## Still pictures

		HDC-SD200	HDC-HS200
Recording media	SD card	<b>SD Memory Card:</b> 8 MB, 16 MB, 32 MB, 64 MB, 128 MB, 256 MB, 512 MB, 1 GB, 2 GB (FAT12 and FAT16 system compliant) <b>SDHC Memory Card:</b> 4 GB, 6 GB, 8 GB, 12 GB, 16 GB, 32 GB (FAT32 system compliant)	
	HDD	–	80 GB
Compression		JPEG (Design rule for Camera File system, based on Exif 2.2 standard), DPOF corresponding	
Picture size		Picture aspect [4:3]: 3520×2640/3264×2448/2560×1920/640×480 Picture aspect [3:2]: 3984×2656/3264×2176/2592×1728 Picture aspect [16:9]: 4224×2376/3840×2160/3328×1872/2560×1440/1920×1080 Refer to page 54 for the number of recordable pictures.	

## AC adaptor

Information for your safety

<b>Power source:</b>	AC 110 V to 240 V, 50/60 Hz
<b>Power consumption:</b>	19 W
<b>DC output:</b>	DC 9.3 V, 1.2 A (Unit operation) DC 8.4 V, 0.65 A (Battery charging)

<b>Dimensions</b>	92 mm (W)×33 mm (H)×61 mm (D)
<b>Mass</b>	Approx. 115 g

Specifications may change without prior notice.

# Index

## ■ Numerics

5.1 channel ..... 99

## ■ A

A/V terminal ..... 14, 17, 96, 110

AC adaptor ..... 19, 23, 142

AF assist lamp ..... 71

AF tracking ..... 59

Alert sound ..... 32

Anti-Ground-Shooting (AGS) ..... 66

Aspect ratio ..... 52

Auto focus ..... 44

Auto slow shutter ..... 66

Automatic face framing ..... 67

Automatic white balance ..... 43

AVCHD ..... 10

## ■ B

Backlight compensation ..... 61

Battery ..... 19, 141

Battery capacity indication ..... 22

## ■ C

Card ..... 24

Charging time ..... 21

Colour night view ..... 61

Component terminal ..... 14, 17, 96

Copy

    Disc ..... 105

    From HDD to SD card ..... 93

    From SD card to HDD ..... 93

Creating still picture from motion picture ..... 80

## ■ D

Date and time display ..... 34

Date and time setting ..... 34

Delete ..... 87

Demo mode ..... 32

Digital cinema ..... 65

Digital cinema colour ..... 67

Digital zoom ..... 57

Display ..... 31

Dividing a scene to delete ..... 89

DPOF setting ..... 91

Dubbing ..... 110

DVD burner ..... 103

## ■ E

Economy ..... 31

Extra optical zoom ..... 57

## ■ F

Fade ..... 61

Flash ..... 62

Focus ..... 50, 76

Focus microphone ..... 68

Formatting ..... 95, 109

Frame-by-frame playback ..... 79

## ■ G

Gain ..... 75

Grip belt ..... 15, 18

Guide line ..... 65

## ■ H

HDD ..... 11

HDD information display ..... 92

HDMI mini connector ..... 14, 17, 96, 100

High definition ..... 10

Highlight playback ..... 82

Highlight&Time frame index ..... 80

Hi-speed burst shooting mode ..... 70

## ■ I

Indications ..... 126

Initial setting ..... 32

Intelligent auto (iA) mode ..... 42

Intelligent contrast control ..... 61

Intelligent exposure ..... 61

Intelligent scene selection ..... 81

Iris ..... 75

## ■ L

Language ..... 30

LCD monitor ..... 13, 16, 37, 142

Lens cap ..... 14, 17

Lens hood ..... 14, 17

## ■ M

Manual focus ..... 76

Manual focus adjustment ..... 76

Menu ..... 29

MF assist ..... 76

Microphone level ..... 69

Microphone setup ..... 68

Mode dial ..... 26

Motion picture compatibility ..... 79

## ■ N

Number of recordable pictures ..... 54

## ■ O

Operation icons ..... 60

Optical image stabilizer ..... 58

<b>■ P</b>	
PictBridge	111
Picture adjustment	76
Picture quality	52
Picture size	52
Playing back motion pictures by date	81
Playing back still pictures by date	86
Power LCD	37
PRE-REC	49
Protect	90
<b>■ Q</b>	
Quick power on	45
Quick start	44
<b>■ R</b>	
Recordable time	21, 48
Recording lamp	31
Recording modes	48
Recording time elapsed	47
Recovery	130
Red eye reduction	62
Remaining number of still pictures	51
Remaining time left for recording	47
Remote control	39
Repeat playback	83
Resume playback	83
<b>■ S</b>	
Scene mode	64
SD card information display	92
SD Memory Card	24
SD Speed Class Rating	24
SDHC Memory Card	24
Self-recording	38
Self-timer recording	62
Shooting guide	49
Shoulder strap fixture	15, 18
Shutter sound	71
Shutter speed	75
Simultaneous recording	53
Skip playback	78
Slide show	85
Slow-motion playback	78
Soft skin mode	61
Still picture compatibility	86
Stylus pen	28
Surround microphone	68
<b>■ T</b>	
Tele macro	61
Touch screen	28
Touch screen calibration	38
Tripod receptacle	15, 18
<b>■ V</b>	
VIERA Link	100
Volume adjustment	78
<b>■ W</b>	
White balance	74
Wind noise reduction	68
World time setting	36
<b>■ Z</b>	
Zoom	57
Zoom microphone	68



VQT1Y50  
F0109MA0 ( 1500 (A) )



**Panasonic Corporation**  
Web site: <http://panasonic.net>

Pursuant to at the directive 2004/108/EC, article 9(2)  
Panasonic Testing Centre  
Panasonic Marketing Europe GmbH  
Winsbergring 15, 22525 Hamburg, Germany