

Panasonic®

Model No.
TX-L26X20B

Operating Instructions LCD Television

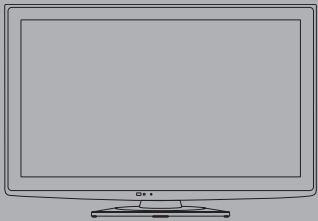

VIERA



Thank you for purchasing this Panasonic product.
Please read these instructions carefully before operating this product and retain them for future reference.
The images shown in this manual are for illustrative purposes only.
“B” model no. suffix denotes UK model.

English

U.K. Standard



TQB0E0955

Features

■ DVB-T tuner built-in

Receives DVB (Digital Video Broadcasting) digital terrestrial broadcasts

Easily select the programme or set Timer Programming by using TV Guide. (p. 18 - 20)

Instantly call up favourite channels with Favourites Edit. (p. 39)

■ GUIDE Plus+ (p. 18)

This TV supports Gemstar-TV Guide sent from the GUIDE Plus+ system.

■ Sharp pictures and clear sound with HDMI connection (p. 68)

Enjoy high definition digital picture and high quality sound by using an HDMI cable.

- This TV incorporates HDMI (Version 1.4 with Audio Return Channel) technology.

■ VIERA IMAGE VIEWER - Media Player (p. 50 - 53)

Enjoy your photos or videos recorded on an SD Card on the TV screen.

■ SDXC Card

This TV supports SDXC Card. SDXC is the latest standard of SD Card and a higher storage capacity card.

■ AVCHD

It is possible to play moving pictures recorded on an SD Card in AVCHD format.

AVCHD is a high definition video recording format. (p. 52)

■ Dolby Digital decoder

It is possible to decode Dolby Digital audio track (multi-channel sound) and output as a Dolby Digital multi-channel sound signal from the DIGITAL AUDIO OUT terminal.

■ Link up and control the connected equipment with “Q-Link” and “VIERA Link” (p. 56 - 63)

Q-Link and VIERA Link provide easy recording and playback, creation of a home theatre without complicated settings, etc.

■ VIERA TOOLS - Display special feature icons for easy accessibility (p. 26)

Special features (such as VIERA Link and Media Player) can be accessed easily by using the VIERA TOOLS button.

■ Owner ID (p. 47)

Owner ID is an anti-theft function. Entering the PIN number and owner's personal information will help the Police to determine the owner in the case of theft.

■ Supports Audio Description signal (p. 15 and p. 29)

Audio Description (when broadcast) adds an additional soundtrack to describe events on screen (narration) and aids understanding and enjoyment, particularly for visually-impaired viewers.

You can switch Audio Description service Auto or Off, and adjust the volume of the description soundtrack independently of the main volume.

Digital Switchover for Terrestrial broadcasts

Starting in late 2007 and ending in 2012, TV services in the UK will go completely digital, TV region by TV region.

If you have any questions, please call Digital UK on **08456 50 50 50** or visit **www.digitaluk.co.uk**
Digital Switchover will cover a period of several weeks. When it starts you will lose all Analogue TV channels and some Digital TV channels will be missing.

You will need to retune your TV each time this happens to recover your digital channels. Analogue channels are permanently turned off, it will not be possible to recover them.

- To retune your TV → “Auto Setup” in “DVB Tuning Menu”-DVB mode (p. 36)

Users of cable or satellite boxes should still retune the TV to continue to receive Freeview channels via their aerial. (Your Analogue channel for viewing Cable or Satellite services will change to a new position.)

- Due to the digital reception technologies involved, quality of the digital signals may be relatively low in some cases, despite good reception of analogue channels.

Contents



Eco Mode

Adjusts picture settings automatically dependent on ambient lighting conditions.



Provides suitable images for playing games

Selecting "Game" in Viewing Mode provides fast response to the input signal and you can enjoy playing games. (p. 28)



V-Audio Surround

Utilises Panasonic's advanced digital amplification technology. (p. 29)



digital tick

The digital tick logo indicates that a digital tuner is built-in.



Freeview

Freeview is the way to enjoy digital TV for free.

Turn your living room into a home theatre!

Enjoy rich multi-media

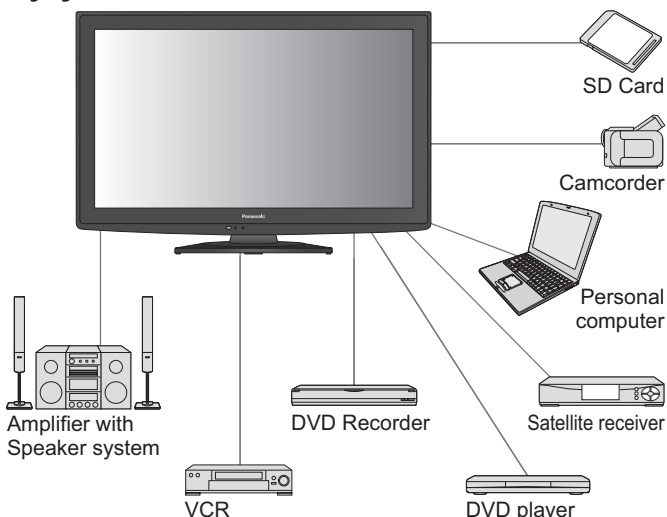

Be Sure to Read

- Safety Precautions (Warning / Caution) 4

Quick Start Guide

- Accessories / Options 6
- Identifying Controls 8
- Basic Connection 10
- Auto Setup 12

Quick Start Guide

Enjoy your TV!

Basic Features

- Watching TV 14
- Using TV Guide 18
- Viewing Teletext 21
- Watching External inputs 24
- How to Use VIERA TOOLS 26
- How to Use Menu Functions 27

Basic

Advanced Features

- Retuning from Setup Menu 36
- Tuning and Editing Channels 38
- Timer Programming 42
- Child Lock 44
- Input Labels 45
- Shipping Condition 46
- Owner ID 47
- Using Common Interface 48
- Updating the TV Software 49
- Using Media Player 50
- Displaying PC Screen on TV 54
- Link Functions (Q-Link / VIERA Link) 56
- External Equipment 64

Advanced

FAQs, etc.

- Technical Information 66
- FAQs 70
- On screen messages 72
- Glossary 73
- Maintenance 74
- Licence 74
- Index 74
- Specifications 75

FAQs, etc.

Safety Precautions

Warning

■ Mains plug and lead

To help avoid risk of electrical shock, fire, damage or injury, please follow the warnings below:

- This TV is designed to operate on AC 220-240 V, 50 Hz.
- Insert the mains plug fully into the socket outlet.
- Ensure that the mains plug is easily accessible.
- Remove the mains plug when cleaning the TV.

- Do not touch the mains plug with a wet hand.



- Do not damage the mains lead.

- Do not place a heavy object on the lead.



- Do not place the lead near a high temperature object.



- Do not pull on the lead. Hold onto the mains plug body when disconnecting the plug.



- Do not move the TV with the lead plugged into a socket outlet.
- Do not twist the lead, bend it excessively or stretch it.
- Do not use a damaged mains plug or socket outlet.
- Ensure the TV does not crush the mains lead.

If you detect anything unusual, immediately switch off the mains supply switch and remove the mains plug.

AC 220-240 V
50 Hz

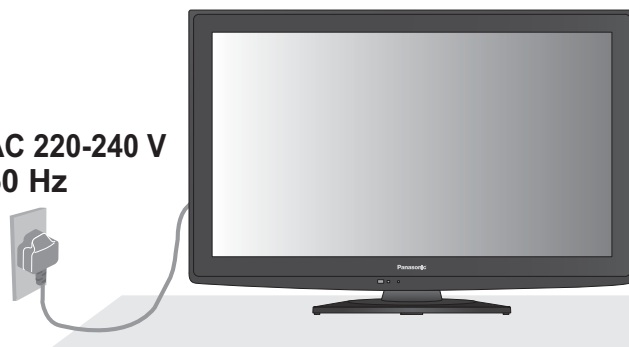

IMPORTANT: THE MOULDED MAINS PLUG

FOR YOUR SAFETY, PLEASE READ THE FOLLOWING TEXT CAREFULLY.

This TV is supplied with a moulded three pin mains plug for your safety and convenience. A 5 amp fuse is fitted in this mains plug. Shall the fuse need to be replaced, please ensure that the replacement fuse has a rating of 5 amps and that it is approved by ASTA or BSI to BS1362.

Check for the ASTA mark  or the BSI mark  on the body of the fuse.

If the mains plug contains a removable fuse cover, you must ensure that it is refitted when the fuse is replaced.

If you lose the fuse cover the mains plug must not be used until a replacement cover is obtained.

A replacement fuse cover may be purchased from your local dealer.

If the fitted moulded mains plug is unsuitable for the socket outlet in your home, then the fuse shall be removed and the mains plug cut off and disposed of safely. There is a danger of severe electrical shock if the cut off mains plug is inserted into any 13 amp socket.

If a new mains plug is to be fitted, please observe the wiring code as shown below.

If in any doubt, please consult a qualified electrician.

IMPORTANT: – The wires in this mains lead are coloured in accordance with the following code: –
Blue: Neutral Brown: Live

As the colours of the wire in the mains lead of this appliance may not correspond with the coloured markings identifying the terminals in your mains plug, proceed as follows.

The wire which is coloured BLUE must be connected to the terminal in the mains plug which is marked with the letter N or coloured BLACK.

The wire which is coloured BROWN must be connected to the terminal in the mains plug which is marked with the letter L or coloured RED.

Under no circumstances should either of these wires be connected to the Earth terminal of the three pin mains plug, marked with the letter E or the earth symbol .

How to replace the fuse

For plug type shown in example 1:

Lift out the removable fuse compartment with a screwdriver and replace the fuse, then refit securely into the mains plug (see example 1).

For plug type shown in example 2:

Lift open the fuse compartment, in the mains plug, with a screwdriver, and replace the fuse, then press the fuse cover down securely (see example 2).

Example 1

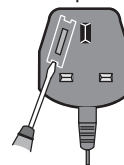



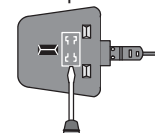

Example 2



Warning

Take care

To help avoid risk of electrical shock, fire, damage or injury, please follow the warnings below:

- Do not remove covers and never modify the TV yourself as live parts are accessible when they are removed. There are no user serviceable parts inside. 
- Do not expose the TV to rain or excessive moisture. This TV must not be exposed to dripping or splashing water and objects filled with liquid, such as vases, must not be placed on top of or above the TV. 
- Do not expose the TV to direct sunlight and other sources of heat. To prevent fire never place any type of candle or naked flame on top or near the TV. 
- Do not place the TV on sloped or unstable surfaces. 
- Do not insert foreign objects into the TV through the air vents.
- Do not use an unapproved pedestal / mounting equipment. Be sure to ask your local Panasonic dealer to perform the setup or installation of approved wall-hanging brackets.
- Do not apply strong force or impact to the display panel.

To prevent the spread of fire, keep candles or other open flames away from this product at all times



Small object

This product contains possibly dangerous parts that can be breathed in or swallowed by young children accidentally.

- Keep the dangerous parts out of reach of young children.
- Do not allow children to handle SD Card. As with any small object, the SD Card could be swallowed by young children. Please remove SD Card immediately after use and store out of reach of young children.



Caution

Ventilation

Allow sufficient space around the TV in order to help prevent excessive heat, which could lead to early failure of some electronic components.

- Ventilation should not be impeded by covering the ventilation openings with items such as newspapers, tablecloths and curtains. 
- Whether you are using the pedestal or not, always ensure the vents in the bottom of the TV are not blocked and there is sufficient space to enable adequate ventilation.

Minimum distance

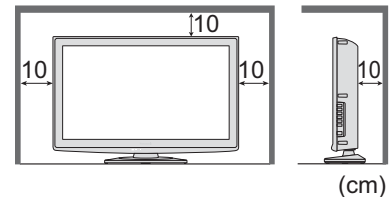

Moving the TV

Before moving the TV, disconnect all cables.

- Transport only in upright position.

When not in use for a long time

This TV will still consume some power even in the Off mode, as long as the mains plug is still connected to a live socket outlet.

- Remove the mains plug from the wall socket when the TV is not in use for a prolonged period of time.

Excessive volume

Do not expose your ears to excessive volume from the headphones. Irreversible damage can be caused.



Accessories / Options

Standard accessories

- Remote Control
 - N2QAYB000487



Check that you have the accessories and items shown

- Batteries for the Remote Control (2)
 - R6 (UM3)

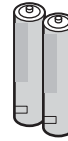

- Operating Instructions
- Product Registration Leaflet

- Pedestal (TX-L26X20B)
 - TBL0E0104
 - TBL0E0122
 - ➔ p. 7

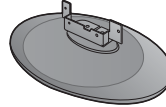

- Assembly screw for Pedestal (4)
 - XYM4+C10FJK

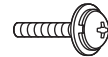

Optional accessories

Wall-hanging bracket

- TY-WK3L2RW

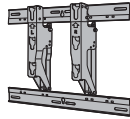

Caution

- Ensure PC connection is connected as shown when using wall-hanging bracket.

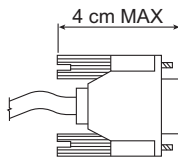

Please contact your nearest Panasonic dealer to purchase the recommended wall-hanging bracket. For additional details, please refer to the wall-hanging bracket installation manual.

Rear of the TV

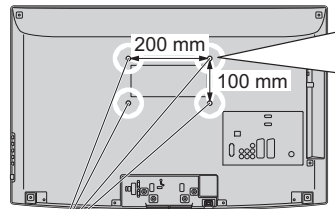

Holes for wall-hanging bracket installation

Screw for fixing the TV onto the wall-hanging bracket (not supplied with the TV)

Depth of screw:
minimum 9 mm, maximum 12 mm

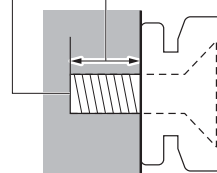

(View from the side)

Diameter: M4

Warning

- Using other wall-hanging brackets, or installing a wall-hanging bracket by yourself has the risk of personal injury and product damage. In order to maintain the unit's performance and safety, be sure to ask your dealer or a licenced contractor to secure the wall-hanging brackets. Any damage caused by installing without a qualified installer will void your warranty.
- Carefully read the instructions accompanying optional accessories, and be sure to take steps to prevent the TV from falling off.
- Handle the TV carefully during installation since subjecting it to impact or other forces may cause product damage which will void your warranty.
- Do not mount the unit directly below ceiling lights (such as spotlights or halogen lights) which typically give off high heat. Doing so may warp or damage plastic cabinet parts.
- Take care when fixing wall brackets to the wall. Wall mounted equipment must not be grounded by metal within the wall. Always ensure that there are no electrical cables or pipes in the wall before hanging bracket.
- To prevent fall and injury, remove the TV from its fixed wall position when it is no longer in use for an extended period of time.

Installing / removing remote's batteries

1

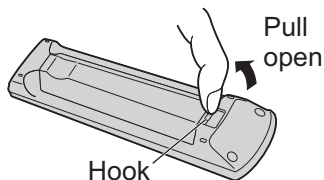

Hook

Pull open

2

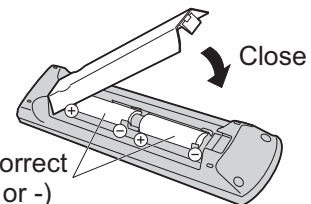

Note the correct polarity (+ or -)

Caution

- Incorrect installation may cause battery leakage and corrosion, resulting in damage to the remote control.
- Do not mix old and new batteries.
- Replace only with same or equivalent type. Do not mix different battery types (such as alkaline and manganese batteries).
- Do not use rechargeable (Ni-Cd) batteries.
- Do not burn or break up batteries.
- Batteries must not be exposed to excessive heat such as sunshine, fire, etc.
- Make sure you dispose of batteries correctly.
- Ensure batteries are replaced correctly, there is danger of explosion and fire if battery is reversed.
- Do not disassemble or modify the remote control.

Attaching the pedestal

To help avoid risk of damage or injury by the TV tipping or falling, please follow the warnings and cautions below:

Warning

- Do not disassemble or modify the pedestal.

Caution

- Do not use with any other TVs or displays.
- Do not use the pedestal if it becomes warped or physically damaged. If this occurs, contact your nearest Panasonic dealer immediately.
- During setup, make sure that all screws are securely tightened.
- Ensure that the TV does not suffer any impact during installation of the pedestal.
- Ensure that children do not climb onto the pedestal.
- Install or remove the TV from the pedestal with at least two people.

(A) Assembly screw (4)

- XSS4+16FNK



(B) Assembly screw (4)

- XYM4+C10FJK



(C) Bracket (1)

- TUX0E197



(D) Base (1)

- TBL0E0104

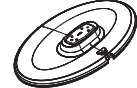

■ Assembling the pedestal

Use the four assembly screws (A) to fasten the bracket (C) to the base (D) securely.

- Forcing the assembly screws the wrong way will strip the threads.
- Make sure that the screws are securely tightened.

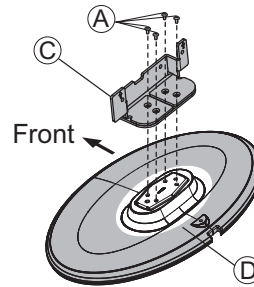

■ Securing the TV

Use only the supplied assembly screws (B) to fasten the pedestal securely to the TV.

- Make sure that the screws are securely tightened.
- Carry out the work on a horizontal and level surface.

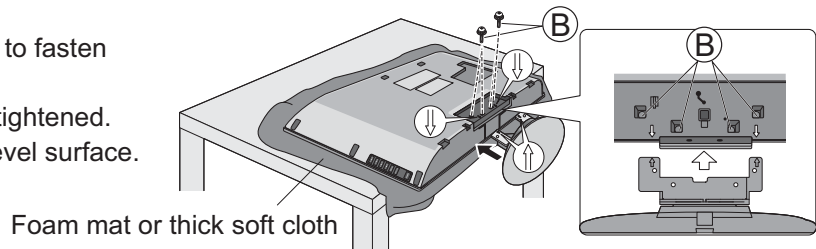

Identifying Controls

Remote Control

Media Player (p. 50)

- Switches to SD Card viewing mode (VIERA IMAGE VIEWER)

Standby On / Off switch

- Switches TV On or Off standby

Main Menu (p. 27)

- Press to access the Picture, Sound and Setup Menus

Aspect (p. 16)

Channel / Programme Information (p. 15)

- Displays channel and programme information

VIERA Link Menu (p. 60)

- Accesses VIERA Link Menu

OK

- Confirms selections and choices
- Press after entering channel position by using numeric buttons to change a channel quickly

Option Menu (p. 17)

- Easy setting for viewing and sound options

Coloured buttons (red-green-yellow-blue)

- Used for the selection, navigation and operation of various functions

Teletext (p. 21)

- Switches to teletext mode

Subtitles (p. 15)

- Displays subtitles

Numeric buttons

- Changes channel and teletext pages
- Sets characters
- When in Standby mode, switches TV On (Press for about 1 second)

Sound Mute

- Switches sound mute On or Off

Volume Up / Down

Input mode selection

- TV - switches between DVB and Analogue modes (p. 14)
- AV - switches to AV input mode from Input Selection list (p. 24)

Direct TV Recording (p. 58 and p. 60)

- Records programme immediately in DVD Recorder / VCR with Q-Link or VIERA Link connection

Normalise (p. 27)

- Resets picture and sound settings to their default levels

Exit

- Returns to the normal viewing screen

VIERA TOOLS (p. 26)

- Easily accesses special features such as VIERA Link and Media Player

TV Guide (p. 18)

- Displays TV Guide

Cursor buttons

- Makes selections and adjustments

Return

- Returns to the previous menu / page

Hold

- Freeze / unfreeze picture (p. 15)
- Holds the current teletext page (teletext mode) (p. 22)

Index (p. 23)

- Returns to the teletext index page (teletext mode)

Last view (p. 17)

- Switches to previously viewed channel or input mode

Channel Up / Down

- Selects channel in sequence

- Connected equipment operations (p. 25 and p. 62)



TV

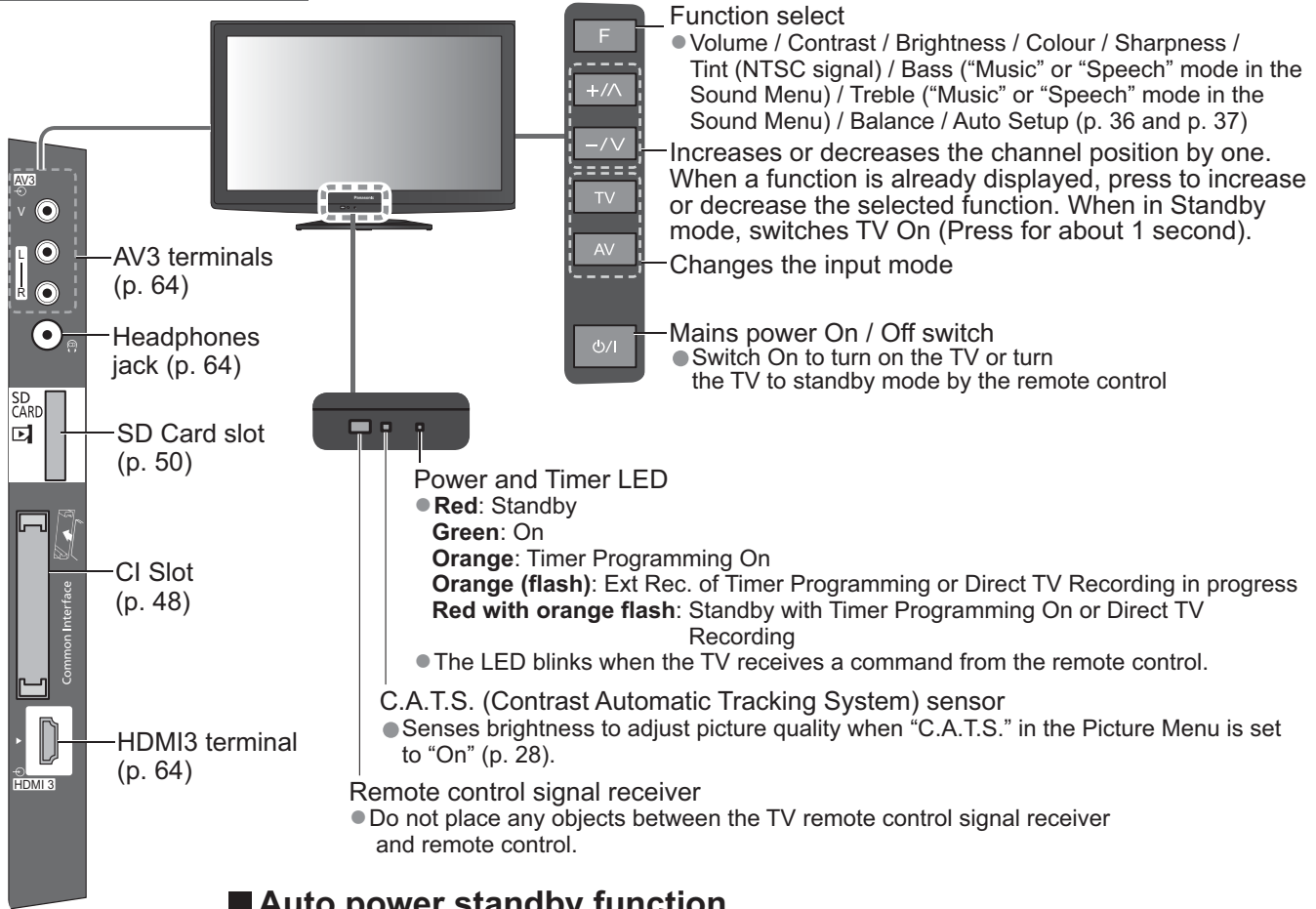

Auto power standby function

- The TV will automatically go to Standby mode in the following conditions:
 - no signal is received and no operation is performed for 30 minutes in Analogue TV mode
 - "Off Timer" is active in the Setup Menu (p. 17)
 - no operation is performed for the period selected in "Auto Standby" (p. 32)
- This function does not affect Ext Rec. of Timer Programming and Direct TV Recording.

Using the On Screen Displays

Many features available on this TV can be accessed via the On Screen Display menu.

How to use remote control

- | | | | |
|--|--|--|--|
| | Open the main menu | | Exit the menu system and return to the normal viewing screen |
| | Move the cursor / select the menu item | | Move the cursor / adjust levels / select from a range of options |
| | Access the menu / store settings after adjustments have been made or options have been set | | Return to the previous menu |

ON SCREEN HELP Instructions box - Operation guide
(example: Owner ID)

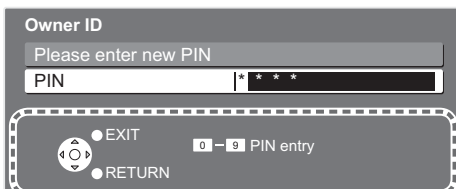

Operation guide will help you.

Basic Connection

External equipment and cables shown are not supplied with this TV.

Please ensure that the unit is disconnected from the mains socket before attaching or disconnecting any leads.

Example 1 Connecting aerial

TV only

Rear of the TV

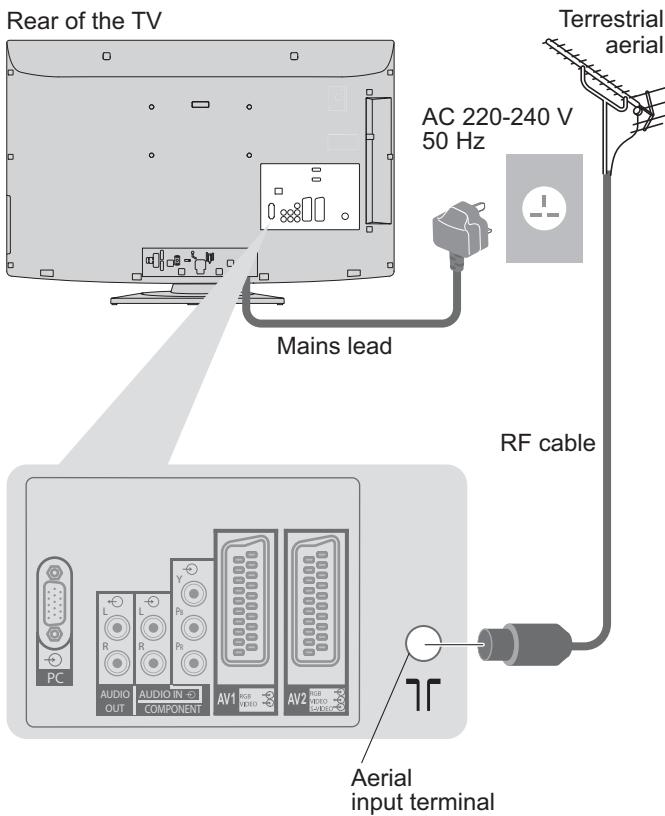

Example 2 Connecting DVD Recorder / VCR

TV, DVD Recorder or VCR

Rear of the TV

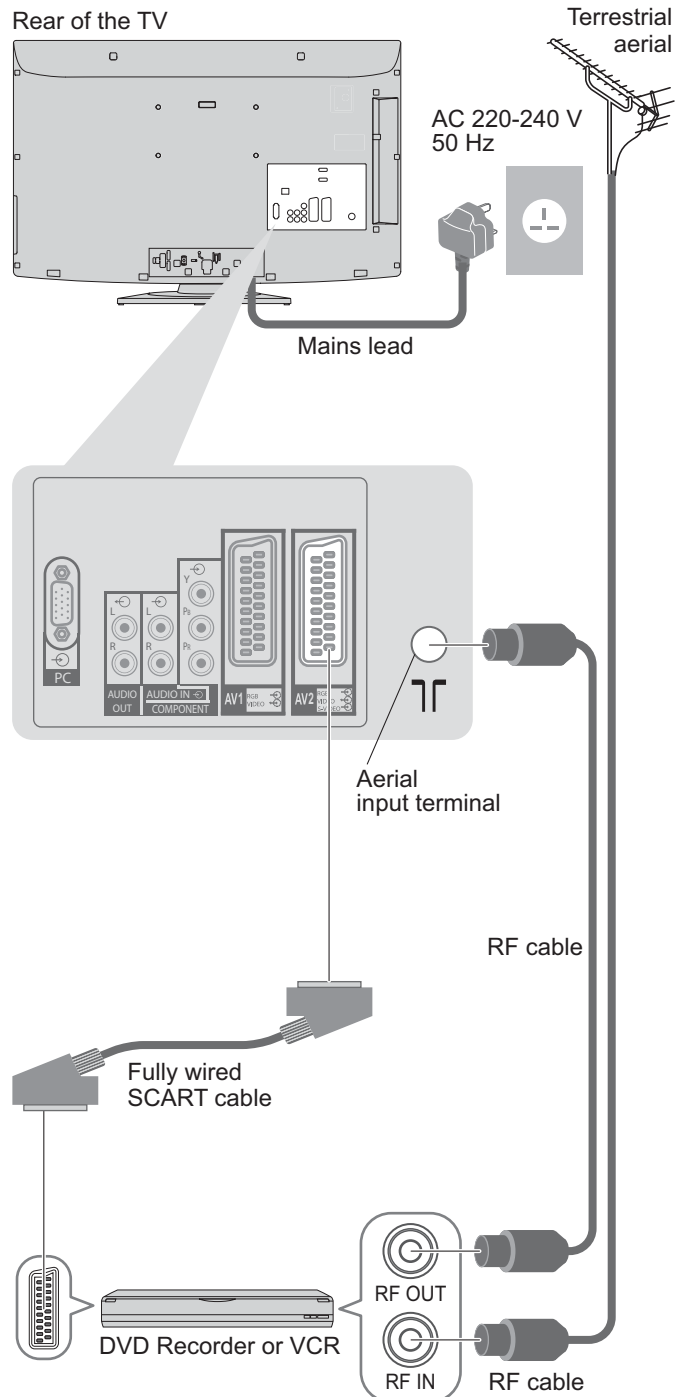

Note

- Connect to the TV's AV2 for a DVD Recorder / VCR supporting Q-Link (p. 58).
- Connect to the TV's AV1 for a Satellite Receiver.
- For HDMI-compatible equipment, possible to connect to HDMI terminals (HDMI1 / HDMI2 / HDMI3) by using HDMI cable (p. 64 and p. 65).
- Q-Link connection → p. 56
- VIERA Link connection → p. 56 and p. 57
- Please also read the manual of the equipment being connected.

Example 3 Connecting DVD Recorder / VCR and Satellite receiver

TV, DVD Recorder / VCR and Satellite receiver

Rear of the TV

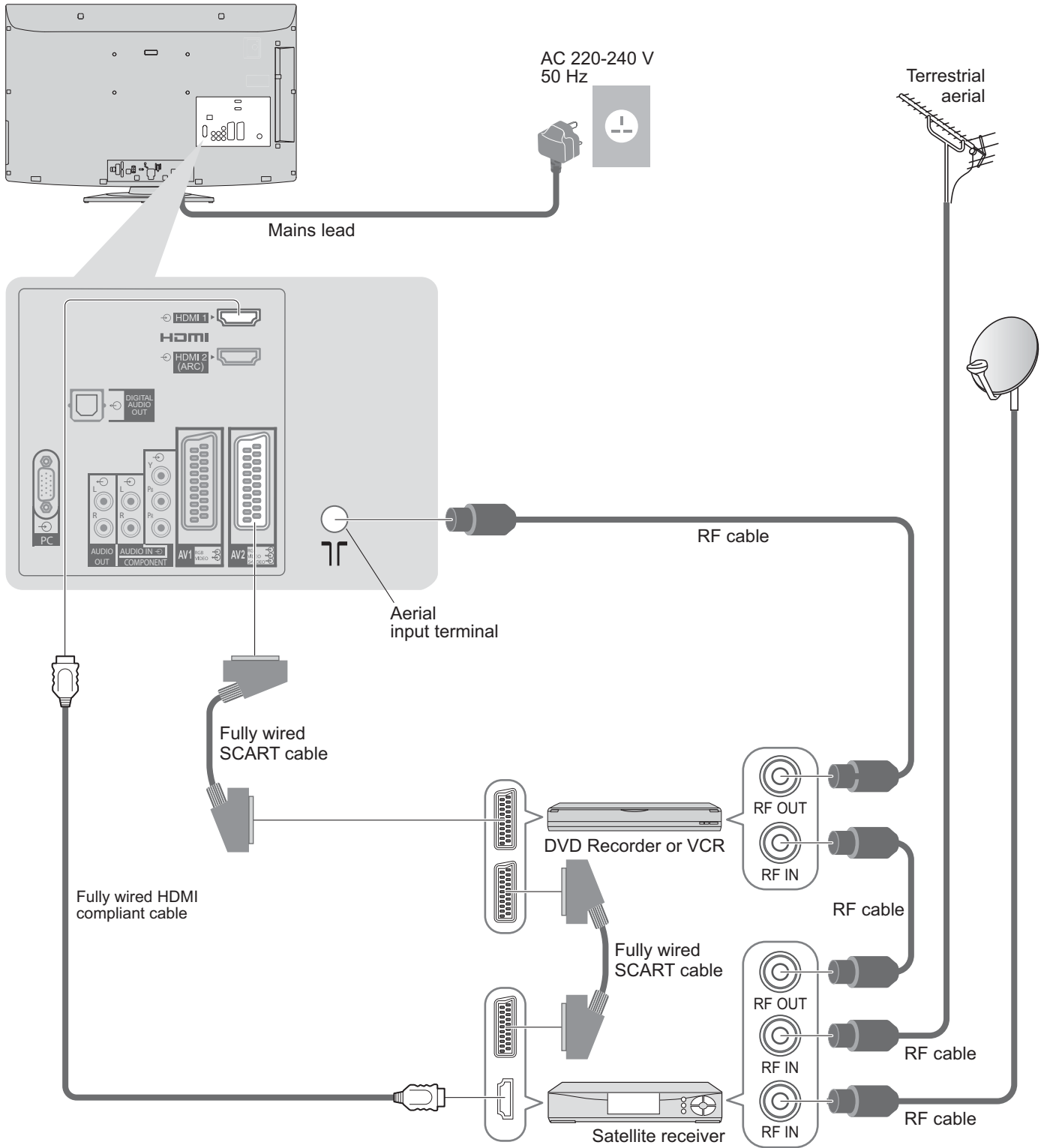

Auto Setup

Search and store TV channels automatically.

- These steps are not necessary if the setup has been completed by your local dealer.
- Please complete connections (p. 10 and p. 11) and settings (if necessary) of the connected equipment before starting Auto Setup. For details of settings for the connected equipment, read the appropriate manual.



1 Plug the TV into mains socket and switch On (Takes a few seconds to be displayed)



- If the red LED shows on the TV, press the Standby On / Off switch on the remote control for at least 1 second to turn the TV On.

Auto Setup - DVB and Analogue

DVB Scan CH 21 68

Analogue Scan CH 21 69

This will take about 6 minutes.

CH	Channel Name	Type	Quality
62	CBBC Channel	Free TV	10
62	BBC Radio Wales	Free TV	10
62	E4	Free TV	10
62	Cartoon Nwk	Free TV	10
29		Analogue	-
33	BBC1	Analogue	-

Free TV: 8 Pay TV: 0 Radio: 0 Data: 0 Analogue: 2

Searching

Auto Setup will start to search for TV channels and store them in the numbered order as specified by the broadcasters.

- Actual number of channels may differ due to channel duplication.

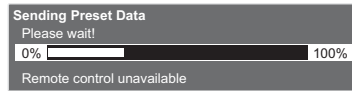

If Q-Link, or similar technology (p. 56), compatible recorder with analogue tuner is connected, analogue channel setting is automatically downloaded to the recorder. (Digital channel setting is not downloaded.)

- If downloading has failed, you can download later through the Setup Menu.
 - ➔ "Q-Link Download" (p. 30)

2 Input Owner ID



Please enter your own choice of PIN number, name, etc. (p. 13) to help the police to crack crime.

- Make a note of the PIN number in case you forget it. The PIN number cannot be reset.
- You can input or change the Owner ID later.
 - ➔ "Owner ID" (p. 47)
- To skip this step ➔ 
- This step will be skipped in the Auto Setup after "Shipping Condition" (p. 46) is performed.

3 Select "Home"

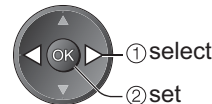
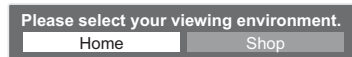

Select "Home" viewing environment (highlight "Home" in yellow) to use in your home environment.

Auto Setup is now complete and your TV is ready for viewing.

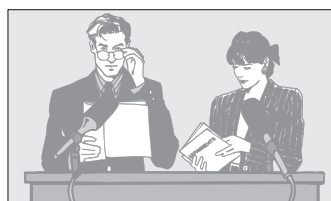

- To check channel list at-a-glance
 - ➔ "Using TV Guide" (p. 18)
- To edit or hide (skip) channels
 - ➔ "Tuning and Editing Channels" (p. 38 - 41)
- If tuning has failed, check the connection of the RF cable, and then, follow the on screen instructions.

■ How to input Owner ID

① Enter the PIN number (4 digits)



● Enter the PIN number twice at first setting.

② Enter your name, house number, and postcode, in that order

Select the item (NAME / HOUSE NO / POSTCODE)



Set characters one by one

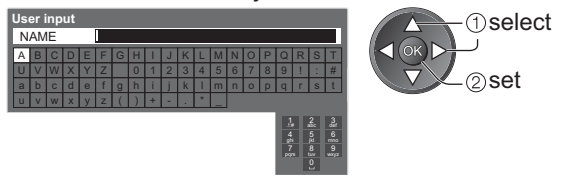

● You can set characters by using numeric buttons.
 ➔ "Characters table for numeric buttons" (p. 67)

Return to select other items



● Select the next item and repeat the operations.

③ Exit to go to next step



■ "Shop" viewing environment (for shop display only)

"Shop" viewing environment is the demonstration mode to explain main features of this TV.

Select "Home" viewing environment to use in your home environment.

● You can return to viewing environment selection screen at the stage of Shop confirmation screen and Automatic Demo Off / On selection screen.

① Return to viewing environment selection screen

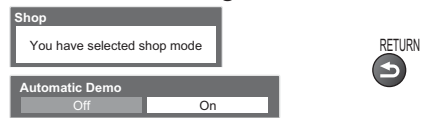

② Select "Home"



Auto Setup is complete

● To change viewing environment later on, you will need to initialise all settings by accessing Shipping Condition.
 ➔ "Shipping Condition" (p. 46)

Note

- If tuning has failed or to retune all channels ➔ "Auto Setup" (p. 36 and p. 37)
- To re-initialise all settings ➔ "Shipping Condition" (p. 46)
- If you turned the TV Off during Standby mode last time, the TV will be in Standby mode when you turn the TV On with Mains power On / Off switch.

Watching TV

1 Turn power on
(Press for about 1 second)

- Mains power On / Off switch should be On. (p. 8)

2 Select DVB or Analogue

- Also possible by pressing the TV button on the side panel of the TV. (p. 9)

Information banner appears whenever you select a channel

- For details → p. 15

3 Select a channel

up or

 down

DVB channel position numbers run from 1 onwards.
Analogue channel position numbers run in the ranges 0 - 99.

- To select a two or three-digit channel position number, e.g. 399
→ → →

Volume

Panasonic TV

Note

- To watch pay-TV
→ "Using Common Interface" (p. 48)

■ Select a channel using Information banner (p. 15)

It is possible to confirm the channel name and programme information by using the Information banner before changing channels.

Display Information banner if it is not displayed



While the banner is displayed, select the channel

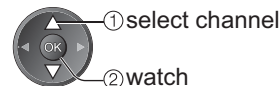

- Possible to set display timeout in "Banner Display Timeout" (p. 31).

■ Select a channel using TV Guide (p. 18)

It is possible to confirm the channel and programme information by using the TV Guide (EPG) before changing channels.

Display TV Guide



Select a current programme or channel



Select "View" (DVB mode)

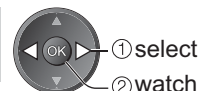
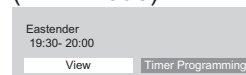

- To use Timer Programming → p. 19

Other useful functions

Hold

Freeze / unfreeze picture



Display Information banner

Display Information banner

- Also appears when changing a channel

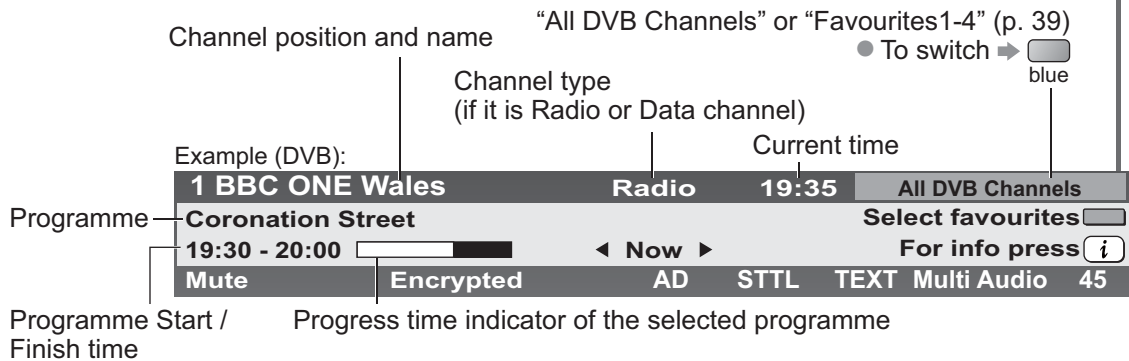

Example (Analogue):



Channel number

- To confirm another tuned channel name → [OK]
- To watch the channel listed in the banner → [OK]
- Information on the next programme (DVB) → [OK]
- To hide → [EXIT]
- Extra information → [i] (press again to hide the banner)
- To set display timeout → “Banner Display Timeout” (p. 31)

Features available / Message meanings

- Mute**
Sound mute On
- Bad signal**
Poor TV signal quality
- Encrypted**
Scrambled programme
- AD**
Audio Description service available
 - This function can aid visually-impaired viewers by adding an additional audio track to describe events on screen.
 - For settings → p. 29
- STTL**
Subtitle service available
- TEXT**
Teletext service available
- Multi Audio**
Multiple audio available
- Stereo, Mono, NICAM**
Audio mode
- 1 - 90**
Off Timer remaining time
 - For settings → p. 17

Example:

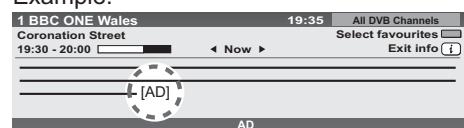

- “AD”, “STTL”, “TEXT”, “Multi Audio” indications are displayed as available on particular programmes, but may not be available for all individual programmes being broadcast. Display the extra information to confirm availability of these functions.

Watching TV

Other useful functions

Display subtitles

DVB mode

Display / hide subtitles (if available)

- To change the language for DVB (if available)
 - ➔ "Preferred Subtitles" (p. 31)



Analogue mode

Display subtitles

- To hide subtitles ➔



Note

- This is the same as switching to Analogue teletext service and selecting "P888" (subtitle service). (p. 23)
- You cannot change the channel when this function is active.

Aspect

Change the aspect ratio (image size)



Enjoy viewing the image at its optimum size and aspect.

Programmes usually contain an Aspect Control Signal (Widescreen signal, etc.), and the TV will choose the aspect ratio automatically according to the Aspect Control Signal (p. 66).

If you would like to change the aspect ratio manually

Display Aspect Selection list

While the list is displayed, select the mode



- To change the mode using the ASPECT button only
 - ➔ (Press repeatedly until you reach the desired mode)

Auto



The best ratio is chosen and the image expanded to fill the screen.
For details ➔ p. 66

16:9



Directly displays the image at 16:9 without distortion (anamorphic).

Zoom1

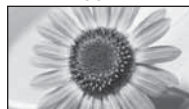

Displays a 16:9 letterbox or 4:3 image without distortion.

14:9

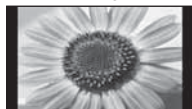

Displays the image at the standard 14:9 without distortion.

Zoom2

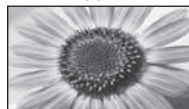

Displays a 16:9 letterbox (anamorphic) image full-screen without distortion.

4:3



Displays the image at the standard 4:3 without distortion.

Zoom3

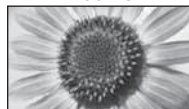

Displays a 2.35:1 letterbox (anamorphic) image full-screen without distortion.
At 16:9, displays the image at its maximum (with slight enlargement).

Note

- Only "16:9" and "4:3" are available in PC input mode.
- Aspect is fixed to "16:9" when "Viewing Mode" is set to "Game" in the Picture Menu.
- Not available when the subtitle function is active.
- Not available in teletext service.
- Aspect mode can be memorized separately for SD (Standard definition) and HD (High definition) signals.

Other useful functions

Display the selectable settings for the current programme

Check or change the current programme status instantly



- To change

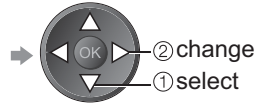

Multi Audio (DVB mode)

Allows you to select between alternative language for sound tracks (if available)

- This setting is not memorized and it will return to the default setting once you exit the current programme.

Monaural Audio (DVB mode)

Allows you to select stereo / monaural (if available)

Subtitle Language (DVB mode)

Allows you to select the language in which subtitles should appear (if available)

NICAM (Analogue mode)

Switches NICAM sound (if available)

- Sound Menu (p. 29)

Volume Correction

Adjusts volume of individual channel or input mode

Audio Description (DVB mode)

Set to "Auto" if the programme has Audio Description service, then you will hear an additional audio track to describe events on screen

- To adjust the volume for Audio Description
 - "Audio Description Menu" (p. 29)

Note

- Also possible to change the settings in Menu list (p. 28 - 32).

Last view

Switch to previously viewed channel or input mode easily



- Press again to return to the present view.

Note

- Switching channel is not available while Ext Rec. of Timer Programming or Direct TV Recording is in progress.
- Watching less than 10 sec. is not regarded as the previously viewed channel or input mode.

Off Timer

Turn the TV off automatically after a fixed period (Off / 15 / 30 / 45 / 60 / 75 / 90 minutes)

Display the menu



Select "Setup"

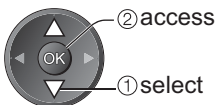
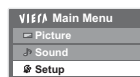

Select "Off Timer" and set the time

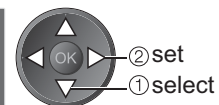
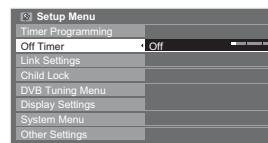

- To cancel → Set to "Off" or turn the TV off.
- To display the remaining time → Information banner (p. 15)

Note

- When the remaining time is within 3 minutes, the remaining time will flash on the screen.

Using TV Guide

TV Guide—Electronic Programme Guide (EPG) provides an on screen listing of the programmes currently broadcast and the forthcoming broadcasts over the next seven days (depending on the broadcasters).

- This TV supports the GUIDE Plus+ system.
- The Gemstar branding partner will supply the rating informations in the programme information and the recommended group in the Search list.
- DVB and Analogue channels are displayed on the same TV Guide screen. “D” means DVB channel and “A” means Analogue channel. There will be no programme listings for Analogue channels.
- When this TV is turned on for the first time, or the TV is switched off for more than a week, it may take some time before the TV Guide is completely shown.

1 Select DVB or Analogue (TV)

2 View TV Guide (GUIDE)

Example:

- Current date and time: Wed 28 Oct 2009 10:46
- TV Guide date: Wed 28 Oct
- Programme: 1 BBC ONE 20:00 - 20:30 DIY SOS: We open in the B...
- Logo of the Gemstar branding partner: RadioTimes
- TV Guide time: Time: 19:30 | 20:00 | 20:30 | 21:00
- Advertisement: VIEIRA
- D: DVB, A: Analogue
- Channel position and name: D 1 BBC ONE Eastender, D 7 BBC THREE Hot Wars, D 14 E4 Emmerrald, D 70 BBC FOUR Coronation Street, D 72 BBC 2W 10 O' clock News BBC, D 105 BBC1 Panorama, D 119 BBC1 Spring watch, D 718 BBC Radi Tim A Celebrity, Rugby, 15 To 1

To return to TV

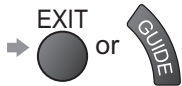

To watch the programme

Select a current programme or channel

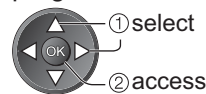

Select “View” (DVB mode)

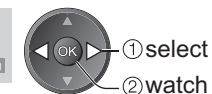
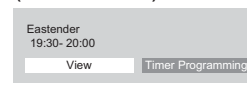

● To use Timer Programming → p. 19

To view a channel list of the selected category



(Category list)

Category	All Channels
All Channels	
All DVB Channels	
All Analogue Channels	
Free DVB Channels	
TV/Data DVB Channels	
Favourites1	
Favourites2	
Favourites3	
Favourites4	

Only Analogue channels are listed

● To list favourite channels → p. 39

To the previous day (DVB mode)



To search programme types and view a channel list of the searched programmes (DVB mode)



(Search list)

Search	Search Titles...
Search Titles...	
Movie	
News and Factual	
Entertainment	
Sport	
Children's	
	...

To the next day (DVB mode)



To search programme titles and view a list of the searched programmes (DVB mode)



(Search list)

Search	Search Titles...
Search Titles...	
Movie	
News and Factual	
Entertainment	
Sport	
Children's	
	...

Set characters one by one (maximum: 19 characters)

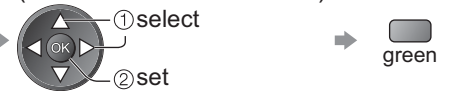

You can set characters by using numeric buttons.
 → “Characters” table for numeric buttons” (p. 67)

- All the programme titles including the word you set will be listed.
- Searching without any characters will list all programmes including current programmes.

■ Other useful functions

Timer Programming (DVB mode)

Timer Programming can remind you to watch a programme or record one on an external recorder.

Select the forthcoming programme

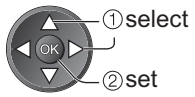

Select the function (Reminder or Ext Rec.)

Timer Programming					
Wed 28 Oct 2009 10:46					
Function	No.	Channel Name	Date	Start	End
Ext Rec.	D 1	BBC ONE DIY SOS	Wed 28 Oct	20:00 20:30 (30 min.)	
...
...
...
...

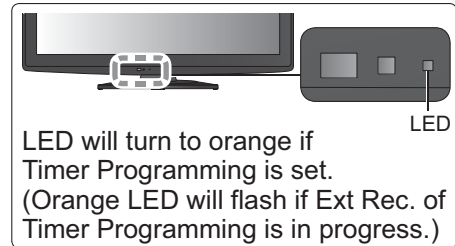
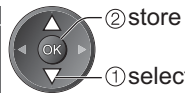

LED will turn to orange if Timer Programming is set. (Orange LED will flash if Ext Rec. of Timer Programming is in progress.)

(Timer Programming screen)

Ext Rec. : to record the programme to the recorder



When the start time comes, the channel will be switched automatically and the video and audio signals will be output. 2 mins. before the starting time, a reminder message appears if you are watching TV.

Reminder : to remind you to watch the programme



When you are watching TV, a reminder message appears 2 mins. before the start time. Press the OK button to switch to the programmed channel.

■ To check / change / cancel a timer programming event → “Timer Programming” (p. 43)

■ To return to TV Guide → RETURN

■ If you select a current programme

A confirmation screen asking whether you wish to watch or record the programme will appear.

Select “Timer Programming” and set “Ext Rec.” to record from the time you finish programming the timer event setting.



Note

- This function is not available in Analogue mode.
- Timer Programming can store up to 15 events.
- Timer Programming reminder messages will remain displayed until one of the following occurs:
 - You press the OK button to view the programme or the EXIT button to cancel the reminder.
 - The timer programming event that the reminder is set for ends.
- No other channel can be selected while Ext Rec. of Timer Programming is in progress.
- When recording programmes, be sure to make the proper settings on the recorder connected to the TV. If a compatible recorder with Q-Link or similar technologies is connected to the TV (p. 58) and the “Link Settings” (p. 30) are completed, no setting of the recorder is required. Also read the manual of the recorder.

Guide link programming (Timer Programming from the TV Guide signal)

Guide link programming is Timer Programming which is controlled by information from the TV Guide; if programme start and end times are changed by the broadcaster, the timer programming event will follow the change.

A Split Programme programming is a Guide link programming which is interrupted by one or more other programmes.

Note that Guide link programming (including Split Programme programming) only works reliably if correct information is received from broadcasters.

Timer Programming					
Wed 28 Oct 2009 10:46					
Function	No.	Channel Name	Date	Start	End
Ext Rec.	D 1	BBC ONE DIY SOS	Wed 28 Oct	20:00 20:30 (30 min.)	
Reminder	D 14	E4 The Bill	Wed 28 Oct	21:00 22:30 (90 min.)	
Ext Rec.	D 72	BBC 2W <TIMER>	Wed 28 Oct	22:45 23:00 (15 min.)	
Ext Rec.	D 1	BBC ONE Red Cap	Thu 29 Oct	10:30 11:30 (60 min.)	
...

(Timer Programming screen)

“Guide” is displayed if the timer is set from the TV Guide (Guide link programming)

“S/P” is displayed if the timer is set from the TV Guide and the programme is a Split Programme

“D” or “S” will be displayed in the TV Guide if Timer Programming is set as the Guide link programming.

Freeview	TV Guide	RadioTimes
Wed 28 Oct 2009 10:46	Wed 28 Oct	Wed 28 Oct 2009 10:46
1 BBC ONE	20:00 - 20:30 DIY SOS : We open in the Battersbys	
D 1 BBC ONE	Eastender	D DIY SOS
D 7 BBC THREE	Hot Wars	Holiday News
D 14 E4	Emmerdal	Coronation Street
D 70 BBC FOUR	10 O'clock News BBC	Pepsi Char.
D 72 BBC 2W	Panorama	Spring watch
D 105 BBC1	I'm A Celebrity	Pop Idol
D 719 BBC Radi	Rugby	15 To 1

Note

- If you edit the start time or end time of a Guide link programming event by more than 10 minutes, it will no longer follow the broadcaster’s changes to the start or end time. The start and end times will become fixed.
- Whilst making the Split Programme programming event for Ext Rec., you cannot record any channels between the interrupted programmes.
- The Split Programme programming event for Reminder will be cleared by pressing the OK button once to view.
- The Split Programme programming event for Reminder will switch to the programmed channel by pressing the OK button even if it is between the interrupted programmes.
- The Split Programme programming does not work if the separated parts are broadcast on different channels.

Using TV Guide

Other useful functions

View details of the programme (DVB mode)

Select the programme



View details

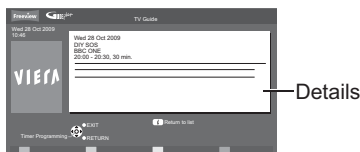

- Press again to return to TV Guide.

View advertisement

Enter your postcode when using this function for the first time

➔ "Postcode" in "GUIDE Plus+ Settings" (p. 32)

If you have already entered your postcode in "Auto Setup" - when first using the TV (p. 12), you do not have to enter it again.

If you enter an incorrect postcode for your area, or no postcode is entered, advertisements may not be displayed correctly.

Display advertisement information

OPTION



- To display the latest advertisement, you will need to update the information.
To update the information continuously, the TV must be left in Standby mode at night.

To change advertisements ➔



To return to TV Guide ➔



Note

- Some advertisements are for future programmes.
In this case it is possible to use the Guide link programming function (p. 19).
- The advertisements displayed on the TV Guide are sent from the GUIDE Plus+ system so that they cannot be deleted manually or will not be lost even when the TV is turned Off with Mains power On / Off switch.

Viewing Teletext

You can enjoy news, weather forecasts and subtitles, etc. (depending on the broadcaster)

- The availability of teletext services for a programme is indicated by “TEXT” in the information banner.

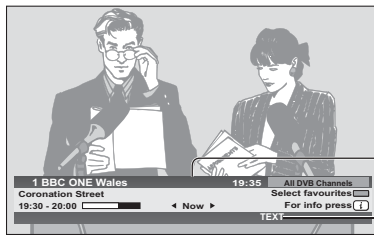

Information banner (p. 15)

Displayed if programme has teletext service

Digital teletext (MHEG)

Digital teletext services

Digital teletext services differ greatly from analogue teletext.

When you switch to a digital teletext service, the images you see can contain graphics and text, laid out and controlled in a manner decided by the broadcaster.

1 Select DVB



- DVB programmes have digital teletext services (MHEG).

2 Switch to Teletext

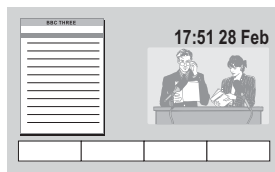

How to use

In all cases, it is possible to navigate the pages using buttons on the remote control, but because the commands available must apply to all manufacturers of digital equipment, some on screen commands may not correspond exactly to the remote control buttons.

For example:

- When “select” or “go” is displayed →

- When “◀”, “▶”, “▲”, “▼” symbol is displayed →

- When the key words are displayed on colour bar →

- When options with numbers are displayed →

- To return to TV →

Note

- As soon as you switch to a digital channel with links to a teletext service, software is downloaded in the background to enable the teletext function. This means that when switching to a digital channel, you should wait for approximately 5 seconds before pressing the TEXT button - this will allow the software to download. If you press the TEXT button before download is complete, it will be ignored and you will have to press the TEXT button again when the download is complete.
- While navigating digital teletext, you will find there is a short delay when moving between pages while the page downloads. There is often a prompt shown somewhere on the page (for example “Loading”) to let you know that this is happening.

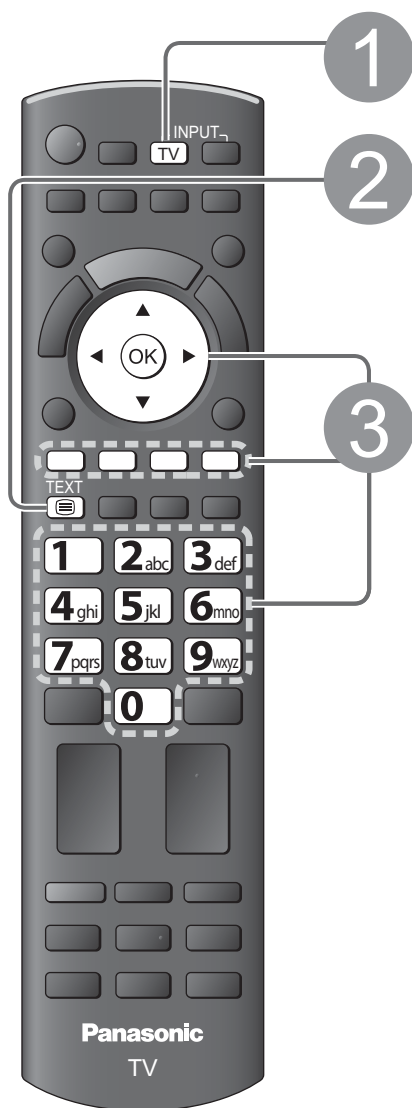

Viewing Teletext

Analogue teletext

Analogue teletext services

Analogue teletext services are the text information provided by the broadcasters. The features may vary depending on the broadcasters.

What is FASTEXT mode?

In FASTEXT mode, four differently coloured subjects are situated at the bottom of the screen. To access more information about one of these subjects, press the appropriately coloured button. This facility enables fast access to information on the subjects shown.

What is List mode?

In List mode, four differently coloured page numbers are situated at the bottom of the screen. Each of these numbers can be altered and stored in the TV's memory. ("Store frequently viewed pages", p. 23)

■ **To change mode** → "Teletext" in the Setup Menu (p. 31)



1 Select Analogue



2 Switch to Teletext



• Displays the index page (content varies depending on the broadcasters)

3 Select the page



OR

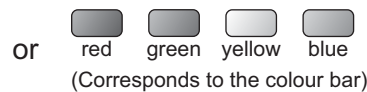
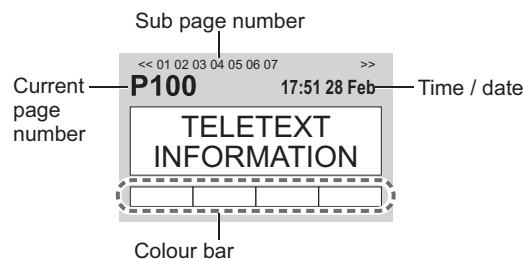

As the blue bar is displayed

■ **To adjust contrast** → MENU (press twice) →



■ **To return to TV** → EXIT

Reveal hidden data

Reveal hidden words e.g. quiz page answers

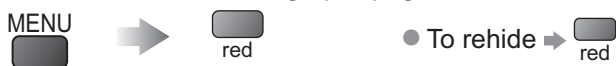

FULL / TOP / BOTTOM

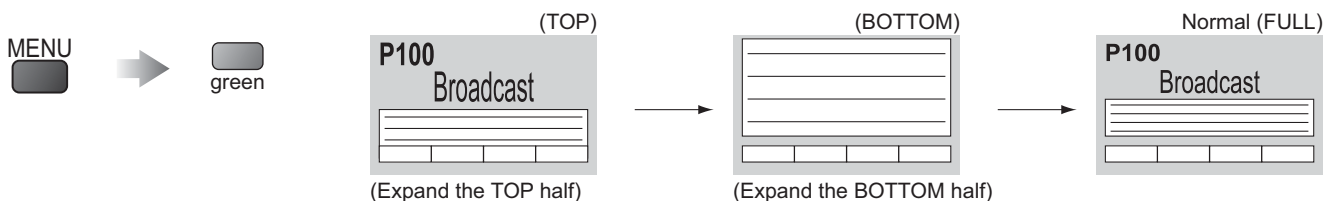

HOLD

Stop automatic updating

(If you wish to hold the current page without updating)



INDEX

Return to the main index page



Subtitles

View a favourite page stored

- STTL
- Factory setting is "P888" (subtitle service) on the blue button (List mode).



View in multi window

Watch TV and Teletext in two windows at once



- Operations can be made only in Teletext screen.
- Each time pressed: Teletext → TV and Teletext



Store frequently viewed pages

Store frequently viewed pages in the colour bar

(List mode only)

As page is displayed

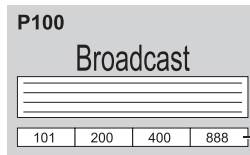

- If you wish to use Subtitles, do not change number on blue button.

The number changes to white.

To change stored pages

Coloured button you want to change



Enter new page number

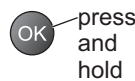

View sub page

View sub page (Only when teletext is more than one page)



Appears at top of the screen

To view specific sub page

MENU → blue

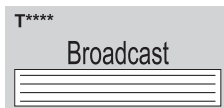

Enter the 4-digit number
example: P6
0 0 0 6

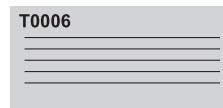

- Sub pages:
The number of sub pages varies depending on the broadcasters (up to 79 pages).
It may take some time for searching, during which time you can watch TV.

Watch TV while waiting for update

View the TV picture while searching for a teletext page

Teletext automatically updates itself when new information becomes available.

MENU → yellow

Changes to TV screen temporarily



Appears when updating is completed

View the updated page



(You cannot change the channel.)

- The news page provides a function that indicates arrival of latest news ("News Flash").

Watching External inputs

Connect the external equipment (VCRs, DVD equipment, etc.) and you can watch through the AV input.

● To connect the equipment → p. 10 - p. 11 and p. 64 - p. 65

The Remote Control is capable of operating some functions of selected external equipment.

1 Turn the TV on

- **When connecting with SCART as example 2 or 3** (p. 10 and p. 11)
 - Receives input signals automatically when playback starts
 - Input signals are automatically identified by the SCART (pin 8) terminal.
 - This function is also available for HDMI connections (p. 64 and p. 65).
- **If input mode is not switched automatically**
 - Perform ② and ③
 - Check the setup of the equipment.

2 Display the Input select menu

AV

3 Select the input mode connected to the equipment

Input Selection	
AV1	
AV2/S	==
AV3	
COMPONENT	
PC	
HDMI1	
HDMI2	
HDMI3	
TV	

- You can also select the input using the AV button on the remote control or the side panel of the TV. Press the button repeatedly until the desired input is selected.
- In order to switch between AV2 and AV2S, move the indicator by pressing left and right cursor button.
- You can label or skip each input mode → “Input Labels” (p. 45) Skipped inputs will not be displayed when the AV button is pressed.

4 View

Displays the selected mode

AV2

■ **To return to TV**

→ TV

Note

- If the external equipment has an aspect adjustment function, set to “16:9”.
- For details, see the manual of the equipment or ask your local dealer.









Screen display

Terminal	AV1	AV2	AV3	COMPONENT	PC	HDMI1	HDMI2	HDMI3
Manual input (default setting in "Input Labels")	AV1 AV1-RGB	AV2 AV2-S-Video AV2-RGB	AV3	COMPONENT	PC	HDMI1	HDMI2	HDMI3
Auto input (EC mode or VIERA Link)	EC/AV1 EC/AV1-RGB	EC/AV2 EC/AV2-S-Video EC/AV2-RGB	—	—	—	EC/HDMI1 ● Applicable for EC mode and VIERA Link	EC/HDMI2 ● Applicable for VIERA Link	EC/HDMI3 ● Applicable for VIERA Link

- If the above information is permanently displayed on the top left of the screen, press the **i** button to clear.

Operating the equipment with the TV remote control

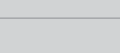

The Panasonic equipment connected to the TV can be directly operated with the below buttons of this TV remote control.

	Standby Set to Standby mode / Turn on
	Play Playback videocassette / DVD
	Stop Stop the operations
	Rewind / Skip / Search VCR: Rewind, view the picture rapidly in reverse DVD: Skip to the previous track or title Press and hold to search backward
	Fast-forward / Skip / Search VCR: Fast-forward, view the picture rapidly forward DVD: Skip to the next track or title Press and hold to search forward
	Pause Pause / Resume DVD: Press and hold to play at slow speed
	Channel Up / Down Select channel
	Record Start recording

■ How to change the code for the type of the equipment

Each type of the Panasonic equipment has its own remote control code.
Please change the code according to the equipment you want to operate.
If you operate the connected equipment in VIERA Link (p. 62), select the code "73".

Press and hold  during the following operations

Enter the appropriate code, see table below  → Press 

Type of the equipment	Code
DVD Recorder, DVD Player	70 (default)
Player theatre, Blu-ray Disc theatre	71
VCR	72
The equipment using in VIERA Link → "VIERA Link Control" (p. 62)	73

Note

- Confirm if the remote control works correctly after changing the code.
- The codes may be reset to default values if batteries are replaced.
- Some operations may not be possible on some equipment models.

How to Use VIERA TOOLS

You can access some special features easily by using the VIERA TOOLS function.

- For “VIERA Link Control” and “Pause Live TV” functions to operate correctly, ensure the connections and settings are completed.
 - ➔ “Summary of Q-Link and VIERA Link features” (p. 56 and p. 57), “Preparations” (p. 59)
After connection, turn the equipment on and then switch the TV on.
- For “Photo” and “Video” functions to operate correctly, ensure the SD Card has photo or video data on it and insert it into the SD Card slot properly.
 - ➔ “Using Media Player” (p. 50)



1 Display icons of the feature

2 Select a feature

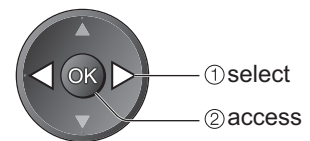

3 Follow the operations of each feature

- VIERA Link Control ➔ “VIERA Link Control” (p. 62)



When two or more compatible equipment are connected, a selection screen will be displayed.
Please select the correct description and access.

- Pause Live TV ➔ “Pause Live TV” (p. 61)



- Photo ➔ “Photo mode” (p. 50)



- Video ➔ “Video mode” (p. 52)



■ To return to TV



Note

- If the selected feature is not available, the demonstration to explain how to use it can be displayed. Press the OK button to view the demonstration after selecting the unavailable feature.

How to Use Menu Functions

Various menus allow you to make settings for the picture, sound, and other functions.



- 1 Display the menu**
 - MENU**
 - Displays the functions that can be set (varies according to the input signal)
- 2 Select the menu**
 - VIERA Main Menu**
 - Picture
 - Sound
 - Setup
- 3 Select the item**

Example (Picture Menu):

Viewing Mode	Dynamic
Contrast	
Brightness	
Colour	
Sharpness	
Tint	
Colour Balance	Warm
Vivid Colour	Off
C.A.T.S.	Off
- 4 Adjust or select**

Example (Picture Menu):

Viewing Mode	Dynamic
Contrast	
Brightness	
Colour	
Sharpness	
Tint	
Colour Balance	Warm
Vivid Colour	Off
C.A.T.S.	Off

■ To return to TV at any time



■ To return to the previous screen



■ To change menu pages

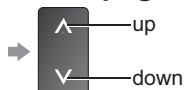

■ Choose from among alternatives

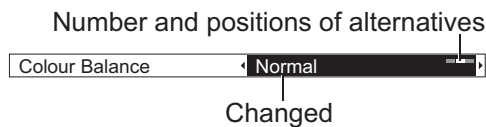

■ Adjust using the slide bar

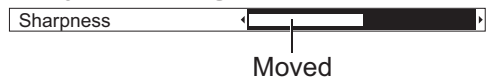

■ Go to the next screen

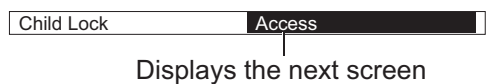

■ Enter characters by free input menu

You can enter names or numbers freely for some items.

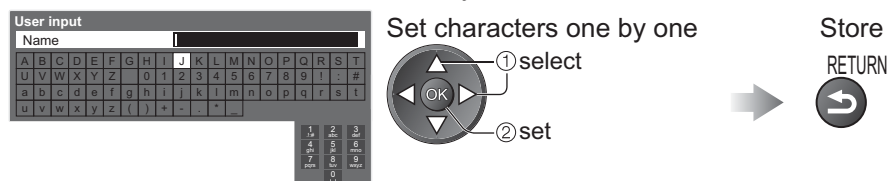

- You can set characters by using numeric buttons.
 - ➔ "Characters table for numeric buttons" (p. 67)

How to Use Menu Functions

■ Menu list

Menu	Item	Adjustments / Configurations (alternatives)
Picture	Viewing Mode	<p>Basic picture mode (Dynamic / Normal / Cinema / True Cinema / Game) In each Viewing Mode, Contrast, Brightness, Colour, Sharpness, Tint, Colour Balance, Vivid Colour, C.A.T.S., P-NR and 3D-COMB can be adjusted and stored to suit your particular viewing requirement.</p> <ul style="list-style-type: none"> ● Set for each input signal. <p>Dynamic : Provides enhanced picture contrast and sharpness when viewing in a bright room.</p> <p>Normal : Recommended for viewing under normal ambient room lighting conditions.</p> <p>Cinema : For watching movies in a darkened room with the improved performance of contrast, black and colour reproduction</p> <p>True Cinema : Precisely reproduces the original quality of the image without any revision.</p> <p>Game : Fast response signal specifically to provide suitable images for playing games</p> <ul style="list-style-type: none"> ● Not valid on TV mode ● A continuous record of time spent using Game mode can be displayed in the top right of the screen. <ul style="list-style-type: none"> ➔ "Playing Time Display" (p. 31)
	Contrast, Brightness, Colour, Sharpness	Increases or decreases the levels of these options according to your personal preference
	Tint	<p>With an NTSC signal source connected to the TV, the picture hue can be adjusted to suit your taste</p> <ul style="list-style-type: none"> ● For NTSC signal reception only
	Colour Balance	<p>Allows you to set the overall colour tone of the picture (Cool / Normal / Warm)</p> <ul style="list-style-type: none"> ● Not valid when "Viewing Mode" is set to "True Cinema"
	Vivid Colour	<p>Automatically adjusts colours to vivid ones (Off / On)</p> <ul style="list-style-type: none"> ● Not valid on PC signal
	C.A.T.S.	<p>Contrast Automatic Tracking System (Automatic Brightness Control function) Adjusts picture settings automatically dependent on ambient lighting conditions (Off / On)</p>
	P-NR	<p>Picture Noise Reduction Automatically reduces unwanted picture noise and flicker noise in the contoured parts of a picture (Off / Min / Mid / Max)</p>
	3D-COMB	<p>Makes still or slow moving pictures look more vivid (Off / On)</p> <ul style="list-style-type: none"> ● Occasionally, whilst viewing still or slow moving pictures, colour patterning may be seen. Set to "On" to display sharper and more accurate colours. ● Not valid on RGB, S-Video, Component, PC, HDMI and SD Card inputs
	Picture Display	<p>Turns the screen off when you select "Off" (Off / On)</p> <ul style="list-style-type: none"> ● The sound is active even if the screen turns off. ● Press any button (except Standby) to turn the screen on. ● This function is effective in reducing power consumption when listening to the sound without watching the TV screen.
	Reset to Defaults	Press the OK button to reset the present Picture Viewing Mode to the default settings

Menu	Item	Adjustments / Configurations (alternatives)	
Sound	Mode	<p>Selects the basic sound mode (Music / Speech / User)</p> <ul style="list-style-type: none"> ● The selected mode affects all input signals. <p>Music: Improves sound quality for watching music videos, etc. Speech: Improves sound quality for watching news, drama, etc.</p> <ul style="list-style-type: none"> ● In Music and Speech modes, you can adjust “Bass” and “Treble” settings, and those settings will be stored for each mode. <p>User: Adjusts the sounds manually by using the equalizer to suit your favourite sound quality.</p> <ul style="list-style-type: none"> ● For the User mode, “Equalizer” will appear on the Sound Menu instead of “Bass” and “Treble”. Select the “Equalizer” and adjust the frequency. ➔ “Equalizer” (below) 	
	Bass	Increases or decreases level to enhance or minimise lower, deeper sound output	
	Treble	Increases or decreases level to enhance or minimise sharper, higher sound output	
	Equalizer	<p>Adjusts the frequency level to suit your favourite sound quality</p> <ul style="list-style-type: none"> ● This function is available when “Mode” is set to “User”. ● Select the frequency and change the frequency level by using the cursor button. ● If you want to enhance the bass sound, raise the level of the lower frequency. If you want to enhance the treble sound, raise the level of the higher frequency. ● To reset the levels of each frequency to the default settings, select the “Reset to Defaults” by using cursor button, and then press the OK button. 	
	Balance	Adjusts volume level of right and left speakers	
	Headphone Volume	Adjusts the volume of the headphones	
	Surround	<p>Surround sound settings (Off / V-Audio / V-Audio Surround)</p> <p>V-Audio: Provides a dynamic enhancer of width to simulate improved spatial effects V-Audio Surround: Provides a dynamic enhancer of width and depth to simulate improved spatial effects</p>	
	Volume Correction	Adjusts the volume of individual channel or input mode	
	Speaker Distance to Wall	<p>Adjusts the low frequency sound (Over 30cm / Up to 30cm)</p> <ul style="list-style-type: none"> ● If the gap between the TV and wall is over 30 cm, “Over 30cm” is recommended. ● If the gap between the TV and wall is within 30 cm, “Up to 30cm” is recommended. 	
	Preferred Multi Audio	Selects the preferred language for digital channel multi audio (depending on the broadcaster) (English / Welsh / Gaelic)	
	NICAM	<p>Near Instantaneous Companded Audio Multiplex Reproduces NICAM stereo sound (Off / On)</p> <ul style="list-style-type: none"> ● Off if reception is poor (FM monaural sound) ● Analogue mode only 	
	HDMI1 / 2 / 3 Input	<p>Select to fit the input signal (Digital / Analogue) (p. 68)</p> <p>Digital : When sound is carried via the HDMI cable connection Analogue : When sound is not carried via the HDMI cable connection</p> <ul style="list-style-type: none"> ● HDMI input mode only 	
	Audio Description Menu	Audio Description	<p>Useful for visually-impaired viewers (Off / Auto)</p> <p>Set to “Auto” to activate the description sound track if available</p> <ul style="list-style-type: none"> ● The availability of audio description sound track is indicated by “AD” in the information banner (p. 15). ● DVB mode only
		Volume	<p>Adjusts the volume for Audio Description</p> <ul style="list-style-type: none"> ● DVB mode only
Speakers		<p>Set to “On” to activate the description sound track from TV speakers (Off / On)</p> <ul style="list-style-type: none"> ● DVB mode only 	
Headphones		<p>Set to “On” to activate the description sound track from headphones (Off / On)</p> <ul style="list-style-type: none"> ● DVB mode only 	
Reset to Defaults		Press the OK button to reset the present Sound Mode, Balance, Headphone Volume and Surround to the default settings	

- A different menu will be displayed while SD Card or PC is used. (p. 50 - p. 53 and p. 54 - p. 55)
- Only available items can be selected.

How to Use Menu Functions

Menu	Item	Adjustments / Configurations (alternatives)	
Setup	Timer Programming	Sets a timer to remind watching or record forthcoming programmes (p. 42)	
	Off Timer	Sets the time until the TV automatically goes to Standby mode (Off / 15 / 30 / 45 / 60 / 75 / 90 minutes) (p. 17)	
	Link Settings	VIERA Link	Sets to use VIERA Link functions (Off / On) (p. 59)
		Q-Link	Selects which AV terminal is to be used for data communication between this TV and a compatible recorder (AV1 / AV2) (p. 58) ● Select the connected terminal to the recorder even it is not compatible with Q-Link.
		AV1 / AV2 out	Chooses the signal to be transmitted from the TV to Q-Link (TV / AV1 / AV2 / AV3 / Monitor) ● Monitor: Image displayed on screen ● Component, PC and HDMI signals cannot be outputted.
		Standby Power Save	Controls the power consumption in Standby mode of the connected equipment to reduce the consumption (Off / On) (p. 60) ● This function is available when "VIERA Link" is set to "On".
		Intelligent Auto Standby	Makes non-watched or non-used connected equipment go into Standby mode to reduce the power consumption (Off / On (With reminder) / On (No reminder)) (p. 60) ● This function is available when "VIERA Link" is set to "On".
		Q-Link Download	Downloads analogue channel information to a Q-Link compatible equipment connected to the TV
	Child Lock	Locks a channel / AV input to prevent access to it (p. 44)	
	DVB Tuning Menu	Favourites Edit	Creates list of favourite DVB channels (p. 39)
		Channel List	Skips the unwanted DVB channels or edits DVB channels (p. 39)
		Auto Setup	Automatically sets the DVB channels received in the area (p. 36)
		Channel Sorting by Region	Automatically sorts tuned channels according to the available region (p. 38)
		Manual Tuning	Sets the DVB channels manually (p. 38)
		Update Channel List	Updates DVB Channel List while keeping your settings (p. 40)
		New Channel Message	Selects whether to give a notification message when a new DVB channel is found (Off / On) (p. 40)
		Signal Condition	Checks the DVB signal condition (p. 40)
	Analogue Tuning Menu	Channel List	Skips the unwanted Analogue channels or edits Analogue channels (p. 41)
		Auto Setup	Automatically sets the Analogue channels received in the area (p. 37)
		Manual Tuning	Sets the Analogue channels manually (p. 41)

Menu	Item	Adjustments / Configurations (alternatives)	
Setup	Display Settings	Teletext	Analogue teletext display mode (FASTEXT / List) (p. 22)
		Preferred Subtitles	Selects the preferred language for digital channel subtitles (depending on the broadcaster) (English / Welsh / Gaelic) ● To display subtitles ➔ p. 16
		Input Labels	Labels or skips each input terminal (p. 45)
		Banner Display Timeout	Sets how long the Information banner (p. 15) stays on screen (0 (No display) / 1 / 2 / 3 / 4 / 5 / 6 / 7 / 8 / 9 / 10 seconds)
		Playing Time Display	Set to "On" to display a continuous record of time spent using Game mode every 30 mins (Off / On) ● This function is available when "Game" is selected in "Viewing Mode" (p. 28).
		Radio Mode	Sets the timer for turning off the screen automatically when a radio channel is selected (Off / 5 / 10 / 15 / 20 seconds) ● The sound is active even if the screen turns off. ● Press any button (except Standby) to turn the screen on. ● This function is effective in reducing power consumption when listening to a radio channel.
	System Menu	Shipping Condition	Resets all settings, for example, when moving house (p. 46)
		Owner ID	Inputs the owner ID (p. 47)
		Common Interface	Uses include to watch pay-TV (p. 48)
		System Update	Downloads new software to TV (p. 49)
		Software Licence	Displays the software licence information
		System Information	Displays the system information of this TV

- A different menu will be displayed while SD Card or PC is used. (p. 50 - p. 53 and p. 54 - p. 55)
- Only available items can be selected.

How to Use Menu Functions

Menu	Item	Adjustments / Configurations (alternatives)	
Setup	GUIDE Plus+ Settings	Postcode	Sets your postcode to display advertisements in the GUIDE Plus+ system (p. 20)
		System Information	Displays the system information of the GUIDE Plus+ system
	Power on Preference	Automatically selects the input when the TV is turned on (TV / AV) Set to "TV" to view picture from TV tuner. Set to "AV" to view input from an external equipment connected to a SCART terminal, e.g. satellite receiver. ● The external equipment must be switched on and sending a control signal for automatic switching at power on to occur.	
	Power on Channel List	Automatically selects All Channels or Favourites list in the Information banner (p. 15) when the TV is turned on (All Channel List / Last) Set to "All Channel List" to display all the channels. Set to "Last" to display the one you selected last time. ● Not available on analogue mode	
	Auto Standby	Sets the time the TV automatically goes to Standby mode when no operation is performed for the selected times (Off / 2 / 4 hours) ● Starting Timer Programming automatically does not affect this function. ● Automatic input switching with the connected equipment affects this function and time-count will be reset. ● The notification message will appear 3 minutes before going to Standby mode.	
	Power Save	Reduces brightness of picture to economise on power consumption (Off / On)	
	16:9 Overscan	Selects the screen area displaying the image (Off / On) On : Enlarges the image to hide the edge of the image. Off : Displays the image in the original size. ● Set to "On" if noise is generated on the edge of the screen. ● This function is available when aspect is set to Auto (16:9 signal only) or 16:9. ● This function can be memorized separately for SD (Standard definition) and HD (High definition) signals.	
	DVI Input Setting	Changes the black level in the image for HDMI input mode with DVI input signal manually (Normal / Full) ● When the DVI input signal from the external equipment, especially from PC, is displayed, the black level may not be suitable. In this case, select "Full". ● The black level for HDMI input signal will be adjusted automatically. ● For HDMI input mode with DVI input signal only	

- A different menu will be displayed while SD Card or PC is used. (p. 50 - p. 53 and p. 54 - p. 55)
- Only available items can be selected.
- If "Demo Settings" item is displayed in the Setup Menu, the TV is in "Shop" viewing environment. To return to "Home" viewing environment initialise all settings by accessing Shipping Condition.
 - ➔ "Shipping Condition" (p. 46)

■ Overview (Picture, Sound)

● How to operate → p. 27

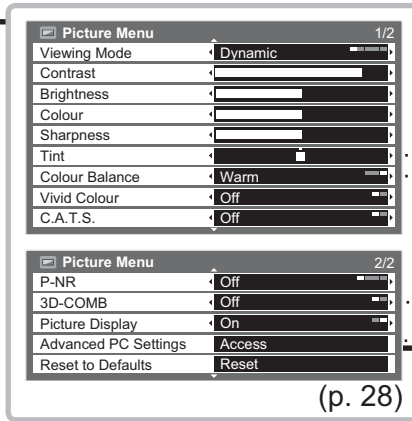
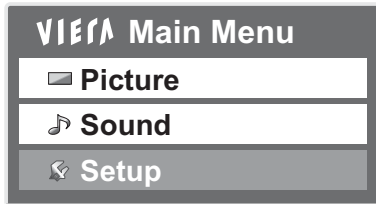

Available in NTSC

Not available when "Viewing Mode" is set to "True Cinema"

Available in NTSC / PAL

Available in PC

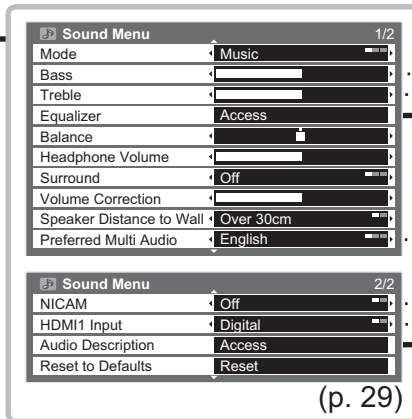
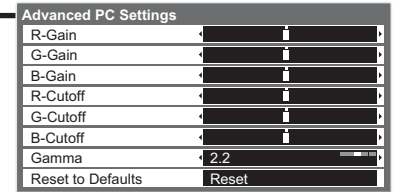

Available when "Mode" is set to "Music" or "Speech"

Available when "Mode" is set to "User"

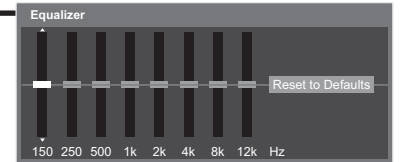

Available in DVB

Available in Analogue

Available in HDMI

Available in DVB

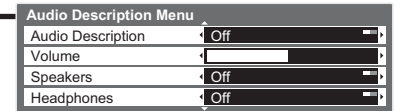

How to Use Menu Functions

■ Overview (Setup)

- How to operate → p. 27

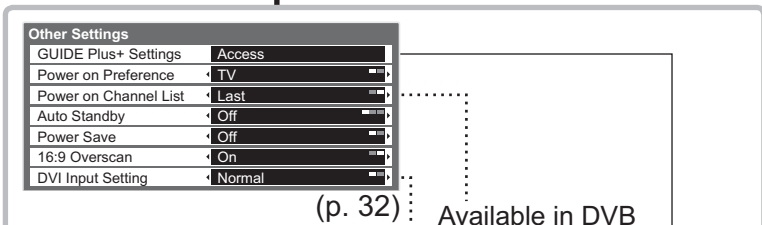
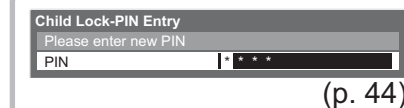
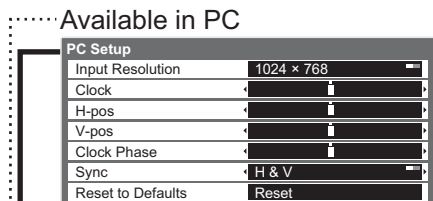
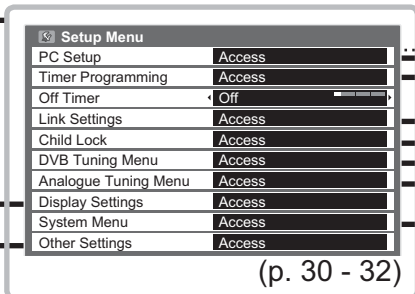
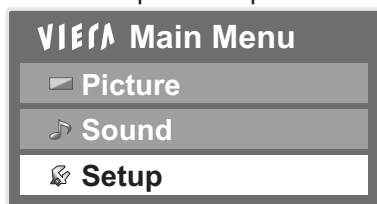

Available in DVB
Available in HDMI with DVI input signal

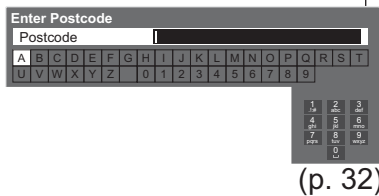
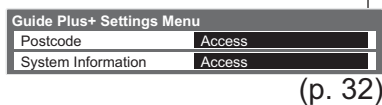

Available in DVB

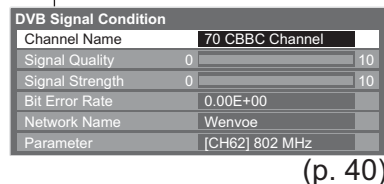
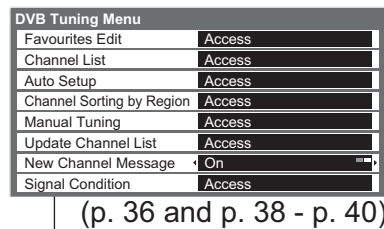

Available in Analogue

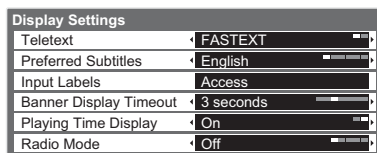
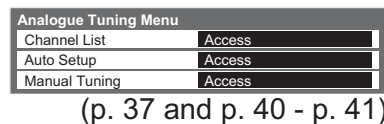

Available in Analogue
Available in DVB

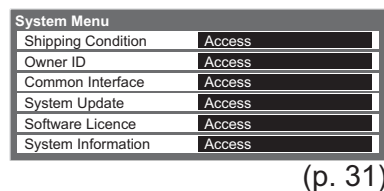
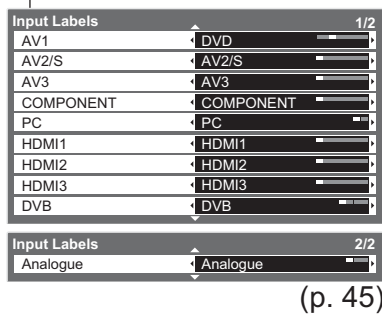

Timer Programming Wed 28 Oct 2009 10:46

Function	No.	Channel Name	Date	Start	End
Ext Rec.	D 1	BBC ONE DIT-SDS	Wed 28 Oct	20:00	20:30 (30 min.)
Reminder	D 14	E4 The Bill	Wed 29 Oct	21:00	22:30 (90 min.)
Ext Rec.	D 72	BBC 2W <TIMER>	Wed 28 Oct	22:45	23:00 (15 min.)
Ext Rec.	D 1	BBC ONE Red Cap	Thu 29 Oct	10:30	11:30 (60 min.)

(p. 43)

Link Settings 1/2

VIERA Link	On
Q-Link	AV2
AV2 out	TV
Standby Power Save	On
Intelligent Auto Standby	On (No reminder)
Q-Link Download	Access

(p. 30)

Sending Preset Data

Please wait!

0% 100%

Remote control unavailable

(p. 30)

Child Lock

Change PIN	Access
Child Lock List	Access

(p. 44)

Child Lock List - TV and AV

Name	Input	Type	Lock
4 BBC 1 Wales	DVB	Free TV	
7 BBC THREE	DVB	Free TV	🔒
14 E4	DVB	Free TV	
VCR	Analogue	Analogue	
1 BBC1	Analogue	Analogue	
2 *****	Analogue	Analogue	🔒
AV1	External	AV	
AV2/S	External	AV	

(p. 44)

DVB Auto Setup

Progress CH 21 68

This will take about 3 minutes.

CH	Channel Name	Type	Quality
62	CBBC Channel	Free TV	10
62	BBC Radio Wales	Free TV	10
62	E4	Free TV	10
62	Cartoon Nwk	Free TV	10

Free TV: 4 Pay TV: 0 Radio: 0 Data: 0

Searching

(p. 36)

All DVB Channels

<input checked="" type="checkbox"/>	70	CBBC Channel
<input checked="" type="checkbox"/>	72	Cartoon Nwk
<input checked="" type="checkbox"/>	105	BBC1
<input type="checkbox"/>	719	BBC Radio Wales
<input type="checkbox"/>	720	BBC Radio Cymru
<input type="checkbox"/>	1	BBC ONE Wales
<input checked="" type="checkbox"/>	7	BBC THREE

(p. 39)

DVB Favourites Editor

All DVB Channels	Favourites1
1 BBC One Wales	
7 BBC THREE	
14 E4	
70 CBBC Channel	
72 Cartoon Nwk	
105 BBC1	
719 BBC Radio Wales	
720 BBC Radio Cymru	

(p. 39)

DVB Update Channel List

Progress CH 21 68

This will take about 3 minutes.

CH	Channel Name	Type	Quality

Free TV: 0 Pay TV: 0 Radio: 0 Data: 0

Searching

(p. 40)

DVB Manual Tuning

Frequency: 0021 470 MHz

Signal Quality: 0 10

Signal Strength: 0 10

No.	Channel Name	Type	New

Free TV: 0 Pay TV: 0 Radio: 0 Data: 0

Stopped

(p. 38)

Channel Sorting by Region

GBR>

Best signal quality (All Regions)

England Regions>

Region choice available

(p. 38)

Analogue Manual Tuning

1 BBC1 CH33

Manual Tuning 21 68

(p. 41)

Analogue Auto Setup

Scan CH 21 68

This will take about 3 minutes.

CH	Channel Name
29	
30	

Analogue: 2

Searching

(p. 37)

Analogue Channel List

<input checked="" type="checkbox"/>	1	BBC1
<input type="checkbox"/>	2	*****
<input type="checkbox"/>	3	*****
<input checked="" type="checkbox"/>	4	
<input checked="" type="checkbox"/>	5	
<input checked="" type="checkbox"/>	6	
<input checked="" type="checkbox"/>	7	

(p. 41)

Available in DVB

Common Interface

Slot 1: Module inserted

(p. 48)

Owner ID

Please enter PIN for access

PIN | * * * *

(p. 47)

Shipping Condition

All tuning data will be erased
Are you sure?
Are you sure?

(p. 46)

System Update

Auto Update Search in Standby	On
System Update Search Now	Access

(p. 49)

Retuning from Setup Menu

Auto Setup retunes all channels automatically.

DVB channels

Automatically retune all DVB channels received in the area.

- Only DVB channels are retuned in DVB mode.
- All the previous tuning settings (Favourites Edit and Channel List, etc.) are erased.
- If a Child Lock PIN number (p. 44) has been set, it must be entered.



- Select DVB**
TV
- Display the menu**
MENU
- Select "Setup"**

VIEWA Main Menu	
Picture	
Sound	
Setup	
- Select "DVB Tuning Menu"**

Setup Menu	
Timer Programming	
Off Timer	Off
Link Settings	
Child Lock	
DVB Tuning Menu	Access
Display Settings	
System Menu	
Other Settings	
- Select "Auto Setup"**

DVB Tuning Menu	
Favourites Edit	
Channel List	
Auto Setup	Access
Channel Sorting by Region	
Manual Tuning	
Update Channel List	
New Channel Message	On
Signal Condition	
- Start Auto Setup**

DVB Auto Setup	
All DVB tuning data will be erased	OK

DVB Auto Setup			
Progress CH 21 68			
This will take about 3 minutes.			
Ch	Channel Name	Type	Quality
62	CBBC Channel	Free TV	10
62	BBC Radio Wales	Free TV	10
62	E4	Free TV	10
62	Cartoon Nwk	Free TV	10
Free TV: 4 Play TV: 0 Radio: 0 Data: 0			
Searching			

To return to TV
EXIT

For Auto Setup, using the buttons on the side panel of the TV (p. 9)

- ① Press repeatedly until "Auto Setup" appears
F
- ② Access "Auto Setup"
TV
- ③ Start "Auto Setup"
TV

To return to TV → F

When the operation is completed, the channel at channel position "1" will be displayed.

Note

- If tuning has not been done completely
→ "Manual Tuning" (p. 38)

Analogue channels

Automatically retune all Analogue channels received in the area.

- Only Analogue channels are retuned in Analogue mode.
- All the previous tuning settings are erased.
- If a Child Lock PIN number (p. 44) has been set, it must be entered.

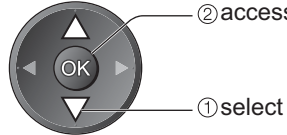
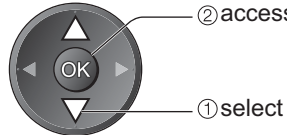

- 1 Select Analogue**
TV
- 2 Display the menu**
MENU
- 3 Select "Setup"**
Main Menu
Picture
Sound
Setup
- 4 Select "Analogue Tuning Menu"**
Setup Menu
Timer Programming
Off Timer Off
Link Settings
Child Lock
Analogue Tuning Menu Access
Display Settings
System Menu
Other Settings

■ To return to TV



- 5 Select "Auto Setup"**
Analogue Tuning Menu
Channel List
Auto Setup Access
Manual Tuning



■ For Auto Setup, using the buttons on the side panel of the TV (p. 9)

① Press repeatedly until "Auto Setup" appears

F

② Access "Auto Setup"

TV

③ Start "Auto Setup"

TV

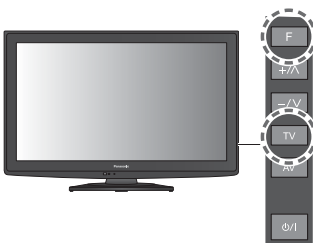

● To return to TV → F

- 6 Start Auto Setup**
Analogue Auto Setup
All analogue tuning data will be erased

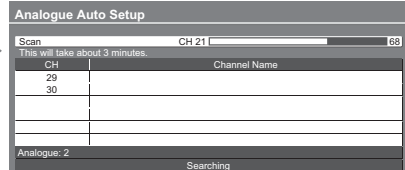
Settings are made automatically

- The analogue settings are downloaded to a Q-Link compatible equipment connected to the TV in Analogue mode.

When the operation is completed, the channel at channel position "1" will be displayed.

Note

- If tuning has not been done completely
→ "Manual Tuning" (p. 41)

Tuning and Editing Channels (DVB)

You can retune channels or make your favourite channel lists, skip unwanted channels, etc.

- 1 **Select DVB**
- 2 **Display the menu**
- 3 **Select "Setup"**

VIERA Main Menu	
Picture	
Sound	
Setup	
- 4 **Select "DVB Tuning Menu"**

Setup Menu	
Timer Programming	
Off Timer	Off
Link Settings	
Child Lock	
DVB Tuning Menu	Access
Display Settings	
System Menu	
Other Settings	
- 5 **Select one of the following functions**

DVB Tuning Menu	
Favourites Edit	Access
Channel List	Access
Auto Setup	Access
Channel Sorting by Region	Access
Manual Tuning	Access
Update Channel List	Access
New Channel Message	On
Signal Condition	Access

 - Auto Setup
 - ➔ "Retuning from Setup Menu" (p. 36)
- 6 **Set**

■ **To return to TV**
 ➔

Sort DVB channels according to the region Channel Sorting by Region

You can sort DVB channels so that those with the best signal quality, or those for your preferred region, appear nearer the top of your Channel List. Normally, you should select "Best signal quality (All Regions)".

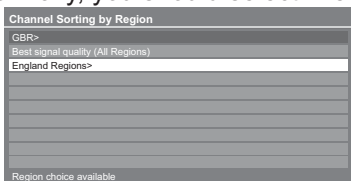

(select repeatedly until you reach the available region)

● If you choose to select your preferred region, you could find channels with a weaker signal appear nearer the top of your Channel List. If you have any image or sound problems, select "Best signal quality (All Regions)" instead.

Set DVB channel manually Manual Tuning

Normally use "Auto Setup" or "Update Channel List" to retune DVB channels. If tuning has not been done completely or for adjusting the direction of the aerial, use this function.

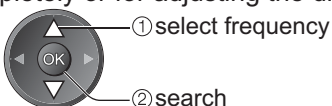
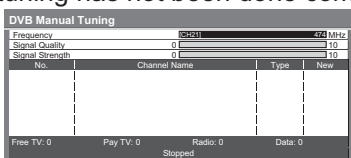

● All channels found will be added to the Channel List.

List favourite DVB channels **Favourites Edit**

Create your favourite channel lists from various broadcasters (up to 4: Favourites1 to 4). The DVB Favourites lists are available for switching in the Information banner (p. 15) and from "Category" in the TV Guide (p. 18).

① Select a channel to list

select → → To display other Favourites → green

Encrypted channel

② Add it to the Favourites list

→ To add all channels to the list → yellow

A channel is added

■ To edit Favourites list

Select the field of Favourites to edit and:

• To delete a channel → Select the channel → → To delete all channels → yellow

• To name the Favourites → → Set characters one by one (maximum: ten characters) → Store

① select ② set

You can set characters by using numeric buttons.
→ "Characters table for numeric buttons" (p. 67)

• To move the channel → → Select the new position → Confirm green

or

Select the turn

③ Store

→

Note

• Channel position numbers (known as logical channel numbers) can be swapped in Channel List. To swap the channel position number → "Channel List" (below)

Skip unwanted DVB channels, Edit DVB Channels **Channel List**

You can hide unwanted DVB channels. The hidden channels cannot be displayed except in this function. Use this function to skip unwanted channels.

Select a channel and reveal / hide

② reveal / hide ① select

: reveal → To reveal all channels yellow
 : hide (skip)

■ To edit channels

You can also edit each channel in Channel List.

Select a channel to edit and:

• To retune each channel - Manual Tuning (p. 38) (only for the revealed channels) → red

• To swap the channel position number → → Enter the new position number → Store green

Channel position number

Tuning and Editing Channels

Update DVB channel automatically **Update Channel List**

You can add new channels, delete removed channels, update channel name and position automatically to Channel List.



- Channel List is updated while keeping your settings in Favourites Edit, Channel List, Child Lock, Timer Programming, etc.

Display a notification message **New Channel Message**

Selects whether to give a notification message when a new DVB channel is found. **(Off / On)**



- Selecting OK will perform "Update Channel List".

Check DVB signal **Signal Condition**

Selects a channel and checks the DVB signal condition.

- To change the channel →

DVB Signal Condition	
Channel Name	70 CBBC Channel
Signal Quality	0
Signal Strength	0
Bit Error Rate	0.00E+00
Network Name	Wenvoe
Parameter	[CH62] 802 MHz

A good Signal Strength is not an indication of best signal for DVB reception. Please use the Signal Quality indicator as follows:

Signal Quality:

- Green bar → Good
- Yellow bar → Poor
- Red bar → Bad (Check the Terrestrial aerial)

(Analogue)

You can retune channels or skip unwanted channels, edit channels etc.



1 Select Analogue



2 Display the menu



3 Select "Setup"

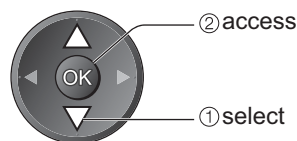
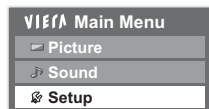

4 Select "Analogue Tuning Menu"

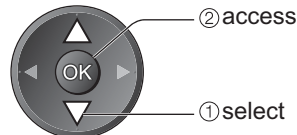
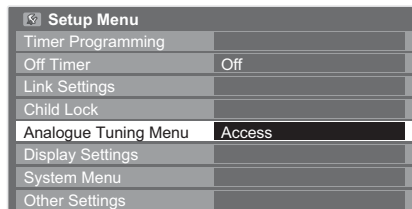

5 Select one of the following functions

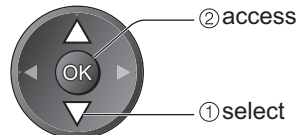
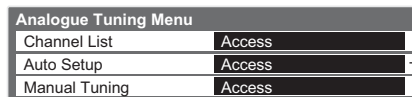

- Auto Setup → "Retuning from Setup Menu" (p. 37)

■ To return to TV



6 Set

Skip unwanted Analogue channels, Edit Analogue channels Channel List

You can hide unwanted Analogue channels.
The hidden channels cannot be displayed except in this function. Use this function to skip unwanted channels.

Select a channel and reveal / hide

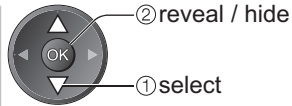
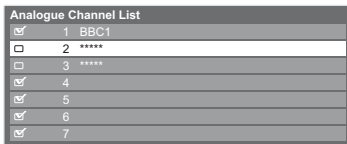

- : reveal
- : hide (skip)

- To reveal all channels → yellow

To edit channels

You can also edit each channel in Channel List.



Select a channel to edit and:

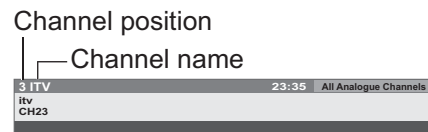

- To retune each channel - Manual Tuning (below) → red

- To move the channel position → green → Select the new position → Store green

- To rename the channel name → blue → Set characters one by one (maximum: five characters) → Store RETURN

- You can set characters by using numeric buttons. → “Characters table for numeric buttons” (p. 67)

Note

- If a VCR is connected only with the RF cable, edit “VCR”.

Set Analogue channel manually Manual Tuning

Set Analogue channel manually after Auto Setup.

- If a VCR is connected only with the RF cable, it is recommended to select channel position “0”.



Select the channel position



Select the channel



Search and store

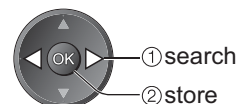

Timer Programming

Timer Programming from Menu

The Timer Programming menu allows you to choose programmes that you wish to remind watching or record to the external recorder. At the correct time, the TV will tune to the correct channel automatically to record even if the TV is in Standby mode.

TV Guide may also be used to set timer programming event (p. 19).

- Timer Programming can store up to 15 events.
- For recording using Timer Programming, the TV must be either On or in standby. For reminders to be displayed, the TV must be On.
- No other channel can be selected while Ext Rec. of a Timer Programming is in progress.
- It may not be possible to record an encrypted programme (which is copy-protected).
- When recording programmes, be sure to make the proper settings on the recorder connected to the TV. If a compatible recorder with Q-Link or similar technologies is connected to the TV (p. 58) and the "Link Settings" (p. 30) are correct, no setting of the recorder is required. Also read the manual of the recorder.
- If the recorder is not compatible with Q-Link or similar technologies, set "Q-Link" in the Setup Menu (p. 30) to the connected terminal (AV1 or AV2), and set the timer of the recorder in addition to the Timer Programming on the TV. For preparations of a recorder, read the manual of the recorder.
- Recordings are always in standard definition composite video via SCART, even if the original programme is in high definition.

1 Select the tuner you want to use (DVB or Analogue)
TV

2 Display the menu
MENU

3 Select "Setup"

VIEW Main Menu	
Picture	
Sound	
Setup	

4 Select "Timer Programming"

Setup Menu	
Timer Programming	Access
Off Timer	Off
Link Settings	
Child Lock	
DVB Tuning Menu	
Display Settings	
System Menu	
Other Settings	

5 Set

To return to TV
EXIT

To unlock the tuner (stop recording)
GUIDE → EXIT

Note

- Check that the LED is orange. If not, timer programmes are not active or not stored.
- Timer Programming reminder messages will remain displayed until one of the following occurs:
 - You press the OK button to view the programme or the EXIT button to cancel the reminder.
 - The timer programming event that the reminder is set for ends.
- "!" identifies that any timer programming events have overlapped. "Ext Rec." is given priority over "Reminder". When two or more "Ext Rec." overlap, the first timer programming event starts and finishes as programmed. The next timer programming event will then start.
- 2 mins. before the starting time, a reminder message appears if you are watching TV.
 - To remove the message and start the programme → OK
 - To cancel the Timer Programming → EXIT
- Ext Rec. of Timer Programming will automatically change to the programmed channel 10 seconds before the start time.
- To stop recording of the timer programming event, it may be necessary to stop the recorder manually.
- Ext Rec. of Timer Programming will be performed even if the TV is in Pause Live TV recording (p. 61). In this case, the Pause Live TV recording will be cancelled.

Set timer programming event details Timer Programming

① Start making the settings



② Select the function (Reminder or Ext Rec.)



select

Ext Rec. : to record the programme to the recorder



When the start time comes, the channel will be switched automatically and the video and audio signals will be output. 2 mins. before the starting time, a reminder message appears if you are watching TV.

Reminder: to remind you to watch the programme



When you are watching TV, a reminder message appears 2 mins. before the start time. Press the OK button to switch to the programmed channel.

③ Set the channel, date and time (repeat the operations as below)

Set items in the order of ① to ④.



select the item

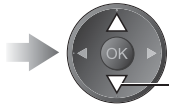

set

● ①, ③ and ④ can also be entered with numeric buttons.



Displayed if the timer programming events are overlapped

Timer programming - Programmes according to the time setting

Guide: Guide link programming - Programmes according to the TV Guide signal (p. 19)

S/P: Split Programme programming (p. 19)

Timer Programming		Wed 28 Oct 2009 10:46			
Function	No.	Channel Name	Date	Start	End
Ext Rec.	D 72	BBC 2W <TIMER>	Wed 28 Oct	20:00	21:30 (90 min.)
Reminder	D 14	E4 The Bill	Wed 28 Oct	21:00	22:00 (60 min.)
Ext Rec.	D 1	BBC ONE DIY SOS	Wed 28 Oct	22:45	23:00 (15 min.)
Ext Rec.	D 1	BBC ONE <TIMER>	STTL Thu 29 Oct	10:30	11:30 (60 min.)

Records with subtitles (if available)

● To indicate this → (press again to remove subtitles)

Duration (automatic display)

④ Ending time

③ Starting time

① Channel number ② Date

D: DVB

A: Analogue

● You cannot change the mode within the menu.



one day ahead

daily or weekly (press repeatedly)

● Daily Sun-Sat: Sunday to Saturday

● Daily Mon-Sat: Monday to Saturday

● Daily Mon-Fri: Monday to Friday

● Weekly Sat/Fri/Thu/Wed/Tue/Mon/Sun: Same time on the same day every week

④ Store



■ To change a timer programming event

→ Select the programme to be changed



② access

① select

→ Correct as necessary (as above)

■ To cancel a timer programming event

→ Select the programme to be deleted



red



OK

■ To record with subtitles (if available)

→ Select the programme to record with subtitles



yellow

● Each time pressed: auto ↔ off

■ To cancel a timer programming event temporarily

→ Select the programme to be cancelled



blue

● Each time pressed: cancel ↔ stop cancelling

■ To view details of the programming (only for Guide link programming)

→ Select the programme to be viewed



i

● Press again to return to Timer Programming menu.

■ Guide link programming (Timer Programming from the TV Guide signal) → p. 19

● This function is not available in Analogue mode.

Guide link programming is Timer Programming which is controlled by information from the TV Guide; if programme start and end times are changed by the broadcaster, the timer programming event will follow the change.

A Split Programme programming is a Guide link programming which is interrupted by one or more other programmes.

Note that Guide link programming (including Split Programme programming) only works reliably if correct information is received from broadcasters.

Child Lock

You can lock specific channels / AV input terminals and control who watches them. When the locked channel / input is selected, a message appears; by entering the PIN number, you can watch it.

1 Display the menu
MENU

2 Select "Setup"
VIERA Main Menu
Picture
Sound
Setup

3 Select "Child Lock"
Setup Menu
Timer Programming
Off Timer Off
Link Settings
Child Lock Access
DVB Tuning Menu
Display Settings
System Menu
Other Settings

4 Set
EXIT

Control channel audience Child Lock

1 Enter the PIN number (4 digits)

Child Lock-PIN Entry
Please enter new PIN
PIN

- Enter the PIN number twice at first setting.
- Make a note of the PIN number in case you forget it.

2 Select "Child Lock List"

Child Lock
Change PIN
Child Lock List Access

3 Select the channel / input to be locked

Name	Input	Type	Lock
4 BBC 1 Wales	DVB	Free TV	Lock
7 BBC THREE	DVB	Free TV	Lock
14 E4	DVB	Free TV	Lock
VCR	Analogue	Analogue	Lock
1 BBC1	Analogue	Analogue	Lock
2 ****	Analogue	Analogue	Lock
AV1	External	Analogue	Lock
AV2/S	External	AV	Lock

Appears when the channel / input is locked

- To cancel → Select the locked channel / input → OK
- To jump to the top of the next input → red
- To lock all → green
- To cancel all locks → yellow

To change the PIN number
Select "Change PIN"

Child Lock
Change PIN Access
Child Lock List

Enter a new PIN number twice

Note

- Setting "Shipping Condition" (p. 46) erases the PIN number and all settings.

Input Labels

For easier identification and selection of the input mode, you can label each input mode or skip terminals that are not connected to any equipment.

- To select the input mode → p. 24

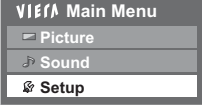

1 Display the menu

2 Select "Setup"

3 Select "Display Settings"

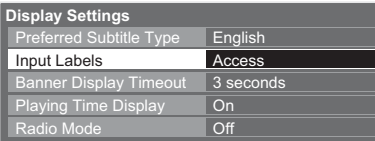
4 Select "Input Labels"

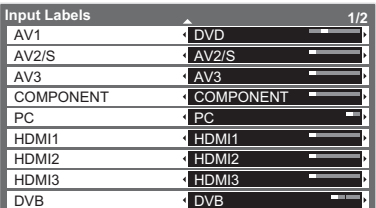
5 Select a input terminal and set

■ To return to TV

The labels you set will be displayed in the "Input Selection" menu (p. 24) or banner.

- If "Skip" is selected, the input will not be displayed in the "Input Selection" menu and you cannot select the mode.

■ User input

You can name each input mode yourself.

Select "User input"

Set characters one by one
 (maximum: ten characters)

Store

- You can set characters by using numeric buttons.
 → "Characters table for numeric buttons" (p. 67)

Shipping Condition

Resets the TV to its original condition with no channels tuned in. All settings other than "Owner ID" are reset (channels, picture, sound settings, etc.).



1 Display the menu



2 Select "Setup"

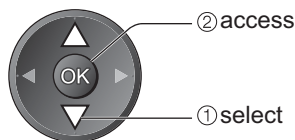
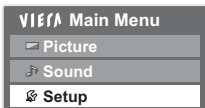

3 Select "System Menu"

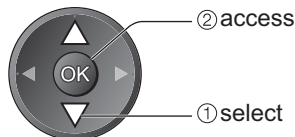
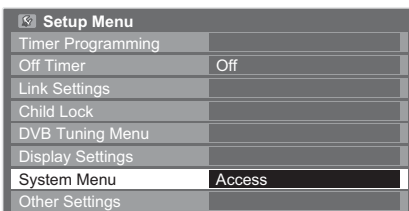

4 Select "Shipping Condition"

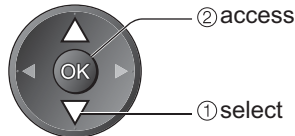
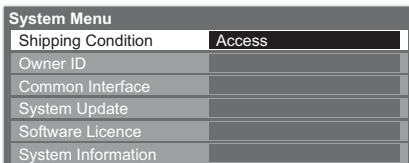

5 Set

■ To return to TV



Restore Settings Shipping Condition

① Check the message and initialise

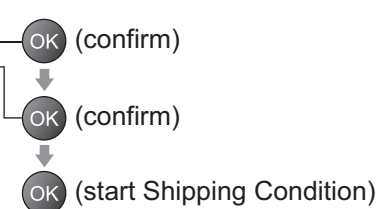
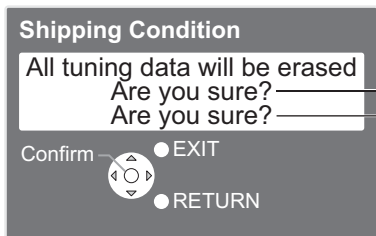

② Follow the on screen instructions



● "Auto Setup" will automatically start when Mains power On / Off switch is next turned On. (p. 12)

■ To retune TV channels only, e.g. after moving house

➔ "Retuning from Setup Menu" (p. 36 and p. 37)

Owner ID

Entry of the PIN number and personal information (your name, address and postcode).
In the unfortunate event of theft, the Owner ID will help the Police to determine the owner.

- 1 Display the menu**
MENU
- 2 Select "Setup"**
VIERA Main Menu
Picture
Sound
Setup
- 3 Select "System Menu"**
Setup Menu
Timer Programming
Off Timer Off
Link Settings
Child Lock
DVB Tuning Menu
Display Settings
System Menu Access
Other Settings
- 4 Select "Owner ID"**
System Menu
Shipping Condition
Owner ID Access
Common Interface
System Update
Software Licence
System Information
- 5 Set**
EXIT

Input owner ID Owner ID

① Enter the PIN number (4 digits)

- Enter the PIN number twice at first setting.
- Make a note of the PIN number in case you forget it. The PIN number cannot be reset.

② Enter your name, house number, and postcode, in that order

Select NAME / HOUSE NO / POSTCODE

Set characters one by one

Return to select other items

RETURN



or

Exit the menu



■ To check the personal information stored

Hold down for about 6 sec.



- The PIN number is not displayed.



■ To change the PIN number

Select "PIN"

Enter a new PIN number twice

Using Common Interface

The Common Interface Module menu provides access to software contained on Common Interface (CI) Modules.

This TV works only Pay TV modules complying with CI standard.

- This function is not available for BSkyB's Sky channels.

Caution

- Turn Off Mains power On / Off switch whenever inserting or removing the CI module.
- If a viewing card and a card reader come as a set, first insert the card reader, then insert the viewing card into the card reader.
- Insert the module in the correct direction.

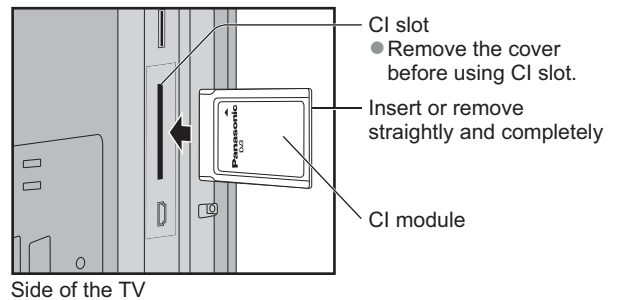

Insert the CI module (optional)

- The features that appear on screen are dependent on the contents of the selected CI module.
- Follow the instructions that came with the viewing card to tune in the pay-TV channels. If pay-TV channels do not appear, perform the below to verify the card is recognized by the TV.
- For more details, see the manual of the CI module, or check with the broadcaster.

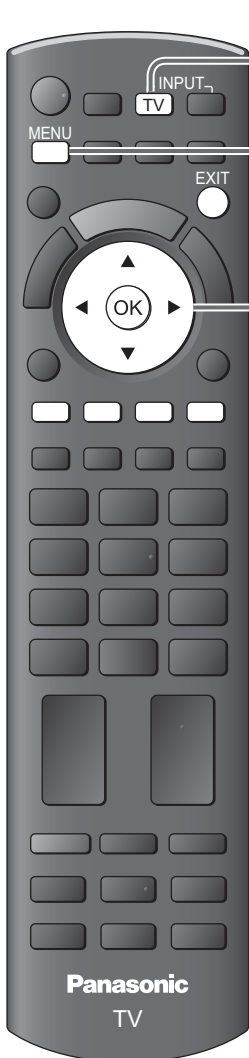

1 Select DVB



2 Display the menu



3 Select "Setup"

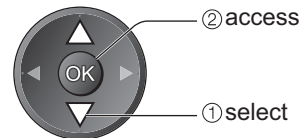
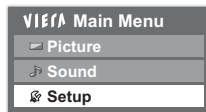

4 Select "System Menu"

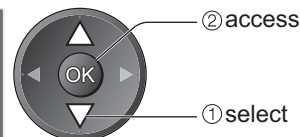
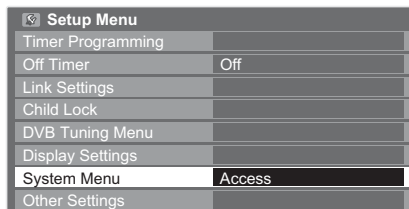

5 Select "Common Interface"

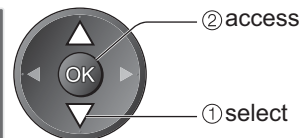
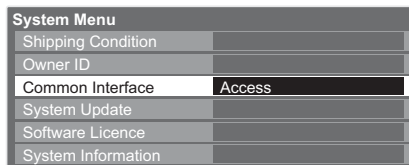

6 Access Common Interface



7 Follow the on screen operation guide (Check the instructions provided with the CI module)

For example: select, go →



Coloured characters → red green yellow blue

■ To return to TV
EXIT
→

- On screen operation guide may not correspond to the remote control buttons.

Updating the TV Software

From time to time, a new version of software may become available for download to enhance the performance or operations of the TV.

In DVB mode, a notification banner will appear when one of the BBC channels is turned to if a new available software is found.

- To download →
- If you choose not to download →

You can update any new software automatically, or manually.

- 1 Display the menu**
MENU
- 2 Select "Setup"**
VIERA Main Menu
Picture
Sound
Setup
- 3 Select "System Menu"**
Setup Menu
Timer Programming
Off Timer Off
Link Settings
Child Lock
DVB Tuning Menu
Display Settings
System Menu Access
Other Settings
- 4 Select "System Update"**
System Menu
Shipping Condition
Owner ID
Common Interface
System Update Access
Software Licence
System Information
- 5 Set**
EXIT

Update TV's software system **System Update**

■ To update automatically

Select "Auto Update Search in Standby" and set to "On"

- Automatically performs a search in standby and downloads an update, if any software updates are available.
- The automatic updating is performed at night under the following conditions:
 - Standby (TV turned Off with the remote control)
 - Ext Rec. of Timer Programming or Direct TV Recording is not in progress.

If System Update is performed, the software will be updated (it may change TV functions). If you do not wish to do so, set "Auto Update Search in Standby" to "Off". The notification banner will keep appearing during the period of new software availability, usually 2 to 3 days.

■ To update immediately

Select "System Update Search Now"

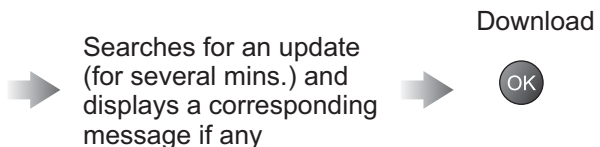

Note

- Download may take up to 60 mins.
- During software download and update, DO NOT perform any operations on the TV or switch Off the TV.

Using Media Player

Viewing from SD Card (VIERA IMAGE VIEWER)

Photo mode : Still pictures recorded by digital cameras will be displayed.

Video mode : Moving pictures recorded by digital video cameras will be played back.

- During the operation, audio signal is output from AV1, AV2, AUDIO OUT and DIGITAL AUDIO OUT terminals, but no video signals are output. AV1 and AV2 can output audio signal if "AV1 / AV2 out" is set to "Monitor" in the Setup Menu (p. 30).
- "Date" shows the date on which the recording was made by the digital camera or digital video camera. The file without record of the date is shown "***/**/*****".
- For details on SD Cards → p. 67

■ To insert the SD Card
Gently insert the SD Card label surface facing front.

■ To remove the SD Card

Photo mode

Photo mode will read all ".jpg" extension files in the card.

1 Insert the SD Card and start Media Player

Media Player

Signal output from all AV terminals will be disabled during Media Player view.

Press OK to proceed.

Press EXIT to return to TV viewing.

OK

2 Select "Photo"

OK
 ① select
 ② access

- You can also access Photo mode directly by using VIERA TOOLS.
- "How to Use VIERA TOOLS" (p. 26)

images that could not be loaded etc.

(Thumbnail - All photos)

The thumbnail of all the photos on the SD Card will be displayed.

- To change the background music → "Photo Setup" (p. 51)
- To display the information of the highlighted photo

→

File name	1/48	file number / total file number
Date	p1010001.JPG	
Size	23/10/2009	
	1600X1200	

■ To return to TV



■ To return to the previous screen



■ Single view - Photos are displayed one at a time. Select the file from the thumbnail of photos to be viewed

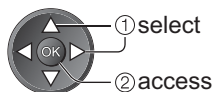

- To display / hide the operation guide →

■ To operate Single view

- To the previous photo
- Rotate 90° (anti-clockwise)
- To the next photo
- Slideshow
- Rotate 90° (clockwise)

- To return to thumbnail →

■ Slideshow - Slideshow will complete when all photos have been viewed within the present thumbnail. Select the file from the thumbnail of photos for the first view



- To display / hide the operation guide →
- To pause (return to Single view) →
- To return to thumbnail →

Photo Setup

Choose the settings for Photo mode.

Display the menu



Select "Photo Setup"

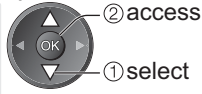
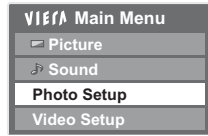

Select the items and set

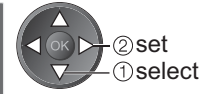
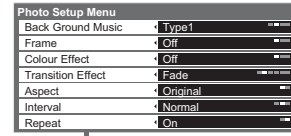

● Other items → p. 28, 29 and p. 53

Menu	Item	Adjustments / Configurations (alternatives)
Photo Setup	Back Ground Music	Selects the back ground music during the Photo mode (Off / Type1 / Type2 / Type3) ● Type1, Type2 and Type3 are the fixed music each installed in this TV.
	Frame	Selects the frame type of the slideshow (Off / Multi / Collage) Multi : 9 photos are displayed orderly at once. Collage: Each photo is displayed at a random position and random scale.
	Colour Effect	Selects the colour effect of photos on Single view and Slideshow (Off / Sepia / Gray scale)
	Transition Effect	Selects the transition effect for switching the photo during the slideshow (Off / Fade / Slide / Dissolve / Motion / Random) Fade : The next photo fades in gradually. Slide : The next photo slides and appears from the left side. Dissolve : Each photo is dissolved when switching to the next photo. Motion : Each photo is displayed with an effect of enlarging, reducing, moving up or moving down. Random : Each transition is selected at random. ● This function is available when "Frame" is set to "Off".
	Aspect	Selects whether enlarged or original viewing on Single view and Slideshow (Original / Zoom) ● Depending on the photo size, it may not be fully enlarged to fill the screen, e.g. portrait style picture.
	Interval	Selects slideshow interval (Short / Normal / Long)
	Repeat	Slideshow repeat (Off / On)

Change to the Video mode

You can switch to the Video mode of the Media Player from the thumbnail view.

While the thumbnail is displayed, display the contents selection

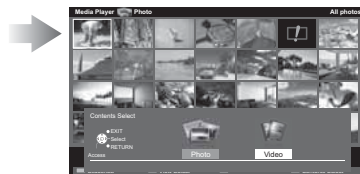

● For details of the Video mode operations → "Video mode" (p. 52)

■ To sort by folder, recorded date or recorded month

Display the view selection



Select the sort type

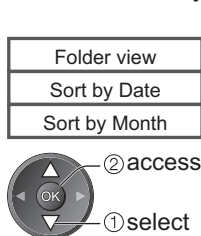

Displays the thumbnail grouped by folder
● The files which are not into a folder will be collected to the folder named "/".

Displays the thumbnail grouped by the same date
● The group of the photos without recorded date is shown as "Unknown".

Displays the thumbnail grouped by the same month
● The group of the photos without recorded date is shown as "Unknown".

Select one of the sorted group to display the thumbnail of the selected group

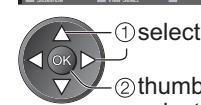
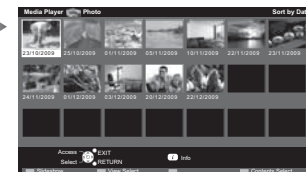

● To display the information of the highlighted group

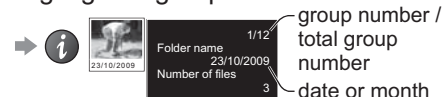

● To return to the thumbnail of all photos



● "All photos"

Using Media Player

Viewing from SD Card (VIERA IMAGE VIEWER)

Video mode

Video mode supports AVCHD and MPEG2 file formats.



1 Insert the SD Card and start Media Player

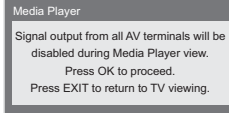

2 Select "Video"

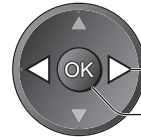
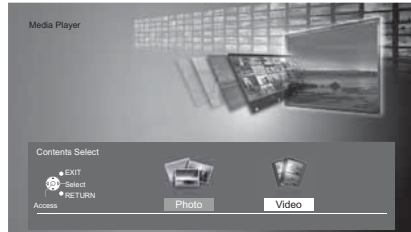

① select

② access

- You can also access Video mode directly by using VIERA TOOLS
- ➔ "How to Use VIERA TOOLS" (p. 26)



images that could not be loaded etc.

The thumbnail of video titles on the SD Card will be displayed. The preview will start when the title is highlighted if it supports a preview.

- To turn off the preview
- ➔ "Video Setup" (p. 53)
- To display the information of the highlighted title

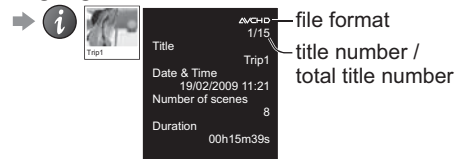

■ Playback from Title view

Playback of the selected title will start. Select the title Start playback



■ Playback from the selected scene in the title

Playback will start from the selected scene to the end of the title. Select the title Select the scene to start playback

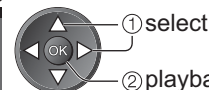
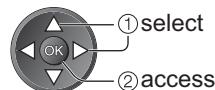

The preview will start when the scene is highlighted if it supports a preview.

- To turn off the preview
- ➔ "Video Setup" (p. 53)

- To repeat playback
- ➔ "Video Setup" (p. 53)
- To display the information of the highlighted scene

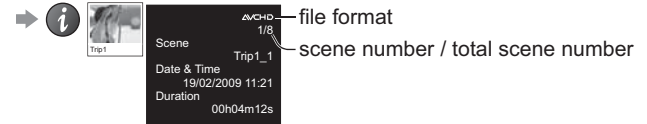

■ How to operate in the playback

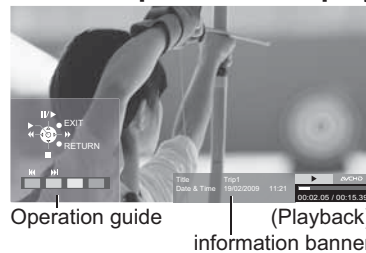

- To change aspect (only for the 4:3 video content)
- ➔ ASPECT
- To return to thumbnail
- ➔ RETURN

- To display / hide the operation guide and information banner
- ➔ i

- To operate the playback

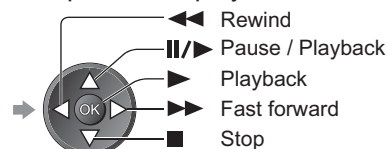

- To the previous scene
- ➔ red

- To the next scene
- ➔ green

■ To return to TV



■ To return to the previous screen



Sound Settings

You can enjoy the multi-channel sound via an amplifier connected to DIGITAL AUDIO OUT terminal.

■ To confirm or change the current sound status (during playback)

Display the Option menu

Change the sound (if the video has multiple audio signals)



● It may take several seconds to change the sound.

■ Audio output settings

Display the menu

Select "Sound"

Select "SPDIF Selection" and set

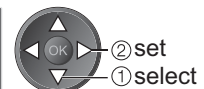
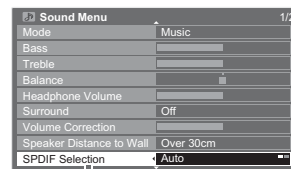
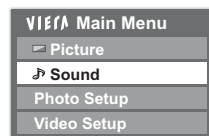

Menu	Item	Adjustments / Configurations (alternatives)
Sound	SPDIF Selection	SPDIF : A standard audio transfer file format Selects the initial setting for digital audio output signal from DIGITAL AUDIO OUT terminal (Auto / PCM) Auto: Dolby Digital is output as Dolby Digital Bitstream. MPEG is output as PCM. PCM: Digital output signal is fixed to PCM.

Video Setup

Choose the settings for Video mode.

Display the menu

Select "Video Setup"

Select "Other Settings"

Select the items and set

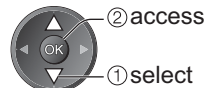
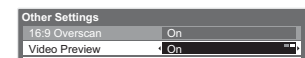
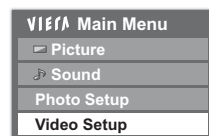

● Display Settings
➔ p. 31

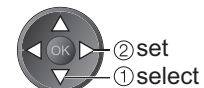

● 16:9 Overscan
➔ p. 32

● Other items
➔ p. 28, 29 and p. 51

Menu	Item	Adjustments / Configurations (alternatives)
Video Setup	Other Settings	
	Video Preview	Sets to start the preview of the title or scene in the thumbnail screen (Off / On) ● Image may not be displayed for an instant in the thumbnail screen. Set the preview "Off" to resolve this.
	Repeat	Playback repeat within the title (Off / On)

Change to the Photo mode

You can switch to the Photo mode of the Media Player from the thumbnail view.

While the thumbnail is displayed, display the contents selection

Select "Photo"

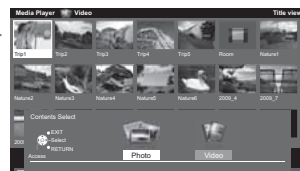

● For details of the Photo mode operations
➔ "Photo mode" (p. 50)

Note

● The structure of titles and scenes may vary depending on the digital video camera used.

Displaying PC Screen on TV

The screen of the PC connected to the TV can be displayed on the TV.
You can also listen to PC sound with the audio cable connected.

- To connect PC → p. 65



1 Select the external input
AV

2 Select "PC"

Input Selection
AV1
AV2/S
AV3
COMPONENT
PC
HDMI1
HDMI2
HDMI3
TV

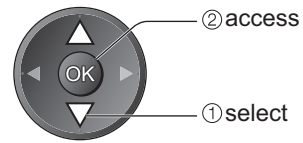

- Corresponding signals → p. 69
- If "H-freq." or "V-freq." is shown in red, the signals may not be supported.

■ To return to TV



■ **PC menu setting** (changed as desired)

- To make settings → “How to Use Menu Functions” ① to ④ (p. 27)

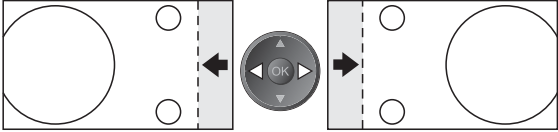
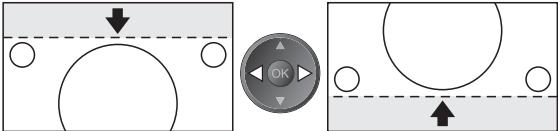
Menu	Item	Adjustments / Configurations (options)	
Picture	Advanced PC Settings	R-Gain	Adjusts the white balance for red areas
		G-Gain	Adjusts the white balance for green areas
		B-Gain	Adjusts the white balance for blue areas
		R-Cutoff	Adjusts the white balance for red areas
		G-Cutoff	Adjusts the white balance for green areas
		B-Cutoff	Adjusts the white balance for blue areas
		Gamma	Switches the gamma curve (1.8 / 2.0 / 2.2 / 2.4 / 2.6)
		Reset to Defaults	Press the OK button to reset to the default Advanced PC Settings
Setup	PC Setup	Input Resolution	Switches to a wide view <ul style="list-style-type: none"> ● VGA (640 × 480 pixels), WVGA (852 × 480 pixels), XGA (1,024 × 768 pixels), WXGA (1,280 × 768 pixels, 1,366 × 768 pixels) ● Options change depending on signals
		Clock	Set to the minimum level if noise occurs
		H-pos	Adjusts horizontal position 
		V-pos	Adjusts vertical position 
		Clock Phase	Eliminates flicker and distortion <ul style="list-style-type: none"> ● Adjust after Clock adjustment ● Set to the minimum level if noise occurs
		Sync	Chooses another synchronous signal if the image is distorted (H & V / On Green) <ul style="list-style-type: none"> ● H & V : by the horizontal and vertical signals from your PC On Green: by the green signal from your PC (if available)
		Reset to Defaults	Press the OK button to reset to the default PC Setup settings

- Other items → p. 28 - 32

Note

- For HDMI-compatible PC, possible to connect to HDMI terminals (HDMI1 / HDMI2 / HDMI3) by using HDMI cable (p. 68).

Link Functions (Q-Link VIERA Link)

Q-Link connects the TV and DVD Recorder / VCR, and enables easy recording, playback, etc. (p. 58)
 VIERA Link (HDAVI Control™) connects the TV and the equipment with VIERA Link function, and enables easy control, convenient recording, playback, energy saving, creation of a home theatre, etc., without complicated setting. (p. 59 - 63)

You can use Q-Link and VIERA Link functions together.

- This TV supports "HDAVI Control 5" function. But available features are depending on the connected equipment's version of HDAVI Control. Please refer to the manual of the equipment to confirm the version.
- VIERA Link features may be available even with other manufacturers' equipment supporting HDMI CEC.

Summary of Q-Link and VIERA Link features

■ Q-Link (SCART connection only)

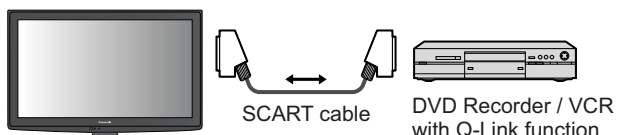
Features	Connected equipment DVD Recorder / VCR with Q-Link function	Connection
Analogue channel download	○	 <p>● Use a fully wired SCART cable. ● Connect the DVD Recorder / VCR supporting Q-Link to the TV's AV1 or AV2 terminal via a SCART cable.</p>
Easy playback	○	
Power on link	○	
Power off link	○	
Direct TV Recording	○	

■ VIERA Link (HDMI connection only)

Features	Connected equipment DIGA Recorder with VIERA Link function	DVD Player / Blu-ray Disc Player with VIERA Link function	HD Video Camera / LUMIX Camera with VIERA Link function
Analogue channel download	-	-	-
Easy playback	○	○	○
Power on link	○	○	○
Power off link	○	○	○
Reduce unnecessary power consumption in standby	○*3	○*3	-
Auto standby for unnecessary equipment	○*3	○*3	-
Pause Live TV programme	○*2 ○*4	-	-
Direct TV Recording	○*2	-	-
Control the menu of the connected equipment by VIERA remote control	○*1	○*1	○*1
Speaker control	-	-	-

Connection

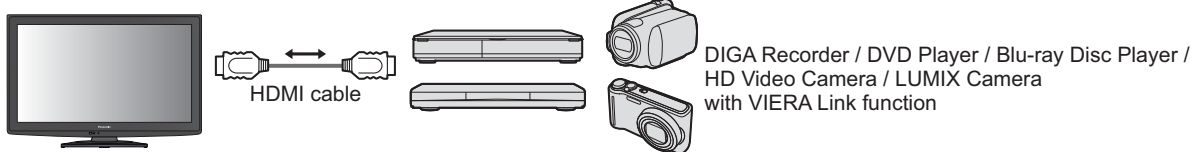

- Use a fully wired HDMI compliant cable.
- Connect the equipment supporting VIERA Link to the TV's HDMI1, HDMI2 or HDMI3 terminal via an HDMI cable.
- For information about using HDMI cables for connecting Panasonic HD Video Camera or LUMIX Camera, read the manual of the equipment.

■ VIERA Link (HDMI and SCART connections)

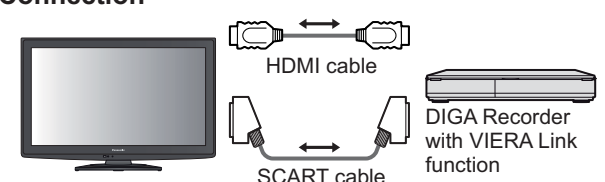
Features	Connected equipment DIGA Recorder with VIERA Link function	Connection
Analogue channel download	○	 <p>● Use a fully wired HDMI compliant cable. ● Connect the equipment supporting VIERA Link to the TV's HDMI1, HDMI2 or HDMI3 terminal via an HDMI cable. ● Use a fully wired SCART cable. ● Connect the equipment supporting VIERA Link to the TV's AV1 or AV2 terminal via a SCART cable.</p>
Easy playback	○	
Power on link	○	
Power off link	○	
Reduce unnecessary power consumption in standby	○*3	
Auto standby for unnecessary equipment	○*3	
Pause Live TV programme	○*2 ○*4	
Direct TV Recording	○*2	
Control the menu of the connected equipment by VIERA remote control	○*1	
Speaker control	-	

■ VIERA Link (HDMI and Audio out connections)

Features	Connected equipment	Player theatre with VIERA Link function	Blu-ray Disc theatre with VIERA Link function	Amplifier with VIERA Link function
Analogue channel download		—	—	—
Easy playback		○*5	○*5	—
Power on link		○	○	—
Power off link		○	○	○
Reduce unnecessary power consumption in standby		—	○*3	—
Auto standby for unnecessary equipment		○*3 ○*6	○*3 ○*6	○*3
Pause Live TV programme		—	—	—
Direct TV Recording		—	—	—
Control the menu of the connected equipment by VIERA remote control		○*1	○*1	—
Speaker control		○	○	○

Connection

- To use Player theatre / Blu-ray Disc theatre:

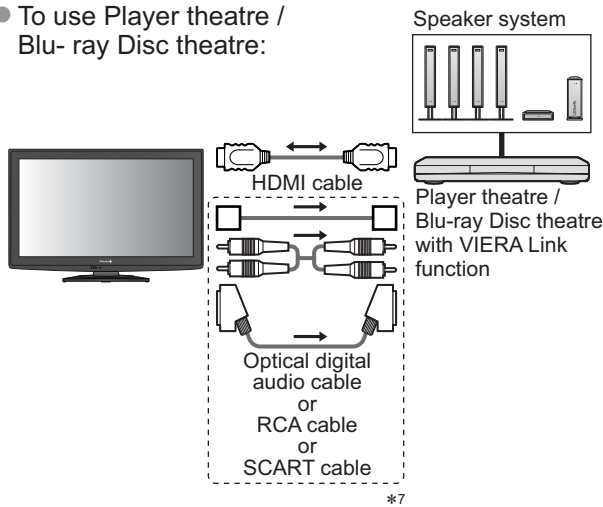

- To use Amplifier:

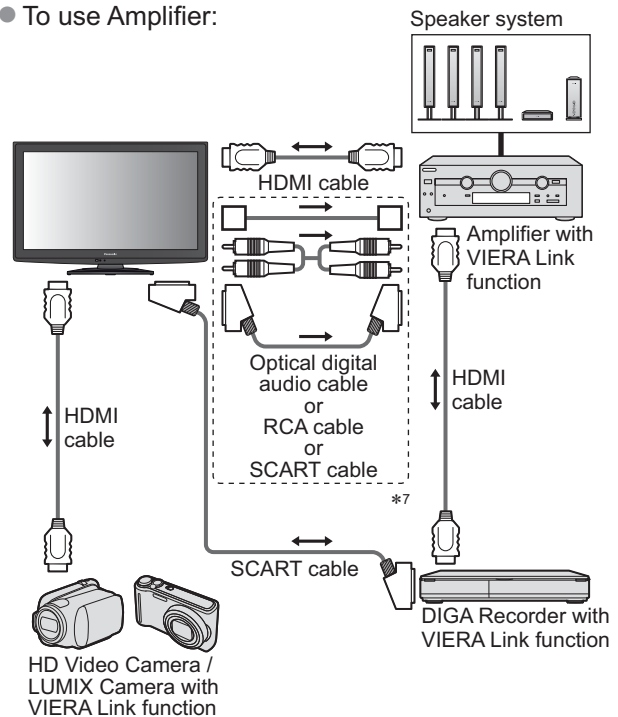

- Use a fully wired HDMI compliant cable.
- Connect the equipment supporting VIERA Link to the TV's HDMI1, HDMI2 or HDMI3 terminal via an HDMI cable.
- Use a fully wired SCART cable.
- If you use a SCART cable for audio output, connect the equipment supporting VIERA Link to the TV's AV1 or AV2 terminal and set "AV1 / AV2 out" to "Monitor" in the Setup Menu (p. 30).
- Use any one of the optical digital audio cable, RCA cable and SCART cable for audio output from the TV.

*1: Available with the equipment which has "HDAVI Control 2 or later" function.

*2: Available with the equipment which has "HDAVI Control 3 or later" function.

*3: Available with the equipment which has "HDAVI Control 4 or later" function.

*4: Available with DIGA Recorder which has HDD.

*5: while playback a disc

*6: except for watching a disc

*7: If the connected equipment has "HDAVI Control 5" function, you do not have to use this audio cable (Optical digital audio cable, RCA cable or SCART cable). In this case, connect the equipment to the TV's HDMI2 terminal via an HDMI cable.

■ VIERA Link Control of compatible equipment (VIERA Link Control → p. 62)

- Table below displays maximum number of compatible equipment that can be controlled by VIERA Link Control. This includes connections to equipment already connected to the TV. For example, DIGA Recorder connected to Amplifier which is connected to the TV via an HDMI cable.

Type of the equipment	Maximum number
Recorder (DIGA Recorder, etc.)	3
Player (DVD Player, Blu-ray Disc Player, HD Video Camera, LUMIX Camera, Digital Camera, Player theatre, Blu-ray Disc theatre, etc.)	3
Audio system (Player theatre, Blu-ray Disc theatre, Amplifier, etc.)	1
Tuner (Set top box, etc.)	4

Link Functions (Q-Link VIERA Link)

Q-Link

■ Preparations

- Connect the DVD Recorder / VCR with the following logos: "Q-Link", "NEXTVIEWLINK", "DATA LOGIC", "Easy Link", "Megalogic" or "SMARTLINK"
- Q-Link connection → p. 56
- Use fully wired SCART cable.
- Set up the DVD Recorder / VCR. Read the manual of the recorder.
- Q-Link terminal setup in the Setup Menu → "Q-Link" (p. 30), "AV1 / AV2 out" (p. 30)
- Download Analogue channel setting → "Analogue channel download" (see below)

■ Features available

Analogue channel download

Analogue channel settings can be downloaded to a recorder with an analogue tuner (where Analogue is still broadcast). Digital channel settings are not downloaded.

- To download the Analogue channel settings → "Q-Link Download" (p. 30) or "Auto Setup" in Analogue mode (p. 37) or "Auto Setup" - when first using the TV (p. 12)

Direct TV Recording - What you see is What you record

Recording the current programme on a DVD Recorder / VCR immediately.



- Available conditions:

Picture source	Mode	Recording from
Analogue	TV	TV monitor out
	AV	Recorder's tuner
DVB	TV	TV monitor out
AV (watching recorder's tuner)	AV	Recorder's tuner
AV (watching recorder's external input)	AV	Recorder's external input
AV (watching TV's external input)	AV	TV monitor out

- When Direct TV Recording is performed, the recorder is automatically turned on if it is in Standby mode.
- Changing channel or turning off the TV is available while the recorder is recording from its own tuner.
- Changing channel is not available while the recorder is recording from the TV tuner.

■ To stop recording

Unlock the tuner

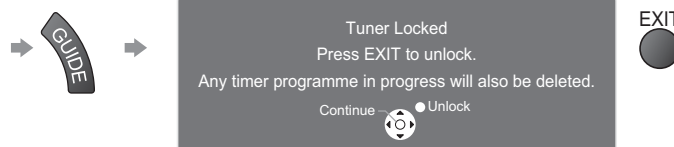

Power on link and Easy playback

When the DVD Recorder / VCR starts playback or the direct navigator / function menu for the equipment is activated, the TV is turned on and the input mode is switched automatically so that you can view the content. (Only when the TV is in Standby mode.)

Power off link

When the TV is set to Standby mode, the recorder is also automatically set to Standby. (Only when the videocassette or disc is not active.)

- This function will work even if the TV enters Standby mode automatically by auto power standby function.

- "DATA LOGIC" (a trademark of Metz Corporation)
- "Easy Link" (a trademark of Philips Corporation)

- "Megalogic" (a trademark of Grundig Corporation)
- "SMARTLINK" (a trademark of Sony Corporation)

Note

- Some recorders are not compatible. Read the manual of the recorder.

VIERA Link “HDAVI Control™”*

*Enjoy additional HDMI Inter-Operability with Panasonic products which have “HDAVI Control” function. This TV supports “HDAVI Control 5” function.

Connections to the equipment (DIGA Recorder, HD Video Camera, Player theatre, Amplifier, etc.) with HDMI and SCART cables allow you to interface them automatically (p. 56 and p. 57).

These features are limited to models incorporating “HDAVI Control” and “VIERA Link”.

- Some functions are not available depending on the equipment’s version of HDAVI Control. Please confirm the connected equipment’s version of HDAVI Control.
- VIERA Link “HDAVI Control”, based on the control functions provided by HDMI which is an industry standard known as HDMI CEC (Consumer Electronics Control), is a unique function that we have developed and added. As such, its operation with other manufacturers’ equipment that supports HDMI CEC cannot be guaranteed.
- Please refer to individual manuals for other manufacturers’ equipment supporting VIERA Link function.
- For information about applicable Panasonic equipment, consult your local Panasonic dealer or refer to www.panasonic.co.uk

■ Preparations

- Connect the equipment that supports VIERA Link.
- VIERA Link connection ➔ p. 56 and p. 57
- Use a fully wired HDMI compliant cable. Non-HDMI-compliant cables cannot be utilized.
Recommended Panasonic HDMI cables’ part numbers:
 - RP-CDHS15 (1.5 m)
 - RP-CDHS30 (3.0 m)
 - RP-CDHS50 (5.0 m)
- Use a fully wired SCART cable.
- Set up the connected equipment. Read the manual of the equipment.
- For optimal recording, the settings of the recorder may need to be changed. For details, read the manual of the recorder.
- Download Analogue channel setting ➔ “Analogue channel download” (see below)
- Set VIERA Link On in the Setup Menu ➔ “VIERA Link” (p. 30)
- Set up the TV
 - ➔ **After connection, turn the equipment on and then switch the TV on. Select the input mode to HDMI1, HDMI2 or HDMI3 (p. 24), and make sure that an image is displayed correctly.**
This setup should be done each time when the following conditions occur:
 - for the first time
 - when adding or reconnecting equipment
 - when changing setup

■ Features available

Analogue channel download

Analogue channel settings can be downloaded to a recorder with an analogue tuner (where Analogue is still broadcast). Digital channel settings are not downloaded.

- To download the Analogue channel settings ➔ “Q-Link Download” (p. 30) or “Auto Setup” in Analogue mode (p. 37) or “Auto Setup” - when first using the TV (p. 12)

Easy playback

Automatic Input switching - When the connected equipment is operated (during playback or menu operations, etc.), the input mode is switched automatically. When playback is stopped or menus are exited, the input mode returns to the original setting.

Power on link

When the connected equipment starts playback or the direct navigator / function menu for the equipment is activated, the TV is automatically turned on and the input mode is switched automatically so that you can view the content. (Only when the TV is in Standby mode.)

Power off link

When the TV is set to Standby mode, the connected equipment is also automatically set to Standby.

- This function will work even if the TV enters Standby mode automatically by auto power standby function.

Link Functions (Q-Link VIERA Link)

■ Features available

Reduce unnecessary power consumption in standby **Standby Power Save**

Set Standby Power Save “On” in the Setup Menu to use this function

➔ “Standby Power Save” (p. 30)

The power consumption in Standby mode of the connected equipment is controlled in synchronization with the TV On / Off state.

When the TV is set to Standby mode, the connected equipment is automatically set to Standby and the power consumption in Standby mode of the connected equipment is automatically minimized.

When the TV is turned on and the connected equipment is still in Standby mode, the power consumption of the connected equipment is increased to reduce the startup time.

- This function is effective if the connected equipment can change the power consumption in Standby mode and is set to higher consumption.

Auto standby for unnecessary equipment **Intelligent Auto Standby**

Set Intelligent Auto Standby “On (With reminder)” or “On (No reminder)” in the Setup Menu to use this function

➔ “Intelligent Auto Standby” (p. 30)

When the TV is On, non-watched or non-used connected equipment goes into Standby mode automatically to reduce power consumption. For example, when the input mode is switched from HDMI, the connected equipment will go into Standby mode / when Speaker Selection is changed to “TV”, the Player theatre will go into Standby mode (except when watching a disc).

- If you select “On (With reminder)”, the on screen message will be displayed before the connected equipment turns to Standby.
- This function may not work properly depending on the connected equipment. If required, set to “Off”.

■ Features available (Using VIERA Link Menu)

Direct TV Recording - What you see is What you record **Direct TV Rec**

Recording the current programme on a DIGA Recorder immediately.

- If you connect a variety of recorders including other manufacturers' recorders at the same time, please connect the DIGA Recorder to the TV's lower HDMI terminal number. For example, if you use HDMI1 and HDMI2 for two recorders, connect the DIGA Recorder to HDMI1.
- If Direct TV Recording does not operate, check the settings and the equipment
➔ “Summary of Q-Link and VIERA Link features” (p. 56 and p. 57), “Preparations” (p. 59)
- If you wish to record a programme that the DIGA Recorder does not support, a SCART connection is required and the programme is recorded by Q-Link function (p. 58).
- Depending on the programme, a SCART connection may be required to record.
- Changing channel or turning off the TV is available while the recorder is recording from its own tuner.
- Changing channel is not available while the recorder is recording from the TV tuner.



1 Display “VIERA Link Menu”

2 Select “Direct TV Rec” and start recording

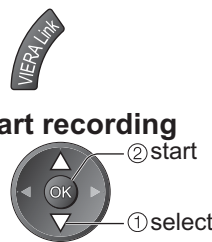

- You can also start recording directly ➔

■ To stop recording

Select “Stop” in “Direct TV Rec” and access

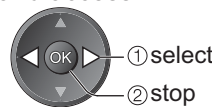

- You can also stop recording directly.

Unlock the tuner

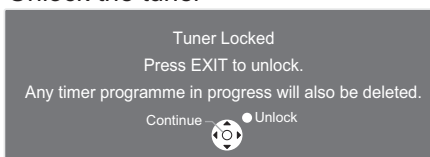

■ Features available (Using VIERA Link Menu)

Pause Live TV programme **Pause Live TV**

You can pause the live TV programme and resume the programme later.
The live TV programme will be recorded on HDD of the connected DIGA Recorder.

- This function is available with a DIGA Recorder which has HDD.
- If you connect a variety of recorders including other manufacturers' recorders at the same time, please connect the DIGA Recorder which has HDD to the TV's lower HDMI terminal number. For example, if you use HDMI1 and HDMI2 for two recorders, connect the DIGA Recorder which has HDD to HDMI1.
- If Pause Live TV does not operate, check the settings and the equipment
→ "Summary of Q-Link and VIERA Link features" (p. 56 and p. 57), "Preparations" (p. 59)

Access and pause the live TV programme



1 Display "VIERA Link Menu"



2 Select "Pause Live TV" and pause

VIERA Link Menu	
Pause Live TV	Start
Direct TV Rec	Start
VIERA Link Control	Recorder
Speaker Selection	Home Cinema

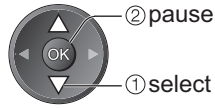

The TV picture will be paused.

- You can also pause directly by using VIERA TOOLS
→ "How to Use VIERA TOOLS" (p. 26)
- Live TV programme is recorded on HDD from where it was paused.
- If the paused TV picture disappears after a few minutes
→ (the paused picture will be restored)
- Follow the operation guide to operate Pause Live TV function.

■ To operate Pause Live TV

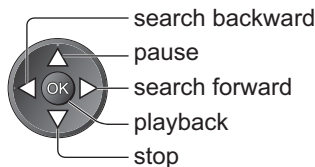

- Operations may be different depending on the recorder. In this case, follow the operation guide or read the manual of the recorder.

- If you stop playback, the recorded programme will be deleted from HDD.

■ To return to Live TV

(stop playback of Pause Live TV / cancel pause)

Select "Yes"

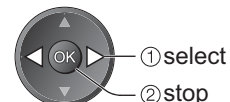
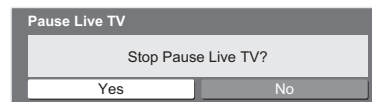

- If you stop playback or cancel pause, the recorded programme will be deleted from HDD.

Link Functions (Q-Link VIERA Link)

■ Features available (Using VIERA Link Menu)

Control the menu of the connected equipment by VIERA remote control

VIERA Link Control

You can control some functions of the connected equipment with this TV remote control (point the remote control at the TV's signal receiver).

- If you cannot operate the menu of the connected equipment, check the settings and the equipment
 - ➔ "Summary of Q-Link and VIERA Link features" (p. 56 and p. 57), "Preparations" (p. 59)
- For details of the operations for the connected equipment, read the manual of the equipment.

Access and operate the menu of the equipment



1 Display "VIERA Link Menu"

2 Select "VIERA Link Control"

VIERA Link Menu	
Pause Live TV	Start
Direct TV Rec	Start
VIERA Link Control	Recorder
Speaker Selection	Home Cinema

select

3 Select the equipment you want to access

The type of the connected equipment is displayed. Select the type of the equipment and access.

VIERA Link Menu	
Pause Live TV	Start
Direct TV Rec	Start
VIERA Link Control	Recorder
Speaker Selection	Home Cinema

① select
② access

Recorder / Player / Home Cinema / Video Camera / LUMIX / Digital Camera / Other

- You can also access directly by using VIERA TOOLS
 - ➔ "How to Use VIERA TOOLS" (p. 26)
- The displayed item may vary depending on the connected equipment.
- "Home Cinema" means Player theatre, Blu-ray Disc theatre or Recorder theatre.
- "Other" means Tuner set top box.

■ If multiple recorders or players are connected

VIERA Link Menu	
Pause Live TV	Start
Direct TV Rec	Start
VIERA Link Control	Recorder2
Speaker Selection	Home Cinema

Recorder1-3 / Player1-3

The number is given from the TV's lower HDMI terminal number connected to the same type equipment. For example, two recorders to HDMI2 and HDMI3, in this case the recorder connected to HDMI2 is displayed as "Recorder1", and the recorder connected to HDMI3 is displayed as "Recorder2".

■ If you access non-VIERA Link equipment

VIERA Link Menu	
Pause Live TV	Start
Direct TV Rec	Start
VIERA Link Control	Recorder
Speaker Selection	Home Cinema

The type of the connected equipment is displayed. You can access the menu of the equipment. But you cannot operate it. Use its own remote control to operate the equipment.

The menu of the accessed equipment (Input mode will be changed automatically)

4 Operate the menu of the equipment

Available VIERA remote control buttons: (depending on the connected equipment)



① **Set the code of the remote control to "73"**

➔ "How to change the code for the type of the equipment" (p. 25)

② **Follow the operation guide**

- To display the operation guide ➔
 - If other manufacturers' equipment is accessed, Setup / Contents Selection menu may be displayed.

- When the key words are displayed on colour bar



Note

- Some operations may not be available depending on the equipment. In this case use its own remote control to operate the equipment.

■ Features available (Using VIERA Link Menu)

Speaker control **Speaker Selection**

You can control the home theatre speakers with this TV remote control (point the remote control at the TV's signal receiver).

- If you cannot control the home theatre speakers with this remote control, check the settings and the equipment
 ➔ "Summary of Q-Link and VIERA Link features" (p. 56 and p. 57), "Preparations" (p. 59)

Access and control the speaker volume

1 Display "VIERA Link Menu"

2 Select "Speaker Selection"

VIERA Link Menu	
Pause Live TV	Start
Direct TV Rec	Start
VIERA Link Control	Recorder
Speaker Selection	Home Cinema

3 Set to "Home Cinema" or "TV"

■ **Home Cinema**
 The Player theatre, Blu-ray Disc theatre or Amplifier will be automatically turned on if it is in Standby mode and the sound will be output from theatre speakers connected to the equipment.

- Volume up / down
 ➔
- Mute ➔
- The sound of the TV speakers is muted.
- When the equipment is turned off, the TV speakers will be activated.

■ **TV**
 TV speakers are active.

Note

- If you wish to enjoy multi-channel sound (e.g. Dolby Digital 5.1ch) via an Amplifier, connect the Amplifier to the TV with an HDMI cable and an Optical digital audio cable (p. 57), and then select "Home Cinema". If your Amplifier has "HDAVI Control 5" function, you only need to connect with an HDMI cable. In this case, connect your Amplifier to the TV's HDMI2 terminal. To enjoy the sound from the DIGA Recorder in multi-channel sound, connect an HDMI cable from the DIGA Recorder to the Amplifier (p. 57).

Note

- These functions may not work properly depending on the connected equipment.
- Image or sound may not be available for the first few seconds when Input mode is switched.
- Easy playback may be available by using the remote control for Player theatre, Blu-ray Disc theatre or Amplifier. Read the manual of the equipment.
- "HDAVI Control 5" is the newest standard (current as of December, 2009) for HDAVI Control compatible equipment. This standard is compatible with conventional HDAVI equipment.
- To confirm this TV's version of HDAVI Control ➔ "System Information" (p. 31)

External Equipment

These diagrams show our recommendations for connection of your TV to various pieces of equipment. For other connections, consult the instructions for each piece of equipment, the table below, and the specifications (p. 75).

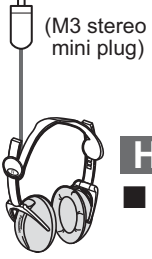
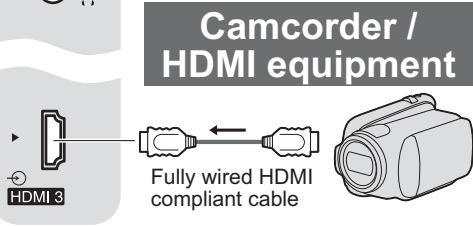
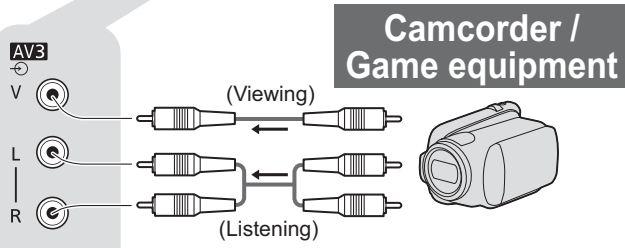
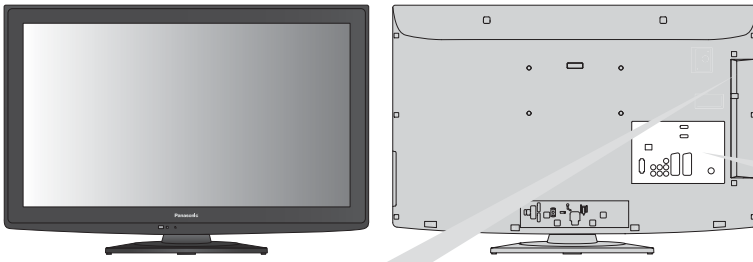

Headphones

■ To adjust volume
 → "Headphone Volume" in the Sound Menu (p. 29)

To listen with speakers

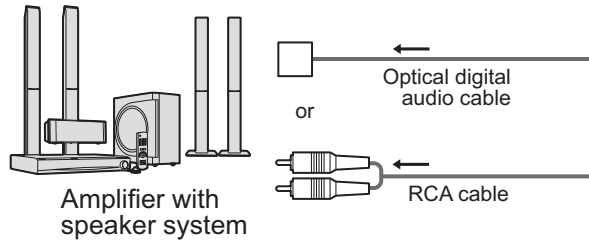

To enjoy the sound from the external equipment in multi-channel sound (e.g. Dolby Digital 5.1 ch), connect the equipment to the amplifier. For the connections, read the manuals of the equipment and amplifier.

To watch DVDs

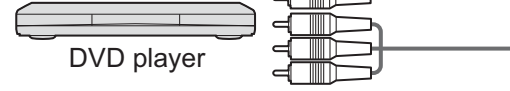

Types of connectable equipment to each terminal

Terminal	AV1	AV2	AV3 (Side panel of the TV)
Recording / Playback (equipment)			
To record / playback videocassettes / DVDs (VCR / DVD Recorder)	○	○	
To watch DVDs (DVD Player)	○	○	○
To watch camcorder images (Video camera)	○	○	○
To watch satellite broadcasts (Set top box)	○	○	○
To play games (Game equipment)	○	○	○
To use amplifier with speaker system			
Q-Link	○	○	
VIERA Link	○ (with HDMI)	○ (with HDMI)	
Direct TV Recording	○	○	

○: Recommended Connection
 *1: applicable if your amplifier has ARC (Audio Return Channel) function

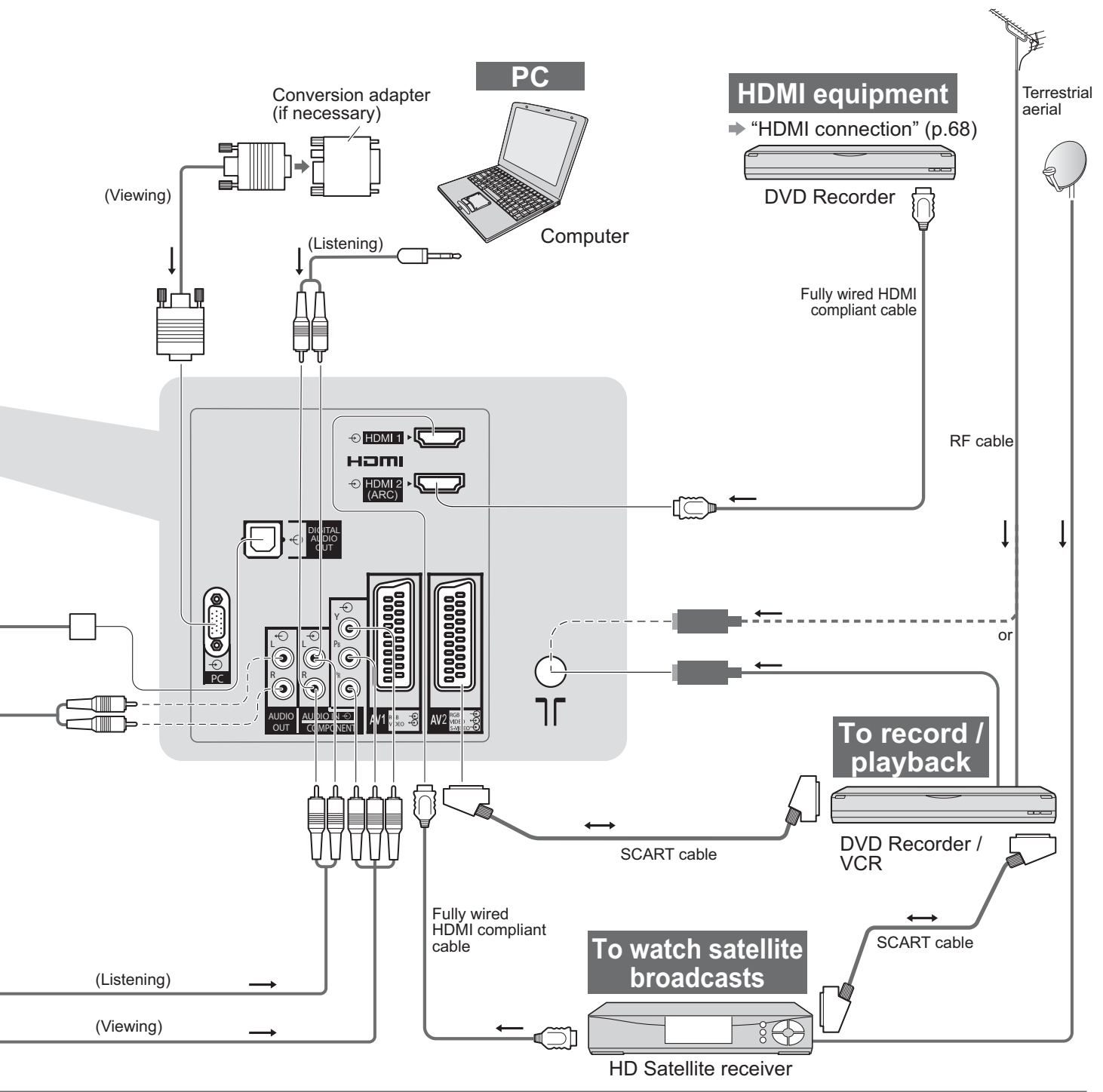

COMPONENT	AUDIO OUT	DIGITAL AUDIO OUT	HDMI		
			1	2	3
			<input type="checkbox"/>	<input type="checkbox"/>	<input type="checkbox"/>
<input type="checkbox"/>			<input type="checkbox"/>	<input type="checkbox"/>	<input type="checkbox"/>
			<input type="checkbox"/>	<input type="checkbox"/>	<input type="checkbox"/>
	<input type="checkbox"/>	<input type="checkbox"/>		<input type="checkbox"/> *1	
			<input type="checkbox"/>	<input type="checkbox"/>	<input type="checkbox"/>
			<input type="checkbox"/>	<input type="checkbox"/>	<input type="checkbox"/>

Technical Information

Auto Aspect

The optimum size and aspect can be chosen automatically, and you can enjoy finer images. (p. 16)

■ Aspect Control Signal

“WIDE” will appear in the top left of the screen if a Widescreen signal (WSS) or a Control signal through SCART / HDMI terminal is found.

The aspect will switch to the appropriate 16:9 or 14:9 widescreen ratio.

This function will work in any aspect mode.

Input terminal	Input signal format	Aspect Control Signal	
		Widescreen signal (WSS)	Control signal through SCART (pin8) / HDMI terminal
RF	DVB	○	
	PAL I	○	
	PAL 525/60 6.0 MHz	—	
	M.NTSC 6.0 MHz	—	
AV1 (Composite) AV2 (Composite or S-Video) AV3	PAL	○	○
	PAL 525/60	—	○
	M.NTSC	—	○
	NTSC	—	○
COMPONENT	525 (480) / 60i	—	
	525 (480) / 60p	—	
	625 (576) / 50i	○	
	625 (576) / 50p	○	
	750 (720) / 60p	—	
	750 (720) / 50p	—	
	1,125 (1,080) / 60i	—	
	1,125 (1,080) / 50i	—	
HDMI1 HDMI2 HDMI3	525 (480) / 60i	—	○
	525 (480) / 60p	—	○
	625 (576) / 50i	—	○
	625 (576) / 50p	—	○
	750 (720) / 60p	—	○
	750 (720) / 50p	—	○
	1,125 (1,080) / 60i	—	○
	1,125 (1,080) / 50i	—	○
	1,125 (1,080) / 60p	—	○
	1,125 (1,080) / 50p	—	○
	1,125 (1,080) / 24p	—	○

■ Auto mode

Auto mode determines the best aspect ratio to fill the screen. It does this using a four step process (WSS, Control signal through SCART / HDMI terminal, Letterbox detection, or Justify to fill the screen).

This process may take several minutes, depending on the darkness of the image.

Letterbox detection: If black bands at the top and bottom of the screen are detected, Auto mode chooses the best ratio and expands the image to fill the screen.

If no aspect signals are detected, Auto mode enhances the image for optimum viewing pleasure.

Note

- The ratio varies depending on the programme, etc. If the ratio is out of the standard 16:9, black bands at the top and bottom of the screen may appear.
- If the screen size looks unusual when a widescreen-recorded programme is played back on a VCR, adjust the tracking of the VCR. Read the manual of the VCR.

SD Card

If the SD Card does not meet SD standards, it may cause the TV to malfunction.

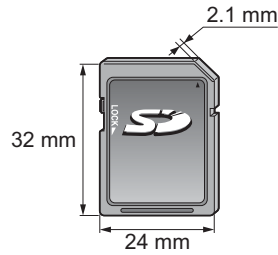

■ Cautions in handling SD Card

- Do not remove the card while the TV is accessing data (this can damage card or TV).
- Do not touch the pins on the back of the card.
- Do not subject the card to a high pressure or impact.
- Insert the card in the correct direction (otherwise the card or TV may be damaged).
- Electrical interference, static electricity, or erroneous operation may damage the data or card.
- Back up the recorded data at regular intervals in case of deteriorated or damaged data or erratic operation of the TV. (Panasonic is not liable for any deterioration or damage of recorded data.)

■ Data format for Card browsing

- Photo: Still images recorded with digital still cameras compatible with JPEG files of DCF* and EXIF standards
Data format - Baseline JPEG (Sub-sampling 4:4:4, 4:2:2 or 4:2:0)
Image resolution - 8 × 8 to 30,719 × 17,279 pixels
- Video: SD-Video Standard Ver. 1.2 [MPEG-2 (PS format)] and AVCHD Standard compatible files with an audio format that is either MPEG-1/Layer-2 format or Dolby Digital format
(Files recorded with vertical frequency 50 Hz are applicable. A modified data with a PC may not be displayed correctly.)
- Card format : SDXC Card - exFAT
SDHC Card / SD Card - FAT16 or FAT32
- Compliant card type (maximum capacity): SDXC Card (64 GB), SDHC Card (32 GB), SD Card (2 GB), miniSD Card (2 GB) (requiring miniSD adapter)
- If miniSD Card is used, insert / remove it together with the adapter.
- Check the latest information on the card type at the following website. (English only)
<http://panasonic.jp/support/global/cs/tv/>

*DCF (Design rule for camera file system): Unified standard established by Japan Electronics and Information Technology Industries Association (JEITA).

Note

- Format the card with the recording equipment.
- The picture may not appear correctly on this TV depending on the recording equipment used.
- Display may take some time when there are many files and folders.
- This function cannot display Motion JPEG or still images that are not JPEG format (i.e. TIFF, BMP).
- Data modified with a PC may not be displayed.
- Images imported from a PC must be compatible with EXIF (Exchangeable Image File) 2.0, 2.1, and 2.2.
- Partly degraded files might be displayed at a reduced resolution.
- The folder and file names may be different depending on the digital camera or digital video camera used.
- Do not use two-byte characters or other special codes.
- The card may become unusable with this TV if the file or folder names are changed.

Characters table for numeric buttons

You can enter characters by using numeric buttons for free input items. Press the numeric button repeatedly until you reach the desired character.

- The character is set automatically if you do not press the button for one second.
- You can also set the character by pressing the OK button or other numeric buttons within one second.

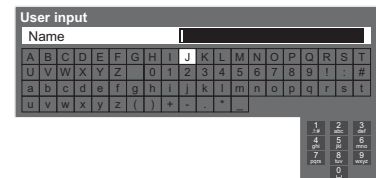

Characters table:

Numeric buttons	The number of times to press										
	1	2	3	4	5	6	7	8	9	10	11
1	.	1	!	:	#	+	-	*	_	()
2_{abc}	a	b	c	2	A	B	C				
3_{def}	d	e	f	3	D	E	F				
4_{ghi}	g	h	i	4	G	H	I				
5_{jkl}	j	k	l	5	J	K	L				
6_{mno}	m	n	o	6	M	N	O				
7_{pqrs}	p	q	r	s	7	P	Q	R	S		
8_{tuv}	t	u	v	8	T	U	V				
9_{wxyz}	w	x	y	z	9	W	X	Y	Z		
0	Space	0									

Technical Information

SCART and HDMI terminal information

■ AV1 SCART terminal (RGB, VIDEO, Q-Link)

Suitable inputs for AV1 include RGB (Red / Green / Blue).

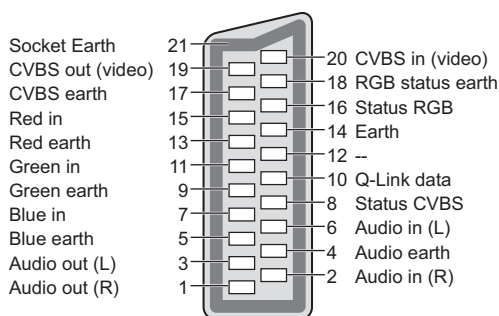

■ AV2 SCART terminal (RGB, VIDEO, S-VIDEO, Q-Link)

AV2 - Pins 15 and 20 are dependent on AV2 S-VHS / VIDEO switching.

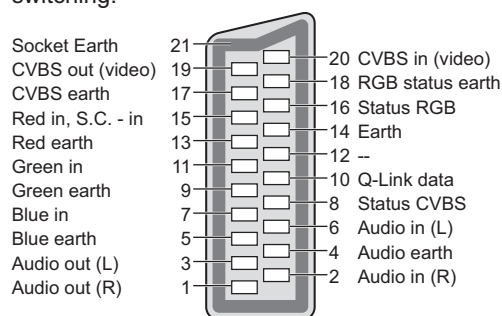

■ HDMI terminal

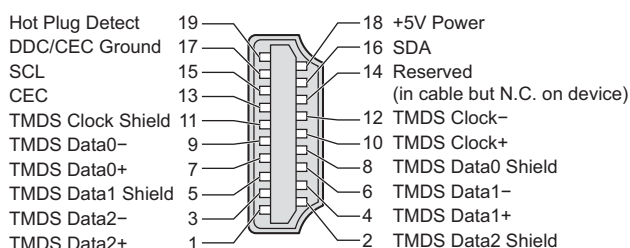

HDMI connection

HDMI (high-definition multimedia interface) is the world's first complete digital consumer AV interface complying with a non-compression standard.

HDMI allows you to enjoy high-definition digital images and high-quality sound by connecting the TV and the equipment.

HDMI-compatible equipment^(*1) with an HDMI or DVI output terminal, such as a DVD player, a set top box or a game equipment, can be connected to the HDMI terminal using an HDMI compliant (fully wired) cable.

For information about connections, see "External Equipment" (p. 64 and p. 65).

■ Applicable HDMI features

- Input audio signal : 2ch Linear PCM (sampling frequencies - 48 kHz, 44.1 kHz, 32 kHz)
- Input video signal : 480i, 480p, 576i, 576p, 720p, 1080i and 1080p
 - ➔ "Input signal that can be displayed" (p. 69)
 - Match the output setting of the digital equipment.
- Input PC signal : ➔ "Input signal that can be displayed" (p. 69)
 - Match the output setting of the PC.
- VIERA Link (HDAVI Control 5) : ➔ "VIERA Link" (p. 59)
- Audio Return Channel^(*3) (HDMI2 terminal only)

■ DVI connection

If the external equipment has only a DVI output, connect to the HDMI terminal via a DVI to HDMI adapter cable^(*2). When the DVI to HDMI adapter cable is used, connect the audio cable to the audio input terminal (HDMI1 / 2: use COMPONENT-AUDIO terminals / HDMI3: use AV3 audio terminals).

Note

- Audio settings can be made on the "HDMI1 / 2 / 3 Input" in the Sound Menu. (p. 29)
- If the connected equipment has an aspect adjustment function, set the aspect ratio to "16:9".
- These HDMI connectors are "type A".
- These HDMI connectors are compatible with HDCP (High-Bandwidth Digital Content Protection) copyright protection.
- Equipment having no digital output terminal may be connected to the input terminal of either "COMPONENT", "S-VIDEO", or "VIDEO" to receive analogue signals.
- This TV incorporates HDMI™ technology.

(*1): The HDMI logo is displayed on HDMI-compliant equipment.

(*2): Enquire at your local digital equipment retailer shop.

(*3): Audio Return Channel (ARC) is a function to be able to send digital sound signals via an HDMI cable.

PC connection

A PC may be connected to this TV so that the PC screen is displayed and sound is heard from the TV.

- PC signals that can be inputted: Horizontal scanning frequency 31 to 69 kHz; vertical scanning frequency 59 to 86 Hz (more than 1,024 signal lines could result in incorrect display of the image).
- A PC adapter is not necessary for the DOS/V-compliant D-sub 15-pin connector.

Note

- Some PC models cannot be connected to this TV.
- To listen to PC sound from the TV, connect the audio cable to COMPONENT-AUDIO terminals. (p. 65)
- When using PC, set the colour display quality of PC to the highest position.
- For details of the applicable PC signals → "Input signal that can be displayed" (below)
- Max. display resolution

Aspect	4:3	1,024 × 768 pixels
	16:9	1,366 × 768 pixels

- D-sub 15-pin connector signal

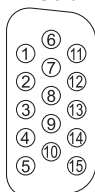

Pin No.	Signal Name	Pin No.	Signal Name	Pin No.	Signal Name
①	R	⑥	GND (Ground)	⑪	NC (not connected)
②	G	⑦	GND (Ground)	⑫	NC (not connected)
③	B	⑧	GND (Ground)	⑬	HD (HSYNC)
④	NC (not connected)	⑨	NC (not connected)	⑭	VD (VSYNC)
⑤	GND (Ground)	⑩	GND (Ground)	⑮	NC (not connected)

Input signal that can be displayed

COMPONENT (Y, P_B, P_R), HDMI

* Mark: Applicable input signal

Signal name	COMPONENT	HDMI
525 (480) / 60i	*	*
525 (480) / 60p	*	*
625 (576) / 50i	*	*
625 (576) / 50p	*	*
750 (720) / 60p	*	*
750 (720) / 50p	*	*
1,125 (1,080) / 60i	*	*
1,125 (1,080) / 50i	*	*
1,125 (1,080) / 60p	*	*
1,125 (1,080) / 50p	*	*
1,125 (1,080) / 24p	*	*

PC (from D-sub 15P)

Applicable input signal for PC is basically compatible to VESA standard timing.

Signal name	Horizontal frequency (kHz)	Vertical frequency (Hz)
640 × 400 @70 Hz	31.47	70.07
640 × 480 @60 Hz	31.47	59.94
640 × 480 @75 Hz	37.50	75.00
800 × 600 @60 Hz	37.88	60.32
800 × 600 @75 Hz	46.88	75.00
800 × 600 @85 Hz	53.67	85.06
852 × 480 @60 Hz	31.44	59.89
1,024 × 768 @60 Hz	48.36	60.00
1,024 × 768 @70 Hz	56.48	70.07
1,024 × 768 @75 Hz	60.02	75.03
1,024 × 768 @85 Hz	68.68	85.00
1,280 × 768 @60 Hz	47.70	60.00
1,280 × 1,024 @60 Hz	63.98	60.02
1,366 × 768 @60 Hz	48.39	60.04
Macintosh13" (640 × 480)	35.00	66.67
Macintosh16" (832 × 624)	49.73	74.55
Macintosh21" (1,152 × 870)	68.68	75.06

PC (from HDMI terminal)

Applicable input signal for PC is basically compatible to HDMI standard timing.

Signal name	Horizontal frequency (kHz)	Vertical frequency (Hz)
640 × 480 @60 Hz	31.47	60.00
750 (720) / 60p	45.00	60.00
1,125 (1,080) / 60p	67.50	60.00

Note

- Signals other than above may not be displayed properly.
- The above signals are reformatted for optimal viewing on your display.
- PC signal is magnified or compressed for display, so that it may not be possible to show fine detail with sufficient clarity.

FAQs

Before requesting service or assistance, please follow these simple guides to resolve the problem. If the problem still persists, please contact your local Panasonic dealer or Panasonic Customer Care Centre for assistance. For details (p. 76)

Block noise, frozen or disappearing image occurs in digital mode / White spots or shadow image (ghosting) occurs in analogue mode / Some channels cannot be tuned

- Check the position, direction and connection of the aerial.
- Check “Signal Condition” (p. 40). If “Signal Quality” is displayed in red, the digital signal is weak.
- Check your postcode area is able to receive the Freeview channels at www.freeview.co.uk
- Digital signals may be relatively low to prevent interference with analogue signals for the period of Digital Switchover. Check the schedule of Digital Switchover at www.digitaluk.co.uk
- Weather conditions will affect signal reception (heavy rain, snow, etc.), in particular in poor reception areas. Even during good weather, high pressure can cause poor reception of some channels.
- Due to the digital reception technologies involved, quality of the digital signals may be relatively low in some cases, despite good reception of analogue channels.
- Turn the TV off with the Mains power On / Off switch, and then on again.
- If problem persists, consult your local dealer.

Neither image nor sound is produced

- Is the TV in AV mode?
- Check the correct AV input mode is selected.
- Check the mains lead is plugged into the socket outlet.
- Has the TV been turned On?
- Check the Picture Menu (p. 28) and volume.
- Check all required cables and connections are firmly in place.

Auto aspect

- Auto aspect is designed to provide you with the best ratio to fill the screen. (p. 66)
- Press the ASPECT button if you would like to change the aspect ratio manually (p. 16).

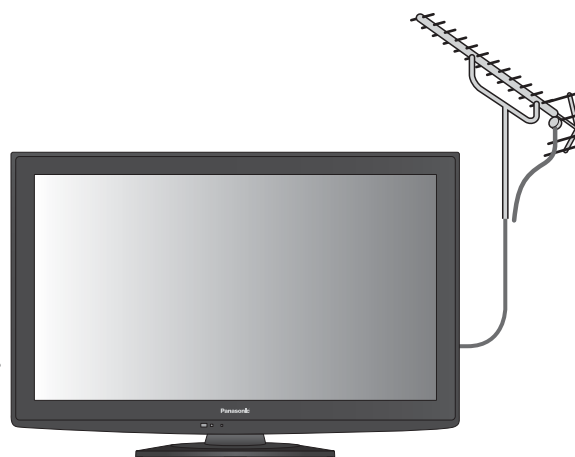

S-Video / black and white picture

- A black and white picture may be seen when the TV is set to S-Video when the connected equipment is not. Change the setting on the TV (p. 24).
- Check that the output of the external equipment matches the input of the TV. If the output of the external equipment is set to S-Video, the TV must also be set to S-Video (p. 24).

Input mode, i.e. EC/AV1 remains on the screen

- Press the **i** button to clear this message. Press again to redisplay.

Q-Link function does not work

- Confirm SCART cable and connection. Also set “AV1 / AV2 out” in the Setup Menu (p. 30).

“VIERA Link” function does not work and an error message appears

- Confirm the connection. (p. 56 and p. 57)
- Turn the connected equipment on and then switch the TV on. (p. 59)

Recording does not start immediately

- Check the settings of the recorder. For details, read the manual of the recorder.

	Problem	Actions
Screen	Chaotic image, noisy	<ul style="list-style-type: none"> ● Set "P-NR" in the Picture Menu (to remove noise). (p. 28) ● Check nearby electrical products (fluorescent lamp, DECT phones, mobile phones, microwave, etc.).
	No image can be displayed	<ul style="list-style-type: none"> ● Is "Contrast", "Brightness" or "Colour" in the Picture Menu set to the minimum? (p. 28) ● Please also refer to "Neither image nor sound is produced" (p. 70)
	Blurry or distorted image (no sound or low volume)	<ul style="list-style-type: none"> ● Reset channels. (p. 36 and p. 37) ● Please also refer to "Neither image nor sound is produced" (p. 70)
	Unusual image is displayed	<ul style="list-style-type: none"> ● Turn the TV Off with Mains power On / Off switch, then turn it On again. ● If the problem persists, perform "Shipping Condition" (p. 46).
Sound	No sound is produced	<ul style="list-style-type: none"> ● Is "Sound mute" active? (p. 8) ● Is the volume set to the minimum? ● Is Speaker Selection (VIERA Link) set to "TV"? ● Please also refer to "Neither image nor sound is produced" (p. 70)
	Sound level is low or sound is distorted	<ul style="list-style-type: none"> ● Sound signal reception may be deteriorated. ● Set "NICAM" (p. 29) in the Sound Menu to "Off". (Analogue only) ● Please also refer to "Neither image nor sound is produced" (p. 70)
Digital Channel	No programmes shown on TV Guide	<ul style="list-style-type: none"> ● Reset channels. (p. 36 and p. 37) ● Check the digital transmission by contacting Digital UK on 08456 50 50 50 or at www.digitaluk.co.uk ● Check the analogue broadcast (if still available in your area). ● Consult an aerial engineer to check the alignment of your aerial.
	Cannot find a channel you have previously watched	<ul style="list-style-type: none"> ● The channel may broadcast for part of the day. ● Check the channel in the TV Guide. (p. 18 and p. 19) ● Channel position numbers may be changed by broadcasters. ● Reset channels. (p. 36 and p. 37)
HDMI	Sound is unusual	<ul style="list-style-type: none"> ● Set the sound setting of the connected equipment to "2ch L.PCM". ● Check the "HDMI1 / 2 / 3 Input" setting in the Sound Menu. (p. 29) ● If digital sound connection has a problem, select analogue sound connection. (p. 68)
	Pictures from external equipment are unusual when the equipment is connected via HDMI	<ul style="list-style-type: none"> ● Check the HDMI cable is connected properly. (p. 64 and p. 65) ● Turn the TV and equipment Off, then turn them On again. (p. 59) ● Check an input signal from the equipment. (p. 69) ● Check the output resolution from the equipment. (p. 69) ● Use an equipment compliant with EIA/CEA-861/861B.
Other	The TV does not switch On	<ul style="list-style-type: none"> ● Press and hold the standby On / Off switch on the remote control for about 1 second if Power LED is red. ● Check the mains lead is plugged into the socket. ● The fuse in the mains plug may have blown. Replace it with one of an identical rating (p. 4).
	The TV goes into Standby mode	<ul style="list-style-type: none"> ● Auto power standby function is activated. (p. 9) ● The TV enters Standby mode about 30 mins. after analogue broadcast ends.
	The remote control does not work or is intermittent	<ul style="list-style-type: none"> ● Are the batteries installed correctly? (p. 6) ● Has the TV been switched On? ● The batteries may be running low. Replace them. ● Point the remote control directly at the front of the TV (within about 7 m and a 30 degree angle of the front of the TV). ● Situate the TV so that sunshine or other sources of bright light do not shine on the TV's remote control signal receiver.
	The LCD panel moves slightly when it is pushed with a finger Clattered sound might be heard	<ul style="list-style-type: none"> ● There is some flexibility around the panel to prevent damage to the panel. ● The panel might move slightly when it is pushed with a finger, and clattered sound might be heard. This is not a malfunction.
	There may be red spots, blue spots, green spots and black spots on the screen	<ul style="list-style-type: none"> ● This is a characteristic of liquid crystal panels and is not a problem. The liquid crystal panel is built with very high precision technology giving you fine picture details. Occasionally, a few non-active pixels may appear on the screen as a fixed point of red, green, blue or black. Please note this does not affect the performance of your LCD.
	An error message appears	<ul style="list-style-type: none"> ● Follow the message's instructions. ● If the problem persists, contact your local Panasonic dealer or the authorized Service Centre.

On screen messages

Message	Meaning / Action
All tuning data will be erased	▶ ● "Shipping Condition" will erase all tuning data (p. 46).
Are you sure ?	▶ ● Confirm correct operation.
Are you sure you want to delete this timer ? Press OK to delete timer. Press RETURN to return.	▶ ● Confirm correct operation.
Bad signal	▶ ● The signal is weak. Check the aerial is plugged in properly. It may be necessary to have an aerial installer check the signal and aerial alignment. ● Reset channels. (p. 36 and p. 37)
Child Lock is active! Press OK to enter PIN.	▶ ● The selected channel is locked in Child Lock (p. 44). You must enter the PIN number before the channel will be displayed.
Feature not available.	▶ ● It is not possible to record from COMPONENT, HDMI or PC. Connect the recorder to the TV using a fully wired SCART cable for recording from the TV tuner. ● Confirm Q-Link or VIERA Link settings (p. 56 - p. 57)
Feature not available. Press OK to view how it works.	▶ ● The selected feature on VIERA TOOLS is not available. Press the OK button to view the demonstration to explain how to use it.
Found new software version ***. Press OK to start update (may take 40 mins) or Press EXIT to ignore and you can update when TV is in standby	▶ ● There is a new software available.
Invalid operation - Please check settings and connections.	▶ ● Check the Q-Link or VIERA Link connection and setting (p. 56 - p. 57).
Invalid system time. Please exit !	▶ ● Cannot get the time information and cannot edit Timer Programming screen. Check the connection of the RF cable.
Invalid system time, Timer Programming will not work. Please press TV button on remote control and check time display on Banner	▶ ● Cannot get the time information. If there is no time displayed on the Information banner, check the connection of the RF cable.
Max. number of timers already set !	▶ ● The maximum number of timer programming events is 15.
New channels found! Press OK to update channel list Press EXIT to ignore.	▶ ● There may be new channels available. ● This message will appear each time a change is made by the broadcasters. This message can be deactivated by setting "New Channel Message" to Off in "DVB Tuning Menu". Selecting OK will perform "Update Channel List".
No channel found. Please check aerial or local signal availability. Press OK to start Auto Setup.	▶ ● Follow the on screen instructions. ● Please also refer to p. 70. ● If channels are still not found, consult your local Panasonic dealer.
No module inserted	▶ ● Check the CI module is inserted completely (p. 48).
No recording - Already recording	▶ ● The equipment may already be recording.
No recording - Check media	▶ ● The tape or disc may be "write protected", fully missing or damaged.
No recording - Playing	▶ ● The equipment may be playing the tape or disc.
No recording - Unknown reason	▶ ● The recording may not be performed. Check the equipment.
No service	▶ ● The broadcaster has stopped the service. Check the channel in the TV Guide. (p. 18 and p. 19)
No signal	▶ ● The TV cannot detect the signal. Check the connection of the RF cable.
PIN incorrect!	▶ ● The PIN number you entered is wrong.
Please check settings and connections on HDMI devices.	▶ ● Communication error in VIERA Link function (p. 59).
Please wait.	▶ ● A function is in progress.
Recording this channel now	▶ ● The recorder is recording the programme from its own tuner. You can turn the TV off and leave the equipment recording in the normal way.
Reset to Factory Shipping Condition Completed. Please switch off TV.	▶ ● "Auto Setup" will automatically start when Mains power On / Off switch is next turned On. (p. 12)
Sending Preset Data	▶ ● Q-Link or VIERA Link channel download is in progress.

Message	Meaning / Action
Software successfully updated. Press EXIT to continue.	● The software updating is finished.
Software update failed. Please try again later. Press EXIT to continue.	● Perform "System Update Search Now" in System Update (p. 49). If this is still unsuccessful, there may not be any new software available.
This timer will not follow the TV Guide information. Press OK to continue, RETURN to restore original timer.	● If you edit the start time or end time of Guide link programming more than 10 minutes, it will no longer be performed as Guide link programming. The programming will be performed according to the time setting.
Timer already expired !	● The starting time in Timer Programming has already passed. Set the timer correctly (p. 43).
Timer Event Due to Start ***:*** has been programmed for External recording at **:***	● This message will appear 2 mins. before timer programming event for external recording due to start.
Timer incorrect !	● Set the start and end times in Timer Programming correctly (p. 43).
Timer overlap. Press OK to keep, RETURN to edit.	● Timer programming events are overlapped. Press the OK button to keep the overlapped setting. "Ext Rec." is given priority over "Reminder". When two or more "Ext Rec." overlap, the first timer programming event starts and finishes as programmed. The next timer programming event can then start.
Tuner Locked Press EXIT to unlock. Any timer programme in progress will also be deleted.	● If you want to unlock the tuner, cancel Direct TV Recording (p. 58 and p. 60) or Ext Rec. of Timer Programming (p. 43).
Unable to download, please check equipment	● The tape or disc is active. Stop the equipment and try again.
Media Player	
Cannot read file	● The file is damaged or unreadable. ● The TV does not support the format. (For the applicable formats and data → p. 67)
No SD card inserted	● Confirm the SD Card is inserted correctly.
No valid file to play	● The card has no data.
Please confirm the SD card is OK	● The inserted SD Card has a problem.
This operation is not possible	● The selected operation is not available.

Glossary

AVCHD

Advanced Video Codec High Definition - A standard for high definition video cameras that can be used to record and play high resolution HD images

DVB

Digital Video Broadcasting

DVD

Digital Versatile Disc

DVI

Digital Visual Interface - A high quality video interface standard to connect to the display

EPG

Electronic Programme Guide - A digital guide showing scheduled programmes

HDMI

High-Definition Multimedia Interface - A digital audio and video interface for transmitting uncompressed digital signals on a single cable

JPEG

Joint Photographic Experts Group - A standard for compressing colour still pictures

MPEG2

Moving Picture Experts Group phase 2 - A standard for efficiently compressing and expanding colour videos

NICAM

Near Instantaneous Companded Audio Multiplex - A format for digital sound over television

NTSC

National Television System Committee - One of the television signals used in USA, etc.

RF

Radio Frequency - Signal received from terrestrial aerial

RGB / S-Video / Video

Choose between these three video formats depending on personal preference and equipment requirement (RGB - Red, Green and Blue)

SCART

21 pin connection used for video, audio and switching signals (Also known as Euro SCART and Peritel)

Shop viewing environment

Shop viewing environment is the demonstration mode to explain main features of this TV in an easy understandable way. This mode will work if you select "Shop" in "Auto Setup" (p. 12 and p. 13).

SPDIF

A standard audio transfer file format

VCR

Video Cassette Recorder

Maintenance

First, remove the mains plug from the socket outlet.

Display panel, Cabinet, Pedestal

Regular care:

Gently wipe the surface of the display panel, cabinet, or pedestal by using a soft cloth to clean the dirt or fingerprints. For stubborn dirt:

Dampen a soft cloth with clean water or diluted neutral detergent (1 part detergent to 100 parts water). Then wring the cloth and wipe the surface. Finally, wipe away all the moisture.

Caution

- Do not use a hard cloth or rub the surface too hard. This may cause scratches on the surface.
- Take care not to subject the TV's surfaces to water or detergent. A liquid inside the TV could lead to product failure.
- Take care not to subject the surfaces to insect repellent, solvent, thinner, or other volatile substances. This may degrade surface quality or cause peeling of the paint.
- Take care not to tap or scratch the surface with your fingernail or other hard objects.
- Do not allow the cabinet and pedestal to make contact with a rubber or PVC substance for a long time. This may degrade surface quality.

Mains plug

Wipe the mains plug with a dry cloth at regular intervals. Moisture and dust may lead to fire or electrical shock.

Licence

Even if no special notation has been made of company or product trademarks, these trademarks have been fully respected.

- DVB and the DVB logos are trademarks of the DVB Project.
- VGA is a trademark of International Business Machines Corporation.
- Macintosh is a registered trademark of Apple Inc., USA.
- S-VGA is a registered trademark of the Video Electronics Standard Association.
- SDXC Logo is a trademark of SD-3C, LLC.
- HDMI, the HDMI Logo, and High-Definition Multimedia Interface are trademarks or registered trademarks of HDMI Licensing LLC in the United States and other countries.
- HDAVI Control™ is a trademark of Panasonic Corporation.
- "AVCHD" and the "AVCHD" logo are trademarks of Panasonic Corporation and Sony Corporation.
- Manufactured under license from Dolby Laboratories.
Dolby and the double-D symbol are trademarks of Dolby Laboratories.
- GUIDE Plus+ is (1) a registered trademark or trademark of, (2) manufactured under license from and (3) subject of various international patents and patent applications owned by, or licensed to, Gemstar-TV Guide International, Inc. and/or its related affiliates.

Index

- A** Accessories 6
Analogue Tuning Menu 37, 40, 41
Aspect 16, 66
Audio Description 17, 29
Auto Setup 12, 36, 37
Auto Standby 32
AV1 / AV2 out 30, 58
- B** Banner Display Timeout 31
- C** Category list 18
C.A.T.S. 28
Channel List 39, 41
Channel Sorting by Region 38
Child Lock 44
CI module 48
COMPONENT 65, 68
Connection 10, 11, 56, 57, 64, 65
- D** Direct TV Recording 58, 60
D-sub 15-pin 69
DVB Tuning Menu 36, 38
DVI 68
DVI Input Setting 32
DVD Recorder 10, 11, 24, 25
- E** EPG 18
Equalizer 29
External equipment 10, 11, 24, 64, 65
External input 24, 45
- F** FAQs 70, 71
Favourites Edit 39
Free input menu 27
- G** Glossary 73
Guide link recording 19
GUIDE Plus+ Settings 32
- H** HDMI 68
Hold 15, 22
Home Cinema 57, 63
- I** Information banner 15
Input Labels 45
Input signal 69
- L** Last view 17
Licence 74
- M** Mains Lead 4, 10, 11
Mains power On / Off switch 9, 12
Maintenance 74
Manual Tuning 38, 41
Media Player 50-53
Menu Functions 27-32
Mode 29
Monaural Audio 17
Multi Audio 17
- N** New Channel Message 40
NICAM 29, 73
Normalisation 8, 27
NTSC 28, 73
- O** Off Timer 17, 30
Optional accessories 6
Owner ID 12, 47
- P** PAL 75
PC 54, 55, 69
Pedestal 6, 7
Photo Mode 50
PIN number 13, 44, 47
Playing Time Display 31
P-NR 28
Power and Timer LED 9, 19, 42
- Q** Q-Link 30, 56, 58
Q-Link Download 12, 30
- R** Quick Start Guide 6-13
Radio Mode 31
Remote control 6, 8
Reset to Defaults 28, 29, 46
RGB 73, 75
- S** Sales and Support Information 76
Satellite receiver 11, 24, 64
SCART 10, 56, 68
SD Card 50, 67
Search list 18
Shipping Condition 46
Signal Condition 40
Slideshow 50, 51
SPDIF Selection 53
Specifications 75
Split Programme 20
Subtitles 15, 23
S-Video 68
System Update 49
- T** Teletext 21-23
Timer Programming 42
TV Guide 18-20
- U** Update Channel List 40
- V** V-Audio Surround 29
VCR 10, 11, 24, 25, 65
Video Mode 52
VIERA Link 56, 57, 59-63
VIERA TOOLS 26
Viewing Mode 28
Vivid Colour 28
Volume Correction 29
- W** WSS 66
- Z** Zoom 16

Specifications

		TX-L26X20B		
Power Source		AC 220-240 V, 50 Hz		
Rated Power Consumption		65 W		
Standby Power Consumption		0,3 W 13 W (With monitor out recording)		
Display panel	Aspect Ratio	16:9		
	Visible screen size	66 cm (diagonal) 577 mm (W) × 325 mm (H)		
	Number of pixels	1,049,088 (1,366 (W) × 768 (H))		
Sound	Speaker	120 mm × 42 mm × 2 pcs, 8 Ω		
	Audio Output	10 W (5 W + 5 W), 10% THD		
	Headphones	M3 (3.5 mm) stereo mini Jack × 1		
PC signals		VGA, SVGA, XGA SXGA (compressed) Horizontal scanning frequency 31 - 69 kHz Vertical scanning frequency 59 - 86 Hz		
Receiving Systems / Band name		PAL I UHF E21-68 PAL 525/60 Playback of NTSC tape from some PAL Video recorders (VCR) or NTSC disc playback from DVD player and recorder. DVB-T Digital terrestrial services via UHF aerial input. M.NTSC Playback from M.NTSC Video recorders (VCR). NTSC (AV input only) Playback from NTSC Video recorders (VCR).		
Aerial input		UHF		
Operating Conditions		Temperature : 0 °C - 35 °C Humidity : 20 % - 80 % RH (non-condensing)		
Connection Terminals	AV1 (SCART terminal)	21 Pin terminal (Audio/Video in, Audio/Video out, RGB in, Q-Link)		
	AV2 (SCART terminal)	21 Pin terminal (Audio/Video in, Audio/Video out, RGB in, S-Video in, Q-Link)		
	AV3	VIDEO	RCA PIN Type × 1	1.0 V[p-p] (75 Ω)
		AUDIO L - R	RCA PIN Type × 2	0.5 V[rms]
	COMPONENT	VIDEO	Y P_B, P_R	1.0 V[p-p] (including synchronization) ±0.35 V[p-p]
		AUDIO L - R	RCA PIN Type × 2	0.5 V[rms]
	Others	HDMI 1 / 2 / 3	TYPE A Connectors HDMI2 : HDMI (Version 1.4 with Audio Return Channel) ● This TV supports "HDMI Control 5" function.	
		PC	HIGH-DENSITY D-SUB 15PIN R,G,B/0.7 V[p-p] (75 Ω) HD, VD/TTL Level 2.0 - 5.0 V[p-p] (high impedance)	
		Card slot	SD Card slot × 1 Common Interface slot × 1	
	Output	AUDIO L - R	RCA PIN Type × 2	0.5 V[rms] (high impedance)
DIGITAL AUDIO OUT		PCM / Dolby Digital, Fiber optic		
Dimensions (W × H × D)		664 mm × 474 mm × 217 mm (With Pedestal) 664 mm × 434 mm × 109 mm (TV only)		
Mass		9.5 kg Net (With Pedestal) 8.0 kg Net (TV only)		

- Design and Specifications are subject to change without notice. Mass and Dimensions shown are approximate.
- This equipment complies with the EMC standards listed below.
EN55013, EN61000-3-2, EN61000-3-3, EN55020, EN55022, EN55024.

This product is licensed under the AVC patent portfolio license for the personal and non-commercial use of a consumer to (i) encode video in compliance with the AVC Standard ("AVC Video") and/or (ii) decode AVC Video that was encoded by a consumer engaged in a personal and non-commercial activity and/or was obtained from a video provider licensed to provide AVC Video. No license is granted or shall be implied for any other use. Additional information may be obtained from MPEG LA, LLC. See <http://www.mpegla.com>.

GEMSTAR-TV GUIDE INTERNATIONAL, INC. AND/OR ITS RELATED AFFILIATES ARE NOT IN ANY WAY LIABLE FOR THE ACCURACY OF THE PROGRAM SCHEDULE INFORMATION PROVIDED BY THE GUIDE PLUS+ SYSTEM. IN NO EVENT SHALL GEMSTAR-TV GUIDE INTERNATIONAL, INC. AND/OR ITS RELATED AFFILIATES BE LIABLE FOR ANY AMOUNTS REPRESENTING LOSS OF PROFITS, LOSS OF BUSINESS, OR INDIRECT, SPECIAL, OR CONSEQUENTIAL DAMAGES IN CONNECTION WITH THE PROVISION OR USE OF ANY INFORMATION, EQUIPMENT, OR SERVICES RELATING TO THE GUIDE PLUS+ SYSTEM.

<http://www.europe.guideplus.com>

Information for Users on Collection and Disposal of Old Equipment and used Batteries



These symbols on the products, packaging, and/or accompanying documents mean that used electrical and electronic products and batteries should not be mixed with general household waste. For proper treatment, recovery and recycling of old products and used batteries, please take them to applicable collection points, in accordance with your national legislation and the Directives 2002/96/EC and 2006/66/EC.

By disposing of these products and batteries correctly, you will help to save valuable resources and prevent any potential negative effects on human health and the environment which could otherwise arise from inappropriate waste handling.

For more information about collection and recycling of old products and batteries, please contact your local municipality, your waste disposal service or the point of sale where you purchased the items.

Penalties may be applicable for incorrect disposal of this waste, in accordance with national legislation.



For business users in the European Union

If you wish to discard electrical and electronic equipment, please contact your dealer or supplier for further information.

[Information on Disposal in other Countries outside the European Union]

These symbols are only valid in the European Union. If you wish to discard these items, please contact your local authorities or dealer and ask for the correct method of disposal.



Note for the battery symbol (bottom two symbol examples):

This symbol might be used in combination with a chemical symbol. In this case it complies with the requirement set by the Directive for the chemical involved.

Cd

Sales and Support Information

Customer Care Centre

- For customers within the UK: **0844 844 3852**
- For customers within the Republic of Ireland: **01 289 8333**
- Visit our website for product information: **www.panasonic.co.uk**
- E-mail: **customer.care@panasonic.co.uk**

Direct Sales at Panasonic UK

- For customers: **0844 844 3856**
- Order accessory and consumable items for your product with ease and confidence by phoning our Customer Care Centre Monday – Thursday 9:00am – 5:30pm, Friday 9:30am – 5:30pm (Excluding public holidays).
- Or go on line through our Internet Accessory ordering application at **www.pas-europe.com**
- Most major credit and debit cards accepted.
- All enquiries transactions and distribution facilities are provided directly by Panasonic UK Ltd.
- It couldn't be simpler!
- Also available through our Internet is direct shopping for a wide range of finished products, take a browse on our website for further details.



Declaration of Conformity (DoC)

If you want to get a copy of the original DoC of this TV, please visit the following website:

<http://www.doc.panasonic.de>

Authorized Representative:

Panasonic Testing Centre

Panasonic Marketing Europe GmbH

Winsbergring 15, 22525 Hamburg, Germany

Customer's Record

The model number and serial number of this product may be found on its rear panel. You should note this serial number in the space provided below and retain this book, plus your purchase receipt, as a permanent record of your purchase to aid in identification in the event of theft or loss, and for Warranty Service purposes.

Model Number _____

Serial Number _____

Panasonic (U. K.) Ltd.

Willoughby Road, Bracknell, Berks RG12 8FP

Web Site : <http://panasonic.net>

© Panasonic Corporation 2010