

Panasonic

Digital Cordless Phone

Model No. **KX-TCD715EM**

Operating Instructions



**PLEASE READ BEFORE USE
AND SAVE.**

Caller ID Compatible

Charge the batteries for about 15 hours before initial use.

This equipment is not designed for making emergency telephony calls when the power fails. Alternative arrangements should be made for access to emergency services.

Thank you for purchasing your new Panasonic digital cordless telephone.

- Order accessory items for all Communications Products with ease and confidence either by telephoning our Customer Care Centre on:
08705 357357 Monday - Friday 9:00am - 5:30pm
- Or go on line through our Internet Accessory ordering application at **www.panasonic.co.uk**.
- Most major credit and debit cards accepted.
- All enquires transactions and distribution facilities are provided directly by Panasonic UK Ltd.
- It couldn't be simpler!

Dear purchaser,

You have acquired a KX-TCD715EM, which is a product made in regard with the European Standards for Cordless Telephones (DECT). DECT technology is characterised by high-security protection against interceptions as well as high-quality digital transmission.

This telephone was designed for a wide range of applications.

For example, this telephone can be used within a network of base units and handsets, constituting a telephone system which:

- operates up to 6 handsets at one base unit
- allows an intercom between 2 handsets
- allows the operation of a handset at up to 4 base units, expanding the communication radio area.

This telephone may be used for:

- operating several handsets
- operating at several base units
- connecting the base unit to a PBX.

Important Information

Do not connect the AC adaptor to any AC outlet other than the standard AC 220–240 V, 50 Hz.

Outlet voltage DC 9 V, 200 mA

- The apparatus is approved for use with the PQLV1E power supply.
- CAUTION: Do not remove cover. Live parts inside.

This apparatus has been approved for the use of the following facilities:

- 1) Storage of names and telephone numbers in the phonebook for retrieval
- 2) Last number redial
- 3) Simple telephone facility
- 4) PBX earth register recall (option)
PBX timed break register recall
- 5) MF signalling

- 6) Pause
- 7) Intercom
- 8) Call prohibition
- 9) Call restriction
- 10) Direct call
- 11) Intercom between handsets
- 12) Transferring a call from one handset to another
- 13) Conference
- 14) Setting the call waiting tone
- 15) Accessing the base unit
- 16) Caller ID service compatible

Any other usage will invalidate the approval of the apparatus if as a result, it then ceases to conform to the standards against which approval was granted.

Method of connection

This is connected to the exchange line or PABX/PMBX (Private Automatic/Manual Branch Exchange) extension by the new standard British Telecom plug and socket. Arrangements for provision of this type of termination can be made through the nearest British Telecom Sales Office. The apparatus may be connected to the following types of installation. The apparatus has been approved for use under the following conditions:

- a) This apparatus may be used on telecommunication systems employing MF signalling. It is suitable for connection to a direct exchange line on the PSTN (Public Switched Telephone Network) or via a compatible PBX (Private Branch Exchange). (Contact the supplier for an up to date list of compatible PBX's.)
- b) This apparatus is not suitable as an extension to a payphone or for use on a party line with shared service. This cordless telephone has been designed to operate on radio frequencies which have been assigned to the exclusive use of cordless telephones. As the use of cordless telephones becomes more widespread users may experience a reduction in the quality of service obtainable from this apparatus.

Although this equipment can use either loop disconnected or DTMF signalling, only the performance of the DTMF signalling is subject to regulatory requirements for correct operation. It is therefore strongly recommended that the equipment is set to use DTMF signalling for access to public or private emergency services. DTMF signalling also provides faster call set up.

999 or 112 can be dialled on the apparatus for the purposes of making outgoing calls to the BT Emergency (999 or 112) Service.

WARNING:

The apparatus may be unable to make emergency 999 or 112 telephone calls, under certain conditions, e.g.

- Radio interference caused by another cordless telephone operating on the same radio frequency.
- The portable handset battery needs recharging, or has failed.
- The portable handset cannot be used while charging.
- When KEY LOCK is set to ON.
- When the unit is in Direct Call Mode.

Any cases of difficulty should be referred in the first instance to the supplier of the apparatus.

NOTE:

If you experience any problems with the normal use of your apparatus, you should unplug it from the telephone outlet and connect a known working telephone in its place. If the known working telephone still gives problems, then please contact the customer service department of your PSTN operator. If it operates properly, then the problem is likely to be a fault in your apparatus. In this case, contact your supplier for advice. Your PSTN operator may charge you if they attend a service call that is not due to apparatus supplied by them.

Before Initial Use



Caller ID, where available, is a telephone company service. After subscribing to Caller ID, this phone will display the caller's phone number. A second caller's phone number displays while the user is on another call, requires a subscription to both Caller ID and Call Waiting.

For your future reference

Serial No. _____ Date of purchase _____
 (found on the bottom of the unit)

Name and address of dealer _____

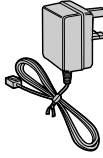
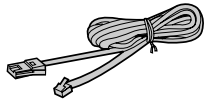
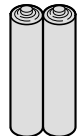
Included with this unit

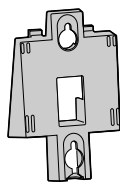
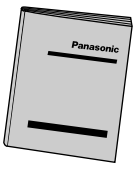
<input type="checkbox"/> AC Adaptor (p. 11) Part No. PQLV1E  one	<input type="checkbox"/> Telephone Line Cord (p. 11) Part No. PQJA87S  one	<input type="checkbox"/> Batteries (p. 12) Part No. BYD N4DH33B00001  two	<input type="checkbox"/> Handset Cover (p. 12) Part No. PQKK10109Z5  one
<input type="checkbox"/> Belt Clip (p. 69) Part No. PQKE10120Z2  one	<input type="checkbox"/> Wall Mounting (p. 72) Part No. PQKL10038Y2  one	<input type="checkbox"/> Operating Instructions Part No. PQQX12950Z  one	

Optional accessories

Please contact the place of purchase for the following options.

Model No.	Description
KX-A115E	Handset/Charger
P6H	Ni-Cd batteries
KX-A109EX	Option covers

For Best Performance

Battery Charge

Rechargeable Nickel-Metal Hydride (Ni-MH) batteries power the handset. Install the batteries (p. 12) and charge them for about **15 hours** before initial use (p. 12).

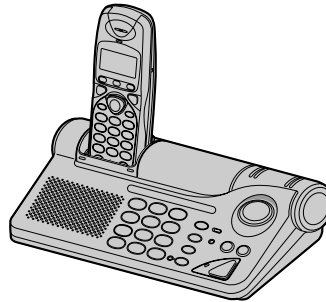

Base Unit Location

Calls are transmitted between the base unit and the handset using wireless radio waves. For **maximum distance and noise-free operation**, the recommended base unit location is:

Away from electrical appliances such as a TV, radio, personal computer or another telephone.

In a **HIGH** and **CENTRAL** location with no obstructions such as walls.

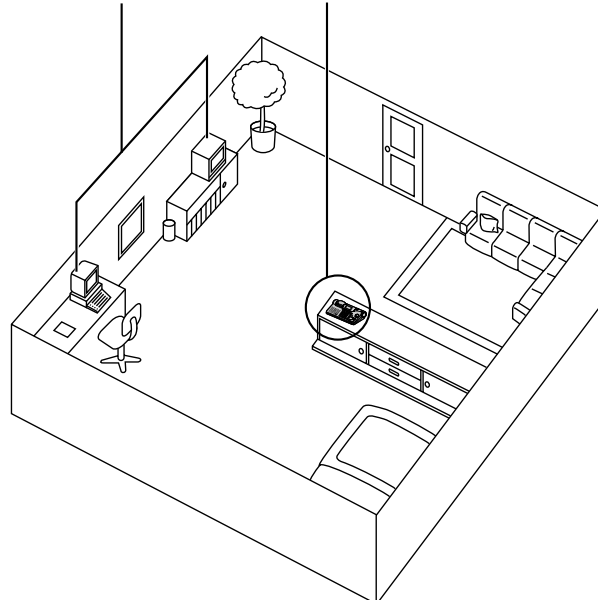

Operating range:

The range of operation depends on the construction of your home, weather and usage conditions. Normally you will get longer range outdoors than indoors. Obstacles such as walls, metal shelves or cement-iron walls may shorten the operating range.

Noise:

Occasional noise or interference may occur due to other random radio waves.

Contents

Chapter 1 Preparation

Location of Controls	8
Display	10
Settings	11
Connections	11
Installing the Batteries in the Handset	12
Battery Charge	12
Turning the Power ON	13
Summary of Programmable Functions	14
Programmable Settings	18
Setting the Display Language	18
Selecting the Auto Talk Feature	18
Setting the Date and Time	19
Selecting the Handset Ringer Volume	20
Selecting the Base Unit Ringer Volume	20

Chapter 2 Basic Operations

Making Calls	21
With the Handset	21
With the Base Unit (Digital Speakerphone)	24
Answering Calls	25
Caller ID Service	26
Using the Caller List	27
Viewing the Caller List	27
Calling Back from the Caller List	28
Editing the Caller's Phone Number	28
Storing the Caller List Information in the Phonebook	29
Clearing the Caller List	30
Using the Phonebook	31
Storing Names and Numbers in the Phonebook	32
Using the Private Category Feature	36

Finding Items in the Phonebook	37
Dialling from the Phonebook	37
Editing an Item in the Phonebook	38
Clearing an Item from the Phonebook	38
Hot Key Dial	39
Phonebook Copy	40
Intercom	41
Transferring a Call Using the Intercom	42
Special Features	43
How to Use the Pause Feature (For Analog PBX Line/Long Distance Service Users)	43
Setting the Key Lock	44
Using the Recall Feature	44
Call Waiting and Caller ID Compatible	45

Chapter 3 Advanced Operations

Direct Call	46
Setting the Direct Call Number and Mode	46
Dialling the Stored Number	46
Call Prohibition	47
Call Restriction	48
Setting the Time Alarm	50
Other Programmable Settings	51
Setting the Talk Mode Display	51
Setting the Handset Ringer Type	52
Selecting the Call Waiting Tone	53
Setting the Range Warning Alarm	53
Setting the Battery Low Alarm	53
Selecting the Base Unit Ringer Pattern	54
Setting the Key Tones	54
Selecting the Display Backlight Color	54
Setting the PIN	55
Clearing the Settings in Memory	56

Chapter 4 **Multi-Unit User Operations**

For Optional Multi-Unit Users	58
Operating More than One Handset.....	58
Operating More than One Base Unit...	58
Registering Optional Handset(s) in the Base Unit.....	59
Selecting the Base Unit Access	60
Cancelling a Handset	61
Bell Selection.....	62
Selecting the Standby Mode Display ..	64
Paging/Intercom	65
Intercom between the Handset(s) and the Base Unit.....	65
Transferring a Call from the Base Unit to a Handset.....	66
Intercom between Handsets	66
Transferring a Call from One Handset to Another	67
Conference	68

Chapter 5 **Useful Information**

Using a Belt Clip	69
Using an Optional Headset	69
Replacing the Batteries	70
Important Notice Concerning the Correct Use and Charging of Ni-MH (Ni-Cd) Batteries	71
Wall Mounting	72
Option Covers	73
Before Requesting Help	74
Safety Instructions	77
Adding Another Phone	78
Term Definitions	78
GUARANTEE CONDITIONS OF GUARANTEE	79

Chapter 1

Chapter 2

Chapter 3

Chapter 4

Chapter 5

Location of Controls

Base unit

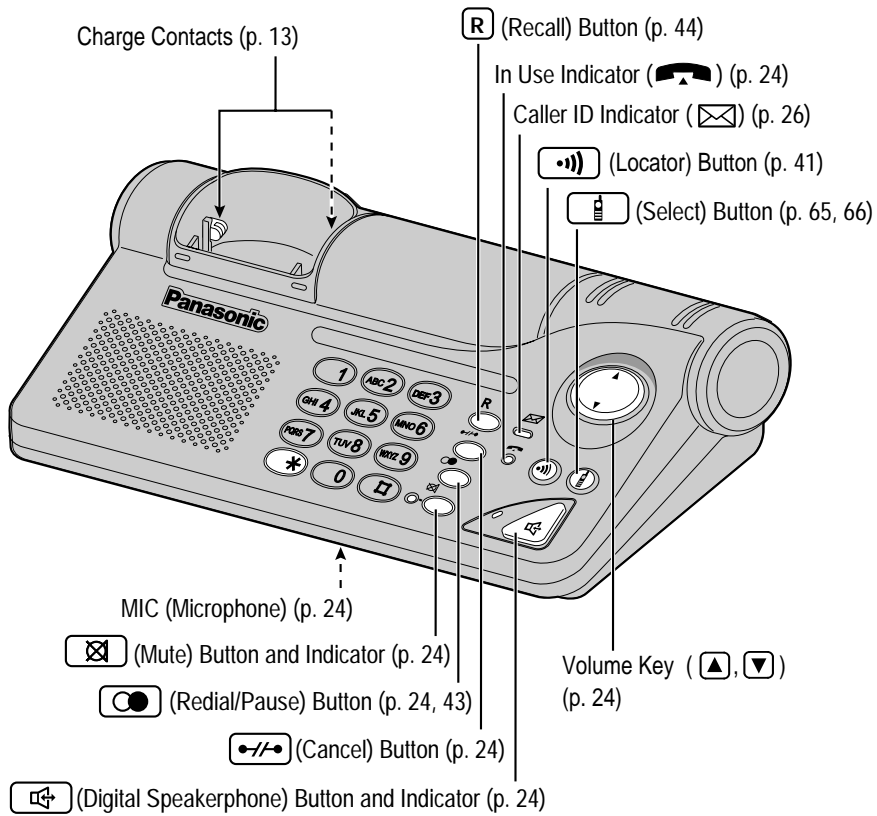



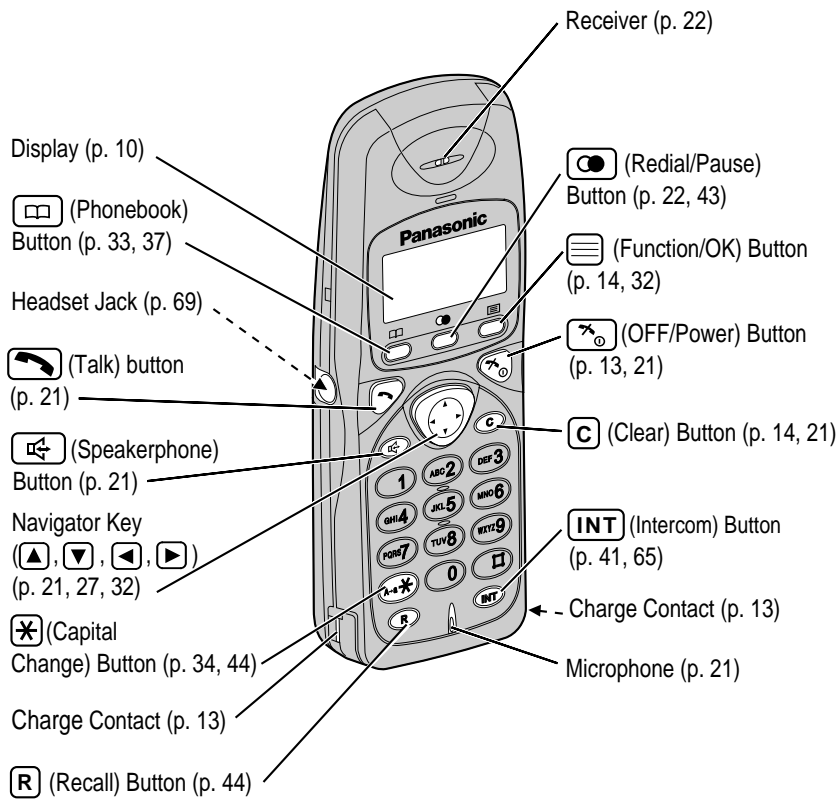
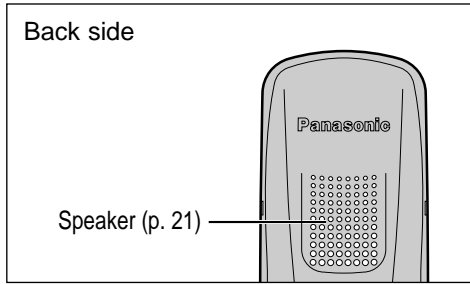



Handset



Display



Icons

-  The in-range icon indicates that the handset is in range of the base unit. It flashes when the handset is out of range.
-  The page/intercom icon is displayed when paging or using the intercom. It flashes when another unit pages the handset.
-  The talk icon is displayed when making or answering calls. It flashes when an external call is being received.
-  The call prohibition icon is displayed when this mode is turned on (p. 47).
-  The phonebook icon is displayed when storing or viewing the phonebook items (p. 33, 37).
-  The battery icon indicates the battery strength (p. 12).

Characters

-  "Pause" is selected while dialling.
-   is pressed while dialling.
-  Direct call mode is ON (p. 46).
-  Key lock is ON (p. 44).

Display backlight

The handset has the backlight display. The display will light when you start using the handset, and when a call is received. The handset display light will stay on for about 10 seconds after pressing a button or lifting the handset off the base unit. You can change the backlight color for identifying callers by setting the private category feature (p. 36).

Lighted handset keypad

The handset dialling buttons will light when pressing a button, lifting the handset off the base unit or receiving a call. The lights will go out about 10 seconds after pressing a button, lifting the handset or answering a call.

Settings



Connections

Chapter 1

Preparation

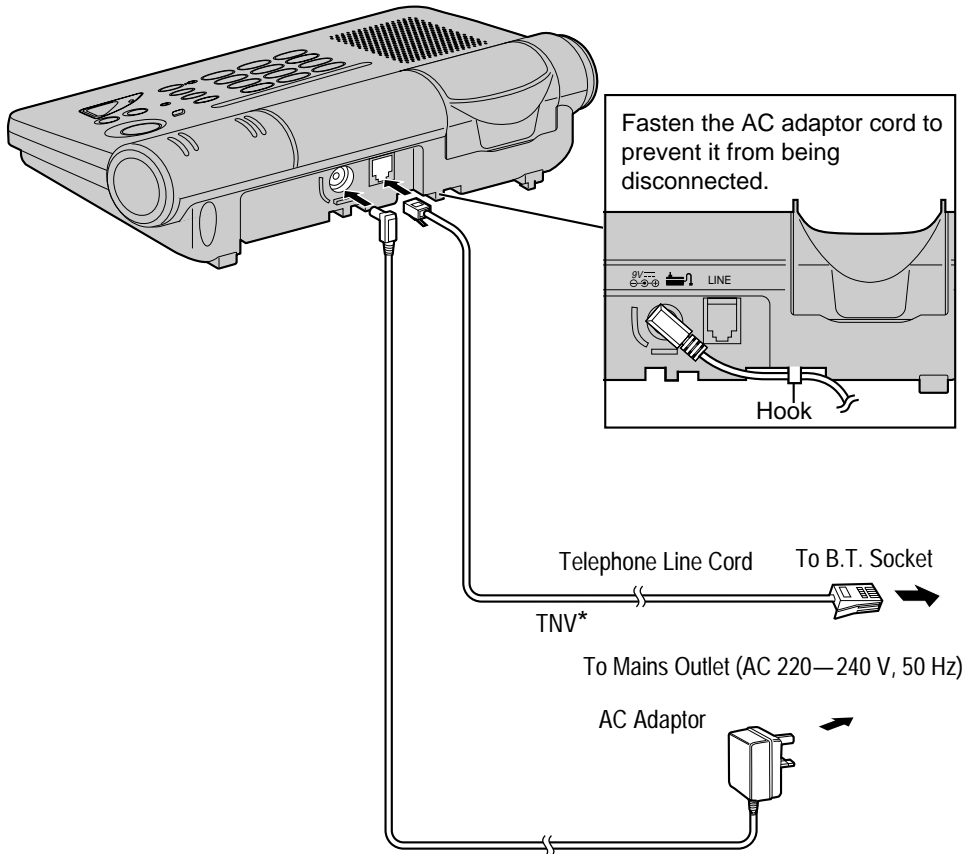

- USE ONLY WITH Panasonic AC ADAPTOR PQLV1E.
 - The AC adaptor must remain connected at all times. (It is normal for the adaptor to feel warm during use.)
 - If your unit is connected to a PBX which does not support Caller ID services, you cannot access those services.
 - To connect a standard telephone on the same line, see page 77.
- * The abbreviation TNV means "Telephone Network Voltage".

CONNECTION OF POWER SUPPLY

This apparatus is intended for use when powered by the PQLV1E.
Using other power supplies will invalidate any approval given to this apparatus.

➔ Settings

Installing the Batteries in the Handset

Install the batteries as shown. Then install the handset cover.

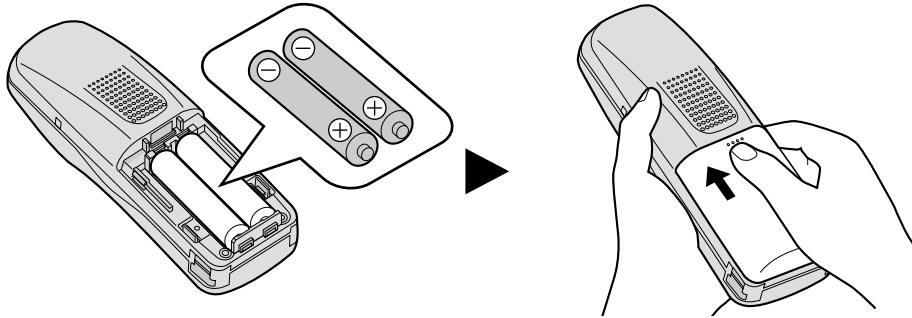

- If the rechargeable batteries are not inserted correctly, the handset will not work.

Battery Charge

At the time of shipment, the batteries are not charged. To charge, place the handset on the base unit. Please charge the batteries for about **15 hours** before initial use. During charging the battery, battery icon is as shown below.

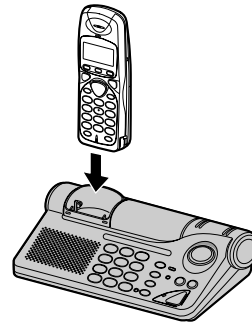
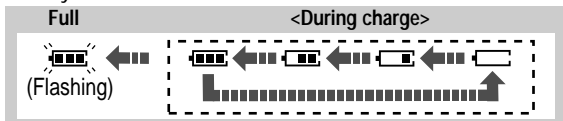

Battery strength

You can check the present battery strength on the display.

Battery strength	Fully charged	High	Medium	Low	Need to be charged.
Display prompt	(Flashing)				(Flashing)

Recharge

When "" flashes or the unit beeps every 15 seconds, recharge the batteries.

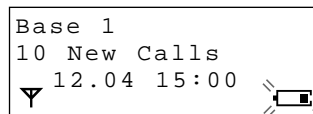

Battery information

After your batteries are fully charged:

Operation	Ni-MH battery operating time (included)	Ni-Cd battery operating time (optional)*
While in use (Talk)	Up to about 20 hours	Up to about 12 hours (based on 800mA per hour)
While not in use (Standby)	Up to about 200 hours	Up to about 100 hours

- Battery operating time may be shortened depending on usage conditions, such as:
 - when viewing the Caller ID Caller List, or phonebook
 - when talking in speakerphone mode and
 - ambient temperature.
- **Clean the handset and the base unit charge contacts with a soft, dry cloth once a month. Clean more often if the unit is subject to grease, dust or high humidity.** Otherwise the batteries may not charge properly.
- If the batteries are fully charged, you do not have to place the handset on the base unit until "  " flashes. This will maximise the battery life.
- The batteries cannot be overcharged.
- * Nickel cadmium (Ni-Cd) rechargeable batteries (AA size) are available. When you replace the batteries, you must program the battery type selection (see page 70).
- Read "Important Notice Concerning the Correct Use and Charging of Ni-MH (Ni-Cd) Batteries" on page 71.

Turning the Power ON

Press and hold .

- After all the possible configurations briefly appear, the display will change to the following. Then the handset is in the standby mode.

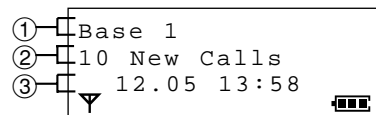

- ① The current connected base unit number:
You can choose whether to display the base unit number, handset number or no display in the standby mode by programming (p. 64).
- ② The number of new Caller ID calls received (p. 26).
- ③ The current date and time:
After you set the date and time, the current date/time will be displayed (p. 19).

To turn the power OFF, press and hold  until a beep sounds.

- The display will go blank.
- The handset will not ring.

Summary of Programmable Functions

You can program the following function items **using the handset near the base unit**. The display shows the instructions. After selecting "Setting Base", enter the desired function command (p. 15). See the corresponding pages for function details.

Make sure that the power is ON (p. 13) and the unit is in the standby mode.

<Standby mode>

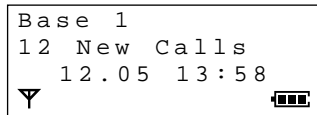

Press .

<Function menu>*

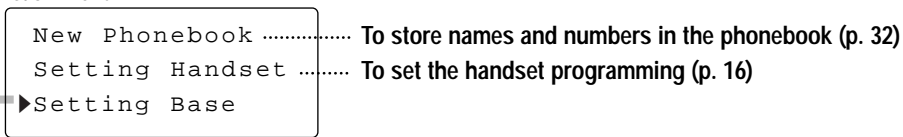



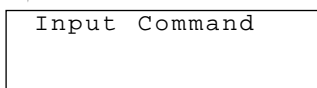





Press .



Enter a desired function command as shown on the next page.

While programming:

*To select a desired function item, press  or  until the arrow points to the item. Then press  to go to the next step.

- You can press  to go to the next menu of the function menu instead of pressing .
- To return to the previous step during programming, press  or .
- You can exit the programming mode any time by pressing  and also can return to "Input Command" by pressing .
- When programming is completed, a beep sounds.



Command menu

Command		Function item
1	1	To select the bell selection (p. 62)
2	1	To set the base unit key tone On/Off (p. 54)
	2	To select the base unit ringer volume (p. 20)
	3	To set the base unit ringer type (p. 54)
3	2	To select the time break recall mode/earth (p. 45)
	3	To set the pause time (p. 43)
5		To change the base unit PIN (p. 55)
6		To set the call restriction (p. 48)
7		To cancel the handset (p. 61)
0		To reset the base unit (p. 57)
*		To set time (p. 19)
*	*	To set date (p. 19)

Chapter 1

Preparation

➔ Summary of Programmable Functions



Handset settings



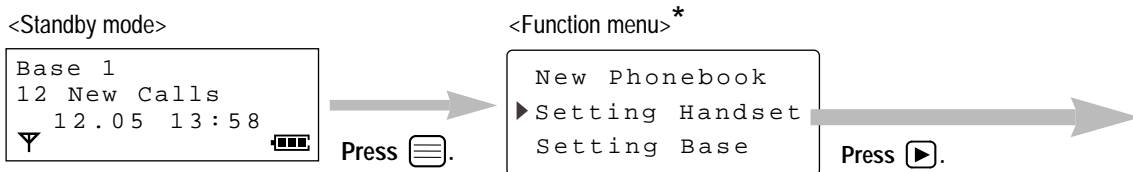

You can program the following function items (**the handset should be within the range of the base unit**). The display shows the instructions. After selecting "Setting Handset", the main menu is displayed. Most items in the main menu have a sub-menu. The sub-menu is shown after selecting the item in the main menu. See the corresponding pages for function details. Main menu items are written in bold and sub-menu items are under each main menu item on the next page.

Make sure that the power is ON (p. 13) and the unit is in the standby mode.



While programming:

*To select a desired function item, press  or  until the arrow points to the item. Then press  to go to the next step.

- You can press  to go to the next menu of the function menu instead of pressing .
- To return to the previous step during programming, press  or .
- You can exit the programming mode any time by pressing .
- When programming is completed, a beep sounds.

Handset settings menu

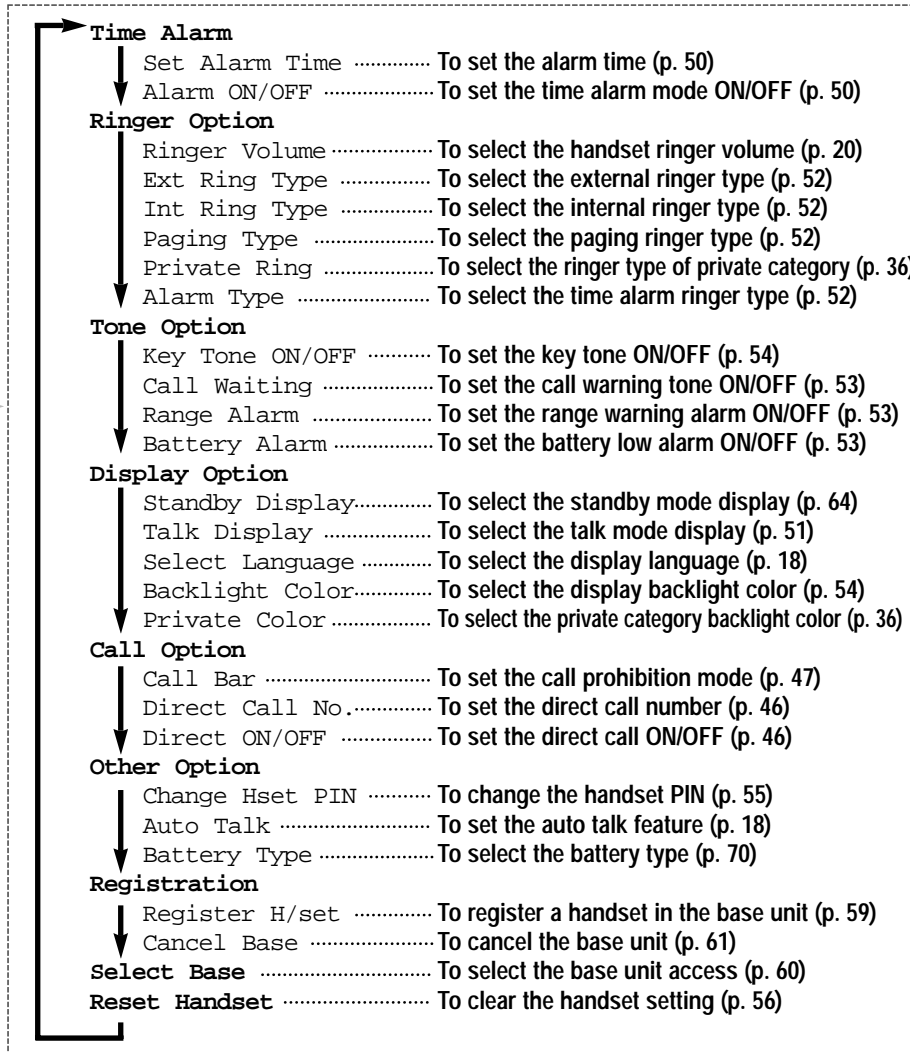















Programmable Settings



Selecting the Display Language

You can choose one of 18 display languages. The factory preset is English.

Make sure that the power is ON (p. 13) and the unit is in the standby mode.















- 1 Press .
- 2 Press  or  until the arrow points to "Setting Handset", then press .
- 3 Press  or  until the arrow points to "Display Option", then press .
- 4 Press  or  until the arrow points to "Select Language", then press .
 - The current setting is at the arrow.
- 5 Press  or  to select the desired language.
- 6 Press .
 - A beep sounds.
 - The display shows in the selected language.
 - To return to the standby mode, press .

Selecting the Auto Talk Feature

The Auto Talk feature allows you to answer a call by lifting the handset off the base unit without pressing  or . If you want to use this feature, turn the feature ON by programming.

The factory preset is OFF. In order to view Caller ID information before answering a call, leave the auto talk feature OFF.

Make sure that the power is ON (p. 13) and the unit is in the standby mode.





- 1 Press .
- 2 Press  or  until the arrow points to "Setting Handset", then press .
- 3 Press  or  until the arrow points to "Other Option", then press .
- 4 Press  or  until the arrow points to "Auto Talk", then press .
 - The current setting is at the arrow.
- 5 Press  or  to select "ON" or "OFF".
- 6 Press .
 - A beep sounds.
 - To return to the standby mode, press .

Setting the Date and Time

After setting the date and time, the current date and time will be displayed on the handset in the standby mode. You can set 24-hour clock by programming.

Make sure that the power is ON (p. 13) and the unit is in the standby mode.

Setting time

- 1 Press .
- 2 Press  or  until the arrow points to "Setting Base", then press .
 - "Input Command" is displayed.

- 3 Press .

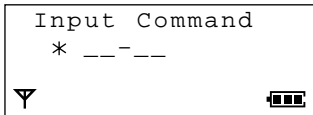

- If already set, the current setting is displayed.

- 4 Enter the current time (24 hour time) using a 4-digit number.



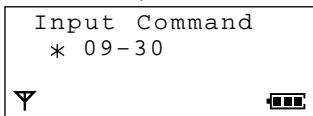

Ex. To set 9:30, enter "0930".



- 5 Press .

- A beep sounds.
- To return to the standby mode, press .

Setting date

- 1 Press .
- 2 Press  or  until the arrow points to "Setting Base", then press .
 - "Input Command" is displayed.

- 3 Press  TWICE.

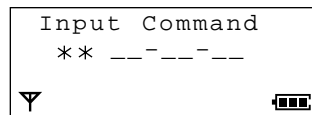

- If already set, the current setting is displayed.

- 4 Enter the current date (day, month, year) using a 6-digit number.

Ex. To set 5. August, 2001, enter "010801".

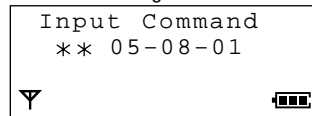

- 5 Press .









- A beep sounds.
- To return to the standby mode, press .

If a power failure occurs, the adjusted day/time will be erased. Readjust the date and time.

➔ Programmable Settings

Selecting the Handset Ringer Volume

6 levels are available. The lowest level is 1. The highest level is 6. The factory preset is 3. When set to OFF, the handset will not ring.

Press  ➔  or  to select "Setting Handset" then  ➔  or  to select "Ringer Option" then  ➔  or  to select "Ringer Volume" then  ➔  or  to select the desired level ➔  ➔ 

•To turn the ringer OFF, erase "■" by pressing  until "OFF" is displayed.

Selecting the Base Unit Ringer Volume

4 levels (HIGH, MEDIUM, LOW, OFF) are available. The factory preset is MEDIUM. When set to  (OFF), the base unit will not ring.

Press  ➔  or  to select "Setting Base" then  ➔  ➔  ➔  ➔  ➔  ➔ 

Making Calls



With the Handset

Make sure that the power is ON (p. 13).

1 Press

- " " is displayed.

2 Dial a phone number.

- The dialled number is displayed.

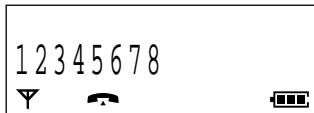

- After a few seconds, the display will show the length of the call.

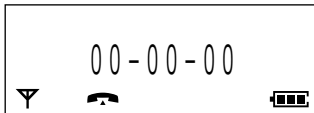

3 To hang up, press or place the handset on the base unit.

- The handset will return to the standby mode.

To dial after confirming the entered number

1 Enter a phone number.

- The entered number is displayed.
- If you misdial, press . Digits are erased from the right.
- To cancel, press and hold or press .

2 Press .

- " " is displayed.
- After a few seconds, the display will start showing the length of the call.

3 To hang up, press or place the handset on the base unit.

- The handset will return to the standby mode.

To have a hands-free phone conversation (Using Digital Speakerphone)

1 Press .

- The button lights.

2 Dial a phone number.

- The dialled number is displayed.
- After a few seconds, the display will show the length of the call.

3 When the other party answers, talk into the microphone.

4 To hang up, press or place the handset on the base unit.

Hands-free Digital Speakerphone

For best performance, please note the following:

- Talk alternately with the caller in a quiet room.
- If the other party has difficulty hearing you, press to decrease the speaker volume.
- If the other party's voice from the speaker cuts in/out during a conversation, press to decrease the speaker volume.
- While talking, you can switch to the hands-free phone conversation by pressing . To switch back to the receiver, press or .

- If " " flashes and an alarm tone sounds after pressing or , move closer to the base unit. Then try again.
- You can choose whether to display either the length of the call or phone number in the talk mode by programming (p. 51).

➔ Making Calls



To select the receiver volume (HIGH, MEDIUM or LOW) or speaker volume (6 levels) while talking

To increase, press .

To decrease, press .

Ex. Receiver volume: HIGH
Speaker volume: level 6





- Each time you press  or , the volume level will change.
- The display will return to the length of the call.

To redial the last number dialled

1 Press  or .

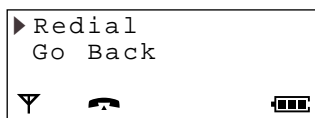

2 Press .



3 While "Redial" is at the arrow, press .

- The last number dialled is automatically redialled.

Automatic Redial:

When using the hands-free digital speakerphone  on the handset, the unit redials the last dialled number up to 12 times (every 40 seconds) if the line is busy. The digital speakerphone button  lights and "Muting" is displayed while redialling.



To redial using the redial list

The last 10 numbers dialled are stored in the redial list.

1 Press .

- The last number dialled is displayed.

2 Press  or  until the desired number is displayed.

- To search from the most recent to the oldest number, press . To search from the oldest to most recent number, press .
- To exit the list, press .

3 Press  or .

- The number is dialled automatically.

- If "No Stored Memory" is displayed in step 1, the redial memory is empty.







- If the same phone number is stored in the phonebook (p. 32), the name will be displayed.



To store a redial number in the phonebook

While the desired number is displayed, press , then see "To store an entered number in the phonebook", from step 3.







To clear a number in the redial memory

- 1 While the desired number is displayed, press .
- 2 Press  or  until the arrow points to "Clear", then press .
- 3 Press  or  to select "YES", then press .

To clear all numbers in the redial memory





Select "All Clear" in step 2 above.

To store an entered number in the phonebook



- 1 Enter a phone number.
 - The entered number is displayed.
 - If you misdial, press . Digits are erased from the right.
 - To cancel, press and hold  or press .
- 2 Press .
- 3 While "Save Phonebook" is at the arrow, press .
 - The display shows the number of remaining phonebook items, then "<Enter Name>".
- 4 Enter a name, up to 16 characters with the dialling buttons,  or .
 - See the steps for entering names and symbols (p. 33).
- 5 To select the private category, see page 32, from step 6.

➔ Making Calls



With the Base Unit (Digital Speakerphone)

- 1 Press .
 - The indicator lights.
 - 2 Dial a telephone number.
 - If you misdial, press  then dial again.
 - 3 When the other party answers, talk into the MIC.
 - 4 To hang up, press .
 - The indicator light goes out.
- The base unit speaker phone cannot be used while a handset is in use. Wait until the in use indicator () goes out.

To adjust the speaker volume (8 levels)



- To increase, press .
- To decrease, press .

To redial the last number dialed on the base unit

Press  ➔ .



Hands-Free Digital Speakerphone

The digital speakerphone enhances your telephone conversation. For best performance, please note the following.

- Talk alternately with the caller in a quiet room.
- If the other party has difficulty hearing you, press  to decrease the speaker volume.
- If the other party's voice from the speaker cuts in/out during a conversation, press  to decrease the speaker volume.

To mute your conversation

Press  while talking.

- The mute indicator () lights.
- The other party cannot hear your voice but you can hear theirs.
- To resume the conversation, press  again.

Answering Calls

If you subscribe to a Caller ID service, the calling party information will be displayed after the first ring (p. 26). Please wait until the second ring to answer a call in order to view the Caller ID information. You can also program the desired external ringer type (p. 52).

Make sure that the power is ON (p. 13), otherwise the handset will not ring.

With the Handset

If the handset is off the base unit;

1 Press .



- You can also answer a call by pressing any dialling button **0** to **9**, *****, **#** or **INT** (-Any Key Talk).

OR

Press  and when the other party answers, talk into the microphone.

2 To hang up, press  or place the handset on the base unit.

Auto talk

If you set the Auto Talk feature to ON (p. 18), you can answer a call by lifting the handset off the base unit without pressing  or .

With the Base Unit

1 Press .

2 Talk into the MIC.

3 To hang up, press .

To turn the handset ringer off temporarily

When the handset starts ringing, press and hold .

- "Ringer Off" is displayed and the handset stops ringing.

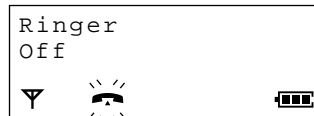

- The ringer will turn back on for the next call.
- This function will not work when the handset is on the base unit.
- The handset and base unit will not ring if both ringer volumes are set to OFF (p. 20).

Caller ID Service

This unit is compatible with a Caller ID service offered by your telephone company. After subscribing to a Caller ID service, the calling party information will be displayed after the first ring.

The unit can record information of up to 50 different callers in the Caller List.

Using this list, you can automatically call back a caller. You can store a caller's phone number from the Caller List into the phonebook.

How caller information is displayed when a call is received

The display shows the caller's phone number when receiving a call.

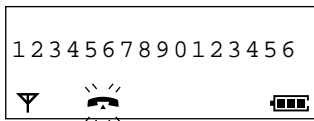

- After you answer the call, the display will show the length of the call.

Private name display

If you receive a call from one of the same phone numbers stored in the phonebook, the caller's name will be displayed.

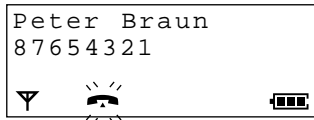

- To use this function, names and phone numbers must be stored in the phonebook (p. 32).

- Caller information cannot be displayed in the following cases:
 - If the caller dialed from an area which does not provide a Caller ID service, the display will show "Out of Area".
 - If the caller has requested not to display his/her information, the display will show "Private Caller".
- If your unit is connected to a PBX which does not support Caller ID services, you cannot access those services.

Checking the number of new calls

When new calls have been received, the Caller ID indicator (☒) flashes on the base unit. In the standby mode, the display shows the number of new calls.

- For example, if you have received 10 new calls, the display will show the following:

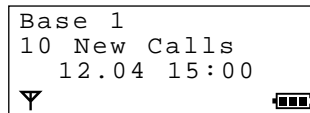

Private category feature:

After subscribing to a Caller ID service, you can select the display backlight color and ringer type for each private category. If you receive a call from one of the phone numbers assigned to one of 9 categories in the phonebook;

- the handset will ring with the selected ringer type,
- the handset display will light in the color of each category.

You can then distinguish the caller from others easily. To use this feature, store items in the phonebook and assign private category to items (p. 36).

Using the Caller List

Viewing the Caller List

Information of up to 50 different callers is sorted from the most recent to the oldest call in the Caller List. When the 51st call is received, the first caller's information is deleted. Each caller's phone number received is shown. If a call is received with the private name display function (p. 32), the caller's name will be shown.

To confirm who has called you, follow the steps below.

Make sure that the power is ON (p. 13) and the unit is in the standby mode.



1 Press  or .

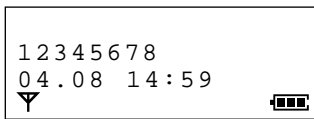

- The most recent caller's information is displayed.

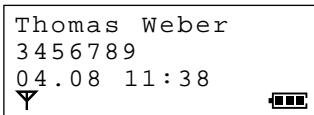

Ex. The caller's name and number are stored in the phonebook.



2 To search from the most recent call, press . To search from the oldest call, press .

- To scroll between callers, press  or .

3 To exit the list, press .

- The handset will return to the standby mode.

- If "No Stored Memory" is displayed in step 1, the Caller List is empty. The display will return to the standby mode.
- If more than one call is received from the same caller, only the information of the most recent call will be recorded.

What "✓" means:

When you have checked new calls, answered the call or called back the caller, "✓" will be added to the caller information.

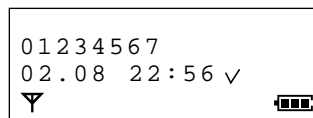

- When the same caller calls again, the call entry with "✓" will be deleted and replaced with the new call entry.

When viewing long telephone numbers:

If an arrow (→) is displayed after the number, the whole telephone number has not been shown. Press  to see the remaining numbers.

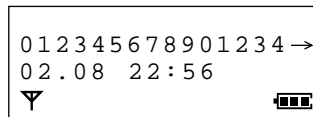



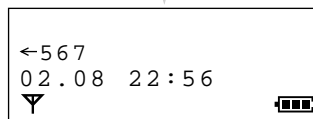

Press 



➔ Using the Caller List

Calling Back from the Caller List











Make sure that the power is ON (p. 13) and the unit is in the standby mode.

- 1 Press  or  until the desired caller number is displayed.
- 2 Press  or .
 - The displayed phone number is dialled automatically.
- 3 To hang up, press .
 - The handset will return to the standby mode.
 - In some cases, you may have to edit the number before dialling (see below).
 - If a phone number is not displayed in the caller information, you cannot call back that caller.

Editing the Caller's Phone Number

You can edit a phone number in the Caller List. After editing the number, you can continue with calling back or phonebook storing procedures.

Make sure that the power is ON (p. 13) and the unit is in the standby mode.

- 1 Press  or  until the desired caller number is displayed, then press .
- 2 Press  or  until the arrow points to "Edit For Call", then press .
- 3 Add a number to the current number.
 - Pressing  erases the digit to the left of the cursor. To erase all digits, press and hold .
- 4 To call back, press  or .

OR

To store the number in the phonebook, press . Then follow the instructions on the display (see pages 23, 32).

 - The number edited in step 3 will not be stored in the Caller List.



Storing the Caller List Information in the Phonebook

You can store phone numbers that are in the Caller List into the phonebook. You can also assign the caller information to one of 9 categories to use the private category feature (p. 36).

Make sure that the power is ON (p. 13) and the unit is in the standby mode.

1 Press or until the desired caller number is displayed, then press .

2 While "Save Phonebook" is at the arrow, press .

- The display shows the number of remaining phonebook items then "<Enter name>".

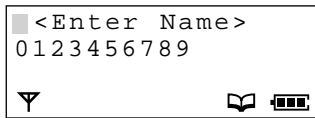

3 Enter the name, up to 16 characters (p. 32).

4 Press .

- If the number requires editing, see step 3 of "Editing the Caller's Phone Number" on page 28. Press to confirm.

5 Press or to select Private category number (1-9) or OFF.

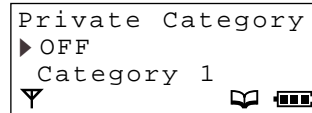

6 Press .

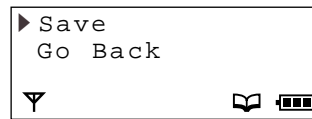

7 While "Save" is at the arrow, press .

- A beep sounds.

8 Press to return to the standby mode.

- If the display shows "Memory full" in step 2, the handset will return to the standby mode. To clear other stored items from the phonebook, see page 38.





➔ Using the Caller List

Clearing the Caller List





You can clear some or all entries in the Caller List.

Make sure that the power is ON (p. 13) and the unit is in the standby mode.

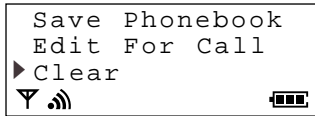



To clear a specific entry from the Caller List

- 1 Press  or  until the caller information you want to clear is displayed, then press .
- 2 Press  or  until the arrow points to "Clear".





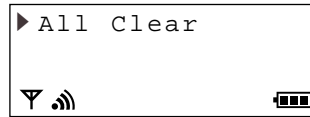

- 3 Press .
 - "Clear ?" is displayed.
- 4 Press  or  to select "YES", then press .
 - A beep sounds and "CLEARED" is displayed.
 - After a few seconds, the display will show the next caller information. To return to the standby mode, press .

To clear all entries in the Caller List

- 1 Press  or  until the caller information you want to clear is displayed, then press .
- 2 Press  or  until the arrow points to "All Clear".



- 3 Press .
 - "All Clear ?" is displayed.
- 4 Press  or  to select "YES", then press .
 - A beep sounds and "CLEARED" is displayed.
 - After a few seconds, the display will show "No Stored Memory" and the handset will return to the standby mode.

Using the Phonebook

After subscribing to a Caller ID service, you can store up to 200 names and phone numbers in the phonebook. All phonebook items are sorted by the first word in alphabetical order. Using the phonebook, you can make a call by selecting a name on the display.

You can also assign the caller's information to one of 9 private categories (1-9) to use the private category feature (p. 36).

Private category feature:

After subscribing to a Caller ID service, you can select the display backlight color and ringer type for each private category. When receiving a call, you can easily figure out who has called (For example, Category 1 for family, Category 2 for friends and Category 9 for business).

When a call is received from the caller belonging to one of the private categories, the handset will ring with the selected ringer type and the display will light in the selected color for each private category. If you do not assign an item to any private category number, the handset will ring in the preset ringer type and light in the preset color (p. 54) when receiving a call.

Entry example:

Phonebook items		Backlight color (3 colors)	Ringer type (1-20)
Phone numbers and names (up to 200)	Private category no. (1-9)		
	1: Family	Red	1
	2: Friends	Orange	2
	3: Neighbors	Green	3
	⋮	⋮	⋮
	9: Business	Red	20
	OFF	Pre-selected color	Pre-selected type

Example;

When receiving a call from a caller belonging to Category 1;

- the handset rings in the ringer type 1.
- the display backlight lights in red.

➔ Using the Phonebook

Storing Names and Numbers in the Phonebook

After caller information is categorized in the phonebook, you can select the backlight color and ringer type for each private category (p. 36).

Make sure that the power is ON (p. 13) and the unit is in the standby mode.



1 Press .

2 Press  or  until the arrow points to "New Phonebook", then press .

- The display shows the number of remaining phonebook items then "<Enter Name>".

```
Enter
New Phonebook
200—Memory Avail
📶 📖 🔋
```

```
█ <Enter Name>
📶 📖 🔋
```



3 Enter a name, up to 16 characters with the dialling buttons,  or  or .

- See steps for entering names and symbols (p. 33).

4 Press .



```
Colin Smith
<Enter Phone No>
📶 📖 🔋
```

5 Enter a phone number up to 24 digits.

- If you misdial, press . Digits are erased from the right. To erase all digits, press and hold .

6 Press .

```
Private Category
▶ OFF
Category 1
📶 📖 🔋
```

7 Press  or  to select Private category number (1-9) or OFF, then press .

8 While "Save" is at the arrow, press .

- A beep sounds and "Saved" is displayed.
- The display will return to "<Enter Name>". You can continue storing other items.
- To return to the standby mode, press .
- If the display shows "Memory Full" in step 2, the display will return to the standby mode. Clear other stored items in the phonebook (p. 38).



To enter names selecting characters

The dialling buttons can be used to enter letters and character symbols. The letters are printed on the dialling buttons. Pressing each button selects a character as shown on page 34, 35.

To change the character mode

You can select one of 6 character modes by pressing during entering a name. The factory preset is "ABC".

- 1 Press while entering a name.
 - 2 Press or until the arrow points to the desired character mode, then press .
- The character mode is displayed.

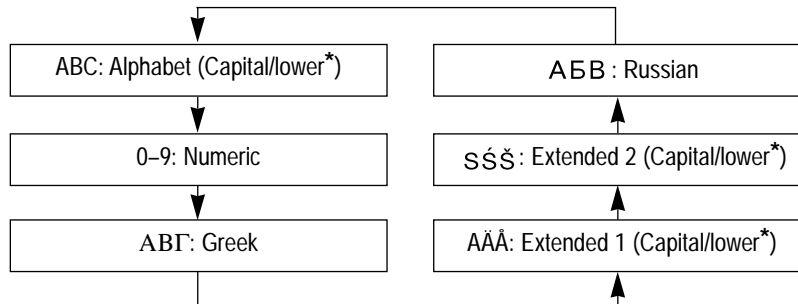
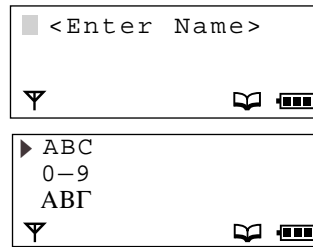

*To change from capital to lower case, press . Each time you press , the mode will change.

For example, to enter "Anne":

1. Press .
2. Press , then TWICE.
3. Press , then TWICE.
4. Press TWICE.

If you make a mistake while entering a name

Press or to move the cursor to the incorrect character, press to delete, and enter the correct character. Pressing erases the character to the left of the cursor. To erase all characters, press and hold .

➔ Using the Phonebook

Character mode table

Buttons	ABC (Alphabet)	0-9 (Numeric)	ΑΒΓ (Greek)	ΑĂĂ (Extended 1)
1	# & ' () * , - . /	1	# & ' () * , - . /	# & ' () * , - . /
	# & ' () * , - . /	1	# & ' () * , - . /	# & ' () * , - . /
2	A B C	2	ΑΒΓ	ΑĂĂĂĂĂĂĂÆΒCÇ
	a b c	2	ΑΒΓ	a à á â ã ä å æ b c ç
3	D E F	3	ΔΕΖ	D E È É Ê Ë Ì Í Î Ï
	d e f	3	ΔΕΖ	d e è é ê ë ì í î ï
4	G H I	4	ΗΘΙ	GĞHIİİİİİİİ
	g h i	4	ΗΘΙ	gğhiiiii
5	J K L	5	ΚΛΜ	J K L
	j k l	5	ΚΛΜ	j k l
6	M N O	6	ΝΕΟ	M N Ñ O Ò Ó Ô Õ Ö Ø
	m n o	6	ΝΕΟ	m n ñ o ò ó ô õ ö ø
7	P Q R S	7	ΠΡΣ	P Q R S Ş ß
	p q r s	7	ΠΡΣ	p q r s ş ß
8	T U V	8	ΤΥΦ	T U Û Ú Û Ü Û Ü V
	t u v	8	ΤΥΦ	t u ù ú û ü ù ü v
9	W X Y Z	9	ΧΨΩ Ϻ	W X Y Z
	w x y z	9	ΧΨΩ Ϻ	w x y z
0	blank	0	blank	blank
	blank	0	blank	blank
◀	To move the cursor █ to the left.			
▶	To move the cursor █ to the right. (To enter another character using the same dialling button, move the cursor to the next space.)			
C	To erase characters.			
*	To shift from capital to lower case, press (*). Each time you press (*), the mode will change.			



Character mode table

Buttons	S Š Š (Extended 2)	АБВ (Russian)
1	# & ' () * , - . /	# & ' () * , - . /
	# & ' () * , - . /	# & ' () * , - . /
2	A Á Ä Å B C Č Ć	А Б В Г
	a á ä å b c č ć	А Б В Г
3	D Ď E É Ě Ě F	Д Е Ж З
	d ě e é ě ě f	Д Е Ж З
4	G H I Í	И Й К Л
	g h i í	И Й К Л
5	J K L Ł Ł Ł	М Н О П
	j k l ł ł ł	М Н О П
6	M N Ń Ń O Ó Ö Ö	Р С Т У
	m n ń ń o ó ö ö	Р С Т У
7	P Q R Ř Ř S Ś Š	Ф Х Ц Ч
	p q r ř ř s ś š	Ф Х Ц Ч
8	T Ť Ú Ü Ů V	Ш Щ Ъ Ы
	t ť ú ü ů v	Ш Щ Ъ Ы
9	W X Y Ý Z Ž Ž Ž	Ь Э Ю Я
	w x y ý z ž ž ž	Ь Э Ю Я
0	blank	blank
	blank	blank

The following small letters of Greek, Russian (Cyrillic), Polish, Czech and Slovakian are not available. Then same letter as Capital will be displayed.

ą ć ċ đ ě ħ ł ĩ ŋ ŋ ř ś ś š ť ž ž ž

➔ Using the Phonebook

















Using the Private Category Feature

After subscribing to a Caller ID service, you can select the display backlight color and ringer type for each private category. When receiving a call, you can easily figure out who has called by setting backlight color and ringer type of each private category.



Make sure that the power is ON (p. 13) and the unit is in the standby mode.

Setting the backlight color of the private category

You can select the display backlight color (red, orange or green) for each category. The factory preset is green.

















- 1 Press .
- 2 Press  or  until the arrow points to "Setting Handset", then press .
- 3 Press  or  until the arrow points to "Display Option", then press .
- 4 Press  or  until the arrow points to "Private Color", then press .
- 5 Press  or  to select the desired category, then press .
 - The current display backlight color lights.
- 6 Press  or  to select the backlight color.
 - Each time you press  or , the display backlight color will change.
 - Ex. Red is selected for the category 1.





- 7 Press .
 - A beep sounds.
 - To return to the standby mode, press .

Setting the ringer type of the private category

You can select the handset ringer type (20 types) for each category. The factory preset is 1.

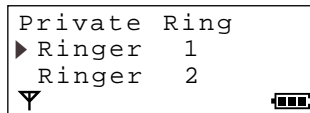
- 1 Press .
- 2 Press  or  until the arrow points to "Setting Handset", then press .
- 3 Press  or  until the arrow points to "Ringer Option", then press .
- 4 Press  or  until the arrow points to "Private Ring", then press .
- 5 Press  or  to select the desired category, then press .
 - The current ringer type rings.
- 6 Press  or  to select the ringer type.
 - Each time you press  or , the ringer type will change.
 - Ex. Ringer 1 is selected for the category 1.



- 7 Press .
 - A beep sounds.
 - To return to the standby mode, press .
- 20 ringer types are available for following ringer types, Private category ringer, External ringer, Internal ringer, Paging and Time alarm (p. 52).



Finding Items in the Phonebook

Make sure that the power is ON (p. 13) and the unit is in the standby mode.

1 Press to enter the phonebook.

- The first item is displayed.

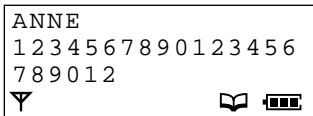

2 Press or until the desired name is displayed.

- All phonebook items are sorted in the following order.

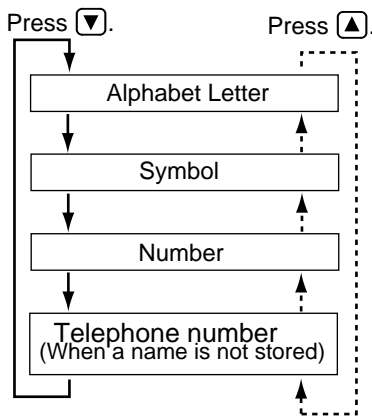

To search for a name by initial

1 Press to enter the phonebook.

- The first item is displayed.

2 Press the dialling button for the first letter of the desired name until any name with the same initial is displayed.

- The letters are printed on the dialling buttons.

Ex. To find "Felix", press repeatedly until the first item under "F" is displayed.

3 Press until the desired name is displayed.

- If "No Stored Memory" is displayed in step 1, the phonebook is empty. The handset will return to the standby mode.

Dialling from the Phonebook

Make sure that the power is ON (p. 13) and the unit is in the standby mode.

1 Press to enter the phonebook.

- The first item is displayed.

2 Press or until the desired name is displayed.

- You can also search for the item by initial.
- To exit the phonebook, press .

3 Press or .





- The number is dialled automatically.

4 To hang up, press or place the handset on the base unit.





➔ Using the Phonebook



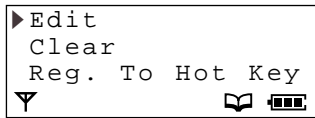







Editing an Item in the Phonebook

Make sure that the power is ON (p. 13) and the unit is in the standby mode.

- 1 Press  to enter the phonebook.
 - The first item is displayed.
- 2 Press  or  until the desired name is displayed, then press .
 - You can also search for the item by initial (p. 37).













- 3 While "Edit" is at the arrow, press .
 - If you do not need to change the name, go to step 5.
- 4 Edit the name using the dialling buttons, ,  or  up to 16 characters.
- 5 Press .
 - If you do not need to change the number, go to step 7.

- 6 Edit the number using the dialling buttons ,  or .
 - Pressing  erases the digit to the left of the cursor. To erase all digits, press and hold .
- 7 Press .
- 8 Press  or  to select the desired category number (1-9) or OFF, then press .
- 9 While "Save" is at the arrow, press .
 - A beep sounds and "Saved" is displayed.
 - To return to the standby mode, press .

Clearing an Item from the Phonebook

Make sure that the power is ON (p. 13) and the unit is in the standby mode.

- 1 Press  to enter the phonebook.
 - The first item is displayed.
- 2 Press  or  until the desired item is displayed.
 - You can also search for the item by initial (p. 37).
- 3 Press .
- 4 Press  or  until the arrow points to "Clear", then press .
 - "Clear ?" is displayed.
- 5 Press  or  to select "YES", and press .
 - A beep sounds and "CLEARED" is displayed.
 - After a few seconds, the display will show the next item.
 - To return to the standby mode, press .



Hot Key Dial

The dialling buttons (1-9) function as one-touch dials. You can assign up to 9 phone numbers from the phonebook items into dialling buttons as hot key dials.

Make sure that the power is ON (p. 13) and the unit is in the standby mode.

Storing phonebook items as hot key dials

- 1 Press to enter the phonebook.
 - The first item is displayed.
- 2 Press or until the desired item is displayed, and press .
- 3 Press or until "Reg. To Hot Key" is displayed, and press .

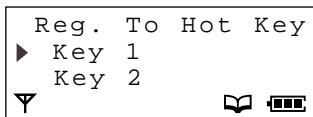

- If already stored an item, "✓" will be displayed on the left of the hot key number.
- 4 Press or to select a hot key number, then press .
 - 5 Press or until "Save" is displayed.
OR
If the hot key number with "✓" is selected, press or until "Overwrite" is displayed.
 - 6 Press .
 - A beep sounds and "Saved" is displayed. The display will return to the phonebook. You can continue storing other items.
 - To return to the standby mode, press .

Dialling a stored number

- 1 Press and hold a hot key number (1-9).

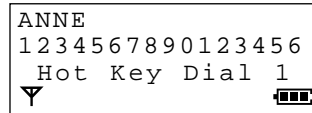

- 2 Press or .
 - The number is dialled automatically.
- 3 To hang up, press .

Clearing an item in the hot key dial

- 1 Press and hold a hot key number (1-9).
 - The stored number is displayed.
- 2 Press or until the desired item is displayed, then press .
- 3 Press or until the arrow points to "Clear", then press .
 - "Clear ?" is displayed.
- 4 While "YES" is at the arrow, press .
 - A beep sounds and "CLEARED" is displayed.

➔ Using the Phonebook





Phonebook Copy

You can copy the information in the phonebook between the handsets registered in the same base unit. The phonebook copy must be operated in intercom mode (see page 41).











Ex. Handset 2 is copying the phonebook to Handset 1 during an intercom call.

To copy the specified item in the phonebook

Handset 1 (Receiver):





- 1 During an intercom call, press .
- 2 Press  or  until the arrow points to "Recv Phonebook", then press .
 - "Copy Proceeding" is on the display.

Handset 2 (Sender):



- 1 Press .
- 2 Press  or  until the arrow points to "Send Phonebook", then press .
 - The phonebook is displayed.
- 3 Press  or  until the desired name is displayed, then press .
- 4 Press  or  until the arrow points to "Copy Entry", then press .
 - "Copy Proceeding" is on the display and the selected information is copied.
 - After copying is completed, a beep sounds and "Copy Complete" is displayed.
 - After a few seconds, the display will return to the intercom call.

To copy all the items in the phonebook

Handset 1 (Receiver):

- 1 During an intercom call, press .
- 2 Press  or  until the arrow points to "Recv Phonebook", then press .
 - "Copy Proceeding" is on the display.

Handset 2 (Sender):







- 1 Follow steps 1 to 3 for Handset 2 of the left column.
 - 2 Press  or  until the arrow points to "Copy Forward", then press .
 - "Copy Proceeding" is on the display and all forwarded information in the phonebook is copied.
 - After copying is completed, a beep sounds and "Copy Complete" is displayed.
 - After a few seconds, the display will return to intercom call.
- If "Copy Incomplete" is displayed, the receiver handset memory is full before copying is completed.
 - If "Copy Failure" is displayed, the receiver and/or sender did not prepare for copying within 60 seconds.

Intercom









A 2-way intercom is available between the handset and the base unit.

Paging the base unit from the handset



- 1 **Handset:**
Press **INT** , then **0**.
 - "  " is displayed and the base unit rings.
 - To stop paging, press  again.
- 2 **Base unit:**
Press  or  to answer.
- 3 **Base unit:**
Talk into the MIC.
- 4 **Handset or Base unit:**
To end the intercom, press  on the handset,
OR
 or  on the base unit.

Paging the handset from the base unit (Handset locator)

Using this feature, you can locate the handset if misplaced.

- 1 **Base unit:**
Press .
 - The handset rings for 1 minute and "  " flashes.
 - To stop paging, press  again.
- 2 **Handset:**
Press  to answer.
- 3 **Base unit:**
Talk into the MIC.
- 4 **Handset or Base unit:**
To end the intercom, press  on the handset,
OR
 on the base unit.

During the intercom:

- If two tones sound, an incoming call has been received. To answer, press ,  or . The intercom is ended.

➔ Intercom

Transferring a Call Using the Intercom

The intercom can be used during a call. This feature enables you to transfer a call between the handset and the base unit.

From the handset to the base unit

1 Handset:
During a call, press **INT** then **0**.

- The call is put on hold and "📶" is displayed.
- If the base unit user does not answer, press **INT**.

2 Base unit:
Press **📞** or **📞** to answer the page.

3 Transferring a call:

Handset:
Press **📞**.

- The transfer is completed.
The base unit user can answer the call.

OR

Ending the intercom:

Handset:
press **INT**.

- The handset returns to the call.

From the base unit to the handset

1 Base unit:
During a call, press **📞**.

- The call is put on hold.
- If the handset user does not answer, press **📞**.

2 Handset:
Press **📞** to answer the page.

3 Transferring a call:

Base unit:
Press **📞**.

- The transfer is completed. The handset user can answer the call.

OR

Ending the intercom:

Base unit:
press **📞**.

- The base unit returns to the call.



Special Features

How to Use the Pause Feature (For Analog PBX Line/Long Distance Service Users)

We recommend you press  if a pause is required for dialling with a PBX or to access a long distance service.

Ex. Line access number  (PBX)









- Selecting pressing  creates a pause. This prevents misdialling when you redial or dial a stored number.
- Selecting pressing  more than once increases the length of the pause between numbers.





Setting the pause timing

You can set the pause timing to 3 seconds or 5 seconds, depending on your PBX requirements. The factory preset is 3 seconds.

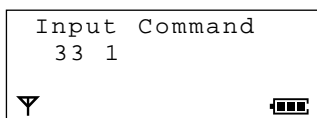
Make sure that the power is ON (p. 13) and the unit is in the standby mode.

- 1 Press .
- 2 Press  or  until the arrow points to "Setting Base", then press .
 - "Input Command" is displayed.
- 3 Press .
- 4 Enter the 4-digit base unit PIN (p. 55).
 - The factory preset is 0000.
- 5 Press .
 - The current timing is displayed.
1: 3 seconds 2: 5 seconds
Ex. 3 second is selected.



- 6 To select 5 seconds, press .
OR
To select 3 seconds, press .
- 7 Press .
 - A beep sounds.
 - To return to the standby mode, press .

- If 5 beeps sound in step 4, the entered PIN is incorrect. Enter the correct PIN.

➔ Special Features

Setting the Key Lock

You can lock the handset dialling buttons. Only incoming calls are accepted until the key lock is cancelled.

When the unit is in the standby mode, press and hold  until a beep sounds.

- "[X]" is displayed and all dialling buttons are locked.

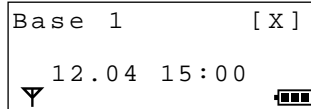

To cancel the key lock

When the unit is in the standby mode, press and hold  for about 2 seconds.

- "[X]" will disappear and the key lock will be cancelled.
- The key lock will also be cancelled when the power is turned OFF (p. 13).

Using the Recall Feature



 is used to access special telephone services (optional) such as call waiting. Contact your telephone company for details.

Example: British Telecom call waiting



When a call waiting tone is heard during a conversation:

a) To hold the existing call and accept the waiting call

Press .

- Each time you press , you can switch between the first and second call.
- Depending on the provider, you may need to enter a code after pressing . Follow the instructions given by your provider.

b) To accept the waiting call and hang up the existing call

Press . When the unit rings, press  to answer the new call.

c) To reject the waiting call

Wait for the call waiting to time out. This will take about 40 seconds.

If your unit is connected to a PBX, pressing  allows you to access some features of your host PBX such as transferring an extension call.

Call Waiting and Caller ID Compatible

If you subscribe to Caller ID and Call Waiting service, your handset displays a second caller's information while talking. After you hear a second caller waiting tone, the caller's phone number and "CALL WAITING" will be displayed.





You can answer the second call, keeping the first call on hold.

- If the phone number is stored in the directory, the caller's name will be displayed (p. 32).
- Please consult your telephone company for details and available in your area.



Selecting the earth (option)/time break recall mode

The earth relay can be installed as an option depending on your PBX requirements. Please consult your nearest Panasonic Customer Care Helpline for installation. Then you can select the time break recall or earth mode. The factory preset is time break recall.



Make sure that the power is ON (p. 13) and the unit is in the standby mode.

- 1 Press .
- 2 Press  or  until the arrow points to "Setting Base", then press .
 - "Input Command" is displayed.
- 3 Press **3**.
- 4 Enter the 4-digit base unit PIN (p. 55).
 - The factory preset is 0000.
- 5 Press **2**.
 - The current mode is displayed.
1: Time break recall 2: Earth
Ex. Time break recall is selected.

```

Input Command
3 2 1
 

```

- 6 To select "Earth", press **2**.
OR
To select "Time break recall", press **1** then **2**.
 - 7 Press .
 - A beep sounds.
 - To return to the standby mode, press .
- If 5 beeps sound in step 4, the entered PIN is incorrect. Enter the correct PIN.

Direct Call

You can easily make a call using a stored direct call number by pressing or . Incoming calls are accepted. To use this feature, store the direct call number and turn on the mode by programming. The factory preset is OFF.

Setting the Direct Call Number and Mode

After storing the direct call number, the unit will automatically switch to the direct call mode. When the direct call mode is on, you can ONLY dial the number stored in the direct call memory.

Make sure that the power is ON (p. 13) and the unit is in the standby mode.

- 1 Press .
- 2 Press or until the arrow points to "Setting Handset", then press .
- 3 Press or until the arrow points to "Call Option", then press .
- 4 Press or until the arrow points to "Direct Call No.", then press .
 - "<Enter Phone No>" is displayed.
- 5 Enter the phone number up to 24 digits.
 - If you misdial, press . The digits are erased from the right. To erase all digits, press and hold .
- 6 Press .
- 7 While the arrow is at "Save", press .
- 8 While the arrow is at "ON", press .
 - A beep sounds.

- 9 Press to return to the standby mode.
 - The handset is now in the direct call mode.

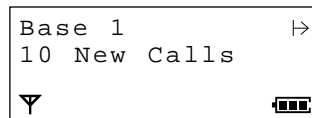

To turn OFF/ON the direct call mode

- Follow steps 1 to 3. In step 4, press or until the arrow points to "Direct ON/OFF", press . Press or to select OFF or ON and press . When finished, press .
- When set to off, "↳" will go out.

Dialling the Stored Number









Make sure that "↳" is displayed, then press or .

- The number stored in the direct call memory is dialled automatically.



Call Prohibition

You can prohibit anyone from making a call with your handset except for emergency calls. Incoming calls are accepted. To use this feature, turn on the call prohibition mode by programming. The factory preset is OFF.

Make sure that the power is ON (p. 13) and the unit is in the standby mode.

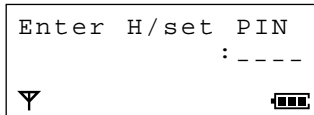
- 1 Press .
- 2 Press  or  until the arrow points to "Setting Handset", then press .
- 3 Press  or  until the arrow points to "Call Option", then press .
- 4 While "Call Bar" is at the arrow, press .



- 5 Enter the 4-digit handset PIN (p. 55).
 - The current mode is displayed.
- 6 Press  or  to select "ON".

- 7 Press .

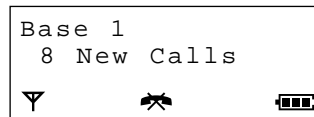

- A beep sounds and " " is displayed.

- 8 Press  to return to the standby mode.



- The call prohibition mode is now in effect.

To turn OFF the call prohibition mode

Press  or  to select "OFF" in step 6.





- After returning to the standby mode, " " will go out.

If you forget your handset PIN, please consult your nearest Panasonic Service Center.

Call Restriction

You can restrict desired handset(s)/base unit from dialling selected phone numbers. Phone numbers beginning with the restricted digits cannot be dialled out. For example, if "00" is assigned as the call restriction number, international calls cannot be made.

For selected handset(s)/base unit, you can assign up to 6 call restriction numbers (up to 8 digits). Set the call restricted handset(s)/base unit and the restriction number(s) by programming. The factory preset is OFF.

- 1 Press .
- 2 Press  or  until the arrow points to "Setting Base", then press .
 - "Input Command" is displayed.

- 3 Press .

- 4 Enter the 4-digit base unit PIN (p. 55).
 - The current registered handset number(s)/base unit is/are displayed.
 - The base unit number is displayed as "0".

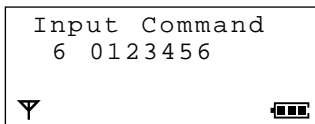

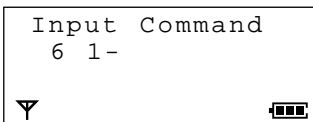

- 5 Enter the handset number(s)/base unit which you want to restrict.
 - The selected handset number(s)/base unit flash(es).
 - If you misdial, press the number(s) again.

- 6 Press .
 - "1" is displayed.





- 7 Enter a call restriction number, up to 8 digits.

- If you misdial, press . The digits are erased from the right. To erase all digits, press and hold .

- 8 Press .

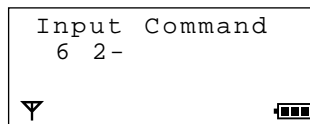
- A beep sounds.
- "2" is displayed. To continue entering a number, enter the next number, then press .



- 9 Press .

- To return to the standby mode, press .

When you dial a restricted number, the call is disconnected and the dialled number flashes.

Ex. The restricted number is "00".



To cancel the call restricted handset(s)

- 1 Follow steps 1 to 2 on page 48.
- 2 Press **6**.
- 3 Enter the 4-digit base unit PIN (p. 55).
- 4 Enter the handset number(s) you want to cancel.
 - The cancelled handset number(s) stop(s) flashing.
- 5 Press **≡** repeatedly until "Setting Base" is displayed.
 - To return to the standby mode, press ***0**.

To cancel the call restriction number(s)

Follow steps 1 to 6 on page 48. In step 7, press **▶** until the call restriction number you want to cancel is displayed. Then erase the number by pressing **C**.

- The call restriction number is cleared.











When finished, press **≡** repeatedly until "Setting Base" is displayed.

To return to the standby mode, press ***0**.

Setting the Time Alarm

The handset will sound an alarm at a preset time for 30 seconds just for once or repeated daily. You can also select the ringer type for time alarm (p. 52). If you select the melody for time alarm, the handset will sound longer (It depends on the ringer type). You must set the date and time before setting the alarm time.

Make sure that the power is ON (p. 13) and the unit is in the standby mode.

- 1 Press .
- 2 Press  or  until the arrow points to "Setting Handset", then press .
- 3 Press  or  until the arrow points to "Time Alarm", then press .
- 4 Press  or  until the arrow points to "Set Alarm Time", then press .



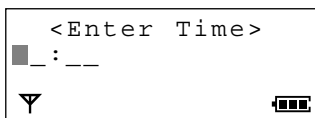

- The current setting is displayed on the 2nd line.



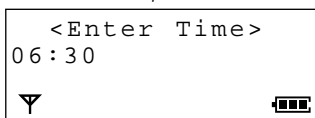





- 5 Enter the desired time (hour and minute) using a 4-digit number (24-hour time), then press .

Ex: To set 06:30, enter "0630".









- 6 While "Save" is at the arrow, press .
- 7 Press  or  to select "Once" or "Repeat Daily".
- 8 Press .
 - A beep sounds.
 - To return to the standby mode, press .

To turn off the time alarm

- 1 Follow the steps 1 to 3.
- 2 Press  or  until the arrow points to "Alarm ON/OFF", then press .
- 3 Press  or  to select OFF, then press .
 - A beep sounds.
 - To return to the standby mode, press .

To stop the time alarm

When the alarm sounds and "Time Alarm" is shown on the flashing backlit display, press any dialing button  to , , , ,  or .











- If "Once" is selected, the setting is automatically turned off. If "Repeat Daily" is selected, the setting remains and the alarm will repeatedly sound at the setting time.
- If the unit is in the talk, speakerphone or intercom mode during the alarm time, the alarm will not sound. After finishing a conversation, the alarm will start ringing.





Other Programmable Settings

Selecting the Talk Mode Display

You can choose whether to display the length of the call or the dialled telephone number while in the talk mode. The factory preset is the length of the call.

Make sure that the power is ON (p. 13) and the unit is in the standby mode.

- 1 Press .
- 2 Press  or  until the arrow points to "Setting Handset", then press .
- 3 Press  or  until the arrow points to "Display Option", then press .
- 4 Press  or  until the arrow points to "Talk Display", then press .
 - The current setting is at the arrow.
 - Talk Time: Length of the call
 - Phone No.: Dialled phone number

Talk Display
 Talk Time
 Phone No.
- 5 Press  or  to select "Talk Time" or "Phone No.".
- 6 Press .
 - A beep sounds.
 - To return to the standby mode, press .

During a conversation, the display will be as follows.

"Talk Time" is selected.
 (Ex: 1 hour, 30 minutes, 40 seconds.)

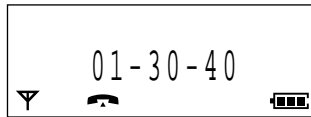

"Phone No." is selected.
 (Ex: 123-456-7890)

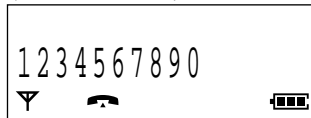















➡ Other Programmable Settings

Setting the Handset Ringer Type

You can program the desired handset ringer type for external/internal calls and paging, time alarm.















External ringer type (p. 25)

You can select the external ringer type. 20 ringer types are available. The factory preset is type 1.

Press  ➡  or  to select "Setting Handset" then  ➡  or  to select "Ringer Option" then  ➡  or  to select "Ext Ring Type" then  ➡
➡ Press  or  to select the desired type* ➡  ➡ 

Internal ringer type (for individual paging) (p. 41, 65)















You can select the internal ringer type. 20 ringer types are available. The factory preset is type 1.

Press  ➡  or  to select "Setting Handset" then  ➡  or  to select "Ringer Option" then  ➡  or  to select "Int Ring Type" then  ➡
➡ Press  or  to select the desired type* ➡  ➡ 

Paging ringer type (p. 41, 65)















You can select the paging ringer type for paging from a handset/base unit.

20 ringer types are available. The factory preset is type 1.

Press  ➡  or  to select "Setting Handset" then  ➡  or  to select "Ringer Option" then  ➡  or  to select "Paging Type" then  ➡
➡ Press  or  to select the desired type* ➡  ➡ 

Time alarm type (p. 50)

You can select the time alarm ringer type. 20 ringer types are available. The factory preset is type 1.

Press  ➡  or  to select "Setting Handset" then  ➡  or  to select "Ringer Option" then  ➡  or  to select "Alarm Type" then  ➡
➡ Press  or  to select the desired type* ➡  ➡ 

* Each time you press a button, the selected ringer type will sound.

- 20 ringer types are available for following ringer types, Private category Ringer (p. 36), External ringer, Internal Ringer, Paging and Time alarm.



Setting the Call Waiting Tone

If an incoming call has been received during an intercom between handsets, a call waiting tone sounds. You can choose whether or not the tone sounds. The factory preset is ON.

Press ➔ or to select "Setting Handset" then ➔ or to select "Tone Option" then ➔ or to select "Call Waiting" then ➔ or to select ON or OFF ➔ ➔

Setting the Range Warning Alarm

You can choose whether or not the handset will sound a range warning alarm. The factory preset is OFF.

Press ➔ or to select "Setting Handset" then ➔ or to select "Tone Option" then ➔ or to select "Range Alarm" then ➔ or to select ON or OFF ➔ ➔

Setting the Battery Low Alarm

You can choose whether or not the handset will sound a battery low alarm. The factory preset is ON.

Press ➔ or to select "Setting Handset" then ➔ or to select "Tone Option" then ➔ or to select "Battery Alarm" then ➔ or to select ON or OFF ➔ ➔

➡ Other Programmable Settings

Selecting the Base Unit Ringer Type













You can program the desired base unit ringer type (6 types). The factory preset is type 1.

Press  ➡  or  to select "Setting Base" then  ➡ **2** ➡ **3** ➡
➡ **Ringer type (1-6)** ➡  ➡ 



Setting the Key Tones

You can choose whether or not the handset keys will sound tones (key tone, confirmation tone, error tone). The factory preset is ON.

On the handset

Press  ➡  or  to select "Setting Handset" then  ➡  or  to select "Tone Option" then  ➡  while "Key Tone ON/OFF" is at the arrow ➡
➡  or  to select ON or OFF ➡  ➡ 















On the base unit

Press  ➡  or  to select "Setting Base" then  ➡ **2** then **1** ➡
➡ **0** (OFF) or **1** (ON) ➡  ➡ 

- If ON is selected, a beep sounds.

Selecting the Display Backlight Color

You can set the display backlight color to green, orange, or red. The display backlight will light in the selected color when pressing a button, lifting the handset from the base unit or receiving a call. The factory preset is green.

Press  ➡  or  to select "Setting Handset" then  ➡  or  to select "Display Option" then  ➡  or  to select "Backlight Color" then  ➡
➡  or  to select green, orange or red ➡  ➡ 

- You can select the display backlight color for identifying callers by setting the private category feature (p. 36).











Setting the PIN

You can program a 4-digit handset/base unit PIN (Personal Identification Number). The factory preset is 0000. Changing the PIN may prevent the unauthorised use of your unit by another person.

Make sure that the power is ON (p. 13) and the unit is in the standby mode.

Once you have programmed the PIN, you cannot confirm it. We recommend you write down the PIN. If you do forget it, please consult the Panasonic Customer Care Helpline.

On the handset

- 1 Press .
- 2 Press  or  until the arrow points to "Setting Handset", then press .
- 3 Press  or  until the arrow points to "Other Option", then press .
- 4 Press  or  until the arrow points to "Change Hset PIN", then press .

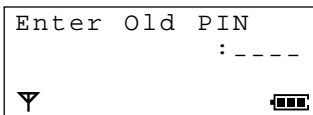



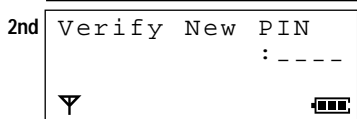
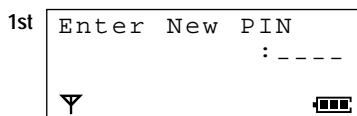

- 5 Enter the current 4-digit handset PIN.
 - The factory preset is 0000.
- 6 Enter the new 4-digit PIN TWICE.
 - If you misdial, press . Digits are erased from the right. To erase all digits, press and



- A beep sounds.
 - To return to the standby mode, press .
- If 5 beeps sound in step 5, the entered PIN is incorrect. Enter the correct PIN.

On the base unit

- 1 Press .
- 2 Press  or  until the arrow points to "Setting Base", then press .
 - "Input Command" is displayed.
- 3 Press .

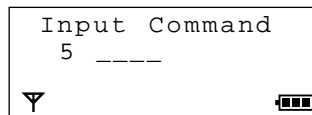

- 4 Enter the current 4-digit base unit PIN.
 - The factory preset is 0000.

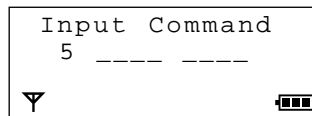

- 5 Enter the new 4-digit PIN TWICE.
 - A beep sounds.
 - The display will return to "Setting Base". To return to the standby mode, press .
- If 5 beeps sound in step 4, the entered PIN is incorrect. Enter the correct PIN.

Clearing the Settings in Memory



On the handset

This function enables the handset to clear the following settings at one time. They will return to their initial settings.

Function	Initial setting
Time Alarm	Clear
Alarm ON/OFF	OFF
Handset ringer volume	MEDIUM
External ringer type	1
Internal ringer type	1
Paging type	1
Alarm type	1
Private ringer	1
Key tones	ON
Call waiting tone	ON
Range warning alarm	OFF
Battery low alarm	ON
Standby mode display	Base unit number

Function	Initial setting
Talk mode display	Length of the call
Display language	English
Backlight color	Green
Private color	Green
Call prohibition	OFF
Direct call number	Clear
Direct call mode	OFF
Handset PIN	0000
Auto talk	OFF
Base unit access	Automatic base unit access
Handset receiver volume	MEDIUM
Redial memory	All clear

1 Press .

2 Press  or  until the arrow points to "Setting Handset", then press .

3 Press  or  until the arrow points to "Reset Handset".

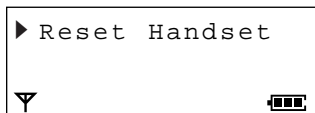

4 Press .

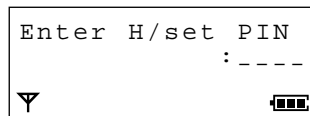

5 Enter the 4-digit handset PIN (p. 55).

- "Reset Handset" is displayed.

6 Press  or  to select "YES".

7 Press .







- A beep sounds and "CLEARED" is displayed.
- To return to the standby mode, press .

On the base unit

This function enables the base unit to clear the following settings at one time. They will return to their initial settings.

Function	Initial setting
Bell selection	All handsets
Bell interval (First ring)	3
Earth/time break recall	Time break recall
Pause timing	3 seconds
Call restricted handset(s)	All clear

Function	Initial setting
Call restriction number(s)	All clear
Base unit PIN	0000
Base unit ringer volume	2 (MEDIUM)
Base unit ringer pattern	1
Key tones	ON

- 1 Press .
- 2 Press  or  until the arrow points to "Setting Base", then press .
 - "Input Command" is displayed.
- 3 Press .
- 4 Enter the 4-digit base unit PIN (p. 55).
- 5 Press .
 - A beep sounds.

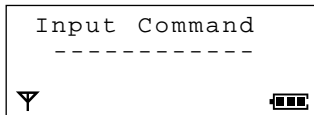

- To return to the standby mode, press .

For Optional Multi-Unit Users

Operating More than One Handset

You can register and operate up to 6 handsets at the base unit. Operating more than one handset allows you to have an internal call while simultaneously conducting an external phone call using another handset.

Ex. 6 optional handsets are added to a base unit. Handset 1 is engaged in an internal call with handset 3. Handset 2 is engaged in an external call.

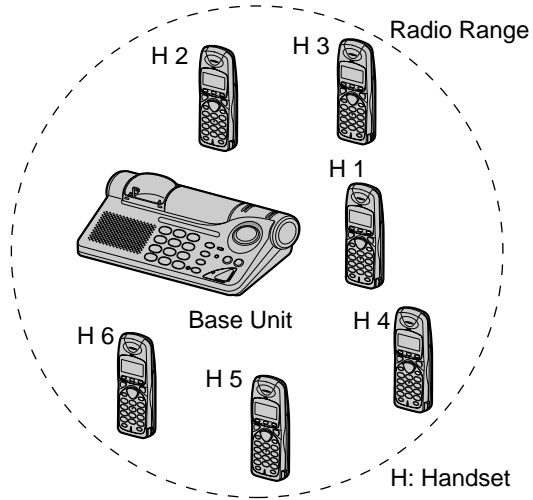

- The optional handset model number is KX-A115E. The functions of the optional handset are the same as those of the KX-TCD715EM handset.

Operating More than One Base Unit

You can register and operate your handset at up to 4 base units. Since each base unit forms a radio cell, you can extend the range or area in which you can make/answer calls with the same handset by placing the base units in suitable locations. For example, you can use a handset in different radio areas, such as at home or the office. However, calls in progress are cancelled when the unit moves to another radio area.

Ex. 3 optional KX-A115E handsets are added to 2 base units.

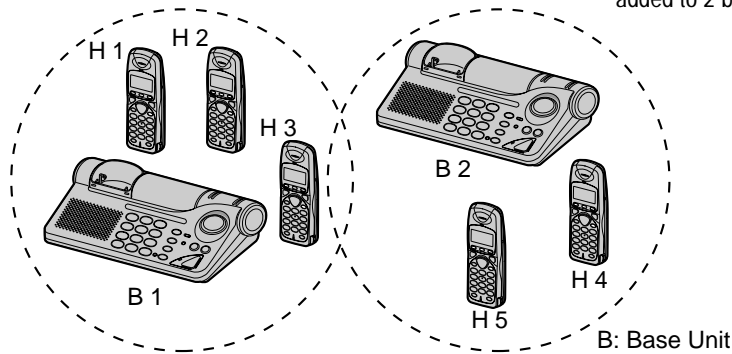







Registering Handset(s) in the Base Unit



You must register the handset in the base unit before use.



- Charge the optional handset batteries for about 15 hours before initial use.
- Make sure that the power is ON (p. 13) and the unit is in the standby mode.
- Register the handset number within 1 minute. If not registered within 1 minute, press  on the handset to cancel the programming mode. Then start again from step 1.

1 Base unit where handset is to be registered:
Press and hold  on the base unit for more than 10 seconds until the in use indicator () lights and a confirmation tone sounds.



2 Handset:
Press .

3 Press  or  until the arrow points to "Setting Handset", then press .

4 Press  or  until the arrow points to "Registration", then press .

5 Press  or  until the arrow points to "Register H/set", then press .

- The available base unit numbers are displayed.

6 Press  or  to select the desired base unit number 1 to 4, then press .

- The number is assigned as the base unit number for the handset.

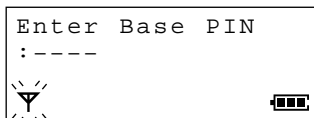
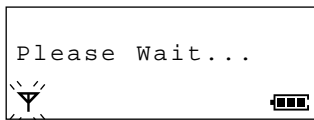



7 Enter the 4-digit base unit PIN (p. 55).

8 Press .

- "Please Wait..." is displayed, then a beep sounds.
- The handset will return to the standby mode. The current connected base unit number will be displayed.

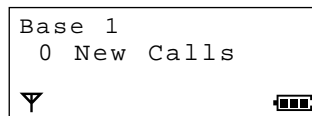
Ex. The handset is registered to the base unit 1.



- The in use indicator () on the base unit will go out.
- To register the handset in more than one base unit, repeat from step 1 with the other base unit(s).
- The base unit number which the handset is currently in contact with can be displayed in the standby mode (p. 64). Calls (both incoming and outgoing) can be conducted only via the displayed base unit (even if the radio areas overlap with neighbouring base units).

We recommend you to change the handset/base unit PIN to prevent unauthorised use of your unit by another person (p. 55).

➔ For Optional Multi-Unit Users

Selecting the Base Unit Access

Automatic base unit access (Auto)

The handset automatically selects a registered base unit.

- When the handset moves to another base unit radio area, it loses contact with the previous base unit and automatically accesses the new base unit.
- If the handset is in the overlap area between several base unit radio areas, the handset will access a base unit in the order of the base unit numbers.

Specified base unit access



You can only select one registered base unit (1 to 4) you want to operate.

- You can choose the base unit/telephone line where you can make/receive calls.

The factory preset is Auto (automatic base unit access). To select the desired base unit, program as follows.

Make sure that the power is ON (p. 13) and the unit is in the standby mode.



1 Press .

2 Press  or  until the arrow points to "Setting Handset", then press .

3 While "Select Base" is at the arrow, press .

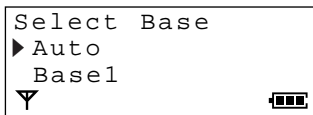
- The current setting, "Auto" or a registered base unit number is at the arrow.



4 Press  or  to select the desired base unit.

5 Press .

- A beep sounds.
- The selected base unit number will be displayed.



Cancelling a Handset

Each handset can cancel itself or another handset.

Make sure that the power is ON (p. 13) and the unit is in the standby mode.

- 1 Press
- 2 Press or until the arrow points to "Setting Base", then press .
 - "Input Command" is displayed.
- 3 Press
- 4 Enter the 4-digit base unit PIN (p. 55).
 - The current registered handset No. is/are displayed.

- 5 Enter the handset number you want to cancel.
 - The selected handset number(s) flash(es).
Ex. The handset No. 5 is selected.

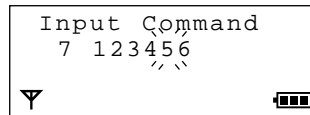

- If you misdial, press the number(s) again.
- 6 Press .
 - A beep sounds.
 - To return to the standby mode, press

Cancelling a base unit

If another handset is out of range and/or its power is OFF when "Cancelling a Handset", the previous base unit number will still remain in the cancelled handset. Therefore, you need to cancel the base unit registered in the cancelled handset.

- 1 Press
- 2 Press or until the arrow points to "Setting Handset", then press .
- 3 Press or until the arrow points to "Registration", then press .
- 4 Press or until the arrow points to "Cancel Base", then press .
 - "Enter H/set PIN" is displayed.
- 5 Enter the 4-digit handset PIN (p. 55).
 - Registered base unit(s) is(are) displayed.

- 6 Press or until the arrow points to the base unit(s) you want to cancel, then press .
 - "✓" marks the selected base unit.
- 7 Press .
 - "Clear ?" is displayed.
- 8 Press or to select "YES", then press .
 - A beep sounds and "CLEARED" is displayed.
 - To return to the standby mode, press

➔ For Optional Multi-Unit Users

Bell Selection

There are three choices for bell selection.

When a call is being received:









- all handsets ring. "All handsets"
- the selected handset(s) ring(s). "Specified handset(s)"
- the selected handset rings first, then if it does not answer, all other handsets will ring. "First handset"

The factory preset is "All handsets". To change the bell selection, program as follows.



Make sure that the power is ON (p. 13) and the unit is in the standby mode.

Selecting specified handset(s)

You can choose which handset(s) you want to ring.

- 1 Press .
- 2 Press  or  until the arrow points to "Setting Base", then press .
 - "Input Command" is displayed.
- 3 Press .
- 4 Enter the 4-digit base unit PIN (p. 55).
 - The current setting is displayed.
 - 1: All handsets
 - 2: Specified handset(s)
 - 3: First handset
- 5 Press .
 - The current registered handset number(s) is/are displayed.
- 6 Enter the handset number(s) you want to ring.
 - The selected handset number(s) flash(es).
 - If you misdial, press the number(s) again.
- 7 Press .
 - A beep sounds.
 - To return to the standby mode, press .

Input Command
 1 2-123456



Selecting first handset

One handset will ring first, then all other handsets will ring if the first handset is not answered. You can choose which handset will ring first and the ring count (1 to 6) until all of the handsets ring. The factory preset is 3 rings.

1 Follow steps 1 to 4 on page 62.

2 Press .

- The current registered handset number(s) is/are displayed.

3 Enter the handset number you want to ring.

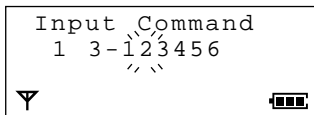

- The selected handset number flashes. Ex. Handset 2 is selected.



- If you misdial, press the number again.

4 Press .

- The handset number is stored.
- The current ring count is displayed.

5 Press a dialling button  to  to select the ring count.

6 Press .

- A beep sounds.
 - To return to the standby mode, press .
- Even if you select "Specified handset(s)" or "First handset", calls can also be received on the handsets which do not ring.

Selecting all handsets

When a call is received, all handsets will ring at the same time.

1 Follow steps 1 to 4 on page 62.

2 Press .

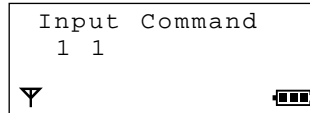

3 Press .











- A beep sounds.
- To return to the standby mode, press .

➔ For Optional Multi-Unit Users

Selecting the Standby Mode Display

You can choose whether to display the currently connected base unit number, handset number or no display while in the standby mode. The factory preset is the base unit number.

Make sure that the power is ON (p. 13) and the unit is in the standby mode.

- 1 Press .
- 2 Press  or  until the arrow points to "Setting Handset", then press .
- 3 Press  or  until the arrow points to "Display Option", then press .
- 4 While "Standby Display" is at the arrow, press .
 - The current setting is at the arrow.
- 5 Press  or  to select "Handset Number", "OFF" or "Base Number".
- 6 Press .
 - A beep sounds.

- 7 Press  to return to the standby mode.

Ex. "Handset Number" is selected.

```

INT.1
10 New Calls
  25.04 15:00
▽
    
```

Ex. "OFF" is selected.

```

10 New Calls
  25.04 15:00
▽
    
```

Ex. "Base Number" is selected.

```

Base 1
10 New Calls
  25.04 15:00
▽
    
```

Paging/Intercom







Intercom between the Handset(s) and the Base Unit

A 2-way intercom is available between one of the handsets and base unit when another handset is not having an outside call.

The base unit user can page the handset users **individually** or **at one time**.









Paging all the handsets from the base unit (All paging)

The base unit user can talk with the handset user who answered the page first.

- 1 **Base unit:**
Press  .
 - All handsets will ring for 1 minute.
 - To stop paging, press  or wait for 60 seconds.
- 2 **One of the handsets:**
Press  .
- 3 **Base unit:**
Talk into the MIC.
- 4 **The handset who answered first or Base unit:**
To end the intercom, press  on the handset.
OR
Press  or  on the base unit.

Paging a handset from the base unit (Individual paging)

The base unit user can page one of the handsets by selecting the handset number. You can confirm the handset number by performing "Selecting the Standby Mode Display" (p. 64).



- 1 **Base unit:**
Press  and enter the handset number which you want to page, then press  .
 - The handset rings for 1 minute.
 - To stop paging, press  or wait for 60 seconds.
- 2 **Handset :**
Press , **INT** or  to answer.
- 3 **Base unit:**
Talk into the MIC.
- 4 **Handset or Base unit:**
To end the intercom, press  on the handset.
OR
Press  or  on the base unit.

➔ Paging/Intercom

Transferring a Call from the Base Unit to a Handset

The intercom can be used during a call. This feature enables you to transfer a call between a handset and the base unit.

1 Base unit:

During a call, press  and enter the handset number you want to page, then press .

- The call is put on hold.
- If the handset user does not answer, press .

2 Handset:

Press  to answer the page.

3 Transferring a call:

Base unit:

Press .

- The transfer is completed. Handset can answer the call.

OR

Ending the intercom:

Base unit:

Press .

- The base unit returns to the call.

Intercom between the Handsets

A 2-way intercom is available between handsets.

Ex. Handset 1 is paging Handset 2.

1 Handset 1:

Press .

2 Handset 1:

Enter the desired handset number.

- "  " is displayed and the paged handset rings.



3 Handset 2:

When the unit rings, press  to answer.

- The intercom duration is displayed.

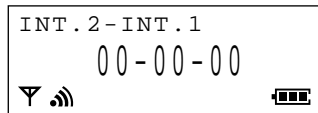

4 Handsets 1 and 2:

To end the intercom, press .

- Intercom calls can be conducted within the radio area of the current base unit, but not with units in neighbouring radio areas.



Transferring a Call from One Handset to Another

The intercom can be used during a call, enabling you to transfer a call between handsets.

Transferring a call using the intercom

Ex. Handset 1 is transferring a call to Handset 2.

1 Handset 1:

During a call, press **INT**.

Then enter the desired handset number.

- The call is put on hold.
- You will hear an internal ring back tone until the other handset is answered.
- If there is no answer, press **INT** to return to the call.

2 Handset 2:

When the unit rings, press  to answer.

3 Transferring a call:

Handset 1:

Press .

- The transfer is completed. Handset 2 can answer the call.

OR

Ending the intercom:

Handset 1:

Press **INT**.

- Handset 1 returns to the call.

Transferring a call without the intercom

This feature enables you to transfer the call to another handset without waiting for the paged handset to answer.

Ex. Handset 1 is transferring a call to Handset 2.

1 Handset 1:

During a call, press **INT** and enter the desired handset number. Then press  to transfer the call.

- The call is put on hold.

2 Handset 2:

When the unit rings, press  to answer the call.



- The transfer is completed.

- If the paged handset is not answered within 30 seconds, a ring tone sounds at the paging handset. The paging handset can return to the call by pressing .

➔ Paging/Intercom

Conference

During a call using the handset, you can make an intercom call to another handset and then combine the calls together to establish a conference call.

- 1 Handset 1:**
During a call, press **INT**. Then enter the desired handset number.
 - The call is put on hold.
 - If there is no answer, press **INT** to return to the call.
- 2 Handset 2:**
When the unit rings, press  to answer.
- 3 Handset 1:**
Press **3** to establish a conference call.
- 4 Handset 1 or 2:**
Press  to hang up the conference call.

Using a Belt Clip

You can hang the handset on your belt or pocket using the belt clip.

To attach the belt clip

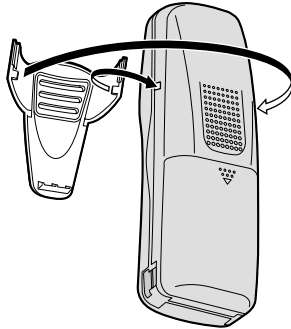

To remove the belt clip



Using an optional Headset



Plugging an optional headset into the handset allows a hands-free phone conversation. Please use only the Panasonic KX-TCA89EX headset.

Connecting the headset to the handset

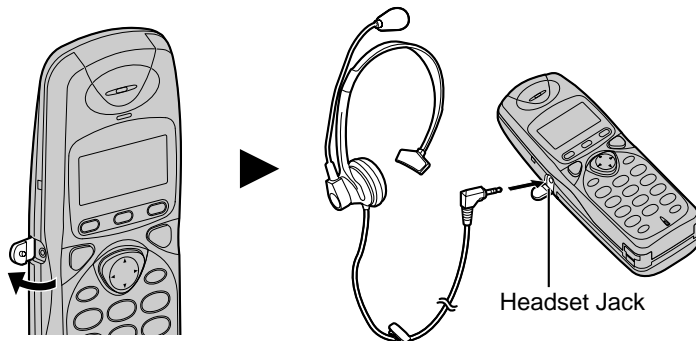
Open the headset jack cover, and connect the headset to the headset jack as shown.



To adjust the headset receiver volume (HIGH, MEDIUM or LOW):















While using the headset, press  or .

When the optional headset is connected to the handset, make sure to use the headset to talk with the caller. If you want to have a normal cordless phone conversation, disconnect the headset.

Replacing the Batteries

Selecting the battery type

Two Nickel metal hydride (Ni-MH) batteries are included with this unit. Nickel cadmium (Ni-Cd) rechargeable batteries can also be used. If you replace the batteries with Ni-Cd batteries, you must set the battery type selection to "Ni-Cd", or the battery strength will not be displayed correctly. The factory preset is "Ni-MH".

- 1 Press .
- 2 Press  or  until the arrow points to "Setting Handset", then press .
- 3 Press  or  until the arrow points to "Other Option", then press .
- 4 Press  or  until the arrow points to "Battery Type", then press .
 - The current battery type is at the arrow.
- 5 Press  or  to select "Ni-Cd" or "Ni-MH", then press .
 - To return to the standby mode, press .

• Incorrect battery type selection may shorten battery life.

Battery replacement

If  flashes after a few telephone calls even when the handset batteries have been fully charged, it is time to replace the batteries with new ones. **Remember to charge the new batteries after replacement.**

- 1 Turn the power OFF to prevent memory loss (p. 13).
Remove the cover by sliding while pressing in the direction of the arrow, then take out the batteries.
- 2 Replace the batteries with new ones as shown.
 - When you finish, close the handset cover and turn the power ON (p. 13).
- 3 Be sure to charge the new batteries fully in order to display the battery strength prompt correctly (p. 12).
Ni-MH battery: For about 15 hours.
Ni-Cd battery: For about 4 hours.

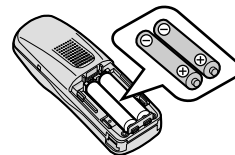
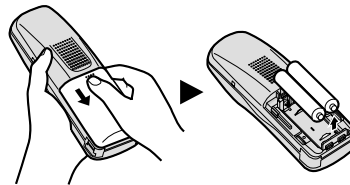

- Discard defective batteries as soon as possible. Defective batteries may leak into the unit.
- Please use only BYD 4DH33B00001 batteries.
- If the rechargeable batteries are not inserted correctly, the handset will not work.
- Please return the rechargeable batteries to your sales shop at the end of their useful life.
- Nickel cadmium (Ni-Cd) rechargeable batteries (AA size) are available. Please use only Panasonic P6H batteries.

Caution:

To reduce the risk of fire or injury to persons, read and follow these instructions.

1. Use only the batteries specified.
2. Do not use non-rechargeable batteries.
3. Do not mix old and new batteries.
4. Do not dispose of the batteries in a fire. They may explode. Check with local waste management codes for special disposal instructions.
5. Do not open or mutilate the batteries. Released electrolyte is corrosive and may cause burns or injury to the eyes or skin. The electrolyte may be toxic if swallowed.
6. Exercise care in handling the batteries in order not to short the batteries with conductive materials such as rings, bracelets, and keys. The batteries and/or conductor may overheat and cause burns.
7. Charge the batteries provided with or identified for use with this product only in accordance with the instructions and limitations specified in this manual.

Important Notice Concerning the Correct Use and Charging of Ni-MH (Ni-Cd) Batteries

Batteries, due to their construction, undergo some wear and tear. The lifetime of a battery also depends on correct maintenance. Charging and discharging are the most important factors. You should take notice of the following to maintain the life of the battery as long as possible.

Ni-MH (Ni-Cd) batteries have a kind of memory, the "memory effect". If fully charged batteries are used several times only for 15 minutes in the handset and then recharged, the capacity of the batteries will be reduced to 15 minutes due to the memory effect. Therefore you should discharge the batteries completely, i.e. use them in the handset until " ," on the display starts flashing. Then recharge them as described in the manual. After the memory effect has occurred, it is possible to achieve almost complete capacity of the Ni-MH (Ni-Cd) batteries by charging and discharging several times one after another.

Ni-MH (Ni-Cd) batteries can also self-discharge. This self-discharge depends on the ambient temperature. At temperatures under 0°C, the self-discharge will be the lowest. High humidity and high temperatures support the self-discharge. Also long-term storage will lead to self-discharge. A dead Ni-MH (Ni-Cd) battery should not be disposed of normally. They contain toxic heavy metal (cadmium) and therefore should be recycled.

Wall Mounting

This unit can be mounted on a wall.

1 Connect the AC adaptor.

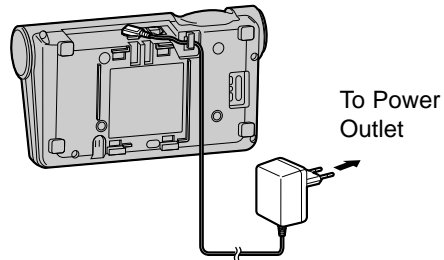

2 Tuck the Telephone line cord inside the wall mounting adaptor, then push it in the direction of the arrow.

- The word "UP" should face upward.

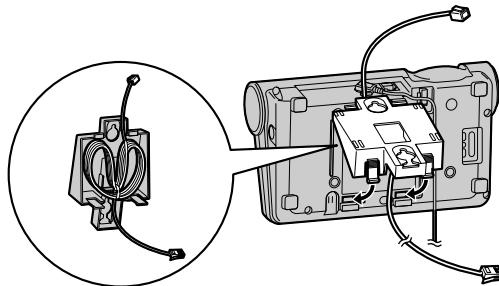

3 Install screws using the wall template below. Connect the Telephone line cord. Mount the unit, then slide down.

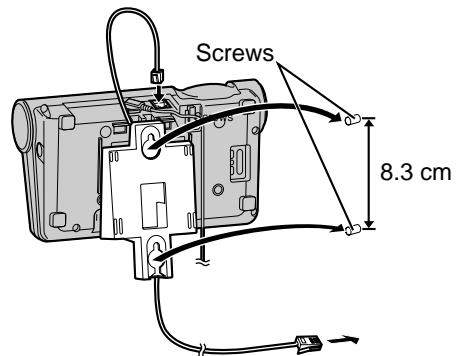

4 To charge the handset battery:

Place the handset on the cradle and adjust the angle of the cradle in the direction of the arrow as shown.

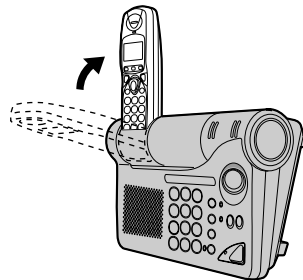

Wall Template

72

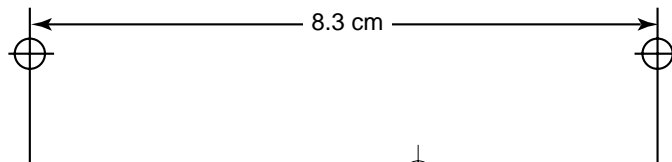

Option Covers

You can change the look of your phone's handset with option covers (KX-A109EX).

1. Turn the power OFF to prevent memory loss (p. 11). Remove the battery cover by sliding while pressing the arrow. Remove the batteries.
2. The option cover is locked with the right and left tabs. Unlock one of the tabs by pressing horizontally ① and vertically ②, and partially pull down the option cover ③, ④, as shown. Repeat this operation on other tab.

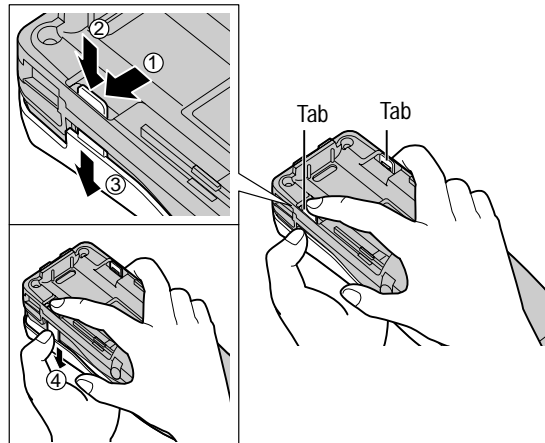

3. Place the new option cover fitting the tabs on the cover into their slots on the handset.

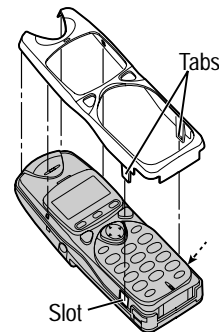



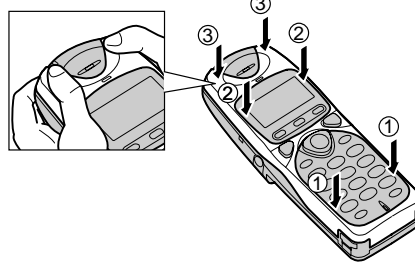



4. Snap the option cover shut on the lower ①, middle ② and upper ③ parts of the handset.







5. Install the batteries and close the battery cover.
 - When you finish, close the handset cover and turn the power ON (p. 11).







Before Requesting Help

Problem	Remedy
The unit does not work.	<ul style="list-style-type: none"> • Turn the power ON (p. 13). • Check the settings (p. 11–20). • Charge the batteries fully (p. 12). • Clean the charge contacts and charge again (p. 12). • Unplug the AC adaptor and turn the power OFF to reset. Plug in the AC adaptor and turn the power ON. Then try again. • The handset has been canceled or has not been registered. Register the handset (p. 59). • Re-install the handset batteries and try again.
“  ” flashes and an alarm tone sounds when you press  or  .	<ul style="list-style-type: none"> • You are too far from the base unit. Move closer and try again. • Plug in the AC adaptor.
A busy tone sounds when you press  or  .	<ul style="list-style-type: none"> • Another handset is in use or the base unit speakerphone is in use.
You cannot dial.	<ul style="list-style-type: none"> • The unit is in call prohibition mode. Cancel the mode (p. 47). • The dialled number is restricted. Cancel the number (p. 49). • Key lock mode is set. Cancel the mode (p. 44).
“  ” flashes during a conversation and the call is disconnected.	<ul style="list-style-type: none"> • The handset is out of range. Move closer to the base unit and make the call again. • Plug in the AC adaptor.
Static, sound cuts in/out, fades. Interference from other electrical units.	<ul style="list-style-type: none"> • Locate the handset and base unit away from other electrical appliances (p. 5). • Move closer to the base unit.



Problem	Remedy
The handset does not ring.	<ul style="list-style-type: none"> • Turn the power ON (p. 13). • The ringer is set to OFF. Select the desired volume level (p. 20).
The base unit does not ring.	<ul style="list-style-type: none"> • The ringer is set to OFF. Set to HIGH, MEDIUM or LOW (p. 20).
You cannot program function items such as selecting language.	<ul style="list-style-type: none"> • Programming is not possible while the unit is in the talk, intercom or speakerphone mode. • Do not pause for over 60 seconds while programming.
You cannot store a name and phone number in the phonebook.	<ul style="list-style-type: none"> • You cannot store a name and phone number while the unit is in the talk, speakerphone or intercom mode. • Do not pause for over 60 seconds while storing.
While programming or searching, the unit starts to ring and stops the program/search.	<ul style="list-style-type: none"> • To answer the call, press  / . Start from the beginning after hanging up.
The unit does not display the caller's phone numbers.	<ul style="list-style-type: none"> • Other telephone equipment may be interfering with your phone. Disconnect them and try again. • Other electrical appliances connected to the same outlet may be interfering with the Caller ID information. Telephone line noise may be affecting the Caller ID information.
The display goes to the standby mode while viewing the Caller List or phonebook.	<ul style="list-style-type: none"> • Do not pause for over 60 seconds while searching.
 does not function.	<ul style="list-style-type: none"> • The handset is too far from the base unit. • The handset is engaged in an outside call or is viewing the Caller List or phonebook. Wait until the in use indicator () light goes out.
You cannot redial.	<ul style="list-style-type: none"> • If the last number dialled was more than 24 digits long, the number will not be redialled.

➔ Before Requesting Help

Problem	Remedy
The paged handset does not answer.	<ul style="list-style-type: none"> • The handset is not in the same radio area. • The handset is engaged in an outside call. • The handset has been cancelled or has not been registered. Register the handset in the base unit (p. 59).
While using the intercom, two tones sound.	<ul style="list-style-type: none"> • A call is being received. To answer, press  and  or  and .
The unit misdials when connected to a PBX.	<ul style="list-style-type: none"> • Check the pause function (p. 43).
You cannot register the handset in the base unit.	<ul style="list-style-type: none"> • The base unit has registered a maximum of 6 handsets or the handset has registered a maximum of 4 base units. • A wrong base unit PIN was entered. Enter the correct PIN. • There is interference from other electrical units. Locate the handset and base unit away from them. • You must finish registration within 1 minute after the ringer tone sounds, or programming will be cancelled (p. 59).
The battery strength is not displayed correctly.	<ul style="list-style-type: none"> • Check that the battery type selection is correct (p. 70).
"  " flashes or the unit beeps every 15 seconds.	<ul style="list-style-type: none"> • Charge the batteries fully (p. 12).
You charged the batteries fully, but "  " flashes.	<ul style="list-style-type: none"> • Clean the charge contacts and charge again (p. 13). • Install new batteries (p. 70).

Safety Instructions

Take special care to follow the safety suggestions listed below.

Safety

- 1) The unit should be connected to a power supply only of the type described in the operating instructions or as marked on the unit.
- 2) When the unit is not used, turn the power off. When left unused for a long period of time, the base unit should be unplugged from the household AC outlet.

Installations

Environment

- 1) Do not use this unit near water—for example, near a bath tub, washbowl, sink, etc. Damp basements should also be avoided.
- 2) The unit should be kept away from heat sources such as radiators, kitchen range, etc. It also should not be placed in rooms where the temperature is less than 5°C or greater than 40°C.
- 3) The AC adaptor is used as the main disconnect device, ensure that the AC outlet is located/ installed near the unit and is easily accessible.

Placement

- 1) Do not place heavy objects on top of this unit.
- 2) Care should be taken so that objects do not fall onto and liquids are not spilled into the unit. Do not subject this unit to excessive smoke, dust, mechanical vibration, or shock.
- 3) Place the unit on a flat surface.

For best performance

- 1) If noise prevents the conversation from being understood at the handset, approach the base unit to lessen the noise.
- 2) The handset should be used at the HIGH volume setting when the reception tone is difficult to hear the other party.
- 3) The handset should be fully recharged on the base unit when "  " on the display flashes.
- 4) The handset aerial should not be touched during use because of its high sensitivity.
- 5) The maximum calling distance may be shortened when the unit is used in the following places:
Near obstacles such as hills, tunnels, underground, near metal objects such as wire fences, etc.

Lightning surge

This unit has already been equipped with a built-in lightning protection circuit. However, we recommend that you install the following options, if your area has frequent lightning strikes.

- 1) Lightning protection on the telephone line
- 2) Lightning protection on the power source

To install the above options, please contact your local sales shop.

- Lightning damage is not covered in the warranty even if lightning protection is installed.

WARNING:

TO PREVENT FIRE OR SHOCK HAZARD, DO NOT EXPOSE THIS PRODUCT TO RAIN OR ANY TYPE OF MOISTURE.

Term Definitions

DECT

The abbreviation DECT means “Digital Enhanced Cordless Telecommunications”.

Advantages of DECT

Excellent voice quality: Through sampling of digital signals DECT units obtain nearly noiseless transmission.

High grade tapping security: Based on digital transmission, DECT conversations are well protected against unapproved monitoring.

Multi-Handset operation: To operate several handsets at the base unit, no cable installation is required.

Interlink: Intercom conversation can be held free of charge between the registered handsets.

Functions like a PBX: More than one operation can be performed at the same time, like a PBX. eg., during an external call, an internal call or outside call can be transferred to another handset.

Multi-Base station operation: More than one handset can be registered to several base units, e.g., for private and office applications.

Equipment Manufacturer’s Code (EMC)

For identification, this unit is prepared with an EM Code, which can be applied to future operators in mobile networks.

Adding Another Phone

This unit will not function during a power failure. To connect a standard telephone on the same line, use a T-adaptor.

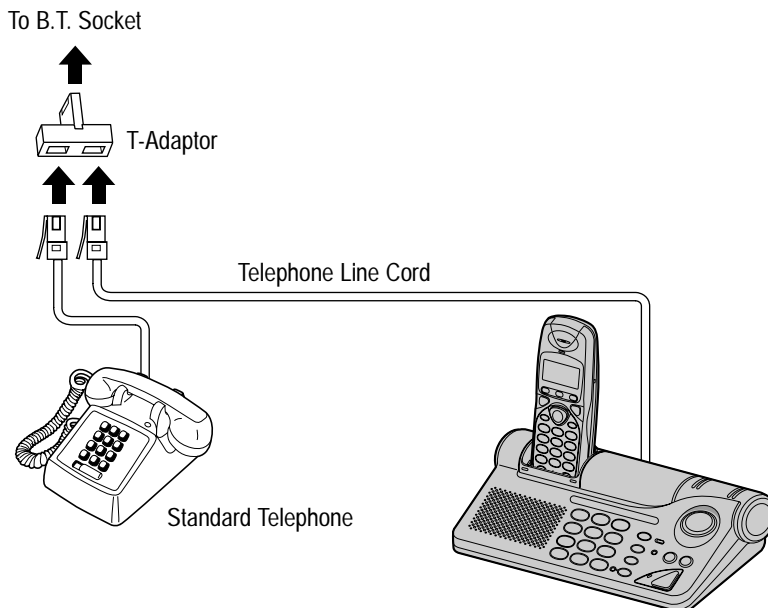

GUARANTEE CONDITIONS OF GUARANTEE

This guarantee is in addition to and does not in any way affect any statutory or other rights of consumer purchasers. If within the applicable guarantee period, the appliance proves to be defective by reason of faulty design, workmanship or materials, we undertake subject to the following conditions to have the defective appliance (or any part or parts there of) repaired or replaced free of charge.

1. The appliance shall have been purchased and used solely within the UK and in accordance with standard operating instructions and the technical and/or Safety Standards required in the UK.
2. The appliance should be returned together with this guarantee and proof of date of purchase promptly on being found defective at the purchaser's risk and expense to the authorised dealer from whom the appliance was purchased or to the nearest authorised dealer. All enquires must be through such dealers.
3. This guarantee shall not apply to damage caused through fire, accident, lightning, misuse, wear and tear, neglect, incorrect adjustment or repair, to damage caused through installation, adaption, modification or use in an improper manner or inconsistent with the technical and/or safety standards required in the country where this appliance is used, or to damage occurred during transit to or from the purchaser.
4. If at any time during the guarantee period any part or parts of the appliance are replaced with a part or parts not supplied or approved by us or of an objective quality safe and suitable for the appliance, or the appliance has been dismantled or repaired by any person not authorised by us, we shall have the right to terminate this guarantee in whole or in part immediately without further notice.
5. The purchaser's sole and exclusive remedy under this guarantee against us is for the repair or replacement of the appliance or any defective part or parts and no other remedy, including, but not limited to, incidental or consequential damage or loss of whatsoever nature shall be available to the purchaser.
6. This guarantee shall not apply to cassette tapes, batteries and any other items of limited natural life.
7. Our decision on all matters relating to complaints shall be final. Any appliance or defective part which has been replaced shall become our property.
8. The guarantee period applicable to this product shall be 12 months.

Please keep these Operating Instructions with your receipt.

Panasonic Business Systems U.K.

Receipt No. Date of Purchase

Model No. **KX-TCD715EM** Serial No.



MODEL No. KX-TCD715EM

Manufacturer's Declaration:

Hereby, Kyushu Matsushita Electric (U.K.) Ltd., declares that this Dect Cordless Telephone is in compliance with the essential requirements and other relevant provisions of Directive 1999/5/EC.

A copy of the manufacturer's declaration of conformity to the essential requirements of the R&TTE Directive is available at the following web address:
<http://doc.panasonic-tc.de>

Customer Care Helpline Tel. No.: 08705 357357

CE0436

1999/5/EC

This equipment is designed for use on the United Kingdom only.
In the event of problem, you should contact your equipment supplier in the first instance.

Technical specifications are subject to change.

Sales Department:

Panasonic Business Systems U.K.

Panasonic House, Willoughby Road, Bracknell, Berkshire, RG12 8FP

Manufacturer:

Kyushu Matsushita Electric (U.K.) Ltd.

Pencarn Way, Duffryn, Newport, South Wales, NP10 8YE, United Kingdom

Printed in the United Kingdom

PQQX12950ZA KU0701ST0