

Operating Instructions Blu-ray Disc Recorder

Model No. **DMR-BS850**
DMR-BS750

DIGA
Blu-ray



Dear customer

Thank you for purchasing this product. For optimum performance and safety, please read these instructions carefully.

Before connecting, operating or adjusting this product, please read the instructions completely.

Please keep this manual for future reference.



BONUS VIEW™



AVCHD™



HDMI



DVB and the DVB logos are trademarks of the DVB Project.

- This Blu-ray Disc recorder is equipped with a Common Interface. It can receive encrypted and free-to-air DVB-S/S2 services.
- The tuner in this unit is only compatible with DVB-S/S2.

Region management information	
<p>BD-Video This unit plays BD-Video marked with labels containing the region code B.</p>	<p>Example:</p>
<p>DVD-Video This unit plays DVD-Video marked with labels containing the region number "2" or "ALL".</p>	<p>Example:</p>

Web Site: <http://www.panasonic-europe.com>

Characteristics of this unit

Record with High Definition

It is possible to record in high definition quality when the broadcast is high definition.

⇒ 7



EPG

Timer recording is made easier because the TV Guide allows you to see programme information.

⇒ 23

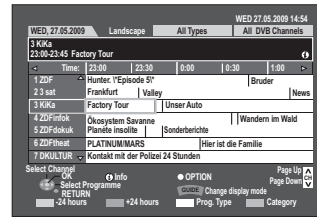

Easy access to various functions

You can access the main function quickly and easily from FUNCTION MENU display.

⇒ 13

- FUNCTION MENU display

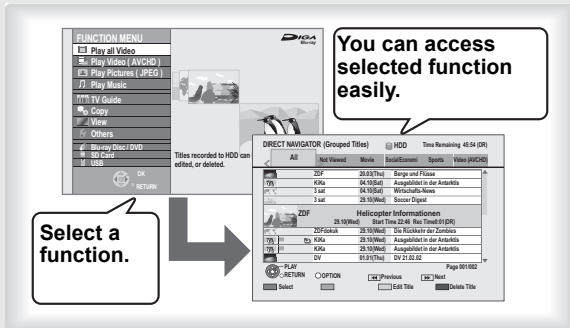

2 programmes Simultaneous Recording

It is possible to record 2 programmes being broadcasted at the same time by connecting two satellite cables.

⇒ 31

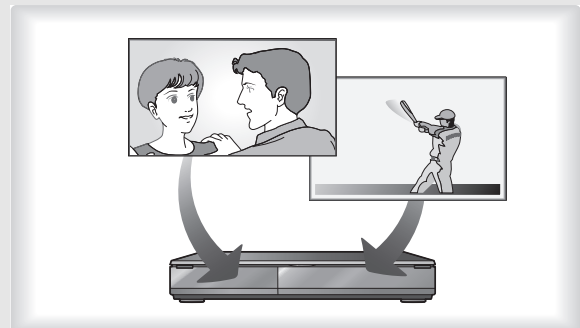

Network Connection

You can access a selection of Internet services from the Home screen with VIERA CAST. You can also playback the video in the HDD of this unit from DLNA compatible equipment on the same network.

- Enjoying VIERA CAST™ (⇒ 78)
- DLNA feature (⇒ 79)

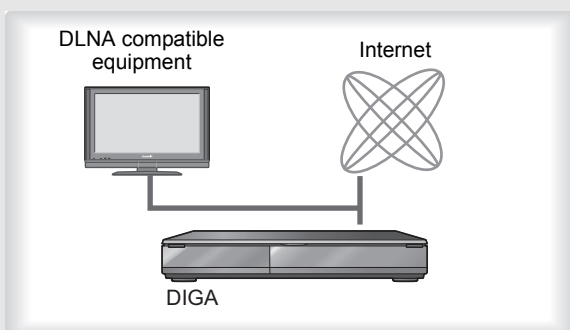

VIERA Link "HDAVI Control™"

Operation of this unit can be controlled by the remote control of the TV (VIERA) by connecting with the HDMI cable to the TV (VIERA).

- Linked operations with the TV (VIERA Link "HDAVI Control™"/ Q Link) (⇒ 76)
- Pause Live TV (⇒ 79)



About descriptions in these operating instructions

• These operating instructions are applicable to models DMR-BS850 and DMR-BS750. The illustrations in these Operating Instructions show images of DMR-BS850 unless otherwise indicated.

BS850: indicates features applicable to DMR-BS850 only.

BS750: indicates features applicable to DMR-BS750 only.

• Pages to be referred to are indicated as "⇒ ○○".

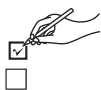

Please check and identify the supplied accessories.
(Product numbers correct as of September 2009. These may be subject to change.)



(N2QAYB000338)

1 Remote control

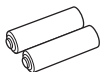

2 Batteries
for remote control

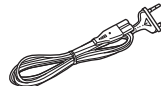

1 AC mains lead
For use with this unit only. Do not use it with other equipment.
Also, do not use cords for other equipment with this unit.

■ The remote control information

Batteries

● Insert so the poles (+ and -) match those in the remote control.

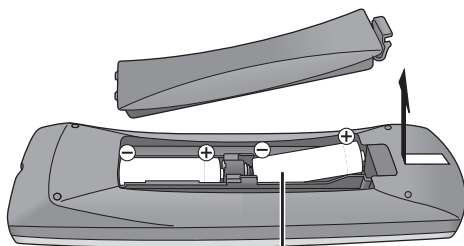

R6/LR6, AA

- Use alkaline or manganese batteries.
- Do not mix old and new batteries.
- Do not use different types at the same time.
- Do not heat or expose to flame.
- Do not leave the battery(ies) in an automobile exposed to direct sunlight for a long period of time with doors and windows closed.
- Do not take apart or short circuit.
- Do not attempt to recharge alkaline or manganese batteries.
- Do not use batteries if the covering has been peeled off.

Mishandling of batteries can cause electrolyte leakage which can damage items the fluid contacts and may cause a fire.

Remove if the remote control is not going to be used for a long period of time. Store in a cool, dark place.

Use

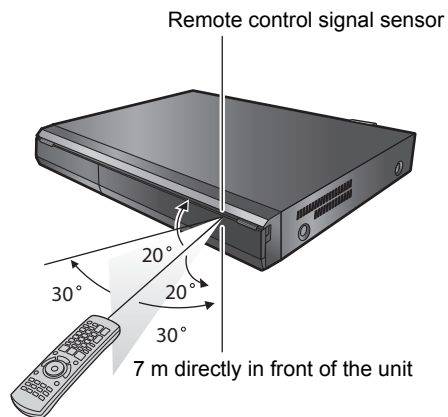

The distance and angles are an approximate.

Getting started

Getting started

Characteristics of this unit	2
Included accessories	3

Quick Start Guide

HDD and disc information	6
Regarding Blu-ray Disc	6
Recording high definition programmes and copying	7
HDD and discs you can use for recording and play	8
Play-only discs	10
Discs that cannot be played	10
USB memory and card information	11
USB memories you can use on this unit	11
Cards you can use on this unit	11
Control reference guide	12
Remote control	12
Main unit	12
The unit's display	13
Easy access to various functions	
— FUNCTION MENU display	13
HDD (Hard disk drive) handling care	14
Unit care	14
Media handling (Disc/USB memory/SD card)	15
Inserting discs	15
Inserting, removing the USB memory	15
Inserting, removing the SD card	15
Disc and card care	15
STEP 1 Inserting the CAM (Conditional Access Module) and Smart Card	16
STEP 2 Connection	17
STEP 3 Channel reception settings and TV aspect settings	18
STEP 4 Setting the CI or CI Plus (Common Interface)	19

Basic operations

Watching digital broadcasts	20
Playing BD-Video or DVD-Video/	
Playing recorded video contents	21
Playing BD-Video or DVD-Video	21
Playing recorded video contents	21
Recording television programmes HDD	22
To specify a time to stop recording	
—One Touch Recording	22
Timer recording	23
Timer Recording using the TV Guide system	23
Deleting titles	25
Deleting during play	25
Copying titles	26
Advanced watching digital broadcasts	27
Digital channel information	27
To show subtitle	27
Switching audio of the TV broadcast	27
To select content in the digital broadcast	28
To show Teletext	28

Title

Recording

Advanced recording	29
Recording method and disc	29
Recording modes and recording contents	29
2 programmes simultaneous recording	31
Types of recording data for copyright protected titles	31
Important notes for recording	32
Playing while you are recording	33
Operation during Recording	34

Advanced timer recording	35
Manually programming timer recording	35
To release the unit from timer recording standby	36
Auto Renewal Recording	36
To cancel recording when timer recording has already begun	36
Check, change or delete a programme	37
Notes on timer recording	37
Operations in the TV Guide system	38
TV Guide data download	38

Playing back

Advanced playback	39
Operation during play	39
Changing audio during play	40
Display the subtitle during play	40
Display the Teletext during play	40
Selecting recorded programmes (titles) to play	
—DIRECT NAVIGATOR	41
Switching of the Navigator HDD	41
Playback the title that was viewed once HDD	41
To change the Genre Label HDD	42
To play grouped titles HDD	42
To edit the group of titles HDD	42
Playback of the High Definition Video (AVCHD)	43
Playback of the playlist created on other equipment	43
Playing DivX®	44
Playing DivX video contents	44
To enjoy the BD Video which supports BONUSVIEW or BD-Live BD-V	46
Playing secondary video (picture-in-picture) and secondary audio	46
Enjoying BD-Live discs with Internet	46
To enjoy High Bit Rate Audio and Video	47
Enjoying High Bit Rate Audio with 7.1ch speaker	47
Regarding 24p output	47

Editing

Editing titles	48
Title operations	49
Create/Playback/Edit of the Chapter	51
Create Chapter Mark	51
Editing and playing chapters	51
Chapter operations	51

Copying

Copying titles	52
Copy Title Playing	55
Copying using the copying list—Copy	56
Copying a finalised DVD-R, DVD-R DL, DVD-RW (DVD-Video format), +R and +R DL	58

With Other Equipment

Recording broadcasts from external equipment	59
Recording from Set Top Box	59
Linked timer recordings with external equipment (Set Top Box) — EXT LINK	59
Copying from a video equipment (video cassette recorder, etc.)	60
Manual recording	60
DV Automatic Recording	61
Flexible Recording via AV input	61
Copy the HD Video (AVCHD format) or the SD Video (MPEG2 format)	62
Copying HD Video (AVCHD format)	62
Copying SD Video (MPEG2 format)	63

Still pictures

Still pictures

Playing still pictures	64
Useful functions during still picture play	65
Editing still pictures	66
Editing still pictures (JPEG)	66
Still pictures operation	67
Copying still pictures	68
Copying new still pictures on the SD card	68
—Copy New Pictures (JPEG)	68
Copying all the still pictures on the USB memory	68
—Copy All Pictures (JPEG)	68
Copying using the copying list	68

Music

Music

Playing music	70
Playing MP3 files	70
Playing music CD	70
Playing music recorded on HDD	71
Useful functions during music play	72
Editing music/playlist	73
Editing music	73
Album and track operation	73
Register track to Playlist	74
Editing Playlist	74
Playlist operation	74
Copying music to HDD	75
About the Gracenote® Database	75
Copying music from a disc or a USB memory	75

Others

Convenient functions

Linked operations with the TV (VIERA Link “HDAVI Control™”/Q Link)	76
Easy control only with VIERA remote control	77
Enjoying VIERA CAST™	78
Pause Live TV	79
To pause the TV programme you are watching	79
—Pause Live TV	79
DLNA feature	79
Playing back from	79
Panasonic DLNA compatible equipment	79
non-Panasonic DLNA compatible equipment	79
Entering text	80
Convenient functions to playback and viewing or listening	81
Using on-screen menus	81
Status messages	83
Switch the aspect ratio of the screen	83

Disc and card management	84
Common procedures	84
Setting the protection	84
Providing a name for a disc	84
Deleting all titles—Delete all titles	85
Delete BD-Video data	85
Enabling the unit's recording function—Format	85
Selecting the background style—Top Menu	86
Selecting whether to show the Top Menu first	86
—Auto-Play Select	86
Finalising—Finalise	86
Creating Top Menu—Create Top Menu	86

Changing the unit's settings	87
Common procedures	87
DVB Tuning	87
HDD / Disc	89
Picture	90
Sound	91
Display	92
Connection	92
Network Settings	94
Others	95
Network Settings	96

Software (firmware) Update	98
Update software (firmware) of this unit	98
CI Plus compatible CAM (Conditional Access Module) software (firmware) update	98

Other Settings	99
Television operation	99
HOLD function	99

Additional connections	100
Connecting a television with AUDIO/VIDEO terminals	100
Connecting a television with	100
COMPONENT VIDEO terminals	100
Connecting a stereo amplifier	100
Connecting VCR or Set Top Box (Terrestrial receiver, CATV, etc.)	101
Connecting an amplifier with a digital input terminal	101
Connecting with an HDMI compatible television and receiver	102
Network connection	103

Reference

Operations that can be performed simultaneously	104
Operations that can be performed while recording or copying a title	104
Starting of the timer recording while executing other operation	104
Frequently asked questions	105
Messages	106
When removing a recorded disc	106
Troubleshooting guide	108
Specifications	115
Glossary	118
Safety precautions	120
Index	122

Getting started

Quick Start Guide

Basic operations

Recording

Playing back

Editing

Copying

With Other Equipment

Still pictures

Music

Convenient functions

Reference

HDD and disc information

This unit can record or copy to the following HDD or discs.

Internal



You can record the programme of the digital broadcast to the HDD by using this unit's tuner.

Recording by pressing [● REC] button

It can only record to HDD by pressing [● REC] in DR mode (⇒ 29).



HDD



Timer recording

It can only record to HDD when using timer record.

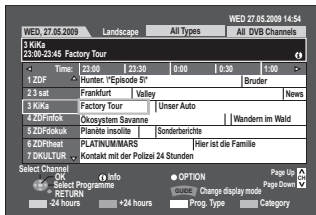

HDD



• Discs can be recorded from the external equipment. Discs that can be recorded will differ depending on the recording method. For details, please refer to "Recording method and disc" on page 29.

Regarding Blu-ray Disc

1.High volume recording

The Blu-ray Disc (BD-RE and BD-R) has a lot more recording capacity compared with the DVD.

When you compare the Blu-ray Disc (single-side dual-layer 50 GB) with the DVD-R (4.7 GB)

DVD-R (4.7 GB)

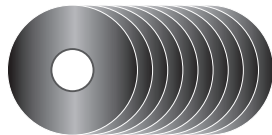

About 10 DVD-Rs

Blu-ray Disc
(50 GB: single-side dual-layer)



When a 2 hour movie is recorded (in SP mode)

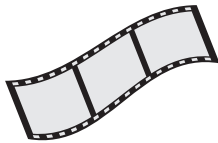

About 1 movie
(per 1 DVD disc)

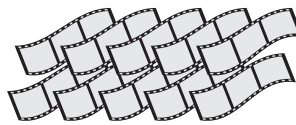

About 10 movies

2.High quality recording

Blu-ray Disc can record the image of the digital broadcasting in the same quality as broadcasted. Therefore, high definition quality can be recorded as high definition quality as it is.



Blu-ray Disc

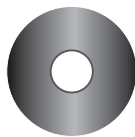

Broadcasted images can be recorded as they are
(When recorded in DR mode)

DVD-R, etc.



Broadcasted images cannot be recorded as they are

Recording high definition programmes and copying

This unit will record the high definition quality programmes*¹ of the digital broadcast onto the HDD with high quality image and audio as it was broadcasted. Perform the copy using an appropriate disc and recording mode for your purpose.



Programmes in high definition (HD) quality

Recording



DR mode



- Record as high definition (HD) quality
- All subtitles, multiple audio and Teletext are recorded.

COPY



When copying titles to disc

- Quality and speed of copy depends on the type of disc being used.

Copy as it was broadcasted



DR mode



- Copy as high definition (HD) quality
- Copy in High Speed mode
- All subtitles, multiple audio and Teletext are copied.

Copy in high definition for a long time*²



HG, HX, HE, HL mode*²



- Copy as high definition quality with compressed broadcast data.
- Copy in Normal Speed mode
- Only one subtitle can be copied.*³
- Only one audio can be copied for the multiple audio.
- Teletext can be copied. [Copy Title Playing only (⇒ 55)]*⁴

Copy in standard definition



XP, SP, LP, EP, FR mode

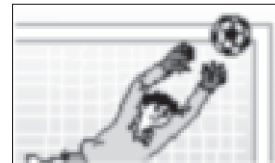

- Copy as standard definition (SD) quality
- Copy in Normal Speed mode
- Only one subtitle can be copied.*³
- Only one audio can be copied for the multiple audio.
- Teletext can be copied. [Copy Title Playing only (⇒ 55)]*⁴

*¹ It will also record standard definition programmes of the digital broadcast with the same quality of image and audio as broadcasted.

*² Data size of the copied title may be larger than the original title, depending on the transfer rate. It is recommended to use HE or HL mode when you record high definition and long programmes.





*³ You cannot switch the subtitle on or off during the playback of the copied title.

*⁴ You cannot operate the Teletext during the playback of the copied title. (⇒ 28)





HDD and discs you can use for recording and play

(○: Possible, -: Impossible)

Disc type	Hard disk drive (HDD)	
Standard symbol		
Data that can be recorded and played	Video/Still picture/Music	
Quality in which video is recorded	High definition (HD) quality/Standard definition (SD) quality	
Recording mode in which video is recorded	DR, HG, HX, HE, HL, XP, SP, LP, EP, FR	
Rewritable	○	
Timer recording	○	
Recording of copyright protected titles (⇒ 31)	○	

Disc type	BD-RE (50 GB/25 GB)	BD-R (50 GB/25 GB)
Standard symbol	 	 
Data that can be recorded and played	Video/Still picture	Video
Quality in which video is recorded	High definition (HD) quality/Standard definition (SD) quality	
Recording mode in which video is recorded	DR, HG, HX, HE, HL, XP, SP, LP, EP, FR	
Rewritable	○	-
Timer recording	-	
Recording of copyright protected titles (⇒ 31)	○	
Play on other players	<p>It can be played on the players compatible with BD-RE (Ver. 2.1) and BD-R.</p> <ul style="list-style-type: none"> ●BD-RE and BD-R that were recorded on this unit may not be played on other Blu-ray Disc players, etc. Also, when programmes broadcasted in countries (France, New Zealand, etc.) adopting the HE-AAC audio format are recorded in the DR mode, Blu-ray Disc Players incompatible with the HE-AAC may not output audio recorded onto BD-RE or BD-R disc on this unit while playback may be possible with those players. To playback titles recorded in DR mode on this unit, please convert the recording mode. (⇒ 32, 50) ●Playback of LTH type BD-R discs may not be possible with players that do not support the LTH type format. ●Single-side dual-layer (50 GB) disc can only be played on the compatible player. 	
Note	<ul style="list-style-type: none"> ●DL is also included. "DL" is a single-side dual-layer disc. ●BD-RE (Ver. 1.0) with a cartridge cannot be used with this unit. (It cannot be used even if it is taken out from the cartridge) Use the BD-RE compliant to Blu-ray Disc Rewritable Format Version 2.1. 	<ul style="list-style-type: none"> ●DL is also included. "DL" is a single-side dual-layer disc. ●LTH type is also included. ●For BD-R finalised with this unit or other equipment, only playback is possible on this unit.

●Recording modes that can be selected differ depending on the recording methods. For details, please refer to the respective operating.

Disc type	DVD-RAM	DVD-R	DVD-R DL	DVD-RW
Standard symbol	 RAM	 -R before finalisation DVD-V after finalisation	 -R DL before finalisation DVD-V after finalisation	 -RW(V) before finalisation DVD-V after finalisation
Data that can be recorded and played	Video Still picture	Video		
Quality in which video is recorded	Standard definition (SD) quality			
Recording mode in which video is recorded	XP, SP, LP, EP, FR			
Rewritable	○	-		○
Timer recording	-			
Recording of copyright protected titles (⇒ 31)	○ CRPM (⇒ 118) compatible discs only.	-		
Play on other players	RAM can be played back on Panasonic DVD recorders and DVD-RAM compatible DVD players.	<ul style="list-style-type: none"> Finalisation needed for playback on other equipment. -R DL can be played back only on equipment compatible with this disc. 		
Note	Take the disc out from the cartridge to use the DVD-RAM with a cartridge. (TYPE1 cannot be used)	-		

Disc type	+R	+R DL	+RW
Standard symbol	+R before finalisation DVD-V after finalisation	+R DL before finalisation DVD-V after finalisation	+RW
Data that can be recorded and played	Video		
Quality in which video is recorded	Standard definition (SD) quality		
Recording mode in which video is recorded	XP, SP, LP, EP, FR		
Rewritable	-	○	
Timer recording	-		
Recording of copyright protected titles (⇒ 31)	-		
Play on other players	<ul style="list-style-type: none"> Finalisation needed for playback on other equipment. +R DL can be played back only on equipment compatible with this disc. 		<ul style="list-style-type: none"> +RW can be played back only on equipment compatible with this disc. If the disc failed to play on other equipment, we recommend you create top menu (⇒ 86).
Note	<ul style="list-style-type: none"> +R +R DL recorded with this unit or with another Panasonic DVD Recorder may be incompatible. However, discs that are finalised are compatible and can be played. 8X Speed +RW disc is not supported. 		







● Recording modes that can be selected differ depending on the recording methods. For details, please refer to the respective operating.

- Note**
- Discs recorded on equipment other than this unit may not be used for recording on this unit.
 - This unit cannot record NTSC signals to discs that already have PAL signal recordings. (However, both types of programmes can be recorded onto the HDD, BD-RE or BD-R.)
 - You may not be able to record depending on the condition of the discs and you may not be able to play due to the condition of the recording.
 - Recording-restricted or copy-restricted programmes may not be recorded depending on the type of discs (including HDD) or recording mode.

■ Regarding 8 cm Disc

This unit cannot record or edit the 8 cm BD-RE, BD-R, DVD-RAM, DVD-R, DVD-R DL, DVD-RW, +R DL or +RW. Only playback or copy to the HDD is possible.

Play-only discs

Disc type	Logo	Standard symbol	Uses
BD-Video		BD-V	<p>High Definition (HD) movie and music discs</p> <ul style="list-style-type: none"> This unit can playback BONUSVIEW or BD-Live compatible discs. (⇒ 46) <p style="text-align: center;">BONUS VIEW™ </p> <ul style="list-style-type: none"> When playing a set of two or more BD-Video discs, the menu screen may continue to display even if the disc has been ejected. To enjoy High Bit Rate Audio and Video (⇒ 47) Operation of this unit may become slower when the BD-J application (⇒ 118) is executing. This is not malfunction.
DVD-Video		DVD-V	Movie and music discs
DVD-RW (DVD Video Recording format)		-RW(VR)	<p>DVD-RW video recorded on another DVD recorder</p> <ul style="list-style-type: none"> By formatting (⇒ 85) the disc, you can record onto it in DVD-Video format. It may be necessary to finalise the disc on the equipment used for recording.
DVD-R DVD-R DL	 	DivX®, MP3, JPEG	<ul style="list-style-type: none"> DVD-R* and DVD-R DL* with video recorded in DivX DVD-R* and DVD-R DL* with music recorded in MP3 DVD-R* and DVD-R DL* with still pictures recorded in JPEG
CD		CD	<ul style="list-style-type: none"> Recorded audio and music (including CD-R/RW*)
	—	DivX®, MP3, JPEG	<ul style="list-style-type: none"> CD-R* and CD-RW* with video recorded in DivX CD-R* and CD-RW* with music recorded in MP3 CD-R* and CD-RW* with still pictures recorded in JPEG
Disc with high definition video (AVCHD) recorded by Panasonic's video camera, etc.	—	AVCHD	<p>Following disc can be played.</p> <ul style="list-style-type: none"> BD-RE, BD-R, DVD-RAM, DVD-R, DVD-R DL, DVD-RW, +R, +R DL, +RW Only the DVD-R, DVD-R DL, DVD-RW, +R or +R DL which was finalised (⇒ 118) with the same equipment that was used to record can be played. Set "Play Video (AVCHD) on BD-RE / BD-R" to "On" for the disc that has high definition video (AVCHD) recorded by Panasonic's video camera, etc. and high definition quality title that was recorded on this unit. (⇒ 89)

* Close the session after recording. Play may be impossible on some discs due to the condition of the recording.

- The producer of the disc can control how discs are played. So you may not always be able to control play as described in these operating instructions. Read the disc's instructions carefully.
- Operation and sound quality of CDs that do not conform to CD-DA specifications (copy control CDs, etc.) cannot be guaranteed.

Discs that cannot be played

- BD-RE (Ver.1.0)
- DVD-RAM that cannot be removed from their cartridges
- 2.6 and 5.2 GB DVD-RAM, 12 cm
- 3.95 and 4.7 GB DVD-R for Authoring
- DVD-R, DVD-R DL, DVD-RW, +R, +R DL recorded on another unit and not finalised (⇒ 118).
- BD-Video with a region code other than "B"
- DVD-Video with a region number other than "2" or "ALL"
- DVD-Audio
- HD DVD
- DVD-ROM, +R (8 cm), CD-ROM, CDV, CD-G, Photo CD, CVD, SVCD, SACD, MV-Disc, PD, Video CD, etc.

USB memories you can use on this unit

USB memories can only be used for playback or copy to HDD or discs.

Compatible USB memories	USB memories which are defined as USB mass storage class and digital camera that use PTP protocol: <ul style="list-style-type: none"> – USB memories that support USB 1.0/1.1 and USB 2.0 Full Speed/High Speed. • USB memories of up to 128 GB can be used. • USB memories that support bulk only transfer. CBI (Control/Bulk/Interrupt) is not supported. • Digital Cameras which require additional programme installation when connected to a PC are not supported. • MTP (Media Transport Protocol) device is not supported. • A multi-port USB card reader is not supported.
Format	FAT16 and FAT32 file systems are supported. <ul style="list-style-type: none"> • UDF/NTFS/exFAT file system is not supported. • Depending on the sector size, some files may not work. • Only the first partition on USB memories with multi-partition is supported.
Indicated in these instructions by	USB
Data that can be played	DivX, MP3, Still pictures (JPEG)
Data that can be copied	MP3 <ul style="list-style-type: none"> • It can be copied to HDD. Still pictures (JPEG) <ul style="list-style-type: none"> • It can be copied to HDD, BD-RE or DVD-RAM. Standard Definition (SD) Video (MPEG2 format) High Definition (HD) Video (AVCHD format) <ul style="list-style-type: none"> • SD Video shot with a Panasonic's video camera, etc. can be copied to the HDD or DVD-RAM. (⇒ 63) • HD Video shot with a Panasonic's video camera, etc. can be copied to the HDD, BD-RE or BD-R. (⇒ 62)

• Despite meeting the conditions mentioned above, there may be USB memories that cannot be used for this unit.

Note

• This unit's USB port does not support bus-powered USB device.

Cards you can use on this unit

SD cards can be used for playback, copy to HDD or discs or copy from HDD or discs.

Type	SD Memory Card*¹ (from 8 MB to 2 GB) SDHC Memory Card*² (from 4 GB to 32 GB) <small>*¹ Including miniSD Card and microSD Card</small> <small>*² Including miniSDHC Card and microSDHC Card</small> The card types mentioned above will be referred to as "SD card" in these operating instructions.
Indicated in these instructions by	SD
Data that can be played	Still pictures (JPEG) HD Video (AVCHD format)
Data that can be copied	Still pictures (JPEG) <ul style="list-style-type: none"> • It can be copied to/from HDD, BD-RE or DVD-RAM. Standard Definition (SD) Video (MPEG2 format) High Definition (HD) Video (AVCHD format) <ul style="list-style-type: none"> • SD Video shot with a Panasonic's video camera, etc. can be copied to the HDD or DVD-RAM. (⇒ 63) • HD Video shot with a Panasonic's video camera, etc. can be copied to the HDD, BD-RE or BD-R. (⇒ 62)
Instructions	You can insert directly into the SD card slot. <ul style="list-style-type: none"> • A miniSD Card, a miniSDHC Card, a microSD Card and microSDHC Card must be used with the adaptor that comes with the card.

Suitable SD cards

- When using SD cards 4 GB or larger, only SD cards that display the SDHC logo can be used.
- Useable memory is slightly less than the card capacity.
- Please confirm the latest information on the following website.
<http://panasonic.jp/support/global/cs/>
 (This site is in English only.)
- If the SD card is formatted on other equipment, the time necessary for recording may be longer. Also, if the SD card is formatted on a PC, you may not be able to use it on this unit. In these cases, format the card on this unit (⇒ 85, 118).
- This unit is compatible with SD Memory Cards that meet SD Card Specifications FAT12 and FAT16 formats, as well as SDHC Memory Cards in FAT32 format.
- SDHC Memory Cards used for recording with this unit can only be used with other SDHC Memory Card-compatible equipment. SDHC Memory Cards cannot be used with equipment that is only compatible with SD Memory Cards.
- We recommend using a Panasonic SD card.
- Keep the Memory Card out of reach of children to prevent swallowing.

■ Setting the protection

Switch the write-protect switch to the "LOCK" position.



Remote control

Instructions for operations are generally described using the remote control.

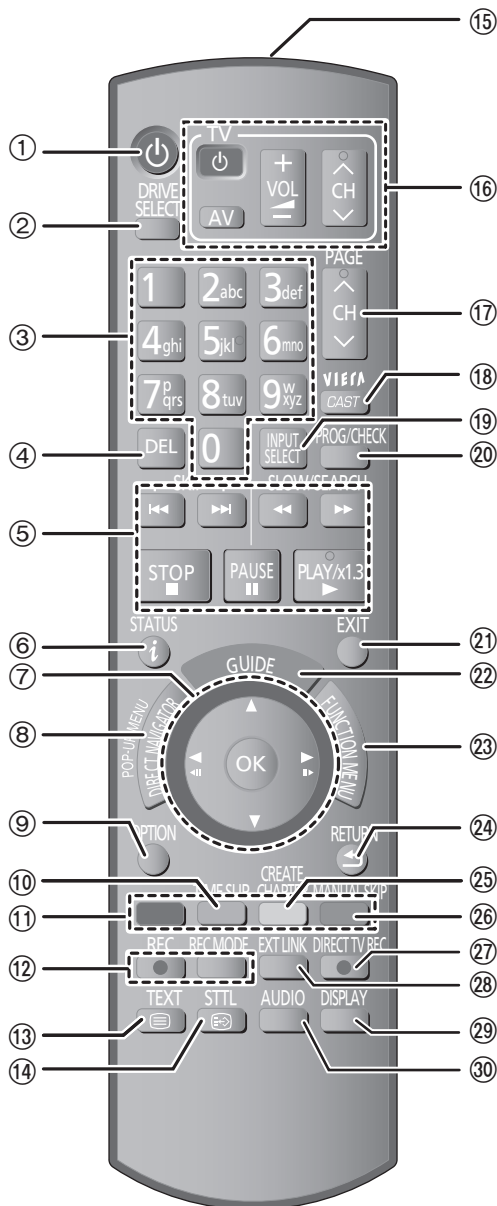

- ① Turn the unit on or off (⇒ 18)
- ② Select drive (HDD, BD or SD) (⇒ 21)
Drive changes each time you press [DRIVE SELECT].
- ③ Select channels and title numbers, etc./Enter numbers or characters (The character buttons may be used when operating VIERA CAST contents.)
- ④ To delete unwanted recorded titles, timer programmes, still pictures or music (⇒ 25, 37)
- ⑤ Basic operations for recording and play
- ⑥ Show digital channel information (⇒ 27)/Programme information within TV Guide screen (⇒ 38)/Show status messages (⇒ 83)
- ⑦ Selection/OK, Select station from Channel List (⇒ 20)/Frame-by-frame (⇒ 40)
- ⑧ Show DIRECT NAVIGATOR, Top menu, Pop-up Menu (⇒ 21)
- ⑨ Show OPTION menu (⇒ 48, 66, 73)
This menu is used when playing or editing titles and still pictures, etc.
- ⑩ Skip the specified time (⇒ 40)
- ⑪ Colour buttons
Use in accordance with instruction on the screen.
- ⑫ Recording functions
 - [● REC] Start recording (⇒ 22)
 - [REC MODE] Change recording mode (⇒ 59)
- ⑬ Show teletext (⇒ 28, 40)
- ⑭ Show subtitles (Subtitles can be viewed if the digital broadcast programme has subtitles.) (⇒ 27)
- ⑮ Transmit the remote control signal
- ⑯ Television operations (⇒ 99)
- ⑰ Channel select/Change pages in the TV Guide system (⇒ 22, 38)
- ⑱ Show VIERA CAST (⇒ 78)
- ⑲ Input select (TV, AV1, AV2, AV3 or DV) (⇒ 20, 22, 59, 60)
- ⑳ Show Timer Recording screen (⇒ 35)
- ㉑ Exit the menu screen
- ㉒ Show the TV Guide screen (⇒ 20, 38)
- ㉓ Show FUNCTION MENU window (⇒ 13)
By using the FUNCTION MENU window you may access the main functions (playback, recording, etc.) quickly and easily.
- ㉔ Return to previous screen
- ㉕ Create chapter (⇒ 51)
- ㉖ Skip approx. 1 minute forward (⇒ 40)
- ㉗ Direct TV Recording (⇒ 76)
- ㉘ EXT LINK function (⇒ 59)
- ㉙ Show on-screen menu (⇒ 81)
- ㉚ Select audio (⇒ 27, 40)

Main unit

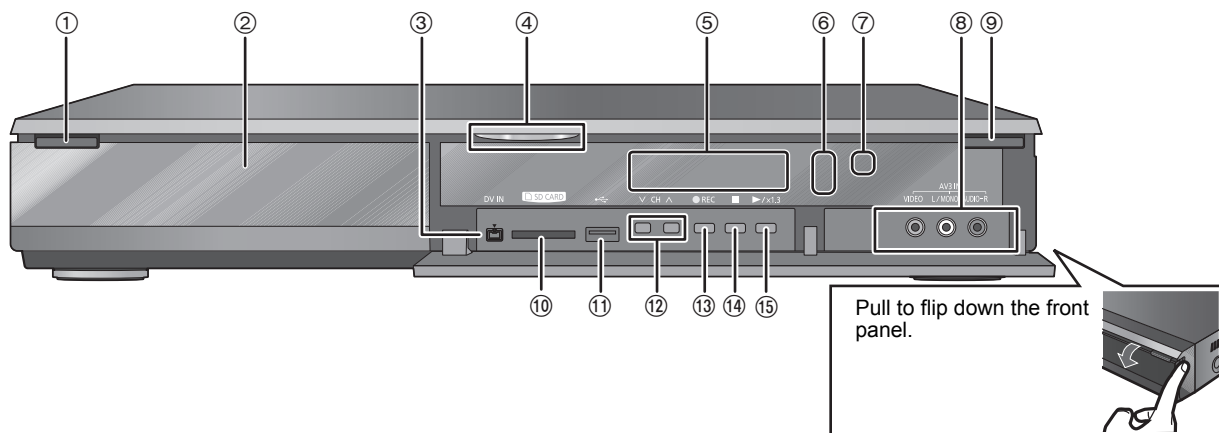

- ① Standby/on switch (⏻/⏻) (⇒ 18)
Press to switch the unit from on to standby mode or vice versa. In standby mode, the unit is still consuming a small amount of power.
- ② Disc tray (⇒ 15)
- ③ Connection for digital video (DV) camcorder (⇒ 60)
- ④ Blue LED
● It is possible to set the LED to turn on/off. (⇒ 92)
- ⑤ Display (⇒ 13)
- ⑥ Recording indicator
- ⑦ Remote control signal sensor
- ⑧ Connection for VCR, Panasonic's video camera, etc. (⇒ 60)
- ⑨ Open/close disc tray (⇒ 15)
- ⑩ SD card slot (⇒ 15)
- ⑪ USB port (⇒ 15)
- ⑫ Channel select (⇒ 20)
- ⑬ Start recording (⇒ 22)/Specify a time to stop recording (⇒ 22)
- ⑭ Stop (⇒ 22, 39)
- ⑮ Start play

Rear panel terminals (⇒ 17, 100–103)

The unit's display

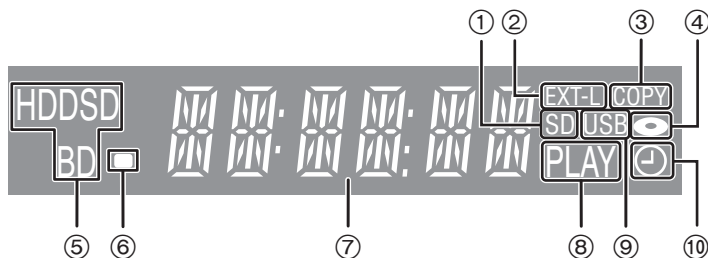

- ① SD card slot indicator
This indicator lights up when an SD card is inserted.
- ② Linked timer recordings with external equipment indicator
- ③ Copying indicator
- ④ Disc indicator
This indicator lights up when a disc is inserted.
- ⑤ Drive (HDD, BD or SD) indicator
Select "BD" for any discs. BD indicator will light up.
- ⑥ Remote control signal indicator
This flashes when it is operated by the remote control.
- ⑦ Main display section indicator
Current time/playback counter, various messages
- ⑧ Playback indicator
- ⑨ USB port indicator
This indicator lights up when a USB memory is inserted.
- ⑩ Timer recording indicator
This indicator lights up when the timer recording standby is activated.

Easy access to various functions — FUNCTION MENU display

You can access the main function quickly and easily.

Press [FUNCTION MENU].

- The FUNCTION MENU is displayed.

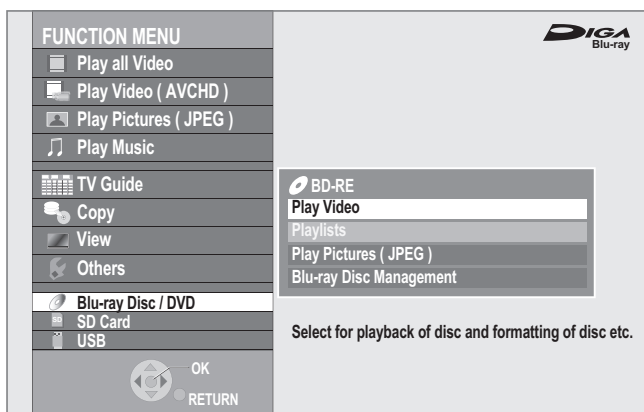

Select an item. **Press [OK].**

- You can access the main functions via either the above operations or repetition of the above operations.

Play all Video (⇒ 21)

Play Video (AVCHD) (⇒ 41)

Play Pictures (JPEG) (⇒ 64)

Play Music (⇒ 71)

TV Guide (⇒ 23)

Copy (⇒ 26)

View (⇒ 20)

- "View" is displayed when this unit is connected with the TV that supports "HDAVI Control 2" or later. (⇒ 76)

Others

Timer Recording (⇒ 35)

Ext Link Standby (⇒ 59)

Flexible Recording via AV input (⇒ 61)

DV Automatic Recording (⇒ 61)

Network (⇒ 78)

Setup (⇒ 87)

Blu-ray Disc / DVD

SD Card

USB

Select an operation that can be executed with media such as discs, SD cards, or USB devices.

- There are operations that cannot be performed when recording or when there is no media inserted. Those items are disabled for selection in such cases.

HDD (Hard disk drive) handling care

The HDD is a high precision recording instrument and because of its long recording capability and high speed operation it is a very special device that is easily susceptible to damage.

As a basic rule, save important content to a disc as backup.

■ The HDD is a device that is not built to withstand vibration/shock or dust

Depending on the setup environment and handling of the HDD some content may become damaged and play and recording may no longer be possible. Especially during operation, do not subject the unit to any vibration, shock, or remove the AC mains lead from the household mains socket. In the event of a power failure during recording or play, the content may be damaged.

■ The HDD is a temporary storage device

The HDD is not an everlasting storage device for recorded content. Use the HDD as a temporary storage place for one-off viewing, editing, or copying. It is recommended to save the recorded content on a disc or to keep the original data or CDs that they were copied from.

■ Immediately save (backup) all content as soon as you feel there may be a problem with the HDD

If there is an irregularity within the HDD, repetitive strange sounds or problems with picture (block noise, etc.) may result. Using the HDD in this condition may worsen the problem and in the worst case the HDD may no longer be usable. As soon as you notice this type of problem, copy all content to disc and request service. Recorded content (data) on a HDD that has become unusable is unrecoverable.

● When the unit is turned on or off, there may be an unexpected sound. This does not indicate a problem with this unit.

■ Setup precautions

● Do not place in an enclosed area where the rear cooling fan and the cooling vents on the side are covered up.

● Place the unit on a surface that is flat and not subject to vibration or impact.

● Do not place on anything that generates heat like a video cassette recorder, etc.

● Do not place in an area often subject to temperature changes.

● Place in an area where condensation does not occur. Condensation is a phenomenon where moisture forms on a cold surface when there is an extreme change in temperature. Condensation may cause internal damage to the unit.

● Conditions where condensation may occur

– When there is an extreme change in temperature (moving from a very hot location to a very cold location, or vice versa, or when subjected to an air conditioner or when cooled air directly impacts the unit). When the HDD (warms during operation) is subjected to cold air, condensation may form on the inside of the HDD and may cause damage to the HDD heads, etc.

– When there is high humidity or a lot of steam in the room.

– During the rainy season.

In the above situation, **without turning the unit on**, let the unit adjust to the room temperature and wait 2–3 hours until condensation is gone.

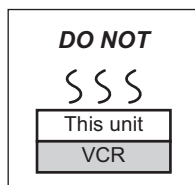

■ Cigarette smoke etc. causes malfunction or breakdown

The unit may breakdown if cigarette smoke or bug spray/vapor, etc. gets inside the unit.

■ While operating

● Do not move the unit or subject to vibration or impact. (The HDD may become damaged.)

● Do not remove the AC mains lead from the household mains socket, or flip the power breaker switch.

While the unit is on, the HDD is rotating at high speed. Sound or movement due to rotation is normal.

■ When moving the unit

- ① Turn the unit off. (Wait until "BYE" disappears from the display.)
- ② Remove the AC mains lead from the household mains socket.
- ③ Move only after the unit has come to a complete stop (approx. 2 minutes) in order to avoid subjecting to vibration and shock. (Even after turning the unit off, the HDD continues operating for a short time.)

■ Indemnity concerning recorded content

Panasonic does not accept any responsibility for damages directly or indirectly due to any type of problems that result in loss of recording or edited content (data), and does not guarantee any content if recording or editing does not work properly. Likewise, the above also applies in a case where any type of repair is made to the unit (including any other non-HDD related component).

Unit care

The precision parts in this unit are readily affected by the environment, especially temperature, humidity, and dust. Cigarette smoke also can cause malfunction or breakdown.

To clean this unit, wipe with a soft, dry cloth.

● Never use alcohol, paint thinner or benzine to clean this unit.

● Before using chemically treated cloth, carefully read the instructions that came with the cloth.

Observe the following points to ensure continued listening and viewing pleasure.

Dust and dirt may adhere to the unit's lens over time, making it impossible to record or play discs.

Use the **Lens cleaner** (not included) about once every year, depending on frequency of use and the operating environment. Carefully read the lens cleaner's instructions before use.

Lens cleaner: RP-CL720E

● This lens cleaner may not be for sale depending on the region.

DO NOT
Do not place the unit on amplifiers or equipment that may become hot.
The heat can damage the unit.

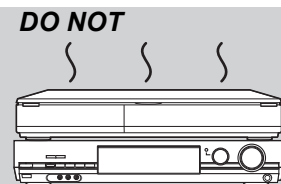

Note

Do not obstruct the rear panel's internal cooling fan.

Before moving the unit, ensure the disc tray is empty.
Failure to do so will risk severely damaging the disc and the unit.

Inserting discs

- Press [▲ OPEN/CLOSE] to open the tray.

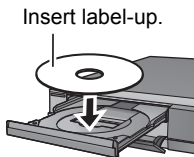

- Press [▲ OPEN/CLOSE] to close the tray.

Disc With a Cartridge

- BD-RE with a cartridge cannot be used with this unit. (It cannot be used even if it is taken out from the cartridge)
- Remove the DVD-RAM or 8 cm disc from the cartridge and place it on the tray. (TYPE1 cannot be used) Refer to the instructions on how to remove the disc from the cartridge.

- RAM** It is not possible to record or play continuously from one side of a double sided disc to the other. You will need to eject the disc and turn it over.

Inserting, removing the USB memory

Inserting the USB memory

When the USB indicator ("USB") on the unit's display is flashing, the USB memory is being read from. Do not turn off the unit or remove the USB memory. Such action may result in malfunction or loss of the USB memory's contents.

- Before inserting any USB memory to this unit, ensure that the data stored therein has been backed up.
- Check the orientation of the USB connector and insert it straight in.
- Insert a USB device while the unit is stopped, so the "USB" screen is displayed. Select an item and press [OK] to switch to the USB-related operations (⇒ 62, 63).

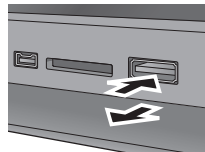

Removing the USB memory

- Complete all USB-related operations and pull the USB memory straight out.
- If a USB memory being accessed is pulled out, then the data may be damaged.

Inserting, removing the SD card

When the card indicator ("SD") on the unit's display is flashing, the card is being read from or written to. Do not turn off the unit or remove the card. Such action may result in malfunction or loss of the card's contents.

- Inserting foreign objects can cause a malfunction.

Inserting the card

Press on the centre of the card until it clicks into place.

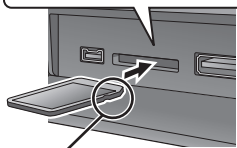

If you are using a miniSD card, a miniSDHC card, a microSD card or a microSDHC card, insert it into the adaptor that comes with the card. Insert and remove this adaptor from the unit.



Insert the card label up with the cut-off corner on the right.

Removing the card

- Press on the centre of the card.
- Pull it straight out.

Disc and card care

How to hold a disc or card

Do not touch the recorded surface or the terminal surface.

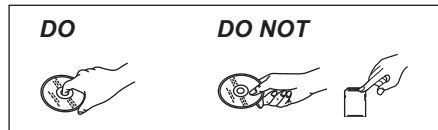

If there is dirt or condensation on the disc

Wipe with a damp cloth and then wipe dry.



Handling precautions

- Do not attach labels or stickers to discs. (This may cause disc warping and unbalanced rotation, rendering it unusable.)
- Write on the label side of the disc only with a soft, oil-based felt pen. Do not use ballpoint pens or other hard writing implements.
- Do not use record cleaning sprays, benzene, thinner, static electricity prevention liquids or any other solvent.
- Do not use scratch-proof protectors or covers.
- Do not expose the terminals of the card to water, garbage or other strange things.
- Do not drop stack, or impact discs. Do not place objects on them.
- Do not use the following discs:
 - Discs with exposed adhesive from removed stickers or labels (rental discs, etc.).
 - Discs that are badly warped or cracked.
 - Irregularly shaped discs, such as heart shapes.

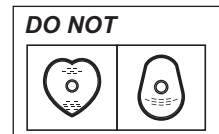

- Do not place in the following areas:
 - In direct sunlight.
 - In very dusty or humid areas.
 - Near a heater.
 - Locations susceptible to significant difference in temperature (condensation can occur).
 - Where static electricity or electromagnetic waves occur.
- To protect discs from scratches and dirt, return them to their cases when you are not using them.

The manufacturer accepts no responsibility and offers no compensation for loss of recorded or edited material due to a problem with the unit or recordable media, and accepts no responsibility and offers no compensation for any subsequent damage caused by such loss.

Examples of causes of such losses are

- A disc recorded and edited with this unit is played in a Blu-ray Disc Recorder or computer disc drive manufactured by another company.
- A disc used as described above and then played again in this unit.
- A disc recorded and edited with a Blu-ray Disc Recorder or computer disc drive manufactured by another company is played in this unit.

STEP 1 Inserting the CAM (Conditional Access Module) and Smart Card

You need a Conditional Access Module together with a valid Smart Card and a subscription with the corresponding broadcaster.

① Insert the certified Smart Card into the commercially available CAM (Conditional Access Module).

② Insert the CAM into the CI (Common Interface) slot of this unit.

TV service encryption is automatically cancelled and the service can be viewed or recorded.

● You can insert one or two different CAMs with Smart Cards into this unit.

However, it will not operate properly when two CI Plus compatible CAMs are simultaneously inserted.

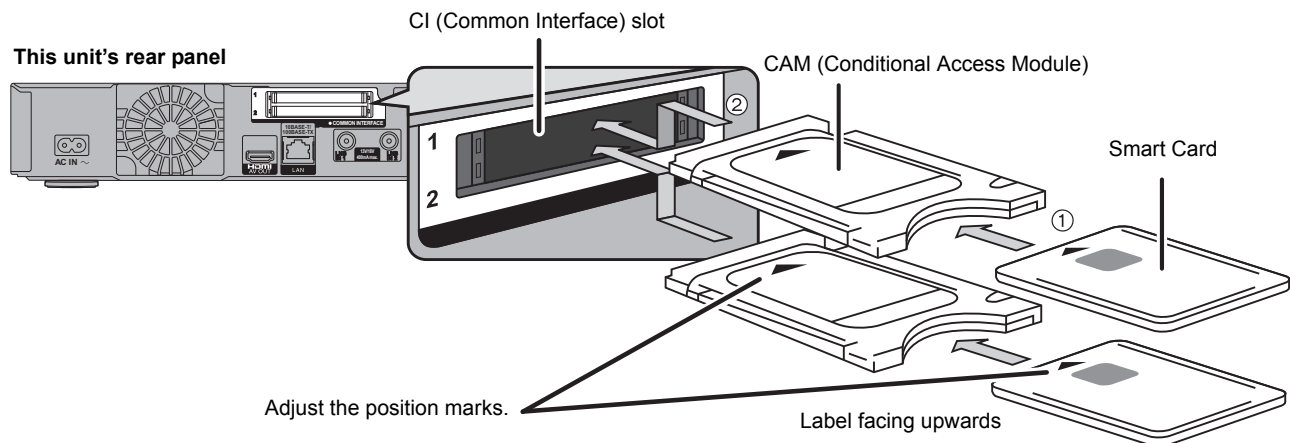

■ PIN query

When you turn the unit on after inserting the card, depending on the card provider, a PIN may be demanded. Enter the 4-digit code with the numbered buttons.

Note

- Be sure to insert the CAM horizontally into the slot.
- Do not insert the CAM and Smart Card upside down.
- For more details, see the manual of the CAM and Smart Card, or consult the dealer.
- The Common Interface supports the modules according to DVB Specification and CI Plus Specification.
- Unplug the AC mains lead before you insert or remove the CAM with Smart Card. Remove it slowly.

STEP 2 Connection

- Before connection, turn off all equipment and read the appropriate operating instructions.
- Refer to “Additional connections” (⇒ 100) for connection using other terminals and connection with other equipment.
- Refer to “Network connection” (⇒ 103) for connection network.
- Confirm connections not listed below with your dealer.

Satellite cable

- Connect both satellite terminals (LNB IN 1 and LNB IN 2) to the satellite dish when you want to record 2 programmes simultaneously or view TV during recording.
- Connect LNB IN 1 terminal to the satellite dish when you use only one terminal. (You cannot view if you connect only LNB IN 2 terminal.) In this case, you cannot record 2 programmes simultaneously or view TV during recording.
- Supply power from another device when you use 2 or more devices to receive satellite broadcast, because this unit does not supply power when it is turned in standby.

To household mains socket
(AC 220 to 240 V, 50 Hz)

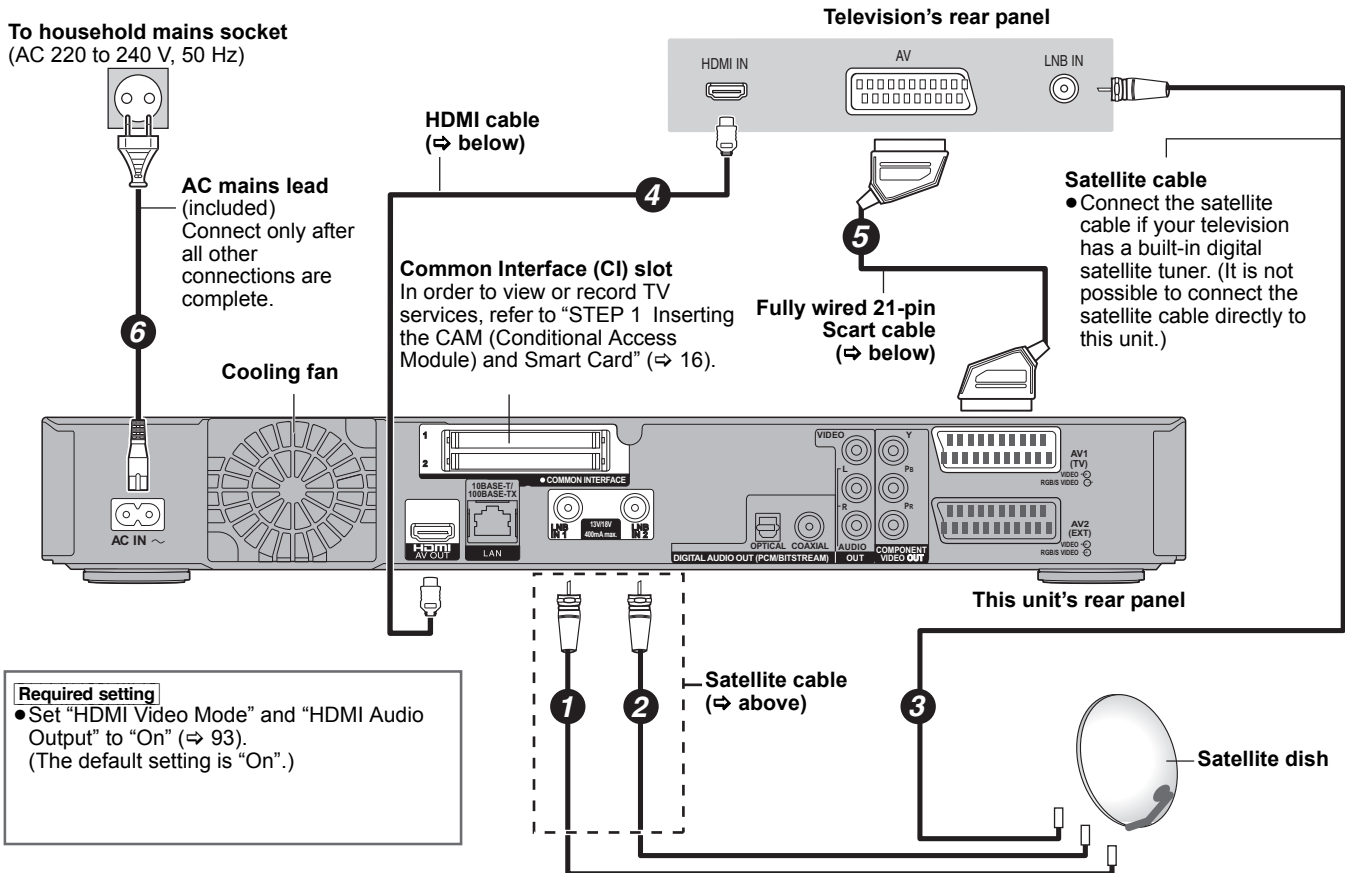

Required setting
 • Set “HDMI Video Mode” and “HDMI Audio Output” to “On” (⇒ 93).
 (The default setting is “On”.)

- Even when your television does not have an HDMI input terminal, you still can view only with the 21-pin Scart cable connection (5) (However, functions such as the “HDAVI Control™” function cannot be used.)

When the unit is not to be used for a long time

To save power, unplug it from the household mains socket. This unit consumes a small amount of power, even when it is turned off
[approx. 0.3 W (“Power Save” is set to “On”)]

Using a HDMI cable

When connected to an HDMI compatible unit, an uncompressed digital audio and video signal is transmitted. You can enjoy high quality, digital video and audio with just one cord. When connecting to an HDMI-compatible HDTV (High Definition Television), the output can be switched to 1080p, 1080i or 720p HD video.

- This unit incorporates HDMI™ (V.1.3a with Deep Colour, x.v.Colour™, High Bit Rate Audio) technology (⇒ 118, 119).
- Video sources converted to 1920×1080 resolution, while of high quality, will exhibit somewhat lower subjective image resolution than true, native 1080p full-HD sources. See dealer for details.
- Please use High Speed HDMI Cables that have the HDMI logo (as shown on the cover).
- When outputting 1080p signal, please use HDMI Cables 5.0 meters or less.

Regarding VIERA Link “HDAVI Control™” function

When connecting with a Panasonic TV (VIERA) or a receiver equipped with the “HDAVI Control” function, linked operations would be possible.
 [⇒ 76, Linked operations with the TV (VIERA Link “HDAVI Control™/Q Link)]

- Non-HDMI-compliant cables cannot be utilised.
- It is recommended that you use Panasonic’s HDMI cable.

Recommended part number:
 RP-CDHS15 (1.5 m), RP-CDHS30 (3.0 m), RP-CDHS50 (5.0 m), etc.

Note

- If you are connecting to a TV that is only compatible with 2 channel audio output, audio with 3 channels or more will be down mixed (⇒ 118) and output as 2 channels, even if connecting with an HDMI cable. (Some discs cannot be down mixed.)
- You cannot connect this unit to DVI devices that are incompatible with HDCP.
 For units compatible with HDCP (High-Bandwidth Digital Content Protection) copyright protection that are equipped with a digital DVI input terminal (PC monitors, etc.):
 Depending on the unit, images may not display properly or at all when connecting with a DVI/HDMI switching cable. (Audio cannot be output.)

Using a 21-pin Scart cable

You can use a variety of Q Link functions by connecting the unit to a Q Link compatible television (⇒ 76).

You can enjoy high-quality viewing [standard definition (SD) quality] by connecting the unit to an RGB compatible television (⇒ 119).

- Set “AV1 Output” in the Setup menu (⇒ 94)

If the 21-pin Scart cable is connected with a Panasonic TV (VIERA), the following functions are available.

- Direct TV Recording (⇒ 76)
- Pause Live TV programme (⇒ 77)

STEP 3 Channel reception settings and TV aspect settings

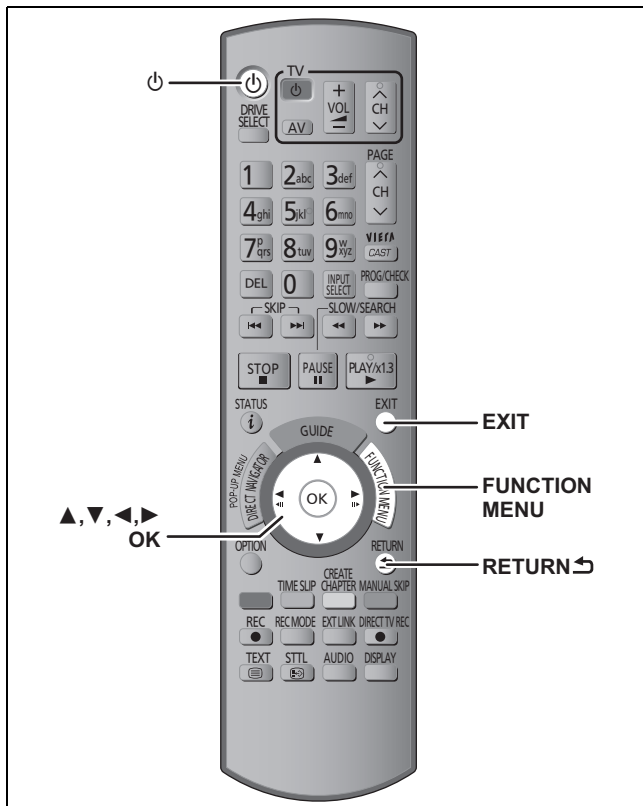

- 1 Turn on the television and select the appropriate AV input to suit the connections to this unit.**
- 2 Press [⏻] to turn the unit on.**
Language setting screen appears on the television.
- 3 Press [▲, ▼] to select the language and press [OK].**
Country setting screen appears on the television.
- 4 Press [▲, ▼] to select the country and press [OK].**
Dish Setup screen appears on the television.
- 5 Press [▲, ▼] to select the number of cables to connect and press [OK].**
(⇒ 22, About 2 programmes recorded simultaneously)
 - Two cables (Same signal):
Select this item when connecting two cables outputting same signal to both LNB IN 1 and LNB IN 2.
 - One cable:
Select this item when connecting only one cable to LNB IN 1.
 Search Mode screen appears on the television.

6 Press [◀, ▶] to select the Search Mode.

- All Channels:
Search for all channels.
- Free Channels:
Search for free channels only.

7 Press [OK].

Auto Setup starts.

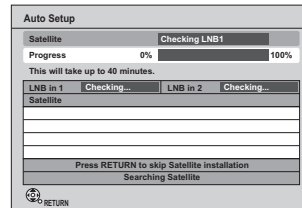

Searching Satellite → Searching Channels

- These operations may take some time.
- After Auto Setup is complete, the time information can be obtained and Power Save setting screen appears.

8 Press [▲, ▼] to select “On” or “Off” and press [OK].

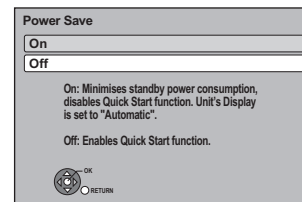

- On:
It will go into the Power Save mode when the power is turned off.
- Off:
It is possible to start quickly from standby mode.

The features of the power save function when the unit is in standby mode are as follows.

Power Save	On*1	Off*2
Power consumption	Approx. 0.3 W	Approx. 7 W
Start up time	Not Quick	Quick*3

- *1 “Unit’s Display” is fixed to “Automatic” in the Setup menu. (⇒ 92)
- *2 “Unit’s Display” is changed to “Bright” in the Setup menu.
- *3 It is possible to startup and start recording within several seconds.
– Depending on the type of TV or the connected terminal, it may take time to display the screen.

After Power Save setting is complete, TV aspect setting screen appears.

9 Press [▲, ▼] to select the TV aspect and press [OK].

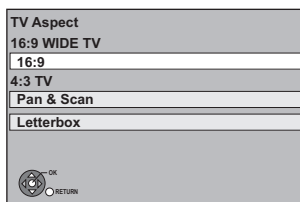

- If the clock setting menu appears (⇒ 95, Clock)
- To confirm that stations have been tuned correctly (⇒ 87, Channel List)
- To restart set up (⇒ 87, Auto Setup)

●16:9:

When connected to a 16:9 widescreen television

●Pan & Scan:

When connected to a 4:3 aspect television, side picture is trimmed for 16:9 picture. This setting may not work and the pictures may be shown in the letterbox style depending on the content.



●Letterbox:

When connected to a 4:3 aspect television. 16:9 picture is shown in the letterbox style.



When television picture appears, set up is complete.

To stop partway

Press [RETURN ↵].

STEP 4 Setting the CI or CI Plus (Common Interface)

- 1 Press [FUNCTION MENU].
- 2 Press [▲, ▼] to select “Others” and press [OK].
- 3 Press [▲, ▼] to select “Setup” and press [OK].
- 4 Press [▲, ▼] to select “Connection” and press [OK].
- 5 Press [▲, ▼] to select “Common Interface” and press [OK].

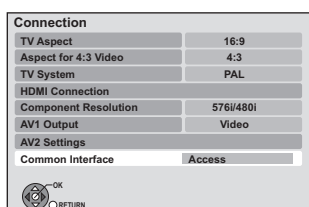

6 Press [▲, ▼] to select “Slot 1:” or “Slot 2:” and press [OK].

The features that appear on screen are dependent on the contents of the inserted CAM and Smart Card. Follow the on-screen instructions.

- On-screen instructions may not correspond to the remote control buttons.

To return to the previous screen

Press [RETURN ↵].

To exit the screen

Press [EXIT].

- For more information about TV service, please contact your service provider.

Note

- Other settings on the card, e.g. changing the password, can be adjusted in the Setup menu. (⇒ 94)
- Depending on the card, in some cases its use together with this unit may be limited or not possible.

Refer to “Advanced watching digital broadcasts” (⇒ 27).

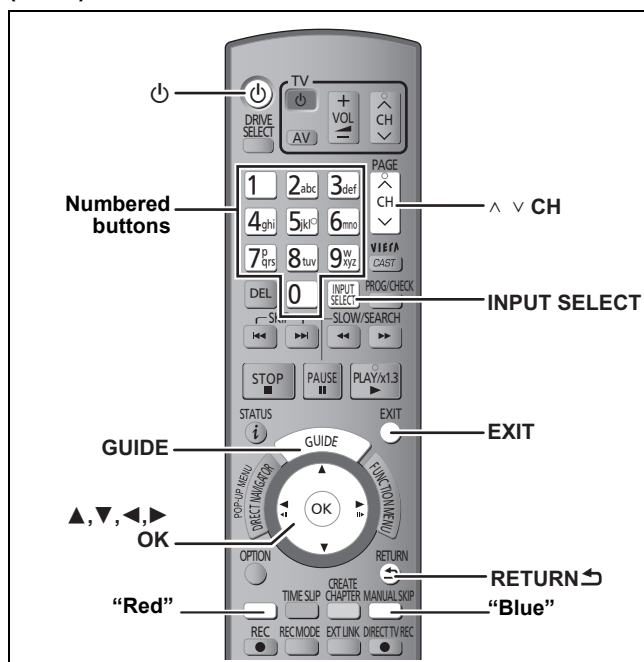

This unit has the tuner which allows it to directly receive and record digital satellite channels.

- 1 Turn on the television and select the appropriate AV input to suit the connections to this unit.
- 2 Press [POWER] to turn the unit on.
- 3 Press [INPUT SELECT] a few times and select “TV”.

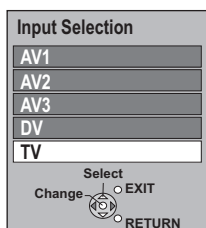

- It will switch when the display disappears. (It will switch faster by pressing [OK])

- 4 Press [^ v CH] to select the channel. Everytime you change the station, digital channel information appears automatically. The length of time the digital channel information is displayed can be changed. (⇒ 92, On-Screen Messages)

Unit's display;



- You can also select the channel with the numbered buttons.
e.g.,
5: [0] ⇒ [0] ⇒ [0] ⇒ [5]
15: [0] ⇒ [0] ⇒ [1] ⇒ [5]
115: [0] ⇒ [1] ⇒ [1] ⇒ [5]
1115: [1] ⇒ [1] ⇒ [1] ⇒ [5]

■ Select the station from Channel List

Selection of channel is made easy by creating a Favourite of the channels you watch often. (⇒ 87, Favourites Edit)

After performing steps 1–3 (⇒ left)

1 Press [OK].

Channel List is displayed.

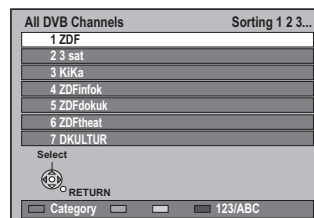

- Press the “Red” button to select the “Category”.
- Press the “Blue” button to change the sorting mode.

2 Press [▲, ▼] to select the station and press [OK].

■ Select the programme to view using the TV Guide

Selection of channel is made easy by creating a Favourite of the channels you watch often. (⇒ 87, Favourites Edit)

After performing steps 1–3 (⇒ left)

1 Press [GUIDE].



- Some digital broadcast may not send programme information.

To select channel in Category.

- ① Press the “Blue” button to display the list of category.
- ② Press [▲, ▼] to select the desired item and press [OK].

Operations in the TV Guide system (⇒ 38)

2 Press [▲, ▼, ◀, ▶] to select the programme to view and press [OK].

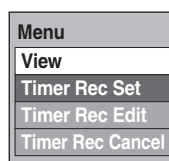

- This is displayed only when the programme currently broadcasting is selected.

3 Press [▲, ▼] to select “View” and press [OK].

To return to the previous screen

Press [RETURN ↵].

To exit the screen

Press [EXIT].

Refer to “Advanced playback” (⇒ 39) for detail information.

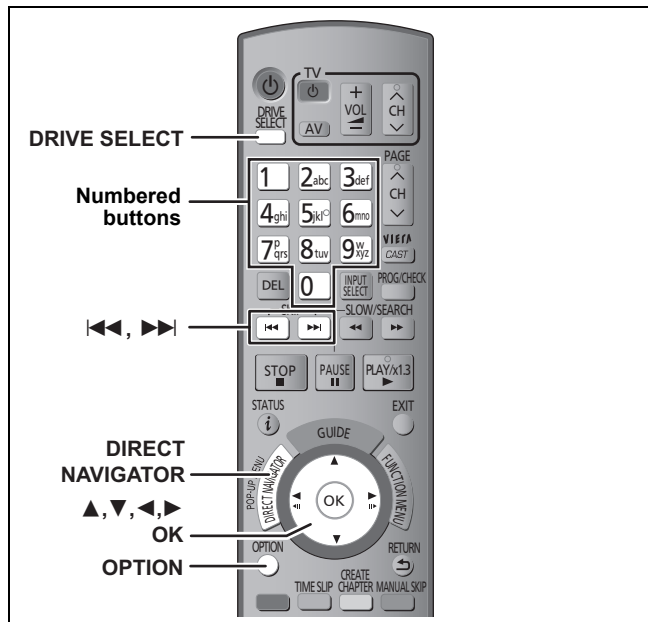

Preparation

- Turn on the television and select the appropriate video input to suit the connections to this unit.
- Turn on this unit.

Playing BD-Video or DVD-Video

- 1 Press [**▲ OPEN/CLOSE**] on the main unit to open the tray and insert a disc.
 - Press the button again to close the tray.
 - Play starts from the point specified by the disc.
- 2 When a menu screen appears on the television Press [**▲, ▼, ◀, ▶**] to select the item and press [**OK**].

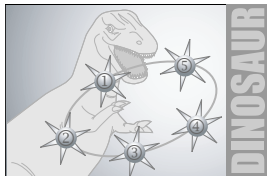

- Some items can also be selected using the numbered buttons.
- If you are instructed to press the “ENTER” button by the menu screen or the disc’s instruction document, press [**OK**].

BD-V

To display Pop-up Menu

While playing

Press [**DIRECT NAVIGATOR**].

- Press [**DIRECT NAVIGATOR**] to exit the Pop-up Menu.

To display Top Menu

BD-V

While playing

1 Press [**OPTION**].

2 Press [**▲, ▼**] to select “Top Menu” and press [**OK**].

While stopped

Press [**DIRECT NAVIGATOR**].

DVD-V

1 Press [**OPTION**].

2 Press [**▲, ▼**] to select “Top Menu” and press [**OK**].

- You can also press [**DIRECT NAVIGATOR**] to return to the menu screen.

Note

BD-V You cannot playback while recording from external equipment. Also, it will stop the playback when the timer recording from external equipment starts during the playback.

Playing recorded video contents

HDD **BD-RE** **BD-R** **RAM** **-R** **-R DL** **-RW(V)** **+R** **+R DL** **+RW** **-RW(VR)**

You can quickly find the recorded titles and easily play them.

Following screen is displayed when recordable disc is inserted.

e.g.,

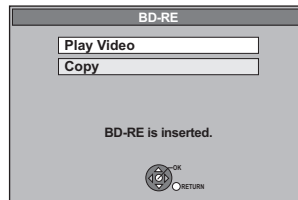

Press [**▲, ▼**] to select “Play Video” and press [**OK**]. It will go to step 3 (⇒ below).

- 1 Press [**DRIVE SELECT**] to select the HDD or BD drive.

The HDD or BD indicator lights up on the unit’s display.

- Select “BD” for any discs. BD indicator will light up.

- 2 Press [**DIRECT NAVIGATOR**].

e.g., **HDD**

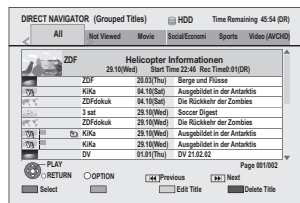

- 3 Press [**▲, ▼**] to select the title and press [**OK**].

To show other pages

Press [**◀, ▶**].

Regarding **DIRECT NAVIGATOR** (⇒ 41)

To exit the screen

Press [**DIRECT NAVIGATOR**].

Refer to “Advanced recording” (⇒ 29–32) for detail information.

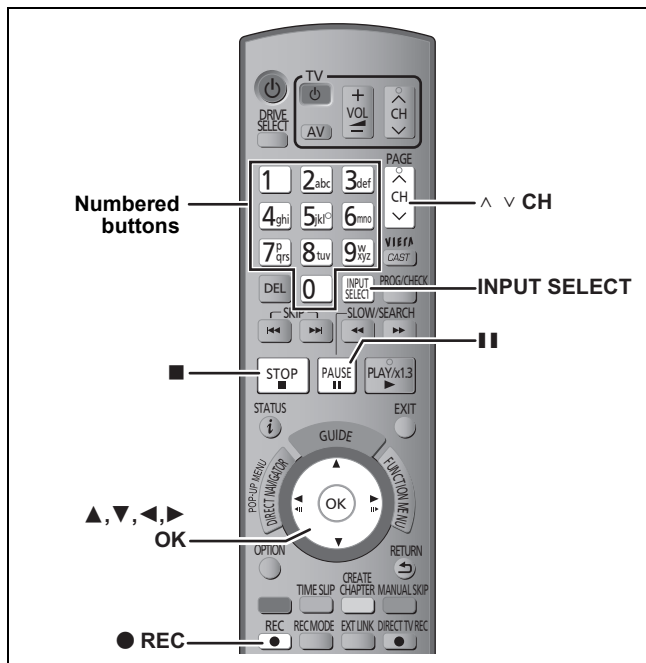

This operation will only record to HDD in DR mode.

Preparation

- Turn on the television and select the appropriate video input to suit the connections to this unit.
- Turn on this unit.

- 1 Press [INPUT SELECT] a few times and select “TV” and press [OK].
- 2 Press [^ v CH] to select the channel.
 - To select with the numbered buttons. (⇒ 20)
 - To select the station from channel List. (⇒ 20)
- 3 Press [● REC] to start recording.

“REC1” or “REC2” will light

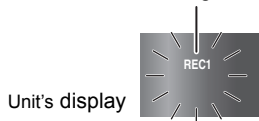

Recording will take place on open space on the HDD. Data will not be overwritten.

- When [● REC] is pressed while a drive other than the HDD is selected, it will automatically switch to HDD and start the recording.

- 4 To stop recording

Press [■].

If the following screen appears

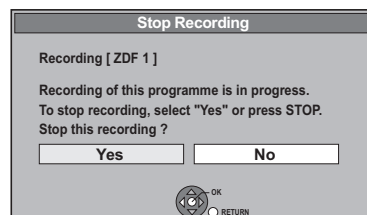

Press [◀, ▶] to select “Yes” and press [OK].

■ To pause recording

Press [||].

Press again to restart recording. You can also press [● REC] to restart. (Title is not split into separate titles.)

■ About 2 programmes recorded simultaneously

There are the following differences during recording depending on the number of antenna cables connected (⇒ 17).

(○: Possible, –: Impossible)

Connection	Broadcast being recorded	Second broadcast being recorded or viewed during recording	
		Unencrypted broadcast	Encrypted broadcast*
Two cables (Same signal)	Unencrypted broadcast	○	○
	Encrypted broadcast*	○	–
One cable	Unencrypted broadcast	–	–
	Encrypted broadcast*	–	–

* To view or record an encrypted broadcast, a CAM (Conditional Access Module) with Smart Card valid for the broadcast is required.

■ To record 2 programmes simultaneously (⇒ 34)

When recording digital broadcast with subtitles, multiple audio or Teletext

If a programme to record has subtitle, multiple audio or Teletext, all subtitles, multiple audio and Teletext are recorded. It can be switched while playing back the title.

To specify a time to stop recording—One Touch Recording

During recording

Press [● REC] on the main unit to select the recording time.

- You can specify up to 4 hours later.
- The unit display changes as shown below.
OFF 0:30 → OFF 1:00 → OFF 1:30 → OFF 2:00
↑ Counter (cancel) ← OFF 4:00 ← OFF 3:00 ↓

- The unit turns off automatically after the time to stop recording is reached.
- This does not work during timer recordings (⇒ 23, 35) or while using Flexible Recording via AV input (⇒ 61).

To cancel

Press [● REC] on the main unit several times until the counter appears.

- The time to stop recording is cancelled; however, recording continues.

To stop recording

Press [■].

■ Refer to “Operation during Recording” (⇒ 34) for detail information.

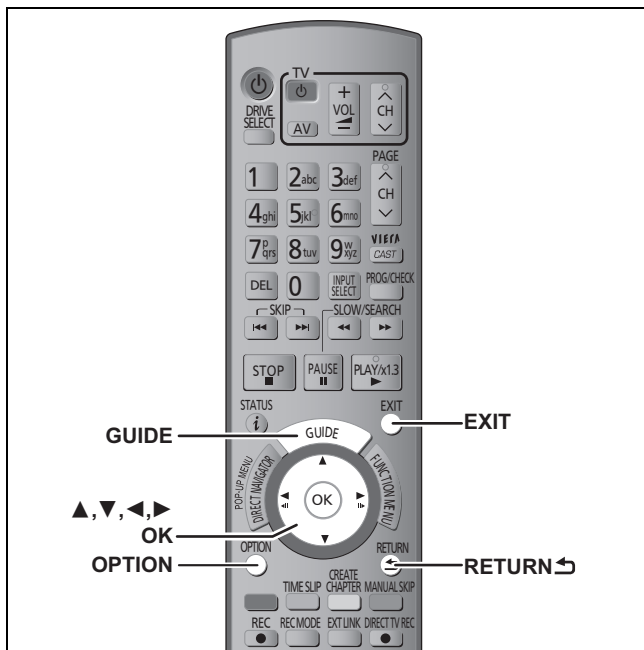

Timer Recording using the TV Guide system

HDD

This operation will only record to HDD in DR mode.

TV Guide system provides programme information only from the digital broadcasts station displayed on the television like a TV programme magazine.

Selection of channel is made easy by creating a Favourite of the channels you watch often. (⇒ 87, Favourites Edit)

• You can enter up to 64 programmes up to a month in advance. (Each daily or weekly programme is counted as one programme.)

Preparation

- Turn on the television and select the appropriate video input to suit the connections to this unit.
- Turn on this unit.
- Make sure that the clock settings are correct (⇒ 95).

Note

- TV Guide does not work if the clock is not set correctly.
- If "NTSC" has been selected for "TV System" (⇒ 93), the TV Guide system cannot be used.
- The receipt of the TV Guide system data is only possible via the satellite input of this unit. The receipt of the TV Guide data via externally connected Set Top Box is not possible.
- To record an encrypted broadcast, a CAM (Conditional Access Module) with Smart Card valid for the broadcast is required.

1 Press [GUIDE].



2 Press [▲, ▼, ◀, ▶] to select the future programme and press [OK].

- Following screen is displayed when the programme currently broadcasting is selected.

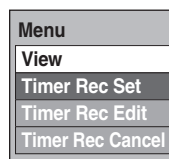

Press [▲, ▼] to select "Timer Rec Set" and press [OK].

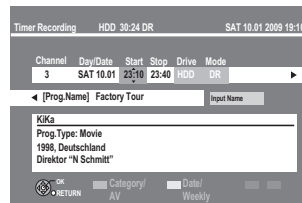

- Confirm the programme (start and end time) by using a TV magazine, etc. and make corrections if necessary using [▲, ▼, ◀, ▶] (⇒ 35, step 3).
- In order to make the timer recording work successfully, using the TV Guide system, the start recording time and finish recording time can be set to a margin of up to 10 minutes. (⇒ 90, Start Recording Time, Finish Recording Time)

3 Press [OK].

The timer programme is stored and the timer icon (red) is displayed.

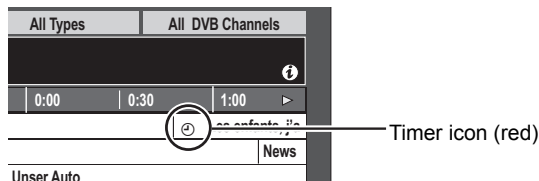

“⌚” lights on the unit's display to indicate timer recording standby has been activated.

To return to the previous screen

Press [RETURN ↵].

To exit the screen

Press [EXIT].

■ To cancel a timer recording on the TV Guide screen

- 1 Press [▲, ▼, ◀, ▶] to select the programme in the TV Guide and press [OK].
- 2 Press [◀, ▶] to select “Yes” and press [OK]. (“☺” in the TV Guide disappears.)

■ To modify the timer recording on the TV Guide screen

- 1 Press [▲, ▼, ◀, ▶] to select the programme in the TV Guide and press [OPTION].

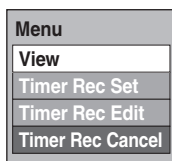

- 2 Press [▲, ▼] to select “Timer Rec Edit” and press [OK]. (⇒ 35, step 3)

■ When the TV Guide displays the empty TV Guide list

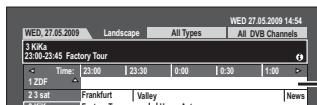

- Some digital broadcast may not send programme information. Set the timer recording manually (⇒ 35).

- Manually programming timer recording (⇒ 35)
- To set the daily or weekly timer recording (⇒ 35)
- To release the unit from timer recording standby (⇒ 36)
- To cancel recording when timer recording has already begun (⇒ 36)
- About 2 programmes recorded simultaneously (⇒ 22)
- Notes on timer recording (⇒ 37)

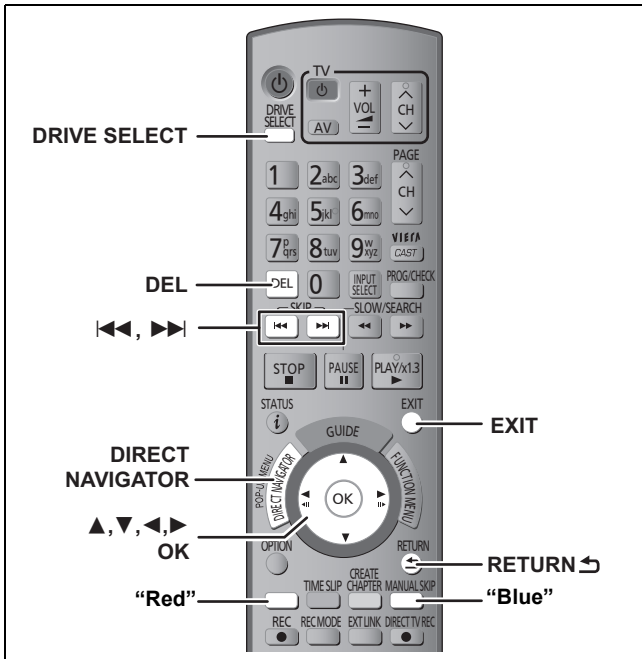

HDD BD-RE BD-R RAM -R -R DL -RW(V) +R +R DL +RW
 (You cannot delete items on finalised discs.)

- A title cannot be restored once it is deleted. Make certain before proceeding.
- Title that is currently recording cannot be deleted.
- Titles on the disc cannot be deleted in the following cases:
 - While recording to disc
 - While high speed copying

Preparation

- Press [DRIVE SELECT] to select the HDD or BD drive. Select "BD" for any discs. BD indicator will light up.
- **BD-RE BD-R RAM** Release protection (⇒ 84, Setting the protection).

Available disc space after deleting

- **HDD BD-RE RAM** The space deleted becomes available for recording.

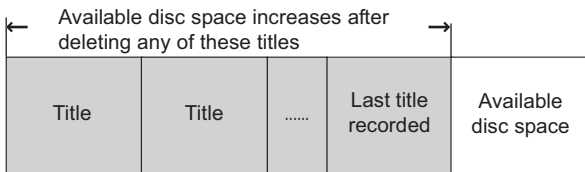

- **-RW(V) +RW** Available recording space increases only when the last recorded title is deleted.

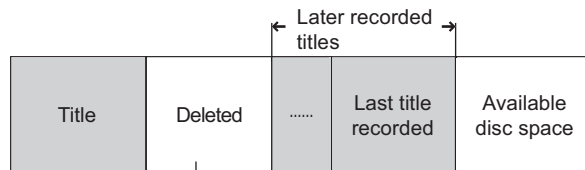
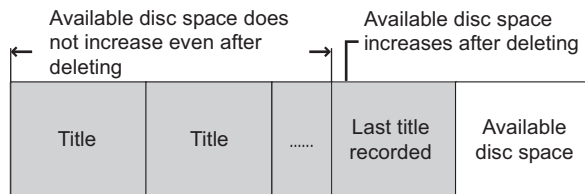

This space become available for recording after all the later recorded titles are deleted.

- **BD-R -R -R DL +R +R DL** Available space does not increase even after the contents are deleted.

- 1 While stopped
Press [DIRECT NAVIGATOR].

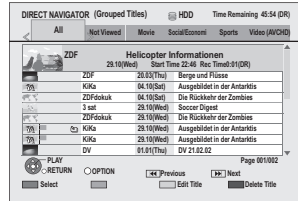

- 2 Press [▲, ▼] to select the title and press the "Red" button.
A check mark is displayed. Repeat this step until you select all items you wish to delete.
• Press the "Red" button again to cancel.

To show other pages
Press [◀, ▶].

You can confirm the titles that you have selected using the option menu. (⇒ 49, Properties)

- 3 Press the "Blue" button.
- 4 Press [◀, ▶] to select "Delete" and press [OK].
The title is deleted.

To return to the previous screen
Press [RETURN ↵].

To exit the screen
Press [EXIT].

Deleting during play

- 1 While playing
Press [DEL].
- 2 Press [◀, ▶] to select "Delete" and press [OK].
The title is deleted.

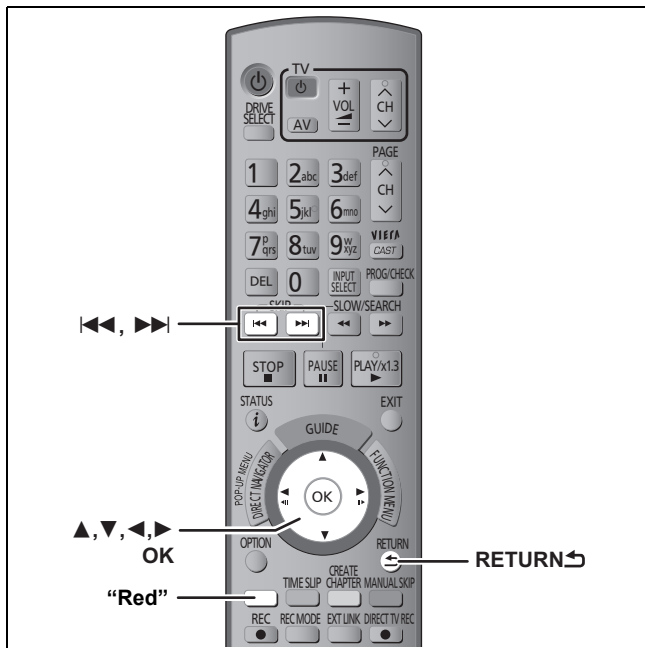

HDD → **BD-RE** **BD-R** **RAM** **-R** **-R DL** **-RW(V)** **+R** **+R DL** **+RW**

(You cannot copy to finalised discs.)

• About copyright protected titles (⇒ 31, 53)

1 Insert a disc.

e.g.,



2 Press [▲, ▼] to select “Copy” and press [OK].

• Confirm that there is enough remaining disc space.

3 Set the copy direction.

- ① Press [▲, ▼] to select “Copy Direction” and press [▶].
- ② Press [▲, ▼] to select “Source” and press [OK].
- ③ Press [▲, ▼] to select “HDD” and press [OK].
- ④ Press [◀] to confirm.

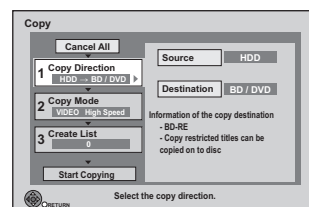

4 Set the recording mode.

- ① Press [▲, ▼] to select “Copy Mode” and press [▶].
- ② Press [▲, ▼] to select “Format” and press [OK].
- ③ Press [▲, ▼] to select “VIDEO” and press [OK].
- ④ Press [▲, ▼] to select “Recording Mode” and press [OK].
- ⑤ Press [▲, ▼] to select the mode and press [OK].
- ⑥ Press [◀] to confirm.

5 Register titles for copy.

- ① Press [▲, ▼] to select “Create List” and press [▶].

- ② Press [▲, ▼] to select “New item” and press [OK].

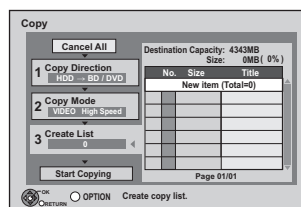

- ③ Press [▲, ▼] to select the title and press the “Red” button.

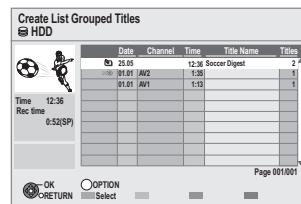

A check mark is displayed. Repeat this step until you select all necessary items.

- Press the “Red” button again to cancel.
- The items will be copied in the order of the copying list. If you want to specify the order, repeat selecting one item at a time.

- Titles indicated with “▶▶⊗” can not be copied in high speed mode.

- To show other pages

Press [◀◀, ▶▶].

- ④ Press [OK].

- ⑤ Press [◀] to confirm.

6 Set other settings.

- ① Press [▲, ▼] to select “Other Settings” and press [▶].

“Subtitles”

(Only when copying titles in DR mode and the recording mode other than High Speed is selected)

- ② Press [▲, ▼] to select “Subtitles” and press [OK].

- ③ Press [▲, ▼] to select “Automatic” or “Off” and press [OK].

- If “Automatic” is selected

Subtitle in the source titles will be copied.

- If “Off” is selected

Subtitle in the source titles will not be copied.

“Finalise” or “Create Top Menu”

(HDD → **-R** **-R DL** **-RW(V)** **+R** **+R DL** **+RW** only)

- ② Press [▲, ▼] to select “Finalise” or “Create Top Menu” and press [OK].

- ③ Press [▲, ▼] to select “On” or “Off” and press [OK].

- If “On” is selected

– **-R** **-R DL** **-RW(V)** **+R** **+R DL** After finalising, the discs become play-only and you can also play them on other DVD equipment. However, you can no longer record or edit.

– **+RW** Create the Top Menu. Top Menu is a convenient function. We recommend you create the menu before playing a +RW disc on other equipment.

- ④ Press [◀] to confirm.

7 Press [▲, ▼] to select “Start Copying” and press [OK].

8 Press [◀, ▶] to select “Yes” and press [OK] to start copying.

To return to the previous screen in step 1 to 7

Press [RETURN ↵].

To stop copying

Press and hold [RETURN ↵] for 3 seconds.

(You cannot stop while finalising or creating Top Menu)

■ Copying list icons and functions (⇒ 57)

Note

- Titles in the grouped titles and other titles cannot be registered simultaneously.
- Titles recorded using a different encoding system (PAL or NTSC) from the TV system currently selected on the unit cannot be copied.

Advanced watching digital broadcasts

There are various services included in the digital broadcasts depending on the programme. You can confirm or set these services with the following operations.

Digital channel information

While stopped

Press [STATUS ①].

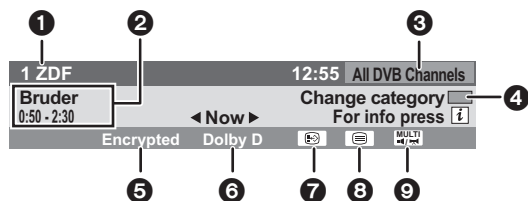

- ① Channel and Station Name
- ② Programme name and Broadcast time
- ③ Current category
- ④ Change the category
- ⑤ Encrypted broadcast
- ⑥ Audio format (⇒ below)
- ⑦ Subtitle (⇒ right)
- ⑧ Teletext (⇒ 28)
- ⑨ Multiple audio/Sub Channel (⇒ 28)

To switch information of the current programme and the next programme

Press [◀, ▶].

To show detailed information about the programme

Press [STATUS ①] again.

To hide the information screen

Press [STATUS ①] once or twice.

Note

You can also select the other channel by pressing [▲, ▼] and [OK] when the information screen is displayed.

Audio format of the programme

There are programmes that use Dolby Digital Plus, Dolby Digital, or MPEG audio formats with the digital broadcasting. You can enjoy these audio format programmes in high quality by connecting to an amplifier.

To set the output of the audio

Set either "Bitstream" or "PCM" for "Dolby D/Dolby D +/Dolby TrueHD", "DTS/DTS-HD" or "MPEG" in the "Digital Audio Output" (⇒ 91).

To show subtitle

Press [STTL ②].

- Press again to hide the subtitle.

Switching audio of the TV broadcast

Press [AUDIO].

- Audio will switch according to the contents of the programme every time it is pressed.

e.g.,

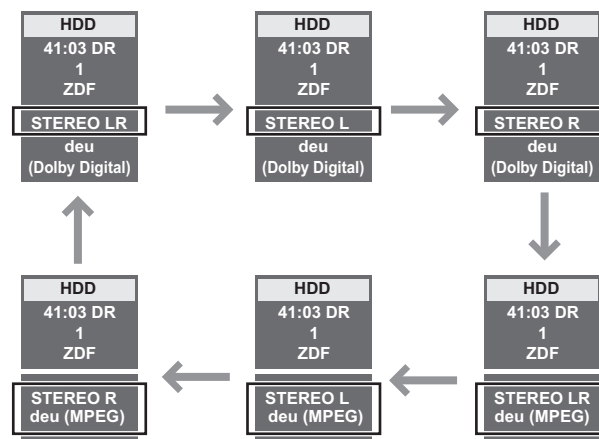

Note

You can not change the audio channel (L, R) when "Rec for High Speed Copy" is set to "On". (⇒ 90)

To select content in the digital broadcast

When a programme of a digital broadcast includes audio signals, subtitle and sub channel, you can use the following operations to select signals.

- 1 Press [OPTION].
- 2 Press [▲, ▼] to select the "Multi Audio", "Sub Channel" or "Subtitle Language" and press [OK].

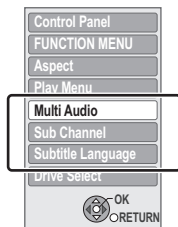

- Multi Audio can also be selected with the [AUDIO] button. (⇒ 27)

- 3 Press [◀, ▶] to select the setting.

- When there is only one setting available, you cannot select between items.

To exit the screen

Press [EXIT].

To show Teletext

You can enjoy teletext broadcasting, including news, weather forecasts and subtitles, if this service is provided by the broadcasters.

When "☺" appears in digital channel information (⇒ 27)

- 1 Press [TEXT☺].

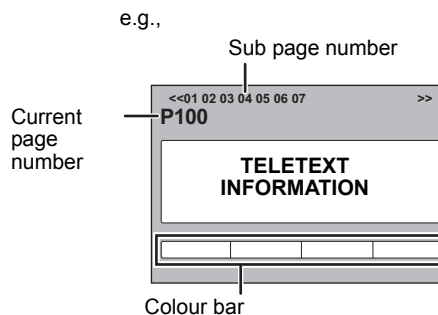

- 2 Press [▲, ▼], the numbered buttons, or the colour buttons to select the page.

Follow the instruction on the screen to select the page.

To show the sub page

(only when there are sub pages)
Press [◀, ▶].

Change the Teletext mode

"Teletext" of the Setup menu can be changed to following modes. (⇒ 92)

• FLOF (FASTTEXT) mode

Four differently coloured subjects are situated at the bottom of the screen. To access more information about one of these subjects, press the appropriately coloured button. This facility enables fast access to information on the subjects shown.

• TOP mode (in case of TOP text broadcasting)

TOP is a particular improvement of the standard teletext service that results in an easier search and effective guide.

- Fast overview of the teletext information available
- Easy to use step-by-step selection of the topical subject
- Page status information at the bottom of the screen

• List mode

Four differently coloured page numbers are situated at the bottom of the screen. Each of these numbers can be altered and stored in this unit.

To store frequently viewed page (List mode only)

During the page is displayed

- ① Press the colour button of the colour to store.
- ② Press and hold [OK].

e.g.,

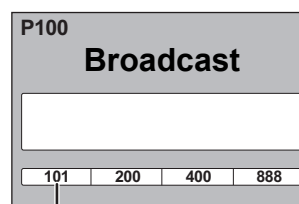

The number changes to white.

To change stored pages (List mode only)

- ① Press the colour button of the colour to change.
- ② Enter the new page number with the numbered buttons.
- ③ Press and hold [OK].

To exit the teletext screen

Press [TEXT☺].

Note

The teletext function depends on respective stations.

Recording method and disc

Recording modes that can be selected differ depending on the recording methods and discs.

Recording method		HDD	BD-RE BD-R	RAM	-R -RW(V)	+R +RW	-R DL +R DL
Using this unit's tuner	Recording by using [● REC] button	DR	–	–	–	–	–
	Timer Recording	DR	–	–	–	–	–
From External equipment	Recording by using [● REC] button	XP, SP, LP, EP	–	–	–	–	–
	Timer Recording	XP, SP, LP, EP, FR	–	–	–	–	–
	Flexible Recording via AV input	FR	FR	FR	FR	FR	–
	DV Automatic Recording	XP, SP, LP, EP	XP, SP, LP, EP	XP, SP, LP, EP	XP, SP, LP, EP	XP, SP, LP, EP	–
	Linked Timer recording (Ext Link)	XP, SP, LP, EP	–	–	–	–	–

Maximum number of titles that can be recorded

HDD: 999 titles (When continuously recording for long durations, titles are automatically divided every 8 hours.)

BD-RE **BD-R**: 200 titles

RAM **-R** **-R DL** **-RW(V)**: 99 titles on one disc.

+R **+R DL** **+RW**: 49 titles on one disc.

Recording modes and recording contents

Picture quality or audio that can be recorded differ depending on the recording mode.

• This also explains about copying or DR File Conversion (⇒ 50).

Recording mode	DR	HG, HX, HE, HL	XP, SP, LP, EP	FR (⇒ below)
Quality that can be recorded	Quality same as broadcast (HD quality and SD quality)	Quality produced by conversion*1 of broadcast data (HD quality and SD quality)	SD quality only	
Multiple audio	Record all multiple audio	Record only one audio*2		
Subtitles	Can be recorded	Can be recorded*3 The subtitles cannot be switched on or off during playback.		
Teletext	Can be recorded	Can be recorded [Copy Title Playing (⇒ 55) only] You will not be able to switch between display/non-display or execute Teletext operations in the recorded content.		
Sub Channel	Cannot be recorded in timer recording			
Surround audio	Surround audio as the broadcast	Surround Audio produced by conversion of broadcast audio format*4	Stereo audio	

*1 MPEG-4 AVC/H.264 encoding

*2 Before copying or DR File Conversion, select the audio to record.

– “Copy” or “DR File Conversion”: Select the audio with “Preferred Language” in the Setup menu (⇒ 89).

– “Copy Title Playing”: Select the audio with “Multi Audio” in the Disc menu (⇒ 81).

*3 Before copying or DR File Conversion, select the subtitle to record.

– “Copy” or “DR File Conversion”: Select the subtitle with “Preferred Language” in the Setup menu (⇒ 89).

– “Copy Title Playing”: Subtitle displayed during playback are recorded.

Press [STTL] to display the subtitle.

Select the subtitle with “Subtitles” in the Disc menu (⇒ 81)

*4 If the audio sampling frequency is not 48 kHz, surround audio is mixed and recorded in front LR channels. Audio will be output from two front speakers only, even if you play it on 5.1 ch speaker connection.

FR (Flexible Recording Mode)

You can set FR (Flexible Recording) mode when copying or recording from external equipment.

The unit automatically selects a recording rate between XP and EP (8 hours) that will enable the recordings to fit in the remaining disc space with the best possible recording quality.

For example with a 90 minute recording to an unused DVD-RAM, the picture quality is adjusted to between “XP” and “SP”.

When recording to the HDD, picture quality is automatically adjusted to precisely fit a copied title on a 4.7 GB disc.

Recording modes and approximate recording times

Depending on the content being recorded, the recording times may become shorter than indicated.
(The times provided on this chart are an estimate.)

Recording Mode	HDD		BD-RE BD-R		RAM		-R -RW(V) +R +RW (4.7 GB)	-R DL +R DL (8.5 GB)
	BS850 (500 GB)	BS750 (250 GB)	Single Layer (25 GB)	Dual Layer (50 GB)	Single-sided (4.7 GB)	Double-sided*2 (9.4 GB)		
DR*1 (High Definition (HD) quality: estimated bit rate is 14 Mbps)	77 hours	37 hours 30 min.	3 hours 30 min.	7 hours 30 min.	–	–	–	–
DR*1 (Standard Definition (SD) quality: estimated bit rate is 5 Mbps)	215 hours	105 hours	10 hours 15 min.	21 hours	–	–	–	–
HG	80 hours	40 hours	4 hours	8 hours	–	–	–	–
HX	120 hours	60 hours	6 hours	12 hours	–	–	–	–
HE	180 hours	90 hours	9 hours	18 hours	–	–	–	–
HL	240 hours	120 hours	12 hours	24 hours	–	–	–	–
XP	110 hours	55 hours	5 hours 15 min.	10 hours 30 min.	1 hour	2 hours	1 hour	1 hour 45 min.
SP	220 hours	110 hours	10 hours 30 min.	21 hours	2 hours	4 hours	2 hours	3 hours 35 min.
LP	442 hours	221 hours	21 hours	42 hours	4 hours	8 hours	4 hours	7 hours 10 min.
EP*3	885 hours (664 hours*4)	441 hours (331 hours*4)	42 hours (31 hours 30 min.*4)	84 hours (63 hours*4)	8 hours (6 hours*4)	16 hours (12 hours*4)	8 hours (6 hours*4)	14 hours 20 min. (10 hours 45 min.*4)

*1 Recording time of DR mode may vary depending on bit rate of broadcasting.

*2 It is not possible to record or play continuously from one side of a double sided disc to the other.

*3 When recording to the HDD in "EP" or "FR (recordings 5 hours or longer)" mode, you cannot perform high-speed copy to +R, +R DL or +RW discs.

*4 When "Recording time in EP mode" is set to "6 hours" in the Setup menu (⇒ 90).

The sound quality is better when using "6 hours" than when using "8 hours".

● **RAM** When recording to DVD-RAM using "8 hours" mode, play may not be possible on DVD players that are compatible with DVD-RAM. Use "6 hours" mode if playback may be on other equipment.

Regarding recording time remaining

DR mode recording

Remaining time in the DR mode is calculated with a bit rate of approx. 14 Mbps. But the bit rate differs depending on the broadcast, so the displayed remaining time might be different from the actual remaining time.

Other recording modes (title conversion or from external input)

This unit records using a VBR (Variable bit rate) data compression system to vary recorded data segments to match video data segments which may cause differences in the displayed amount of time and space remaining for recording.

If the remaining amount of time is insufficient, delete any unwanted titles to create enough space before you start recording.

2 programmes simultaneous recording

This function can only be used when two satellite cables are connected to the unit (⇒ 17) and “Two cables (Same signal)” has been selected in Auto Setup (⇒ 18, 87).

Possible combination for 2 programmes simultaneous recording

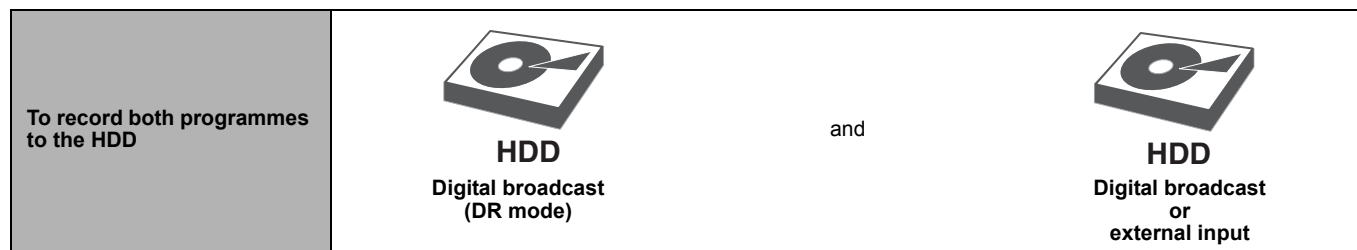

To perform 2 programmes simultaneous recording, 1 programme out of the 2 needs to be recorded to the HDD in “DR” mode.

During the recording of an encrypted broadcast, you cannot view or record another encrypted broadcast.

Note

- 2 programmes simultaneous recording is not possible in following conditions:
 - When “One cable” has been selected in Auto Setup (⇒ 18, 87).
 - When a single satellite cable is connected to the unit (⇒ 17)
 - 2 programmes from the external input
 - While recording from DV input, or executing “Flexible Recording via AV input”
 - While high speed copying
 - 2 programmes on same channel cannot be recorded simultaneously by pressing [● REC].

Types of recording data for copyright protected titles

Titles recorded using CI Plus are copyright protected.

Copying not restricted	It can be copied for indefinite generations. ● There may be a limitation with the types of disc that can be copied to. (⇒ 53)
One generation copy is permitted	There are limitations with the types of disc that can be copied to, and the number of copies. (⇒ 53) ● Original data are deleted when the recording mode is converted. (⇒ 50)
Copying is prohibited	Copy is not possible. ● You will not be able to playback after a specific period has passed following recording. ● Playback limitation can be confirmed with Properties. (⇒ 49) ● Editing, other than Delete and Properties, is not possible. (⇒ 48) ● Playback/record is not possible when "Automatic" in "Clock" is set to "Off". (⇒ 95)

Important notes for recording

<p>16:9 image such as wide broadcasting</p>	<ul style="list-style-type: none"> •When the “Rec for High Speed Copy” of the Setup menu is “On” <ul style="list-style-type: none"> – Record from external equipment. – Copy from the finalised disc (DVD-Video) to the HDD •When recording to -R -R DL -RW(V) •When copying to BD-RE BD-R in HG, HX, HE or HL modes •When converting the recording mode from DR mode to HG, HX, HE, HL, XP, SP, LP, EP or FR modes <p style="text-align: center;">↓</p> <p>It will be recorded in accordance to the setting of “Aspect for Recording” (⇒ 90) in the Setup menu.</p> <ul style="list-style-type: none"> •In the following cases, even when set to “Automatic” or “16:9”, recordings will be made or copied in 4:3. <ul style="list-style-type: none"> – -R -R DL -RW(V) When the recording mode is set to “EP” or “FR (recordings 5 hours or longer)” mode. – When recording or copying to a +R, +R DL and +RW.
<p>High Speed Copy</p>	<p>Speed to copy the title recorded on the HDD to a disc differs depending on the recording mode of the title and the disc to copy.</p> <p>Title in DR mode BD-RE BD-R Title can be copied at high speed.</p> <p>Title in HG, HX, HE, or HL modes BD-RE BD-R Title can be copied at high speed.</p> <p>Title in XP, SP, LP, EP, or FR modes RAM Title can be copied at high speed.</p> <p>-R -R DL -RW(V) +R +R DL +RW Title can be copied at high speed if “Rec for High Speed Copy” was set to “On” before the programme is recorded to HDD from external input. (The default setting is “On”. ⇒ 90)</p> <p>But in the following cases, high speed mode does not work.</p> <ul style="list-style-type: none"> – +R +R DL +RW Titles recorded in “EP” mode and “FR (recordings 5 hours or longer)” mode – +R +R DL +RW Titles recorded in 16:9 aspect – -R -R DL -RW(V) Titles recorded in 16:9 aspect using “EP” mode or “FR” (recordings 5 hours or longer) mode
<p>DR File Conversion</p>	<p>“DR File Conversion” is a function that converts the titles in DR mode to other recording modes. In general, Data size of a title will be smaller than the original title after conversion. You can save HDD capacity by deleting the original title after conversion.</p> <div style="text-align: center;"> <p>The diagram illustrates the DR File Conversion process in three stages:</p> <ol style="list-style-type: none"> Initial State: A bar represents the disc's capacity. A large grey block labeled "Title DR" occupies most of the space, leaving a small white area labeled "Available disc space". Conversion: An arrow labeled "Converting to other mode" points to a second bar. The grey block is now smaller and labeled "Title HL", with a larger white area labeled "Available disc space". Final State: A third arrow labeled "Deleting the original data" points to a final bar. The grey block is now very small, and the white area labeled "Available disc space" is significantly larger than in the previous stages. </div>
<p>Playing the disc on other players</p>	<p>BD-RE BD-R Titles may not playback on other Blu-ray Disc player. (⇒ 8)</p> <p>-R -R DL -RW(V) +R +R DL The disc must be finalised (⇒ 86). It is necessary to finalise DVD-R, etc. on this unit after recording or copying titles to them. You can then play them as a commercially sold DVD-Video. However, the discs become play-only and you can no longer record or copy.* * You can record and copy again if you format DVD-RW. (⇒ 85)</p> <div style="text-align: center;"> <p>The flowchart shows the process of preparing a disc for playback on other equipment:</p> <ol style="list-style-type: none"> An icon of a person recording is followed by an arrow pointing to a disc with the text "Record to DVD-R, etc." An arrow labeled "Finalise" points from the disc to a box containing icons of a laptop and a DVD player, with the text "Play on other DVD equipment". </div> <p>+RW If the disc failed to play on other equipment, we recommend you create top menu (⇒ 86).</p>
<p>Recording an encrypted broadcast</p>	<p>To view or record an encrypted broadcast, insert the CAM (Conditional Access Module) with Smart Card valid for the broadcast in the CI slot in the rear panel of the unit, and set the CI. (⇒ 16, 19)</p> <ul style="list-style-type: none"> •During the recording of an encrypted broadcast, you cannot view or record another encrypted broadcast.

Playing while you are recording

Chasing playback

Playback from the beginning of the title in the HDD, while the title is being recorded to the HDD.

Simultaneous rec and play

Playback the previously recorded title while recording onto the HDD or timer recording onto the disc.

- 1 Press [DRIVE SELECT] to select the HDD or BD drive.
 - Select "BD" for any discs.
- 2 Press [DIRECT NAVIGATOR] during recording.

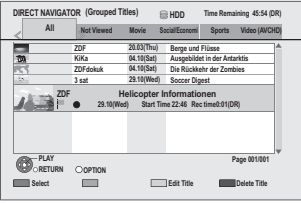

"●" is displayed on the recording programme.

- 3 Press [▲, ▼] to select a title and press [OK].

To stop play

Press [■].

To exit the DIRECT NAVIGATOR screen

Press [DIRECT NAVIGATOR].

To stop recording



After play stops

- 1 Press [DIRECT NAVIGATOR] to exit the screen.
- 2 Press [■].

Note

- "Chasing playback" and "Simultaneous rec and play" can only be used with programmes of the same encoding system (PAL/NTSC).
- Depending on the state of the unit, playback may not be possible. (⇒ 104)

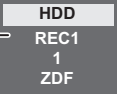
Operation during Recording

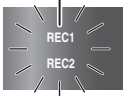
<p>Check the recording programme</p>	<p>Press [STATUS ⓘ]. e.g., while 2 programmes simultaneous recording</p> <p>Recording programme displayed on the TV screen → </p> <p>Recording programme not displayed on the TV screen → </p>
<p>Switch the input</p>	<p>Press [INPUT SELECT].</p>
<p>Switch to other channel*</p>	<p>Press [^ ∇ CH].</p> <ul style="list-style-type: none"> • Other operation (⇒ 20) • During the recording of an encrypted broadcast, you cannot view or record another encrypted broadcast. (⇒ 22)
<p>Display the recording programme on the TV screen</p>	<p>It is necessary to display the recording programme onto the TV screen to perform operations such as pause.</p> <ul style="list-style-type: none"> • If the input was switched: Press [INPUT SELECT]. • If the channel was switched: Press [^ ∇ CH]. • If the drive was switched: Press [DRIVE SELECT].
<p>To stop recording</p>	<p>It is necessary to display the programme you want to stop on the TV screen. (⇒ above)</p> <p>Press [■].</p> <ul style="list-style-type: none"> • From the start to the end of the recording is called one title.
<p>To pause recording</p>	<p>It is necessary to display the programme you want to pause on the TV screen. (⇒ above)</p> <p>Press [II].</p> <ul style="list-style-type: none"> • Press again to restart recording. You can also press [● REC] to restart. (Title is not split into separate titles.) • If paused while recording in DR mode, the paused part may become a still picture for a moment during playback of that programme.
<p>Perform 2 programmes simultaneous recording*</p>	<p>Record other programme with steps 1–3 on page 22.</p> <ul style="list-style-type: none"> • One of the 2 programmes needs to be digital broadcasting recorded with DR mode. <p>“REC1” and “REC2” will light</p> <p>Unit's display </p> <ul style="list-style-type: none"> • Channel switch / input switch while performing 2 programmes simultaneous recording will switch between the 2 recording programmes.

* This function can only be used when two satellite cables are connected to the unit (⇒ 17) and “Two cables (Same signal)” has been selected in Auto Setup (⇒ 18, 87).

Manually programming timer recording

Timer recording of the broadcast

Recording disc: **HDD**

Recording mode: **DR**

Timer recording from the external equipment connected to AV1, AV2 or AV3

Recording disc: **HDD**

Recording mode: **XP, SP, LP, EP, FR**

Selection of channel is made easy by creating a Favourite of the channels you watch often. (⇒ 87, Favourites Edit)

- You can enter up to 64 programmes up to a month in advance. (Each daily or weekly programme is counted as one programme.)

Preparation

- Turn on the television and select the appropriate video input to suit the connections to this unit.
- Turn on this unit.
- Make sure that the clock settings are correct (⇒ 95).

1 Press [PROG/CHECK].

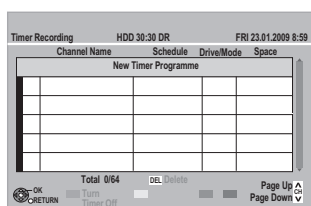

2 Press [▲, ▼] to select “New Timer Programme” and press [OK].

3 Press [◀, ▶] to select the items and change the items with [▲, ▼].

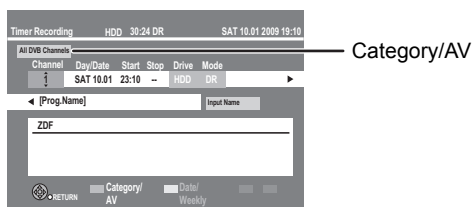

• Channel

Select the channel to record.

You can press the “Red” button (Category/AV) to change “AV input”, “All DVB Channels”, “Free Channels”, “Radio” or “Favourites1”, etc.

You can perform this operation when you select the box of “Channel”.

You can also select channel with the numbered buttons.

• Day/Date

You can select current date up to one month later minus one day. You can select “Date” or “Weekly” by pressing the “Green” button only when “Day/Date” is selected. Titles recorded using the same daily or weekly timer are bundled and displayed as a “group” in the DIRECT NAVIGATOR screen (⇒ 41) except when using Auto Renewal Recording.

• Start/Stop

Press and hold [▲, ▼] to alter the Start (Start time) and Stop (Finish time) in 15-minute increments.

• Mode

Recording modes and recording contents (⇒ 29)

“XP”, “SP”, “LP”, “EP”, “FR” can be selected when “Channel” is selected in “AV input”.

It will be fixed to DR mode if anything else is selected.

• Renew (Auto Renewal Recording) (⇒ 36)

• Input Name

Press [OK]. (⇒ 80, Entering text)

4 Press [OK].

The timer programme is stored and the timer icon (red) is displayed.

Timer icon (red)

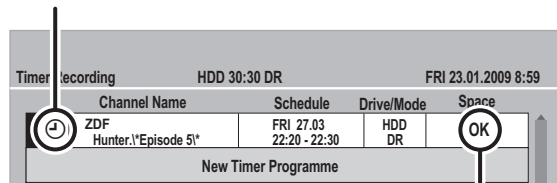

Check for available space on HDD, etc., when the “!” is displayed. (⇒ 37)

“Ⓢ” lights on the unit’s display to indicate timer recording standby has been activated.

To return to the previous screen

Press [RETURN ↵].

To exit the screen

Press [EXIT].

■ Timer Recording using the TV Guide system (⇒ 23)

■ To release the unit from timer recording standby (⇒ 36)

■ To cancel recording when timer recording has already begun (⇒ 36)

■ About 2 programmes recorded simultaneously (⇒ 22)

■ Notes on timer recording (⇒ 37)

Note

- To record an encrypted broadcast, a CAM (Conditional Access Module) with Smart Card valid for the broadcast is required.

To release the unit from timer recording standby

Even when the unit is turned off, you can display the timer recording list by pressing [PROG/CHECK].

- 1 Press [PROG/CHECK].
- 2 Press [▲, ▼] to select the programme and press the “Red” button.
 - The timer icon “⊖” (⇒ 37) will change from red to grey.
 - You cannot cancel timer recording standby mode as long as even one timer icon “⊖” (red) remains in the timer recording list.
 - Press the “Red” button again to activate timer recording standby. (The timer icon “⊖” will change to red.)

Auto Renewal Recording

HDD

If you record a programme onto HDD repeatedly everyday or every week using timer recording, the unit will record the new programme over the old one.

This function can be used only when weekly recording or daily recording is selected.

- 1 Press [PROG/CHECK].
- 2 Press [▲, ▼] to select the programme and press [OK].
- 3 Press [◀, ▶] to select “Renew” column.
- 4 Press [▲, ▼] to select “ON” and press [OK].

Note

- If a programme set for Auto Renewal Recording is protected or while playback is taking place from the HDD, or while copying, the programme will not be overwritten. Instead the programme set for recording will be saved as a separate programme, and this programme will be the one to be overwritten when the next Auto Renewal Recording takes place.
- When there is not enough space on the HDD, the programme may not be recorded completely.

To cancel recording when timer recording has already begun

Press [INPUT SELECT] or [∧ ∨ CH] to display the programme that you want to stop recording on the TV screen while 2 programmes are simultaneously recording.

- 1 Press [■].

e.g.,

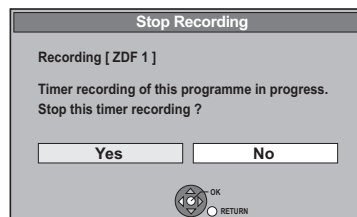

- 2 Press [◀, ▶] to select “Yes” and press [OK].

- If you stop a timer recording, it will be cancelled. However, if you have already set a weekly, daily timer recording, the recording will start at the next scheduled time.

Check, change or delete a programme

Even when the unit is turned off, you can display the timer recording list by pressing [PROG/CHECK].

Press [PROG/CHECK].

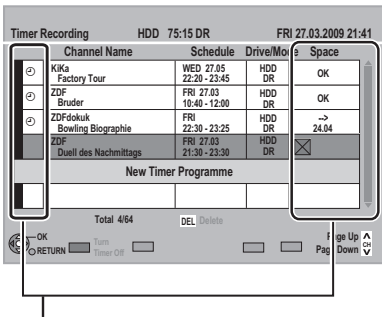

Icons

- ⊙ Red: Timer recording standby is activated.
Grey: Timer recording standby is not activated.
 - This programme is currently recording.
 - 🕒 Part or all of the programme will not be recorded since the programme is overlapping.
 - 🗑️ The disc was full so the programme failed to record.
 - 🔒 The programme was copy-protected so it was not recorded.
 - ⊗ The programme did not complete recording because of some reason.
 - 🔄 Timer programmes set to Auto Renewal Recording (⇒ 36).
 - 🔒 The timer recording of the encrypted broadcast is overlapping another programme.
- OK:** Displayed if the recording can fit in the remaining space.
→ **(Date):** For recordings made daily or weekly, the display will show until when recordings can be made (up to a maximum of one month from the present time) based on the time remaining on the disc.
- ! :** It may not be possible to record because:
- there is not enough space left.
 - the number of possible titles has reached its maximum. (⇒ 29)
 - programmes are deactivated.

■ To change a programme

Press [▲, ▼] to select the programme and press [OK]. (⇒ 35, step 3)

■ To delete a programme

Press [▲, ▼] to select the programme and press [DEL].

■ To exit the timer recording list

Press [PROG/CHECK].

Note

- Programmes that failed to record are deleted from the timer recording list at 4 a.m. two days later.

Notes on timer recording

- Only 1 programme can be set to timer recording on the disc.
- Timer recording will not be performed if the clock is not set.
- If the "TV System" (⇒ 93) in the Setup menu was modified to playback a disc or a title while on timer recording standby, return the setting to original before the recording is started.
- Timer recordings are activated regardless of whether the unit is turned on/off.
- Timer recordings begin when the set time is reached even when playing. Depending on the state of the unit, playback may stop when recording begins.
- Timer recordings do not begin while copying in normal speed mode.
- The timer recording starts, whether the unit is turned on or off. When the recording starts with the unit turned on, if you should turn the unit off the recording status is not affected.
- When you programme successive timer recordings to start immediately one after the other, last 1 minute of earlier programme will not be recorded unless it can perform 2 programmes simultaneous recording.

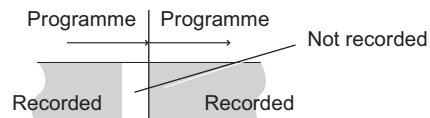

- If timer recordings overlap around the same time, some programmes will not be recorded depending on the set timer recordings. As for programmes with "🕒" displayed on the timer recording list screen, some portion or all of the programmes cannot be recorded. Press [PROG/CHECK] to confirm. (⇒ left)
- It is not possible to simultaneously record multiple programmes from encrypted broadcasts.

Starting of the timer recording while executing other operation (⇒ 104)

Operations in the TV Guide system

Basic operations

Press [GUIDE] to switch between Landscape view and Portrait view.

Landscape view

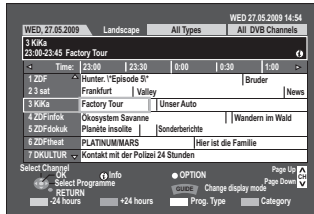

Portrait view

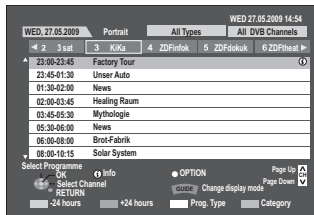

To change channels	<p>Landscape view Press [▲, ▼] to select a channel.</p> <p>Portrait view Press [◀, ▶] to select a channel. The TV Guide list appears for this channel.</p>
To view a programme list for another day	<ul style="list-style-type: none"> Jump ahead 24 hours Press the “Green” button to jump ahead by one day. Jump back 24 hours Press the “Red” button. You can only jump back to the current date. Past information cannot be viewed. <p>When jumping, the selected time period may deviate.</p>
To browse through the TV Guide list	Press [▲ ▼ CH].
To see programme information (Programmes with the ⓘ symbol)	<p>Press [STATUS ⓘ]. Additional information (programme name, programme duration, broadcast time, description) is available for these programmes. Press [▲, ▼] to scroll up and down.</p> <p>To show other pages Press [CH ▲] (Previous) or [▼ CH] (Next).</p> <p>Press [STATUS ⓘ] again to return to the programme list.</p>

Selecting the programme from the desired programme type or Category

This function lets you display a TV Guide list sorted by programme type (e.g. Movie, Sport) or Category (e.g. TV, Radio).

- From the desired programme type
Press the “Yellow” button to display the list of programme type.
From the desired Category
Press the “Blue” button to display the list of category.
- Press [▲, ▼] to select the desired item.

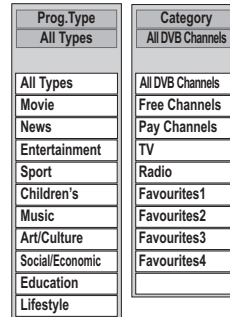

- Press [OK].

- A list appears with all programmes of the selected item.
- When you select the Landscape view, the unit displays programmes in grey that do not belong to the selected programme type.



e.g., Programme type, “News” is selected in step 2 of Landscape view.

Note

The broadcasters allocate individual programmes to topic areas. This function does not work properly unless the information which distinguishes the programme type and profiles sent from broadcast stations is correct.

- Press [▲, ▼, ◀, ▶] to select the programme.

To return to the previous TV Guide list before you have selected the programme type or Category

Select “All Types” of the programme type or “All DVB Channels” of the Category in step 2. (⇒ above)

To return to the previous screen

Press [RETURN ↵].

To exit the screen

Press [EXIT].

TV Guide data download

- TV Guide data is downloaded automatically while the unit is turned on.
If the unit is turned off at the specified time, the TV Guide data is downloaded automatically. (⇒ 95)
- Depending on the state of the unit, data is not downloaded during 2 programmes simultaneous recording and the like.
- You cannot download TV Guide data during recording when “One cable” has been selected in Auto Setup (⇒ 18, 87).

- Refer to page 44 for playing DivX.
- Refer to page 64 for playing still pictures.
- Refer to page 70 for playing music.

Note

- When playing back a title recorded on the HDD, BD-RE or BD-R, ensure that you match the “TV System” setting to the recorded title (⇒ 93).
- A disc or title with different “TV System” (⇒ 93) may not be able to playback while recording or on standby for the timer recording. You will be able to playback by changing the “TV System” settings in that case, but to prevent failure of the timer recording, change back the settings before the recording starts.
- Depending on the disc, it may take time for the menu screen, pictures, sound, etc. to start.
- The producer of the disc can control how discs are played. So you may not always be able to control play as described in these operating instructions. Read the disc’s instructions carefully.
- Discs continue to rotate while menus are displayed. Press [■] when you have finished playback to protect the unit’s motor, your television screen and so on.

Operation during play

HDD **BD-RE** **BD-R** **BD-V** **RAM** **-R** **-R DL** **-RW(V)** **+R** **+R DL** **+RW** **-RW(VR)** **DVD-V** **AVCHD** **DivX**

- Depending on the media, some operations may not be possible.

<p>Stop</p>	<p>Press [■]. The stopped position is memorized.</p> <p>Resume play function Press [▶] (PLAY) to restart from this position.</p> <ul style="list-style-type: none"> • BD-V On BD-Video discs including BD-J (⇒ 118), the resume play function does not work. <p>Stopped position</p> <ul style="list-style-type: none"> • HDD : Stopped position for each title is memorized. • Discs: Only previous stopped position is memorized. The position is cleared if the tray is opened. • AVCHD (SD card), DivX: Only previous stopped position is memorized. The position is cleared if the unit is turned off.
<p>Pause</p>	<p>Press [⏸]. Press [⏸] again or [▶] (PLAY) to restart play.</p>
<p>Search</p>	<p>Press [◀◀] or [▶▶].</p> <ul style="list-style-type: none"> • The speed increases up to 5 steps. (+R +R DL +RW up to 3 steps) • Press [▶] (PLAY) to restart play. • Audio is heard during first level search forward. • DivX: Audio is not heard during all levels search. • BD-V Only primary video is played while performing this operation.
<p>Skip</p>	<p>During play or while paused, press [◀◀] or [▶▶].</p> <p>Skip to the title or chapter you want to play.</p> <ul style="list-style-type: none"> • It will skip to the beginning of chapters (⇒ 51) if the title contains chapters. • HDD It will not skip the title. But the title in the grouped titles during the “Grouped Playback” (⇒ 42) will be skipped. • DivX: Press [◀◀] to return to the beginning of the title currently playing.
<p>Starting from a selected title</p> <p>BD-V DVD-V AVCHD</p>	<p>Press the numbered buttons. Play starts from the selected title or chapter.</p> <ul style="list-style-type: none"> • BD-V AVCHD Input a 3-digit number e.g., 5: [0] ⇒ [0] ⇒ [5] 15: [0] ⇒ [1] ⇒ [5] • DVD-V Input a 2-digit number e.g., 5: [0] ⇒ [5] 15: [1] ⇒ [5] • While stopped (the screen on the right is displayed on the television), the title is designated. While playing, the chapter is designated. 
<p>Quick View</p> <p>Except -RW(V) (It will not work even if it is finalised) -RW(VR), DivX</p>	<p>Press and hold [▶] (PLAY/×1.3). Play speed is quicker than normal.</p> <ul style="list-style-type: none"> • Press again to return to normal speed. • Image may not be played back smoothly in case of DR, HG, HX, HE, HL mode titles or BD-V AVCHD. • BD-V Only primary video is played while performing this operation.
<p>Slow-motion</p> <p>Except DivX</p>	<p>While paused, press [◀◀] or [▶▶].</p> <p>The speed increases up to 5 steps.</p> <ul style="list-style-type: none"> • Press [▶] (PLAY) to restart play. • BD-V AVCHD Forward direction [▶▶] only. • The unit will pause if slow-motion play is continued for approximately 5 minutes (excluding BD-V DVD-V AVCHD). • BD-V Only primary video is played while performing this operation. • You cannot perform this operation when you playback the radio programme.

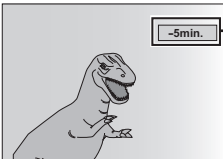
<p>Frame-by-frame Except DivX</p>	<p>While paused, press [◀] (◀◀) or [▶] (▶▶). Each press shows the next frame. <ul style="list-style-type: none"> • Press and hold to change in succession forward or backward. • Press [▶] (PLAY) to restart play. • BD-V AVCHD Forward direction [▶] (▶▶) only. • BD-V Only primary video is played while performing this operation. • You cannot perform this operation when you playback the radio programme. </p>
<p>Skipping the specified time (Time Slip) Except BD-V DVD-V AVCHD, DivX</p>	<p>1 Press [TIME SLIP]. 2 Press [▲, ▼] to select the time and press [OK]. Play skips the specified time. <ul style="list-style-type: none"> • Each time you press [▲, ▼], the time increases [▲] or decreases [▼] by 1 minute intervals. (Press and hold for 10-minute intervals.) </p>  <p>This automatically disappears after approximately 5 seconds. To show the screen again press [TIME SLIP] again.</p>
<p>Manual Skip Except BD-V, DivX</p>	<p>Press [MANUAL SKIP]. Each time you press, play restarts approximately 1 minute later.</p>
<p>Aspect</p>	<p>Switch the aspect ratio of the screen (⇒ 83)</p>
<p>Create Chapter HDD BD-RE BD-R RAM</p>	<p>Chapters are divided at the point pressed. (⇒ 51)</p>

Changing audio during play

HDD BD-RE BD-R BD-V RAM -RW(VR) DVD-V AVCHD DivX

Press [AUDIO].

It will switch depending on the contents recorded every time it is pressed.

e.g., **HDD** "Audio LR, deu" is selected.

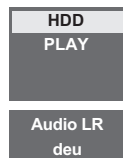

BD-V DVD-V AVCHD

You can change the audio channel number each time you press the button. This allows you to change things like the soundtrack language (⇒ 81, Soundtrack).



e.g., English is selected.

Display the subtitle during play

HDD BD-RE BD-R

It is possible to display the subtitles during the playback if the programme with subtitle is recorded with DR mode.

Press [STTL (E)].

• It will switch between On/Off every time it is pressed.

BD-V DVD-V AVCHD DivX

Display with "Subtitles" in the Disc menu (⇒ 81).

Display the Teletext during play

HDD BD-RE BD-R

It is possible to display the Teletext during the playback if the programme with Teletext is recorded with DR mode.

Press [TEXT (E)].

• It will switch between On/Off every time it is pressed.

Note

- List mode cannot be used. (⇒ 28)
- Teletext cannot be displayed when the subtitle is On. (⇒ above)
- You cannot use "Skipping the specified time (Time Slip)", "Manual Skip" or "Create Chapter" when Teletext is being displayed.

When playing DVD-R DL (Dual Layer, single-sided) and +R DL (Double Layer, single-sided)

DVD-R DL (Dual Layer, single-sided) and +R DL (Double Layer, single-sided) discs have two writable layers on one side. If there is not enough space on the first layer to record a programme, the remainder is recorded on the second layer. When playing a title recorded on both layers, the unit automatically switches between layers and plays the title in the same way as a normal programme. However, video and audio may momentarily cut out when the unit is switching layers.

DVD-R DL
+R DL

When switching layers:
Video and audio may momentarily cut

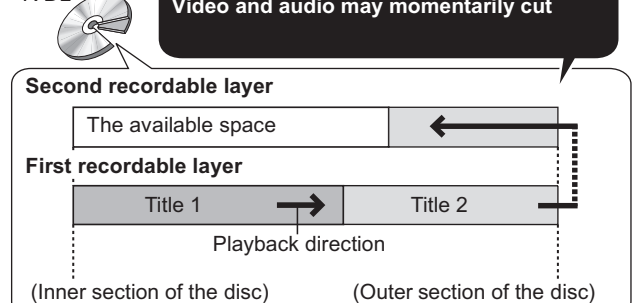

Selecting recorded programmes (titles) to play—DIRECT NAVIGATOR

You can quickly find the recorded titles and easily play them by using DIRECT NAVIGATOR screen.
Press [DIRECT NAVIGATOR].

e.g., **HDD**

Display status
(Grouped Titles or All Titles) (⇒ right)

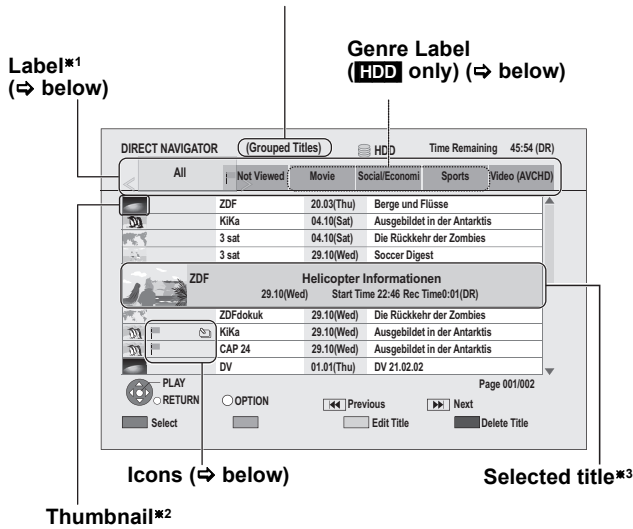

- *1 Label will only display “All” when using media other than HDD.
- *2 Thumbnail is displayed for the selected title only except for with HDD.
- *3 If the title has a long name, the name scrolls once only.

DIRECT NAVIGATOR screen icons

- Currently recording.
- Title protected.
- Title that was not recorded due to recording protection
- Title cannot be played
(When copying a title to the HDD, or when data is damaged etc.)
- Title that is copyright protected (One generation copy is permitted) (⇒ 31)
- Title that is copyright protected (Copying is prohibited) within playback period (⇒ 31)
 - Playback period limit can be checked in the Properties of that title. (⇒ 49)
- Title that is copyright protected (Copying is prohibited) past playback period (⇒ 31)
- Groups of titles (**HDD** only)
- Title that has not yet been played (**HDD** only)
- Title recorded using a different encoding system from that of the TV system currently selected on the unit.
 - Alter the “TV System” setting on this unit to suit (⇒ 93).
- Radio programme

Regarding Label **HDD**

Titles recorded to HDD will be categorized to the following labels automatically depending on the contents of the titles.
It is convenient when searching for the titles you want to playback.
Press [◀, ▶] to select the label.

- All:** All titles
- Not Viewed:** Titles that have not been viewed yet
- Genre Label: (News, Movie, etc.)** Titles sorted in categories according to the information of the recorded programme
 - Some titles may not be sorted correctly.
 - Categories for Genre Label can be changed. (⇒ 42)
- Video (AVCHD):** High definition video acquired from the disc, SD card or USB device

Switching of the Navigator **HDD**

- ① Press [OPTION].
- ② Press [▲, ▼] to select “Grouped Titles” or “All Titles” and press [OK].

Grouped Titles screen

Two or more titles recorded in the Daily/weekly timer recording mode are bundled and displayed as one item.

Select the item marked with and press [OK] to display the bundled titles.

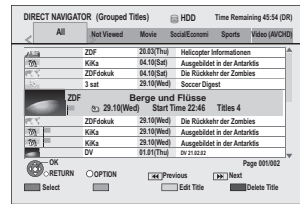

All Titles screen

Displays all titles.

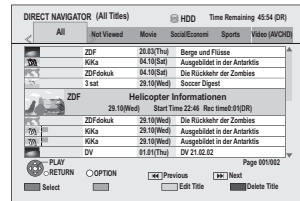

Playback the title that was viewed once **HDD**

You can choose to start the playback from the point you have last stopped, or from the beginning when the resume play function (⇒ 39) is operating.

- ① Press [OPTION].
- ② Press [▲, ▼] to select “Play from the Beginning” or “Play from Last Viewed” and press [OK].

Playing back

To change the Genre Label HDD

Genre displayed in the Genre Label can be changed.

- ① Press [◀, ▶] to select the Genre Label (Movie, News, Sports, etc.) and press [OPTION].
- ② Press [▲, ▼] to select “Genre Label Setting” and press [OK].
- ③ Press [▲, ▼] to select the genre and press [OK].

To play grouped titles HDD

(Grouped Titles screen only)

■ Play the selected titles

- ① Press [▲, ▼] to select the group and press [OK].
- ② Press [▲, ▼] to select the title and press [OK].

■ Play the titles continuously (Grouped Playback)

While the Grouped Titles screen is displayed, Press [▲, ▼] to select the group and press [▶] (PLAY).

To edit the group of titles HDD

(Grouped Titles screen only)

- ① Press [▲, ▼] to select a title or a group and press the “Red” button.
A check mark is displayed. Repeat this step until you select all necessary titles.
● Press the “Red” button again to cancel.
- ② Press [OPTION].
- ③ Press [▲, ▼] to select the option and press [OK].

Create Group:

Press [◀, ▶] to select “Create” and press [OK].
Selected titles are bundled to form a group.

Release Grouping:

Press [◀, ▶] to select “Release” and press [OK].
● All the titles in the group are released.

Remove:

(Only when titles in a group have been selected)
Press [◀, ▶] to select “Remove” and press [OK].
Selected titles are removed from the group.

■ Regarding the group name

The name of the first title in the group is used as the group name.

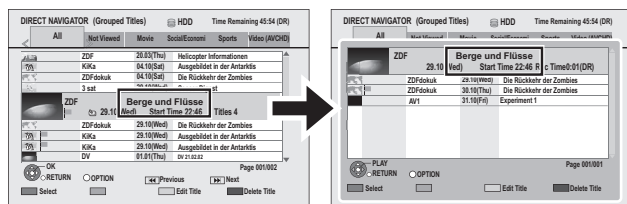

To change the group name

- 1 Press [▲, ▼] to select the group and press [OPTION].
 - 2 Press [▲, ▼] to select “Edit” and press [OK].
 - 3 Press [▲, ▼] to select “Enter Title Name” and press [OK].
 - 4 Enter the name. (⇒ 80, Entering text)
- Even if the group name is changed, the title names in the group will not be changed.

Note

- These functions are only available for videos and not available for music and still pictures.

Playback of the High Definition Video (AVCHD)

AVCHD

Only AVCHD recorded or edited on a Panasonic's video camera will be recognised. An SD card or disc that contains AVCHD recorded on devices other than a Panasonic's video camera may not be recognised.

1 Insert the disc or the SD card

The display below automatically appears.

Disc

e.g., **RAM**

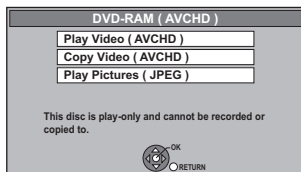

SD

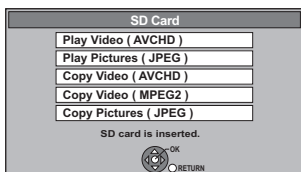

- Display items differ depending on what is recorded in each media.

2 Press [▲, ▼] to select “Play Video (AVCHD)” and press [OK].

- If the top menu of the disc or SD card to play was

- Created: Display the top menu
- Not created: Display the “DIRECT NAVIGATOR” screen
If the “DIRECT NAVIGATOR” screen is not displayed, press [▶] (PLAY) to playback and press [◀◀, ▶▶] or [◀◀, ▶▶] to select the programme.

3 Press [▲, ▼] to select the title and press [OK].

e.g., **SD** DIRECT NAVIGATOR screen

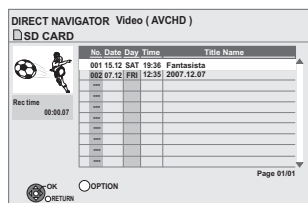

To exit the screen

Press [EXIT].

To display the top menu

Press [DIRECT NAVIGATOR].

When the top menu or the “DIRECT NAVIGATOR” is not displayed

Refer to “Starting from a selected title” (⇒ 39) to playback.

Operation during play (⇒ 39)

Note

- Set “Play Video (AVCHD) on BD-RE / BD-R” to “On” for the disc that has high definition video (AVCHD) recorded on the Panasonic's video camera, etc. and high definition quality title that was recorded on this unit. (⇒ 89)
- Multiple titles may not playback continuously depending on the disc. Press [DIRECT NAVIGATOR], and playback by selecting the title.
- It may pause for a few seconds on the break of images when editing such as partial deletion is performed.
- High definition video (transfer rate of 24 Mbps or faster) cannot be played back correctly if it was recorded on a DVD compatible with double speed or slower.

If the menu screen (⇒ left) is not displayed, display it by performing the following operation.

- 1 Press [FUNCTION MENU].
- 2 **BD-RE** **RAM** **-R** **-R DL** **-RW(V)** **+R** **+R DL** **+RW**
Press [▲, ▼] to select “Blu-ray Disc / DVD” and press [OK].
SD
Press [▲, ▼] to select “SD Card” and press [OK].

Playing
back

Playback of the playlist created on other equipment

BD-RE **BD-R** **RAM** **-RW(VR)**

Creation or editing of playlists cannot be done on this unit.

Preparation

- Insert a disc.

1 While stopped Press [FUNCTION MENU].

2 Press [▲, ▼] to select “Blu-ray Disc / DVD” and press [OK].

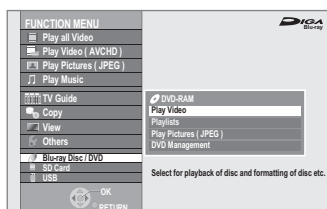

3 Press [▲, ▼] to select “Playlists” and press [OK].

4 Press [▲, ▼, ◀, ▶] to select the playlist and press [OK].

e.g., **RAM**

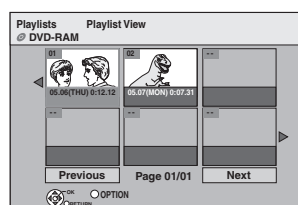

To return to the previous screen

Press [RETURN ↵].

To exit the screen

Press [EXIT].

Operation during play (⇒ 39)

Playing DivX video contents

-R -R DL CD USB

ABOUT DIVX VIDEO:

DivX® is a digital video format created by DivX, Inc. This is an official DivX Certified device that plays DivX video.

You can play DivX video contents recorded with a computer onto DVD-R, DVD-R DL, CD-R/CD-RW and USB memory.

1 Insert a disc or USB memory.

-R -R DL CD

e.g., **CD**

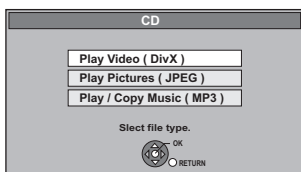

- It will go to step 3 automatically if only DivX is recorded on the disc.

USB

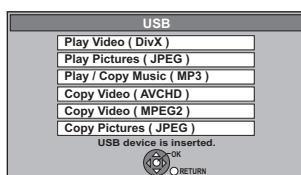

- Display items differ depending on what is recorded in each media.

2 Press [▲, ▼] to select “Play Video (DivX)” and press [OK].

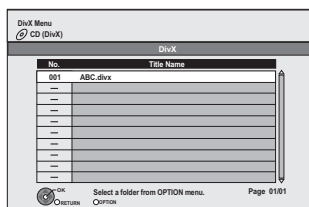

- Files are treated as titles.

3 Press [▲, ▼] to select the title and press [OK].

Play starts on the selected title.

To stop playing

Press [■].

To show other pages

Press [◀, ▶].

To exit the screen

Press [DIRECT NAVIGATOR].

If the menu screen (⇒ above) is not displayed, display it by performing the following operation.

1 Press [FUNCTION MENU].

2 **-R -R DL CD**

Press [▲, ▼] to select “Blu-ray Disc / DVD” and press [OK].

USB

Press [▲, ▼] to select “USB” and press [OK].

Note

- Picture sizes set at the recording time may prevent the unit from showing pictures in the adequate aspect. You may be able to adjust the aspect through the TV.
- Successive play is not possible.
- Playback is not possible during recording.

Using the tree screen to find a folder

1 While the file list is displayed

Press [OPTION].

2 Press [▲, ▼] to select “Select Folder” and press [OK].

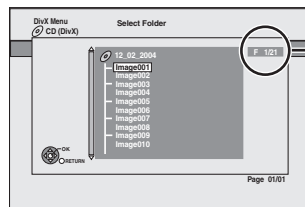

F: Selected folder no./
Total folder no. including
DivX title.

You cannot select folders
that contain no compatible
files.

3 Press [▲, ▼] to select a folder and press [OK].

The file list for the folder appears.

To return to the previous screen

Press [RETURN ↵].

Regarding DivX VOD content

ABOUT DIVX VIDEO-ON-DEMAND:

This DivX® Certified device must be registered in order to play DivX Video-on-Demand (VOD) content.

First generate the DivX VOD registration code for your device and submit it during the registration process.

[Important: DivX VOD content is protected by a DivX DRM (Digital Rights Management) system that restricts playback to registered DivX Certified devices. If you try to play DivX VOD content not authorized for your device, the message "Authorisation Error." will be displayed and your content will not play.]

Learn more at www.divx.com/vod.

Display the unit's registration code.

(⇒ 95, "DivX Registration")

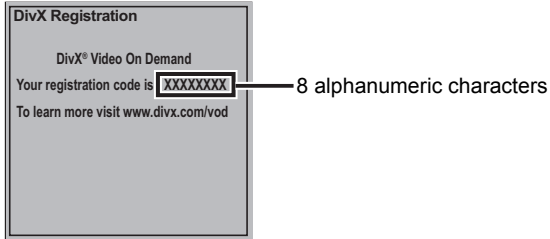

- After playing DivX VOD content for the first time, another registration code is then displayed in "DivX Registration". Do not use this registration code to purchase DivX VOD content. If you use this code to purchase DivX VOD content, and then play the content on this unit, you will no longer be able to play any content that you purchased using the previous code.
- If you purchase DivX VOD content using a registration code different from this unit's code, you will not be able to play this content. ("Authorisation Error." is displayed.)

Regarding DivX content that can only be played a set number of times

Some DivX VOD content can only be played a set number of times. When you play this content, the remaining number of plays is displayed. You cannot play this content when the number of remaining plays is zero. ("Rental Expired." is displayed.)

- The remaining number of plays decreases each time a program is played. However, when playing from the point where play was previously stopped, the remaining number of plays does not decrease due to the resume play function.

About DivX Subtitle Text display

You can display subtitles text recorded onto the DivX video disc on this unit.

This function has no relation to the subtitles specified in DivX standard specifications and has no clear standard. Depending on the methods used to create the file, the following functions may not work.

■ Displaying subtitles text

1 During play, press [DISPLAY].

- DivX video files that do not display "Text" do not contain subtitles text.

Subtitles text cannot be displayed.

2 Press [▲, ▼] to select "Disc" and press [▶].

3 Press [▲, ▼] to select "Subtitles" and press [▶].

4 Press [▲, ▼] to select "On".

- If the subtitles text are not displayed correctly, try changing the language settings (⇒ below).

■ Subtitles text language settings

After playing back a DivX video file containing subtitles text

1 Press [FUNCTION MENU].

2 Press [▲, ▼] to select "Others" and press [OK].

3 Press [▲, ▼] to select "Setup" and press [OK].

4 Press [▲, ▼] to select "HDD / Disc" and press [OK].

5 Press [▲, ▼] to select "Settings for Playback" and press [OK].

6 Press [▲, ▼] to select "DivX Subtitle Text" and press [OK].

7 Press [▲, ▼] to select "Latin 1", "Latin 2", or "Cyrillic" then press [OK].

- The initial setting is "Latin 1".

To exit the screen

Press [EXIT].

■ Types of subtitles text file that can be displayed

Subtitles text that satisfy the following conditions can be displayed on this unit.

- File format: MicroDVD, SubRip, or TMLPlayer.
- File extension: ".SRT", ".srt", ".SUB", ".sub", ".TXT", or ".txt"
- The DivX video file and subtitles text file are inside the same folder, and the file names are the same except for the file extensions.
- If there are more than one subtitles text files inside the same folder, they are displayed in the following order of priority: ".srt", ".sub", ".txt".

■ Limitations of this unit

- In the following situations, the subtitles cannot be displayed as recorded. Furthermore, depending on the methods used to create the file or the state of the recording, only parts of the subtitles may be displayed, or the subtitles may not be displayed at all.
 - When special text or characters are included in the subtitles text.
 - When the file size is larger than 256 KB.
 - When characters with styling specified are included in the subtitle data.
Codes that specify the character style within files are displayed as subtitle characters.
 - When data with a different format exists within the subtitle data.
- If the file name of the DivX video file is not displayed correctly on the menu screen (the file name is displayed as "_"), the subtitles text may not be displayed correctly.
- Depending on the disc, the subtitles text cannot be displayed when search and other such operations are being performed.

What is BONUSVIEW?

BONUSVIEW allows you to enjoy functions such as picture-in-picture or secondary audio etc., with BD-Video supporting BD-ROM Profile 1 version 1.1/Final Standard Profile.

What is BD-Live?

In addition to the BONUSVIEW function, BD-Video supporting BD-ROM profile 2 that has a network extension function allows you to enjoy more functions such as subtitles, exclusive images and online games by connecting this unit to the Internet. In order to use the Internet feature, you must have this unit connected to a broadband network. (⇒ 103)

- These discs may not be on sale in certain regions.
- The usable functions and the operating method may vary with each disc, please refer to the instructions on the disc and/or visit their website.

Playing secondary video (picture-in-picture) and secondary audio

Secondary video can be played from a disc compatible with the picture-in-picture function.

For the playback method, refer to the instructions for the disc.

Image of the secondary video

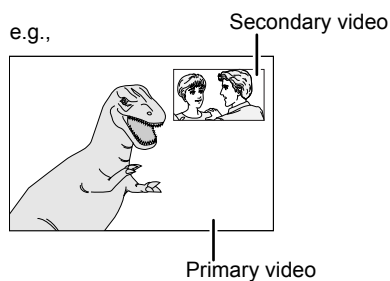

When the secondary video does not display

Turn the "Video" and "Soundtrack" to "On" in the "Secondary Video" in the "Signal Type" in the Disc menu. (⇒ 81)

- To output the audio of the secondary video, set the "BD-Video Secondary Audio" to "On" in the Setup menu (⇒ 91).

Note

- Discs may not always be played back according to the settings on this unit, as certain playback formats are prioritized on certain discs.
- Only the primary video is played during search/slow-motion/Quick View or frame-by-frame.
- When the secondary video is turned off, the secondary audio is not be played.

Enjoying BD-Live discs with Internet

Many BD-Live compatible discs require content to be downloaded onto an SD card (⇒ 118, Local storage) in order to access the available BD-Live features.

- An SD card with 1 GB or more of free space (SD Speed Class Rating 2 or higher) needs to be inserted prior to inserting the BD Live compatible disc.

Some BD-Live content available on the Blu-ray Disc may require an Internet account to be created in order to access the BD-Live content. Follow the screen display or instruction manual of the disc for information on acquiring an account.

Preparation

- Connect to the network. (⇒ 103)
- Set "Network Settings" in the Setup menu. (⇒ 94)

1 Insert an SD card (⇒ 15).

- If the SD card menu screen is displayed, press [RETURN ↵] to exit the SD card menu screen.

2 Insert the disc (⇒ 15).

- For operation method, refer to the instructions on the disc.

To use the above functions, it is recommended that you format the card on this unit. (⇒ 85)

Note

- While using this feature, do not remove the SD card. Doing so will cause playback to stop.
- A message may be displayed when SD card doesn't have enough storage capacity for BD-Live content. Please make space available on the current SD card, or insert another SD card.
- The unit must be connected to the Internet and set up (⇒ 96) to use the BD-Live functions. "BD-Live" may need to be changed for certain discs (⇒ 89).
- When discs supporting BD-Live are played back, the player or disc IDs may be sent to the content provider via the Internet.
- The unit is connected to the Internet when BD-Live functions are used, generating communication charges.
- The playback may be paused depending on the communication environment. Some functions may be disabled to prevent skipping to sections that have not been downloaded, etc.
- Delete the unnecessary video data recorded in the SD card by using "Delete BD-Video data". (⇒ 85)

Enjoying High Bit Rate Audio with 7.1ch speaker

This unit can decode High Bit Rate Audio (Dolby Digital Plus, Dolby TrueHD, DTS-HD High Resolution Audio and DTS-HD Master Audio) adopted in BD-Video.

To enjoy 7.1ch surround sound, the following conditions are necessary (Part shown in the shaded area of table given below).

- Connect an amplifier/receiver with 7.1ch speaker supporting HDMI (High Bit Rate Audio) using a High Speed HDMI cable. (⇒ 102)
- Set "BD-Video Secondary Audio" to "Off". (⇒ 91)
- Set "Dolby D/Dolby D +/Dolby TrueHD" or "DTS/DTS-HD" to "Bitstream" or "PCM". (⇒ 91)

About audio from audio output terminal

Connect an amplifier/receiver and confirm the desired audio type and necessary settings ("BD-Video Secondary Audio", "Dolby D/Dolby D +/Dolby TrueHD" or "DTS/DTS-HD").

- The number of channels listed is the maximum possible number of output channels.
- Also, depending on the specifications or the settings of the amplifier/receiver, the results of the output may vary.

Terminal	HDMI AV OUT				DIGITAL AUDIO OUT	
	"Bitstream" ^{*1}		"PCM" ^{*3}		"Bitstream"	"PCM"
"Dolby D/Dolby D +/Dolby TrueHD"/ "DTS/DTS-HD"						
"BD-Video Secondary Audio"	"On" ^{*2}	"Off"	"On"	"Off"	"On"/"Off"	"On"/"Off"
Dolby Digital/ Dolby Digital EX ^{*6}	Dolby Digital/ Dolby Digital EX ^{*7}	Dolby Digital/ Dolby Digital EX	DVD-V 5.1ch PCM BD-V 7.1ch ^{*4}		Dolby Digital/ Dolby Digital EX ^{*7}	Down-mixed 2ch PCM
Dolby Digital Plus	Dolby Digital	Dolby Digital Plus	7.1ch PCM ^{*2,4}	7.1ch PCM	Dolby Digital	
Dolby TrueHD		Dolby TrueHD				
DTS Digital Surround/ DTS-ES ^{*6}	DTS Digital Surround/ DTS-ES ^{*7}	DTS Digital Surround/ DTS-ES	DVD-V 5.1ch PCM BD-V 7.1ch PCM ^{*5}		DTS Digital Surround DTS-ES ^{*7}	
DTS-HD High Resolution Audio	DTS Digital Surround	DTS-HD High Resolution Audio	7.1ch PCM ^{*5}		DTS Digital Surround	
DTS-HD Master Audio		DTS-HD Master Audio				
7.1ch LPCM	7.1ch PCM				Down-mixed 2ch PCM	

^{*1} When the connected equipment is not supported with these audio format, the audio is output as Dolby Digital bitstream, DTS Digital Surround bitstream or down-mixed 2ch PCM (e.g., TV)

^{*2} **BD-V**: When playing BD-Video without secondary audio or clicking sound, the audio is output as the same format as if "BD-Video Secondary Audio" was set to "Off". (⇒ 91)

^{*3} When the connected equipment is not supported with multi channel surround, the audio is output as down-mixed 2ch PCM.

^{*4} **BD-V**: The audio is output as 5.1ch when "7.1ch Audio Reformatting" in the Setup menu (⇒ 93) is set to "Off".

^{*5} **BD-V**: The audio output is amplified from 5.1ch or 6.1ch to 7.1ch depending on the DTS, Inc. specifications regardless of the setting of "7.1ch Audio Reformatting" in the setup menu (⇒ 93).

^{*6} With PCM output, Dolby Digital EX becomes PCM audio decoded as Dolby Digital, DTS-ES recorded to DVD-Video becomes PCM audio decoded as DTS Digital Surround, and DTS-ES recorded to BD-Video becomes PCM audio decoded as DTS-ES.

^{*7} **BD-V**: When "BD-Video Secondary Audio" is set to "On", Dolby Digital EX is output as Dolby Digital and DTS-ES is output as DTS Digital Surround, however if playing BD-Video without secondary audio or clicking sound, the audio is output as the original format.

Note

- When setting "BD-Video Secondary Audio" to "Off", the clicking sound on the menu and audio with secondary video in picture-in-picture mode (⇒ 46) cannot be output.

Regarding 24p output

Many BD-Video movie contents are recorded in 24 frames/second in accordance with the film materials. However, they will normally be output in 60 frames/second in accordance with the display format.

These can be output in 24p as the original. Therefore, high-quality video can be enjoyed, such as the improved clarity, enhanced perspective, etc.

Preparation

- Connect to a TV supporting 1080/24p input via an HDMI cable.
- Set "BD-Video 24p Output" to "On". (⇒ 93)

HDD **BD-RE** **RAM**
BD-R **-R** **-R DL** **-RW(V)** **+R** **+R DL** (You cannot edit finalised discs.)
+RW
-RW(VR) Only "Properties" is possible.

Editing of the title can be performed with this unit.
 For example, an unrequired part of the title can be deleted. (⇒ 49, Partial Delete)

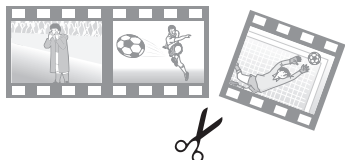

Note

- Once deleted, divided or partially deleted, recorded content cannot be restored to its original state. Make certain before proceeding.
- Restricted recording information remains even after editing (e.g. dividing a title etc).
- **BD-R** **+R** **+R DL** Each time you edit a title the information is saved to the free space on the disc. If you do this numerous times, the amount of free space decreases. We recommend that you edit on the HDD and then copy to disc.
- With titles that are copyright protected (Copying is prohibited), you cannot perform editing other than Delete, Properties. (⇒ 31)

Preparation

- Turn on the television and select the appropriate AV input to suit the connection to this unit.
- Turn the unit on.
- Press [DRIVE SELECT] to select the drive containing the recorded title to be edited. Select "BD" for any discs.
- **BD-RE** **BD-R** **RAM** Release protection (⇒ 84, Setting the protection).

- 1 Press [DIRECT NAVIGATOR].
- 2 Press [▲, ▼] to select the title.

e.g., **HDD**

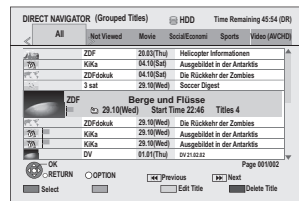

To show other pages

Press [◀, ▶].

Multiple editing

Select with [▲, ▼] and press the "Red" button. (Repeat.) A check mark appears. Press the "Red" button again to cancel.

- 3 Press [OPTION].
- 4 Press [▲, ▼] to select the operation and press [OK].

• If you select "Edit", press [▲, ▼] to select the operation and press [OK].

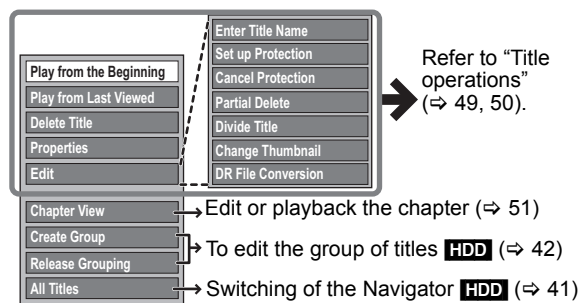

To return to the previous screen

Press [RETURN ⇨].

To exit the screen

Press [DIRECT NAVIGATOR].

Title operations

After performing steps 1–4 (⇒ 48)

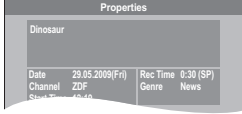
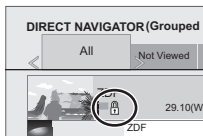
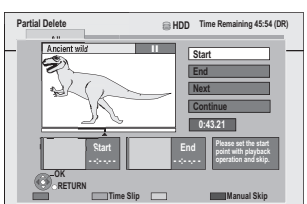
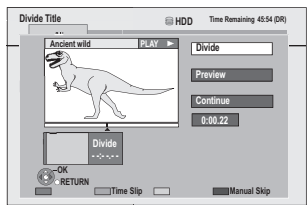
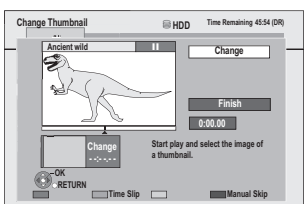
<p>Delete Title*</p> <p>HDD BD-RE BD-R RAM -R -R DL -RW(V) +R +R DL +RW</p>	<p>Press [◀, ▶] to select “Delete” and press [OK].</p> <ul style="list-style-type: none"> • Once deleted, the recorded contents are lost and cannot be restored. Make certain before proceeding. • The available recording space on BD-R, DVD-R, DVD-R DL, +R or +R DL does not increase when you delete titles. • Available recording space on DVD-RW (DVD-Video format) and +RW increases only when the last recorded title is deleted. It does not increase if other titles are deleted (⇒ 25).
<p>Properties</p> <p>HDD BD-RE BD-R RAM -R -R DL -RW(V) +R +R DL +RW -RW(VR)</p>	<p>Information (e.g., time and date) is shown.</p> <ul style="list-style-type: none"> • Press [OK] to exit the screen. <p>e.g., HDD</p> 
<p>Enter Title Name</p> <p>HDD BD-RE BD-R RAM -R -R DL -RW(V) +R +R DL +RW</p>	<p>You can give names to recorded titles. (⇒ 80, Entering text)</p> <ul style="list-style-type: none"> • HDD Even if the group name is changed, the title names in the group will not be changed.
<p>Set up Protection*</p> <p>Cancel Protection*</p> <p>HDD BD-RE BD-R RAM +R +R DL +RW</p>	<p>If set, this will protect the title from accidental deletion.</p> <p>Press [◀, ▶] to select “Yes” and press [OK]. The lock symbol appears when the title is protected.</p> 
<p>Partial Delete</p> <p>HDD BD-RE BD-R RAM (⇒ below, For your reference)</p>	<p>You can remove unnecessary part of the recording.</p> <ol style="list-style-type: none"> 1 Press [OK] at the start point and end point of the section you want to delete. <ul style="list-style-type: none"> • Press [▶] (PLAY) to start the playback when the title is paused. 2 Press [▲, ▼] to select “Continue” and press [OK]. <ul style="list-style-type: none"> • Select “Next” and press [OK] to delete other sections. Up to 20 sections can be set. (⇒ go to step 1) 3 Press [◀, ▶] to select “Delete” and press [OK]. <ul style="list-style-type: none"> • Chapter Mark is generated in the scene that was partially deleted. 4 Press [RETURN ↵]. <ul style="list-style-type: none"> • You cannot perform this operation when you select the radio programme. 
<p>Divide Title</p> <p>HDD BD-RE BD-R RAM (⇒ below, For your reference)</p>	<p>You can divide a title into two.</p> <ol style="list-style-type: none"> 1 Press [OK] at the point you want to divide the title. 2 Press [▲, ▼] to select “Continue” and press [OK]. 3 Press [◀, ▶] to select “Divide” and press [OK]. <ul style="list-style-type: none"> To confirm the division point Press [▲, ▼] to select “Preview” and press [OK]. (The unit plays 10 seconds before and after the division point.) To change the division point Restart play and press [▲, ▼] to select “Divide”, then press [OK] at the point where you want to divide the title. <p>Note</p> <ul style="list-style-type: none"> • The divided titles retain the title name and copy-restriction of the original title. • Video and audio just before and after the dividing point may momentarily cut out. • HDD Divided titles form a group of titles. • You cannot perform this operation when you select the radio programme. 
<p>Change Thumbnail</p> <p>HDD RAM -R -R DL -RW(V) +R +R DL +RW (⇒ below, For your reference)</p>	<p>-R -R DL -RW(V) +R +R DL It is possible to change the image displayed on the top menu after finalising.</p> <p>+RW It is possible to change the image displayed on the top menu after creating Top Menu.</p> <p>HDD Settings for the “Change Thumbnail” is saved when high speed copy is performed to DVD-R, DVD-R DL, DVD-RW (DVD-Video format), +R, +R DL or +RW.</p> <ol style="list-style-type: none"> 1 Press [▶] (PLAY) to start play. 2 Press [OK] when the image you want to use as a thumbnail is shown. <ul style="list-style-type: none"> To change the thumbnail Restart play and press [▲, ▼] to select “Change”, then press [OK] at the point you want to change. 3 Press [▲, ▼] to select “Finish” and press [OK]. <ul style="list-style-type: none"> • You cannot perform this operation when you select the radio programme. 

* Multiple editing is possible.

For your reference

- Use Search (⇒ 39), Time Slip (⇒ 40) to find the desired point.
- To find the desired point correctly, use Slow-motion (⇒ 39) and Frame-by-frame (⇒ 40).
- To skip to the start or end of a title, press [**◀◀**] (start) or [**▶▶**] (end).

Title operations

After performing steps 1–4 (⇒ 48)

DR File Conversion

HDD
(Converting the recording mode)

DR File Conversion is a function to convert the recording mode of the title in DR mode. The size of the converted title will be small regularly. It will take about the same time as playback of the title to convert the recording mode.

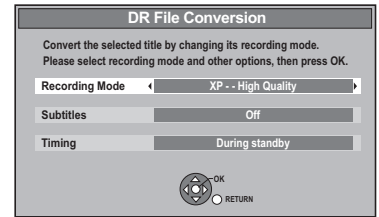

① Press [◀, ▶] to select recording mode and press [▼].

② Press [◀, ▶] to select whether to record the subtitle or not and press [▼].

“Automatic”

Subtitles will be recorded for titles with subtitles.
You cannot switch the subtitle on or off during the playback.

“Off”

Subtitle will not be recorded.

③ Press [◀, ▶] to select when to start the conversion and press [OK].

“Now”

Conversion begins immediately after step ⑤.
Recording and playback are not available during conversion. Note also that Timer recording will not be performed during conversion.

“During standby”

The conversion will be performed a short time after the unit is turned off in a time slot for which no timer recording is set. If the power is switched on during the conversion, the conversion will be cancelled, and start from the beginning when the power is next switched off.

④ Press [◀, ▶] to select whether to delete the original title after the conversion or not and press [OK].

“Convert & Delete”

The original title will be deleted to save HDD capacity after conversion.

“Convert Only”

The original title remains after conversion.

- The original title in DR format will be deleted after DR File Conversion when a title that is copyright protected (One generation copy is permitted) is selected.

⑤ To begin the conversion “Now”:
Press [◀, ▶] to select “Start” and press [OK].

- To cancel a conversion that is in progress
Press and hold [RETURN ↵] for more than 3 seconds.

To begin the conversion “During standby”:
Press [OK].

- To remove a conversion setting
After performing steps 1–3 (⇒ 48)
1 Press [▲, ▼] to select “DR File Conversion” and press [OK].
2 Press [◀, ▶] to select “Yes” and press [OK].
- Conversion begins soon after the unit is turned off.
“COPY” on the unit’s display remains lighted during conversion. [Only when the “Unit’s Display” in the Setup menu is set to “Bright” (⇒ 92).]

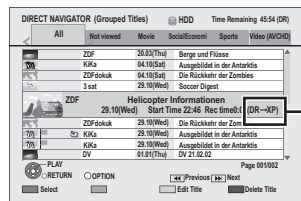

When “DR → ○○ (Recording mode for conversion)” is displayed in the DIRECT NAVIGATOR, the conversion has not finished.

Note

- To use “DR File Conversion”, the HDD needs enough storage capacity. Please make space available on the HDD.
- The size of the converted title may increase for some combinations of programme and recording mode.
- DR File Conversion is stopped when the power is turned on while the recording mode is converting with power turned off. Conversion will start from the beginning again once the power is turned off.
- The converted one of a title including multiple video and audio content will contain only single video and audio content. The “Preferred Language” setting in the Setup menu (⇒ 89) is applied.
- During the conversion “Now” with “Subtitles” set to “Automatic” in step ②, you cannot turn off the subtitle displayed on the television.
- Teletext will not be recorded.
- When recording to DVD disc with XP mode, select the audio to record with “Audio Mode for XP Recording” before converting the recording mode. (⇒ 92)
- Select the audio to record when converting to “HG”, “HX”, “HE”, or “HL” mode. (⇒ 92, Audio Channels for HG / HX / HE / HL Recording)
- In titles with the Auto Renewal Recording function (⇒ 36) set, a programme may be unintentionally converted while in “During standby”.
So it is recommended to convert the recording mode by selecting “Now”.
- The aspect ratio will be recorded in accordance with “Aspect for Recording” of the Setup menu, regardless of the recording mode for conversion. (⇒ 90)
When converting to “XP”, “SP”, “LP” or “EP” mode, the title will be recorded with original aspect ratio if “Rec for High Speed Copy” is set to “Off”. (⇒ 90)
- **Regarding titles recorded from radio service**
The data size of the title recorded from radio service will be larger after converted for copy.
It is recommended that you keep them in DR mode.

Create/Playback/Edit of the Chapter

HDD **BD-RE** **BD-R** **RAM**
-R **-R DL** **-RW(V)** **-RW(VR)** **+R** **+R DL** **+RW** Only playback of chapter is possible.

Chapter
 Each section between the division points becomes a chapter.



“Chapter Creation” in the Setup menu (⇒ 90)

HDD **BD-RE** **BD-R**

“Automatic”:

Detects changes in the scene (like the start and the end of the programme) during recording and sets chapter start points on them automatically.

- Depending on the programme to be recorded or the Recording Mode, the chapter start points may not be created correctly.

“5 minutes”:

Sets chapter start points automatically during recording at approximately 5-minute interval.

- Chapters will not be created:
 - when recording a radio broadcast
 - when recording from the AV Input or DV input

- The maximum number of chapters on a disc: (Depends on the state of recording.)

HDD: Approx. 1000 per title

BD-RE **BD-R** **RAM**: Approx. 1000 per disc

Note

- **HDD** You will not be able to perform the Resume play function (⇒ 39) or the “Change Thumbnail” (⇒ 49) with a title with the maximum number of chapters.
- **HDD** Chapter Marks created will be maintained when copied or used “DR File Conversion”. But, it will not maintain the exceeded amount if it exceeds the maximum chapter numbers.

Create Chapter Mark

During the playback or pause
 Press **[CREATE CHAPTER]**.

- Chapters are divided at the point pressed.

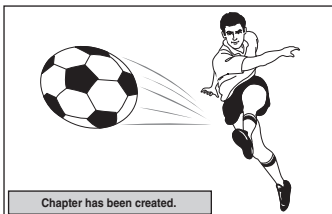

■ To delete the Chapter Mark

- 1 While paused
 Press **[◀, ▶]** and skip to the location you want to delete.
- 2 Press **[CREATE CHAPTER]**.
- 3 Press **[◀, ▶]** to select “Yes” and press **[OK]**.

Editing and playing chapters

Preparation

- Press **[DRIVE SELECT]** to select the HDD or BD drive. Select “BD” for any discs. BD indicator will light up.
- **BD-RE** **BD-R** **RAM** Release protection (⇒ 84, Setting the protection).

1 Press **[DIRECT NAVIGATOR]**.

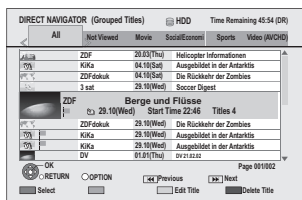

- 2 Press **[▲, ▼]** to select the title and press **[OPTION]**.
- 3 Press **[▲, ▼]** to select “Chapter View” and press **[OK]**.
- 4 Press **[◀, ▶]** to select the chapter.
 To start play ⇒ Press **[OK]**.
 To edit ⇒ Step 5.
 To create ⇒ Press the “Green” button. (⇒ below, Create Chapter)

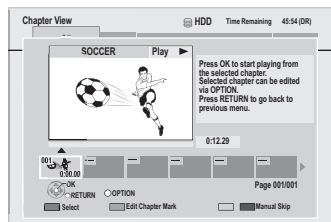

Chapter View screen

- 5 Press **[OPTION]**, then **[▲, ▼]** to select the operation and press **[OK]**.

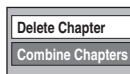

➔ Refer to “Chapter operations”.

To return to the previous screen

Press **[RETURN ↵]**.

To exit the screen

Press **[EXIT]**.

Note

- You cannot perform this operation when you select the radio programme.

Chapter operations

After performing steps 1–4 (⇒ left)

Create Chapter

Select the point where you want to start a new chapter while viewing the title.

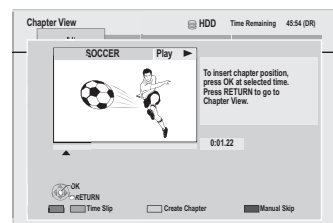

- ① Press **[OK]** at the point you want to divide.
 - Repeat this step to divide at other points.
- ② Press **[RETURN ↵]** to go to Chapter View screen.

After performing steps 1–5 (⇒ left)

Delete Chapter*

Press **[◀, ▶]** to select “Delete” and press **[OK]**.

- Once deleted, the recorded contents are lost and cannot be restored. Make certain before proceeding.
- Select “Combine Chapters” (⇒ below) when you only want to delete the division point between chapters. (The recorded contents will not be deleted.)

Combine Chapters

Press **[◀, ▶]** to select “Combine” and press **[OK]**.

- The selected chapter and following chapter are combined.

* Multiple editing is possible. Select with **[◀, ▶]** and press the “Red” button. (Repeat.) A check mark appears. Press the “Red” button again to cancel.

Copying titles

There are following copying methods.

Copy Title Playing	Copy the playing title on the HDD to the disc. (⇒ 55)
Copy	Make a copying list and then copy. You can set the unit to copy titles in the way you want. (⇒ 56)
Copy Video (AVCHD)	High definition video (AVCHD format) can be copied from disc, SD card, or USB. (⇒ 62)

■ Copy direction

Copy source	Copy destination	Possible copying method	Copy speed
HDD	BD-RE BD-R RAM -R -R DL -RW(V) +R +R DL +RW	Copy Title Playing Copy	<ul style="list-style-type: none"> The high speed copy may not be possible depending on the destination disc or the title to copy. (⇒ 54, When is high speed copy not possible?)
BD-RE BD-R	HDD	Copy	Normal speed
RAM -RW(VR)	HDD	Copy	High speed
+RW	HDD	Copy	Normal speed
Before finalise -R -R DL -RW(V) +R +R DL		Cannot copy	
DVD-V After finalise -R -R DL -RW(V) +R +R DL	HDD	Copy	Normal speed
SD Video (MPEG2 format) <ul style="list-style-type: none"> From an SD card or Panasonic's video camera, etc. (from USB) 	HDD RAM	Copy	High speed
	BD-RE BD-R -R -R DL -RW(V) +R +R DL +RW		Cannot copy
HD Video (AVCHD format) <ul style="list-style-type: none"> From discs 	HDD	Copy Video (AVCHD)	High speed
HD Video (AVCHD format) <ul style="list-style-type: none"> From an SD card or Panasonic's video camera, etc. (from USB) 	HDD BD-RE BD-R	Copy Video (AVCHD)	High speed
	RAM -R -R DL -RW(V) +R +R DL +RW		Cannot copy

Note

● Almost all DVD-Video on sale have been treated to prevent illegal copying. Any software that has been treated so, cannot be copied using this unit.

■ Copy speed

(○: Possible, -: Impossible)

	High speed mode	Normal speed mode
Features	Copy with shorter time than the recorded time of the title with same quality (recording mode).	It will take same or longer time as the recorded time of the copying title. ● Even if you select a recording mode with better picture quality than the original, the picture quality does not improve.
Are chapters maintained?	○*1	○*1
Are thumbnails maintained?	○	○*2
Recording and Playing while Copying	○*3	-

*1 Position of the chapter might shift slightly.

It will not maintain the exceeded amount if it exceeds the maximum chapter numbers on a disc.

- **BD-RE** **BD-R** **RAM** **-R** **-R DL** **-RW(V)** : Approx. 1000

- **+R** **+R DL** **+RW** : Approx. 254

(Depends on the state of recording.)

*2 Position of the thumbnails might shift slightly. (May not be maintained depending on the state of recording.)

*3 Possible only with titles on the HDD

[However it is not possible when copying with finalisation, creating Top Menu or when copying SD Video (MPEG2 format) or when copying HD Video (AVCHD format).]

- You cannot perform chasing play or edit, etc. while copying.

- Still pictures or music cannot be played.

Maximum writing speed of discs

BD-RE (DL):	2x Speed	DVD-RAM:	5x Speed	+R:	8x Speed
BD-RE:	2x Speed	DVD-R:	12x Speed	+R DL:	4x Speed
BD-R (DL):	6x Speed	DVD-R DL:	4x Speed	+RW:	4x Speed
BD-R:	6x Speed	DVD-RW:	4x Speed		

Copying speed when copying from the HDD to BD-R in High Speed Copy

Approx.

HDD		▶	6X Speed BD-R (DL, 50 GB/SL, 25 GB)	
Recording Mode	Recorded Programme		Required time	Speed
HL	1 hour		1 min. 24 s.	43x

Note

- The above rate in the list indicates the shortest time and fastest speed required for copying one-hour title from HDD to the disc by High-Speed copying.
- The required amount of time and speed may vary depending on the conditions such as the area where information is written or unique feature on the disc.

■ Copying titles that are copyright protected

Copying not restricted

- There are titles that can only be handled by HDD, BD-RE, BD-R, or DVD-RAM (CPRM compatible discs only).

One generation copy is permitted

- You can copy to BD-RE, BD-R or DVD-RAM (CPRM compatible discs only) only once. However, the original title will be deleted. (⇒ 31, 118)
- You cannot copy to a DVD-RAM (not compatible with CPRM), DVD-R, DVD-R DL, DVD-RW, +R, +R DL or +RW.
- You cannot copy from the copied disc to another disc.

Copying is prohibited

- You cannot copy to disc.

■ Frequently asked questions

<p>When is high speed copy not possible?</p>	<p>It will copy at normal speed in following cases:</p> <ul style="list-style-type: none"> ● Copying XP, SP, LP, EP, or FR mode title to BD-RE or BD-R ● Copying to DVD-RAM, DVD-R, DVD-R DL, DVD-RW, +R, +R DL or +RW in following conditions: <ul style="list-style-type: none"> – Titles in DR, HG, HX, HE, HL mode – Title of the AVCHD copied to the HDD ● Copying to DVD-R, DVD-R DL, DVD-RW, +R, +R DL or +RW in following conditions: <ul style="list-style-type: none"> – Copy including a title that was recorded to HDD with “Rec for High Speed Copy” set to “Off” (⇒ 90) – Titles that contain many deleted segments. – Titles that have been copied to the HDD from an SD card or a Panasonic’s video camera, etc. with HDD (SD Video) (⇒ 63). – +R +R DL +RW Titles recorded in “EP” mode and “FR (recordings 5 hours or longer)” mode. – +R +R DL +RW Titles recorded in 16:9 aspect – -R -R DL -RW(V) Titles recorded in 16:9 aspect using “EP” mode or “FR (recordings 5 hours or longer)” mode ● Setting the “Recording Mode” to anything but “High Speed” in “Copy” ● Copying from BD-RE, BD-R or +RW to HDD ● -R -R DL -RW(V) +R +R DL When copying from the finalised disc to HDD
<p>When copying titles in high speed mode to high speed recording compatible discs</p>	<p>The sound of the disc rotating becomes louder than normal. If you want copy to perform more quietly, select “Normal (Silent)” in “BD / DVD Speed for High Speed Copy” in the Setup menu (⇒ 90).</p>
<p>-R -R DL -RW(V) +R +R DL +RW When copying to disc in normal speed mode</p>	<p>When not copying in high speed mode, titles are temporarily copied at normal speed to the HDD and then copied at high speed to the disc. The titles that were temporarily copied to the HDD are then deleted. You cannot copy to the disc in the following cases. – When there is not enough free space on the HDD. (When copying to a new blank disc, if you intend to fill a new disc when copying to it, the equivalent of up to 4 hours of free space in SP mode is needed on the HDD.) – When the number of titles recorded to the HDD and the number of titles to be copied to the disc is greater than 999 in total.</p>
<p>When stopping the copy during copy</p>	<p>When High-speed copying All titles that have completely copied at the point cancelled are copied. When Normal Speed copying Copies until the point cancelled. ● -R -R DL -RW(V) +R +R DL +RW If copy is cancelled during the step while temporarily copying to the HDD, then nothing will be copied. However, if copy is cancelled during the step while copying to disc from the HDD, then only titles completely copied at the point cancelled are copied. Even if the title was not copied to the BD-R, DVD-R, DVD-R DL, DVD-RW (DVD-Video format), +R, +R DL or +RW, the amount of remaining writable disc space becomes less.</p>
<p>Is it possible to copy to the disc, SD card, or USB memory after copying HD video (AVCHD format) to the HDD?</p>	<ul style="list-style-type: none"> ● It can be copied to the disc. <ul style="list-style-type: none"> – BD-RE BD-R It can be copied with HD quality. – RAM -R -R DL -RW(V) +R +R DL +RW It will be copied with SD quality. (It cannot be copied as it is in HD picture quality.) ● It cannot be copied to SD card or USB memory.
<p>Regarding titles recorded in DR mode from radio service</p>	<ul style="list-style-type: none"> ● Picture data will be added to the titles recorded in DR mode from radio service when copying them in HG, HX, HE, HL, XP, SP, LP, EP or FR mode or converting them to these recording modes using “DR File Conversion”. Therefore, the data size will be larger after copying or “DR File Conversion”. <ul style="list-style-type: none"> – If you are going to copy the titles to disc with least audio degradation It is recommended that you select LP mode. – If you are going to copy the titles to disc with least data size It is recommended that you select them to EP (8 hours) mode. ● Title recorded from radio service cannot be copied in DR mode.
<p>MPEG-2 or AVCHD files are not recognised</p>	<ul style="list-style-type: none"> ● Only MPEG2 or AVCHD recorded or edited on a Panasonic’s video camera will be recognised. MPEG2 or AVCHD recorded or edited to USB memory or an SD card using devices other than a Panasonic’s video camera may not be recognised.

Copy Title Playing

Copy the playing title on the HDD to the disc.

- It will start copying from the beginning of the title regardless of the playing position.

HDD → **BD-RE** **BD-R** **RAM** **-R** **-R DL** **-RW(V)** **+R** **+R DL** **+RW**

1 Playback the title to copy.



When copying the title in DR mode with multiple audio, subtitles and Teletext

BD-RE **BD-R**

- Audio, subtitles and Teletext can be copied as is.

RAM **-R** **-R DL** **-RW(V)** **+R** **+R DL** **+RW**

- Only the audio selected in the “Multi Audio” in the Disc menu will be copied for the multiple audio. (⇒ 81).
- Subtitle displayed during playback will be copied. Press [STTL] to display the subtitle. Select the subtitle with “Subtitles” in the Disc menu (⇒ 81)
- Teletext displayed during playback will be copied. Press [TEXT] to display the Teletext.

2 Press [OPTION].

3 Press [▲, ▼] to select “Copy Title Playing” and press [OK].

4 Press [◀, ▶] to select “Start” and press [OK].

To stop copying

Press and hold [RETURN] for 3 seconds.

To return to the previous screen

Press [RETURN].

Recording and playing while copying

You can record and play using the HDD while high speed copying.

Press [OK] to disappear the screen display.

- Still pictures and music recorded on the HDD cannot be played.

• To confirm the current progress

Press [STATUS].

Note

- Timer recordings executed while copying are recorded to the HDD regardless of the recording drive settings. (Only when high speed copying)

Speed and recording mode when copying

Titles in DR, HG, HX, HE or HL modes

Copy destination	Copy Speed	Recording mode
BD-RE BD-R	High speed*	Same as title to be copied*
RAM -R -R DL -RW(V) +R +R DL +RW	Normal speed	FR

* When copying over the available space on the disc, one from HG, HX, HE, or HL modes will be selected to match the available space, and it will be copied with normal speed.

- When copying at normal speed, only the audio selected in the “Multi Audio” in the Disc menu will be copied for the multiple audio. (⇒ 81)
- When copying at normal speed, subtitle displayed during playback will be copied. Press [STTL] to display the subtitle. Select the subtitle with “Subtitles” in the Disc menu (⇒ 81)
- When copying at normal speed, Teletext displayed during playback will be copied. Press [TEXT] to display the Teletext.

Titles in XP, SP, LP, EP or FR modes

Copy destination	Copy Speed	Recording mode
BD-RE BD-R	Normal speed	Recording mode of playing back title* ¹
RAM	High speed* ¹	Same as title to be copied* ¹
-R -R DL -RW(V) +R +R DL +RW	High speed* ^{1, *2}	Same as title to be copied* ¹

*¹ When the copy destination (disc) does not have enough space, copy will perform at normal speed in FR mode.

*² Titles that were recorded with “Rec for High Speed Copy” (⇒ 90) set to “Off” will be copied with normal speed.

In the following cases, even if “Rec for High Speed Copy” is set to “On”, copy will perform at normal speed.

- **+R** **+R DL** **+RW** When the copying source was recorded in “EP” or “FR (recordings 5 hours or longer)” mode.
- When the copy destination (disc) does not have enough space.
- When the title aspect for the copying source and the “Aspect for Recording” (⇒ 90) setting do not match.
- When the title aspect for the copying source is 16:9:
 - **+R** **+R DL** **+RW**
 - **-R** **-R DL** **-RW(V)** copying source was recorded in “EP” or “FR (recordings 5 hours or longer)” mode.

To play DVD-R, DVD-R DL, DVD-RW (DVD-Video format), +R and +R DL on other players, it is necessary to finalise them after copy (⇒ 86). To play +RW on other players, we recommend you create top menu (⇒ 86), but they may not play on all DVD players.

Copying using the copying list—Copy

You can order titles as desired for copy to disc.

HDD ↔ **BD-RE** **BD-R** **RAM** **+RW**

-RW(VR) → **HDD**

HDD → **-R** **-R DL** **-RW(V)** **+R** **+R DL**

When copying the title in DR mode with multiple audio and subtitles

BD-RE **BD-R** **HDD**

- When copying at high speed, audio and subtitles can be copied as is.

- When copying at normal speed, only the audio and subtitles selected in the “Preferred Language” in the Setup menu will be copied for the multiple audio and subtitles. (⇒ 89)

RAM **-R** **-R DL** **-RW(V)** **+R** **+R DL** **+RW**

- Only the audio and subtitles selected in the “Preferred Language” in the Setup menu will be copied for the multiple audio and subtitles. (⇒ 89).

1 While stopped

Press **[FUNCTION MENU]**.

2 Press **[▲, ▼]** to select “Copy” and press **[OK]**.

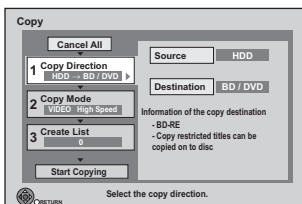

- If you are not going to change the each setting (⇒ step 7).

3 Set the copy direction.

- If you are not going to change the copying direction (⇒ step 4).

- 1 Press **[▲, ▼]** to select “Copy Direction” and press **[▶]**.
- 2 Press **[▲, ▼]** to select “Source” and press **[OK]**.
- 3 Press **[▲, ▼]** to select the drive and press **[OK]**.
If you select “HDD”, “Destination” is automatically set to “BD/DVD”, or vice versa. (⇒ step 6)
- 4 Press **[▲, ▼]** to select “Destination” and press **[OK]**.
- 5 Press **[▲, ▼]** to select the drive and press **[OK]**.
The same drive as the copy source cannot be selected.
- 6 Press **[◀]** to confirm.

4 Set the recording mode.

- If you are not going to change the recording mode (⇒ step 5).

- 1 Press **[▲, ▼]** to select “Copy Mode” and press **[▶]**.
- 2 Press **[▲, ▼]** to select “Format” and press **[OK]**.
- 3 Press **[▲, ▼]** to select “VIDEO” and press **[OK]**.
- 4 Press **[▲, ▼]** to select “Recording Mode” and press **[OK]**.
- 5 Press **[▲, ▼]** to select the mode and press **[OK]**.
- 6 Press **[◀]** to confirm.

5 Register titles for copy.

- If you are going to copy a registered list without making any changes to it (⇒ step 6).

- 1 Press **[▲, ▼]** to select “Create List” and press **[▶]**.

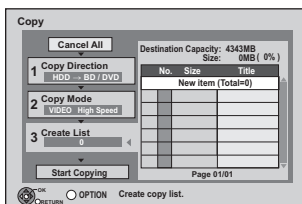

- 2 Press **[▲, ▼]** to select “New item” and press **[OK]**.

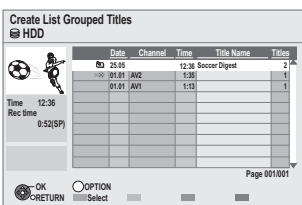

- 3 Press **[▲, ▼]** to select the title and press the “Red” button.

A check mark is displayed. Repeat this step until you select all necessary items.

- Press the “Red” button again to cancel.
- The items will be copied in the order of the copying list. If you want to specify the order, repeat selecting one item at a time.

- Titles indicated with “▶❌” can not be copied in high speed mode.

- **To show other pages**
Press **[◀◀, ▶▶]**.

- 4 Press **[OK]**.

- **To edit the copying list (⇒ 57)**

You cannot start copying when the value of the “Size” (⇒ 57) exceeds 100% (“Destination Capacity” is not sufficient).

- 5 Press **[◀]** to confirm.

6 Set other settings.

- If you are not going to change these settings (⇒ step 7)

- 1 Press **[▲, ▼]** to select “Other Settings” and press **[▶]**.

“Subtitles”

(Only when copying titles in DR mode and the recording mode other than High Speed is selected)

- 2 Press **[▲, ▼]** to select “Subtitles” and press **[OK]**.

- 3 Press **[▲, ▼]** to select “Automatic” or “Off” and press **[OK]**.

- **“Automatic”:**

Subtitle selected in the “Preferred Language” in the Setup menu (⇒ 89) will be copied.

- **“Off”:**

Subtitle in the source titles will not be copied.

“Finalise” or “Create Top Menu”

(**HDD** → **-R** **-R DL** **-RW(V)** **+R** **+R DL** **+RW** only)

- 2 Press **[▲, ▼]** to select “Finalise” or “Create Top Menu” and press **[OK]**.

- 3 Press **[▲, ▼]** to select “On” or “Off” and press **[OK]**.

- If **“On”** is selected

- **-R -R DL -RW(V) +R +R DL** After finalising, the discs become play-only and you can also play them on other DVD equipment. However, you can no longer record or edit.

- **+RW** Create the Top Menu. Top Menu is a convenient function. We recommend you create the menu before playing a +RW disc on other equipment.

- 4 Press **[◀]** to confirm.

7 Press **[▲, ▼]** to select “Start Copying” and press **[OK]**.

8 Press **[◀, ▶]** to select “Yes” and press **[OK]** to start copying.

To return to the previous screen in steps 1 to 7

Press **[RETURN ↵]**.

To stop copying

Press and hold **[RETURN ↵]** for 3 seconds.

(You cannot stop while finalising or creating Top Menu)

Recording and playing while copying

You can record and play using the HDD while high speed copying. (Only when high speed copying without finalising or creating Top Menu).

Press **[OK]** to disappear the screen display.

- Still pictures and music recorded on the HDD cannot be played.

- **To confirm the current progress**

Press **[STATUS ⓘ]**.

Note

- Titles in the grouped titles and other titles cannot be registered simultaneously.

- Timer recordings executed while copying are recorded to the HDD regardless of the recording drive settings.

(Only when high speed copying without finalising or creating Top Menu)

Copying list icons and functions

Copying list indicators



Titles that cannot be copied in high speed mode to the inserted disc



Title contains still picture(s)
 • Still picture(s) cannot be copied.



(NTSC)

Title recorded using a different encoding system from that of the TV system currently selected on the unit.



(PAL)

• Titles displaying these marks cannot be selected.

Data size of each registered item

No.	Size	Title
New Item		(Total=0)

Page 01/01

Size:

Data size recorded to the copy destination

- When copying at normal speed, the total data size will change according to the recording mode.
- The total data size shown may be larger than the sum of the data sizes for each registered item, because of data management information being written to the copy destination, etc.

To play DVD-R, DVD-R DL, DVD-RW (DVD-Video format), +R and +R DL on other players, it is necessary to finalise them after copy (⇒ 86). To play +RW on other players, we recommend you create top menu (⇒ 86), but they may not play on all DVD players.

■ To check the properties of a title and sort Copying list

After performing step 5-② (⇒ 56)

- 1 Press [▲, ▼] to select the title and press [OPTION].



- 2 Press [▲, ▼] to select "Properties" or "Sort" and press [OK].

Properties:

The name, recording date, channel etc. of the selected title are shown. (You cannot select a title if it has a check mark.)

Sort (All Titles screen only):

Press [▲, ▼] to select the item and press [OK].

This changes the way that titles are displayed. You can select to display titles by No., recording date, day, channel, recording start time and title name. (You cannot select a title if it has a check mark.) If you close the Copying list screen, the display order is cancelled.

■ To edit the copying list

Select the item after step 5-④ (⇒ 56)

- ① Press [OPTION].
- ② Press [▲, ▼] to select the operation and press [OK].

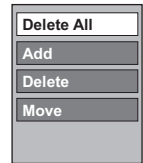

Delete All:

Delete all items registered on the copying list. Press [◀, ▶] to select "Yes" and press [OK].

Add:

Add new items to the copying list.

- 1 Press [▲, ▼] to select the title and press the "Red" button.
 A check mark is displayed. Repeat this step until you select all necessary items.
 • Press the "Red" button again to cancel.
- 2 Press [OK].

Delete:

Delete the selected items. Press [◀, ▶] to select "Yes" and press [OK].

Move:

Move selected items or change the order of items on the copying list. Press [▲, ▼] to select the destination and press [OK].

To cancel all registered copying setting and lists

After performing steps 1-2 (⇒ 56)

- 1 Press [▲, ▼] to select "Cancel All" and press [OK].
 - 2 Press [◀, ▶] to select "Yes" and press [OK].
- The settings and lists may be cancelled in the following situations.
 - When a title, still picture, etc. has been recorded or deleted at the copy source
 - When steps have been taken, for instance, to turn off the unit, open the tray, change the copy direction, etc.

Copying a finalised DVD-R, DVD-R DL, DVD-RW (DVD-Video format), +R and +R DL

DVD-V → HDD

You can copy the content of finalised DVD-R, DVD-R DL, DVD-RW (DVD-Video format), +R, and +R DL to the HDD and re-edit. While playing a disc, the content being played is copied to the HDD according to the set time.

- When “Rec for High Speed Copy” (⇒ 90) is set to “On” and you make a copy, the copy will be made using the picture size selected in “Aspect for Recording” (⇒ 90) of the Setup menu.

- Operations and on screen displays during copy are also recorded.
- Almost all DVD-Video on sale have been treated to prevent illegal copying, and cannot be copied.

Preparation

- Insert the finalised disc (⇒ 15).

After performing steps 1–4 (“Format” is automatically set to “DVD-Video”) (⇒ 56, Copying using the copying list—Copy)

1 Set “Copy Time”.

- If you are not going to change the setting (⇒ step 2).
- 1 Press [▲, ▼] to select “Copy Time” and press [▶].
 - 2 Press [▲, ▼] to select “Time Setting” and press [OK].
 - Setting the unit to copy all the content on the disc
 - 3 Press [▲, ▼] to select “Off” and press [OK].
 - 4 Press [◀] to confirm.
 - Copy will continue until there is not enough available recording space on the HDD.
 - Setting the copying time
 - 3 Press [▲, ▼] to select “On” and press [OK].
 - 4 Press [▲, ▼] to select “Copy Time” and press [OK].

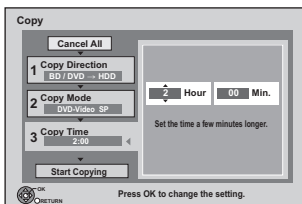

- 5 Press [◀, ▶] to select “Hour” and “Min.” and press [▲, ▼] to set the recording time.
- 6 Press [OK].
- 7 Press [◀] to confirm.
 - Copying to the HDD continues for the set time even after the content being played finishes.

- Set a few minutes longer than the source title, in order to include the operation time before play begins.

2 Press [▲, ▼] to select “Start Copying” and press [OK].

3 Press [◀, ▶] to select “Yes” and press [OK] to start copying.

The disc top menu is displayed.

- Disc play automatically begins from title 1 when “Title 1” is selected from the “Auto-Play Select” menu when finalising the disc (⇒ 86).

4 When the top menu is displayed Press [▲, ▼, ◀, ▶] to select the title you want to start copying, and press [OK].

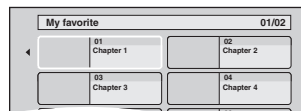

While playing in order, all the titles after the selected title are recorded until the set time. (After the last title on the disc has finished playing the top menu is recorded until the set time is reached.)

To return to the previous screen in steps 1 to 3

Press [RETURN ↵].

To stop copying after step 3

Press [■].

You can also press and hold [RETURN ↵] for 3 seconds to stop copying.

- If stopped partway, copying will be up to that point.

Note

- The screen on the right is recorded at the beginning.
- The content is recorded as 1 title from the start of copy to the end.
- If play does not begin automatically or if the top menu does not display automatically, press [▶] (PLAY) to start.
- Even if you copy a high quality video/audio DVD, the original picture and audio quality cannot be exactly replicated.
- If you want to copy a title from a DVD-RW (DVD Video Recording format), create a copy list and then copy (⇒ 56, Copying using the copying list—Copy).



Recording from Set Top Box

Recording disc: **HDD**

Recording mode: XP, SP, LP, EP

Preparation

- Connect a Set Top Box to this unit's input terminals (⇒ 101).
- When the output signal from the external equipment is NTSC, change the "TV System" to "NTSC" in the Setup menu (⇒ 93).
- Press [DRIVE SELECT] to select the HDD drive.

- 1 While stopped**
Press [INPUT SELECT] to select the input channel for the equipment you have connected.
- 2 Press [REC MODE] to select the recording mode.**
• DR, HG, HX, HE, HL and FR mode cannot be selected.
- 3 Select the channel on the other equipment.**
- 4 Press [● REC].**
Recording starts.

To skip unwanted parts

Press [II] to pause recording. (Press again to restart recording.)

To stop recording

Press [■].

Note

- It will be recorded in standard definition quality even if the programme is in high definition.
- When this unit is in EXT LINK standby ("EXT-L" is shown on the unit's display), this function does not work.

Linked timer recordings with external equipment (Set Top Box) — EXT LINK

Recording disc: **HDD**

Recording mode: XP, SP, LP, EP

To record programmes from Set Top Box using timer programming

Preparation

- Make sure you connect the AV2 input terminal of this unit to the Scart terminal of a Set Top Box with a 21-pin Scart cable (⇒ 101).
- Set "AV2 Input" to match the connected equipment in the Setup menu (⇒ 94).
- Set "Ext Link" to match the connected equipment in the Setup menu (⇒ 94).

- 1 Make timer programming on the external equipment.**
- 2 Press [EXT LINK].**
• "EXT-L" lights on the unit's display to indicate timer recording standby has been activated.
• The guidance information of EXT LINK appears.

To set external link standby using the FUNCTION MENU display

Perform step 1 (⇒ above)

- 1 Press [FUNCTION MENU].
- 2 Press [▲, ▼] to select "Others" and press [OK].
- 3 Press [▲, ▼] to select "Ext Link Standby" and press [OK].

To cancel the external control

- 1 Turn on this unit.
- 2 Press [EXT LINK] to stop recording or to cancel linked timer recording standby. ("EXT-L" disappears.)

Note

- It will be recorded in standard definition quality even if the programme is in high definition.
- During EXIT LINK standby mode or recording, you cannot press [INPUT SELECT] to select external input other than AV2.
- In order to prevent accidental operation, press [EXT LINK] to cancel the setting after recording is finished.
- This function does not work when "TV System" is set to "NTSC" in the Setup menu (⇒ 93).
- This function does not work when recording from an external input other than AV2.
- This function does not work while recording 2 programmes simultaneously with timer recording.
- This function does not work with some equipment. Refer to the equipment's operating instructions.
- The beginnings of recordings may not be recorded correctly in some cases.
- When "Ext Link" is set to "Ext Link 2", this function does not work if the input signal is NTSC system.
- Programmes are recorded as one title on this unit when the end time of the earlier timer recording and the start time of the later timer recording are close to each other.
To divide the titles, go to "Divide Title" (⇒ 49).
- While the unit is in EXT LINK standby mode or recording, AV1 output terminal outputs the signal which is input from the AV2 input terminal irrespective of "AV1 Output" setting (⇒ 94).
- During EXIT LINK standby mode or recording, playback is available on both HDD and BD drive. However, during EXIT LINK recording, BD-Video, still pictures or music cannot be played back.
- When "EXT-L" lights on the unit's display, Direct TV Recording is unavailable.

e.g., Connecting to the AV3 or DV input terminals on the front

- Turn off the unit and other video equipment before connecting.

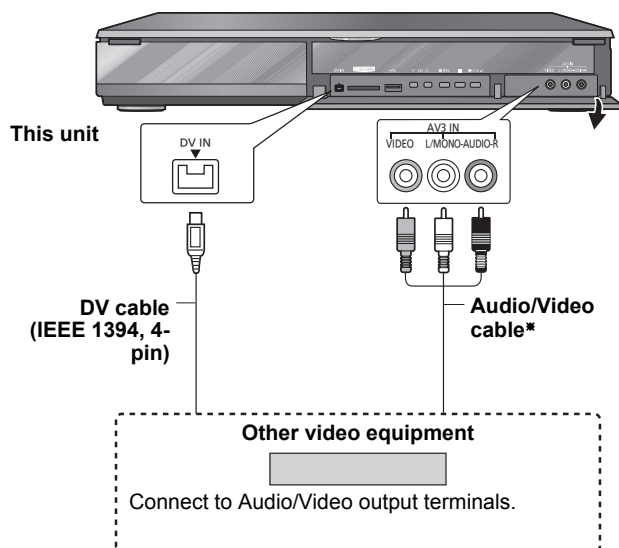

* Connect to terminals of the same colour.

If the audio output of the other equipment is monaural
Connect to L/MONO on the AV3 input terminals at the front.

When recording from the unit's DV terminal

- Select the type of audio recording from "Audio Mode for DV Input" in the Setup menu (⇒ 92).
- When recording from DV equipment (e.g., digital video camcorder), you can record audio/video recordings from DV tape only.
- When "Rec for High Speed Copy" (⇒ 90) is set to "On" and you make a copy, the copy will be made using the picture size selected in "Aspect for Recording" (⇒ 90) of the Setup menu.

16:9 image such as wide broadcasting (⇒ 32)

Note

- If video is copied from another piece of equipment to this unit, then the video quality will be degraded.
- While copying from DV input or executing the "Flexible Recording via AV input" (⇒ 61)
 - Copy will stop when timer recording starts.
 - Chasing playback, simultaneous rec and play, switching of the broadcast or input cannot be performed.

Manual recording

Recording disc: HDD

Recording mode: XP, SP, LP, EP

Preparation

- Press [DRIVE SELECT] to select the HDD drive.
- When recording bilingual programmes, select "M1" or "M2" on the external equipment.
- When the output signal from the external equipment is NTSC, change the "TV System" to "NTSC" in the Setup menu (⇒ 93).

1 While stopped
Press [INPUT SELECT] to select the input channel for the equipment you have connected.

e.g., If you have connected to AV3 input terminals, select "AV3".

2 Press [REC MODE] to select the recording mode.

- DR, HG, HX, HE, HL and FR mode cannot be selected.

3 Start play on the other equipment.

4 When you want to start recording

Press [● REC].

Recording starts.

To skip unwanted parts

Press [II] to pause recording. (Press again to restart recording.)

To stop recording

Press [■].

Almost all videos and BD-Video/DVD-Video on sale have been treated to prevent illegal copying. Any software (firmware) that has been so treated cannot be recorded using this unit.

Note

When this unit is in EXT LINK standby ("EXT-L" is shown on the unit's display), this function does not work.

DV Automatic Recording

Recording disc: **HDD** **BD-RE** **BD-R** **RAM** **-R** **-RW(V)** **+R** **+RW**
 Recording mode: **XP**, **SP**, **LP**, **EP**

Preparation

- 1 Turn off this unit and DV equipment, then connect the equipment with the unit's DV input terminal (⇒ 60).
- 2 Turn on this unit.
 - If you record to a disc, insert a disc (⇒ 15).
 - **BD-RE** **BD-R** **RAM** If the disc is protected, release protection (⇒ 84, Setting the protection).
 - When the output signal from the external equipment is NTSC, change the "TV System" to "NTSC" in the Setup menu (⇒ 93).

1 Turn on the DV equipment, and pause play at the point you want recording to start.

The following screen appears.

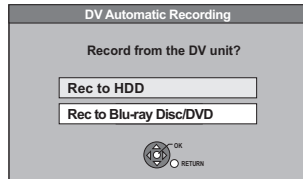

• When the screen is not displayed

- After performing step 1
- 1 Press [FUNCTION MENU].
 - 2 Press [▲, ▼] to select "Others" and press [OK].
 - 3 Press [▲, ▼] to select "DV Automatic Recording" and press [OK].
⇒ Go to step 2

2 Press [▲, ▼] to select "Rec to HDD" or "Rec to Blu-ray Disc / DVD" and press [OK].

- It may take a while for the next screen to display while preparing to record.

3 Press [REC MODE] to select the recording mode.

- DR, HG, HX, HE, HL and FR mode cannot be selected.

4 Press [◀, ▶] to select "Start" and press [OK].

Recording starts.

To stop recording

Press [■].

Note

- When this unit is in EXT LINK standby ("EXT-L" is shown on the unit's display), this function does not work.
- Only one piece of DV equipment (e.g., Panasonic's video camera, etc.) can be connected to the unit via the DV input terminal.
- It is not possible to operate the unit from the connected DV equipment.
- The DV input on this unit is for use with DV equipment only. (It cannot be connected to a computer, etc.)
- The DV equipment name may not be shown correctly.
- Depending on the DV equipment, the images or audio may not be input properly.
- The date and time information on the tape of the DV equipment will not be recorded.
- You cannot record and play simultaneously.
- **-R** **+R** It may not be able to record after repeating about 30 times of step 4 or recording or editing.
- **-R** **-RW(V)** After finalising, chapters for every 5 minutes will be created.
- **+R** After finalising, chapters for every 8 minutes will be created.
- **+RW** Regardless of creating top menu, chapters for every 8 minutes will be created.

If the DV automatic recording function does not work properly, check the connections and DV equipment settings, and turn the unit off and back on.

If that does not work, follow the instructions for manual recording (⇒ 60).

Flexible Recording via AV input

Recording disc: **HDD** **BD-RE** **BD-R** **RAM** **-R** **-RW(V)** **+R** **+RW**
 Recording mode: **FR**

It is possible to record from equipment connected to the AV input terminals.

Preparation

- **BD-RE** **BD-R** **RAM** If the disc is protected, release protection (⇒ 84, Setting the protection).
- When the output signal from the external equipment is NTSC, change the "TV System" to "NTSC" in the Setup menu (⇒ 93).

1 While stopped

Press [INPUT SELECT] to select the input channel for the equipment you have connected.

e.g., If you have connected to AV3 input terminals, select "AV3".

2 While stopped

Press [FUNCTION MENU].

3 Press [▲, ▼] to select "Others" and press [OK].

4 Press [▲, ▼] to select "Flexible Recording via AV input" and press [OK].

5 Press [▲, ▼] to select "Rec to HDD" or "Rec to Blu-ray Disc / DVD" and press [OK].

- It may take a while for the next screen to display while preparing to record.

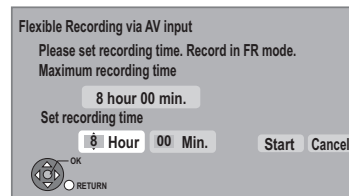

6 Press [◀, ▶] to select "Hour" and "Min." and press [▲, ▼] to set the recording time.

- You cannot record more than maximum recording time.

7 Start play on the other equipment.

8 When you want to start recording Press [◀, ▶] to select "Start" and press [OK].

To exit the screen without recording

Press [RETURN ⇨].

To stop recording partway

Press [■].

To show the remaining time

Press [STATUS ⓘ].

Note

- When this unit is in EXT LINK standby ("EXT-L" is shown on the unit's display), this function does not work.
- **-R** **+R** It may not be able to record after repeating about 30 times of step 8 or recording or editing.
- **-R** **-RW(V)** After finalising, chapters for every 5 minutes will be created.
- **+R** After finalising, chapters for every 8 minutes will be created.
- **+RW** Regardless of creating top menu, chapters for every 8 minutes will be created.

Copying HD Video (AVCHD format)

It is possible to copy the HD video (AVCHD format) recorded on the Panasonic's video camera, etc. to the HDD or disc.

From an SD card or Discs

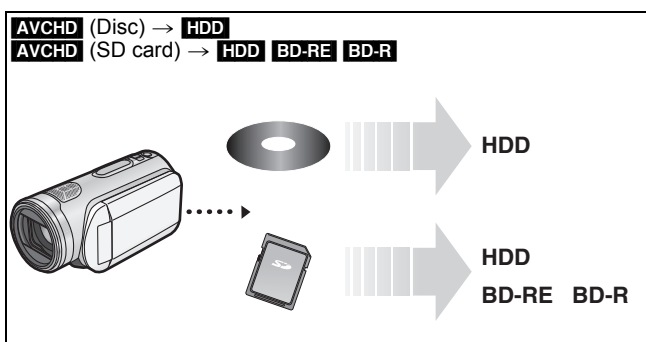

1 Insert a disc or card.

e.g., **SD**

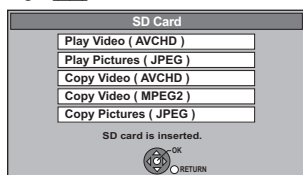

• Display items differ depending on what is recorded in each media.

2 Press [▲, ▼] to select “Copy Video (AVCHD)” and press [OK].

3 When copying from an SD card Press [▲, ▼] to select “Copy to HDD” or “Copy to Blu-ray Disc” and press [OK].

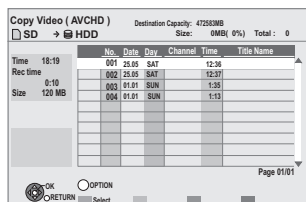

4 Press [▲, ▼] to select the title and press the “Red” button.

A check mark is displayed. Repeat this step until you select all necessary titles.

• Press the “Red” button again to cancel.
 (All the recordings on the same date become a title.)

5 Press [OK].

6 Press [◀, ▶] to select “Start” and press [OK].

It will automatically format the unformatted disc, such as new disc, when copying.

From a video equipment

HDD of Panasonic's video camera, etc. → **HDD BD-RE BD-R**
 • You cannot playback HD Video in the HDD of Panasonic's video camera, etc. with this unit.
 You must copy the files to the HDD or disc.

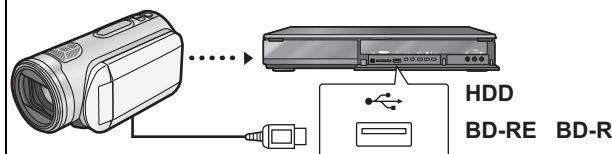

USB connection cable
 (specified cable such as accessory of the USB equipment)

Preparation

Turn on both this unit and the Panasonic's video camera, etc.

1 Connect the Panasonic's video camera, etc. to this unit.

2 Select the appropriate mode that makes the Panasonic's video camera ready for data transfer (such as “PC CONNECT”) on the Panasonic's video camera, etc.

• Refer to the camera's operating instructions for detail.

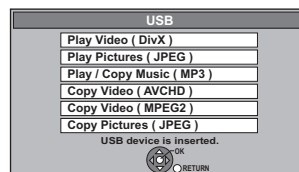

• Display items differ depending on what is recorded in the USB device.

3 Press [▲, ▼] to select “Copy Video (AVCHD)” and press [OK].

4 Press [▲, ▼] to select “Copy to HDD” or “Copy to Blu-ray Disc” and press [OK].

5 Press [▲, ▼] to select the title and press the “Red” button.

A check mark is displayed. Repeat this step until you select all necessary titles.

• Press the “Red” button again to cancel.
 (All the recordings on the same date become a title.)

6 Press [OK].

7 Press [◀, ▶] to select “Start” and press [OK].

It will automatically format the unformatted disc, such as new disc, when copying.

To stop copying

Press and hold [RETURN ⇨] for 3 seconds.

If the menu screen (⇨ above) is not displayed, display it by performing the following operation.

- Press [FUNCTION MENU].
- BD-RE RAM -R -R DL -RW(V) +R +R DL +RW**
 Press [▲, ▼] to select “Blu-ray Disc / DVD” and press [OK].
SD
 Press [▲, ▼] to select “SD Card” and press [OK].
USB
 Press [▲, ▼] to select “USB” and press [OK].

Note

- Record, playback, or timer recording cannot be executed while copying.
- Copy cannot be executed while recording or playback.
- An AVCHD title with more than 100 scenes will be divided into titles every 99th scene and copied.
- Copied video will be displayed as “AVCHD” in the “Channel” column of the DIRECT NAVIGATOR screen.
- Depending on the recording condition with the high definition camera, scenes recorded on same day might have different titles (“-1”, “-2” appended to date).
- See the instructions of the equipment used to record.
- After copying AVCHD to HDD, it can be copied to DVDs with standard definition quality. It is not recommended to delete original AVCHD.

Copying SD Video (MPEG2 format)

It is possible to copy the SD video (MPEG2 format) recorded on the Panasonic video camera, etc. to the HDD or disc.

■ From an SD card

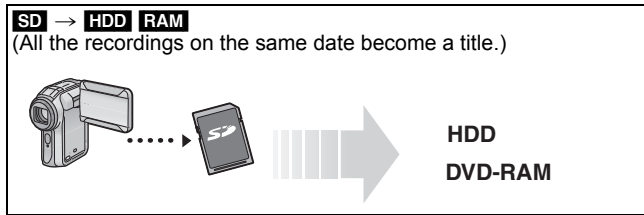

1 Insert a card.

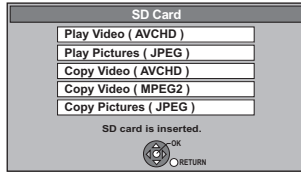

- Display items differ depending on what is recorded in the card.

2 Press [▲, ▼] to select “Copy Video (MPEG2)” and press [OK].

3 Press [▲, ▼] to select “Start Copying” and press [OK].

How to copy

Refer to “Copying using the copying list—Copy” (⇒ 56)
Please set the items in step 3 and 4 as shown below.

Copy Direction:

Source : SD CARD

Copy Mode:

Format : VIDEO

- SD Video on an SD card are automatically registered on the copy list.

4 Press [◀, ▶] to select “Yes” and press [OK] to start copying.

■ From a video equipment

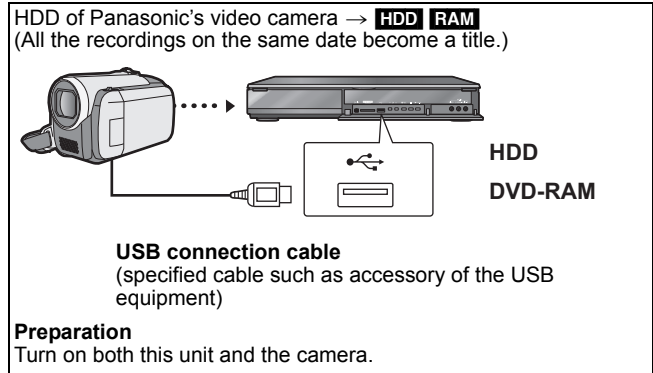

USB connection cable

(specified cable such as accessory of the USB equipment)

Preparation

Turn on both this unit and the camera.

- 1 Connect the Panasonic's video camera, etc. to this unit.
- 2 Select the appropriate mode that makes the Panasonic's video camera, etc. ready for data transfer (such as “PC CONNECT”) on the Panasonic's video camera, etc.

- Refer to the camera's operating instructions for detail.

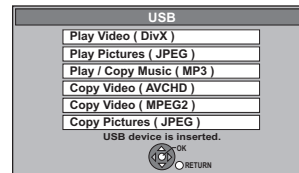

- Display items differ depending on what is recorded in the USB device.

3 Press [▲, ▼] to select “Copy Video (MPEG2)” and press [OK].

4 Press [▲, ▼] to select “Start Copying” and press [OK].

How to copy

Refer to “Copying using the copying list—Copy” (⇒ 56)
Please set the items in step 3 and 4 as shown below.

Copy Direction:

Source : USB

Copy Mode:

Format : VIDEO

- SD Video on the Panasonic's video camera, etc. are automatically registered on the copy list.

5 Press [◀, ▶] to select “Yes” and press [OK] to start copying.

To stop copying

Press and hold [RETURN ↵] for 3 seconds.

If the menu screen (⇒ above) is not displayed, display it by performing the following operation.

- 1 Press [FUNCTION MENU].
- 2 **SD**
Press [▲, ▼] to select “SD Card” and press [OK].
USB
Press [▲, ▼] to select “USB” and press [OK].

Note

- You cannot playback SD Video on an SD card or in the HDD of the Panasonic's video camera, etc. with this unit. You must copy the files to the HDD or a DVD-RAM.
- You cannot playback or record while copying SD Video.

Playing still pictures

HDD BD-RE RAM -R -R DL CD USB SD

- You can play still pictures recorded with a computer onto a BD-RE, DVD-R, DVD-R DL, CD-R/CD-RW, USB memory and SD card.
- You cannot play still pictures while recording or copying.

1

HDD

Press [FUNCTION MENU].

BD-RE RAM -R -R DL CD USB SD

Insert the disc, the SD card or USB memory.

The display below automatically appears.

Disc

e.g., **CD**

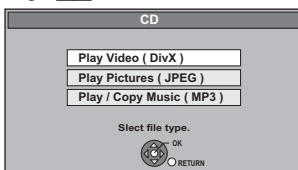

SD

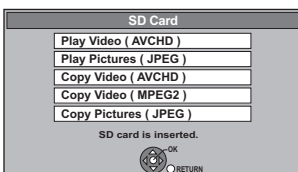

USB

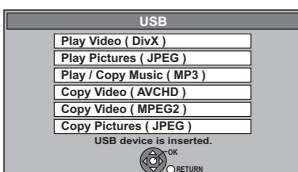

- Display items differ depending on what is recorded in each media.

2

Press [▲, ▼] to select “Play Pictures (JPEG)” and press [OK].

■ Switching the Picture View appearance

HDD BD-RE RAM

Still pictures copied from SD cards and USB memories are grouped by the shooting date on Pictures by Date screen.

- 1 Press [OPTION].
- 2 Press [▲, ▼] to select “View Album” or “Pictures by Date” and press [OK].

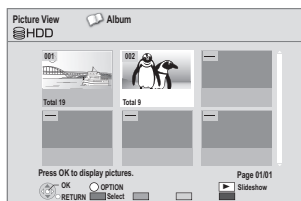

Album screen

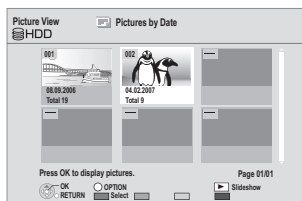

Pictures by Date screen

3

Press [▲, ▼, ◀, ▶] to select the album of “Album” or date of “Pictures by Date” and press [OK].

- Picture list screen is displayed.

e.g., **HDD**

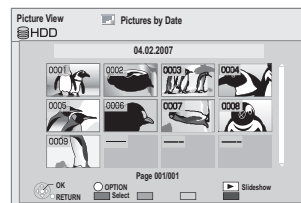

Picture list screen

Picture View screen icons

- Picture and Album protected.

HDD

- Date that has not yet been viewed (Only still pictures copied with “Copy All Pictures (JPEG)” or “Copy New Pictures (JPEG)”)

To show other pages

Press [◀, ▶].

4

Press [▲, ▼, ◀, ▶] to select the still picture and press [OK].

- Press [◀, ▶] to display the previous or next still picture.
- Useful functions during still picture play (⇒ 65)

To return to previous screen

Press [RETURN ↵].

To exit the screen

Press [EXIT].

If the menu screen (⇒ left) is not displayed, display it by performing the following operation.

- 1 Press [FUNCTION MENU].
- 2 **BD-RE RAM -R -R DL CD**
Press [▲, ▼] to select “Blu-ray Disc / DVD” and press [OK].
SD
Press [▲, ▼] to select “SD Card” and press [OK].
USB
Press [▲, ▼] to select “USB” and press [OK].

Useful functions during still picture play

Start Slideshow

You can display still pictures one by one at a constant interval.
1 Press [▲, ▼, ◀, ▶] to select the album or date.*
2 Press [▶] (PLAY).

You can also start Slideshow with following steps.

After performing step 1 (⇒ above)

- 1 Press [OPTION].
- 2 Press [▲, ▼] to select "Start Slideshow" and press [OK].

To end the slide show

Press [RETURN ↵].

Slideshow Settings

1 Press [▲, ▼, ◀, ▶] to select the album or date.*
2 Press [OPTION].
3 Press [▲, ▼] to select "Slideshow Settings" and press [OK].
4 After completing the following settings, press [▲, ▼, ◀, ▶] to select "Set" and press [OK].

e.g.,



● **To change the display interval**

After performing steps 1–3

- 1 Press [▲, ▼] to select "Display Interval".
- 2 Press [◀, ▶] to select the desired interval.

● **To change the transition effect**

After performing steps 1–3

- 1 Press [▲, ▼] to select "Transition Effect".
- 2 Press [◀, ▶] to select the transition effect.

"Fade": Pictures are changed by fading out and fading in.

"Motion": Pictures are changed by fading out and fading in, while it is enlarged, reduced, or moved up or down.

"Random": In addition to the "Motion", pictures are changed by various methods.

● **To set repeat play**

After performing steps 1–3

- 1 Press [▲, ▼] to select "Repeat Play".
- 2 Press [◀, ▶] to select "On" or "Off".

● **To playback the music**

Sample music in this unit or music stored on the HDD (My Favourites or Playlists) (⇒ 71) or the USB can be played during the playback of the slideshow.

After performing steps 1–3

- 1 Press [▲, ▼] to select "Soundtrack".
- 2 Press [◀, ▶] to select "On".

e.g., **HDD**

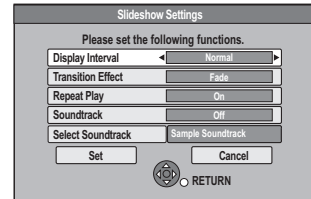

● **To change the music to playback**

- 1 Press [▲, ▼] to select "Select Soundtrack" and press [OK].
- 2 Press [▲, ▼] to select the storage location and press [OK].
- 3 Press [▲, ▼] to select the music playlist and press [OK].



Rotate RIGHT Rotate LEFT

While playing

1 Press [OPTION].
2 Press [▲, ▼] to select "Rotate RIGHT" or "Rotate LEFT" and press [OK].

● Rotation information will not be stored in the following cases.

- [R] [R DL] [CD] [USB] Still pictures
- When disc or card is protected
- When played on other equipment
- When copying pictures
- When changing date

● If you remove the SD card while the Picture View screen is displayed, picture rotation information may not be properly stored. Remove the SD card after you exit the Picture View screen.

e.g.,

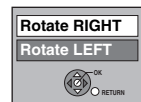

Zoom in Zoom out

While playing

1 Press [OPTION].
2 Press [▲, ▼] to select "Zoom in" and press [OK].

● Press [▲, ▼] to select "Zoom out" in step 2 and press [OK] to resume the display size of the still picture.

- When zooming in, the picture may be cut off.
- The Zoom in information will not be stored.
- This function is only available for small-sized still pictures.

e.g.,

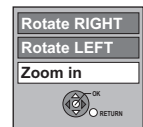

Properties

Information (e.g., time and date) is shown.

1 Press [▲, ▼, ◀, ▶] to select the album or date and press [OK].*
2 Press [▲, ▼, ◀, ▶] to select the still picture.
3 Press [OPTION].
4 Press [▲, ▼] to select "Properties" and press [OK].

While playing

Press [STATUS ⓘ] twice.

To exit the picture properties screen

Press [STATUS ⓘ].

e.g., **HDD**

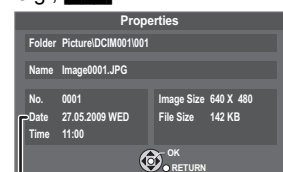

Shooting date

* To switch the "Album" or "Pictures by Date" (⇒ 64, step 2)

Editing still pictures (JPEG)

HDD **BD-RE** **RAM** **SD**

- Editing can be done in units of pictures, albums, or dates.
- You cannot edit still pictures recorded on DVD-R, DVD-R DL, CD-R/CD-RW and USB memory.

Preparation

- Press [DRIVE SELECT] to select the drive. Select "BD" for any discs.
- **BD-RE** **RAM** **SD** Release protection (⇒ 11, 84, Setting the protection).

1

HDD

Press [FUNCTION MENU].

BD-RE **RAM** **SD**

Insert the disc or the SD card.

The menu is automatically displayed.

Disc

e.g., **RAM**

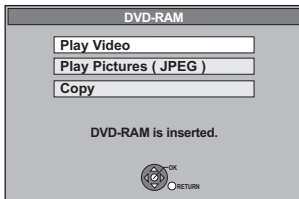

SD

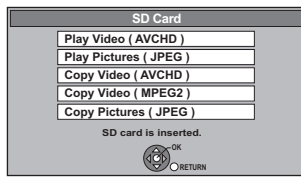

- Display items differ depending on what is recorded in each media.

2

Press [▲, ▼] to select "Play Pictures (JPEG)" and press [OK].

■ Switching the Picture View appearance

HDD **BD-RE** **RAM**

① Press [OPTION].

② Press [▲, ▼] to select "View Album" or "Pictures by Date" and press [OK].

e.g., **HDD**

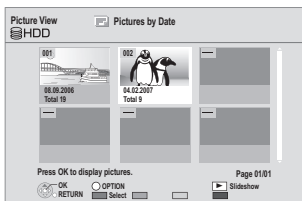

Pictures by Date screen

3

Editing an album or date:

Select the album or date to be edited and press [OPTION].

Editing a still picture:

① Select the album or date which contains the still picture to edit and press [OK].

e.g., **HDD**

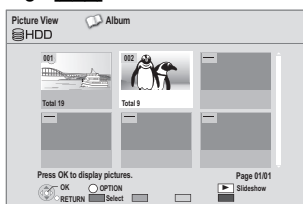

② Select the still pictures to edit and press [OPTION].

To show other pages

Press [◀, ▶].

Multiple editing

Select with [▲, ▼, ◀, ▶] and press the "Red" button. (Repeat.)

A check mark appears. Press the "Red" button again to cancel.

4 Press [▲, ▼] to select the operation and press [OK].

(e.g., **HDD** Pictures by Date)

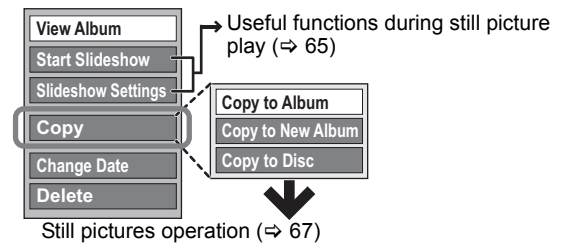

(e.g., **HDD** Album)

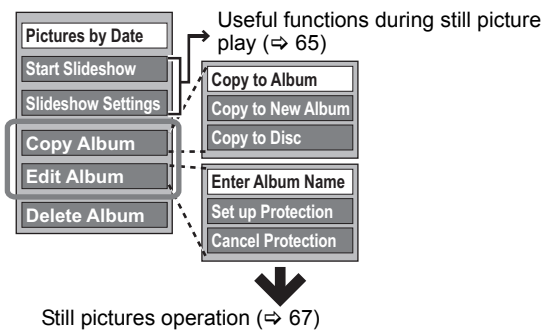

(e.g., **HDD** Picture list in the Pictures by Date View)

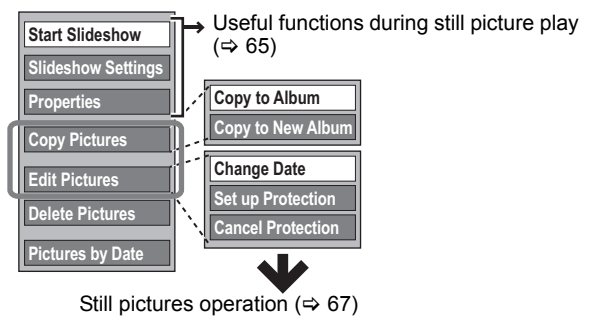

(e.g., **SD** Album)

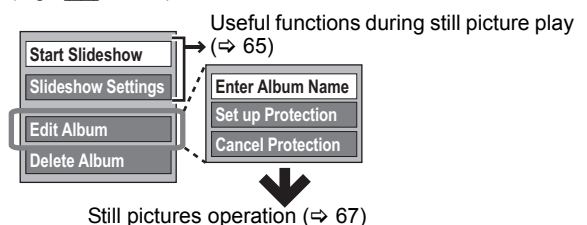

(e.g., **SD** Picture list)

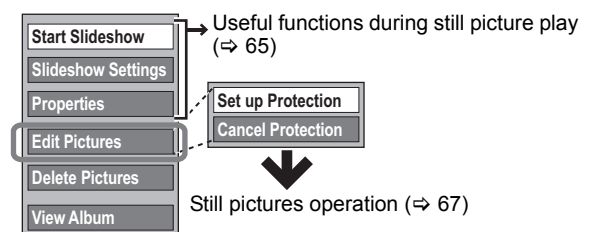

To return to the previous screen

Press [RETURN ↵].

To exit the screen

Press [EXIT].

If the menu screen (⇒ step 1) is not displayed, display it by performing the following operation.

1 Press [FUNCTION MENU].

2 **BD-RE** **RAM**

Press [▲, ▼] to select "Blu-ray Disc / DVD" and press [OK].

SD

Press [▲, ▼] to select "SD Card" and press [OK].

Still pictures operation

After performing steps 1–3 (⇒ 66)

Copy to Album* HDD BD-RE RAM	Copy the selected album, date, or pictures to an existing album. ① Press [◀, ▶] to select “Start” and press [OK]. ② Press [▲, ▼, ◀, ▶] to select the destination album and press [OK]. ● The destination album with protect setting cannot be copied to. ● After copying, the screen shows the Album screen automatically.
Copy to New Album* HDD BD-RE RAM	Copy the selected album, date, or pictures to new album. ① Press [◀, ▶] to select “Start” and press [OK]. ② Press [OK]. ③ Press [◀, ▶] to select “Yes” or “No” and press [OK]. ● If “Yes” is selected: You can give names to albums. (⇒ 80, Entering text) ● If “No” is selected: Date of the first recorded picture in the album becomes the album name automatically. (If there is no information about the recording date, it will become “--.--”.) ● After copying, the screen shows the Album screen automatically.
Copy to Disc HDD Copy to HDD BD-RE RAM	Press [◀, ▶] to select “Start” and press [OK].
Change Date* HDD BD-RE RAM (Pictures by Date only)	Change the date of a folder and move the picture in it into the folder of the changed date. ① Press [◀, ▶] to select the item and press [▲, ▼] to change. ② Press [OK]. ● You can also change the date of a picture. ● Date folder of the original is maintained even if all original pictures were deleted after changing the date of folder. Delete it if unrequired. ● If there is no folder with the changed date, a new folder will be created.
Enter Album Name HDD BD-RE RAM SD (Album only)	You can give names to albums. (⇒ 80, Entering text) ● Album names input using this unit may not be displayed on other equipment.
Set up Protection* Cancel Protection* HDD BD-RE RAM SD (Album and picture list only)	If set, this will protect the still picture or album from accidental deletion. Press [◀, ▶] to select “Yes” and press [OK]. The lock symbol appears when the still picture or album is protected. ● Even if the protection setting is used by this unit to protect an album, the album may be deleted by another unit.
Delete* Delete Album* Delete Pictures* HDD BD-RE RAM SD	Press [◀, ▶] to select “Delete” and press [OK]. ● Once deleted, the recorded contents are lost and cannot be restored. Make certain before proceeding. ● BD-RE RAM SD If there is a file other than DCF format or other folder exists in the date or album, only the pictures will be deleted, and the date or the album itself will not be deleted.

* Multiple editing is possible.

[Copy to Album, Copy to New Album, Change Date : Only when the picture list is displayed]

Note

● Timer recordings do not start when performing “Copy to Album”, “Copy to New Album”, “Change Date”, “Copy to Disc” or “Copy to HDD”.

Copying still pictures

HDD **BD-RE** **RAM** **USB** **SD**

- Pictures copied from SD card and USB memory will be categorised according to the shooting date. Pictures without shooting date will be categorised using the creation date.
- The pictures recorded on DVD-R, DVD-R DL, CD-R/CD-RW cannot be copied.
- If the space on the destination drive runs out or the number of files/folders to be copied exceeds the maximum (⇒ 116), copying will stop partway through.
- You cannot copy the information about the picture rotation.
- Timer recording will not start while copying still pictures.

Copying new still pictures on the SD card—Copy New Pictures (JPEG)

SD → **HDD**

This unit saves information about imported still pictures. Therefore, if still pictures are imported from the same SD card, then only new still pictures will be imported.

1 While stopped

Insert the SD card.

The menu is automatically displayed.

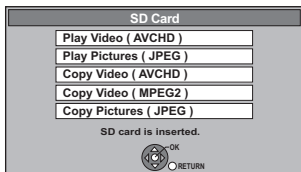

- Display items differ depending on what is recorded in the card.

2 Press [▲, ▼] to select “Copy Pictures (JPEG)” and press [OK].

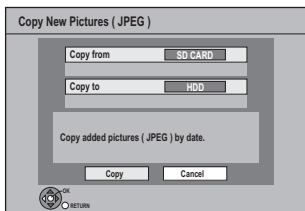

3 Press [◀, ▶] to select “Copy” and press [OK].

- Protection of the card is
 - Set: Copy will start
 - Not set: Go to step 4

4 Press [◀, ▶] to select “Copy & Delete” or “Copy Only” and press [OK].

If “Copy & Delete” is selected
Copied pictures in the SD card will be deleted after copying.

If “Copy Only” is selected
Pictures will not be deleted.

- will be displayed on the Pictures by Date screen of the Picture View for the added pictures.

To stop copying

Press and hold [RETURN ↵] for 3 seconds.

If the menu screen (⇒ above) is not displayed, display it by performing the following operation.

- 1 Press [FUNCTION MENU].
- 2 Press [▲, ▼] to select “SD Card” and press [OK].

Note

- This unit saves the information on up to 12,000 still pictures and 30 SD cards. If additional still pictures are imported, then the older information will be deleted.

Copying all the still pictures on the USB memory—Copy All Pictures (JPEG)

USB → **HDD**

1 While stopped

Insert the USB memory.

The menu is automatically displayed.

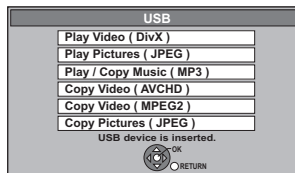

- Display items differ depending on what is recorded in the USB memory.

2 Press [▲, ▼] to select “Copy Pictures (JPEG)” and press [OK].

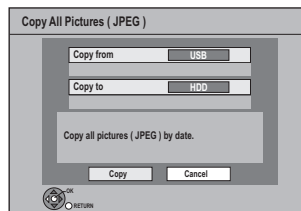

3 Press [◀, ▶] to select “Copy” and press [OK].

- will be displayed on the Pictures by Date screen of the Picture View for the added pictures.

To stop copying

Press and hold [RETURN ↵] for 3 seconds.

If the menu screen (⇒ above) is not displayed, display it by performing the following operation.

- 1 Press [FUNCTION MENU].
- 2 Press [▲, ▼] to select “USB” and press [OK].

Note

- The structure of folders on the USB memory may not be the same at the copy destination.

Copying using the copying list

HDD ↔ **BD-RE** **RAM** **SD**

SD ↔ **BD-RE** **RAM**

USB → **HDD** **BD-RE** **RAM**

1 While stopped

Press [FUNCTION MENU].

2 Press [▲, ▼] to select “Copy” and press [OK].

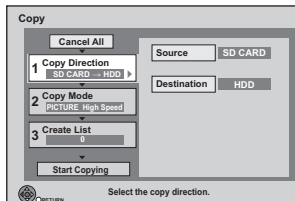

- If you are not going to change each setting (⇒ step 6).

3 Set the copy direction.

- If you are not going to change the copying direction (⇒ step 4).
- ① Press [▲, ▼] to select “Copy Direction” and press [▶].
- ② Press [▲, ▼] to select “Source” and press [OK].
- ③ Press [▲, ▼] to select the drive and press [OK].
- ④ Press [▲, ▼] to select “Destination” and press [OK].
- ⑤ Press [▲, ▼] to select the drive and press [OK].
The same drive as the copy source cannot be selected.
- ⑥ Press [◀] to confirm.

4 Set the copy mode.

- If you are not going to change the recording mode (⇒ step 5).
- ① Press [▲, ▼] to select “Copy Mode” and press [▶].
- ② Press [▲, ▼] to select “Format” and press [OK].
- ③ Press [▲, ▼] to select “PICTURE” and press [OK].
“Recording Mode” is automatically set to “High Speed”.
- ④ Press [◀] to confirm.

5 Register still pictures for copy.

- If you are going to copy a registered list without making any changes to it (⇒ step 6).
- Pictures from different dates or albums will not be registered to same list.

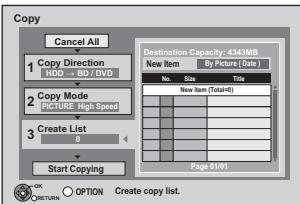

- ① Press [▲, ▼] to select “Create List” and press [▶].



- ② Press [▲, ▼] to select “New Item” and press [OK].

e.g., **HDD**

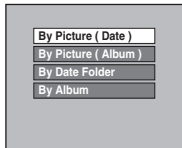

e.g., **SD**

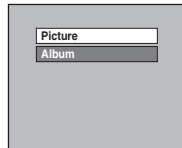

- ③ Press [▲, ▼] to select the item and press [OK].

Register with “By Picture (Date)”/“By Picture (Album)”/“Picture”

- Press [▲, ▼] to select “New item” and press [OK].
- Press [▲, ▼, ◀, ▶] to select the still picture and press the “Red” button.
A check mark is displayed. Repeat this step until you select all necessary items.
 - Press the “Red” button again to cancel.
 - Press [◀◀, ▶▶] to show other pages.
 - The items will be copied in the order of the copying list. If you want to specify the order, repeat selecting one item at a time.
 - To select another “Album” or “Date” (⇒ right)
- Press [OK].
 - To edit the copying list (⇒ right)
- Press [◀] to confirm.

Register with “By Date Folder”/“By Album”/“Album”

- Press [▲, ▼] to select “New item” and press [OK].
- Press [▲, ▼, ◀, ▶] to select the folder and press the “Red” button.
A check mark is displayed. Repeat this step until you select all necessary items.
 - Press the “Red” button again to cancel.
 - Press [◀◀, ▶▶] to show other pages.
 - The items will be copied in the order of the copying list. If you want to specify the order, repeat selecting one item at a time.
- Press [OK].
 - To edit the copying list (⇒ right)
- Press [◀] to confirm.

6 Press [▲, ▼] to select “Start Copying” and press [OK].

- [Only when copied with “By Picture (Album)” from **HDD** to **BD-RE RAM SD** or from **BD-RE RAM** to **HDD SD**] When specifying another album as the copying destination, select “Album”.

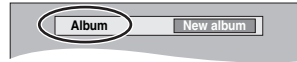

7 Press [◀, ▶] to select “Yes” and press [OK] to start copying.

To return to the previous screen in steps 1 to 7
Press [RETURN ↵].

To stop copying after step 7
Press and hold [RETURN ↵] for 3 seconds.

Note

- The sequence in which the still pictures are registered on the copy list may not be the same at the copy destination.
- If still pictures are already contained inside the copy destination folder, the new still pictures are recorded following the existing still pictures.

To edit the copying list

- Select the item after step 5–3 (⇒ left)
- Press [OPTION].
 - Press [▲, ▼] to select the operation and press [OK].

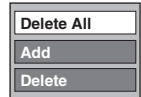

Delete All:

Delete all items registered on the copying list.
Press [◀, ▶] to select “Yes” and press [OK].

Add:

Add new items to the copying list.

- Press [▲, ▼, ◀, ▶] to select the item and press the “Red” button.
A check mark is displayed. Repeat this step until you select all necessary items.
 - Press the “Red” button again to cancel.
- Press [OK].

Delete:

Delete the selected items.
Press [◀, ▶] to select “Yes” and press [OK].

To cancel all registered copying settings and lists

- After performing steps 1–2 (⇒ 68, Copying using the copying list)
- Press [▲, ▼] to select “Cancel All” and press [OK].
 - Press [◀, ▶] to select “Yes” and press [OK].
- The settings and lists may be cancelled in the following situations.
 - When a title or still picture has been recorded or deleted at the copy source
 - When steps have been taken, for instance, to turn off the unit, remove the card, open the tray, change the copy direction, etc.

To select another “Album” or “Date”

After performing step 5–2 (⇒ left, Register with “By Picture (Date)”/“By Picture (Album)”/“Picture”)

- Press [OPTION].
 - Press [▲, ▼] to select “Select Album” or “Select Date” and press [OK].
 - Press [▲, ▼, ◀, ▶] to select “Album” or “Date” and press [OK].
- The still pictures of different folders cannot be registered on the same list.

Playing MP3 files

-R -R DL CD USB

You can play MP3 files recorded with a computer onto a DVD-R, DVD-R DL, CD-R/CD-RW and USB memory.

- You cannot play MP3 files on the USB memory while recording.

1 While stopped

Insert a disc or USB memory.

e.g., **CD**

USB

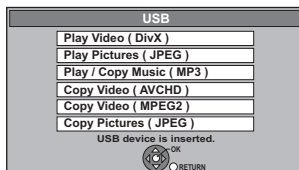
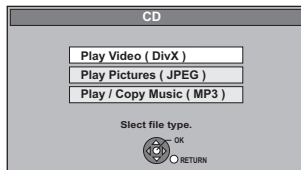

- Display items differ depending on what is recorded in each media.
- **-R -R DL CD** Playback will automatically start if only MP3 is recorded.

2 Press [▲, ▼] to select “Play / Copy Music (MP3)” and press [OK].

- Playback will automatically start.

e.g., **CD**

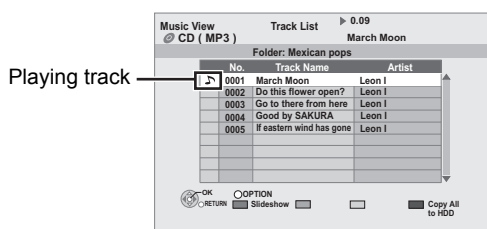

Playing different track

Press [▲, ▼] to select the track and press [OK].

To exit the screen

Press [EXIT].

Playback of track will stop.

If the menu screen (⇒ above) is not displayed, display it by performing the following operation.

- 1 Press [FUNCTION MENU].
- 2 **-R -R DL CD**
Press [▲, ▼] to select “Blu-ray Disc / DVD” and press [OK].
USB
Press [▲, ▼] to select “USB” and press [OK].

Using the tree screen to find a folder

- 1 While the Track List is displayed
Press [OPTION].
- 2 Press [▲, ▼] to select “Select Folder” and press [OK].

Selected folder No. /Total folder

If the folder has no track, “- -” is displayed as folder number.

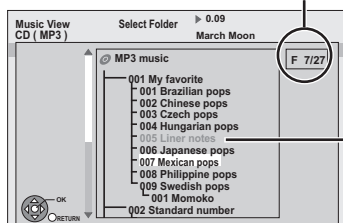

You cannot select folders that contain no compatible files.

- 3 Press [▲, ▼, ◀, ▶] to select a folder and press [OK].

The Track List for the folder appears.

To return to the previous screen

Press [RETURN ↵].

Note

When this unit is not operated for approximately 5 minutes during music playback, the screen saver is displayed [only when the “Screen Saver” in the Setup menu is set to “On” (⇒ 92)]. To return to the previous screen, press [RETURN ↵].

Playing music CD

While stopped

Insert a music CD.

The unit starts accessing the Gracenote® Database (⇒ 75) and searches for the title information.



If search results indicate that multiple titles were found Press [▲, ▼] to select the appropriate title and press [OK].

- Playback will automatically start.

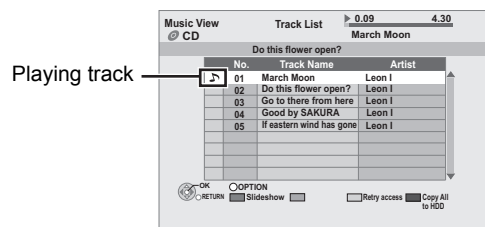

Playing different track

Press [▲, ▼] to select the track and press [OK].

Reacquire the CD title

Press the “Yellow” button.

To exit the screen

Press [EXIT].

Playback of track will stop.

Note

When this unit is not operated for approximately 5 minutes during music playback, the screen saver is displayed [only when the “Screen Saver” in the Setup menu is set to “On” (⇒ 92)]. To return to the previous screen, press [RETURN ↵].

Playing music recorded on HDD

Copying music to HDD (⇒ 75)

- 1 Press [FUNCTION MENU].
- 2 Press [▲, ▼] to select “Play Music” and press [OK].



- 3 Press [▲, ▼] to select the item and press [OK].

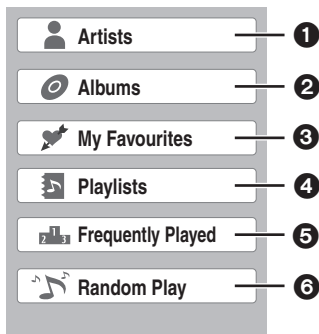

- 1 Categorise by artist
- 2 Categorise by album
- 3 Tracks registered in “My Favourites”
- 4 Tracks registered in “Playlists”
- 5 Tracks played most within 200 tracks played recently (up to 30 Tracks)
- 6 Random playback of all tracks

■ When “Artists” is selected

- 1 Press [◀, ▶] to select the initial of the artist.
- 2 Press [▲, ▼] to select the name of the artist and press [OK].
- 3 Press [▲, ▼] to select the album and press [OK].

■ When “Albums” is selected

- 1 Press [◀, ▶] to select the initial of the album.
- 2 Press [▲, ▼] to select the album and press [OK].

- 4 Press [▲, ▼] to select the track and press [OK].

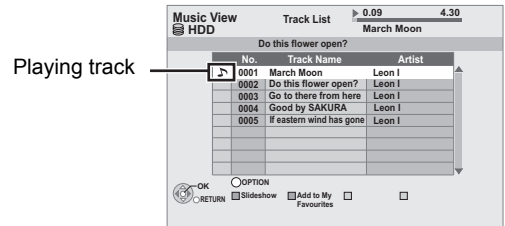

Playing different track

Press [▲, ▼] to select the track and press [OK].

To return to the previous screen

Press [RETURN ↵].

To exit the screen

Press [EXIT].

Playback of track will stop.

Note

- You cannot play music tracks on HDD while copying.
- When this unit is not operated for approximately 5 minutes during music playback, the screen saver is displayed [only when the “Screen Saver” in the Setup menu is set to “On” (⇒ 92)]. To return to the previous screen, press [RETURN ↵].

Useful functions during music play

HDD R R-DL CD USB

Operations during play

Stop	Press [■].
Pause	Press [⏸]. Press [⏸] again or [▶] (PLAY) to restart play.
Search	Press [◀◀] or [▶▶]. Press [▶] (PLAY) to restart play.
Skip	During play or while paused, press [◀◀] or [▶▶]. Skip to the track you want to play. • Each press increases the number of skips.
Register a track to the "My Favourites"	While Track List screen is displayed Press [▲, ▼] to select the track and press the "Green" button. • Up to 99 tracks can be registered.
Properties	While Track List screen is displayed 1 Press [▲, ▼] to select the track. 2 Press [OPTION]. 3 Press [▲, ▼] to select "Properties" and press [OK]. • To exit the Properties screen, press [OK].
Repeat Play Random	1 Press [DISPLAY]. 2 Press [▲, ▼] to select "Play" and press [▶]. 3 Press [▲, ▼] to select "Repeat Play" or "Random" and press [▶]. 4 Press [▲, ▼] to select the item. • Repeat Play "All": Repeatedly playback the selected album, etc. "Track": Repeatedly playback the selected track "Off" • Random "On": Randomly playback the selected album, etc. "Off"
Re-master 1 Re-master 2	This feature gives you a more natural sound by adding higher frequency signals not recorded on the track. 1 Press [DISPLAY]. 2 Press [▲, ▼] to select "Sound" and press [▶]. 3 Press [▲, ▼] to select "Sound Effects" and press [▶]. 4 Press [▲, ▼] to select "Re-master 1" or "Re-master 2". • This function is effective for audio from the HDMI terminal or the DIGITAL AUDIO OUT terminal only when "Dolby D/Dolby D +/Dolby TrueHD", "DTS/DTS-HD" or "MPEG" is set to "PCM" (⇒ 91). (However, in this case, audio is output as 2ch from the DIGITAL AUDIO OUT terminal.)
Display Still Pictures (Slideshow)	Sample pictures in this unit or pictures stored on the "Album" of the HDD can be played back as slideshow during playback of the music. While playing the music Press the "Red" button. Change the pictures to display 1 Press [OPTION]. 2 Press [▲, ▼] to select "Select Picture Album" and press [OK]. 3 Press [▲, ▼] to select the album and press [OK].  To end the slide show Press [RETURN ↵]. • It will also end when the music is stopped.
Playing music continuously even after turning off power to the television	When the unit is connected to a Panasonic TV (VIERA) that supports HDAVI Control 2 or later, the unit is turned off if the power to the television is turned off, since "Power off link" (⇒ 76) operates. The following operations make it possible to keep the power of the unit ON and to play music continuously. ① While playing music Press [OPTION]. ② Press [▲, ▼] to select "TV Power Off" and press [OK]. • Sound may be discontinued for several seconds when the power to the television is turned off. • If the operation mentioned above is executed while audio is output from the television, the sound may not be output from the amplifier/receiver. It is recommended to set the amplifier/receiver beforehand so that audio will be output from the amplifier/receiver.

Editing music

HDD

- 1 Press [FUNCTION MENU].
- 2 Press [▲, ▼] to select “Play Music” and press [OK].

• When doing “Delete All Tracks”, “Clear My Favourites” or “Clear Frequently Played” (⇒ go to step 4)

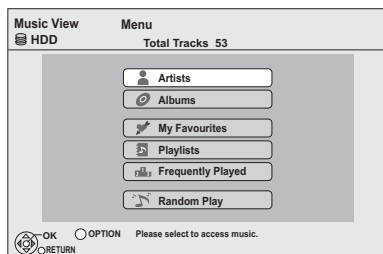

- 3 Press [▲, ▼] to select item and press [OK].

■ When “Artists” is selected

- ① Press [◀, ▶] to select the initial of the artist.
- ② Press [▲, ▼] to select the name of the artist, and press [OK].
- ③ Press [▲, ▼] to select the album.
 - To edit the track, press [OK], and select the track with [▲, ▼].

■ When “Albums” is selected

- ① Press [◀, ▶] to select the initial of the album.
- ② Press [▲, ▼] to select the album.
 - To edit the track, press [OK], and select the track with [▲, ▼].

- 4 Press [OPTION].

- 5 Press [▲, ▼] to select item and press [OK].

e.g., while selecting album

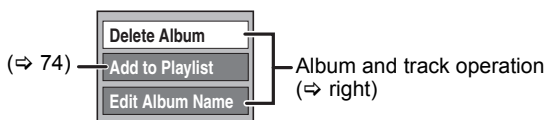

e.g., while selecting artist

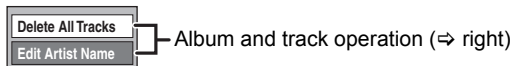

e.g., while selecting track

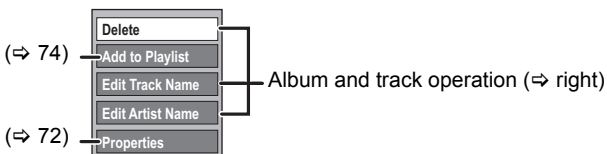

To return to the previous screen

Press [RETURN ↵].

To exit the screen

Press [EXIT].

Album and track operation

After performing steps 1–5 (⇒ left)

Delete All Tracks • While displaying “Menu” screen	Delete all tracks in the HDD. ① Press [◀, ▶] to select “Yes” and press [OK]. ② Press [◀, ▶] to select “Delete” and press [OK]. • Once deleted, the recorded contents are lost and cannot be restored. Make certain before proceeding.
Delete All Tracks • While displaying “Artists” screen Delete Album • While displaying “Albums” screen Delete	All tracks in the selected Artist or Album are deleted in case of “Delete All Tracks” or “Delete Album”. Press [◀, ▶] to select “Delete” and press [OK]. • Once deleted, the recorded contents are lost and cannot be restored. Make certain before proceeding.
Edit Album Name Edit Track Name Edit Artist Name	(⇒ 80, Entering text)
Clear My Favourites • While displaying “Menu” screen	Remove all tracks in “My Favourites”. Tracks themselves are not deleted from the HDD. Press [◀, ▶] to select “Clear” and press [OK].
Clear Frequently Played • While displaying “Menu” screen	Remove all tracks in “Frequently Played”. Tracks themselves are not deleted from the HDD. Press [◀, ▶] to select “Clear” and press [OK].
Remove • While displaying “My Favourites” or “Frequently Played” screen	Selected track is removed. Track itself is not deleted from the HDD. Press [◀, ▶] to select “Remove” and press [OK].

Register track to Playlist

HDD

You can register your favourite albums and tracks into 10 preset playlists.

- Name of the playlist can be changed.
- New playlist cannot be added.
- Up to 999 tracks can be registered to each playlist.

- 1 Press [FUNCTION MENU].
- 2 Press [▲, ▼] to select “Play Music” and press [OK].

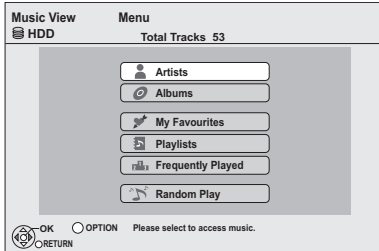

- 3 Press [▲, ▼] to select item and press [OK].

■ When “Artists” is selected

- ① Press [◀, ▶] to select the initial of the artist.
- ② Press [▲, ▼] to select the name of the artist, and press [OK].
- ③ Press [▲, ▼] to select the album.
 - To register the track, press [OK], and select the track with [▲, ▼].

■ When “Albums” is selected

- ① Press [◀, ▶] to select the initial of the album.
- ② Press [▲, ▼] to select the album.
 - To register the track, press [OK], and select the track with [▲, ▼].

- 4 Press [OPTION].
- 5 Press [▲, ▼] to select “Add to Playlist” and press [OK].
- 6 Press [▲, ▼] and select the playlist to register, and press [OK].

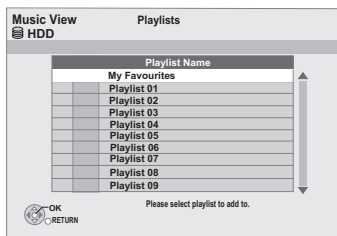

To return to the previous screen

Press [RETURN ↵].

To exit the screen

Press [EXIT].

Editing Playlist

HDD

- 1 Press [FUNCTION MENU].
- 2 Press [▲, ▼] to select “Play Music” and press [OK].
- 3 Press [▲, ▼] to select “Playlists” and press [OK].
- 4 Edit the playlist
Press [▲, ▼] to select the playlist and press [OPTION].

e.g., while selecting playlist

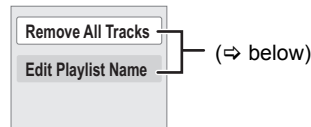

Edit the track in the playlist

- ① Press [▲, ▼] to select the playlist and press [OK].
- ② Press [▲, ▼] to select the track and press [OPTION].

e.g., while selecting the track in playlist

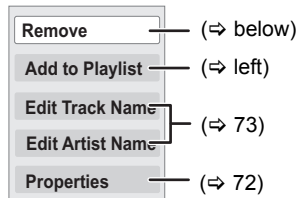

- 5 Press [▲, ▼] to select item and press [OK].

To return to the previous screen

Press [RETURN ↵].

To exit the screen

Press [EXIT].

Playlist operation

After performing steps 1–4 (⇒ above, Editing Playlist)

Remove All Tracks	Remove all tracks in the selected playlist. Tracks themselves are not deleted from the HDD. Press [◀, ▶] to select “Remove” and press [OK].
Remove	Selected track is removed. Track itself is not deleted from the HDD. Press [◀, ▶] to select “Remove” and press [OK].
Edit Playlist Name	(⇒ 80, Entering text)

Copying music to HDD

You can store the two formats of music data in this unit's HDD.

Music CD (CD-DA)

When inserting music CDs, this unit makes access to the internal Gracenote® Database to obtain title information. The album name, track name and artist name are assigned automatically allowing you find the track easily when playing back.

MP3

You can copy MP3 files from the DVD-R, DVD-R DL, CD or USB memory.

The track name and artist name will be displayed on this unit if the information is contained in ID3 tag of the MP3 file.

About the Gracenote® Database

The Gracenote® Database is a database used to search and retrieve music CD title information.

When a music CD is inserted, the unit will automatically search for and obtain information about the inserted music CD.

The Gracenote® Database comes pre-installed on this unit, so titles and artist information can be obtained. This unit has an internal database containing information for approximately 350,000 album titles.

If the title of the newly released music CD is not in the built-in database, it is possible to acquire the title automatically by connecting to the network via the Internet. (⇒ 103)

If there are music CDs with very similar title information, then the incorrect title information may be obtained. If no title suggestions are found, it is displayed as "Unknown Artist", "Unknown Album".

In these cases, enter the music CD title information manually, after recording to the HDD has completed.

Copying music from a disc or a USB memory

-R -R DL CD USB → HDD

- **CD** (Music CD): All tracks in the CD will be recorded.
- **-R -R DL CD USB** (MP3): All tracks in the folder will be recorded. (Cannot record track-by-track.)
- It will be recorded as 1 album to the HDD in 1 recording.
- **Audio quality**
 - CD** (Music CD): LPCM.
 - R -R DL CD USB** (MP3): MP3
- The maximum number of tracks on HDD: 40000 (Depends on the remaining capacity.)
If titles or pictures are recorded, then the number of albums that can be recorded will be reduced.

1 While stopped

Insert a disc or USB memory.

CD (Music CD)

The unit starts accessing the Gracenote® Database and searches for the title information.



If search results indicate that multiple titles were found Press [▲, ▼] to select the appropriate title and press [OK].

-R -R DL CD (MP3) USB

The menu is automatically displayed.

Press [▲, ▼] to select "Play / Copy Music (MP3)" and press [OK].

- **-R -R DL CD (MP3)** It will go to step 2 automatically if it is only MP3 that is recorded.

e.g., **CD (MP3) USB**

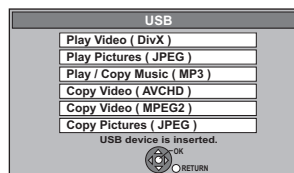
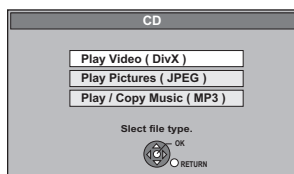

- Display items differ depending on what is recorded in each media.

2 Press the "Blue" button.

e.g., **CD** (Music CD)

Playing track

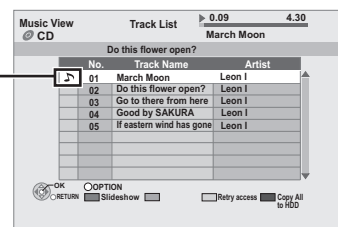

3 Press [◀, ▶] to select "Copy" and press [OK].

Recording starts.

To return to the previous screen in steps 1 to 3

Press [RETURN ↵].

To stop recording after step 3

Press and hold [RETURN ↵] for 3 seconds.

If the menu screen (⇒ above) is not displayed, display it by performing the following operation.

- 1 Press [FUNCTION MENU].
- 2 **-R -R DL CD**
Press [▲, ▼] to select "Blu-ray Disc / DVD" and press [OK].
USB
Press [▲, ▼] to select "USB" and press [OK].

Note

- While recording, no other operations can be performed. Timer recordings will not proceed.
- Tracks recorded on the HDD cannot be transferred to a disc, USB memory or SD card.
- CDs which have SCMS (Serial Copy Management System) restrictions cannot be recorded to the HDD.

You can enjoy linked operations with the TV and receiver by using “HDAVI Control” or Q Link.

What is VIERA Link “HDAVI Control”?

VIERA Link “HDAVI Control” is a convenient function that offers linked operations of this unit, and a Panasonic TV (VIERA) or receiver under “HDAVI Control”. You can use this function by connecting the equipment with the HDMI cable. See the operating instructions for connected equipment for operational details.

- VIERA Link “HDAVI Control”, based on the control functions provided by HDMI which is an industry standard known as HDMI CEC (Consumer Electronics Control), is a unique function that we have developed and added. As such, its operation with other manufacturers' equipment that supports HDMI CEC cannot be guaranteed.
- **This unit supports “HDAVI Control 4” function.** “HDAVI Control 4” is the newest standard (current as of December, 2008) for Panasonic's HDAVI Control compatible equipment. This standard is compatible with Panasonic's conventional HDAVI equipment.
- Please refer to individual manuals for other manufacturers' equipment supporting VIERA Link function.

Preparation

- 1 Connect this unit to your TV using an HDMI cable and a fully wired 21-pin Scart cable (⇒ 17), or to your receiver using an HDMI cable (⇒ 102).
- 2 Set “VIERA Link” to “On” (⇒ 93). (The default setting is “On”.)
- 3 Set the “HDAVI Control” operations on the connected equipment (e.g., TV).
 - **Set the input channel on VIERA to suit the terminal to be used as “HDAVI Control”.**
- 4 Turn on all “HDAVI Control” compatible equipment and select this unit's input channel on the connected TV so that the “HDAVI Control” function works properly.

Also when the connection or settings are changed, repeat this procedure.

What is Q Link?

Q Link is a convenient function that offers linked operations of this unit and a Panasonic TV. You can use this function by connecting the equipment with a fully wired 21-pin Scart cable.

Preparation

- Connect this unit to your TV with a fully wired 21-pin Scart cable (⇒ 17).

For your reference

The following systems from other manufacturers have similar function to Q Link from Panasonic.

For details, refer to your television's operating instructions or consult your dealer.

- Q Link (registered trademark of Panasonic)
- DATA LOGIC (registered trademark of Metz)
- Easy Link (registered trademark of Philips)
- Megalogic (registered trademark of Grundig)
- SMARTLINK (registered trademark of Sony)

What you can do with “HDAVI Control” and Q Link

(When the TV is on)

Easy playback **VIERA Link** **Q Link**

When the TV is on and the following operations are performed, the TV's input will automatically switch to HDMI input mode (**VIERA Link**) or AV input mode (**Q Link**) and the TV displays the corresponding action.

(Picture or sound may not be available for the first few seconds.)

Press **[FUNCTION MENU]*1**, **[▶] (PLAY)*2**, **[DIRECT NAVIGATOR]**, **[GUIDE]**, **[PROG/CHECK] etc.**

(When the TV is off)

Power on link **VIERA Link** **Q Link**

When the TV is off and the following operations are performed, the TV will automatically turn on and displays the corresponding action. (Picture or sound may not be available for the first few seconds.)

Press **[FUNCTION MENU]*1**, **[▶] (PLAY)*2**, **[DIRECT NAVIGATOR]**, **[GUIDE]**, **[PROG/CHECK] etc.**

- **BD-V DVD-V CD**

The TV is automatically turned on when you insert the discs.

Power off link **VIERA Link** **Q Link**

When you set the TV to standby mode, the unit is also automatically set to standby mode. The unit is automatically set to standby mode even if the FUNCTION MENU screen etc. is displayed during playback or when the unit set to a timer recording. Even if the TV is set to standby mode, the unit will not be set to standby mode at the same time when recording, copying, finalising etc.

- When this unit is connected to an “HDAVI Control” compatible Panasonic receiver with an HDMI cable, the receiver will also turn off.

Direct TV Recording **VIERA Link** *3 **Q Link**

This function allows you to immediately start recording the programme that you are viewing on the TV.

Press and hold [● DIRECT TV REC] for 1 second.

Recording starts.

- The titles are recorded to the HDD.

To stop recording

Press **[■]**.

- This function does not work during EXT LINK standby or recording.

Playing music continuously even after turning off power to the television*4

(⇒ 72, Playing music continuously even after turning off power to the television)

- *1 This button is available only when this unit is on.
- *2 When this button is pressed, the playback image is not immediately displayed on the screen and it may not be possible to watch the contents from where playback started. In this case, press **[◀◀]** or **[▶▶]** to go back to where playback started.
- *3 This function is available with the TV that supports “HDAVI Control 3” or later.
- *4 This function is available with the TV that supports “HDAVI Control 2” or later.

Note

- These functions may not work normally depending on the equipment condition.
- About “HDAVI Control” function, read the manual of the connected equipment (e.g., TV) too.

Easy control only with VIERA remote control

If you connect this unit to the TV that has "HDAVI Control 2" or later function with an HDMI cable, you can enjoy using more convenient functions.

You can operate this unit using buttons on the TV remote control. The buttons that you can use for this unit vary depending on the TV. For details, refer to the operating instructions of the TV. Use the remote control supplied with this unit if you cannot operate this unit using buttons on the TV remote control.

- The operation of this unit may be interrupted when you press incompatible buttons on the TV remote control.

Using the FUNCTION MENU window to operate this unit **VIERA Link**^{*1}

Refer to the TV operating instructions for operating the TV.

1 Display this unit's "FUNCTION MENU" window using the TV remote control.

- If this unit is set to standby mode, it will automatically turn on.

2 Select the item you want to operate with the TV remote control, and press [OK].

- About the FUNCTION MENU window (⇒ 13).

Pause Live TV programme **VIERA Link**^{*2}

You can pause the TV programme you are watching and resume later by temporarily saving it on the HDD. This is useful when you have to briefly stop watching TV to run an errand.

If you stop the Pause Live TV function, then the TV programme temporarily saved on the HDD will be deleted.

Refer to the TV operating instructions for operating the TV.

1 When you want to pause the TV programme

Turn on the "Pause Live TV" function using the TV remote control.

- This unit turns on automatically.

2 When you want to resume

Display the Control Panel (⇒ right) and press [OK].

- The TV programme resumes.

To stop Pause Live TV

① Press [▼] while the Control Panel is displayed.

② Press [◀, ▶] to select "Yes" and press [OK].

Note

- Subtitles are not displayed correctly if the setting for Subtitle Character Set is different between this unit and the TV.

- This function does not work with TV's analogue broadcast programmes during EXT LINK standby or recording.

Refer to other "Note" on page 79, "To pause the TV programme you are watching—Pause Live TV".

Using the OPTION menu window to operate this unit **VIERA Link**^{*1}

By using the TV remote control, you can play discs using the "Control Panel" (⇒ below) and display the Top Menu for DVD-Video.

1 Press [OPTION].

Note

OPTION menu may be disabled when operating the BD-Video or DVD-Video.

e.g.,



2 Select an item then press [OK].

Control Panel	Control Panel is displayed (⇒ below).
Switch to TV	Displayed when watching digital satellite broadcasts with the tuner of this unit. It will return to the TV picture.
FUNCTION MENU	FUNCTION MENU window is displayed (⇒ left).
Aspect	Switch the screen mode (⇒ 83).
Multi Audio	Switch the signal (⇒ 28).
Sub Channel	
Subtitle Language	
Play Menu	Play Menu is displayed (⇒ 82).
Top Menu BD-V DVD-V	Top Menu is displayed (⇒ 21).
Menu DVD-V	Menu is displayed.
Pop-up Menu BD-V	Pop-up Menu is displayed.
Drive Select	Select the HDD, BD or SD drive
Rotate RIGHT (JPEG)	Rotate the still picture (⇒ 65).
Rotate LEFT (JPEG)	
Zoom in (JPEG)	Enlarge or shrink the still picture (⇒ 65).
Zoom out (JPEG)	
TV Power Off	Play music continuously even after turning off power to the television (⇒ 72).

Using the Control Panel

Using the Control Panel, you can operate search backward, search forward, stop, etc. with the TV remote control.

Perform steps 1 and 2 of "Using the OPTION menu window to operate this unit **VIERA Link**^{*1}" (⇒ above).

The Control Panel is displayed (⇒ below).

- When playing a title or DVD-Video, etc.
 - [▲]: Pause, [▼]: Stop, [◀]: Search backward, [▶]: Search forward, [OK]: Play, [EXIT]: Exit the Control Panel.

- While playing still pictures

– [▼]: Stop, [◀]: View previous picture, [▶]: View next picture, [EXIT]: Exit the Control Panel.

Control Panel

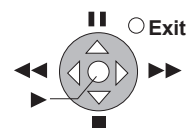

^{*1} This function is available with the TV that supports "HDAVI Control 2" or later.

^{*2} This function is available with the TV that supports "HDAVI Control 3" or later.

When you want to leave the TV on and set only this unit to standby mode

Press [⏻] on this unit's remote control and set to standby mode.

When not using "HDAVI Control"

Set "VIERA Link" in the Setup menu to "Off" (⇒ 93).

You can access a selection of Internet services from the Home screen with VIERA CAST, for example YouTube, Picasa Web Albums. (Current as of December 2009)

Preparation

- Network connection (⇒ 103)
- Network Settings (⇒ 94)

1 Press [VIERA CAST].

Message is displayed. Please read these instructions carefully and then press [OK].

2 Press [▲, ▼, ◀, ▶] to select the item and press [OK].

- You can operate VIERA CAST using the following buttons on the unit's remote control. [▲, ▼, ◀, ▶], [OK], [RETURN ↵], coloured buttons and numbered buttons.

VIERA CAST Home screen;

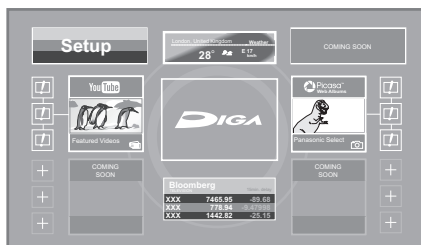

Images are for illustration purpose, contents may change without notice.

Note

- If using slow Internet connection, the video may not be displayed correctly. A high-speed Internet service with a speed of at least 6 Mbps is recommended.
- Be sure to update the software (firmware) when a software (firmware) update notice is displayed on the screen. If the software (firmware) is not updated, you will not be able to use the VIERA CAST™ function.
- VIERA CAST™ Home screen is subject to change without notice.
- The services through VIERA CAST™ are operated by their respective service providers, and service may be discontinued either temporarily or permanently without notice. Therefore, Panasonic will make no warranty for the content or the continuity of the services.
- All features of websites or content of the service may not be available.
- Some content may be inappropriate for some viewers.
- Some content may only be available for specific countries and may be presented in specific languages.
- If timer recording starts, VIERA CAST will stop.

For details of VIERA CAST Home screen

Refer to a help item on the home screen.

To return to VIERA CAST Home screen

Press [VIERA CAST].

To exit from VIERA CAST

Press [EXIT].

- Set the "Lock" to "On" to restrict using VIERA CAST. (⇒ 94)
- Set the "Automatic Volume Control" to "Off" when the audio is warped while using the VIERA CAST. (⇒ 94)

Pause Live TV

To pause the TV programme you are watching—Pause Live TV

You can pause the TV programme you are watching using this unit's tuner and resume later by temporarily saving it on the HDD. This is useful when you have to briefly stop watching TV to run an errand. If you stop the Pause Live TV function, then the TV programme temporarily saved on the HDD will be deleted.

- 1 When you want to pause the TV programme while watching TV
Press [II].

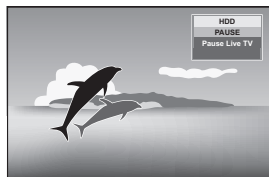

- 2 When you want to resume
Press [▶] (PLAY).

- The programme is saved on the HDD in DR recording mode.
- Programmes can be saved temporarily up to 8 hours on the HDD. (This may vary depending on the HDD free space.)

Operation during Pause Live TV

Search	Press [◀◀, ▶▶]. The speed increases up to 5 steps. • Press [▶] (PLAY) to restart play.
Pause	Press [II]. • Press [▶] (PLAY) to restart.
Quick View	Press and hold [▶] (PLAY/×1.3). • Press again to return to the normal speed.
Slow-motion	While paused, press [◀◀] or [▶▶]. The speed increases up to 5 steps. • Press [▶] (PLAY) to restart play.
Stop Pause Live TV	1 Press [■]. 2 Press [◀, ▶] to select "Yes" and press [OK].

Note

- Temporary save is stopped in following cases.
 - When save time exceeds 8 hours
 - When save time exceeds 1 hour with no HDD free space
 - When 2 programmes are recorded simultaneously
 - When start time of a timer recording arrives*
 - The Pause Live TV function does not work
 - The clock is not set.
 - While 2 programmes simultaneous recording
 - While watching a programme being recorded
 - When DV is selected
 - When a radio programme is selected
 - During recording*
 - Titles that are copyright protected (Copying is prohibited) cannot be viewed going back in time more than the allowed playback period.
 - When this unit is not operated for approximately 5 minutes while the screen is being displayed the screen saver is displayed [only when the "Screen Saver" in Setup menu is set to "On" (⇒ 92)]. To return to the previous screen, press [RETURN ↵].
- * Only when "One cable" has been selected in Auto Setup (⇒ 18, 87).

DLNA feature

You can enjoy the video saved on the HDD of this unit on DLNA compatible equipment connected via a network.

For details regarding connection and operation of equipment connected via a network, refer to their respective operating instructions.

- Network connection (⇒ 103)
- Register the DLNA compatible equipment to this unit (⇒ 97, Register the DLNA compatible equipment to this unit)
- Network Settings (⇒ 94)

Note

- You cannot playback the titles on other DLNA compatible equipment from this unit.
- Still pictures, music, and copyright protected (Copying is prohibited) titles cannot be played back.
- Editing is not possible. (Only delete can be performed from Panasonic equipment)
- Programme being recorded cannot be played back.
- Playback via DLNA compatible equipment cannot be done when this unit is in the following conditions:
 - While simultaneously recording 2 programmes
 - While playing back a disc
 - While simultaneously performing High speed copy and recording
 - While displaying the Setup menu
 - While executing functions using a network, such as "VIERA CAST"
- There may be some video that cannot be played back on DLNA compatible equipment depending on the equipment.
- You cannot playback simultaneously from 2 or more items of DLNA compatible equipment.

Playing back from Panasonic DLNA compatible equipment

- 1 Operate the playback equipment to display the list of titles on this unit.
 - For operation of the equipment, refer to their respective operating instructions.
- 2 Press [▲, ▼, ◀, ▶] to select the item to playback (folder), and press [OK]
 - Menu structure will be different depending on the equipment connected to this unit. Select the contents by repeating the operation.
 - Control Panel is displayed once the playback starts. Operation can be performed with [▲, ▼, ◀, ▶], [OK], and [EXIT].

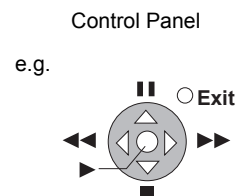

- Press [OK] if the Control Panel is not displayed.
- Even with Panasonic DLNA compatible equipment, listing of titles or playback method may be different. In such cases, operate following the operating instructions of that equipment, or following the instructions on the screen.

Playing back from non-Panasonic DLNA compatible equipment

Select the title on this unit from the connected equipment, and start the playback.

- For operation of the equipment, refer to their respective operating instructions.

Entering text

HDD BD-RE BD-R RAM -R -R DL -RW(V) +R +R DL +RW SD

You can give names to recorded titles, etc.
The maximum number of characters:

HDD BD-RE BD-R RAM	Characters
Title (HDD RAM)	64 (44*)
Title (BD-RE BD-R)	254
Album of still pictures (HDD BD-RE RAM)	36
Album (Music) (HDD)	59
Track (HDD)	59
Artist (HDD)	39
Playlist (Music) (HDD)	59
Disc (BD-RE BD-R)	254
Disc (RAM)	64

*Title name for timer recording

-R -R DL -RW(V) +R +R DL +RW	Characters
Title	44
Disc	40

SD	Characters
Album of still pictures	36

Note

If a name is long, parts of it may not be shown in some screens.

1 Show Enter Title Name screen.

Title (timer recording)

Select "Input Name" in step 3 on page 35.

Title

Select "Enter Title Name" in step 4 on page 48.

Disc

Select "Disc Name" in step 1 of "Providing a name for a disc" on page 84.

Album of still pictures (HDD BD-RE RAM SD)

Select "Enter Album Name" in step 4, "Editing still pictures (JPEG)" on page 66.

Album (Music) (HDD)

Select "Edit Album Name" in step 5 of "Editing music" on page 73.

Track (HDD)

Select "Edit Track Name" in step 5 of "Editing music" on page 73.

Artist (HDD)

Select "Edit Artist Name" in step 5 of "Editing music" on page 73.

Playlist (Music) (HDD)

Select "Edit Playlist Name" in step 5 of "Editing Playlist" on page 74.

Name field: shows the text you have entered

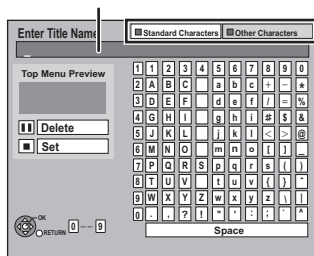

Press the "Red" button or "Green" button to select character type and press [OK].

"Standard Characters":
(=> left, Alphabet characters, etc.)

"Other Characters":
(=> below, Umlaut characters, accented characters, etc.)

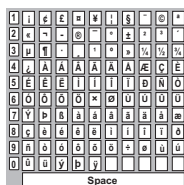

2 Press [▲, ▼, ◀, ▶] to select a character and press [OK].

Repeat this step to enter other characters.

• To delete a character

Press [▲, ▼, ◀, ▶] to select the character in the name field and press [II]. (The selected characters are deleted.)

• Using the numbered buttons to enter characters e.g., entering the letter "R"

- Press [7] to move to the 7th row.
- Press [7] twice to highlight "R".
- Press [OK].

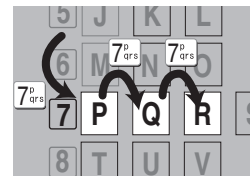

3 Press [■] (Set).

"Writing..." appears then the screen returns to the Title view screen and so on.

To end partway

Press [RETURN ⏏].
Text is not added.

For your reference

If you enter a long name, only part of it is shown in the Top Menu after finalisation or creating Top Menu (=> 86). When entering a title name, the name that will appear in the Top Menu can be previewed in "Top Menu Preview" window.

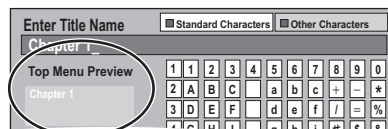

Using on-screen menus

Common procedures

1 Press [DISPLAY].

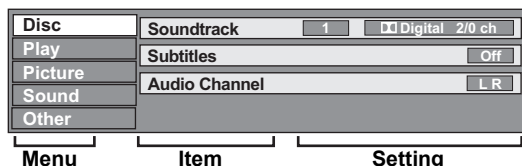

- Depending on the condition of the unit (playing, stopped, etc.) and disc contents, there are some items that you cannot select or change.
- The menu is not displayed when playing still pictures.

2 Press [▲, ▼] to select the menu and press [▶].

3 Press [▲, ▼] to select the item and press [▶].

4 Press [▲, ▼] to select the setting.

- Some items can be changed by pressing [OK].

To clear the on-screen menus

Press [DISPLAY].

Disc menu—Setting the disc content

Video **AVCHD**

The video recording method appears

Signal Type

BD-V

• Primary Video

Video: The video recording method appears.
 Soundtrack: Select the type of audio or language.

• Secondary Video

Video: Select on/off of images.
 The video recording method appears.
 Soundtrack: Select on/off of audio and the language.

Soundtrack*

HDD **BD-RE** **BD-R** [Except titles recorded in DR mode, or copied from high definition video (AVCHD format)]

RAM **-R** **-R DL** **-RW(V)** **+R** **+R DL** **+RW** **-RW(VR)**

The disc's audio attributes appear (⇒ right, Audio attribute).

DVD-V **AVCHD**

Select the audio and language (⇒ right, Audio attribute, Language).

DivX

Select the soundtrack number.

Soundtrack numbers are displayed even when there is only one audio type.

Subtitles*

BD-V **DVD-V** **AVCHD**

Turn the subtitle on/off and select the language (⇒ below, Language).

HDD **BD-RE** **BD-R** [Except titles recorded in DR mode, or copied from high definition video (AVCHD format)]

RAM **-R** **-R DL** **-RW(V)** **+R** **+R DL** **+RW** **-RW(VR)**
 (Only discs that contain subtitle on/off information)

Turn the subtitle on/off.

• Subtitle on/off information cannot be recorded using this unit.

DivX

Turn the subtitle on/off and select the subtitle number.

• Subtitle number is displayed even if there are not multiple subtitles.

• You can select "Text" in the subtitle number while playing back a DivX video file containing DivX subtitle text. DivX subtitles text is displayed as a closed caption by selecting "Text".

Multi Audio **HDD** **BD-RE** **BD-R** [Titles recorded in DR mode, or copied from high definition video (AVCHD format)]

Switch in the case of multiple audio.

Subtitle Language **HDD** **BD-RE** **BD-R** [Titles recorded in DR mode, or copied from high definition video (AVCHD format)]

Select the subtitle language in the case of multiple languages.

Subtitle Style **BD-V**

Select the subtitle style recorded on the disc.

Angle* **BD-V** **DVD-V** **+R** **+R DL** **+RW**

Change the number to select an angle.

Audio Channel **HDD** **BD-RE** **BD-R** (Titles in recording mode other than DR) **RAM** **-R** **-R DL** **-RW(V)** **-RW(VR)** and **DivX**

(⇒ 40, Changing audio during play)

* With some discs, you may only be able to make changes using the menus (⇒ 21) on the disc.

• The display changes according to the disc content. You cannot change when there is no recording.

Audio attribute

LPCM/**D**Digital/**D**Digital+/
DTrueHD/DTS/DTS-HD/MPEG: Signal type
 k (kHz): Sampling frequency
 b (bit): Number of bits
 ch (channel): Number of channels

Language

ENG: English	DAN: Danish	THA: Thai
FRA: French	POR: Portuguese	POL: Polish
DEU: German	RUS: Russian	CES: Czech
ITA: Italian	JPN: Japanese	SLK: Slovak
ESP: Spanish	CHI: Chinese	HUN: Hungarian
NLD: Dutch	KOR: Korean	FIN: Finnish
SVE: Swedish	MAL: Malay	*: Others
NOR: Norwegian	VIE: Vietnamese	

Play menu—Change the play sequence

This function works only when the elapsed play time is displayed. Select the item for repeat play. Depending on the disc, the items that can be selected will differ.

Repeat Play

HDD BD-RE BD-R BD-V RAM -R -R DL -RW(V) +R +R DL +RW
DVD-V -RW(VR) CD USB AVCHD

Items displayed depends on the contents of the playback.

- All
- Title
- Chapter
- Playlist
- Track

Select "Off" to cancel.

Random (Only when playing music)

HDD -R -R DL CD USB

While playing, press [▲, ▼] to select "On".

Picture menu—Change the picture quality

Mode

HDD BD-RE BD-R BD-V RAM -R -R DL -RW(V) +R +R DL +RW
DVD-V -RW(VR) AVCHD

Select the picture quality mode during play.

- **Normal:** Default setting
- **Soft:** Soft picture with fewer video artifacts
- **Fine:** Details are sharper
- **Cinema:** Mellows movies, enhances detail in dark scenes. (This does not affect the titles in DR mode.)

HD optimizer

HDD BD-RE BD-R BD-V RAM -R -R DL -RW(V) +R +R DL +RW
DVD-V -RW(VR) AVCHD and DivX

It will compensate the mosaic noise in the video and haze around the characters precisely.

Progressive*

Select the method of conversion for progressive output to suit the type of title being played (⇒ 118, Film and video).

- **Auto:** Automatically detects the film and video content, and appropriately converts it.
- **Video:** Select when using "Auto", and the content is distorted.
- **Film:** Select this if the edges of the film content appear jagged or rough when "Auto" is selected. However, if the video content is distorted as shown in the illustration to the right, then select "Auto".

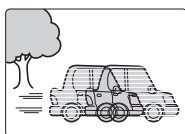

* It will work when "HDMI Video Mode" in the Setup menu is "Off" (⇒ 93) and "Component Resolution" in the Setup menu is "576p/480p" (⇒ 94) and playing DVD-V.

Sound menu—Change the sound effect

Sound Effects

HDD BD-RE BD-R BD-V RAM -R -R DL -RW(V) +R +R DL +RW
DVD-V -RW(VR) CD USB AVCHD

- **Re-master 1**
- **Re-master 2**
(Discs record at 48 kHz or less)
This feature gives you a more natural sound by adding higher frequency signals not recorded on the track.
- This function is effective for audio from the HDMI terminal or the DIGITAL AUDIO OUT terminal only when "Dolby D/Dolby D +/Dolby TrueHD", "DTS/DTS-HD" or "MPEG" is set to "PCM" (⇒ 91). (However, in this case, audio is output as 2ch from the DIGITAL AUDIO OUT terminal.)

Dialogue Enhancer

HDD BD-RE BD-R BD-V RAM -R -R DL -RW(V) +R +R DL +RW
DVD-V -RW(VR) AVCHD and DivX

(3-channel or over only, including a centre channel)

The volume of the centre channel is raised to make dialogue easier to hear.

Other menu—Change the display position

Position

HDD BD-RE BD-R BD-V RAM -R -R DL -RW(V) +R +R DL +RW
DVD-V -RW(VR) CD USB SD AVCHD and DivX

Change where this menu screen appears on your TV.

Status messages

Status of this unit during recording or playback can be displayed with the following operation.

The status message will differ depending on the media or status of this unit.

Press [STATUS ①].

The display changes each time you press the button.

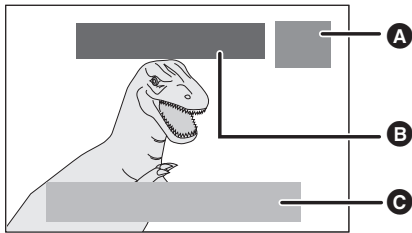

A Status of this unit is displayed.
e.g.,

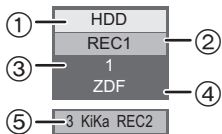

- ① Selected drive status/type of disc or USB memory
- ② Recording status/the remaining time/play status
- ③ Channel
- ④ The name of the station
- ⑤ Recording in background/copy progress indicator (When recording 2 programmes simultaneously.)

B Detailed status of this unit is displayed.
e.g.,

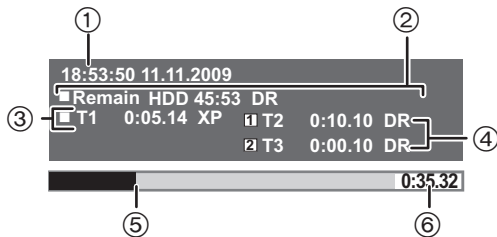

• When using Pause Live TV



- ① Date and time
- ② Available recording time and recording mode
- ③ Title number and elapsed time during play and recording mode
- ④ Title number and elapsed time during recording and recording mode
- ⑤ Current play position
- ⑥ Total time
- ⑦ Current time
- ⑧ The time when the picture currently displayed on the television was broadcasted

C Status of the broadcast being received is displayed. (⇒ 27)



Switch the aspect ratio of the screen

When black bars are shown at the top, bottom, left, and right sides of the screen, you can enlarge the image to fill the screen.

- 1 Press [OPTION].
- 2 Press [▲, ▼] to select "Aspect" and press [OK].
- 3 Press [◀, ▶] to select the item.

- **Normal:**
Normal output
- **Side cut:**

The black bars on the right and left sides of the 16:9 image disappear and the image is enlarged. Please note that the right and left sides of the image are cut off when the black bar is not displayed.

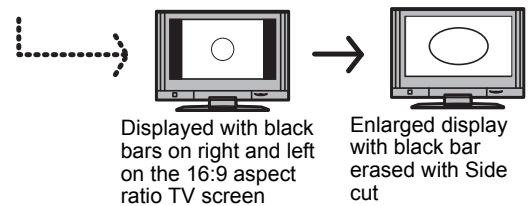
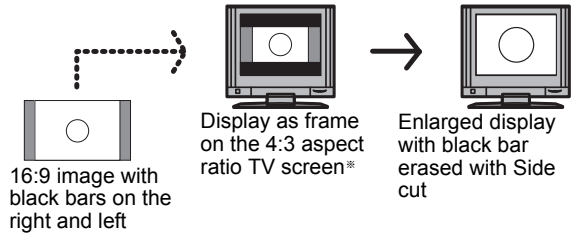

* Only when "TV Aspect" (⇒ 92) is set to "Letterbox".

- **Zoom:**
The black bars on the top and bottom sides of the 4:3 image disappear and the image is enlarged. Please note that the top and bottom sides of the image are cut off when the black bar is not displayed.

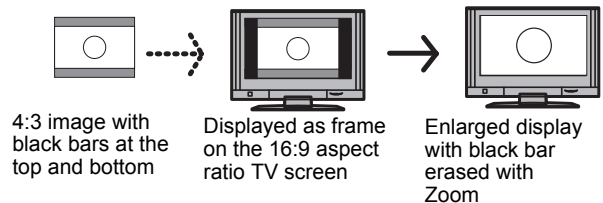

4 Press [OK].

Note

- The screen mode is switched to "Normal" in the following situations:
 - when you change channel
 - when you start or end the playback of a title
 - when the unit is turned off or on.
- **BD-V DVD-V** "Side cut" does not have any effect.
- When "TV Aspect" (⇒ 92) is set to "Pan & Scan" or "Letterbox", the "Zoom" effect is disabled.

To return to the previous screen

Press [RETURN ↵].

To exit the screen

Press [EXIT].

BD-RE BD-R RAM -R -R DL -RW(V) +R +R DL +RW -RW(VR)
SD

Common procedures

- 1 While stopped
Press [FUNCTION MENU].
- 2 Press [▲, ▼] to select “Blu-ray Disc / DVD” or “SD Card” and press [OK].

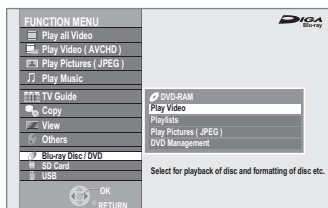

- 3 Press [▲, ▼] to select “Blu-ray Disc Management”, “DVD Management” or “Card Management” and press [OK].

e.g., **RAM**

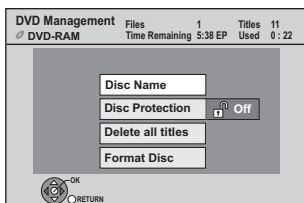

To return to the previous screen

Press [RETURN ↵].

To exit the screen

Press [EXIT].

Setting the protection

BD-RE BD-R RAM

After performing steps 1–3 (⇒ left)

- 1 Press [▲, ▼] to select “Disc Protection” and press [OK].
- 2 Press [◀, ▶] to select “Yes” and press [OK].

e.g., **RAM**

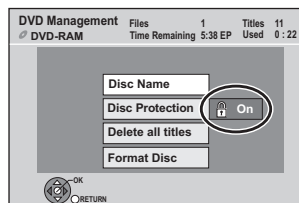

The lock symbol appears closed when the disc is write-protected.

To return to the previous screen

Press [RETURN ↵].

To exit the screen

Press [EXIT].

Providing a name for a disc

BD-RE BD-R RAM -R -R DL -RW(V) +R +R DL +RW

You can provide a name for each disc.

Preparation

- **BD-RE BD-R RAM** Release protection (⇒ above, Setting the protection).

After performing steps 1–3 (⇒ left)

- 1 Press [▲, ▼] to select “Disc Name” and press [OK].

(⇒ 80, Entering text)

- The disc name is displayed in the Blu-ray Disc Management/DVD Management window.
- **-R -R DL -RW(V) +R +R DL** With a finalised disc, the name is displayed on the Top Menu.
- **+RW** The disc name is displayed only if you play the disc on other equipment after creating top menu.



To return to the previous screen

Press [RETURN ↵].

To exit the screen

Press [EXIT].

Deleting all titles—Delete all titles

BD-RE BD-R RAM

Preparation

- Release protection (⇒ 84, Setting the protection).

After performing steps 1–3 (⇒ 84, Common procedures)

- 1 Press [▲, ▼] to select “Delete all titles” and press [OK].
- 2 Press [◀, ▶] to select “Yes” and press [OK].
- 3 Press [◀, ▶] to select “Start” and press [OK].
A message appears when finished.
- 4 Press [OK].

To return to the previous screen

Press [RETURN ↵].

To exit the screen

Press [EXIT].

Note

- Once deleted, the recorded contents are lost and cannot be restored. Make certain before proceeding.
- Still picture data (JPEG) or computer data cannot be deleted.
- Delete does not work if one or more titles are protected.

Delete BD-Video data

SD

You can delete the BD-Live video data (⇒ 46).

Preparation

After performing steps 1–3 (⇒ 84, Common procedures)

- 1 Press [▲, ▼] to select “Delete BD-Video data” and press [OK].
- 2 Press [◀, ▶] to select “Yes” and press [OK].
- 3 Press [◀, ▶] to select “Start” and press [OK].
A message appears when finished.
- 4 Press [OK].

Enabling the unit’s recording function—Format

BD-RE RAM -RW(V) +RW -RW(VR)

BD-R +R +R DL (New disc only)

SD

Preparation

- BD-RE BD-R RAM SD Release protection (⇒ 11, 84, Setting the protection).

Note

Formatting deletes all contents (including computer data), and they cannot be restored. Check carefully before proceeding. The contents are deleted when you format a disc or card even if you have set protection.

After performing steps 1–3 (⇒ 84, Common procedures)

- 1 Press [▲, ▼] to select, “Format Disc” or “Format Card” and press [OK].
- 2 Press [◀, ▶] to select “Yes” and press [OK].
- 3 Press [◀, ▶] to select “Start” and press [OK].
A message appears when formatting is finished.
- 4 Press [OK].

Note

- When a disc or card has been formatted using this unit, it may not be possible to use it on any other equipment.
- -R -R DL CD Formatting cannot be performed.
- -RW(V) -RW(VR) You can format DVD-RW only as DVD-Video format on this unit.
- HDD Perform “Format HDD” in the Setup menu (⇒ 90).

To stop formatting RAM

Press [RETURN ↵].

- You can cancel formatting if it takes more than 2 minutes. The disc must be reformatted if you do this.

To return to the previous screen

Press [RETURN ↵].

To exit the screen

Press [EXIT].

Selecting the background style—Top Menu

-R -R DL -RW(V) +R +R DL +RW

The background selected here will be displayed as the DVD-Video top menu after finalising or Create Top Menu (**+RW**).

After performing steps 1–3 (⇒ 84, Common procedures)

- 1 Press [**▲**, **▼**] to select “Top Menu” and press [**OK**].
- 2 Press [**▲**, **▼**, **◀**, **▶**] to select the background and press [**OK**].

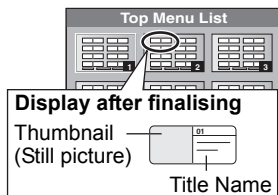

- You can change thumbnails displayed in the top menu. (⇒ 49, Change Thumbnail)

Selecting whether to show the Top Menu first—Auto-Play Select

-R -R DL -RW(V) +R +R DL +RW

You can select whether to show the top menu after finalising or creating Top Menu (**+RW**).

After performing steps 1–3 (⇒ 84, Common procedures)

- 1 Press [**▲**, **▼**] to select “Auto-Play Select” and press [**OK**].
- 2 Press [**▲**, **▼**] to select “Top Menu” or “Title 1” and press [**OK**].

Top Menu: The top menu appears first.

Title 1: The disc content is played without displaying the top menu.

Finalising—Finalise

-R -R DL -RW(V) +R +R DL

You can play these discs on compatible DVD players by finalising it on the unit, effectively making it into DVD-Video that complies with DVD-Video standards. Before finalising, select the background on the “Top Menu” (⇒ above). The menu you create with the unit can also be used on most DVD players.

BD-R

- Finalising BD-R prevents accidental recording or editing.
- BD-R that were recorded on this unit may not be played on other Blu-ray Disc players, etc. whether or not you finalise it.

After performing steps 1–3 (⇒ 84, Common procedures)

- 1 Press [**▲**, **▼**] to select “Finalise” and press [**OK**].
- 2 Press [**◀**, **▶**] to select “Yes” and press [**OK**].
- 3 Press [**◀**, **▶**] to select “Start” and press [**OK**].

A message appears when finalising is finished.

Note

- You cannot cancel finalising.
- Finalising takes up to 15 minutes.
- (**-R DL +R DL**) Finalising takes up to 60 minutes.)
- Do not disconnect the AC mains lead while finalising. This will render the disc unusable.

- 4 Press [**OK**].

Note

When finalising a high-speed recording compatible disc, it may take longer than displayed on the confirmation screen (approximately four times longer).

After finalising

- **BD-R -R -R DL +R +R DL** The disc becomes play-only and you can no longer record or edit.
- **-RW(V)** You can record and edit the disc after formatting (⇒ 85) although it becomes play-only after finalising.

- You cannot finalise discs recorded on other manufacturer's equipment.
- **-R -R DL -RW(V) +R +R DL** If you finalise discs recorded on Panasonic equipment other than this unit, the background selected as “Top Menu” may not be displayed.
- Discs finalised on this unit may not be playable on other players due to the condition of the recording.

Creating Top Menu—Create Top Menu

+RW

+RW discs contain no Top Menu data. Top Menu is a convenient function. We recommend you create the menu before playing a +RW disc on other equipment.

You cannot use the Top Menu for playing on this unit.

Make selections from “Top Menu” and “Auto-Play Select” (⇒ left) before creating top menu.

After performing steps 1–3 (⇒ 84, Common procedures)

- 1 Press [**▲**, **▼**] to select “Create Top Menu” and press [**OK**].
- 2 Press [**◀**, **▶**] to select “Yes” and press [**OK**].
- 3 Press [**◀**, **▶**] to select “Start” and press [**OK**].
Creating Top Menu starts. You cannot cancel creating. Creating Top Menu can take a few minutes.
- 4 Press [**OK**].

Note

- You can record or edit discs after creating the Top Menu. But the created menu is deleted when you record or edit disc. In such cases, create the Top Menu again by using “Create Top Menu”.

To return to the previous screen

Press [**RETURN** ⇐].

To exit the screen

Press [**EXIT**].

Changing the unit's settings

You can change the unit's settings using Setup menu.
•The settings remain intact even if you switch the unit to standby.

Common procedures

- 1 While stopped
Press [FUNCTION MENU].
- 2 Press [▲, ▼] to select "Others" and press [OK].
- 3 Press [▲, ▼] to select "Setup" and press [OK].

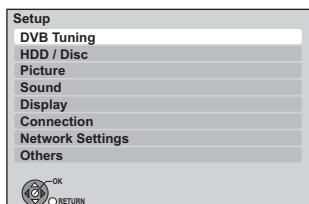

- 4 Press [▲, ▼] to select the menu and press [OK].
- 5 Press [▲, ▼] to select the item and press [OK].
- 6 Press [▲, ▼, ◀, ▶] to select the option and press [OK].
 - Follow the instruction on the screen if the operation method is different.

To return to the previous screen

Press [RETURN ↵].

To exit the screen

Press [EXIT].

DVB Tuning

■ Favourites Edit

You can create four Favourites of channels for viewing and recording easier. Editing these Favourites does not affect the channel setting itself.

- Timer recording may not work correctly if you edit the Favourites during timer recording standby.

Press the "Green" button to select the Favourite to edit.

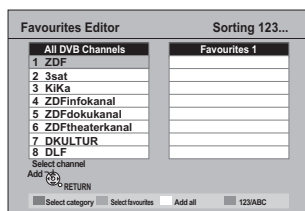

To add channels to a Favourite

- 1 Press [▲, ▼] to select the channel in the "All DVB Channels" column and press [OK].
 - Repeat this step to add other channels.
 - Press the "Red" button to select the Category.
 - Press the "Blue" button to change the sorting mode.
 - Press the "Yellow" button to add all the available channels to the Favourite. (This function is available only when no channels have been added to the Favourite.)
- 2 Press [RETURN ↵].
- 3 Press [OK] to save the Favourite.

To change the order of channels of a Favourite

- 1 Press [▶]*.
- 2 Press [▲, ▼] to select the channel in the "Favourite" column to move and press the "Green" button.
- 3 Press [▲, ▼] to select the new position of the channel and press the "Green" button.
 - Repeat the steps 2 – 3 to move other channels.
- 4 Press [RETURN ↵].
- 5 Press [OK] to save the Favourite.

To delete channels on a Favourite

- 1 Press [▶]*.
- 2 Press [▲, ▼] to select the channel in the "Favourite" column and press [OK].
 - Repeat this step to delete other channels.
 - Press the "Yellow" button to delete all the channels from the Favourite.
- 3 Press [RETURN ↵].
- 4 Press [OK] to save the Favourite.

Deleting a channel from a Favourite does not affect the channel itself. You can still select the channel from the "All DVB Channels".

To change the name of a Favourite in the "Favourite" column

- 1 Press [▶]*.
- 2 Press the "Red" button.
 - User input screen appear.
- 3 Press [▲, ▼, ◀, ▶] to select a character and press [OK]. Repeat this step to enter other characters.
 - To delete a character
Press the "Red" button.
 - To delete all characters
Press the "Blue" button.
- 4 Press [RETURN ↵] to save the Favourite.

* When the station name of the "All DVB Channels" column is highlighted

■ Channel List

You can edit the Channel List to change the channel skip setting or channel number assignments to make tuning simpler.

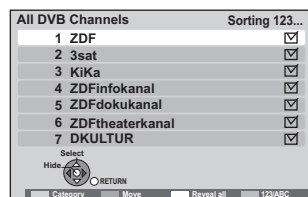

To skip unwanted channels

- 1 Press [▲, ▼] to select the channel in the "All DVB Channels".
 - Press the "Red" button to select the "Category".
 - Press the "Blue" button to change the sorting mode.
- 2 Press [OK].
 - The check mark is removed.
 - To clear the skip setting, press [OK] again.
 - To clear the all skip setting, press "Yellow" button.

To change the channel number assignment

- 1 Press [▲, ▼] to select the channel in the "All DVB Channels" and press the "Green" button.
- 2 Press [▲, ▼] to select the channel number you wish to reassign.
- 3 Press [OK].
 - If another channel is already assigned to the channel number you wish to use, the two channels will be switched.

■ Auto Setup

You can restart auto channel setting if set up (⇒ 18) fails for some reason.

Press [▲, ▼] to select the Auto Setup method.

- Search by selected satellite
Satellite is selected and transponders are searched for channels.
- Search all satellites
All satellites and transponders are searched for channels.

When the confirmation screen appears

Press [◀, ▶] to select "Yes" and press [OK].

- When restarting the auto tuning using the main unit's buttons (⇒ 114, To reset this unit)

Manual Tuning

You can add each new channels manually that the Auto Setup could not complete successfully.

- Press [▲, ▼] to select the channel you want to set.

Transponder Frequency

Enter value with numbered buttons.

Symbol Rate

Press [◀, ▶] to select the auto and manual input of symbol rate method.

- Data flow transmission rate from the satellite to the dish.

Polarisation

Press [◀, ▶] to select the Polarisation method.

- Polarisation indicates whether the transponder transmits the satellite signal horizontally or vertically.

Modulation

Press [◀, ▶] to select the Modulation method.

Service ID

Press [◀, ▶] to select the Service ID method.

- Press [OK] to start scan.
The set channel is displayed in the table.
- Press [EXIT] and press [^ v CH] to check that applicable channels have been selected.

Update Channel List

You can update the satellite digital channels to receive to the latest one.

- Press [▲, ▼] to select "Update Channel List" and press [OK].
- Press [▲, ▼] to select the method and press [◀, ▶] to select settings.

Satellite

Satellite name is displayed.

Search Mode

All Channels:

Search for all channels.

Free Channels:

Search for free channels only.

Scan Mode

Quick:

In this mode, scanning takes place in a short period of time.

Full:

In this mode, the scanning is thorough but takes more time.

- Press [OK].
The unit starts searching for newly available satellite digital channels.

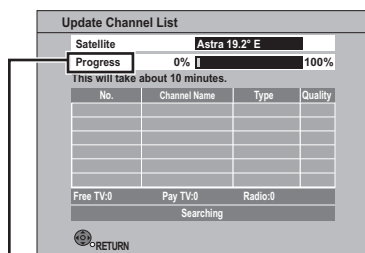

"Finished" is displayed when the search is finished.

- Press [RETURN ↵] to save the newly found channels.

Signal Condition

You can check the quality and strength of digital broadcast signals. Check the satellite dish if you are receiving a poor signal.

When "Signal Condition" is displayed in grey and cannot be selected:

- Press [EXIT] to exit the screen.
- Press [INPUT SELECT] to select "TV".
- Display the Setup menu again (⇒ 87, Common procedures).

The quality and strength of the signal are shown. Press [^ v CH] to select the channel.

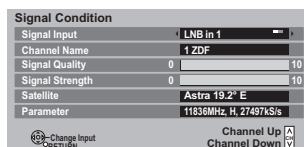

Signal Input

Press [◀, ▶] to select the terminal for which you wish to display the signal condition.

Signal Quality

- Below 2 (display red):

The signal quality is so poor that there may be interference in the pictures and sound.

- 2-5 (display orange):

The signal quality is basically adequate, but brief interference in the pictures and sound is possible in isolated case.

- Over 5 (display green):

Optimum picture and sound quality.

Signal Strength

The display for signal strength is grey. "0" means signal strength is 0%, "10" means signal strength is 100%.

If the signal is too strong, the display will change from grey to red. Reduce the signal amplification at your satellite dish.

- When the signal is weak:

– adjust the position and direction of the dish.

– check that the current digital broadcast channel is correctly broadcasting.

Satellite

Satellite name is displayed.

Parameter

Physical channel and frequency is displayed.

Antenna System

You can receive several satellites if you have DiSEqC control antenna system.

- Press [▲, ▼] to select "Antenna System".
- Press [◀, ▶] to select antenna system and press [OK].

[One LNB] Compatible with Single LNB

[MiniDiSEqC] Up to 2 LNBS can be controlled.

[DiSEqC1.0] Up to 4 LNBS can be controlled.

- This unit supports DiSEqC Version 1.0.

LNB Configuration

LNB

- If you set to "One LNB" in "Antenna System".

Not selectable.

- If you set to "MiniDiSEqC" in "Antenna System".

[AA] [AB]

- If you set to "DiSEqC1.0" in "Antenna System".

[AA] [AB] [BA] [BB]

LNB Low Band Frequency (MHz)

LNB High Band Frequency (MHz)

Satellite

Set the connected satellite for the selected LNB.

[No Satellite] [Turksat 42°E] [Hellas 39°E]

[Astra 28.2°E] [Arabsat 26°E] [Astra 23.5°E]

[Astra 19.2°E] [Eutelsat 16°E] [Hot Bird 13°E]

[Eutelsat 10°E] [Eurobird 9°E] [Eutelsat 7°E]

[Sirius 5°E] [Intelsat 1°W] [Amos 4°W]

[Atl. Bird 5°W] [Atl. Bird 7°W] [Atl. Bird 8°W]

[Hispasat 30°W] [User defined]

- If you do not know the connected satellite, select "No Satellite". (Available satellite will be searched in Auto Setup.)
- If you select "User defined", set "Test Transponder Frequency" manually.

Test Transponder Frequency

■ Preferred Language

(All factory default settings are indicated with underlined text.)

- ① Press [▲, ▼] to select the item.
- ② Press [◀, ▶] to select the language or item.

You can select up to 2 different subtitles, audio tracks and teletext to be used when multi audio, subtitles and teletext digital broadcasts are received. Select the order of priority.

If the selected language is not available, then the original language will be selected.

Multi Audio

Multi Audio (alternative)

Subtitles

Subtitles (alternative)

Teletext Character Set

[West] [East 1] [East 2]

Teletext

[English]	[German]	[French]	[Dutch]
[Spanish]	[Portuguese]	[Italian]	[Turkish]
[Danish]	[Swedish]	[Finnish]	[Norwegian]
[Polish]	[Basque]	[Catalan]	[Corsican]
[Galician]	[Czech]	[Greek]	[Luxembourgish]
[Slovak]	[Croatian]	[Slovenian]	[Estonian]
[Lithuanian]	[Original]		

- The default language is the language setting selected when making the initial settings.

Preferred Subtitle Type

[Standard]

[Hard of Hearing] Display subtitles for people who are hard of hearing.

HDD / Disc

(All factory default settings are indicated with underlined text.)

Settings for Playback

- Press [OK] to show the following settings.

Soundtrack

(When selecting this item and press [OK], the title "Soundtrack for BD-Video / DVD-Video" is displayed.)

[English]	[German]	[French]	[Italian]
[Spanish]	[Dutch]	[Swedish]	
[Original]	The original language of each disc will be selected.		

[Other * * * * *]*

- The default language is the language setting selected when making the initial settings.

Subtitles

(When selecting this item and press [OK], the title "Subtitles for BD-Video / DVD-Video" is displayed.)

[Automatic] If the language selected for "Soundtrack" is not available, subtitles of that language will automatically appear if available on that disc.

[English]	[German]	[French]	[Italian]
[Spanish]	[Dutch]	[Swedish]	

[Other * * * * *]*

Menu

(When selecting this item and press [OK], the title "Menu for BD-Video / DVD-Video" is displayed.)

[English]	[German]	[French]	[Italian]
[Spanish]	[Dutch]	[Swedish]	

[Other * * * * *]*

- The default language is the language setting selected when making the initial settings.

Play Video (AVCHD) on BD-RE / BD-R

Set when you are playing a disc that has high definition video (AVCHD) recorded by the Panasonic's video camera, etc. and high definition quality title that was recorded on this unit.

- It can be played regardless of the setting for discs that do not have both recorded.

[On] Playback high definition video (AVCHD)

[Off] Playback high definition quality title

BD-Live

You can restrict Internet access when BD-Live functions are used.

[On (No Limit)] Internet access is permitted for all BD-Live contents.

[On (Limit)] Internet access is permitted only for BD-Live contents which have content owner certificates.
Internet access is prohibited for all BD-Live contents without a certificate.

[Off] Internet access is prohibited for all BD-Live contents.

BD-Video Ratings

Set a ratings level to limit BD-Video play.

Follow the on-screen instructions. Enter a 4-digit PIN with the numbered buttons when the PIN screen is shown.

It will be the common PIN for "DVD-Video Ratings", "BD-Video Ratings" and "Lock" of "Internet Content Settings".

Do not forget your PIN.

Setting ratings (When no limit is selected)

[No Limit] All BD-Video can be played.

[0 to 254 year(s)] Prohibits play of BD-Video with corresponding ratings recorded on them.

- Changing settings [When 0 to 254 year(s) is selected]

[Unlock Recorder]

[Change Level]

[Temporary Unlock]

DVD-Video Ratings

(When selecting this item and press [OK], the title "Ratings" is displayed.)

Set a ratings level to limit DVD-Video play.

Follow the on-screen instructions. Enter a 4-digit PIN with the numbered buttons when the PIN screen is shown. It will be the common PIN for "DVD-Video Ratings", "BD-Video Ratings" and "Lock" of "Internet Content Settings".

Do not forget your PIN.

Setting ratings (When level 8 is selected)

[8 No Limit] All DVD-Video can be played.

[1 to 7] Prohibits play of DVD-Video with corresponding ratings recorded on them.

[0 Lock All] Prohibits play of all DVD-Video.

- Changing settings (When level 0 to 7 is selected)

[Unlock Recorder]

[Change Level]

[Temporary Unlock]

DivX Subtitle Text

Select a suitable item according to the language used for DivX subtitles text (⇒ 45).

- This item is displayed only when pressing [DISPLAY] after playing back a file.

[Latin 1] English, German, Spanish, etc.

[Latin 2] Polish, Czech, Hungarian, etc.

[Cyrillic] Russian, etc.

* [Other * * * * *]

Enter a code (⇒ 104) with the numbered buttons.

When the selected language is not available on the disc, the default language is played. There are discs where you can only switch the language from the menu screen (⇒ 21).

BD-V DVD-V

Choose the language for audio, subtitle and disc menus.

- Some discs start in a certain language despite any changes you make here.

Settings for Recording

- Press [OK] to show the following settings.

Recording time in EP mode

Select the maximum number of hours for recording in EP mode (⇒ 30, Recording modes and approximate recording times).

[6 hours]	You can record for 6 hours on an unused 4.7 GB disc.
[8 hours]	You can record for 8 hours on an unused 4.7 GB disc.

- The sound quality is better when using "6 hours" than when using "8 hours".

Aspect for Recording

Sets the aspect ratio when recording or copying in HG, HX, HE, HL, XP, SP, LP, EP, FR mode.

[Automatic] The title will be recorded with the original aspect ratio at the time when recording started (including when recording started at a commercial, etc.).

[16:9]

[4:3]

- In the following cases, the programme will be recorded with the original aspect ratio.
 - **BD-RE** **BD-R** When the recording mode is set to "XP", "SP", "LP", "EP" or "FR"
 - **HDD** **RAM** When the recording mode is set to "XP", "SP", "LP", "EP" or "FR" with the "Rec for High Speed Copy" set to "Off"
- In the following cases, even when set to "Automatic" or "16:9", recordings will be made or copied in 4:3.
 - **R** **R DL** **RW(V)** When the recording mode is set to "EP" or "FR (recordings 5 hours or longer)" mode.
 - When recording to a +R, +R DL and +RW.

Chapter Creation

Set the automatic Chapter Creation method. (⇒ 51)

[Automatic]	[5 minutes]
[Off]	No chapter start points are set.

Rec for High Speed Copy

You can copy titles recorded in XP, SP, LP, EP or FR mode from the HDD to DVD-R, DVD-R DL, DVD-RW (DVD-Video format), +R, +R DL and +RW using high speed mode. However, screen size, etc. is restricted (⇒ below).

We recommend turning the setting "Off" if high speed copy to DVD-R, etc. is not necessary when recording a programme.

This setting is valid for the following cases:

- Recording from an external equipment (including DV equipment)
- Copying from a finalised DVD-Video disc.

[On]	You can high-speed copy to DVD-R, etc. Press [◀, ▶] to select "Yes" and press [OK]. <ul style="list-style-type: none"> • The following restrictions are applied to recorded titles. <ul style="list-style-type: none"> – Recordings are made using the aspect ratio set in "Aspect for Recording" (⇒ above). – Select the type of audio in advance from "Bilingual Audio Selection" (⇒ 91). – You are no longer able to switch the audio when watching a programme on an input channel on the TV connected to this unit.
[Off]	

Note

Titles recorded in XP, SP, LP, EP, FR mode on HDD cannot be copied to BD-RE or BD-R using high speed mode, regardless of the above setting.

BD / DVD Speed for High Speed Copy

(When selecting this item and press [OK], the title "Blu-ray Disc / DVD Speed for High Speed Copy" is displayed.)

Select the speed of high-speed copying (When using high-speed copy compatible discs).

[Maximum]

[Normal (Silent)] The noise generated by this unit is less than when "Maximum" is selected, however the time required for copying will double (approximately).

Start Recording Time

This function sets the timer recording to start earlier than the TV Guide time.

[1 min earlier]	[3 min earlier]	[5 min earlier]
[10 min earlier]	[Off]	

Finish Recording Time

This function sets the timer recording to stop later than the TV Guide time.

[1 min later]	[3 min later]	[5 min later]
[10 min later]	[Off]	

HDD Management

- Press and hold [OK] for 3 seconds to show the following settings.

Delete all titles

Delete all titles.

- Delete does not work if one or more titles are protected.

Format HDD

Format of the HDD is performed.

Formatting deletes all contents, and they cannot be restored. Check carefully before proceeding.

Picture

(All factory default settings are indicated with underlined text.)

Still Mode

Select the type of picture shown when you pause play (⇒ 118, Frames and fields).

[Automatic]

[Field] Select if jittering occurs when "Automatic" is selected. (The picture is coarser.)

[Frame] Select if small text or fine patterns cannot be seen clearly when "Automatic" is selected. (The picture is clearer and finer.)

Seamless Play

Select the play mode between playlist chapter segments and partially deleted titles.

- It is not valid for titles in DR mode or AVCHD videos.

[On] The chapters in playlists are played seamlessly. This does not work when there are several audio types included on the playlist and when using Quick View (PLAY × 1.3). Additionally, the positioning of chapter segments may change slightly.

[Off] The points where chapters in playlists change are played accurately, but the picture may freeze for a moment.

NTSC Video Output

Select how the NTSC image is output.

[NTSC] Output as NTSC.

[PAL60] Convert and output as PAL60. Select this when connected to the PAL format TV.

Sound

(All factory default settings are indicated with underlined text.)

Dynamic Range Compression

BD-V **DVD-V**

Change the dynamic range for late night viewing.

[On] [Off] [Automatic]

Downmix

Switch the downmix system for playing back multi-channel surround sound.

- When "Dolby D/Dolby D +/Dolby TrueHD", "DTS/DTS-HD" or "MPEG" is set to "Bitstream", there are no downmix effects for the audio output.
- The audio output will be in "Stereo" in the following cases.
 - AVCHD playback
 - **BD-V**: Playback of clicking sound on the menu and audio with secondary video in picture-in-picture mode

[Stereo] When connected to equipment that does not support the virtual surround function.

[Surround encoded] When connected to equipment that supports the virtual surround function

Bilingual Audio Selection

(Only when recording from DV input)

Select whether to record the main or secondary audio type when:

- Copying to a DVD-R, DVD-RW (DVD-Video format), +R and +RW.
- "Rec for High Speed Copy" is enabled. (⇒ 90)
- Recording sound in LPCM (⇒ 92, "Audio Mode for XP Recording").

[M 1] [M 2]

- You cannot select the audio on this unit when recording from an external source, such as when copying from a video cassette recorder (except from DV equipment connected to this unit's DV input terminal). Select the audio on the other equipment.
- When recording from the unit's DV terminal, select the type of audio recording from "Audio Mode for DV Input" (⇒ 92).

Digital Audio Output

- Press [OK] to show the following settings.

PCM Down Conversion

Select how to output audio with a sampling frequency of 96 kHz. It will be converted to 48 kHz regardless of the setting in following cases.

- The signals have a sampling frequency of over 96 kHz.
- The disc has copy protection.
- "BD-Video Secondary Audio" is set to "On". (**BD-V**)

[On] Signals are converted to 48 kHz. (Choose when the connected equipment cannot process signals with a sampling frequency of 96 kHz.)

[Off] Signals are output as 96 kHz. (Choose when the connected equipment can process signals with a sampling frequency of 96 kHz.)

Dolby D/Dolby D +/Dolby TrueHD*¹

DTS/DTS-HD*²

MPEG*¹

Select to output Dolby Digital, Dolby Digital Plus, Dolby TrueHD, DTS Digital Surround, DTS-HD High Resolution Audio, DTS-HD Master Audio or MPEG as bitstream or PCM.

Note

- Not making the proper settings may result in noise.
- If the unit is connected with the HDMI AV OUT terminal, the specifications of the connected equipment take preference over this unit and audio selected in these items may not be output (e.g., when a television is connected, the HDMI audio output of this unit is limited to down-mixed 2ch.)

[Bitstream] Select "Bitstream" when the connected equipment can decode the respective audio format.

- Connect equipment supporting HDMI Ver. 1.3a (High Bit Rate Audio) and use a High Speed HDMI Cable in order to output High Bit Rate Audio such as Dolby Digital Plus, Dolby TrueHD, DTS-HD High Resolution Audio or DTS-HD Master Audio.

[PCM] Select "PCM" when the connected equipment cannot decode the respective audio format.

Refer to the operating instructions for connected devices to verify whether or not they can decode each of the audio formats.
Set the speaker output on the amplifier when output with PCM.

BD-Video Secondary Audio

(**BD-V** with secondary audio)

Turn on/off the clicking sound on the menu and audio with secondary video.

[On] The sampling frequency is converted to 48 kHz. Audio will be converted to Dolby Digital or DTS during playback of the BD-Video with secondary audio when "Bitstream" (⇒ above) is selected.

[Off] Output in original audio method.

*¹ The default setting is "PCM".

*² The default setting is "Bitstream".

Audio Mode for XP Recording

Choose the audio type when recording or copying with XP mode.

[Dolby Digital] (⇒ 118) [LPCM] (⇒ 119)

- The picture quality of LPCM recordings may be lower than that of normal XP mode recordings.
- The audio recording becomes Dolby Digital even if you selected LPCM when using a recording mode other than XP.
- When recording a bilingual broadcast, select the type of audio in advance from "Bilingual Audio Selection" (⇒ 91).

Audio Mode for DV Input

You can select the kind of audio when recording from the unit's DV input terminal (⇒ 60).

[Stereo 1] Records audio (L1, R1).

[Stereo 2] Records added audio such as narration (L2, R2) subsequent to original recording.

[Mix] Records both Stereo 1 and Stereo 2.

- When recording bilingual broadcast, select the type of audio in advance from "Bilingual Audio Selection" (⇒ 91).

Audio Channels for HG / HX / HE / HL Recording

This will set the audio when copying DR mode titles to BD-RE or BD-R disc in "HG", "HX", "HE", or "HL" mode, or converting the recording mode to "HG", "HX", "HE", or "HL" mode (⇒ 50).

[5.1-channel]* Record using 5.1 ch audio

[2-channel] Record using 2 ch audio.

- * If the audio sampling frequency is not 48 kHz, surround audio is mixed and recorded in front LR channels. Audio will be output from two front speakers only, even if you play it on 5.1 ch speaker connection.

Display

(All factory default settings are indicated with underlined text.)

Language

Choose the language for these menus and on-screen messages.

[Deutsch] [English] [Français] [Italiano]

- The default language is the language setting selected when making the initial settings.

On-Screen Messages

Choose the approximate time until the digital channel information screen (⇒ 27) disappears automatically. The length of time the Control Panel (⇒ 77) is displayed can also be changed, but "Off" does not work.

[Off] (The digital channel information is not displayed.)

[3 sec.] [5 sec.] [7 sec.] [10 sec.]

Unit's Display

Changes the brightness of the unit's display. This setting is fixed with "Automatic" if you set "Power Save" (⇒ 95) to "On".

[Bright] [Dim]

[Automatic] The display turns dark during play and disappears when the unit is turned off. It reappears momentarily if a button is pressed. While using this mode, the standby power consumption can be reduced.

Screen Saver

This is to prevent burn-in on the screen.

- When this is set to "On", the masked-off area on the screen becomes grey.

[Only when connecting with an HDMI cable or a component video cable and "HDMI Video Format" (⇒ 93) is set to any other mode than "576p/480p", or "Component Resolution" (⇒ 94) is set to "720p" or "1080i"]

- [On] If there is no operation for a while or more, the displayed screen switches to the other states automatically.
- When the DIRECT NAVIGATOR, TV Guide, Timer recording list, Copying list or FUNCTION MENU, etc. is displayed, the screen saver is not displayed.
 - When Music is played, the display returns to the screen saver mode. (Playback continues.)
 - When still pictures are shown (except for slideshows), the display returns to the Picture View screen.
 - The display returns to the screen saver mode when it is paused by the Pause Live TV. (Pause status will continue.)

[Off]

Teletext

Select the Teletext display mode. (⇒ 28)

[TOP (FLOF)] When switching Teletext display mode to either TOP mode or FLOF (FASTTEXT) mode.

[List] When switching Teletext display mode to List mode.

Blue LED

Set the lighting method for the lamp on the SD card slot.

[On]

[SD inserted] When this unit is turned on and SD card is inserted, the lamp is lighted.

[Off]

Connection

(All factory default settings are indicated with underlined text.) Depending on the connected equipment, some items may be shaded in grey on the display and cannot be selected, or you may not be able to change the settings.

TV Aspect

Set to match the type of television connected.

[16:9] When connected to a 16:9 widescreen television.

[Pan & Scan] When connected to a 4:3 aspect television, side picture is trimmed for 16:9 picture. This setting may not work and the pictures may be shown in the letterbox style depending on the content.



[Letterbox] When connected to a 4:3 aspect television, 16:9 picture is shown in the letterbox style.



Aspect for 4:3 Video

To play a 4:3 title, set how to show pictures on a 16:9 widescreen television.

[4:3] Picture output expands left or right.

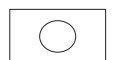

[16:9] Picture is output as original aspect with side panels.



TV System

Change the setting to match the equipment you are connecting with, or to match the title when there are both PAL and NTSC titles on the HDD, BD-RE or BD-R.

- [PAL]
- Select when connecting to a PAL or Multi-system television.
 - Select to record television programmes and PAL input from other equipment.
 - Select when playing a PAL input title recorded on the HDD, BD-RE or BD-R.

- [NTSC]
- Select when connecting to a NTSC television. Television programmes cannot be recorded properly.
 - Select to record NTSC input from other equipment.
 - Select when playing a NTSC input title recorded on the HDD, BD-RE or BD-R.

Note

- This unit cannot record NTSC signals to discs that already have PAL signal recordings. (However, both types of programmes can be recorded onto the HDD, BD-RE or BD-R.)
- If "NTSC" has been selected, the TV Guide system cannot be used.
- A disc or title with different "TV System" may not be able to playback while recording or on standby for the timer recording. You will be able to playback by changing the "TV System" settings in that case, but to prevent failure of the timer recording, change back the settings before the recording starts.

To change the setting all at once (PAL↔NTSC)

While stopped, keep pressing [■] and [▲ OPEN/CLOSE] on the main unit at the same time for 5 or more seconds.

■ Types of disc or title recorded on HDD, BD-RE or BD-R for the type of connected TV

When you use the discs recorded either PAL or NTSC, or playback a title recorded on HDD, BD-RE or BD-R using PAL or NTSC, refer to this table.

(○: Possible to view, -: Impossible to view)

TV type	Disc/Titles recorded on HDD, BD-RE or BD-R	Yes/No
Multi-system TV	PAL	○
	NTSC	○
PAL TV	PAL	○
	NTSC	○*1 (PAL60)
NTSC TV	PAL	-
	NTSC	○*2

*1 Select "PAL60" for "NTSC Video Output" in the Setup menu (⇒ 90). If your television is not equipped to handle PAL 525/60 signals the picture will not be shown correctly.

*2 Select "NTSC" in "TV System".

- When playing back a title recorded on the HDD, BD-RE or BD-R, ensure that you match the "TV System" setting to the title (PAL or NTSC).

HDMI Connection

- Press [OK] to show the following settings.

HDMI Video Mode

Select "On" when video is output from HDMI AV OUT terminal.

[On]

- [Off] When the equipment such as amplifiers is connected using HDMI cable, and TV is connected to the COMPONENT VIDEO OUT terminal (setup before connecting to the amplifiers.)

HDMI Video Format

You can only select items compatible with the connected equipment. This setting normally does not need to be changed. However if you are concerned about output picture quality, it may be improved by changing the setting.

- To enjoy High Quality Video up-converted to 1080p, you need to connect the unit directly to 1080p compatible HDTV. If this unit is connected to an HDTV through other equipment, it must also be 1080p compatible.

[576p/480p]

[720p] All images other than 720p will be output as 1080i.

[1080i]

[1080p] When outputting 1080p signal, we recommend using High Speed HDMI Cables that have the HDMI logo (as shown on the cover) and are less than 5.0 meters to prevent video distortion etc.

[Automatic] Automatically selects the output resolution best suited to the connected television (1080p, 1080i, 720p or 576p/480p).

- Press and hold [■] and [▶] (PLAY) for more than 5 seconds when the image is disturbed by changing the setting. It will be set to "576p/480p".

BD-Video 24p Output

When playing BD-Video recorded in 24 frames, this unit displays each frame at 1/24 second intervals—the same interval originally shot with the film movie.

- This item is effective only when the unit is connected to a TV with an HDMI terminal that supports 1080/24p input.

[On]

- Images in 24p are output in 24p as they are. (Only when the "HDMI Video Format" is "Automatic" or "1080p")
However,
– when video is being output at 24 frames, images from any other terminal than the HDMI terminal may not be output properly.
– when images other than 24p are played, images are output at 60p.

[Off]

HDMI Audio Output

[On]

- [Off] When connected to TV with HDMI cable, and connected to amplifiers not compatible to HDMI with a DIGITAL AUDIO OUT terminal

7.1ch Audio Reformating **BD-V**

[Automatic] Surround audio of less than 7.1 ch will be output as 7.1 ch automatically.

"Automatic" is enabled in the following cases:

- When the connected device supports 7.1 channel surround audio
- "Dolby D/Dolby D +/Dolby TrueHD" in the Setup menu (⇒ 91) is set to "PCM"
- When the audio is Dolby Digital, Dolby Digital Plus, Dolby TrueHD or LPCM

[Off]

It is output via the original channels. However, surround audio of DTS and DTS-HD will be output as 7.1 ch automatically.

VIERA Link

Set to use "HDAVI Control" function when connected with an HDMI cable to a device that supports "HDAVI Control".

[On]

- [Off] Select when you do not want to use "HDAVI Control".

Component Resolution

This sets the video output resolution when using the component video terminal.

[576i/480i] [576p/480p] [720p] [1080i]

- You cannot change the setting while the "HDMI Video Mode" is set to "On". Set the "HDMI Video Mode" to "Off" and set the "AV1 Output" to "Video (with component)" or "S Video (with component)".
- If it is set to "720p", images other than "720p" will be output as "1080i".
- The video output resolution will be restricted to "576p/480p" even if you select "720p" or "1080i" when viewing or recording the following images:
 - Some programmes in the HD format
 - DVD-Video discs
 - DivX
 - BD-Video discs recorded at a rate of 50 field per second
 - Images input via AV1, AV2 or DV input
- Press the [■] and [▶] (PLAY) for more than 5 seconds when the image is disturbed by changing the setting. It will be set to "576i/480i".

AV1 Output

Set according to the terminal of the connected TV. Select "Video (with component)" or "S Video (with component)" for component output (progressive output). If this unit is connected with an HDMI cable, you cannot select "RGB 1 (without component)" or "RGB 2 (without component)". When a decoder is connected, do not set to "RGB 1 (without component)".

[Video (with component)]

Select when a TV is connected that can receive a composite signal.

[S Video (with component)]

Select when a TV is connected that can receive an S Video signal.

[RGB 1 (without component)]

Select when a TV is connected that can receive an RGB signal. If you always would like to view the picture from the unit in RGB signal, select this mode. The TV screen will automatically switch to display the picture from the unit when the unit is turned on.

[RGB 2 (without component)]

Select when a TV is connected that can receive an RGB signal. If you would like to switch to display the picture from the unit only when playback or viewing menus, select this mode.

AV2 Settings

Set to match the connected equipment.
 • Press [OK] to show the following settings.

AV2 Input

Set to "RGB / Video" or "RGB" when receiving or recording RGB output from external equipment.

[RGB / Video] [RGB] [Video] [S Video]

Ext Link

This setting cannot be made when the "TV System" is set to "NTSC" (⇒ 93).

[Ext Link 1] When a Set Top Box etc. which transmits a special control signal recordings via the 21-pin Scart cable is connected. Start and stop timings of recording are controlled by the control signal.

[Ext Link 2] When external equipment with a timer function is connected. When it turns on, recording starts. When it turns off, recording stops.

Common Interface

Access to software contained on Common Interface (CI) modules. (⇒ 16, 19) Follow the on-screen instructions.

Network Settings

(All factory default settings are indicated with underlined text.)

IP Address / DNS Settings (⇒ 96)

- Press [OK] to show the following settings.

Connection Test

IP Address Auto-assignment

[On] [Off]

IP Address

Subnet Mask

Gateway Address

DNS-IP Auto-assignment

[On] [Off]

Primary DNS

Secondary DNS

Connection Speed Auto-configure

[On] [Off]

Connection Speed Setting

This is enabled only when "Connection Speed Auto-configure" is turned "Off".

[10BASE half duplex] [10BASE full duplex]
 [100BASE half duplex] [100BASE full duplex]

Proxy Server Settings (⇒ 97)

- Press [OK] to show the following settings.

Initialize

Set the setting of the "Proxy Server Settings" back.

Proxy Address

(The initial setting is blank.)

Proxy Port Number

(The initial setting is "0".)

Connection Test

Internet Content Settings (⇒ 97)

- Press [OK] to show the following settings.

Lock

You can restrict using VIERA CAST. Follow the on-screen instructions. Enter a 4-digit PIN with the numbered buttons when the PIN setting screen is shown. It will be the common PIN for "DVD-Video Ratings", "BD-Video Ratings", and "Lock".

Do not forget your PIN.

[On] [Off]

Automatic Volume Control

[On]

[Off] Select "Off" when the audio is warped while using VIERA CAST.

Home Network (DLNA) Settings (⇒ 97)

You will be able to access this unit from Panasonic DLNA compatible equipment on the network by registering them to this unit. It is also possible to change the name of this unit on the network.

Server (DLNA) Settings (⇒ 97)

By allowing access from non-Panasonic DLNA compatible equipment on the network, it allows them to access this unit.

Others

(All factory default settings are indicated with underlined text.)

Automatic Standby

Select how long the unit remains on when it is not being used.

[2 hours] [4 hours] [6 hours] [Off]

Remote Control

Change the remote control code on the main unit and the remote control (the two must match) if you place other Panasonic products close together.

[BD 1] [BD 2] [BD 3]

Use "BD 1", the factory set code, under normal circumstances.

- Press [**▲**, **▼**] to select the code ("BD 1", "BD 2" or "BD 3") and press [OK].

To change the code on the remote control

- While pressing [OK], press and hold the numbered button ([1], [2] or [3]) for more than 5 seconds.
- Press [OK].

■ When the following indicator appears on the unit's display



The unit's remote control code

Change the code on the remote control to match the main unit's (⇒ step ②).

Note

Executing "Shipping Condition" in the Setup menu returns the main unit code to "BD 1". Change the remote control code to 1 (⇒ step ②).

Clock

This unit usually obtains time and date information from digital broadcasts and automatically corrects the time several times a day. However, if the time is not set correctly, use the settings listed in the method below.

- Press [**▲**, **▼**] to select "Off" of "Automatic" and press [OK].

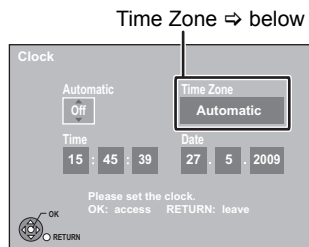

When you select "Off"

- Press [**◀**, **▶**] to select the item you want to change.
The items change as follows:
Hour ↔ Minute ↔ Second ↔ Day ↔ Month ↔ Year
- Press [**▲**, **▼**] to change the setting.
- Press [OK] when you have finished the settings.
The clock starts.

■ To change the Time Zone

When the time is not correct, set "Time Zone" (GMT -6 to + 6).

- Press [**▲**, **▼**] to select "On" of "Automatic" and press [OK] in step ①.
Auto clock setting starts. This takes a few minutes.
"Automatic clock setting completed." screen is displayed.
- Press [**▶**].
- Press [**▲**, **▼**] to select the correct time zone and press [OK].
- Press [RETURN ↵].

PIN Entry

This PIN will be used for following controlling

- BD-Video playback
- DVD-Video playback
- Using VIERA CAST

● Make a note of PIN in case you forget it.

- Press [**▲**, **▼**] to select the number, then press [**▶**].
● You can also use the numbered buttons.
- Repeat step ① for enter 4-digit PIN.
- Press [OK] to confirm.



Power Save

[On] Power consumption is minimized when the unit is turned to standby (⇒ 115).

[Off] It is possible to start quickly from standby mode.

- "Unit's Display" (⇒ 92) is fixed with "Automatic" when "Power Save" is set to "On", and is changed to "Bright" when "Power Save" is set to "Off".
- This function cannot be enabled when the DLNA function is enabled in "Home Network (DLNA) Settings" or "Server (DLNA) Settings". (⇒ 94)

System Update (⇒ 98)

In order to update this unit's software (firmware) and to support system changes made by broadcasts, this unit periodically performs software (firmware) updates.
Press [OK] to show the following settings.

Software Update in Standby

[0:00 to 23:00]* When you set this unit to standby mode, software (firmware) updates and TV Guide data are downloaded automatically at the specified time.

[Off]

* Default setting is "3:00".

Software Licence

Information about the software licence is displayed.

DivX Registration

You need this registration code to purchase and play DivX Video-on-Demand (VOD) content (⇒ 45).

Initialize

- Press [OK] to show the following settings.

Shipping Condition

All the settings except for the ratings level and ratings PIN return to the factory preset. The timer recording programmes are also cancelled.

[Yes] [No]

Default Settings

All the settings other than the tuning settings, clock settings, language settings, disc language settings, ratings level, ratings PIN, remote control code, network settings etc. return to the factory presets.

[Yes] [No]

Network Settings

These settings are used if you will connect this unit to a network. The connection to the Internet may take time or the internet may not be connected depending on the connection environment. It is recommended that you use a broadband connection.

Preparation

Connect to the network. (⇒ 103)

■ Testing the connection

Always test the connection when a LAN cable is connected or when new "IP Address / DNS Settings" have been made.

- 1 Press [FUNCTION MENU].
- 2 Press [▲, ▼] to select "Others" and press [OK].
- 3 Press [▲, ▼] to select "Setup" and press [OK].
- 4 Press [▲, ▼] to select "Network Settings" and press [OK].
- 5 Press [▲, ▼] to select "IP Address / DNS Settings" and press [OK].

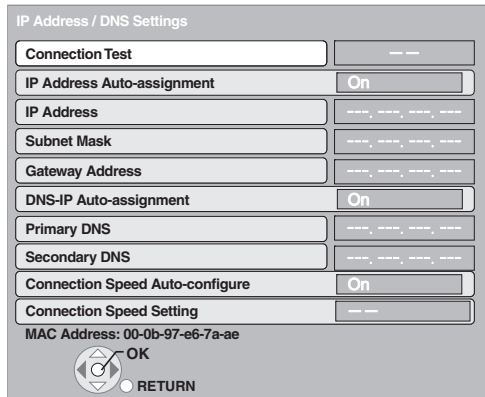

- 6 Press [▲, ▼] to select "Connection Test" and press [OK].

"Testing": The test is in progress.

"OK": The connection is completed.

"Failed": Please check the connection and settings.

Note

- Perform the "Connection Test" also when any change was made to the "IP Address / DNS Settings".

- If the connection test fails, it may be necessary to set the MAC address of this unit at the router side. The MAC address can be displayed by selecting "Network Settings" and "IP Address / DNS Settings" in steps 1–5 (⇒ above).

■ Setting the IP address

In most cases, default settings can normally be used without making any changes.

Set the IP address only when the router has no DHCP server functions or when the router's DHCP server function is disabled.

After performing steps 1–5 (⇒ left)

- 6 Press [▲, ▼] to select "IP Address Auto-assignment" and press [◀, ▶] to select "Off".
- 7 Press [▲, ▼] to select "IP Address", "Subnet Mask" or "Gateway Address" and press [OK].
- 8 Enter numbers with the numbered buttons and press [OK].
 - After checking the specifications for your broadband router, enter each number.
 - If the number is unknown, then check the number of other devices such as personal computers connected via a LAN cable. Assign a different number from those of other devices for the "IP Address" and the same number for others.
 - If a wrong number is entered, then press [DEL].

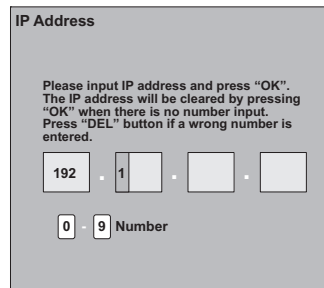

- 9 Press [◀, ▶] to select "Yes" and press [OK].

Note

- The numeric input range is between 0 and 255.

■ Setting the DNS-IP

In most cases, default settings can normally be used without making any changes.

When setting an assigned DNS server from your internet service provider, perform the following settings.

After performing steps 1–5 (⇒ left)

- 6 Press [▲, ▼] to select "DNS-IP Auto-assignment" and press [◀, ▶] to select "Off".
- 7 Press [▲, ▼] to select "Primary DNS" or "Secondary DNS" and press [OK].
- 8 Enter numbers with the numbered buttons and press [OK].
 - Follow the instructions given by your internet service provider and enter the numbers.
 - If the number is unknown, then check the number of other devices such as personal computers connected via a LAN cable and assign the same number.
 - If a wrong number is entered, then press [DEL].

- 9 Press [◀, ▶] to select "Yes" and press [OK].

Note

- The numeric input range is between 0 and 255.

■ Setting the connection speed

When the connection test results in "Failed" after the IP and DNS-IP addresses are assigned, perform the following settings.

After performing steps 1–5 (⇒ left)

- 6 Press [▲, ▼] to select "Connection Speed Auto-configure" and press [◀, ▶] to select "Off".
- 7 Press [▲, ▼] to select "Connection Speed Setting" and press [◀, ▶] to select a connection speed.
 - Select a connection speed in accordance with the environment of the network connected.
 - When the settings are changed, the network connection may be disabled depending on the device.

■ Setting the proxy server

In most cases, default settings can normally be used without making any changes.

Please use this setting when instructed to by your Internet service provider.

- Set the proxy server only after the connection test is completed properly.

After performing steps 1–4 (⇒ 96, Testing the connection)

- 5 Press **[▲, ▼]** to select “Proxy Server Settings” and press **[OK]**.

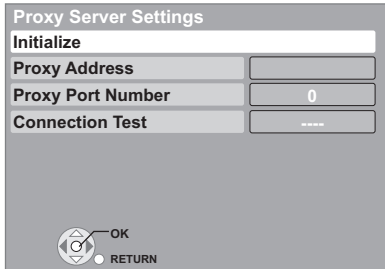

- 6 Press **[▲, ▼]** to select “Connection Test” and press **[OK]**.

“Testing”: The test is in progress.
 “OK”: The connection is completed.
 Press **[RETURN ↵]** to exit.
 “Failed”: Please check the connection and settings.

- 7 Press **[▲, ▼]** to select “Proxy Address” and press **[OK]**.

(⇒ 80, Entering text)

After the input of “Proxy Address” is completed

- 8 Press **[▲, ▼]** to select “Proxy Port Number” and press **[OK]**.

- 9 Enter numbers with the numbered buttons and press **[OK]**.

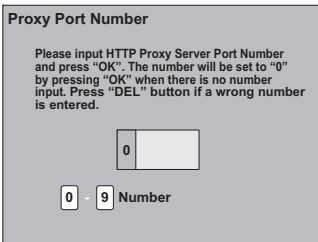

- 10 Press **[◀, ▶]** to select “Yes” and press **[OK]**.

To set back to default setting

After performing step 5 (⇒ above)

- ① Press **[▲, ▼]** to select “Initialize” and press **[OK]**.
- ② Press **[◀, ▶]** to select “Yes” and press **[OK]**.

■ Setting the internet content (VIERA CAST)

After performing steps 1–4 (⇒ 96, Testing the connection)

- 5 Press **[▲, ▼]** to select “Internet Content Settings” and press **[OK]**.

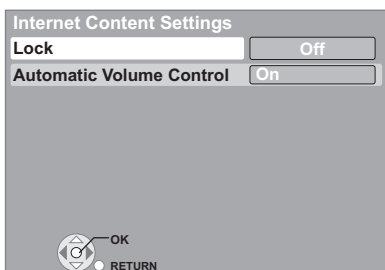

- Lock (⇒ 94)
- Automatic Volume Control
 Select “On”, the volume is controlled by this unit automatically. If you want to enjoy the original volume, set it to “Off”.

■ Register the DLNA compatible equipment to this unit

After performing steps 1–4 (⇒ 96, Testing the connection)

- When connecting Panasonic DLNA compatible equipment

- 5 Select “Home Network (DLNA) Settings” and press **[OK]**.

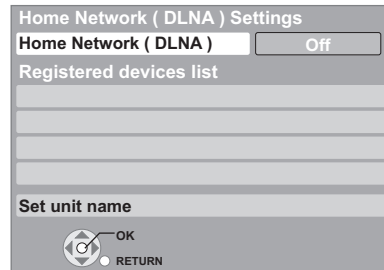

- 6 Select “On” and press **[OK]**.

- 7 Select “Yes” and press **[OK]**.

Access this unit from the connected DLNA compatible equipment within 10 minutes.

- Up to 4 devices can be registered.

- Even if it is Panasonic DLNA compatible equipment, you may not be able to register from “Home Network (DLNA) Settings”. In such a case, register the equipment from “Server (DLNA) Settings” (⇒ below)

- When connecting non-Panasonic DLNA compatible equipment

- 5 Select “Server (DLNA) Settings” and press **[OK]**.

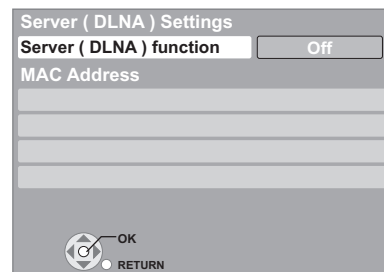

- Up to 4 devices can be registered.

- 6 Select the MAC Address for the connected equipment and press **[OK]**.

- Up to 12 devices can display the MAC Address.

- 7 Select “Yes” and press **[OK]**.

■ Viewing video in this unit via the registered equipment (⇒ 79, DLNA feature)

You cannot operate the unit until the update is complete. Removing the AC mains lead while the update is in progress may damage the unit. Don't remove the AC mains lead during the update.

Update software (firmware) of this unit

Software (firmware) of this unit can be updated automatically by following method.

- From broadcasts
- From Internet [network connection and setting is required. (⇒ 96, 103)]

Update of the software (firmware) is done when it is in standby mode.

Once the new software (firmware) is found, it will start the download of the software (firmware), and then the upload.

Download of the software (firmware) will start automatically when the power of this unit is turned off or when the set time comes (⇒ 95)

- The time it takes to update depends on the connection.
 - For Broadcast: About 2 to 4 hours
 - For Internet: About 1 hour
 (It may take longer than specified above to download because the download time differs depending on the network environment. It is recommended to be used in a broadband environment.)

Time to start the download of the software (firmware) can be set arbitrarily. If you do not want to perform the software (firmware) update during the standby mode, set the "Software Update in Standby" in the Setup menu to "Off". (⇒ 95)

■ The unit's display during the update

e.g.,



- **"SW-DL"** : Software (firmware) is downloading. Download will stop when the power is turned on, or the timer recording starts.
- **"START"** : Update of the software (firmware) will start once the download is completed.
- **"UPD □/□"** : Software (firmware) is updating.
- **"FINISH"** : Updated of the software (firmware) has completed.

Note

- If the timer recording is scheduled within the following time at the start of the download, the download will not be executed.
 - For broadcast: Within 4 hours
 - For Internet: Within 1 hour
- If downloading on this unit fails or this unit is not connected to the Internet, then you can download the latest software (firmware) from the following website and burn it to a CD-R to update the software (firmware).
<http://panasonic.jp/support/global/cs/>

CI Plus compatible CAM (Conditional Access Module) software (firmware) update

- Software (firmware) of CAM (compatible CI Plus) can be updated automatically from broadcasts.
- Availability of software (firmware) update is detected while viewing the programmes compatible with CI Plus.

Notification is displayed on the screen if available.

- Notice is not displayed in the following cases:
 - When recording a programme
 - When scheduled recording and update occur simultaneously
 - When displaying FUNCTION MENU, DIRECT NAVIGATOR, etc.

Follow the on-screen instructions when updating.

■ The unit's display during the update

e.g.,



- If you did not update or if the notice for update did not display on the screen, you will be notified on the Digital Channel Information of the channel where the update for CAM was detected.

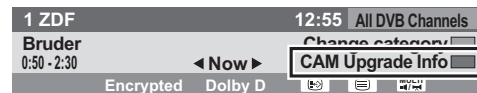

To perform an update, press the "Red" button and follow the on-screen instructions.

Note

- Operations such as view, playback, or record cannot be performed while updating the CAM. If you press the [⏏] on the remote control while updating the CAM, the power of this unit will turn off automatically after the update.
- For details, refer to your CAM's operating instructions or consult your dealer.

Television operation

You can configure the remote control TV operation buttons to turn the television on/off, change the television input mode, select the television channel and change the television volume.

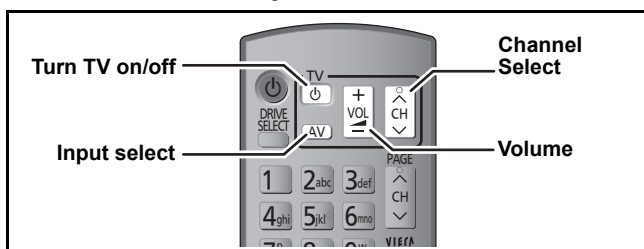

1 Point the remote control at the television
While pressing [TV], enter the code with the numbered buttons.

e.g., 01: [0] ⇒ [1] 10: [1] ⇒ [0]

Manufacturer and Code No.

Brand	Code	Brand	Code
Panasonic	01/02/03/04	METZ	05/28
AIWA	35	MITSUBISHI	05/19/20/47
AKAI	27/30	MIVAR	24
BEJING	33	NEC	36
BEKO	05/71/72/73/74	NOBLEX	33
BENQ	58/59	NOKIA	25/26/27/60/61
BP	09	NORDMENDE	10
BRANDT	10/15	OLEVIA	45
BUSH	05	ONWA	30/39/70
CENTREX	66	ORION	05
CHANGHONG	69	PEONY	49/69
CURTIS	05	PHILCO	41/48/64
DAEWOO	64/65	PHILIPS	05/06/46
DESMET	05	PHONOLA	05
DUAL	05	PIONEER	37/38
ELEMIS	05	PROVIEW	52
FERGUSON	10/34	PYE	05
FINLUX	61	RADIOLA	05
FISHER	21	SABA	10
FUJITSU	53	SALORA	26
FUNAI	63/67	SAMSUNG	32/42/43/65/68
GOLDSTAR	05/50/51	SANSUI	05
GOODMANS	05	SANYO	21/54/55/56
GRADIENTE	36	SCHNEIDER	05/29/30
GRUNDIG	09	SEG	05/69/75/76/77/78
HIKONA	52	SELECO	05/25
HITACHI	05/22/23/40/41	SHARP	18
INNO HIT	05	SIEMENS	09
IRRADIO	30	SINUDYNE	05
ITT	25	SONY	08
JINGXING	49	TCL	31/33/66/67/69
JVC	17/30/39/70	TELEFUNKEN	10/11/12/13/14
KDS	52	TEVION	52
KOLIN	45	TEX ONDA	52
KONKA	62	THOMSON	10/15/44
LG	05/50/51	TOSHIBA	16/57
LOEWE	07/46	WHITE WESTINGHOUSE	05
MAG	52	YAMAHA	18/41

2 Test by turning on the television and changing channels.

- Repeat the procedure until you find the code that allows correct operation.
- If your television brand is not listed or if the code listed for your television does not allow control of your television, this remote control is not compatible with your television.

Note

- If your television brand has more than one code listed, select the one that allows correct operation.

HOLD function

The HOLD function deactivates all buttons on the unit and remote control. Use it to prevent other people from operating the unit.

Press and hold [OK] and [RETURN ↵] simultaneously until “X HOLD” appears on the unit’s display.



If you press a button while the HOLD function is on, “X HOLD” appears on the unit’s display and operation is impossible.

To cancel the HOLD function

Press and hold [OK] and [RETURN ↵] simultaneously until “X HOLD” disappears.

Connecting a television with AUDIO/VIDEO terminals

- Connect to terminals of the same colour.

Television's rear panel

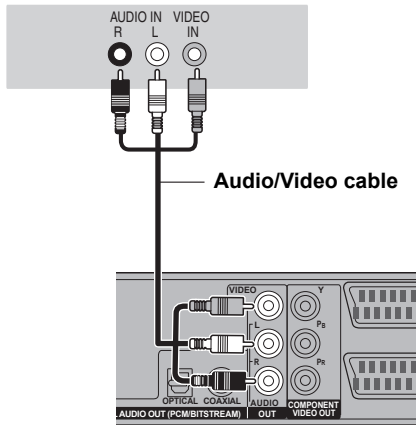

This unit's rear panel

Connecting a stereo amplifier

- Connect to terminals of the same colour.

Amplifier's rear panel

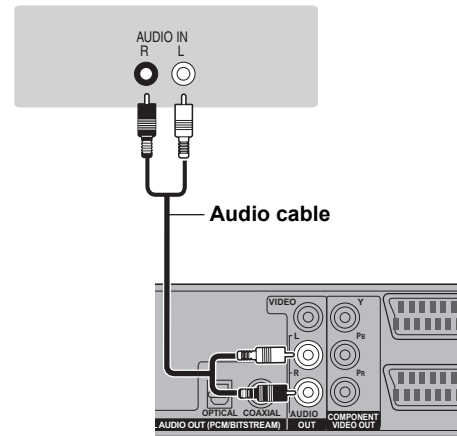

This unit's rear panel

Connecting a television with COMPONENT VIDEO terminals

- Connect to terminals of the same colour.

Television's rear panel

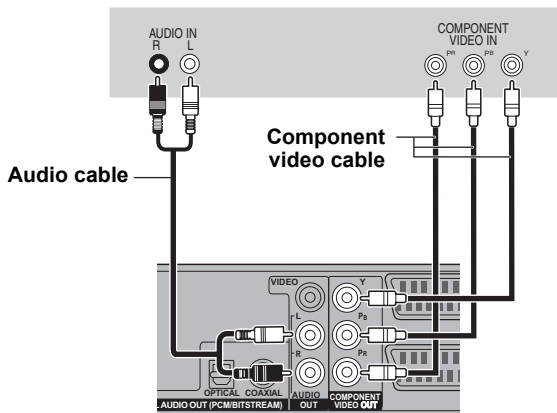

This unit's rear panel

COMPONENT VIDEO terminals can be used for either interlace or progressive output (⇒ 119) and provide a purer picture than the VIDEO OUT terminal.

Required setting

"Component Resolution" setting in the Setup menu (⇒ 94)

If you have a regular television (CRT: cathode ray tube)

Progressive output may cause some flickering, even if it is progressive compatible. Set the "Component Resolution" in Setup menu to "576i/480i" if you are concerned about it (⇒ 94). This is the same for multi system televisions using PAL mode.

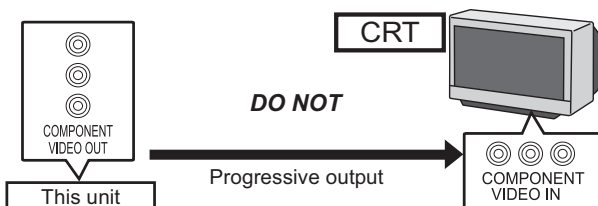

Connecting VCR or Set Top Box (Terrestrial receiver, CATV, etc.)

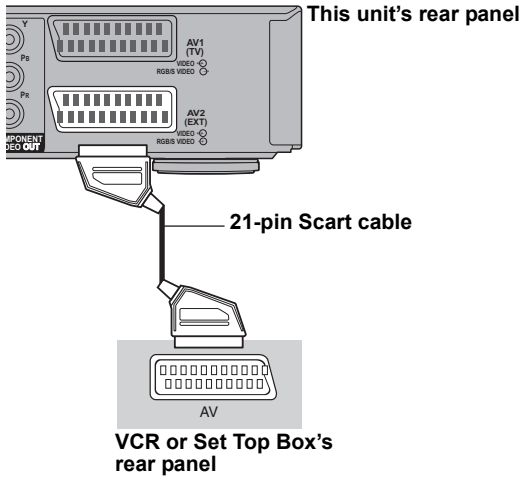

Connect the unit directly to the television

If you connect the unit through an AV selector or video cassette recorder to the television, video signal will be affected by copyright protection systems and the picture may not be shown correctly.

When connecting to a television with a built-in VCR

Connect to the input terminals on the television side if there are both television and VCR input terminals.

DO NOT

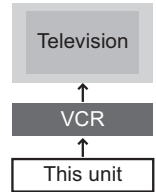

Connecting an amplifier with a digital input terminal

Required setting

- "Digital Audio Output" in the Setup menu (⇒ 91)

- When this unit is connected to an amplifier with an optical digital audio cable or coaxial cable and connected to a television with an HDMI cable, you can enjoy the highest quality of audio from the disc by setting "HDMI Audio Output" to "Off" in the Setup menu (⇒ 93). In this case audio is only output from the amplifier not the television.
- Before purchasing an optical digital audio cable (not included), check the terminal shape of the connected equipment.

With OPTICAL

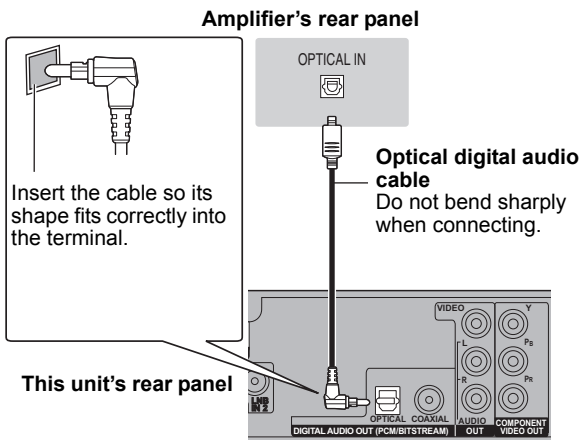

With COAXIAL

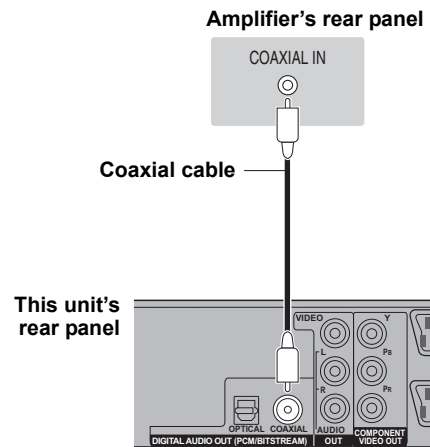

Connecting with an HDMI compatible television and receiver

When connected to an HDMI compatible unit, an uncompressed digital audio and video signal is transmitted. You can enjoy high quality, digital video and audio with just one cord. When connecting to an HDMI-compatible HDTV (High Definition Television), the output can be switched to 1080p, 1080i or 720p HD video.

- This unit incorporates HDMI™ (V.1.3a with Deep Colour, x.v.Colour™, High Bit Rate Audio) technology (⇒ 118, 119).
- Video sources converted to 1920×1080 resolution, while of high quality, will exhibit somewhat lower subjective image resolution than true, native 1080p full-HD sources. See dealer for details.
- Please use High Speed HDMI Cables that have the HDMI logo (as shown on the cover).
- When outputting 1080p signal, please use HDMI Cables 5.0 meters or less.

Regarding VIERA Link “HDAVI Control™” function

When connecting with a Panasonic TV (VIERA) or a receiver equipped with the “HDAVI Control” function, linked operations would be possible. [⇒ 76, Linked operations with the TV (VIERA Link “HDAVI Control™/Q Link”)]

- **Non-HDMI-compliant cables cannot be utilised.**
- **It is recommended that you use Panasonic’s HDMI cable.**

Recommended part number:
 RP-CDHS15 (1.5 m), RP-CDHS30 (3.0 m), RP-CDHS50 (5.0 m), etc.

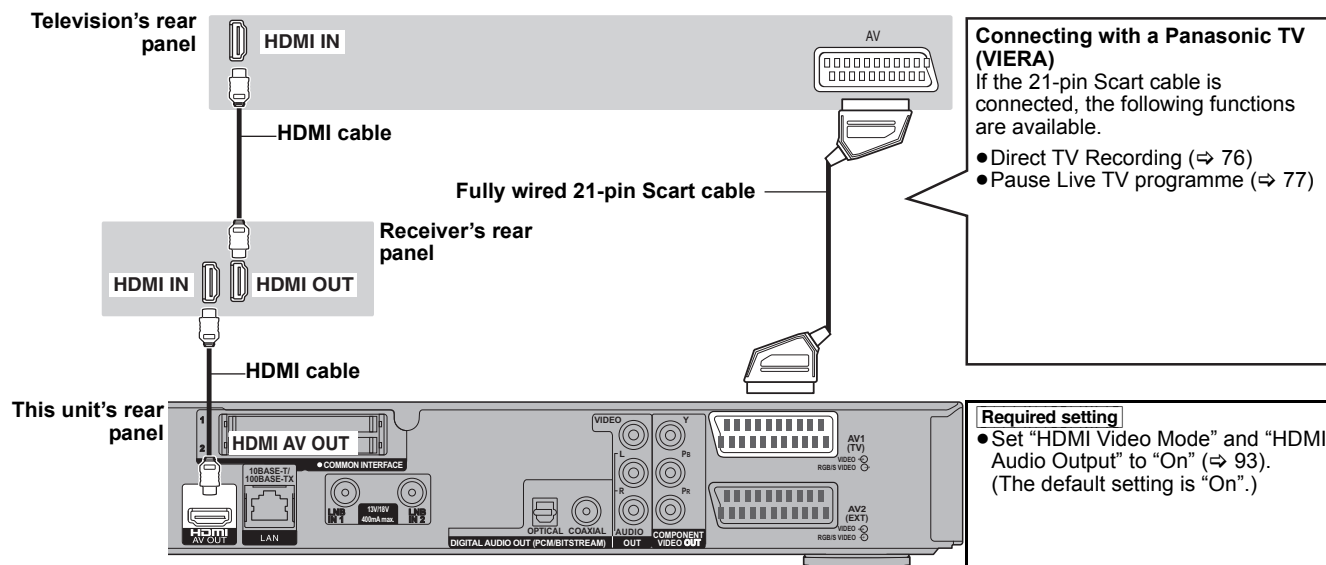

Note

- If you are connecting to a TV that is only compatible with 2 channel audio output, audio with 3 channels or more will be down mixed (⇒ 118) and output as 2 channels, even if connecting with an HDMI cable. (Some discs cannot be down mixed.)
 - You cannot connect this unit to DVI devices that are incompatible with HDCP.
- For units compatible with HDCP (High-Bandwidth Digital Content Protection) copyright protection that are equipped with a digital DVI input terminal (PC monitors, etc.):
 Depending on the unit, images may not display properly or at all when connecting with a DVI/HDMI switching cable. (Audio cannot be output.)

Operations that can be performed simultaneously

Operations that can be performed while recording or copying a title

(○: Possible, –: Impossible)

	Playback of HDD	Playback of discs	Playback of BD-Video	Playback of still pictures	Playback of music recorded on HDD
While recording to HDD in DR mode	○	○	○	–	○
While recording to HDD in XP, SP, LP, EP, or FR modes	○	○*	–	–	○
While recording from DV input	–	–	–	–	–
While copying in normal speed mode	–	–	–	–	–
While copying in high speed mode [With finalising or creating Top Menu (+RW)]	–	–	–	–	–
While copying in high speed mode [Without finalising or creating Top Menu (+RW)]	○	–	–	–	–

* **AVCHD** It cannot playback.

• Simultaneous operation is not possible while executing the "DV Automatic Recording" or "Flexible Recording via AV input".

Starting of the timer recording while executing other operation

Starting of timer recording possible during the following operations	Starting of timer recording not possible during the following operations
<ul style="list-style-type: none"> • Recording the title*1, *2, *3 • Playing the title*4 • Editing the title • Copying a title in high speed mode (without finalising or creating Top Menu) <ul style="list-style-type: none"> – Only 1 programme can be recorded • Executing "DV Automatic Recording"*1, *5 • Executing "Flexible Recording via AV input"*1, *5 • Executing Pause Live TV*1, *2 <p>*1 Cannot be executed when "One cable" has been selected in Auto Setup (⇒ 18, 87)</p> <p>*2 Executing operation will terminate when 2 programmes simultaneous recording cannot be performed.</p> <p>*3 While recording an encrypted broadcast, you cannot record another encrypted broadcast.</p> <p>*4 Playback of disc will terminate when the timer recording to disc is started while playing back from the disc or when the timer recording other than the DR mode has started while playing BD-Video.</p> <p>*5 Executing operation will be terminated.</p>	<ul style="list-style-type: none"> • Copying a title in normal speed mode • Copying a title in high speed mode (with finalising or creating Top Menu) • Copying HD Video (AVCHD format) • Editing still pictures or music • Copying still pictures • Copying music • Formatting • Finalising/Creating Top Menu (+RW)

Language code list

Enter the code with the numbered buttons.

Abkhazian: 6566	Catalan: 6765	Gujarati: 7185	Lingala: 7678	Rhaeto-Romance: 8277	Tamil: 8465
Afar: 6565	Chinese: 9072	Hausa: 7265	Lithuanian: 7684	Romanian: 8279	Tatar: 8484
Afrikaans: 6570	Corsican: 6779	Hebrew: 7387	Macedonian: 7775	Russian: 8285	Telugu: 8469
Albanian: 8381	Croatian: 7282	Hindi: 7273	Malagasy: 7771	Samoan: 8377	Thai: 8472
Amharic: 6577	Czech: 6783	Hungarian: 7285	Malay: 7783	Sanskrit: 8365	Tibetan: 6679
Arabic: 6582	Danish: 6865	Icelandic: 7383	Malayalam: 7776	Scots Gaelic: 7168	Tigrinya: 8473
Armenian: 7289	Dutch: 7876	Indonesian: 7378	Maltese: 7784	Serbian: 8382	Tonga: 8479
Assamese: 6583	English: 6978	Interlingua: 7365	Maori: 7773	Serbo-Croatian: 8372	Turkish: 8482
Aymara: 6589	Esperanto: 6979	Irish: 7165	Marathi: 7782	Shona: 8378	Turkmen: 8475
Azerbaijani: 6590	Estonian: 6984	Italian: 7384	Moldavian: 7779	Sindhi: 8368	Twi: 8487
Bashkir: 6665	Faroese: 7079	Japanese: 7465	Mongolian: 7778	Singhalese: 8373	Ukrainian: 8575
Basque: 6985	Fiji: 7074	Javanese: 7487	Nauru: 7865	Slovak: 8375	Urdu: 8582
Bengali; Bangla: 6678	Finnish: 7073	Kannada: 7578	Nepali: 7869	Slovenian: 8376	Uzbek: 8590
Bhutanian: 6890	French: 7082	Kashmiri: 7583	Norwegian: 7879	Somali: 8379	Vietnamese: 8673
Bihari: 6672	Frisian: 7089	Kazakh: 7575	Oriya: 7982	Spanish: 6983	Volapük: 8679
Breton: 6682	Galician: 7176	Kirghiz: 7589	Pashto, Pushto: 8083	Sundanese: 8385	Welsh: 6789
Bulgarian: 6671	Georgian: 7565	Korean: 7579	Persian: 7065	Swahili: 8387	Wolof: 8779
Burmese: 7789	German: 6869	Kurdish: 7585	Polish: 8076	Swedish: 8386	Xhosa: 8872
Byelorussian: 6669	Greek: 6976	Laotian: 7679	Portuguese: 8084	Tagalog: 8476	Yiddish: 7473
Cambodian: 7577	Greenlandic: 7576	Latin: 7665	Punjabi: 8065	Tajik: 8471	Yoruba: 8979
	Guarani: 7178	Latvian, Lettish: 7686	Quechua: 8185		Zulu: 9085

Frequently asked questions

Refer to the following items if you have any doubts about unit operations.

Set up

Can this unit receive or record High Definition (HD) broadcasts?

- Yes, this unit can receive or record High Definition (HD) broadcasts. Record in DR recording mode.

What do I need to play multi channel surround sound?

- Connect the appropriate amplifier/receiver to the HDMI AV OUT terminal, the DIGITAL AUDIO OUT terminal (OPTICAL, COAXIAL). (⇒ 101, 102)

Are the headphones and speakers directly connected to the unit?

- You cannot directly connect them to the unit. Connect through the amplifier etc. (⇒ 100, 101, 102)

My television has Scart terminal, COMPONENT VIDEO IN terminals and HDMI IN terminal. Which should I connect with?

- The different levels of picture quality input are listed below in order from highest to lowest.
HDMI IN→COMPONENT VIDEO IN→ Scart→VIDEO IN.
However, it will take longer for the picture output to start up when this unit is connected with the HDMI IN terminal.

When are the software (firmware) updates broadcast?

- The unit shows automatically when a software (firmware) update has been broadcast, and also automatically updates the software (firmware) if the time is specified in "Software Update in Standby". (⇒ 95)

Disc

Can I play BD-Video and DVD-Video bought in another country?

- Playback of the following discs is not possible. (⇒ Cover)
 - BD-Video discs that do not include region "B".
 - DVD-Video discs that do not include region "2" or "ALL".Refer to the disc's jacket for more information.

Can BD-Video/DVD-Video that does not have a region code/number be played?

- The region management information for BD-Video/DVD-Video indicates that the disc conforms to industry standards. You cannot play discs that do not conform to industry standards or do not have a region code or number.

Please tell me about disc compatibility with this unit.

- Refer to "HDD and disc information". (⇒ 6–10)

Recording

Can I record from a commercially purchased video cassette, Blu-ray Disc or DVD?

- Most commercially sold video cassettes, Blu-ray Disc and DVD are copy protected; therefore, recording is usually not possible.

Can the disc recorded with this unit play on other equipment?

- Refer to "Play on other players" in "HDD and disc information". (⇒ 8, 9)

Can I copy to a disc at high speed copy?

- Yes, you can. (But you may not high speed copy depending on the disc to copy or the title.) (⇒ 54)
Depending on the disc type, the maximum speed varies.

- Title in DR mode on the HDD can be copied to BD-RE or BD-R at high speed.

Is it possible to copy to the disc, SD card, or USB memory after copying HD video (AVCHD format) to the HDD?

- It can be copied to the disc.
 - **BD-RE** **BD-R** It can be copied with HD quality.
 - **RAM** **-R** **-R DL** **-RW(V)** **+R** **+R DL** **+RW** It will be copied with SD quality. (It cannot be copied as it is in HD picture quality.)
- It cannot be copied to SD card or USB memory.

TV Guide

Is it possible to programme a recording, with a start and end time that are different from the TV Guide system?

- You can change the start and end time of programmes in the Timer Recording menu. (⇒ 35, 90)

Can I receive TV Guide system data via a Set Top Box?

- No, only via the built-in tuner. To perform timer recordings with Set Top Boxes, please use the External Link feature or your unit's manual timer programming. (⇒ 35, 59)

How can I cancel a TIMER programming?

- Press [PROG/CHECK] and select the desired entry and then press [DEL]. (⇒ 37)

What happens when I unplug the unit from the household mains socket?

- The TV Guide data will not be updated.
- If the unit is disconnected from the household mains socket for a longer period of time, the TV Guide data will be lost.
- Clock setting will be erased and timer recording will not work.

USB

What can or cannot be done using the USB port on this unit?

- You can play DivX, MP3 or still picture (JPEG) files on a USB memory. (⇒ 44, 64, 70)
- You can copy still pictures (JPEG) files on a USB memory to the HDD, BD-RE or DVD-RAM. (⇒ 68)
- You can copy MP3 files on a USB memory to the HDD. (⇒ 75)
- You can connect a video equipment and copy SD Video to the HDD or DVD-RAM. (⇒ 63)
- You can connect a video equipment and copy HD Video to the HDD, BD-RE or BD-R. (⇒ 62)
- Data on the HDD or a disc cannot be transferred to a USB memory.
- Data on a USB memory cannot be edited or a USB memory cannot be formatted on this unit.
- Some USB memories cannot be used with this unit. (⇒ 11)

Music

What will happen if I try to record the same CD multiple times?

- New album will be made following the existing album.

Can I transfer the music tracks from HDD to the disc or USB memory?

- No, you cannot.

Regarding Frequently asked questions for copying (⇒ 54)

On the television

Authorisation Error.	<ul style="list-style-type: none"> You are trying to play the DivX VOD content that was purchased with a different registration code. You cannot play the content on this unit. (DivX) (⇒ 45)
Cannot finish recording completely.	<ul style="list-style-type: none"> The programme was copy-protected. The HDD or disc may be full. The maximum number of programme has been exceeded. (⇒ 29)
Cannot play. Incompatible TV system setting !	<ul style="list-style-type: none"> You tried to play a title recorded using a different encoding system from that of the TV system currently selected on the unit. Alter the "TV System" setting on this unit to suit. (⇒ 93)
Cannot record to the disc.	<ul style="list-style-type: none"> The disc may be dirty or scratched. (⇒ 15)
Cannot format.	
Cannot play on this unit.	<ul style="list-style-type: none"> You tried to play a non-compatible image. (⇒ 116) Turn the unit off and re-insert the USB memory or card. (⇒ 15)
No folders.	<ul style="list-style-type: none"> There is no compatible folder in this unit. (⇒ 117)
No SD card No valid SD card.	<ul style="list-style-type: none"> The card is not inserted. If this message is displayed with a compatible card already inserted, turn off the unit, remove and then re-insert the card. (⇒ 15) The card inserted is not compatible or the card format does not match. (⇒ 116)
Not enough space in the copy destination.	<ul style="list-style-type: none"> Create space by deleting any unnecessary items. (⇒ 25, 49, 85) Delete one or more items registered on the copy list to ensure that the "Destination Capacity" is not exceeded.
The disc is not recordable.	<ul style="list-style-type: none"> The unit cannot record on the disc you inserted. Insert an unfinalised disc. You inserted an unformatted disc. (⇒ 85)
This disc is not formatted properly.	
Rental Expired.	<ul style="list-style-type: none"> The DivX VOD content has zero remaining plays. You cannot play it.
⊘ This operation cannot be performed now.	<ul style="list-style-type: none"> The operation is prohibited by the unit or disc. <ul style="list-style-type: none"> BD-V: During playback, reverse slow-motion or reverse frame-by-frame is not possible. Depending on the disc, you may not be able to perform search or skip when film previews and warning screens are being played back.
⊘ This operation is prohibited by this disc.	<ul style="list-style-type: none"> Depending on the disc, you may not be able to perform search or skip when film previews and warning screens are being played back.

When removing a recorded disc

-R -R DL -RW(V) +R +R DL

The following screen appears when you have not processed the disc for play on other equipment.

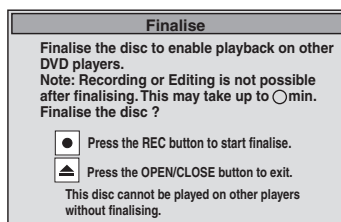

■ To finalise the disc

Press **[● REC]** on the main unit.

- You cannot stop this process once you have started it.
- If you want to set the background, play menu select or provide a disc name, select "Top Menu" (⇒ 86), "Auto-Play Select" (⇒ 86) or "Disc Name" (⇒ 84) in "DVD Management" before finalising.

■ To open the tray without disc finalisation

Press **[▲ OPEN/CLOSE]** on the main unit.

On the unit's display

The following messages or service numbers appear on the unit's display when something unusual is detected during startup and use.

BD □ ("□" stands for a number.)	<ul style="list-style-type: none"> The remote control and main unit are using different codes. Change the code on the remote control.  <p>Press and hold [OK] and the indicated number button at the same time for more than 5 seconds. (⇒ 95)</p>
CAM-UP	<ul style="list-style-type: none"> CAM is being updated. (⇒ 98)
GUIDE	<ul style="list-style-type: none"> TV Guide data is being downloaded. (⇒ 38)
FINISH	<ul style="list-style-type: none"> The software (firmware) update is complete. (⇒ 98)
HARD ERR*	<ul style="list-style-type: none"> If there is no change after turning the unit on and off, consult the dealer where the unit was purchased.
NoERAS	<ul style="list-style-type: none"> You cannot delete items on this disc. The disc may be damaged. Use a new disc.
NoREAD	<ul style="list-style-type: none"> The disc is dirty or badly scratched. The unit cannot record, play, or edit. (⇒ 15) This message may appear when the lens cleaner has finished cleaning. Press [▲ OPEN/CLOSE] on the main unit to eject the disc. (⇒ 14)
NoWRIT	<ul style="list-style-type: none"> You cannot write to this disc. The disc may be damaged. Use a new disc.
PLEASE WAIT*	<ul style="list-style-type: none"> Displayed when the unit is started and turned off. This is not malfunction. It takes some minutes until the message disappears depending on the status of the unit. You can not turn the unit on while the message is displayed. There was a power failure or the AC plug was disconnected while the unit was on. The unit is carrying out its recovery process. This process restores the unit to normal operation. The unit is not broken. Wait until the message disappears.
PROG FULL*	<ul style="list-style-type: none"> There are already 64 timer programmes. Delete unnecessary timer programmes. (⇒ 37)
REMOVE	<ul style="list-style-type: none"> The USB device is drawing too much power. Remove the USB device.
START	<ul style="list-style-type: none"> Update of the software (firmware) is started. You cannot operate the unit until the update is complete. (⇒ 98)
SW-DL	<ul style="list-style-type: none"> Software (firmware) is downloading. Download will stop when the power is turned on, or the timer recording starts. (⇒ 98)
UNFORMAT*	<ul style="list-style-type: none"> You inserted an unformatted BD-RE, BD-R, DVD-RAM, DVD-RW, +RW, an unused +R, +R DL, or DVD-RW (DVD-Video format) that has been recorded on other equipment. Format the disc to use it. (⇒ 85) However all the recorded contents on the disc are deleted.
UNSUPPORT*	<ul style="list-style-type: none"> You have inserted a disc the unit cannot play or record on. (⇒ 6–10) You tried to operate with a non-compatible USB memory.
UPD □/□ ("□" stands for a number.)	<ul style="list-style-type: none"> The software (firmware) is being updated. You cannot operate the unit until the update is complete. (⇒ 98)
U50	<ul style="list-style-type: none"> The terminal, antenna cable or dish is short-circuited as for both LNB IN 1 and LNB IN 2. Check the connection status. (⇒ 17)
U50 1	<ul style="list-style-type: none"> The terminal, antenna cable or dish is short-circuited as for LNB IN 1. Check the connection status. (⇒ 17)
U50 2	<ul style="list-style-type: none"> The terminal, antenna cable or dish is short-circuited as for LNB IN 2. Check the connection status. (⇒ 17)
U59	<ul style="list-style-type: none"> The unit is hot. The unit switches to standby for safety reasons. Wait for about 30 minutes until the message disappears. Select a position with good ventilation when installing the unit. Do not block the cooling fan on the rear of the unit.
U61	<ul style="list-style-type: none"> (When a disc is not inserted) Displays when a malfunction has occurred during recording, playback or copy. This is displayed when the unit is in the recovery process to return to normal operation; it is not broken. Once the display clears you can use the unit again.
U72 U73	<ul style="list-style-type: none"> The HDMI connection acts unusually. <ul style="list-style-type: none"> The connected equipment is not HDMI compatible. Please use HDMI cables that have the HDMI logo (as shown on the cover). The HDMI cable is damaged.
U76	<ul style="list-style-type: none"> HDMI cannot be output because you are connected to a model that does not support copyright protection.
U77	<ul style="list-style-type: none"> Due to the current disc not having authorised copyright information, video output is not performed.
U88	<ul style="list-style-type: none"> (When a disc is inserted) Displays when there was something unusual detected with the disc while recording, playback or copy. This is displayed when the unit is in the recovery process to return to normal operation; it is not broken. Once the display clears you can use the unit again. (⇒ 108)
U99	<ul style="list-style-type: none"> The unit fails to operate properly. Press [⏻/] on the main unit to switch the unit to standby mode. Now press [⏻/] on the main unit again to turn the unit on.
H□□ or F□□	<ul style="list-style-type: none"> There is something unusual. (The service number displayed after H and F depends on the unit's condition.) Check the unit using the troubleshooting guide. If the service number does not disappear, do the following. (⇒ 108–114) <ol style="list-style-type: none"> Disconnect the plug from the household mains socket, wait a few seconds, then reconnect it. Press [⏻/] to turn the power on. (The unit may be fixed.) If the service number does not disappear despite after doing the above, request service from the dealer. Inform the dealer of the service number when requesting service.
X HOLD	<ul style="list-style-type: none"> The HOLD function is activated. Press and hold [OK] and [RETURN ↵] at the same time until "X HOLD" disappears. (⇒ 99)

* The message scrolls on the unit's display.

Troubleshooting guide

Before requesting service, make the following checks. If you are in doubt about some of the check points, or if the solutions indicated in the chart do not solve the problem, consult your dealer for instructions.

Updating to the latest software (firmware) may solve the problem. (⇒ 98)

The following do not indicate a problem with this unit:

- Regular disc rotating sounds.
- Poor reception due to atmospheric conditions.
- Image disturbance during search.
- Interruptions in reception due to periodic satellite broadcasting breaks.
- Operations are slow to respond in power save mode.
- Operations do not work due to a poor-quality disc. (Try again using a Panasonic disc.)
- **The unit freezes due to one of its safety devices being activated. (Press and hold [⏻/⏸] on the main unit for 3 seconds.)**
- When the unit is turned on or off, there may be an unexpected sound. This does not indicate a problem with this unit.

Power

No power.

The unit does not turn on pressing [⏻].

- Insert the AC mains lead securely into a known active household mains socket. (⇒ 17)

The unit switches to standby mode.

- One of the unit's safety devices is activated. Press [⏻/⏸] on the main unit to turn the unit on.

The power is turned off automatically.

- If you connected this unit to a "HDAVI Control" compatible TV with an HDMI cable, or connected this unit to a Q Link-compatible TV with a fully wired 21-pin Scart cable, this unit will be automatically set to standby mode when the TV is set to standby mode.

This unit turns off when the TV input is switched.

- If connected with an HDAVI Control 4 compatible TV (VIERA) with the "Intelligent Auto Standby" setting activated on the TV, when switching the TV input, the unit will be automatically turned to standby. For details please read the operating instructions of the TV.

Displays

The display is dim.

- Change "Unit's Display" in the Setup menu. (⇒ 92)

"0:00" is flashing on the unit's display.

- Set the clock. (⇒ 95)

The time recorded on the disc and the available time shown do not add up.

The displayed time of this unit is different from the actual recording time.

- Times shown may disagree with actual times.
- **BD-R R R DL +R +R DL** The remaining capacity does not increase even if titles are deleted.
- Available recording space on DVD-RW (DVD-Video format) or +RW increases only when the last recorded title is deleted. It does not increase if other titles are deleted.
- If you record or edit about 200 times or more, the remaining capacity of DVD-R, DVD-R DL, +R, and +R DL is reduced and then recording or editing may be disabled (for the second layer on DVD-R DL and +R DL, this happens after about 60 times).
- While searching, the elapsed time may not display correctly.

Compared to the actual recorded time, the elapsed time displayed is less. (Only when recording in NTSC)

- The displayed recording/play time is converted from the number of frames at 29.97 frames (equal to 0.999 seconds) to one second. There will be a slight difference between the time displayed and the actual elapsed time (e.g., actual one-hour elapsed time may display as approximately 59 minutes 56 seconds). This does not affect the recording.

The clock does not display on the unit when switched to standby.

- The clock does not display when "Power Save" is set to "On". Ensure "Power Save" is set to "Off". (⇒ 95)

Available disc space display is showing different from what was used

- Available disc space display may be different from actual. Varying may be large especially when recorded in DR mode.

"U88" is displayed and the disc cannot be ejected.

- The unit is carrying out the recovery process. Do the following to eject the disc.
 - 1 Press [⏻/⏸] on the main unit to switch the unit to standby. If the unit doesn't switch to standby, press and hold [⏻/⏸] on the main unit for about 3 seconds. The unit is forcibly switched to standby.
 - 2 While the unit is off, press and hold [■] and [CH ^] on the main unit at the same time for about 5 seconds. Remove the disc.

TV screen and video

Television reception worsens after connecting the unit.

- This can occur because the signals are being divided between the unit and other equipment. It can be solved by using a signal booster, available from audio-visual suppliers. If it is not solved by using a signal booster, consult the dealer.

The digital channel information or Control Panel does not appear.

- Select the length of time (3–10 sec.) that the "On-Screen Messages" in the Setup menu will be displayed. (⇒ 92)
- The digital channel information will not appear during playback.
- The Control Panel is only displayed when connected to a TV with "HDAVI Control 2" or later. (⇒ 77)

Picture does not appear during timer recording.

- Timer recordings work regardless whether the unit is on or off. To confirm the timer recording is going to work properly, turn the unit on.

Screen size is wrong.

- Use the television to change the aspect. If your television does not have that function, set "HDMI Video Mode" in the Setup menu to "Off" (⇒ 93) and "Component Resolution" to "576i/480i". (⇒ 94)
- Check the following setting in the Setup menu. (⇒ 92) – "TV Aspect", "Aspect for 4:3 Video"
- Check "Aspect for Recording" before recording or file conversion. (⇒ 90)
- If you connect an HDMI cable, set "Aspect for 4:3 Video" in the Setup menu to "16:9". (⇒ 92)

It may be possible to adjust the display mode on the TV. Refer to your television's operating instructions.

Pictures do not appear with the HD quality although HD setting was made.

- Even if this unit is connected to a TV through COMPONENT VIDEO terminals and the Component Resolution is set to 720p or 1080i, the pictures of HD broadcast output from this unit are output with 576p/480p.

The screen changes automatically.

- If there is no operation for 5 minutes or more, the displayed screen switches to the other states automatically. (only when the "Screen Saver" in Setup menu is set to "On".) (⇒ 92)

The recorded title is stretched vertically.

- It may have been recorded with 4:3 aspect ratio. You will be able to view in 16:9 aspect ratio by setting the "Aspect for 4:3 Video" in Setup menu to "4:3". (⇒ 92)
 - If the 16:9 aspect ratio image is output to a 4:3 TV connected with the COMPONENT VIDEO OUT terminal or the HDMI AV OUT terminal, it will be stretched vertically. Adjust by the aspect ratio setting on the TV. If you cannot make the adjustment, set the "Component Resolution" in the Setup menu to "576p/480p" and "HDMI Video Format" to "576p/480p". (⇒ 93, 94)
 - 16:9 aspect programmes are recorded in 4:3 aspect in the following cases.
 - **-R -R DL -RW(V)** If you recorded or copied using "EP" or "FR (recordings 5 hours or longer)" recording mode.
 - If you recorded or copied to a +R, +R DL or +RW.
 - If you recorded with the "Aspect for Recording" set to "4:3" in the Setup menu. (⇒ 90)When you want to record 16:9 programme in the same aspect, set "Rec for High Speed Copy" to "On", and set the "Aspect for Recording" to "16:9". (⇒ 90)
- It may be possible to adjust the display mode on the TV. Refer to your television's operating instructions.

There is a lot of after-image when playing video.

- Set "HD optimizer" in the Picture menu to "Off". (⇒ 82)

When playing DVD-Video using progressive output, one part of the picture momentarily appears to be doubled up.

- This problem is caused by the editing method or material used on DVD-Video, but should be corrected if you use interlaced output. If outputting from the COMPONENT VIDEO OUT terminal, set "Component Resolution" to "576i/480i" in the Setup menu. (⇒ 94)

There is no apparent change in picture quality when adjusted with the Picture menu in the on-screen menus.

- The effect is less perceivable with some types of video.

The images from this unit do not appear on the television.

Picture is distorted.

- Make sure that the television is connected to the AV1 terminal, the VIDEO OUT terminal, COMPONENT VIDEO OUT terminals or HDMI terminal on this unit. (⇒ 17, 100)
- Make sure that the television's input setting is correct.
- When "Component Resolution" in the Setup menu is set to "576p/480p" or "720p", but the connected television is not progressive compatible, press and hold [■] and [▶] (PLAY) on the main unit at the same time for more than 5 seconds to cancel this setting. The setting will change to interlace.
- The unit's "TV System" setting differs from the TV system used by the disc now playing. While stopped, keep pressing [■] and [▲ OPEN/CLOSE] on the main unit for 5 or more seconds. The system switches from PAL to NTSC or vice versa. (⇒ 93)
- When this unit is connected with an HDMI cable, use a disc that matches with this unit's TV system.
- Picture may not be seen when more than 4 devices are connected with HDMI cables. Reduce the number of connected devices.

The picture is distorted during play, or video will not play correctly.

- You may be playing a TV programme recorded with poor reception or unfavourable weather conditions.
- The picture may be distorted or a black screen may appear briefly between recorded titles in the following situations:
 - between titles recorded with different recording modes.
 - between scenes recorded with different aspect ratios.
 - between scenes recorded with different resolutions.
 - between playlist chapters.
- Make sure the connections are pushed firmly. (⇒ 17, 100–103)

Sound

No sound.

Low volume.

Distorted sound.

Cannot hear the desired audio type.

- Check the connections and the "Digital Audio Output" settings. Check the input mode on the amplifier if you have connected one. (⇒ 17, 91, 100–103)
- Check if TV is muted.
- Check if amplifier is muted.
- Sound is not output while fast-forwarding during chasing playback and simultaneous record and playback.
- Press [AUDIO] to select the audio. (⇒ 40)
- Turn the "Sound Effects" in the Sound menu to "Off" in the following cases. (⇒ 82)
 - When using discs that do not have surround sound effects such as Karaoke discs.
 - When playing bilingual broadcast titles.
- Audio may not be heard when more than 4 devices are connected with HDMI cables. Reduce the number of connected devices.
- Audio may not be output due to how files were created. (DivX)
- The sound effects will not work when the bitstream signal is output from the HDMI AV OUT terminal or the DIGITAL AUDIO OUT terminal.
- To output audio from a device connected with an HDMI cable, set "HDMI Audio Output" to "On" in the Setup menu. (⇒ 93)
- Depending on the connected equipment, the sound may be distorted if this unit is connected with an HDMI cable.
- When "BD-Video Secondary Audio" is set to "On", Dolby Digital Plus, Dolby TrueHD, and DTS-HD are converted to 48 kHz Dolby Digital and output. In this case, set the "BD-Video Secondary Audio" to "Off". (⇒ 91)

Cannot switch audio.

- You cannot switch the audio (L, R) in the following cases.
 - When the recording mode is XP and "Audio Mode for XP Recording" is set to "LPCM". (⇒ 92)
 - When "Rec for High Speed Copy" is set to "On". (The default setting is "On"). (⇒ 90)
- The amplifier is connected using an optical digital audio cable, a coaxial cable or an HDMI cable. You cannot switch the audio if "Dolby D/Dolby D +/Dolby TrueHD", "DTS/DTS-HD" or "MPEG" is set to "Bitstream". Set "Dolby D/Dolby D +/Dolby TrueHD", "DTS/DTS-HD" or "MPEG" to "PCM" or connect using audio cables. (⇒ 91, 101, 102)
- There are discs for which audio cannot be changed because of how the disc was created.

Operation

Cannot operate the television. The remote control doesn't work.

- Change the manufacturer code. Some televisions cannot be operated even if you change the code. (⇒ 99)
- The remote control and main unit are using different codes. Change the code on the remote control. (⇒ 95)



Press and hold [OK] and the indicated number button at the same time for more than 5 seconds.

- The batteries are depleted. Replace them with new ones. (⇒ 3)
- You are not pointing the remote control at the main unit's remote control signal sensor during operation. (⇒ 3)
- Coloured glass may obstruct the signal reception/transmission.
- Don't place the signal sensor in direct sunlight or in areas that may be subject to sunlight exposure.
- Software (firmware) is updating when "UPD □/□" is displaying on the unit's display. Wait until the update is completed. (⇒ 98)
- It may be necessary to set the code on the remote control again after changing the batteries. (⇒ 95)
- It may be necessary to set the manufacturer code again after changing the batteries. (⇒ 99)
- The HOLD function is activated. (⇒ 99)

The unit is on but cannot be operated.

- Recording drive or playback drive has not been selected properly.
- Some operations may be prohibited by the disc.
- The unit is hot ("U59" appears on the display). Wait for "U59" to disappear.
- One of the unit's safety devices may have been activated. Reset the unit as follows:
 - 1 Press [⏻/|] on the main unit to switch the unit to standby. If the unit doesn't switch to standby, press and hold [⏻/|] on the main unit for about 3 seconds. The unit is forcibly switched to standby. Alternatively, disconnect the AC mains lead, wait one minute, then reconnect it.
 - 2 Press [⏻/|] on the main unit to switch it on. If the unit still cannot be operated, consult the dealer.

Cannot eject disc.

- The unit is recording.
- The unit may have a problem. While the unit is off, press and hold [■] and [CH ^] on the main unit at the same time for about 5 seconds. Remove the disc and consult the dealer. If the HOLD function is activated, above operation does not work. Cancel the HOLD function. (⇒ 99)

Cannot tune channels.

- Check the connections.

Startup is slow.

- Startup takes time in the following situations:
 - A disc other than a DVD-RAM is inserted.
 - The clock is not set.
 - Immediately after a power failure or the AC mains lead is connected.
 - When the unit is connected with an HDMI cable.
- Set "Power Save" to "Off" in the Setup menu. (⇒ 95)
This is a normal phenomenon when using VIERA Link (HDAVI Control 4 or later). For details please read the operating instructions for the TV.

Recording, timer recording and copying

Cannot record. Cannot copy.

- You can not record to the disc by pressing the [● REC] or timer recording.
- BD-RE with a cartridge cannot be copied.
- **BD-RE BD-R RAM -RW(V) +R +R DL +RW** The disc is unformatted. Format the disc. (⇒ 85)
- The disc is protected with DVD Management or Blu-ray Disc Management. (⇒ 84)
- You cannot record/copy when there is not enough space or when the number of titles has reached its limit. Delete unwanted titles or use a new disc. (⇒ 25, 49, 85)
- **-R -R DL -RW(V) +R +R DL +RW** In the following situations, you cannot copy. Delete unnecessary titles from the HDD and then copy. (⇒ 25, 49, 85)
 - If there is not enough space available on the HDD (If you will copy titles from the HDD to a blank disc and fill the entire disc, HDD disc space equivalent to 4 hours of SP mode recording is necessary).
 - If the number of recorded titles and the number of titles to be copied has exceeded 999.
- You cannot copy on finalised discs. However, you can record and copy again if you format BD-RE and DVD-RW.
- Due to peculiarities of DVD-R, DVD-R DL, DVD-RW (DVD-Video format), +R, +R DL and +RW you may be unable to record onto or edit them if you either insert and remove the disc or switch the unit on and off while a disc is loaded, a total of 30 times.
- Discs recorded on equipment other than this unit may not be able to be copied to.
- This unit cannot record NTSC signals to discs that already have PAL signal recordings. (However, both types of programmes can be recorded/copied onto the HDD, BD-RE or BD-R.) Play of discs recorded with both PAL and NTSC on another unit is not guaranteed.
- Some broadcasts are copyright protected.

Cannot record from external equipment.

- Check that the connection is correct. (⇒ 60, 101)
- The proper external input channel (AV2, AV3, or DV) is not selected. Press [INPUT SELECT] to change.
- Select the input channel for the equipment you have connected.
- Recording-restricted or copy-restricted programmes may not be recorded.

Cannot record 2 programmes simultaneously.

- It cannot in following conditions.
 - One satellite cable is connected to this unit.
 - "One cable" has been selected in Auto Setup (⇒ 18, 22, 87)
 - Record 2 programmes from external input
 - When performing high speed copying (1 programme can be recorded to HDD)
 - Recording from DV input, while recording to discs with "Flexible Recording via AV input" function.

The recording lacks the beginning or ending part of the programme although the timer recording was set on TV Guide.

- This occurs when the broadcast signals are not correct. We recommend you set the timer again, allowing enough time for the start and end time. (⇒ 90)

Timer recording does not stop even when [■] is pressed.

- When using the linked timer recording with external equipment, press [EXT LINK]. ("EXT-L" on the unit's display disappears.) (⇒ 59)

Timer recording does not work properly.

- The timer programme is incorrect or different timer programme times overlap (⌚ is displayed). Correct the programme. (⇒ 37)
- The programme is not in timer recording standby. (The timer icon "⊕" (red) in the timer recording list is grey.) (⇒ 36)
- Set the clock. (⇒ 95)

The timer programme remains even after recording finishes.

- The timer programme remains if set to daily or weekly. (⇒ 35)

A part or whole of a recorded title has been lost.

- If there is a power failure or the AC mains lead is disconnected from the household mains socket while recording or editing, the title may be lost or the HDD/disc may become unusable. You will have to format the disc (HDD BD-RE RAM -RW(V) +RW) or use a new disc. We cannot offer any guarantee regarding lost programmes or discs. (⇒ 85, 90)
- If you use Auto Renewal Recording, the old title will be deleted after the new title is recorded. (⇒ 36)

Cannot copy to a disc using the high speed mode.

- High speed copying cannot be performed depending on the disc or title that is being copied. Refer to "When is high speed copy not possible?" for details. (⇒ 54)

When copying, it takes a long time even when high speed mode is selected.

- Use a disc that is compatible with high speed recording. Even if the disc is high speed recording compatible, the maximum speed may not be possible due to the condition of the disc.
- It takes longer than normal to copy many titles.
- You cannot high speed copy to DVD-R titles longer than 6 hours when using other Panasonic DVD Recorders that are not compatible with EP (8 hours) mode recording.

An unusually loud sound is coming from the rotating disc.

- When recording or high speed copying to a disc, the sound of the disc rotating may be louder than normal, however, this is not a problem.
- If you want copy to perform more quietly, select "Normal (Silent)" in "BD / DVD Speed for High Speed Copy" in the Setup menu. (⇒ 90)

The quality has dropped when the title in HDD is copied to the disc.

- Titles in HD quality (titles recorded in DR mode or titles in AVCHD) will be copied as SD quality when copied to RAM -R -R DL -RW(V) +R +R DL +RW.

The DV automatic recording function does not work.

- If images cannot be recorded or if the recording is aborted, check the connections and DV equipment settings. (⇒ 60)
- You cannot start recording until the images from the DV equipment appear on the television.
- Recording may not be performed as desired if the time codes on the tape in the DV equipment are not successive.
- Depending on the equipment, the DV automatic recording may not operate properly.
- The audio/video recordings are recorded on other than a DV tape. (⇒ 61)

You cannot press [INPUT SELECT] to select external input other than AV2.

- You cannot select external input other than AV2 when this unit is in EXT LINK Standby mode or recording. Press [EXT LINK] to cancel EXT LINK Standby mode. (⇒ 59)

Recorded title cannot be played back anymore.

- There are some titles that are copyright protected (Copying is prohibited) for which the playback is disabled after a predetermined time. (⇒ 31)

Play

Play fails to start even when [▶] (PLAY) is pressed.

Play starts but then stops immediately.

- Insert the disc correctly with the label facing up. (⇒ 15)
- The disc is dirty, scratched or marked. (⇒ 15)
- You tried to play a blank disc or disc unplayable on this unit. (⇒ 10)
- You tried to play a +RW that needs to have a top menu on the equipment used for recording.
- When recording to DVD-RAM using EP (8 hours) mode, play may not be possible on DVD players that are compatible with DVD-RAM. In this case use EP (6 hours) mode. (⇒ 90)
- You cannot playback while executing the "Flexible Recording via AV input" or when recording from the DV input.
- If playing DivX VOD content, refer to the homepage where you purchased it. (DivX)
- Make sure that the TV is turned on. If the menu or messages are displayed, follow the on-screen instructions.
- Set "Play Video (AVCHD) on BD-RE / BD-R" to "On" for the disc that has high definition video (AVCHD) recorded by the Panasonic's video camera, etc. and other video format such as those recorded on this unit. (⇒ 89)

Audio and video momentarily pause.

- This occurs between playlist chapters.
- This occurs between chapters and with partially deleted titles on finalised DVD-R, DVD-R DL, DVD-RW (DVD-Video format), +R, +R DL and +RW that have been copied using the high speed mode.
- This occurs as scenes change during Quick View.
- **-R DL +R DL** When playing a title recorded on both layers, the unit automatically switches between layers and plays the title in the same way as a normal programme. However, video and audio may momentarily cut out when the unit is switching layers. (⇒ 40)

BD-Video or DVD-Video is not played.

- You have set a ratings level to limit BD-Video or DVD-Video play. Change this setting. (⇒ 89)
- Ensure the disc is for the correct BD-Video region code or DVD-Video region number, and is not defective. (⇒ Cover)
- **BD-V** You cannot playback while recording from external equipment.

Alternative soundtrack and subtitles cannot be selected.

- The languages are not recorded on the disc.
- You may not be able to use the on-screen menus to change the soundtrack and subtitles on some discs. Use the disc's menus to make changes. (⇒ 21)

No subtitles.

- Subtitles are not recorded on the disc.
- Turn the subtitles on. Set "Subtitles" on the on-screen menu to "On". (⇒ 81)

Angle cannot be changed.

- Angles can only be changed during scenes where different angles are recorded.

You have forgotten your ratings PIN. You want to cancel the ratings level.

- The ratings level returns to the factory preset. While the disc tray is open, press [DRIVE SELECT] to select the BD drive, then press and hold [● REC] and [▶] (PLAY) on the main unit at the same time for 5 or more seconds ("INIT" will appear on the unit's display).

Image for the Quick View is not smooth.

- Image may not be played back smoothly in case of DR, HG, HX, HE, HL mode titles or **BD-V AVCHD**.
- This function does not work when recording is in XP or FR mode.

The resume play function does not work.

- Memorized positions are cancelled when
 - open the disc tray.
 - **SD CD USB** turn off the power. (**HDD** will not be cancelled)
- This function does not work for Some BD-Video disc that contains BD-J.

Time Slip, Manual Skip, etc. does not work. Slow-motion playback does not go reverse. Reverse frame-by-frame does not work properly.

- Time Slip does not work when the unit's "TV System" settings are different from the title recorded on the disc. (⇒ 93)
- Slow-motion playback in reverse does not work for **BD-V AVCHD**.
- **BD-V AVCHD** Reverse frame-by-frame cannot be done.
- Frame-by-frame backward for titles that have copied the AVCHD will be reversed in 10 frame units.
- Slow-motion and frame-by-frame do not work with the title recorded from radio service.

It takes time before play starts.

- This is normal on DivX video. (DivX)

Picture stops.

- Picture may stop if the DivX files are greater than 2 GB. (DivX).

Cannot see the beginning of the title played.

- (If connecting to a TV that supports VIERA Link with an HDMI cable)
When [▶] (PLAY) is pressed on this unit's remote control, you may not be able to see the beginning of the title played until the picture is displayed on the TV. Using [◀◀], return to the beginning of the title.

Edit

The available recording time doesn't increase even after deleting titles on the disc.

- Available space on BD-R, DVD-R, DVD-R DL, +R, or +R DL does not increase even after deleting previous titles.
- Available space on DVD-RW (DVD-Video format) or +RW increases when you delete the last title.

Cannot edit.

- You may not be able to edit on the HDD if there is no available space.
Delete any unwanted titles to create empty space. (⇒ 25)

Cannot format.

- The disc is dirty. Wipe with a damp cloth and then wipe dry. (⇒ 15)
- Disc may be defective or of poor quality.
- You tried formatting a disc that you may not be able to use in this unit. (⇒ 10)

Cannot create chapters. Cannot mark the start point or the end point during "Partial Delete" operation.

- The unit writes the chapter division information to the disc when you turn it off or remove the disc.
- These operations are not possible with still pictures.
- You cannot set points if they are too close to each other. You cannot set an end point before a start point.

Cannot delete chapters.

- **HDD BD-RE BD-R RAM** When the chapter is too short to delete, use "Combine Chapters" to make the chapter longer. (⇒ 51)

Cannot create a playlist.

- Creation or editing of playlists cannot be done on this unit.

Still pictures

Cannot display Picture View screen.

- This screen cannot be displayed during recording or copy.

Cannot edit or format a card.

- Release the card's protection setting. (⇒ 11)

The contents of the card cannot be read.

- Remove the card from the slot and then insert again. If this does not solve the problem, turn off and turn on the unit again.
- The card format is not compatible with the unit. (The contents on the card may be damaged.) (⇒ 11)
- This unit is compatible with SD Memory Cards that meet SD Card Specifications FAT12 and FAT16 formats, as well as SDHC Memory Cards in FAT32 format.
- The card contains a folder structure and/or file extensions that are not compatible with this unit. (⇒ 117)
- You can use SD Memory Cards with capacities from 8 MB to 2 GB and SDHC Memory Cards with capacities from 4 GB to 32 GB.

Copying, deleting and setting protection takes a long time.

- When there are a lot of folders and files, it may sometimes take a few hours.
- When repeating copying or deleting, it may sometimes take a long time. Format the disc or card. (⇒ 85)

Still pictures (JPEG) do not playback normally.

- The images that were edited on the PC, such as Progressive JPEG, etc., may not play back. (⇒ 116)

Music

Tracks could not be copied to the HDD.

- If there are copyright protected tracks such as SCMS restrictions, they will not be copied.
- Recording from CDs that do not conform to CD-DA specifications (copy control CDs, etc.) cannot be guaranteed.
- Bonus tracks may not be copied.

Title of the newly released CD cannot be acquired.

- Title cannot be acquired if the title is not registered in the built-in Gracenote® database. Connection to the network is necessary to acquire title for the newly released CD. (⇒ 103)

ID3 tag of a MP3 file is not completely displayed.

- Only the track name and artist name can be displayed with this unit.

USB

The contents of the USB memory cannot be read.

- Remove the USB memory from the USB port and then insert again. If this does not solve the problem, turn off and turn on the unit again.
- Check that the USB memory is inserted correctly. (⇒ 15)
- The format of the USB memory or of its contents is not compatible with the unit. (The contents on the USB memory may be damaged.) (⇒ 11)
- The USB memory contains a folder structure and/or file extensions that are not compatible with this unit. (⇒ 117)
- USB memories connected using a USB extension cable or a USB hub may not be recognized by this unit.
- Some USB memories cannot be used with this unit. (⇒ 11)
- If inserted during playback, recording or copying etc., the USB memory may not be recognized by this unit.
- You can use USB memories with capacities up to 128 GB.

USB memory cannot be operated.

- Turn the power of this unit off once, and turn it back on. If it cannot be operated after that, set "VIERA Link" to "Off" and turn the power of this unit off again, and turn it back on. (⇒ 93)

TV Guide

The TV Guide System does not receive any data.

- Check whether the clock is properly set. (⇒ 95)
- If signal quality is bad (ghost images or limited reception), the TV Guide system may not be able to receive any data.

The empty field is displayed for some or all stations.

- Some stations are not supported by the TV Guide system.
- Programme the Timer recording manually. (⇒ 35)

The TV Guide information is not displayed properly.

- There was a programme change, or TV Guide information from a broadband cast station was possibly not correctly transmitted. Check the current programme, e.g. on the Web site for the TV Guide system provider or station provider.

The TV Guide data transfer was interrupted.

- The TV Guide system shows the data that was received up to the interruption.
- The programme information may be incomplete.

The TV Guide data is not updated.

- Make sure that the time is set correctly. (⇒ 95)

Digital broadcast

Digital broadcasts cannot be received.

- The dish may not be pointing in the direction of the satellite, or the direction of the dish may have changed due to strong winds or vibration. If problem persists consult your local TV aerial installer.
- Reception may be disturbed in bad weather.
- To record an encrypted broadcast, a CAM (Conditional Access Module) with Smart Card valid for the broadcast is required.

TV reception worsens after connecting the unit.

- This can occur because the signals are being divided between the unit and other equipment. It can be solved by using a signal booster, available from electronics retailers.

The digital channel information does not appear.

- Select the length of time (3–10 sec.) in the "On-Screen Messages" in the Setup menu. (⇒ 92)
- The digital satellite channel information will not appear during playback.

Picture regularly breaks up on some channels. “No signal” message is displayed.

- Check aerial connection.
- Check that the satellite dish and satellite cable are designed for DVB.
- Check “Signal Condition”. If “Signal Quality” or “Signal Strength” are displayed in red or constantly changing, check aerial. If problem persists consult your local TV aerial installer. (⇒ 88)
- Interference (known as impulse noise) from household appliances such as light switches, fridges etc. may cause picture break up and/or audio distortion. Use a high quality quad shielded coaxial cable fly lead between this unit and antenna wall socket to minimise impulse noise pickup. If problem persists consult your local TV aerial installer.
- Check the reception capacity of the satellite dish. The dish must be large enough for good reception. There must not be any hindrances in the way which could impair reception, e.g. twigs, leaves, snow.
- Adjust the aerial reception with “Manual Tuning” in the Setup menu. (⇒ 88)
- The receiver (LNB) of the satellite dish must be suitable for digital reception.

Picture very infrequently breaks up on some or all channels.

- Electrical atmospheric interference caused by local or distant lighting storms or heavy rain with wind in “leafy” locations may cause pictures to break up and audio to mute or distort momentarily.
- Impulse noise interference from an infrequently used electrical appliance, or a passing vehicle or lawn mower with a “noisy” ignition system.
- The reception capacity of the satellite dish is not sufficient.

After the Auto-setup, there aren’t any stations in the station list.

- “Shipping Condition” was performed or the unit was in the delivery status. The Auto-setup was then started and interrupted.
Do an Auto-setup again and let it continue right through to the end. The data is only saved after this has been completed.

VIERA Link

VIERA Link doesn’t work.

- Check the HDMI cable connection. Check that “HDMI” is displayed on the front display when the power for the main unit is set to On.
- Make sure that “VIERA Link” is set to “On”. (⇒ 93)
- Check the “HDAVI Control” settings on the connected device.
- Some functions may not work if depending on the version of “HDAVI Control” of the connected equipment. This unit supports “HDAVI Control 4” functions.
- If the connection for the equipment connected with HDMI was changed, or if there was a power failure or the plug was removed from the household mains socket, “HDAVI Control” may not work.
In this case, perform the following operations.
 - 1 When the HDMI cable is connected to all equipment with the power on, turn the TV (VIERA) on again.
 - 2 Change the TV (VIERA) settings for the “HDAVI Control” function to off, and then set to on again. (For more information, see the VIERA operating instructions.)
 - 3 Switch the VIERA input to HDMI connection with this unit, and after this unit’s screen is displayed check that “HDAVI Control” is working.

The Control Panel does not appear.

- The Control Panel is only displayed when connected to a TV with “HDAVI Control 2” or later function. (⇒ 77)

The operation on this unit (music playback etc.) is interrupted.

- The operation on this unit may be interrupted when you press buttons on the TV remote control that do not work for VIERA Link functions.

To reset this unit

To return all the settings other than the main ones to the factory preset

- Select “Yes” in “Shipping Condition” in the Setup menu. All the settings except for the ratings level and ratings PIN, etc. return to the factory preset. The timer recording programmes are also cancelled. (⇒ 95)
- Select “Yes” in “Default Settings” in the Setup menu. All the settings other than the tuning settings, clock settings, language settings, disc language settings, ratings level, ratings PIN, remote control code, network settings, etc. return to the factory presets. (⇒ 95)
- Press and hold [v CH] and [CH ^] on the main unit until the Auto Setup screen appears. All the settings except for the ratings level, ratings PIN and clock settings, etc. return to the factory preset. The timer recording programmes are also cancelled.

To reset the ratings level settings

- While the disc tray is open, press [DRIVE SELECT] to select the BD drive, then press and hold [● REC] and [▶] (PLAY) on the main unit at the same time for 5 or more seconds.

To restore the unit if it freezes due to one of the safety devices being activated

- Press and hold [⏻/|] on the main unit for 3 seconds. (The settings remain.)

Network

I can’t connect to the network.

- Has the LAN cable become unplugged? Check that the LAN cable is properly connected. (⇒ 103)
- Have you plugged in a modular cable for use with a telephone into the LAN terminal on this unit? Connect with a straight LAN cable. (⇒ 103)
- Is the power for the modem or broadband router turned on? Turn the power on for each device.
- Is there a mistake in the network settings? Follow any instructions you may have received from your ISP (Internet Service Provider) and make changes to the settings.
- Are the broadband router settings correct? Read the operating instructions for the broadband router.
- Is the broadband router and/or modem correctly connected? Check the operating instructions for each device and connect accordingly.

While using my PC, I cannot connect to the network.

- Does your Internet Service Provider (ISP) or service contract prevent multiple terminals connecting at the same time? Check the content of your contract.

Other

After performing an update, you can no longer receive broadcasts.

- Depending on the content of the update, some settings may have returned to the preset values. Fix the settings again.

Cannot set “On” in “BD-Video 24p Output”.

- Only when the unit is connected to the HDMI terminal of a TV supporting 24p you can select “On”. In some cases where the unit is connected to a TV via an amplifier/receiver through the HDMI terminals, you may not be able to select “On”. In this case, connect the unit to a TV through the HDMI terminal and connect it to the amplifier/receiver through any terminal other than HDMI.

Pause Live TV stops.

- Pause Live TV from AV1, AV2 or AV3 input stops when a timer recording from external input started.

Specifications

Recording system

BD-RE (SL/DL):	Blu-ray Disc Rewritable Format
BD-R (SL/DL):	Blu-ray Disc Recordable Format
DVD-RAM:	DVD Video Recording format
DVD-R:	DVD-Video format
DVD-R DL (Dual Layer):	DVD-Video format
DVD-RW:	DVD-Video format
+R	
+R DL (Double Layer)	
+RW	

Recordable discs

BD-RE (SL/DL):	1-2X SPEED (Ver. 2.1)
BD-R (SL/DL):	1-4X SPEED (Ver. 1.1), 1-4X SPEED (Ver. 1.2), 1-6X SPEED (Ver. 1.3)
DVD-RAM:	1-2X SPEED LTH type (Ver. 1.2), 2X SPEED (Ver. 2.0), 2-3X SPEED (Ver. 2.1), 2-5X SPEED (Ver. 2.2)
DVD-R (SL):	1X SPEED (Ver. 2.0), 1-4X SPEED (Ver. 2.0), 1-8X SPEED (Ver. 2.0), 1-16X SPEED (Ver. 2.1)
DVD-R (DL):	2-4X SPEED (Ver. 3.0), 2-8X SPEED (Ver. 3.0)
DVD-RW:	1X SPEED (Ver. 1.1), 1-2X SPEED (Ver. 1.1), 2-4X SPEED (Ver. 1.2), 2-6X SPEED (Ver. 1.2)
+R (SL):	2.4X SPEED (Ver. 1.0), 2.4-4X SPEED (Ver. 1.1), 2.4-8X SPEED (Ver. 1.2), 2.4-16X SPEED (Ver. 1.3)
+R (DL):	2.4X SPEED (Ver. 1.0), 2.4-8X SPEED (Ver. 1.1)
+RW:	2.4X SPEED (Ver. 1.1), 2.4-4X SPEED (Ver. 1.2)

Playable discs

BD-RE (SL/DL):	BD-RE Ver. 2.1 conforming, JPEG
BD-R (SL/DL):	BD-R LTH TYPE Ver. 1.2 conforming, BD-R Ver. 1.3 conforming
BD-Video	
DVD-RAM*1:	DVD Video Recording format, AVCHD format, JPEG
DVD-R:	DVD-Video format*2, AVCHD format*2, MP3*2,3, JPEG*2,3, DivX*2,3
DVD-R DL (Dual Layer):	DVD-Video format*2, AVCHD format*2, MP3*2,3, JPEG*2,3, DivX*2,3
DVD-RW:	DVD-Video format*2, DVD Video Recording format, AVCHD format*2
+R*2, +R DL (Double Layer)*2, +RW	
DVD-Video, CD-Audio (CD-DA)	
CD-R/CD-RW:	CD-DA*2, MP3*2,3, JPEG*2,3, DivX*2,3

Optical pick-up

System with 2 lens, 3 integration units
(405 nm wavelength for BDs,
661 nm wavelength for DVDs, 783 nm wavelength for CDs)

LASER specification

Class 1 LASER Product

Wave length:

CD	783 nm wave length
DVD	661 nm wave length
BD	405 nm wave length

Laser power:

No hazardous radiation is emitted with the safety protection

Video

Video system:	PAL/NTSC
Recording system:	MPEG2 (Hybrid VBR)/MPEG-4 AVC/H.264
Video in (PAL/NTSC):	AV1/AV2 (21 pin), AV3 (pin jack) 1 Vp-p 75 Ω, termination
S-Video in (PAL/NTSC):	AV2 (21 pin) 1 Vp-p 75 Ω, termination
RGB in (PAL):	AV2 (21 pin), 0.7 Vp-p 75 Ω, termination
Video out (PAL/NTSC):	AV1/AV2 (21 pin), Video Out (pin jack) 1 Vp-p 75 Ω, termination
S-Video out (PAL/NTSC):	AV1 (21 pin) 1 Vp-p 75 Ω, termination
RGB out (PAL/NTSC):	AV1 (21 pin) 0.7 Vp-p (PAL) 75 Ω, termination
Component video output	
(PAL 576i/576p/720p/1080i, NTSC 480i/480p/720p/1080i)	
	Y: 1.0 Vp-p 75 Ω, termination
	P _B : 0.7 Vp-p 75 Ω, termination
	P _R : 0.7 Vp-p 75 Ω, termination

Audio

Recording system:	Dolby Digital 2ch (XP, SP, LP, EP, FR mode), Linear PCM (XP mode), Dolby Digital Max 5.1ch (DVB-S/S2) (DR, HG, HX, HE, HL mode), Dolby Digital Plus Max 5.1ch (DVB-S/S2) (DR mode), MPEG 2ch (DR mode)
Audio in:	AV1/AV2 (21 pin), AV3 (pin jack)
Input level:	Standard: 0.5 Vrms, Full scale: 2.0 Vrms at 1 kHz
Input impedance:	More than 10 kΩ
Audio out:	AV1/AV2 (21 pin), Audio Out (pin jack)
Output level:	Standard: 0.5 Vrms, Full scale: 2.0 Vrms at 1 kHz
Output impedance:	Less than 1 kΩ
Digital audio out:	Optical terminal (PCM, Dolby Digital, DTS, MPEG), Coaxial terminal (PCM, Dolby Digital, DTS, MPEG), HDMI terminal (PCM, Dolby Digital, DTS, MPEG, Dolby Digital Plus, Dolby TrueHD, DTS-HD Master Audio, DTS-HD High Resolution Audio)

HDMI Output

19 pin type A: 1 pc
HDMI™ (V.1.3a with Deep Colour, x.v.Colour™, High Bit Rate Audio)
● This unit supports "HDAVI Control 4" function.

Internal HDD capacity

BS850 500 GB

BS750 250 GB

DV Input

IEEE 1394 Standard, 4 pin: 1 pc

USB Port

Type A: 1 pc

SD Card Slot

1 pc

LAN (Ethernet) Port

10BASE-T/100BASE-TX

CI (Common Interface) Slot

EN 50221 Standard,
2 slot Type I and II PC Card (5 V only) rear side

Television system

Tuner System:	DVB-S/S2
Antenna receive frequency:	950 MHz to 2150 MHz
Input level:	-65 dBm to -25 dBm
Input impedance:	Nominal 75 Ω
Demodulation:	QPSK, 8PSK
LNB input:	F shape terminal female, power supply 13 V/18 V max. 400 mA
LNB output:	Not provided
RF converter output:	Not provided
DiSEqC:	Version 1.0 or Tone burst A/B, 22 kHz 0.65 Vp-p

Others

Region code:

DVD: #2

BD: Region B

Operating temperature: 5 °C to 40 °C

Operating humidity range: 10 % to 80 % RH (no condensation)

Power supply: AC 220 to 240 V, 50 Hz

Power consumption: **BS850** Approx. 65 W

BS750 Approx. 64 W

Dimensions (W×H×D):

BS850

430 mm×66 mm×239 mm (excluding the projecting parts)

430 mm×66 mm×259 mm (including the projecting parts)

BS750

430 mm×59 mm×239 mm (excluding the projecting parts)

430 mm×59 mm×259 mm (including the projecting parts)

Mass:

BS850 Approx. 3.3 kg

BS750 Approx. 3.2 kg

Power consumption in standby mode:

Approx. 0.3 W ("Power Save" is set to "On")

Approx. 7 W ("Power Save" is set to "Off")

SD Card

Slot: SD Memory Card slot: 1 pc
 Compatible media: SD Memory Card*4, SDHC Memory Card
 Format: FAT12, FAT16*5 (In case of SD Memory Card)
 FAT32*5 (In case of SDHC Memory Card)
 Data that can be played: JPEG, SD (Standard Definition)-Video*6,
 HD (High Definition)-Video

USB device

USB standard: USB 2.0 High Speed
 Format: FAT16, FAT32
 Data that can be played: MP3, JPEG, DivX,
 SD (Standard Definition)-Video*7, HD (High Definition)-Video*8

DivX

Playable media	-R -R DL CD USB
File format	DivX ● Files must have the extension ".DIVX", ".divx", ".AVI" or ".avi". 
Number of folders	Maximum number of folders recognizable : 300 folders (including the root folder)
Number of files	Maximum number of files recognizable: 200 files
Support version	Certified to the DivX Home Theater Profile. GMC (Global Motion Compensation) is not supported. DivX, DivX Certified, and associated logos are trademarks of DivX, Inc. and are used under license. Video – Number of stream: Up to 1 – Codec: DIV3, DIV4, DIVX, DV50 – Picture size: 32×32 to 720×576 – FPS (Frame Per Second): Up to 30 fps Audio – Number of stream: Up to 8 – Format: MP3, MPEG, Dolby Digital – Multi channel: Dolby Digital is possible. MPEG multi is 2 ch conversion.

SD (Standard Definition)-Video

Playable media	SD *6 USB *7
Codec	MPEG2
File Format	SD-Video format*9 used on Standard Definition Camera (Panasonic and some other's)

HD (High Definition)-Video

Playable media	SD USB *8
Codec	MPEG-4 AVC/H.264
File Format	AVCHD format conforming

MP3

Playable media	HDD -R -R DL CD USB
File format	MP3 ● Files must have the extension ".mp3" or ".MP3".
Number of folders	Maximum number of folders recognizable (except for HDD): 300 folders (including the root folder)
Number of files (tracks)	Maximum number of files recognizable (except for HDD): 3000 files
Bit rates	32 kbps to 320 kbps
Sampling frequency	16 kHz/22.05 kHz/24 kHz/32 kHz/44.1 kHz/48 kHz
ID3 tags	compatible

● If there is a large amount of still picture data etc. within a MP3 file, play may not be possible.

JPEG

Playable media	HDD BD-RE RAM -R -R DL CD USB SD
File format	JPEG conforming DCF (Design rule for Camera File system)*10 ● Files must have the extension ".jpg" or ".JPG".
Number of pixels	Between 34×34 and 8192×8192 pixels (Sub sampling is 4:2:2 or 4:2:0)
Thawing Time	Approx. 2 sec. in case of SD card (8.1 M pixels, JPEG)
Number of folders	CD Maximum number of folders recognizable: 99 folders (including the root folder) HDD BD-RE RAM -R -R DL USB SD Maximum number of folders recognizable: 300 folders (including the root folder)
Number of files	CD Maximum number of files recognizable: 999 files RAM -R -R DL USB SD Maximum number of files recognizable: 3000 files HDD BD-RE Maximum number of files recognizable: 9999 files
MOTION JPEG PROGRESSIVE JPEG	Not supported

- It may take a few moments for still pictures to display.
- When there are many files and/or folders, some files may not display or be playable.

-R -R DL CD

- Operation may take time to complete when there are many files (tracks) and/or folders and some files (tracks) may not display or be playable.
- English alphabet and Arabic numerals are displayed correctly. Other characters may not be displayed correctly.
- The display order on this unit may differ from how the order is displayed on a computer.
- Depending on how you create the disc (writing software), files (tracks) and folders may not play in the order you numbered them.
- Depending on the recording conditions, the disc may not play.

Note

- Specifications are subject to change without notice.
- Useable capacity will be less. (SD card)
- *1 Remove the disc from cartridge case (TYPE1 cannot be used).
- *2 Finalising is necessary for compatible playback.
- *3 ISO9660 level 1 or 2 (except for extended formats) and Joliet This unit is compatible with multi-session/border (except for DVD-R DL). This unit is not compatible with packet-write format.
- *4 Includes miniSD cards. (A miniSD adaptor needs to be inserted.) Includes microSD cards. (A microSD adaptor needs to be inserted.)
- *5 Long file name is unsupported.
- *6 Video Recording conversion and transfer is possible from SD card to HDD or DVD-RAM disc. After Video Recording conversion and transfer to HDD or DVD-RAM disc is completed, the playback becomes possible.
- *7 Video Recording conversion and transfer is possible from USB device to HDD or DVD-RAM disc. After Video Recording conversion and transfer to HDD or DVD-RAM disc is completed, the playback becomes possible.
- *8 Video Recording conversion and transfer is possible from USB device to HDD, BD-RE (SL/DL) or BD-R (SL/DL) disc. After Video Recording conversion and transfer to HDD, BD-RE (SL/DL) or BD-R (SL/DL) disc is completed, the playback becomes possible.
- *9 SD-Video Entertainment Video Profile
- *10 Design rule for Camera File system: unified standard established by Japan Electronics and Information Technology Industries Association (JEITA).

■ Structure of folders displayed by this unit

You can play DivX, MP3 and still pictures (JPEG) on this unit by making folders as shown below. However depending on the method of writing data (writing software), play may not be in the order you numbered the folders.

-R -R DL CD USB Structure of MP3, still picture or DivX folders

Prefix with 3-digit numbers in the order you want to play them.

MP3

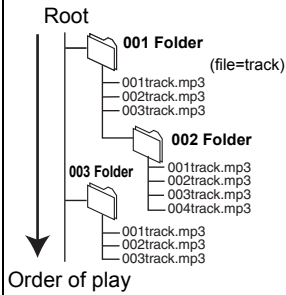

Files inside a folder are displayed in the order they were updated or taken.

Still picture

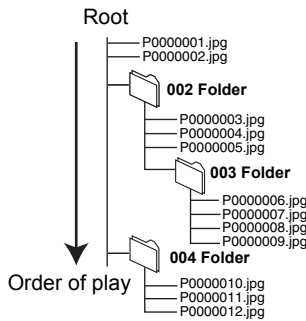

DivX

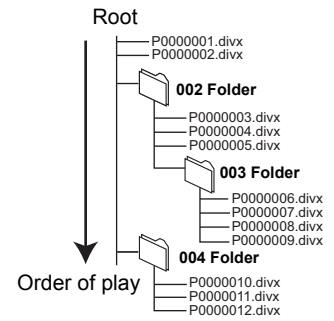

BD-RE RAM

***: Numbers XXX: Letters

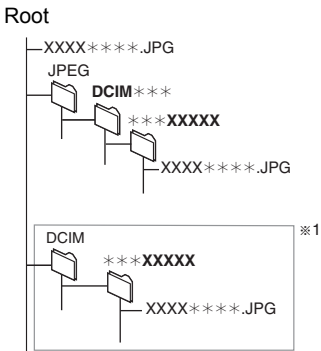

- *1 Folders can be created on other equipment. However, these folders cannot be selected as a copying destination.
- If a folder name or file name has been input using other equipment, the name may not be displayed properly or you may not be able to play or edit the data.

SD

***: Numbers XXX: Letters

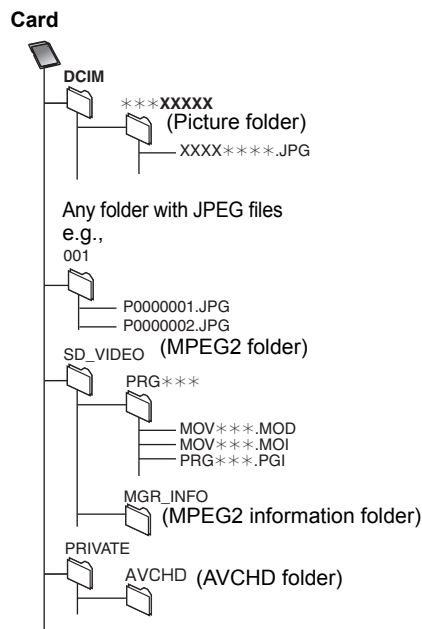

AVCHD

AVCHD is a new format (standard) for high definition video cameras that can be used to record and play high-resolution HD images.

BD-J

Some BD-Video discs contain Java applications, and these applications are called BD-J. You can enjoy various interactive features in addition to playing normal video.

Bitstream

This is the digital form of multi-channel audio data (e.g., 5.1 channel) before it is decoded into its various channels.

BONUSVIEW

With the new play function of the BD-Video, you can enjoy the secondary video recorded on the disc, in addition to the main movie.

CI (Common Interface)

Common Interface is a defined standard, to enable the addition of a CAM (Conditional Access Module) in a Digital TV/Recorder.

CI Plus

CI Plus is a technical specification that adds additional security and features to the proven DVB Common Interface Standard that will allow CI Plus compatible consumer electronics devices, such as Integrated Digital Televisions and Set Top Boxes, access to a wide range of Pay TV Services via a Plug-in CI Plus CAM wherever the CI Plus Technology is supported by the local Pay TV Provider.

CPRM (Content Protection for Recordable Media)

CPRM is technology used to protect broadcasts that are allowed to be recorded only once. Such broadcasts can be recorded only with CPRM compatible recorders and discs.

Decoder

A decoder restores the coded audio signals on discs to normal. This is called decoding.

Deep Colour

This unit incorporates HDMI™ (V.1.3a with Deep Colour) technology that can reproduce greater colour gradation (4096 steps) when connected to a compatible TV.

You can enjoy exceptionally rich, natural-looking colours, with smooth, detailed gradation and minimal colour banding. [A lower colour gradation (256 steps), without Deep Colour, will be reproduced if connected to a TV which does not support Deep Colour. The unit will automatically set appropriate output to suit the connected TV.]

DiSEqC (Digital Satellite Equipment Control)

Digital Satellite Equipment Control is a control system for selecting several LNBS at one input.

DivX

DivX is a popular media technology created by DivX, Inc. DivX media files contain highly compressed video with high visual quality that maintains a relatively small file size.

DLNA (Digital Living Network Alliance)

DLNA is a standard that makes DLNA Certified digital electronics easier and more convenient to use on a home network.

DNS Server

A server which acts like a telephone directory and translates Internet domain names into IP addresses.

Dolby Digital

This is a method of coding digital signals developed by Dolby Laboratories. Apart from stereo (2-channel) audio, these signals can also be multi-channel audio.

Dolby Digital Plus

Multi-channel audio and higher audio quality is made possible using Dolby Digital Plus. BD-Video supports up to 7.1 channel output.

Dolby TrueHD

Dolby TrueHD is a very high quality audio format that reproduces the studio master audio. BD-Video supports up to 7.1 channel output.

Down-mixing

This is the process of remixing the multi-channel audio found on some discs into fewer channels.

DTS (Digital Theater Systems)

This surround system is used in many movie theaters. There is good separation between the channels, so realistic sound effects are possible.

DTS-HD

DTS-HD is a high-quality, sophisticated audio format used in movie theaters. Previous DTS Digital Surround-compatible equipment can play DTS-HD as DTS Digital Surround audio. BD-Video supports up to 7.1 channel output.

Dynamic range

Dynamic range is the difference between the lowest level of sound that can be heard above the noise of the equipment and the highest level of sound before distortion occurs.

Dynamic range compression means reducing the gap between the loudest and softest sounds. This means you can listen at low volumes but still hear dialogue clearly.

Film and video

DVD-Videos are recorded using either film or video. This unit can determine which type has been used, then uses the most suitable method of progressive output.

Film: Recorded at 25 frames per second (PAL discs) or 24 frames per second (NTSC discs). (NTSC discs recorded at 30 frames per second as well.)

Video: Recorded at 25 frames/50 fields per second. (PAL discs) or 30 frames/60 fields per second (NTSC discs). Generally appropriate for motion picture films. Generally appropriate for TV drama programmes or animation.

Finalise

A process that makes play of a recorded CD-R, CD-RW, DVD-R, etc. possible on equipment that can play such media. You can finalise BD-R, DVD-R, DVD-R DL, DVD-RW (DVD-Video format), +R, +R DL on this unit.

After finalising, the disc becomes play-only and you can no longer record or edit. However, finalised DVD-RW can be formatted for recording again.

Formatting

Formatting is the process of making media such as DVD-RAM recordable on recording equipment.

You can format BD-RE, DVD-RAM, DVD-RW (only as DVD-Video format), +RW, SD cards and the HDD or unused BD-R, +R and +R DL on this unit.

Formatting permanently deletes all contents.

Frames and fields

Frames refer to the single images that constitute the video you see on your television. Each frame consists of two fields.

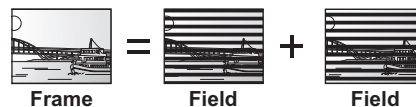

- A frame still shows two fields, so there may be some blurring, but picture quality is generally better.
- A field still shows less picture information so it may be rougher, but there is no blurring.

Gateway

IP address of the electronic device providing Internet access. Usually called a router IP address. (e.g., 192.168.0.1)

HDD (Hard disk drive)

This is a mass data storage device used in computers, etc. A disk with a surface that has been treated with magnetic fluid is spun and a magnetic head is brought in close proximity to facilitate the reading and writing of large amounts of data at high speed.

HDMI (High-Definition Multimedia Interface)

Unlike conventional connections, it transmits uncompressed digital video and audio signals on a single cable. This unit supports high-definition video output [720p (750p), 1080i (1125i), 1080p (1125p)] from HDMI AV OUT terminals. To enjoy high-definition video a high definition compatible television is required.

IP address

A set of numbers which distinguish each PC on the network when, for example, connected to the Internet. When using a PC in a LAN to access a PC or device that is not included in the LAN, the IP address is called the local IP address. (e.g., 192.168.0.10)

JPEG (Joint Photographic Experts Group)

This is a system used for compressing/decoding colour still pictures. If you select JPEG as the storage system on digital cameras, etc., the data will be compressed to 1/10–1/100 of its original size. The benefit of JPEG is less deterioration in picture quality considering the degree of compression.

LAN (Local Area Network)

A group of linked devices in a company, school or home. Indicates the boundaries of a particular network.

LNB (Low Noise Block - converter)

This is attached to the satellite dish, which will amplify the weak signal that was received, lower the frequency, and input into the tuner.

Local storage

This storage area is used as a destination for sub contents for playing virtual packages on BD-Video.

LPCM (Linear PCM)

These are uncompressed digital signals, similar to those found on CDs.

MPEG2 (Moving Picture Experts Group)

A standard for efficiently compressing and expanding colour video. MPEG2 is a compression standard used for DVD and satellite based digital broadcasting.

MPEG-4 AVC/H.264

A standard for efficiently compressing and expanding colour video. MPEG-4 AVC/H.264 is an encoding method used for recording of the high definition videos.

MP3 (MPEG Audio Layer 3)

An audio compression method that compresses audio to approximately one tenth of its size without any considerable loss of audio quality.

Pan&Scan/Letterbox

In general, BD-Video and DVD-Video are produced with the intention that they be viewed on a widescreen television (16:9 aspect ratio), so images often don't fit regular (4:3 aspect ratio) televisions. Two styles of picture, "Pan & Scan" and "Letterbox", deal with this problem.

Pan & Scan: The sides are cut off so the picture fills the screen.



Letterbox: Black bands appear at the top and bottom of the picture so the picture itself appears in an aspect ratio of 16:9.



Progressive/Interlace

Interlace is a conventional image signal that displays the image in 2 phases by splitting the display into odd and even scans. Progressive will display whole image in 1 scan. Therefore, it will give high definition image without flickering compared with interlace.

Protection

You can prevent accidental deletion by setting writing protection or deletion protection.

RGB

This refers to the three primary colours of light, red (R), green (G), and blue (B) and also the method of producing video that uses them. By dividing the video signal into the three colours for transmission, noise is reduced for even higher quality images.

Router

Distinguishes the IP address assigned to each device, such as the PC, and relays the flow of data within the network.

Sampling frequency

Sampling is the process of converting the heights of sound wave (analog signal) samples taken at set periods into digits (digital encoding). Sampling frequency is the number of samples taken per second, so larger numbers mean more faithful reproduction of the original sound.

Signal Quality

This is the guide for checking the aerial direction. The numbered values displayed do not indicate the strength of the signal, but the quality of the signal (the signal to noise ratio, or "S/N"). The channels you can receive are affected by weather conditions, seasons, time (day/night), region, length of the cable that is connected to the aerial, etc.

Subnet mask

Enables efficient network use. A set of numbers which identify which part of the IP address allocated to every device connected to the router is the network portion.

Thumbnail

This refers to a miniature representation of a picture used to display multiple pictures in the form of a list.

Transponder

The signals of a broadcasting station are received by a transponder on a satellite. The transponder converts them to frequencies and sends them to satellite dishes near the ground. A transponder can broadcast several TV and radio programmes or data in parallel.

x.v.Colour™

x.v.Colour™ is a name for devices that are compatible with the xvYCC format, an international standard for expanded colour in motion pictures, and that follow the rules for signal transmission. You can enjoy vivid colours of wider colour ranges for a more realistic picture when connected to a TV that supports the x.v.Colour™ with HDMI cable.

1080i

In one high definition image, 1080 (1125) alternating scan lines pass every 1/50th of a second to create an interlace image. Because 1080i (1125i) more than doubles current television broadcasts of 480i (525i), the detail is much clearer and creates a more realistic and rich image.

1080p

In one high definition image, 1080 (1125) scan lines pass at the same time every 1/50th of a second to create a progressive image. Since progressive video does not alternate scan lines like interlace, there is a minimal amount of screen flicker.

24p

This is a progressive image recorded at a rate of 24 frames per second.

720p

In one high definition image, 720 (750) scan lines pass at the same time every 1/50th of a second to create a progressive image. Since progressive video does not alternate scan lines like interlace, there is a minimal amount of screen flicker.

Safety precautions

Placement

Set the unit up on an even surface away from direct sunlight, high temperatures, high humidity, and excessive vibration. These conditions can damage the cabinet and other components, thereby shortening the unit's service life.

Do not place heavy items on the unit.

Voltage

Do not use high voltage power sources. This can overload the unit and cause a fire.

Do not use a DC power source. Check the source carefully when setting the unit up on a ship or other place where DC is used.

AC mains lead protection

Ensure the AC mains lead is connected correctly and not damaged. Poor connection and lead damage can cause fire or electric shock. Do not pull, bend, or place heavy items on the lead.

Grasp the plug firmly when unplugging the lead. Pulling the AC mains lead can cause electric shock.

Do not handle the plug with wet hands. This can cause electric shock.

Foreign matter

Do not let metal objects fall inside the unit. This can cause electric shock or malfunction.

Do not let liquids get into the unit. This can cause electric shock or malfunction. If this occurs, immediately disconnect the unit from the power supply and contact your dealer.

Do not spray insecticides onto or into the unit. They contain flammable gases which can ignite if sprayed into the unit.

Service

Do not attempt to repair this unit by yourself. If sound is interrupted, indicators fail to light, smoke appears, or any other problem that is not covered in these instructions occurs, disconnect the AC mains lead and contact your dealer or an authorized service centre. Electric shock or damage to the unit can occur if the unit is repaired, disassembled or reconstructed by unqualified persons.

Extend operating life by disconnecting the unit from the power source if it is not to be used for a long time.

Java and all Java-based trademarks and logos are trademarks or registered trademarks of Sun Microsystems, Inc. in the United States and other countries.

Manufactured under license from Dolby Laboratories. Dolby and the double-D symbol are trademarks of Dolby Laboratories.

Manufactured under license under U.S. Patent #'s: 5,451,942; 5,956,674; 5,974,380; 5,978,762; 6,226,616; 6,487,535; 7,392,195; 7,272,567; 7,333,929; 7,212,872 & other U.S. and worldwide patents issued & pending. DTS and the Symbol are registered trademarks, & DTS-HD, DTS-HD Master Audio | Essential and the DTS logos are trademarks of DTS, Inc. Product includes software. © DTS, Inc. All Rights Reserved.

This product incorporates copyright protection technology that is protected by U.S. patents and other intellectual property rights. Use of this copyright protection technology must be authorized by Macrovision, and is intended for home and other limited viewing uses only unless otherwise authorized by Macrovision. Reverse engineering or disassembly is prohibited.

SDHC Logo is a trademark of SD-3C, LLC.

HDMI, the HDMI Logo, and High-Definition Multimedia Interface are trademarks or registered trademarks of HDMI Licensing LLC in the United States and other countries.

This product is licensed under the AVC patent portfolio license and VC-1 patent portfolio license for the personal and non-commercial use of a consumer to (i) encode video in compliance with the AVC Standard and VC-1 Standard ("AVC/VC-1 Video") and/or (ii) decode AVC/VC-1 Video that was encoded by a consumer engaged in a personal and non-commercial activity and/or was obtained from a video provider licensed to provide AVC/VC-1 Video. No license is granted or shall be implied for any other use. Additional information may be obtained from MPEG LA, LLC. See <http://www.mpegla.com>.

"AVCHD" and the "AVCHD" logo are trademarks of Panasonic Corporation and Sony Corporation.

HDAVI Control™ is a trademark of Panasonic Corporation.

"Blu-ray Disc" is trademark.

"BONUSVIEW" is trademark of Blu-ray Disc Association.

"BD-LIVE" logo is trademark of Blu-ray Disc Association.

DiSEqC™ is a trademark of EUTELSAT.

Plays DivX® video
DivX® is a registered trademark of DivX, Inc., and is used under license.

x.v.Colour™ is a trademark.

VIERA CAST™ is a trademark of Panasonic Corporation.

YouTube and Picasa are trademarks of Google, Inc.

The "CI Plus" Logo is a trademark of CI Plus LLP.

DLNA®, the DLNA Logo and DLNA CERTIFIED™ are trademarks, service marks, or certification marks of the Digital Living Network Alliance.

This product incorporates the following software:
(1) the software developed independently by or for Panasonic Corporation,
(2) the software owned by third party and licensed to Panasonic Corporation,
(3) the software licensed under the GNU General Public License, Version 2 (GPL v2),
(4) the software licensed under the GNU LESSER General Public License, Version 2.1 (LGPL v2.1) and/or,
(5) open sourced software other than the software licensed under the GPL v2 and/or LGPL v2.1
For the software categorized as (3) and (4), please refer to the terms and conditions of GPL v2 and LGPL v2.1, as the case may be at
<http://www.gnu.org/licenses/old-licenses/gpl-2.0.html> and
<http://www.gnu.org/licenses/old-licenses/lgpl-2.1.html>.
In addition, the software categorized as (3) and (4) are copyrighted by several individuals. Please refer to the copyright notice of those individuals at
<http://www.am-linux.jp/dl/JPRCBW93>

The GPL/LGPL software is distributed in the hope that it will be useful, but WITHOUT ANY WARRANTY, without even the implied warranty of MERCHANTABILITY or FITNESS FOR A PARTICULAR PURPOSE.

At least three (3) years from delivery of products, Panasonic will give to any third party who contact us at the contact information provided below, for a charge no more than our cost of physically performing source code distribution, a complete machine-readable copy of the corresponding source code covered under GPL v2/LGPL v2.1.

Contact Information
cdrequest@am-linux.jp

Source code is also freely available to you and any other member of the public via our website below.
<http://www.am-linux.jp/dl/JPRCBW93>

The recording and playback of content on this or any other device may require permission from the owner of the copyright or other such rights in that content. Panasonic has no authority to and does not grant you that permission and explicitly disclaims any right, ability or intention to obtain such permission on your behalf. It is your responsibility to ensure that your use of this or any other device complies with applicable copyright legislation in your country. Please refer to that legislation for more information on the relevant laws and regulations involved or contact the owner of the rights in the content you wish to record or playback.

Gracenote® Corporate Description
Music recognition technology and related data are provided by Gracenote®. Gracenote is the industry standard in music recognition technology and related content delivery. For more information visit www.gracenote.com.

Gracenote® Proprietary Legends
CD and music-related data from Gracenote, Inc., copyright © 2000–2009 Gracenote. Gracenote Software, copyright © 2000–2009 Gracenote. This product and service may practice one or more of the following U.S. Patents: #5,987,525; #6,061,680; #6,154,773, #6,161,132, #6,230,192, #6,230,207, #6,240,459, #6,330,593, and other patents issued or pending. Some services supplied under license from Open Globe, Inc. for U.S. Patent: #6,304,523.

Gracenote and CDDB are registered trademarks of Gracenote. The Gracenote logo and logotype, and the "Powered by Gracenote" logo are trademarks of Gracenote.



Gracenote® End-User License Agreement
USE OF THIS PRODUCT IMPLIES ACCEPTANCE OF THE TERMS BELOW.

This application or device contains software from Gracenote, Inc. of Emeryville, California ("Gracenote"). The software from Gracenote (the "Gracenote Software") enables this application to perform disc and/or file identification and obtain music-related information, including name, artist, track, and title information ("Gracenote Data") from online servers or embedded databases (collectively, "Gracenote Servers") and to perform other functions. You may use Gracenote Data only by means of the intended End-User functions of this application or device.

You agree that you will use Gracenote Data, the Gracenote Software, and Gracenote Servers for your own personal non-commercial use only. You agree not to assign, copy, transfer or transmit the Gracenote Software or any Gracenote Data to any third party. YOU AGREE NOT TO USE OR EXPLOIT GRACENOTE DATA, THE GRACENOTE SOFTWARE, OR GRACENOTE SERVERS, EXCEPT AS EXPRESSLY PERMITTED HEREIN.

You agree that your non-exclusive license to use the Gracenote Data, the Gracenote Software, and Gracenote Servers will terminate if you violate these restrictions. If your license terminates, you agree to cease any and all use of the Gracenote Data, the Gracenote Software, and Gracenote Servers. Gracenote reserves all rights in Gracenote Data, the Gracenote Software, and the Gracenote Servers, including all ownership rights. Under no circumstances will Gracenote become liable for any payment to you for any information that you provide. You agree that Gracenote, Inc. may enforce its rights under this Agreement against you directly in its own name.

The Gracenote service uses a unique identifier to track queries for statistical purposes. The purpose of a randomly assigned numeric identifier is to allow the Gracenote service to count queries without knowing anything about who you are. For more information, see the web page for the Gracenote Privacy Policy for the Gracenote service.

The Gracenote Software and each item of Gracenote Data are licensed to you "AS IS."
Gracenote makes no representations or warranties, express or implied, regarding the accuracy of any Gracenote Data from in the Gracenote Servers. Gracenote reserves the right to delete data from the Gracenote Servers or to change data categories for any cause that Gracenote deems sufficient. No warranty is made that the Gracenote Software or Gracenote Servers are error-free or that functioning of Gracenote Software or Gracenote Servers will be uninterrupted. Gracenote is not obligated to provide you with new enhanced or additional data types or categories that Gracenote may provide in the future and is free to discontinue its services at any time.

GRACENOTE DISCLAIMS ALL WARRANTIES EXPRESS OR IMPLIED, INCLUDING, BUT NOT LIMITED TO, IMPLIED WARRANTIES OF MERCHANTABILITY, FITNESS FOR A PARTICULAR PURPOSE, TITLE, AND NON-INFRINGEMENT. GRACENOTE DOES NOT WARRANT THE RESULTS THAT WILL BE OBTAINED BY YOUR USE OF THE GRACENOTE SOFTWARE OR ANY GRACENOTE SERVER. IN NO CASE WILL GRACENOTE BE LIABLE FOR ANY CONSEQUENTIAL OR INCIDENTAL DAMAGES OR FOR ANY LOST PROFITS OR LOST REVENUES.

Adjust the audio quality (Sound menu)	82
Adjust the picture quality (Picture menu)	82
Album (Music)	
Edit	73
Play	71
Album (Still picture)	
Copy	67
Edit	66
Play	64
Angle	81
Aspect	83
Audio	
Digital broadcast	27
Playback	40
Auto Renewal Recording	36
AVCHD	
Copy	62
Play	43
AV2 Settings	94
BD-Live	46
BONUSVIEW	46
CAM (Conditional Access Module)	16
Change Thumbnail	49
Channel	
Select	20
Settings	87
Chapter	51
Chapter Creation	51, 90
Chasing playback	33
CI Plus	16, 19, 31, 98, 118
Cleaning	
Disc	15
Lens	14
Main unit	14
Clock Settings	95
Common Interface	16, 19, 94
Connection	
Aerial	17
Amplifier	100, 101
Common Interface	16
COMPONENT VIDEO terminals	100
Digital Audio Output	101
DV input terminal	60
HDMI	17, 102
Network	103
Set Top Box	101
Television	17, 100, 102
Video cassette recorder	101
VIDEO terminal	100
Copy	
HD Video	62
Music	75
SD Video	63
Still picture	68
Title	26, 52–58
Copy Title Playing	55
Country setting	18
CPRM	118
Deep Colour	118
Delete	
Album (Music)	73, 74
Album (Still picture)	67
All titles (Discs)	85
All titles (HDD)	90
Chapter	51
Still picture	67
Title	25
Digital Audio Output settings	91
Digital broadcast	
Digital channel information	27
Signal Condition	88
Multi Audio	27, 28, 89
Select channel	20
Sub Channel	27, 28
Subtitle	27, 28, 89
Update Channel List	88
DIRECT NAVIGATOR	
Title	21
Discs	
Disc Name	84
Discs that cannot be played	10
Discs you can use for recording and play	8
Format	85
Play-only discs	10
Protection	84
DiSeqC	118
Display	
Digital channel information	27
Status messages	83
Divide Title	49
DivX	44, 45, 116, 117, 118
DLNA	79, 118
DR (Direct Recording mode)	29
DR File Conversion	32
DV automatic recording	61
Edit	
Chapter	51
Music on HDD	73, 74
Still picture	66
Title	48
Finalise	86, 118
Flexible Recording via AV input	61
Format	85, 118
FUNCTION MENU display	13
Glossary	118
Gracenote® Database	75
HD Video	
Copy	62
Play	43
HDD	
Format	90
Handling care	14
HDMI	118
Connecting with a receiver	102
Connecting with a television	17, 102
Settings (HDMI Connection)	93
High Speed Copy	32, 90
HOLD function	99
Initialize	95
JPEG	116, 117, 118
Language	
Code list	104
Disc menu	81, 89
On-screen	92
Soundtrack	81, 89
Subtitle	81, 89
Linked timer recordings with external equipment (Set Top Box)	59
LNB	88, 118
LPCM	92, 119

Manual Skip	40	SD card	
Menu		Copy (HD Video)	62
DivX	44	Copy (SD Video)	63
MP3	70	Copy (Still picture)	68
Pop-up	21	Format	85
Setup	87	Insert	15
Mode		Play (HD Video)	43
Recording	29	Play (Still picture)	64
Still Mode	90	Supported formats	11
MPEG2	119	SD Video	
Copy	63	Copy	63
Music		Select channel	20
Copy	75	Setup menu	87
Edit	73, 74	Signal Condition	88
Play (CD)	70	Simultaneous rec and play	33
Play (MP3)	70	Slideshow	65
Play (Music on HDD)	71	Smart Card	16
Name		Software (firmware) Update	98
Album (Music)	73, 74	Soundtrack	81
Album (Still picture)	67	Specifications	115
Disc	84	Still picture	
Entering text	80	Copy	68
Title	49	Edit	66
Network		Play	64
Connection	103	Subtitle	
DLNA	79, 118	Digital broadcast	27
Settings	96	Disc	81
One Touch Recording	22	Playback	40
On-screen		Switch the audio/subtitles on the disc (Disc menu)	81
Language	92	Teletext	
Partial Delete	49	Digital broadcast	28
Pause Live TV	79	Playback	40
VIERA	77	Time Slip	40
Playing back		Timer recording	
BD-Video/DVD-Video	21	Check, change or delete a programme	37
HD Video	43	Manual Recording	35
Music	70	Using the TV Guide system	23
Still picture	64	Title	
Title	21	Copy	26, 52–58
Playlist		Delete	25
Music	71	Edit	48
Title	43	Play	21
Power Save	95	Protection	49
Progressive	82, 119	Transponder	88, 119
Properties		Tuning	87
Music	72	TV Guide	23, 38
Still picture	65	TV System (PAL/NTSC)	93
Title	49	Update Channel List	88
Protection		USB	
Album (Still picture)	67	Copy (HD Video)	62
Card	11	Copy (Music)	75
Disc	84	Copy (SD Video)	63
Still picture	67	Copy (Still picture)	68
Title	49	Insert	15
Quick View	39	Play (Still picture)	64
Ratings level		Supported formats	11
BD-Video	89	VIERA CAST™	78
DVD-Video	89	VIERA Link (HDAVI Control)	17
Recording	22	Connection	17, 102
Aspect	90	Operation	76, 77
Auto Renewal	36	Settings	93
DV automatic recording	61	x.v.Colour™	119
EXT Link	59	2 programmes simultaneous recording	31, 34
Flexible Recording via AV input	61		
Important notes	32		
Mode	29		
Timer	23, 35–38		
Recording to discs from external equipment			
DV automatic recording	61		
Flexible Recording via AV input	61		
Timer	59		
Remote control code	95		
Repeat Play	82		
Resume play function	39		

Information for Users on Collection and Disposal of Old Equipment and used Batteries



These symbols on the products, packaging, and/or accompanying documents mean that used electrical and electronic products and batteries should not be mixed with general household waste. For proper treatment, recovery and recycling of old products and used batteries, please take them to applicable collection points, in accordance with your national legislation and the Directives 2002/96/EC and 2006/66/EC. By disposing of these products and batteries correctly, you will help to save valuable resources and prevent any potential negative effects on human health and the environment which could otherwise arise from inappropriate waste handling. For more information about collection and recycling of old products and batteries, please contact your local municipality, your waste disposal service or the point of sale where you purchased the items. Penalties may be applicable for incorrect disposal of this waste, in accordance with national legislation.



For business users in the European Union
If you wish to discard electrical and electronic equipment, please contact your dealer or supplier for further information.

[Information on Disposal in other Countries outside the European Union]

These symbols are only valid in the European Union. If you wish to discard these items, please contact your local authorities or dealer and ask for the correct method of disposal.



Note for the battery symbol (bottom two symbol examples):

This symbol might be used in combination with a chemical symbol. In this case it complies with the requirement set by the Directive for the chemical involved.

Cd

CAUTION!

**THIS PRODUCT UTILIZES A LASER.
USE OF CONTROLS OR ADJUSTMENTS OR
PERFORMANCE OF PROCEDURES OTHER THAN THOSE
SPECIFIED HEREIN MAY RESULT IN HAZARDOUS
RADIATION EXPOSURE.
DO NOT OPEN COVERS AND DO NOT REPAIR YOURSELF.
REFER SERVICING TO QUALIFIED PERSONNEL.**

WARNING:

**TO REDUCE THE RISK OF FIRE, ELECTRIC SHOCK OR
PRODUCT DAMAGE,
• DO NOT EXPOSE THIS APPARATUS TO RAIN, MOISTURE,
DRIPPING OR SPLASHING AND THAT NO OBJECTS
FILLED WITH LIQUIDS, SUCH AS VASES, SHALL BE
PLACED ON THE APPARATUS.
• USE ONLY THE RECOMMENDED ACCESSORIES.
• DO NOT REMOVE THE COVER (OR BACK); THERE ARE
NO USER SERVICEABLE PARTS INSIDE. REFER
SERVICING TO QUALIFIED SERVICE PERSONNEL.**

CAUTION!

**• DO NOT INSTALL OR PLACE THIS UNIT IN A BOOKCASE,
BUILT-IN CABINET OR IN ANOTHER CONFINED SPACE.
ENSURE THE UNIT IS WELL VENTILATED. TO PREVENT
RISK OF ELECTRIC SHOCK OR FIRE HAZARD DUE TO
OVERHEATING, ENSURE THAT CURTAINS AND ANY
OTHER MATERIALS DO NOT OBSTRUCT THE
VENTILATION VENTS.
• DO NOT OBSTRUCT THE UNIT'S VENTILATION OPENINGS
WITH NEWSPAPERS, TABLECLOTHS, CURTAINS, AND
SIMILAR ITEMS.
• DO NOT PLACE SOURCES OF NAKED FLAMES, SUCH AS
LIGHTED CANDLES, ON THE UNIT.
• DISPOSE OF BATTERIES IN AN ENVIRONMENTALLY
FRIENDLY MANNER.**

CAUTION

Danger of explosion if battery is incorrectly replaced. Replace only with the same or equivalent type recommended by the manufacturer. Dispose of used batteries according to the manufacturer's instructions.

THIS UNIT IS INTENDED FOR USE IN MODERATE CLIMATES.

This product may receive radio interference caused by mobile telephones during use. If such interference is apparent, please increase separation between the product and the mobile telephone.

The socket outlet shall be installed near the equipment and easily accessible.
The mains plug of the power supply cord shall remain readily operable.
To completely disconnect this apparatus from the AC Mains, disconnect the power supply cord plug from AC receptacle.

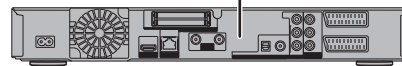

DANGER - VISIBLE AND INVISIBLE LASER RADIATION WHEN OPEN. AVOID DIRECT EXPOSURE TO BEAM. FDA 21 CFR/Class IIIb	
CAUTION	- CLASS 3B VISIBLE AND INVISIBLE LASER RADIATION WHEN OPEN. AVOID EXPOSURE TO THE BEAM. IEC60825-1 #A2/Class 3B
ATTENTION	- RAYONNEMENT LASER VISIBLE ET INVISIBLE. CLASSE 3B. EN CAS D'OUVERTURE, EVITER UNE EXPOSITION AU FAISCEAU.
FORSIGTIG	- SYNLIG OG USYNLIG LASERSTRÅLING KLASSE 3B. NÅR LÅGET ER ÅBENT, UNDGÅ AT BLIVE UDSAT FOR STRÅLEN.
VARO	- AVATTAESSA OLET ALTIINNA LUOKAN 3B NÄKYVÄÄ JA NÄKYMÄTÖNTÄ LASERSTRÄLÄÄ. VARO ALTISTUMISTA SÄTEELLE.
WARNING	- KLASS 3B SYNLIG OCH OSYNLIG LASERSTRÅLING NÄR DENNA DEL ÄR ÖPPNAD. UNDIK EXPONERING FÖR STRÅLEN.
VORSICHT	- SICHTBARE UND UNSICHTBARE LASERSTRÄHLUNG KLASSE 3B. WENN ABDECKUNG GEÖFFNET, NICHT DEM STRAHL AUSSETZEN.
注意	- 打开时有可见及不可见激光辐射。避免光束照射。
注意	- ここを開くと可視及び不可視レーザー光が出ます。ビームを見たり、触れたりしないでください。VOL1370

(Inside of product)



Environment friendly printed on chlorine free bleached paper.

Panasonic Corporation
Web Site: <http://panasonic.net>

Pursuant to at the directive 2004/108/EC, article 9(2)
Panasonic Testing Centre
Panasonic Marketing Europe GmbH
Winsbergring 15, 22525 Hamburg, Germany

© Panasonic Corporation 2010



RQT9434-L

(En)
RQT9434-L
F0110MD0