

## Operating Instructions

### Blu-ray Disc Player

Model No. **DMP-BD65**  
**DMP-BD45**



The illustration shows the image of DMP-BD65.

### *Dear customer*

Thank you for purchasing this product.

For optimum performance and safety, please read these instructions carefully.

Before connecting, operating or adjusting this product, please read the instructions completely.

Please keep this manual for future reference.



### Region management information

#### BD-Video

This unit plays BD-Video marked with labels containing the region code B.

Example:



#### DVD-Video

This unit plays DVD-Video marked with labels containing the region number "2" or "ALL".

Example:



Model number suffix "EB" denotes UK model.



# Caution for AC Mains Lead

For your safety, please read the following text carefully.

This appliance is supplied with a moulded three pin mains plug for your safety and convenience.

A 5-ampere fuse is fitted in this plug.

Should the fuse need to be replaced please ensure that the replacement fuse has a rating of 5-ampere and that it is approved by ASTA or BSI to BS1362.

Check for the ASTA mark  or the BSI mark  on the body of the fuse.

If the plug contains a removable fuse cover you must ensure that it is refitted when the fuse is replaced.

If you lose the fuse cover the plug must not be used until a replacement cover is obtained.

A replacement fuse cover can be purchased from your local dealer.

## CAUTION!

IF THE FITTED MOULDED PLUG IS UNSUITABLE FOR THE SOCKET OUTLET IN YOUR HOME THEN THE FUSE SHOULD BE REMOVED AND THE PLUG CUT OFF AND DISPOSED OF SAFELY. THERE IS A DANGER OF SEVERE ELECTRICAL SHOCK IF THE CUT OFF PLUG IS INSERTED INTO ANY 13-AMPERE SOCKET.

If a new plug is to be fitted please observe the wiring code as stated below.

If in any doubt please consult a qualified electrician.

## IMPORTANT

The wires in this mains lead are coloured in accordance with the following code:

Blue: Neutral, Brown: Live.

As these colours may not correspond with the coloured markings identifying the terminals in your plug, proceed as follows:

The wire which is coloured Blue must be connected to the terminal which is marked with the letter N or coloured Black or Blue.

The wire which is coloured Brown must be connected to the terminal which is marked with the letter L or coloured Brown or Red.

**WARNING: DO NOT CONNECT EITHER WIRE TO THE EARTH TERMINAL WHICH IS MARKED WITH THE LETTER E, BY THE EARTH SYMBOL  OR COLOURED GREEN OR GREEN/YELLOW.**

**THIS PLUG IS NOT WATERPROOF—KEEP DRY.**

## Before use

Remove the connector cover.

## How to replace the fuse

The location of the fuse differ according to the type of AC mains plug (figures A and B). Confirm the AC mains plug fitted and follow the instructions below.

Illustrations may differ from actual AC mains plug.

1. Open the fuse cover with a screwdriver.

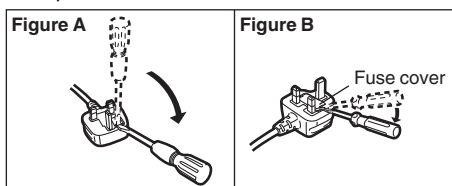

2. Replace the fuse and close or attach the fuse cover.

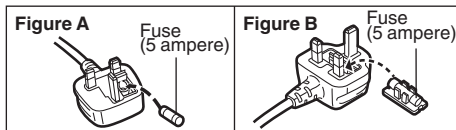

## CAUTION!

THIS PRODUCT UTILIZES A LASER.

USE OF CONTROLS OR ADJUSTMENTS OR PERFORMANCE OF PROCEDURES OTHER THAN THOSE SPECIFIED HEREIN MAY RESULT IN HAZARDOUS RADIATION EXPOSURE.

DO NOT OPEN COVERS AND DO NOT REPAIR YOURSELF.

REFER SERVICING TO QUALIFIED PERSONNEL.

## WARNING:

TO REDUCE THE RISK OF FIRE, ELECTRIC SHOCK OR PRODUCT DAMAGE,

- DO NOT EXPOSE THIS APPARATUS TO RAIN, MOISTURE, DRIPPING OR SPLASHING AND THAT NO OBJECTS FILLED WITH LIQUIDS, SUCH AS VASES, SHALL BE PLACED ON THE APPARATUS.

- USE ONLY THE RECOMMENDED ACCESSORIES.

- DO NOT REMOVE THE COVER (OR BACK); THERE ARE NO USER SERVICEABLE PARTS INSIDE. REFER SERVICING TO QUALIFIED SERVICE PERSONNEL.

The socket outlet shall be installed near the equipment and easily accessible.

The mains plug of the power supply cord shall remain readily operable.

To completely disconnect this apparatus from the AC Mains, disconnect the power supply cord plug from AC receptacle.

## CAUTION!

- DO NOT INSTALL OR PLACE THIS UNIT IN A BOOKCASE, BUILT-IN CABINET OR IN ANOTHER CONFINED SPACE. ENSURE THE UNIT IS WELL VENTILATED. TO PREVENT RISK OF ELECTRIC SHOCK OR FIRE HAZARD DUE TO OVERHEATING, ENSURE THAT CURTAINS AND ANY OTHER MATERIALS DO NOT OBSTRUCT THE VENTILATION VENTS.

- DO NOT OBSTRUCT THE UNIT'S VENTILATION OPENINGS WITH NEWSPAPERS, TABLECLOTHS, CURTAINS, AND SIMILAR ITEMS.

- DO NOT PLACE SOURCES OF NAKED FLAMES, SUCH AS LIGHTED CANDLES, ON THE UNIT.

- DISPOSE OF BATTERIES IN AN ENVIRONMENTALLY FRIENDLY MANNER.

## CAUTION

Danger of explosion if battery is incorrectly replaced. Replace only with the same or equivalent type recommended by the manufacturer. Dispose of used batteries according to the manufacturer's instructions.

This product may receive radio interference caused by mobile telephones during use. If such interference is apparent, please increase separation between the product and the mobile telephone.

THIS UNIT IS INTENDED FOR USE IN MODERATE CLIMATES.

# Table of contents

## Getting started

Caution for AC Mains Lead . . . . .	2
Accessory . . . . .	4
Unit and media care . . . . .	4
Control reference guide . . . . .	5
Playable discs/Cards/USB devices . . . . .	6

## Connections and settings

STEP 1 : Connecting to a TV . . . . .	8
STEP 2 : Connecting to an amplifier/receiver . . . . .	9
STEP 3 : Connecting to a broadband network <b>BD65</b> . . . . .	10
STEP 4 : Connecting AC mains lead . . . . .	11
STEP 5 : Setting . . . . .	12
STEP 6 : Reprogramming the remote control . . . . .	14

## Playback

Inserting or removing a media . . . . .	15
FUNCTION menu . . . . .	15
Playing video contents . . . . .	16
Playing still pictures . . . . .	20
Playing music . . . . .	21
Linked operations with the TV (VIERA Link "HDAVI Control™") . . . . .	22
Enjoying VIERA CAST™ <b>BD65</b> . . . . .	23

## Settings

Playback menu . . . . .	24
Setup menu . . . . .	26

## Reference

Troubleshooting guide . . . . .	30
Messages . . . . .	32
Audio Information . . . . .	33
About MP3/JPEG/DivX/AVCHD/MPEG2 files . . . . .	34
Specifications . . . . .	36
Safety precautions . . . . .	36
Supplemental information . . . . .	37
Glossary . . . . .	38
Index . . . . .	Back cover

### About descriptions in these operating instructions

- Instructions for operations are generally described using the remote control.
- These operating instructions are applicable to models DMP-BD65 and DMP-BD45. Unless otherwise indicated, illustrations in these operating instructions are of DMP-BD65.  
**BD65** **BD45** : indicates features applicable to DMP-BD65 and DMP-BD45, respectively.

### Firmware updating (⇒ 14)

### Sales and Support Information

#### Customer Care Centre

- For customers within the UK: 0844 844 3852
- For customers within the Republic of Ireland: 01 289 8333
- Visit our website for product information [www.panasonic.co.uk](http://www.panasonic.co.uk)
- E-mail: [customer.care@panasonic.co.uk](mailto:customer.care@panasonic.co.uk)

#### Direct Sales at Panasonic UK

- For customers: 0844 844 3856
- Order accessory and consumable items for your product with ease and confidence by phoning our Customer Care Centre Monday–Thursday 9:00 a.m.–5:30 p.m., Friday 9:30 a.m.–5:30 p.m. (Excluding public holidays)
- Or go on line through our Internet Accessory ordering application at [www.pas-europe.com](http://www.pas-europe.com).
- Most major credit and debit cards accepted.
- All enquiries transactions and distribution facilities are provided directly by Panasonic UK Ltd.
- It couldn't be simpler!
- Also available through our Internet is direct shopping for a wide range of finished products, take a browse on our website for further details.

*Interested in purchasing an extended guarantee?  
Please call 0870 240 6284 or visit our website  
[www.panasonic.co.uk/guarantee](http://www.panasonic.co.uk/guarantee).*

# Accessory

Check the supplied accessories before using this unit.

## 1 Remote control

**BD65** (N2QAKB000077)

**BD45** (N2QAKB000079)

## 2 Batteries for remote control

### 1 AC mains lead

(K2CZ3YY00005)



- Product numbers correct as of December 2009. These may be subject to change.
- Do not use AC mains lead with other equipment.

## Using the remote control

Insert so the poles (+ and -) match those in the remote control.

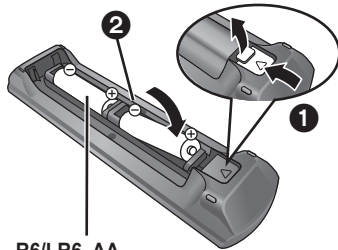

R6/LR6, AA

(Alkaline or manganese batteries)

Point it at remote control signal sensor on this unit. (⇒ 5)



Mishandling of batteries can cause electrolyte leakage which can damage items the fluid contacts and may cause a fire.

- Do not mix old and new batteries or different types at the same time.
  - Do not heat or expose to flame.
  - Do not leave the battery(ies) in an automobile exposed to direct sunlight for a long period of time with doors and windows closed.
  - Do not take apart or short circuit.
  - Do not attempt to recharge alkaline or manganese batteries.
  - Do not use batteries if the covering has been peeled off.
- Remove batteries if the remote control is not going to be used for a long period of time. Store in a cool, dark place.

# Unit and media care

## ■ Clean this unit with a soft, dry cloth

- Never use alcohol, paint thinner or benzine to clean this unit.
- Before using chemically treated cloth, carefully read the instructions that came with the cloth.

## ■ Clean the lens with the lens cleaner

Lens cleaner: RP-CL720E

- This lens cleaner may not be available for sale in all countries, e.g. not available in Germany, please consult your Panasonic dealer for advice.
- This lens cleaner is primarily for use on Panasonic DVD recorders (DIGA), but it is also suitable for use on this unit.

## ■ Clean discs

**DO**

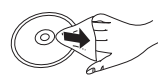

**DO NOT**



Wipe with a damp cloth and then wipe dry.

## ■ Disc and card handling precautions

- Handle discs by the edges to avoid inadvertent scratches or fingerprints on the disc.
- Do not attach labels or stickers to discs.
- Do not use record cleaning sprays, benzine, thinner, static electricity prevention liquids or any other solvent.
- Clean any dust, water, or foreign matter from the terminals on the rear side of the card.
- Do not use the following discs:
  - Discs with exposed adhesive from removed stickers or labels (rented discs etc).
  - Discs that are badly warped or cracked.
  - Irregularly shaped discs, such as heart shapes.

## ■ To dispose or transfer this unit

The unit may keep the user settings information in the unit. If you discard this unit either by disposal or transfer, then follow the procedure to return all the settings to the factory presets to delete the user settings. (⇒ 30, "To return all settings to the factory preset.")

- The operation history may be recorded in the memory of this unit.

# Control reference guide

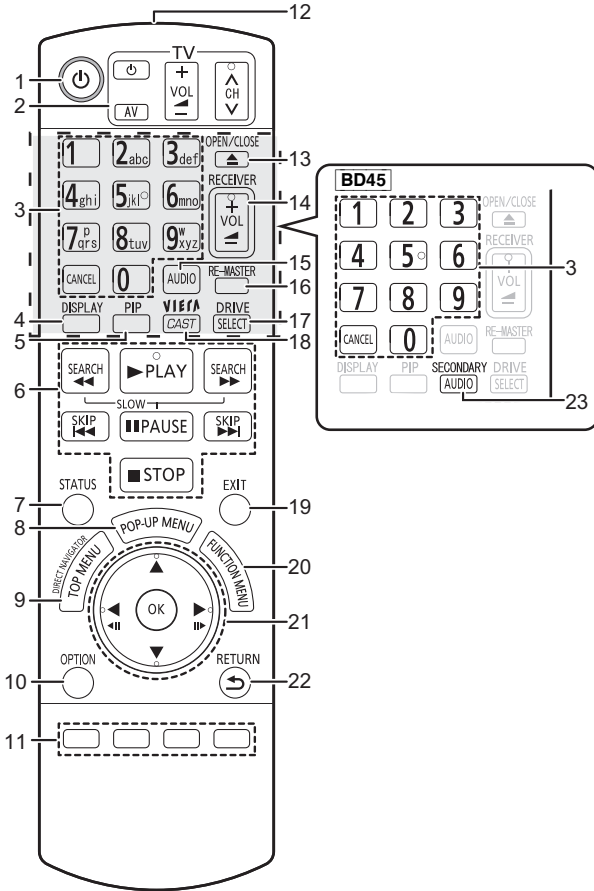

- 1 Turn the unit on and off (⇒ 12)
- 2 **TV operation buttons** (⇒ 14)  
You can operate the TV through the unit's remote control.  
[⏻ TV] : Turn the television on and off  
[AV] : Switch the input select  
[+ - VOL] : Adjust the volume  
[^ v CH] : Channel select
- 3 Select title numbers, etc./Enter numbers or characters (⇒ 23)  
[CANCEL] : Cancel
- 4 Show playback menu (⇒ 24)
- 5 Switch on/off Secondary Video (Picture-in-picture) (⇒ 18)
- 6 Basic playback control buttons (⇒ 16)
- 7 Show status messages (⇒ 16)
- 8 Show Pop-up menu (⇒ 16)
- 9 Show Top menu/DIRECT NAVIGATOR (⇒ 16)
- 10 Show OPTION menu (⇒ 17)
- 11 Coloured buttons (red, green, yellow, blue)  
These buttons are used when;
  - Operating a BD-Video disc that includes Java™ applications (BD-J).
  - Displaying "Title View" and "Album View" screens. (⇒ 20)
  - Operating contents of VIERA CAST. **BD65** (⇒ 23)
- 12 Transmit the remote control signal
- 13 Open or close the disc tray (⇒ 15)  
**CAUTION**  
Do not place objects in front of the unit. The disc tray may collide with objects when it is opened, and this may cause injury.
- 14 Adjust the volume of an amplifier/receiver. (⇒ 14)
- 15 Select audio (⇒ 16)
- 16 Reproduce more natural audio (⇒ 17)
- 17 Select drive (BD/DVD/CD, SD card or USB device) (⇒ 15)
- 18 **BD65** Displays the Home screen of the VIERA CAST (⇒ 23)
- 19 Exit the menu screen
- 20 Show FUNCTION menu (⇒ 15)
- 21 Selection/OK, Frame-by-frame (⇒ 16)
- 22 Return to previous screen
- 23 **BD45** Switch on/off Secondary Audio (⇒ 18)

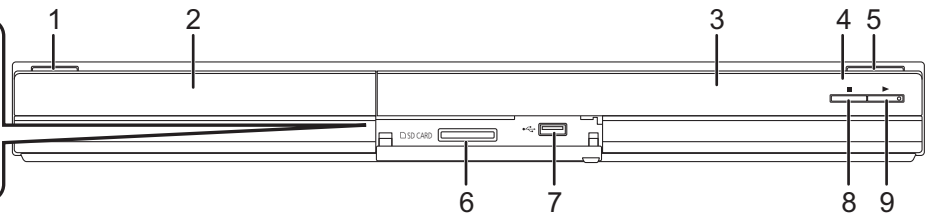
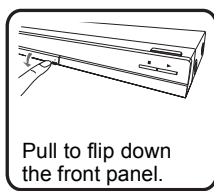

- 1 **Standby/on switch** (⏻/⏻) (⇒ 12)  
Press to switch the unit from on to standby mode or vice versa. In standby mode, the unit is still consuming a small amount of power.
- 2 Disc tray (⇒ 15)
- 3 Display









	<b>SD</b>	<b>USB</b>
Disc indicator	SD card indicator	USB device indicator

The indicator blinks when reading data from a disc, a card or a USB device, or writing data to a card.

- 4 Remote control signal sensor  
Distance: Within approx. 7 m  
Angle: Approx. 20° up and down, 30° left and right
- 5 Open or close the disc tray (⇒ 15)
- 6 SD card slot (⇒ 15)
- 7 USB port (⇒ 15)
- 8 Stop (⇒ 16)
- 9 Start play (⇒ 16)

Rear panel terminals (⇒ 8–11)

# Playable discs/Cards/USB devices

Type	Logo examples	Type detail	Playable contents*
BD		BD-Video	Video
		BD-RE	Video JPEG
		BD-R	Video DivX®
DVD		DVD-Video	Video
		DVD-RAM	Video AVCHD JPEG
		DVD-R	Video AVCHD DivX MP3 JPEG
		DVD-R DL	
		DVD-RW	Video AVCHD
	—	+R/+RW/+R DL	
CD		Music CD	Music [CD-DA]
	—	CD-R CD-RW	DivX Music [CD-DA] MP3 JPEG
SD		<b>SD Memory Card (from 8 MB to 2 GB)</b> (Including miniSD Card and microSD Card) <b>SDHC Memory Card (from 4 GB to 32 GB)</b> (Includes microSDHC Card) <b>SDXC Memory Card (48 GB, 64 GB)</b> (Includes microSDXC Card)	MPEG2 AVCHD JPEG
USB	—	<b>USB device</b> (up to 128 GB)	DivX MP3 JPEG

\* See page 7, 34–35 for more information on the types of content that can be played.

## ■ Discs that cannot be played in this unit

Any other disc that is not specifically supported or previously described.

- 2.6 GB and 5.2 GB DVD-RAM
- DVD-RAM that cannot be removed from their cartridges
- Super Audio CD
- Photo CD
- DVD-Audio
- Video CD and Super Video CD
- WMA discs
- HD DVD

## ■ Region management information

### BD-Video

This unit plays BD-Video marked with labels containing the region code "B".

Example:



### DVD-Video

This unit plays DVD-Video marked with labels containing the region number "2" or "ALL".

Example:



## ■ Finalize

DVD-R/RW/R DL, +R/+RW/+R DL and CD-R/RW recorded by a recorder, etc. needs to be finalized by the recorder to play on this unit. Please refer to the recorder's instructions.

## ■ BD-Video

This unit supports high bit rate audio (Dolby Digital Plus, Dolby TrueHD, DTS-HD High Resolution Audio and DTS-HD Master Audio) adopted in BD-Video. In order to enjoy these audio formats, refer to page 33.

## ■ Music CD

Operation and sound quality of CDs that do not conform to CD-DA specifications (copy control CDs, etc.) cannot be guaranteed.

## ■ SD card

- MiniSD Cards, microSD Cards, microSDHC Cards and microSDXC Cards can be used, but must be used with an adaptor card. These are usually supplied with such cards, or otherwise customer provided.
- Keep the Memory Card out of reach of children to prevent swallowing.
- To protect the card's contents, move the record prevention tab (on the SD card) to "LOCK".
- This unit is compatible with SD Memory Cards that meet SD Card Specifications FAT12 and FAT16 formats, as well as SDHC Memory Cards in FAT32 format (Does not support long file name.) and SDXC Memory Cards in exFAT.
- If the SD card is used with incompatible computers or devices, recorded contents may be erased due to the card being formatted etc.
- Useable memory may be slightly less than the card capacity.



## ■ USB device

- This unit supports connecting a USB memory, digital camera and video camera produced by Panasonic, etc. It is not warranted that all USB devices will work with this unit.
- This unit does not support USB device charging.
- FAT12, FAT16 and FAT32 file systems are supported.
- This unit supports USB 2.0 High Speed.

## ■ BD-RE, BD-R

Discs recorded in DR mode using Panasonic Blu-ray Disc recorders may not playback the audio etc., correctly.



- It may not be possible to play the above media in some cases due to the type of media, the condition of the recording, the recording method and how the files were created.
- The producers of the disc can control how discs are played. So you may not always be able to control play as described in these operating instructions. Read the disc's instructions carefully.

# STEP 1 : Connecting to a TV

- Do not place the unit on amplifiers/receiver or equipment that may become hot. The heat can damage the unit.
- Before making any connections we suggest you temporarily disconnect all the units from AC power.
- Do not connect video signals through a video recorder. Due to copy guard protection the picture may not be displayed properly.
- Refer to page 33, about recommended settings for each piece of connected equipment.

- Please use High Speed HDMI Cables that have the HDMI logo (as shown on the cover). It is recommended that you use Panasonic's HDMI cable. When outputting 1080p signal, please use HDMI cables 5.0 meters or less.

Recommended part number:  
 RP-CDHS15 (1.5 m), RP-CDHS30 (3.0 m),  
 RP-CDHS50 (5.0 m), etc.

BE SURE TO READ THE CAUTION FOR THE AC MAINS LEAD ON PAGE 2 BEFORE CONNECTION.

**Highest Quality  
(VIDEO)**

**Standard Quality  
(VIDEO)**

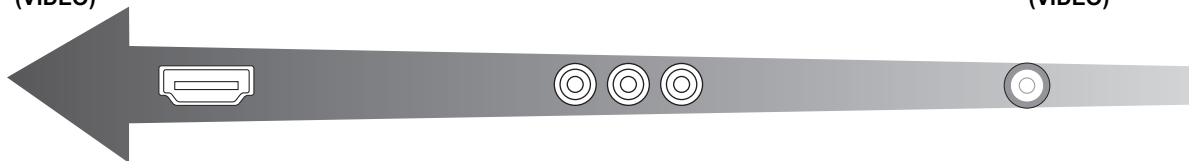

## ■ Via an HDMI AV OUT terminal

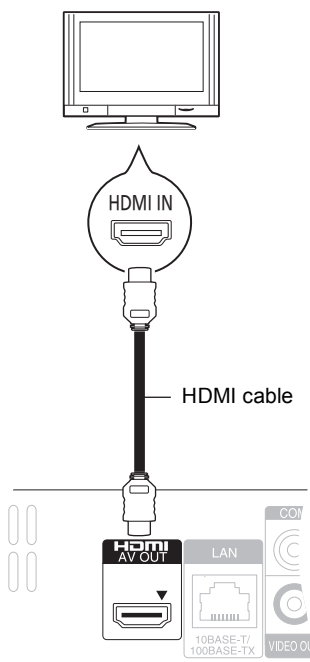

- The HDMI connection supports VIERA Link "HDAVI Control" (⇒ 22) when used with a compatible Panasonic TV.
- Set "HDMI Video Mode" [BD65] and "HDMI Audio Output" to "On" (⇒ 28).

## ■ Via a COMPONENT VIDEO OUT terminal [BD65]

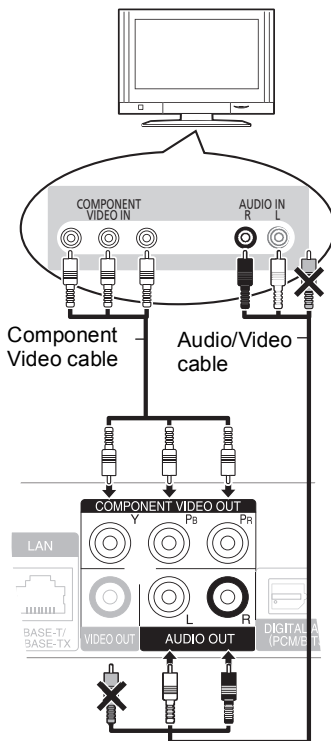

- Connect terminals of the same colour.
- Set "Component Resolution" to "576p/480p", "720p" or "1080i". (⇒ 28)
- Set "HDMI Video Mode" to "Off" (⇒ 28).

## ■ Via a VIDEO OUT terminal

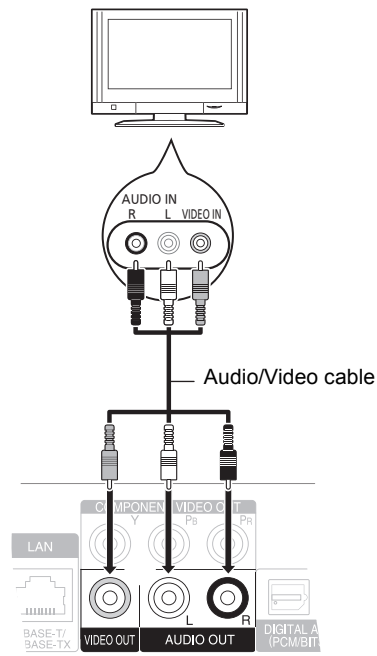

- Connect terminals of the same colour.



# STEP 2 : Connecting to an amplifier/receiver

## Digital Audio

### ■ Via an HDMI AV OUT terminal

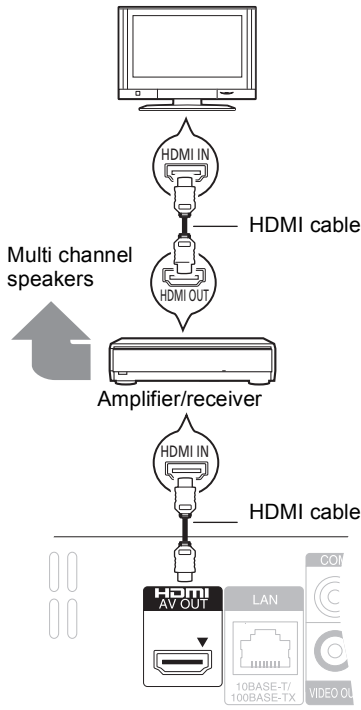

- The HDMI connection supports VIERA Link "HDAVI Control" (⇒ 22) when used with a compatible Panasonic TV.
- Set "HDMI Video Mode" **BD65** and "HDMI Audio Output" to "On" (⇒ 28).
- Set "Digital Audio Output" depending on the used terminal and connected amplifier/receiver. (⇒ 27)

### ■ Via an OPTICAL terminal

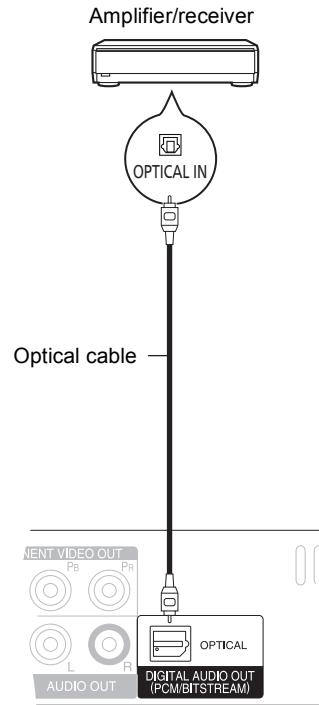

- When connecting a TV (⇒ 8) with HDMI AV OUT terminal, set "HDMI Audio Output" to "Off" (⇒ 28).
- Set "Digital Audio Output" depending on the connected amplifier/receiver (⇒ 27)

# STEP 3 : Connecting to a broadband network BD65

The following services can be used when this unit is connected to broadband.

- Firmware can be updated (⇒ 14)
- You can enjoy the BD-Live (⇒ 18)
- You can enjoy the VIERA CAST (⇒ 23)

For details about connection method, refer to the instructions supplied with the connected equipment.

- The unit is not compatible with public wireless LAN services (Hotspot etc.) provided in airports, stations, cafes etc.

## ■ Using LAN (ethernet) cable

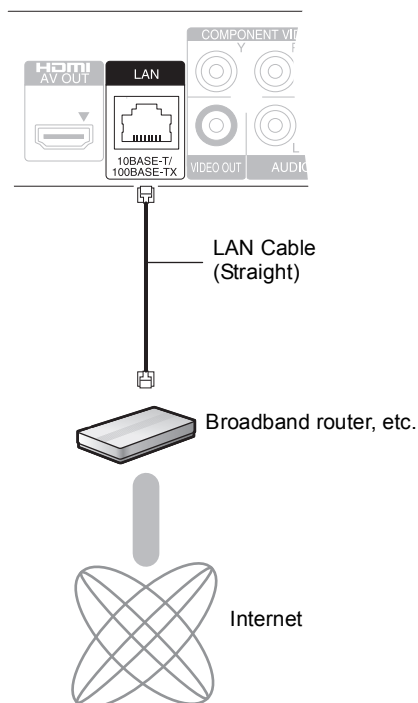

- Use shielded LAN cables when connecting to peripheral devices.
- Inserting any cable other than a LAN cable in the LAN terminal can damage the unit.

## ■ Using Wireless LAN Adaptor DY-WL10 (optional)

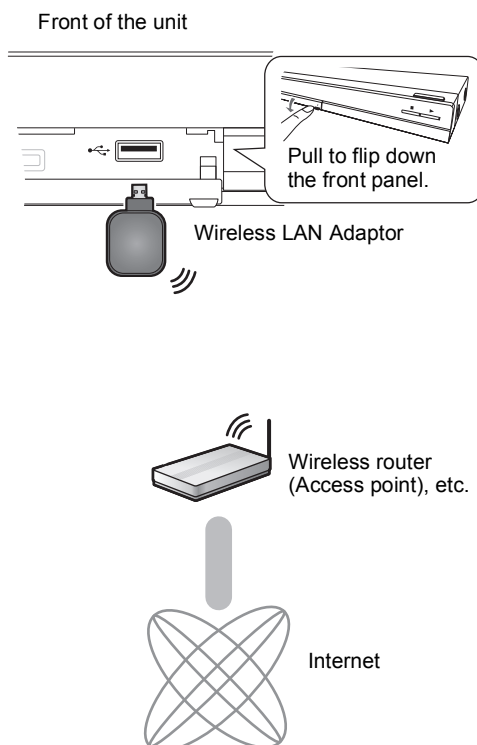

- Only the Wireless LAN Adaptor DY-WL10 (optional) can be used.
- Read the operating instructions for the Wireless LAN Adaptor DY-WL10 (optional) thoroughly when using it.
- For up to date compatibility information on your Wireless router (Access Point) refer to <http://panasonic.jp/support/global/cs/>

## STEP 4 : Connecting AC mains lead

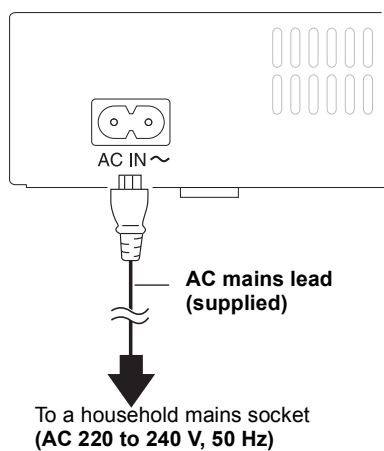

- This unit consumes a small amount of AC power ("Quick Start": "Off", approx. 0.2 W) even when turned off. In the interest of power conservation, if you will not be using this unit for an extended period of time, it can be disconnected.

# STEP 5 : Setting

## Easy Setting

After connecting your new player for the first time and pressing [⏻], a screen for the basic settings will appear.

### Preparation

Turn on the television and select the appropriate video input on the television.

#### 1 Press [⏻].

Setup screen appears.

If this unit is connected to a Panasonic TV (VIERA) supporting HDAVI Control 2 or later via an HDMI cable, then the setting information on the TV is acquired by this TV.

#### 2 Follow the on-screen instructions and make the settings with [▲, ▼] and press [OK].

"On-Screen Language", "TV Aspect" and "Quick Start" are set. (⇒ 27 – 29)

**BD65** After completing "Easy Setting", you can perform "Network Easy Setting".



- You can perform this setup anytime by selecting "Easy Setting" in the Setup menu. (⇒ 29)
- You can also change these settings individually. (⇒ 27 – 29)

## Network Easy Setting **BD65**

After completing "Easy Setting", you will be asked to perform "Network Easy Setting".

Select "Wired" or "Wireless" and press [OK].

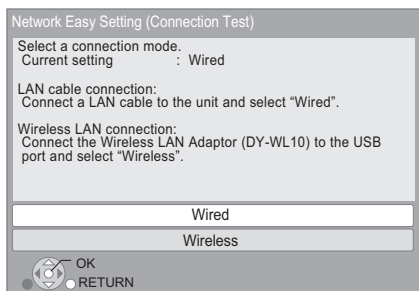

### ■ "Wired" connection

Follow the on-screen instructions to make your connection settings.

- When you experience problems (⇒ 13)

### ■ "Wireless" connection

If you select "Wireless" and "Wireless LAN Adaptor is not connected." is displayed, check that the Wireless LAN Adaptor is fully inserted. Alternatively, disconnect and reconnect it. If there is still no change in the display, consult your dealer for advice.

Select "WPS (PUSH button)" or "Search for access point" and then follow the on-screen instructions and make the settings.

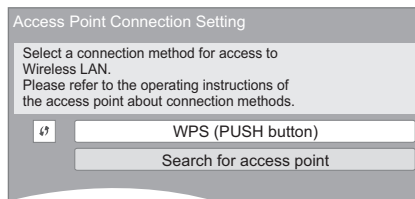

#### WPS (PUSH button):

If your Wireless router (Access point) supports WPS (PUSH button), you can easily perform the settings by pressing WPS button on it.

WPS (Wi-Fi Protected Setup) is a standard that facilitates settings relating to the connection and security of wireless LAN devices.

- ① Press WPS button or corresponding button of Wireless router (Access point) until the lamp starts flashing.
  - For details, refer to the operating instruction of Wireless router (Access point).
- ② Press [OK].

e.g.

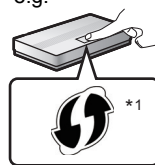

\*1 Wi-Fi Protected Setup-compatible Wireless router (Access point) may have the mark.

#### Search for access point:

Available Wireless routers (Access points) are searched and listed. You can select the one to use from the list.

- ① Press [▲, ▼] to select SSID\*2 of Wireless router (Access point) you want to connect with. Then press [OPTION] to show information of the selected router, make a note of the authentication and encryption type.

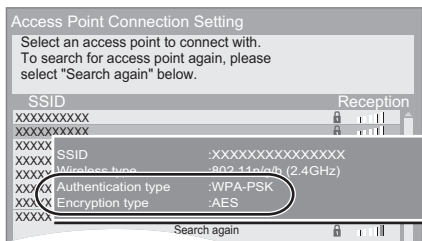

- If you can not find the SSID\*2, select "Search again".
- ② Press [RETURN] and then press [OK]. Then select an item on the following screen which corresponds to the authentication type noted down in step ① above.

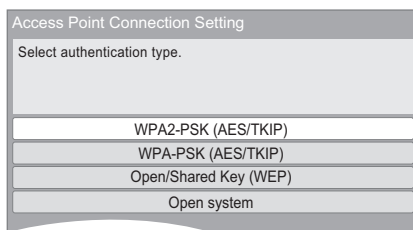

Follow the on-screen instructions to make the settings.

- Input your encryption key code in "Encryption Key" supplied with your Wireless router (Access point).

# When you experience problems with settings

## Access Point Connection Setting

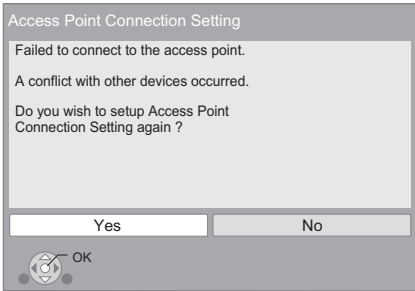

Display	Check the following
A conflict with another device occurred.	<ul style="list-style-type: none"> <li>Please wait a few moments, and then try again.</li> </ul>
A time out error occurred.	<ul style="list-style-type: none"> <li>Setting of the Wireless router (Access point) for MAC Address etc.</li> <li>The signal may be weak. Using the USB extension cable supplied with the Wireless LAN Adaptor, adjust the position of the Wireless LAN Adaptor.</li> <li>The SSID*<sup>2</sup> and the encryption key of the Wireless router (Access point).</li> <li>Please wait a few moments, and then try again.</li> </ul>
An authentication error or a time out error occurred.	
A device error occurred.	<ul style="list-style-type: none"> <li>Connection of Wireless LAN Adaptor If there is no improvement in symptom, consult your dealer.</li> </ul>

1. LAN cable connection or Connection to access point	:Pass	<ul style="list-style-type: none"> <li>Connection and settings of the hub and router</li> <li>Settings of "IP Address / DNS Settings" (⇒ 29)</li> </ul>
2. IP address setting	:Fail	
3. Connection to gateway	:Fail	
1. LAN cable connection or Connection to access point	:Pass	
2. IP address setting	:Pass	
3. Connection to gateway	:Fail	

## Network Easy Setting (Internet Connection Test)

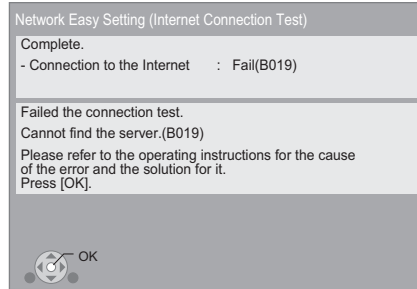

Display	Check the following
Cannot find the server. (B019)	<ul style="list-style-type: none"> <li>"Primary DNS" and "Secondary DNS" settings of "IP Address / DNS Settings" (⇒ 29)</li> </ul>
Failed to connect to the server. (B020)	<ul style="list-style-type: none"> <li>The server may be busy or the service may have been suspended. Please wait a few moments, and then try again.</li> <li>Settings of "Proxy Server Settings" (⇒ 29) and the router</li> </ul>



## Network Easy Setting (Connection Test)

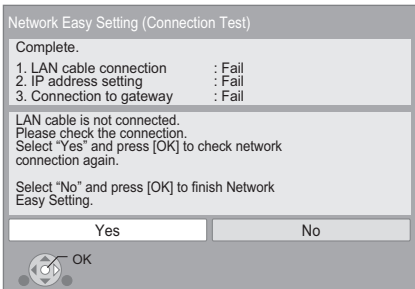

Display	Check the following	
1. LAN cable connection or Connection to access point	:Fail	<ul style="list-style-type: none"> <li>Connection of the LAN cables (⇒ 10)</li> </ul>
2. IP address setting	:Fail	
3. Connection to gateway	:Fail	

- Refer to the operating instructions of the hub or router.
- You can perform this setup anytime by selecting "Network Easy Setting" in the Setup menu. (⇒ 29)
- You can redo these settings individually using "Network Settings". (⇒ 29)
- Do not connect to a wireless network for which you do not have usage rights. Wireless networks for which you do not have usage rights (SSID\*<sup>2</sup>) may appear during the automatic search for a wireless network environment. However, if you connect, there is a risk that it will be regarded as illegal access.
- After performing network settings on this unit, the settings (encryption level, etc.) of the Wireless router (Access point) might change. When you have trouble getting online on your PC, perform the network settings on your PC in accordance with the settings of Wireless router (Access point).

<sup>2</sup> This is a name given to identify specific networks among wireless LANs. When the SSID is the same in two devices, data can be transmitted between them.

## Firmware updating

Occasionally, Panasonic may release updated firmware for this unit that may add or improve the way a feature operates. These updates are available free of charge.

**BD65** : This unit is capable of checking the firmware automatically when connected to the Internet via a broadband connection.

When a new firmware version is available, the following screen is displayed.



If you use **BD45** or you use **BD65** but downloading on this unit fails or this unit is not connected to the Internet, then you can download the latest firmware from the following website and burn it to a CD-R to update the firmware.

<http://panasonic.jp/support/global/cs/>  
(This site is in English only.)

To show the firmware version on this unit. (⇒ 29, "System Information")

DO NOT DISCONNECT the unit from the AC power or perform any operation while the update takes place. After the firmware is installed, "FINISH" will be displayed on the unit's display. Unit will restart and the following screen will be displayed.

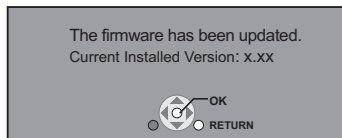

- **BD65** : You can perform update anytime by selecting "Firmware Update" in the Setup menu. (⇒ 29)
- Downloading will require several minutes. It may take longer or may not work properly depending on the connection environment.
- If you do not want to check for the latest firmware version, set "Automatic Update Check" to "Off". (⇒ 29)

## STEP 6 : Reprogramming the remote control

### For other Panasonic products

If you have more than one Panasonic player/recorder and the remote control operates both products at once, you will need to change the remote control code on one product to prevent this occurrence. After changing the remote control code on this product, you will need to change the code of the remote control. (⇒ 29, "Remote Control")

### For TV or amplifier/receiver

You can operate the TV or amplifier/receiver using the unit's remote control.

#### 1 For televisions

**Input the 2-digit code (⇒ 37) with the numbered buttons while pressing [TV].**

#### For amplifiers/receivers

**Input the 2-digit code (⇒ 37) with the numbered buttons while pressing [RECEIVER – VOL].**

e.g., 01: [0] ⇒ [1]

#### 2 Test by turning on the television or adjusting the volume of the amplifier/receiver.



- If your television or amplifier/receiver brand has more than one code listed, select the one that allows correct operation.

# Inserting or removing a media

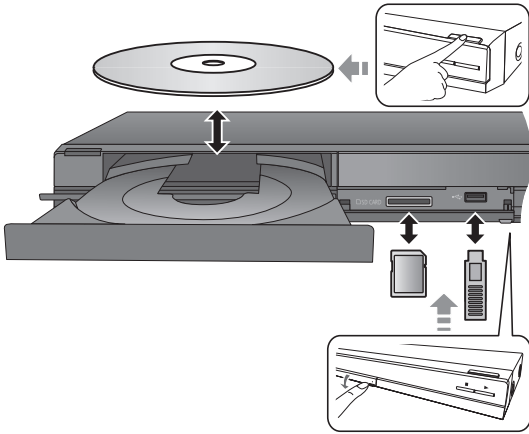

- When inserting a media, ensure that it is facing the right way up.
- When indicator on this unit's display blinks, do not turn off the unit or remove the media. Such action may result in loss of the media's contents.
- When removing the SD card, press on the centre of the card and pull it straight out.
- If you connect a Panasonic product with a USB connection cable, setup screen may be displayed on connected equipment. For details, refer to the instructions for the connected equipment.

## ■ To switch drives

Press [DRIVE SELECT] to select "BD/DVD/CD", "SD card" or "USB device".

- If a media is inserted while the unit is stopped, the drive switches automatically depending on the inserted media.

# FUNCTION menu

Major functions of this unit can be operated from the FUNCTION menu.

Press [▲, ▼] to select the item and press [OK].

BD65

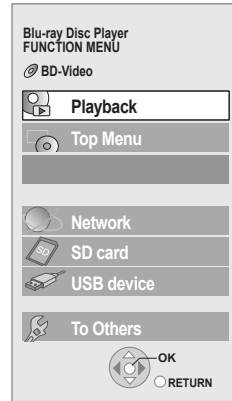

<b>Playback</b>	Play back the contents.	
<b>Top Menu</b>	(⇒ 16)	
<b>Menu</b>	(⇒ 16)	
<b>Viewing Picture</b>	(⇒ 20)	
<b>Viewing Video</b>	(⇒ 16)	
<b>Listening Music</b>	(⇒ 21)	
<b>Network</b> <span style="border: 1px solid black; padding: 0 2px;">BD65</span>	Displays the Home screen of the VIERA CAST(⇒ 23)	
<b>BD/DVD/CD</b>	Switches to each drive.	
<b>SD card</b>		
<b>USB device</b>		
<b>To Others</b>	<b>Playlists</b>	You can play playlists created on DVD-VR.
	<b>Setup</b>	(⇒ 26)
	<b>Card Management</b>	(⇒ 18)

## To exit the screen

Press [FUNCTION MENU].



- Items to be displayed may vary with the media.
- If FUNCTION screen is not displayed, press [FUNCTION MENU].

# Playing video contents

**BD DVD CD SD USB**

## Preparation

Turn on the television and select the appropriate video input on the television.

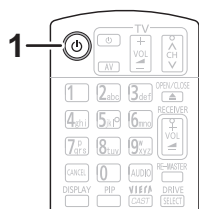

**1 Press [⏻] to turn on the unit.**

**2 Insert the media.**

Play starts.

- If the menu is displayed, press [▲], [▼], [◀], [▶] to select the item and press [OK].
- If play does not start, press [▶] (PLAY).

## ■ To show menus

You can display Top Menu, DIRECT NAVIGATOR or Pop-up Menu.

**Press [TOP MENU/DIRECT NAVIGATOR] or [POP-UP MENU].**

- Press [▲], [▼], [◀], [▶] to select the item and press [OK].
- Pop-up menu also appears by pressing [OPTION] and selecting "Pop-up Menu".

## ■ To show the status messages

**While playing, press [STATUS].**

The status messages give you information about what is currently being played. Each time you press [STATUS], the display information may change or will disappear from the screen.

e.g. BD-Video

T: Title, C: Chapter, PL: Playlist

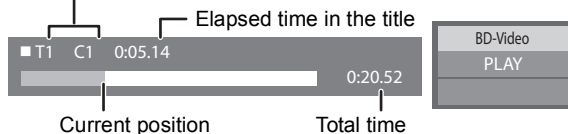

- Signal from PAL discs is output as PAL. Signal from NTSC discs is output as "NTSC" or "PAL60". You can select "NTSC" or "PAL60" in "NTSC Contents Output" for NTSC discs. (⇒ 27)
- DISCS CONTINUE TO ROTATE WHILE MENUS ARE DISPLAYED. Press [■] when you have finished playback to protect the unit's motor, your television screen and so on.
- Depending on media and contents, the display may change or may not appear.
- DivX: Successive play is not possible.
- It is not possible to playback AVCHD and MPEG2 video which have been dragged and dropped, copied and pasted to the media.

## Other operations during play

These functions may not work depending on the media and contents.

### Stop

**Press [■].**

The stopped position is memorized.

#### Resume play function

Press [▶] (PLAY) to restart from this position.

- The position is cleared if the tray is opened or you press [■] several times to display "STOP" on unit's display.
- **On BD-Video discs including BD-J (⇒ 38), the resume play function does not work.**

### Pause

**Press [⏸].**

- Press [⏸] again or [▶] (PLAY) to restart play.

### Search/Slow-motion

#### Search

**While playing, press [◀◀] or [▶▶].**

- Music and MP3: The speed is fixed to a single step.

#### Slow-motion

**While paused, press [◀◀] or [▶▶].**

- BD-Video and AVCHD: Forward direction [▶▶] only.

The speed increases up to 5 steps.

- Press [▶] (PLAY) to revert to normal playback speed.

### Skip

**While playing or paused, press [◀◀] or [▶▶].**

Skip to the title, chapter or track you want to play.

- Each press increases the number of skips.

### Frame-by-frame

**While paused, press [◀] (◀◀) or [▶] (▶▶).**

- Press and hold to change in succession forward or backward.
- Press [▶] (PLAY) to revert to normal playback speed.
- BD-Video and AVCHD: Forward direction [▶] (▶▶) only.

### Changing audio

**Press [AUDIO].**

You can change the audio channel number or soundtrack language (⇒ 24), etc.



# Enhancing the brilliance of audio playback

(Discs recorded at 48 kHz or less)

## Press [RE-MASTER] to select an item.

This feature gives you brighter sound by increasing the high frequency portion of the audio.

Recommended setting

<b>Re-master 1</b>	Pop and rock
<b>Re-master 2</b>	Jazz
<b>Re-master 3</b>	Classical



- This function is effective for audio from the HDMI terminal or the OPTICAL terminal only when "Digital Audio Output" is set to "PCM" (⇒ 27). (However, in this case, audio is output as 2ch from the OPTICAL terminal.)

## Useful functions

- 1 Press [OPTION].
- 2 Select an item, then press [OK].

While DIRECT NAVIGATOR screen is displayed

<b>Properties</b>	To display the title properties (recording date, etc.)
<b>Chapter View</b>	To select the chapter
<b>To Picture</b>	Playing still pictures (⇒ 20)
<b>Folder</b>	To switch to another folder

While playing

<b>Screen Aspect</b>	When black bars are shown at the top and bottom or left and right sides of the screen, you can enlarge the image to fill the screen.
<b>Top Menu</b>	To display Top Menu.
<b>Pop-up Menu</b>	To display Pop-up Menu.
<b>Menu</b>	To display Menu.

- Depending on the played contents if you perform "Screen Aspect", there may be not effect.
- When "TV Aspect" (⇒ 28) is set to "4:3 Pan & Scan" or "4:3 Letterbox", the "Zoom" effect in "Screen Aspect" is disabled.



- Depending on the media and contents, displayed items are different.

## Enjoying BD-Live BD65 or BONUSVIEW in BD-Video

### What is BONUSVIEW?

BONUSVIEW allows you to enjoy functions such as picture-in-picture or secondary audio etc.

### What is BD-Live?

In addition to the BONUSVIEW function, BD-Live allows you to enjoy more functions such as subtitles, exclusive images and online games by connecting this unit to the Internet.

- The usable functions and the operating method may vary with each disc, please refer to the instructions on the disc and/or visit their website.

## Playing picture-in-picture

To turn on/off secondary video  
Press **[PIP]**.

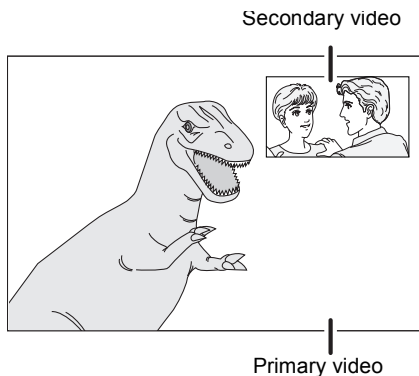

To turn on/off secondary audio  
**[DISPLAY]** ⇒ select **"Disc"** ⇒ **[▶]** ⇒ select **"Signal Type"** ⇒ **[OK]** ⇒ set **"Soundtrack"** in **"Secondary Video"** to **"On"** or **"Off"**  
OR  
BD45 : Press **[SECONDARY AUDIO]**.



- During search/slow-motion or frame-by-frame, only the primary video is displayed.
- When "BD-Video Secondary Audio" in "Digital Audio Output" is set to "Off", secondary audio will not be played (⇒ 27).

## Enjoying BD-Live discs with Internet BD65

Some BD-Live content available on the Blu-ray discs may require an Internet account to be created in order to access the BD-Live content. Follow the screen display or instruction manual of the disc for information on acquiring an account.

### 1 Connect to the network. (⇒ 10)

**2 Insert an SD card** (with 1 GB or more free space).  
SD card is used as the local storage (⇒ 38).

### 3 Insert the disc.

## ■ Deleting data/Formatting SD cards

- ① Insert an SD card.
- ② Press **[FUNCTION MENU]**.
- ③ Press **[▲, ▼]** to select **"To Others"** and press **[OK]**.
- ④ Press **[▲, ▼]** to select **"Card Management"** and press **[OK]**.
- ⑤ Press **[▲, ▼]** to select **"BD-Video Data Erase"** or **"Format SD Card"** and press **[OK]**.

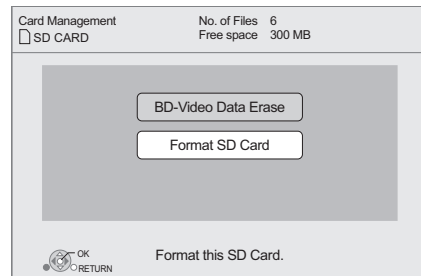

- ⑥ Press **[◀, ▶]** to select **"Yes"** and press **[OK]**.
- ⑦ Press **[◀, ▶]** to select **"Start"** and press **[OK]**.



- To use the above functions, it is recommended that you format the card on this unit. If the SD card you use is formatted, all data on the card will be erased. It cannot be recovered.
- "BD-Live Internet Access" may need to be changed for certain discs (⇒ 26).
- When discs supporting BD-Live are played back, the player or disc IDs may be sent to the content provider via the Internet.

## Regarding DivX

### ABOUT DIVX VIDEO:

DivX® is a digital video format created by DivX, Inc. This is an official DivX Certified device that plays DivX video. Visit [www.divx.com](http://www.divx.com) for more information and software tools to convert your files into DivX video.

### ABOUT DIVX VIDEO-ON-DEMAND:

This DivX Certified® device must be registered in order to play DivX Video-on-Demand (VOD) content.

To generate the registration code, locate the DivX VOD section in the device setup menu.

Go to [vod.divx.com](http://vod.divx.com) with this code to complete the registration process and learn more about DivX VOD.

- It is not possible to playback DivX VOD content recorded on the USB device.

### Display the unit's registration code.

(⇒ 29, "DivX Registration" in "General")

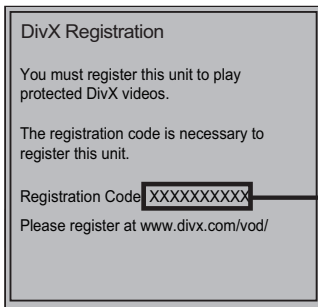

10 alphanumeric characters

- After playing DivX VOD content for first time, the registration code is not displayed.
- If you purchase DivX VOD content using a registration code different from this unit's code, you will not be able to play this content. ("Authorisation Error." is displayed.)

### Cancel the unit's registration.

(⇒ 29, "DivX Registration" in "General")

Press [◀, ▶] to select "Yes" in "DivX Registration".

Use the deregistration code to cancel the registration in [www.divx.com](http://www.divx.com).

### Regarding DivX VOD content that can only be played a set number of times

Some DivX VOD content can only be played a set number of times. When you play this content, the remaining number of plays is displayed. You cannot play this content when the number of remaining plays is zero. ("Rental Expired." is displayed.)

- The remaining number of plays decreases each time a program is played. However, when playing from the point where play was previously stopped, the remaining number of plays does not decrease due to the resume play function.

## ■ Displaying subtitles text

You can display subtitles text on the DivX video disc on this unit.

This function has no relation to the subtitles specified in DivX standard specifications and has no clear standard. The operation might be different or it may not operate properly depending on the way the file was made or the state of this unit (playing, stopped, etc.).

### Set "Subtitle" in "Disc" (⇒ 24)



- DivX video files that do not display "Text" do not contain subtitles text.
- If the subtitles text are not displayed correctly, try changing the language settings. (⇒ 26)

# Playing still pictures

**BD DVD CD SD USB**

(BD-RE, DVD-RAM/-R/-R DL, CD-R/RW, SD Card, USB device)

## 1 Insert a disc, SD card or USB device.

If the menu is displayed, press [**▲**, **▼**] to select the item and press [**OK**].

## 2 BD-RE, DVD-RAM

Press [**▲**, **▼**, **◀**, **▶**] to select the album and press [**OK**].

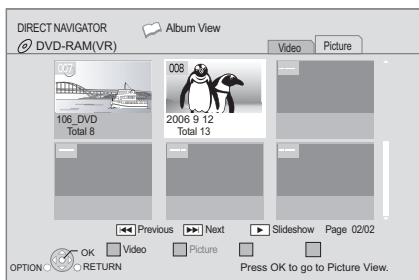

## 3 Press [**▲**, **▼**, **◀**, **▶**] to select the still picture and press [**OK**].

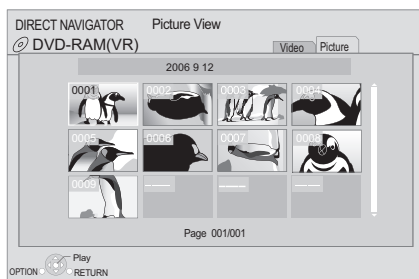

Press [**◀**, **▶**] to display the previous or next still picture.

**To show DIRECT NAVIGATOR screen or exit the screen**  
Press [**TOP MENU/DIRECT NAVIGATOR**].

## ■ To show the picture properties

While playing, press [**STATUS**] twice.

e.g. JPEG on DVD-RAM  
Shooting date



**To exit the screen**

Press [**STATUS**].

## Useful functions

### 1 Press [**OPTION**].

### 2 Select an item, then press [**OK**].

While "Album View" or "Picture View" screen is displayed

<b>Start Slideshow</b>	You can display still pictures one by one at a constant interval.
<b>Slideshow Setting</b>	<p><b>Display interval</b> Change the display interval.</p> <p><b>Transition Effect</b> Set display method.</p> <p><b>Repeat Play</b> Repeat slideshow.</p> <p><b>Soundtrack</b> The MP3 that is recorded on the USB device or the music CD can be played back as background music during the slideshow.</p> <p><b>Soundtrack Folder</b> A folder to playback can be selected when a USB device with MP3 recorded is connected to this unit.</p> <p><b>Press [<b>▲</b>, <b>▼</b>, <b>◀</b>, <b>▶</b>] to select "Set" and press [<b>OK</b>].</b></p>
<b>Select Folder</b>	To switch to another higher folder <ul style="list-style-type: none"> <li>Only if there is a multiple number of higher folders recognizable</li> </ul>
<b>Folder</b>	To select the still pictures in another folder
<b>To Video</b>	Playing video contents (⇒ 16)
<b>To album view</b>	To display album view.

While playing (except for slideshow)

<b>Rotate RIGHT</b>	Rotate the still picture.
<b>Rotate LEFT</b>	
<b>Zoom out</b>	Reduce the still picture <ul style="list-style-type: none"> <li>This function is only available for small-sized still pictures.</li> </ul>
<b>Zoom in</b>	Cancel "Zoom out"



- Depending on the media and contents, displayed items are different.
- When a still picture with large number of pixels is played, the display interval may become longer. Even if the setting is changed, the display interval may not become shorter.
- When both the music CD and the USB device with MP3 recorded is inserted to this unit, the music CD has a priority to be played back as background music.

# Playing music

**DVD CD USB**

(DVD-R/-R DL, music CD, CD-R/RW, USB device)

## 1 Insert a disc or USB device.

If the menu is displayed, press [**▲**, **▼**] to select the item and press [**OK**].

## 2 Press [**▲**, **▼**] to select the track and press [**OK**].

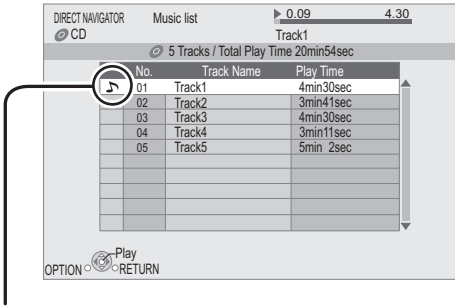

“” indicates the track currently playing.

### To show DIRECT NAVIGATOR screen or exit the screen

Press [**TOP MENU/DIRECT NAVIGATOR**].

## ■ Playing a track in another folder

While the “Music list” is displayed

Press [**OPTION**], press [**▲**, **▼**] to select “Select Folder” and press [**OK**].



- You cannot select folders that contain no compatible tracks.

# Linked operations with the TV

(VIERA Link “HDAVI Control™”)

## What is VIERA Link “HDAVI Control”?

VIERA Link “HDAVI Control” is a convenient function that offers linked operations of this unit, and a Panasonic TV (VIERA) or other device under “HDAVI Control”.

You can use this function by connecting the equipment with an HDMI cable. See the operating instructions for connected equipment for operational details.

## Preparation

- ① Set “VIERA Link” to “On” (⇒ 28).  
(The default setting is “On”.)
- ② Set the “HDAVI Control” operations on the connected equipment (e.g., TV).
- ③ Turn on all “HDAVI Control” compatible equipment and select this unit’s input channel on the connected TV so that the “HDAVI Control” function works properly.  
**Also when the connection or settings are changed, repeat this procedure.**

## Automatic input switching Power on link

When the following operations are performed, the television will automatically switch the input channel and display the corresponding action. When the television is off, the television will automatically turn on.

- When play starts on the unit
- When an action that uses the display screen is performed (e.g., DIRECT NAVIGATOR screen)
- BD-Video, DVD-Video:  
When playback stops, the TV will automatically return to TV tuner mode.

## Power off link

All connected equipment compatible with “HDAVI Control”, including this unit, automatically turns off when you switch the television off.

## Playing music continuously even after turning off power to the television

When the unit is connected to a Panasonic TV (VIERA) that supports HDAVI Control 2 or later and an amplifier/receiver supports VIERA Link.

- ① While playing music  
Press [OPTION].
- ② Press [▲, ▼] to select “TV Power” and press [OK].

## Easy control only with VIERA remote control

### Only TV supports “HDAVI Control 2” or later

By using the TV remote control, you can play discs using the “Control Panel” and display the Top Menu or Pop-up Menu, etc.

- 1 Press [OPTION].
- 2 Select an item, then press [OK].

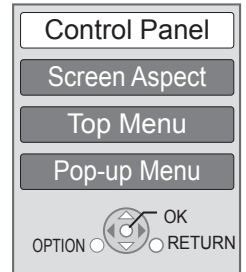

- The OPTION menu may not appear while the Top Menu for BD-Video or DVD-Video is displayed.



- The buttons that you can use for this unit vary depending on the TV. For details, refer to the operating instructions of the TV.
- The operation of this unit may be interrupted when you press incompatible buttons on the TV remote control.
- This unit supports “HDAVI Control 5” function.  
“HDAVI Control 5” is the newest standard (current as of December, 2009) for Panasonic’s HDAVI Control compatible equipment. This standard is compatible with Panasonic’s conventional HDAVI equipment.
- VIERA Link “HDAVI Control”, based on the control functions provided by HDMI which is an industry standard known as HDMI CEC (Consumer Electronics Control), is a unique function that we have developed and added. As such, its operation with other manufacturers’ equipment that supports HDMI CEC cannot be guaranteed.
- Please refer to individual manuals for other manufacturers’ equipment supporting VIERA Link function.

# Enjoying VIERA CAST™

## BD65

You can access a selection of Internet services from the Home screen with VIERA CAST, for example YouTube, Picasa Web Albums. (Current as of December 2009)

### Preparation

- Network connection (⇒ 10)
- Network setting (⇒ 12)

### 1 Press [VIERA CAST].

Message is displayed. Please read these instructions carefully and then press [OK].

### 2 Press [▲, ▼, ◀, ▶] to select the item and press [OK].

Operable buttons:

[▲, ▼, ◀, ▶], [OK], [RETURN], coloured buttons, numbered buttons

### VIERA CAST Home screen;

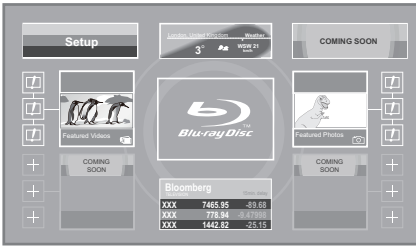

Images are for illustration purposes, contents may change without notice.

### To return to VIERA CAST Home screen

Press [VIERA CAST].

### To exit from VIERA CAST

Press [EXIT], [FUNCTION MENU] or [TOP MENU/DIRECT NAVIGATOR].



- In the following cases, settings are possible using "Internet Content Settings" (⇒ 29)
  - When restricting the use of VIERA CAST.
  - When the audio is distorted.
  - When wrong time is displayed
- If using slow Internet connection, the video may not be displayed correctly. A high-speed Internet service with a speed of at least 6 Mbps is recommended.
- Be sure to update the firmware when a firmware update notice is displayed on the screen. If the firmware is not updated, you will not be able to use the VIERA CAST™ function. (⇒ 14)
- VIERA CAST™ home screen is subject to change without notice.
- The services through VIERA CAST™ are operated by their respective service providers, and service may be discontinued either temporarily or permanently without notice. Therefore, Panasonic will make no warranty for the content or the continuity of the services.
- All features of websites or content of the service may not be available.
- Some content may be inappropriate for some viewers.
- Some content may only be available for specific countries and may be presented in specific languages.

# Playback menu

## 1 Press [DISPLAY].

e.g., BD-Video

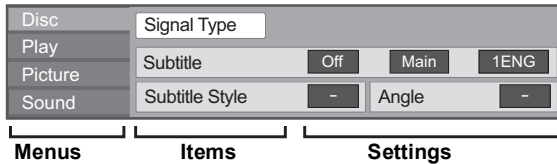

## 2 Press [▲, ▼] to select the menu and press [▶].

## 3 Press [▲, ▼, ◀, ▶] to select the item and press [▶].

## 4 Press [▲, ▼] to select the setting.

Some items can be changed by pressing [OK].

### To exit the screen

Press [DISPLAY].

**Depending on the condition of the unit (playing, stopped, etc.) and media contents, there may be some items that you cannot select or change.**

Regarding Language, Audio attribute and video attribute:  
(⇒ 37)

## Disc

### Signal Type

#### Primary Video

<b>Video</b>	The recording method of original video appears.
<b>Soundtrack</b>	Select the type of audio or language.

#### Secondary Video

<b>Video</b>	Select on/off of images. The recording method of original video appears.
<b>Soundtrack</b>	Select on/off of audio and the language.

### Video

The recording method of original video appears.

### Soundtrack

Show or change the soundtrack.

### Subtitle

Turn the subtitle on/off, and change the language depending on the media.

### Subtitle Style

Select the subtitle style.

### Audio channel

Select the audio channel number.  
(⇒ 16, Changing audio)

### Angle

Select the number of the angle.

Some items may be changed only on the disc specific menu.  
(⇒ 16)

## Play

### Repeat Play

(Only when the elapsed time is being displayed on the unit's display.)

Select the item which you want to repeat. The items displayed differ depending on the type of media.

Select "Off" to cancel.

### Random

Select whether or not to play random.



## Picture

### Mode

Select the picture quality mode during play.

- If you select "User", you can make further adjustments.  
Press [▶] to select "Picture Adjustment" and press [OK].
- 3D NR: Reduces the rough noise in the background to give a greater feeling of depth.  
When "24p Output" is set to "On", this function may not operate. (⇒ 28)
- Integrated NR: Smooths block noise and reduces the smudging that appears around contrasting sections of the picture.

---

### Detail Clarity

The picture is sharp and detailed.

---

### Progressive

Select the method of conversion for progressive output to suit the type of material being played.

- If the video is disrupted when "Auto" is selected, select either "Video" or "Film" depending on the material to be played back.

---

### 24p

Movies and other material recorded on DVD-Video at 24p are output at 24p.

- Only when you have selected "On" in "24p Output" (⇒ 28) and play discs recorded at a rate of 60 fields per second.
- 

## Sound

### Sound Effects<sup>\*1 \*2</sup>

Select the sound effect.

- **Re-master:** (⇒ 17)
- **Night Surround:**  
Enjoy a movie with powerful sound even when the volume is kept low at night. The audio is set in such a way that it can be heard easily.

---

### Dialog Enhancer<sup>\*2</sup>

The volume of the centre channel is raised to make dialog easier to hear.

---

<sup>\*1</sup> Not every function can be set individually.

<sup>\*2</sup> This function is effective for audio from the HDMI terminal or the OPTICAL terminal only when "Digital Audio Output" is set to "PCM" (⇒ 27). (However, in this case, audio is output as 2ch from the OPTICAL terminal.)

# Setup menu

Change the unit's settings if necessary. The settings remain intact even if you switch the unit to standby.

**1 Press [FUNCTION MENU] and press [▲, ▼] to select "To Others" and press [OK].**

**2 Press [▲, ▼] to select "Setup" and press [OK].**

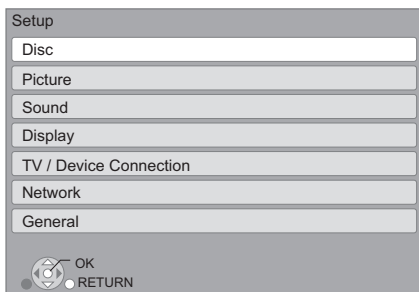

**3 Press [▲, ▼] to select the menu and press [OK].**

**4 Press [▲, ▼] to select the item and press [OK].**

If there are any other items, repeat these steps.

**5 Press [▲, ▼, ◀, ▶] to select the option and press [OK].**

- There may be differences in operation methods. If this happens, follow the on-screen instructions for the operation.

## About the password

The following items use the same password. Don't forget your password.

- "DVD-Video Ratings"
- "BD-Video Ratings"
- "Lock" **[BD65]** (⇒ 29)

## Disc

### DVD-Video Ratings

Set a ratings level to limit DVD-Video play.

- Follow the on-screen instructions. Enter the 4-digit password with the numbered buttons when the password screen is shown.

### BD-Video Ratings

Set an age limit of BD-Video play.

- Follow the on-screen instructions. Enter the 4-digit password with the numbered buttons when the password screen is shown.

### Soundtrack Preference

Choose the language for audio.

- If "Original" is selected, the original language of each disc will be selected.
- Enter a code (⇒ 37) with the numbered buttons when you select "Other \* \* \* \* \*".

### Subtitle Preference

Choose the language for subtitle.

- If "Automatic" is selected and the language selected for "Soundtrack Preference" is not available, subtitles of that language will automatically appear if available on that disc.
- Enter a code (⇒ 37) with the numbered buttons when you select "Other \* \* \* \* \*".

### Menu Preference

Choose the language for disc menus.

- Enter a code (⇒ 37) with the numbered buttons when you select "Other \* \* \* \* \*".

### BD-Live Internet Access **[BD65]** (⇒ 18)

You can restrict Internet access when BD-Live functions are used.

- If "Limit" is selected, Internet access is permitted only for BD-Live contents which have content owner certificates.

### DivX Subtitle Text

Select a suitable item according to the language used for DivX subtitles text (⇒ 19).

- This item is displayed only after playing back a file.

## Picture

### Still Mode

Select the type of picture shown when you pause playback.

<b>Automatic</b>	Automatically selects the type of picture shown.
<b>Field</b>	Select if jittering occurs when "Automatic" is selected.
<b>Frame</b>	Select if small text or fine patterns cannot be seen clearly when "Automatic" is selected.

### Seamless Play

The chapters segment in playlists are played seamlessly.

- Select "On", when the picture freezes for a moment at the chapters segment in playlists.

### NTSC Contents Output

Select PAL60 or NTSC output when playing NTSC discs.

## Sound

### Dynamic Range Compression

You can listen at low volumes but still hear dialog clearly. (Dolby Digital, Dolby Digital Plus and Dolby TrueHD only)

- "Auto" is effective only when playing Dolby TrueHD.

### Digital Audio Output (⇒ 33)

Press [OK] to show the following settings.

#### Dolby D/Dolby D +/Dolby TrueHD DTS/DTS-HD MPEG Audio

Select the audio signal to output.

- Select "PCM", when the connected equipment cannot decode the respective audio format.
- Not making the proper settings may result in noise.

#### BD-Video Secondary Audio

Select whether to mix or not mix the primary audio and secondary audio (including the button click sound). (⇒ 18)

- If "Off" is selected, the unit outputs the primary audio only.

### PCM Down Conversion

Select how to output audio with a sampling frequency of 96 kHz for the PCM output from the DIGITAL AUDIO OUT.

- If "On" is selected, the signals that are converted to 48 kHz are output.
- If "Off" is selected, and the connected equipment does not support 96 kHz, the sound will not be output normally.
- Signals are converted to 48 kHz despite the settings across in the following cases:
  - when the signals have a sampling frequency of 192 kHz
  - when the disc has copy protection
  - when "BD-Video Secondary Audio" is set to "On"

## Downmix

Select the downmix system of multi-channel to 2-channels sound.

- Select "Surround encoded", when the connected equipment supports the virtual surround function.
- There is no effect on "Bitstream" via HDMI AV OUT and DIGITAL AUDIO OUT.
- The audio will be output in "Stereo" in the following cases.
  - AVCHD playback
  - Playback of secondary audio (including the button click sound).

### 7.1ch Audio Reformatting [BD65]

Surround sound with 6.1ch or less is automatically expanded and played back at 7.1ch.

- If "Off" is selected, sound is played over the original number of channels.  
(Note that in the case of 6.1ch audio, playback will be at 5.1ch.)

Audio reformatting is enabled in the following cases:

- When you have selected "PCM" in "Digital Audio Output".
- When the audio is Dolby Digital, Dolby Digital Plus, Dolby TrueHD or LPCM.

## Display

### On-Screen Messages

Choose whether to show status messages automatically.

### On-Screen Language

Choose the language for these menus and on-screen messages.

### Screen Saver Function

This is to prevent burn-in on the screen.

- When this is set to "On":
  - If there is no operation for 10 minutes or more, DIRECT NAVIGATOR screen switches to FUNCTION screen automatically.
- While playing and pausing, etc., this function is not available.
- As for Music [CD-DA] or MP3, regardless of the setting, if there is no operation for a while, DIRECT NAVIGATOR screen switches to the other states automatically.

### FL Display

Changes the brightness of the unit's display.

- If "Automatic" is selected the display is dimmed during playback and bright except during playback.

### Software Licence



Information about the software used by this unit is displayed.

## TV / Device Connection

### TV Aspect

Set to match the type of television connected.

When connected to a 4:3 aspect television and playing 16:9 ratio image:

<b>4:3 Pan &amp; Scan</b>	The sides are cut off so the picture fills the screen. When playing BD-Video, video is output as "4:3 Letterbox".	
<b>4:3 Letterbox</b>	Black bands appear at the top and bottom of the picture.	

When connected to a 16:9 widescreen television and playing 4:3 ratio image:

<b>16:9</b>	Video is displayed as a 4:3 ratio image in the centre of the screen.
<b>16:9 full</b>	Video is displayed as a horizontally stretched 16:9 image.

### HDMI Connection

Press [OK] to show the following settings.

#### HDMI Video Mode [BD65]

Select "On" when video is output from HDMI AV OUT terminal.

<b>On</b>	Images are output from the HDMI terminal in the resolution set in "HDMI Video Format".
<b>Off</b>	Images are output in the resolution set in "Component Resolution".

#### HDMI Video Format

The items supported by the connected devices are indicated on the screen as "\*". When any item without "\*" is selected, the images may be distorted.

- If "Automatic" is selected, automatically selects the output resolution best suited to the connected television.
- To enjoy high definition video up-converted to 1080p, you need to connect the unit directly to 1080p compatible HDTV (High Definition Television). If this unit is connected to an HDTV through other equipment, the other must also be 1080p compatible.

#### 24p Output

When this unit is connected to a TV supporting 1080/24p output using an HDMI cable, movies and other material recorded at 24p are output at 24p.

- When playing DVD-Video, set to "On" and then set "24p" in "Picture" (⇒ 25) to "On"
- When BD-Video images other than 24p are played, images are output at 60p.

#### HDMI Output Range

The signal is enhanced to reproduce clear video, when connected to a device that only supports RGB output.

#### HDMI Audio Output

This setting selects whether or not to output audio from HDMI.

- Select "Off" when the TV is connected to this unit via an HDMI terminal, and this unit is also connected to other devices, such as an amplifier/receiver via an OPTICAL terminal.

#### VIERA Link

Set to use "HDAVI Control" function when connected with an HDMI cable to a device that supports "HDAVI Control".

- Select "Off" when you do not want to use "HDAVI Control".

#### Deep Colour Output

This setting is for selecting whether to use Deep Colour Output when a television that supports Deep Colour is connected.

#### Contents Type Flag

Depending on the playback content, the TV will output adjusting to the optimal method when a TV that supports Contents Type Flag is connected.

#### Component Resolution [BD65]

This sets the video output resolution when using the component video terminal.



480i, 480p: When playing NTSC discs

576i, 576p: When playing PAL discs

- Even if you select "720p" or "1080i", the video output resolution is restricted to "576p/480p" when DVD-Video discs, DivX and BD-Video discs recorded at a rate of 50 field per second are output from the COMPONENT VIDEO OUT terminals.

#### TV System

Perform the setup so it matches the TV System of the connected TV.

- When NTSC contents are played, they are outputted in the signal format specified in the "NTSC Contents Output", irrespective of the settings here.

## Network Easy Setting(⇒ 12)

### Network Settings

Perform network-related settings individually.  
Press [OK] to show the following settings.

#### LAN Connection Mode

Select connection method.

#### Access Point Connection Setting

This allows the Wireless router (Access point) and connection settings to be set and the current connection settings and connection state to be checked when a wireless connection is used.

##### Connection Setting

The Wireless router (Access point) connection wizard will be displayed.

#### IP Address / DNS Settings

This is for checking the state of the network connection and setting the IP address and DNS-related.

Press [OK] to show the respective setting.

- "Connection Speed Setting" is enabled only when "Connection Speed Auto-Config" is turned "Off".

#### Proxy Server Settings

This is for checking the state of connection with the Proxy server and performing settings.

Press [OK] to show the respective setting.

#### Internet Content Settings (⇒ 23) (VIERA CAST)

Press [OK] to show the following settings.

##### Lock

You can restrict the usage of VIERA CAST.

- Follow the on-screen instructions. Enter the 4-digit password with the numbered buttons when the password screen is shown.

##### Audio Auto Gain Control

Volume that is different depending on the contents is adjusted automatically to the standard volume while using the VIERA CAST.

- Depending on contents, this function effect will not work.
- Select "Off" when the audio is warped.

##### Time Zone

By selecting the time zone, it is possible to set the unit's time to match your location.

- Some VIERA CAST contents require the time zone to be set. Set the time zone if necessary.

##### Summer Time

- Select "On" when using Daylight Saving time.

#### MAC Address

Displays the MAC address of this unit.

## Remote Control

Change the remote control code if other Panasonic products react to this remote control.

### Quick Start

Speed of startup from standby mode is increased.

- Internal control unit will be powered when it is set to "On" so compared to when the setting is "Off" the following will occur.
  - Idle power consumption will increase. (about the power consumption⇒ 36)

### Easy Setting

You can execute basic settings ("On-Screen Language", "TV Aspect", "Quick Start")

### Default Settings

This returns all values in the Setup menu and the playback menu, except for "Remote Control", "On-Screen Language", "IP Address / DNS Settings" BD65, "Proxy Server Settings" BD65, "Lock" BD65, "DVD-Video Ratings" and "BD-Video Ratings" to the default settings.

## DivX Registration (⇒ 19)

You need this registration code to purchase and play DivX Video-on-Demand (VOD) content.

### System Information

Display firmware version of this unit and wireless LAN module of your Wireless LAN Adaptor BD65.

## Firmware Update BD65 (⇒ 14)

Press [OK] to show the following settings.

### Automatic Update Check

When this equipment remains connected to the Internet, it will check for the latest firmware version when it is turned on and you can update it if necessary.

### Update Now

You can update the firmware manually if a firmware update is available.

# Troubleshooting guide

Before requesting service, please perform the following steps.

## Do you have the latest firmware installed?

Firmware updates may be released to correct operating irregularities that are discovered with certain movies.  
(⇒ 14)

▼  
**Make the following checks.  
If the problem remains unresolved, consult  
your dealer for instructions.**

The following do not indicate a problem with this unit:

- Regular disc rotating sounds.
- Image disturbance during search.

## ■ Unit doesn't respond to remote control or front panel buttons.

Press and hold [⏻] on the main unit for 3 seconds.  
– If still unable to turn the unit off, disconnect the AC mains lead, wait 1 minute, then reconnect the AC mains lead.

## ■ Cannot eject disc.

The unit may have a problem.

- ① While the unit is off, press and hold [OK], the yellow button and the blue button on the remote control at the same time for more than 5 seconds.  
– “00 RET” is displayed on the unit's display.
- ② Repeatedly press [▶] (right) on the remote control or [⏻] on the unit until “06 FTO” is displayed on the unit's display.
- ③ Press [OK] on the remote control or [▲ OPEN/CLOSE] on the unit.

## General operation

### To return to the factory preset.

- Select “Yes” in “Default Settings” in the Setup menu. (⇒ 29)

### To return all settings to the factory preset.

- Reset the unit as follows:
  - ① While the unit is off, press and hold [OK], the yellow button and the blue button on the remote control at the same time for more than 5 seconds.  
– “00 RET” is displayed on the unit's display.
  - ② Repeatedly press [▶] (right) on the remote control or [⏻] on the unit until “08 FIN” is displayed on the unit's display.
  - ③ Press and hold [OK] on the remote control or [▲ OPEN/CLOSE] on the unit for at least 3 seconds.

### Power of this unit is turned off when the input for the TV is switched.

- This is a normal phenomenon when using VIERA Link (HDAVI Control 4 or later). For details please read the operating instructions for the TV.

### The remote control doesn't work properly.

- The remote control and main unit are using different codes. If “SET 1”, “SET 2” or “SET 3” is displayed when a button is pressed on the remote control, change the code on the remote control. (⇒ 29)
- It may be necessary to set the manufacturer code or the remote control code again after changing the batteries for remote control. (⇒ 14)

### The TV tuner mode is not displayed when the TV is switched on.

- This phenomenon may occur, depending on the TV setting, when “Quick Start” is set to “On”.  
– Depending on the TV, this phenomenon may be prevented by reconnecting the HDMI cable to a different HDMI input terminal or by changing the HDMI auto connection setting.

### You have forgotten your ratings password. You want to cancel the ratings level.

- The ratings level returns to the factory preset.
  - ① While the unit is on, press and hold [OK], the yellow button and the blue button on the remote control at the same time for more than 5 seconds.  
– “00 RET” is displayed on the unit's display.
  - ② Repeatedly press [▶] (right) on the remote control or [⏻] on the unit until “03 VL” is displayed on the unit's display.
  - ③ Press [OK] on the remote control or [▲ OPEN/CLOSE] on the unit.

## Picture

### The images from this unit do not appear on the television.

#### Picture is distorted.

- An incorrect resolution is selected in “Component Resolution” **[BD65]** or “HDMI Video Format”. Reset the setting as follows:
  - ① While the unit is on, press and hold [OK], the yellow button and the blue button on the remote control at the same time for more than 5 seconds.
    - “00 RET” is displayed on the unit’s display.
  - ② Repeatedly press [▶] (right) on the remote control or [⏪/I] on the unit until “04 PRG” is displayed on the unit’s display.
  - ③ Press and hold [OK] on the remote control or [▲ OPEN/CLOSE] on the unit for at least 3 seconds.
    - Set the item again. (⇒ 28)
- When Dolby Digital Plus, Dolby TrueHD, and DTS-HD audio are not output in bitstream, select “Yes” in “Default Settings” and make proper settings. (⇒ 29)
- The unit and television are using different video systems. While stopped, keep pressing [■] and [▲ OPEN/CLOSE] on the main unit for 5 or more seconds. The system switches from PAL to NTSC or vice versa.
- The system used on the disc doesn’t match your television.
  - PAL discs cannot be correctly viewed on an NTSC television.
  - This unit can convert NTSC signals to PAL60 for viewing on a PAL television (“NTSC Contents Output” in the “Picture”).

#### Video is not output in high definition.

- Confirm that the “HDMI Video Mode” **[BD65]**, “HDMI Video Format”, and “Component Resolution” **[BD65]** in the Setup menu are set properly. (⇒ 28)
- **[BD65]** The video output resolution is restricted to “576p/480p” when DVD-Video discs, DivX and BD-Video discs recorded at a rate of 50 field per second are output from the COMPONENT VIDEO OUT terminals.

### A black band is displayed around the edge of the screen.

#### The aspect ratio of the screen is abnormal.

- Confirm the “TV Aspect” is set properly. (⇒ 28)
- Adjust the aspect setting on the television. (Adjustment using “Screen Aspect” (⇒ 17) on the unit is also possible.)

## Audio

### Cannot switch audio.

- When connecting an amplifier/receiver using an OPTICAL terminal or an HDMI terminal, you cannot switch the audio if “Digital Audio Output” is set to “Bitstream”. Set “Digital Audio Output” to “PCM” or connect using AUDIO OUT terminal. (⇒ 9, 27)

### Cannot hear the desired audio type.

- Check the connections and the “Digital Audio Output” settings. (⇒ 27)
- To output audio from a device connected with an HDMI cable, set “HDMI Audio Output” to “On” in the Setup menu. (⇒ 28)

## Playback

### Disc cannot be played.

- The disc is dirty. (⇒ 4)
- Check the region code.

### The contents of the USB device cannot be read.

- **[BD65]** USB devices connected using USB extension cable other than the supplied with the Wireless LAN Adaptor DY-WL10 (optional) or a USB hub may not be recognized by this unit.
- If inserted during playback the USB device may not be recognized by this unit.
- **[BD65]** If two USB devices other than Wireless LAN adaptor are connected simultaneously, they will not be recognized by this unit.

### Still pictures (JPEG) do not playback normally.

- The images that were edited on the PC, such as Progressive JPEG, etc., may not playback.

### I can’t play back BD-Live. **[BD65]**

- The SD card is write-protected. (⇒ 7)
- Confirm that this unit is connected to the broadband Internet. (⇒ 10, 29)
- Confirm the “BD-Live Internet Access” settings. (⇒ 26)
- Confirm an SD Card is inserted into the SD Card slot. (⇒ 15)

## Network **[BD65]**

### I can’t connect to the network.

- Confirm the network connection and settings. (⇒ 10, 29)
- Check the operating instructions for each device and connect accordingly.

# Messages

The following messages or service numbers appear on the television or unit's display when something unusual is detected during startup and use.

## On the television

### Cannot play.

- You inserted an incompatible disc.

### Cannot play on this unit.

- You tried to play a non-compatible image.
- Confirm "SD" on the unit's display is not blinking and re-insert the card.

### No disc is inserted.

- The disc may be upside down.

### ⊘ This operation is not available.

- Some operations are unsupported by the unit. For example;
  - BD-Video: During playback, reverse slow-motion or reverse frame-by-frame is not possible.

### IP address is not set. **[BD65]**

- The "IP Address" in "IP Address / DNS Settings" is "----. ---. ---. ---". Set the "IP Address", "Subnet Mask", and "Gateway Address". (Select the automatic address acquisition if necessary.)

## On the unit's display

### F99

- The unit fails to operate properly. Press [⏻/I] on the main unit for 3 seconds to switch the unit to standby, then switch back on.

### HDMI ONLY

- Some BD-Video discs can only be output with HDMI.

### NET **[BD65]**

- Displays while VIERA CAST is starting up.

### No PLAY

- There is a viewing restriction on a BD-Video or DVD-Video. (⇒ 26)

### No READ

- The media is dirty or badly scratched. The unit cannot play.

### PLEASE WAIT

- The unit is carrying out internal process. This is not a malfunction. You cannot operate the unit while "PLEASE WAIT" is displayed.

### REMOVE

- The USB device is drawing too much power. Remove the USB device.

### SET

("  " stands for a number.)

- The remote control and main unit are using different codes. Change the code on the remote control.

Press and hold [OK] and the indicated number button at the same time for more than 5 seconds.



### U59

- The unit is hot. The unit switches to standby for safety reasons. Wait for about 30 minutes until the message disappears. Select a position with good ventilation when installing the unit. Do not block the ventilation hole on the rear and side of the unit.

### U72

### U73

- The HDMI connection acts unusually.
  - Turn the unit and TV off.
  - Disconnect the HDMI cable between the player and the TV.
  - Please use HDMI cables that have the HDMI logo.
  - The connected equipment may not be compatible. If connecting through an amplifier/receiver, try connecting directly to the TV to see if message clears.

### H or F

("  " stands for a number.)

- There is something unusual.
- Check the unit using the troubleshooting guide. If the service number does not disappear, do the following.
  - ① Disconnect the plug from the household mains socket wait a few seconds, then reconnect it.
  - ② Press [⏻/I] to turn the unit on. (The unit may be fixed.) If the service number does not disappear despite doing the above, request service from the dealer. Inform the dealer of the service number when requesting service.

### START **[BD65]**

- The system is being restarted during the firmware update. Please do not turn off the unit.

### UPD/ **[BD65]**

("  " stands for a number.)

- The firmware is being updated. Please do not turn off the unit.

### FINISH

- The firmware update is complete.



# Audio Information

## About audio from audio output terminal

The audio output differs depending on which terminals are connected to the amplifier/receiver, and the settings on the unit. (⇒ 27, Digital Audio Output)

- The number of channels listed is the maximum possible number of output channels.

### HDMI AV OUT/DIGITAL AUDIO OUT

Terminal	HDMI AV OUT				DIGITAL AUDIO OUT	
	"Bitstream" <sup>*1</sup>		"PCM" <sup>*2,3</sup>		"Bitstream"	"PCM"
"BD-Video Secondary Audio"	"On" <sup>*4</sup>	"Off"	"On" <sup>*5</sup>	"Off"	"On"/"Off"	"On"/"Off"
Dolby Digital/ Dolby Digital EX <sup>6</sup>	Dolby Digital	Outputs using original audio	DVD-Video : 5.1ch PCM		Dolby Digital/ Dolby Digital EX <sup>7</sup>	Down-mixed 2ch PCM
			BD-Video : 7.1ch PCM <sup>8</sup>			
Dolby Digital Plus/ Dolby TrueHD	7.1ch PCM		Dolby Digital			
DTS Digital Surround/ DTS-ES <sup>6</sup>	DTS Digital Surround		DVD-Video : 5.1ch PCM		DTS Digital Surround/ DTS-ES <sup>7</sup>	
		BD-Video : 7.1ch PCM <sup>9</sup>				
DTS-HD High Resolution Audio/ DTS-HD Master Audio		7.1ch PCM <sup>9</sup>		DTS Digital Surround		
7.1ch LPCM	7.1ch PCM				Down-mixed 2ch PCM	

<sup>\*1</sup> When the connected equipment is not supported with these audio formats, the audio is output as Dolby Digital bitstream, DTS Digital Surround bitstream or down-mixed 2ch PCM (e.g., TV).

<sup>\*2</sup> When the connected equipment is not supported with multi channel surround, the audio is output as down-mixed 2ch PCM.

<sup>\*3</sup> [BD45] : Regardless of a condition, the maximum possible number is 5.1ch PCM.

<sup>\*4</sup> When playing BD-Video without secondary audio or button click sound, the audio is output as the same format as if "BD-Video Secondary Audio" was set to "Off".

<sup>\*5</sup> When playing BD-Video with secondary audio or button click sound, the audio is output as 5.1ch.

<sup>\*6</sup> With PCM output, Dolby Digital EX becomes PCM audio decoded as Dolby Digital, DTS-ES recorded to DVD-Video becomes PCM audio decoded as DTS Digital Surround, and DTS-ES recorded to BD-Video becomes PCM audio decoded as DTS-ES.

<sup>\*7</sup> When "BD-Video Secondary Audio" is set to "On", Dolby Digital EX is output as Dolby Digital and DTS-ES is output as DTS Digital Surround, however if playing BD-Video without secondary audio or button click sound, the audio is output as the original format.

<sup>\*8</sup> [BD65] : When BD-Video is played and "7.1ch Audio Reformatting" is set to "Off", the audio is output as 5.1ch.

<sup>\*9</sup> The audio output is amplified from 5.1ch or 6.1ch to 7.1ch depending on the DTS, Inc. specifications.

## Recommended audio output setting

The settings of the audio output vary depending on the connected equipment. Refer to the table below and set each of items.

Press [FUNCTION MENU] ⇒ select "To Others" ⇒ "[OK]" ⇒ select "Setup" ⇒ "[OK]" ⇒ "Sound" ⇒ Set each item

For details of the each item, refer to page 27.

Setup menu		Example of connected equipment			
		TV via HDMI <sup>*1</sup>	Receiver with HD audio <sup>*2</sup> decoder via HDMI	Receiver without HD audio <sup>*2</sup> decoder via HDMI	Receiver via OPTICAL
"Digital Audio Output"	"Dolby D/Dolby D +/Dolby TrueHD"	"PCM"	<u>"Bitstream"</u>	"PCM"	"PCM"
	"DTS/DTS-HD"	"PCM"	<u>"Bitstream"</u>	"PCM"	"PCM"
	"BD-Video Secondary Audio"	"Off"	"Off"	"Off"	"Off"
"PCM Down Conversion"		No effect	No effect	No effect	<u>"Off"</u> <sup>*3</sup>
"Downmix"		<u>"Stereo"</u>	No effect	No effect	<u>"Stereo"</u> <sup>*4</sup>

- Because underlined items are the factory presets, it is not necessary to change these settings.

<sup>\*1</sup> If connected to TV via except HDMI, these settings have no effect.

<sup>\*2</sup> HD audio: Dolby Digital Plus, Dolby TrueHD, DTS-HD High Resolution Audio and DTS-HD Master Audio

<sup>\*3</sup> If the connected equipment that does not support 96 kHz, set to "On".

<sup>\*4</sup> If the connected equipment that supports the virtual surround function, set to "Surround encoded".

# About MP3/JPEG/DivX/AVCHD/MPEG2 files

## MP3

<b>File format</b>	<b>MP3</b>
<b>Extension</b>	Files must have the extension ".mp3" or ".MP3".
<b>Compression rate</b>	32 kbps to 320 kbps
<b>Sampling rate</b>	44.1 kHz/48 kHz
<b>Reference</b>	ID3 tags: version 1, 2.2, 2.3, 2.4 (Only titles and the names of artists)

## JPEG

<b>File format</b>	<b>JPEG</b>
<b>Extension</b>	Files must have the extension ".jpg" or ".JPG".
<b>Picture resolution</b>	between 34×34 and 8192×8192 pixels (sub sampling is 4:2:2 or 4:2:0)
<b>Reference</b>	JPEG conforming DCF* is supported. <ul style="list-style-type: none"> <li>• MOTION JPEG and Progressive JPEG is not supported.</li> </ul>

\* Design rule for Camera File system: unified standard established by Japan Electronics and Information Technology Industries Association (JEITA).

- DVD-RAM must conform to UDF 2.0.
- BD-RE must conform to UDF 2.5.

## DivX

<b>File format</b>	<b>DivX</b>
<b>Extension</b>	Files must have the extension ".DIVX", ".divx", ".AVI" or ".avi".
<b>Picture resolution</b>	Up to 1920×1080 pixels
<b>Reference</b>	<ul style="list-style-type: none"> <li>• DivX certified to play DivX video up to HD 1080p, including premium content.  <b>Video</b> <ul style="list-style-type: none"> <li>– Number of stream: Up to 1</li> <li>– Codec: DIV3, DIV4, DIVX, DX50, DIV6</li> <li>– FPS (Frame Per Second): Up to 60 fps</li> </ul> <b>Audio</b> <ul style="list-style-type: none"> <li>– Number of stream: Up to 8</li> <li>– Format: MP3, MPEG, Dolby Digital</li> <li>– Multi channel: Dolby Digital is possible. MPEG multi is 2 ch conversion.</li> </ul> </li> <li>• GMC (Global Motion Compensation) is not supported.</li> </ul>

- DVD-R and DVD-R DL must conform to UDF 1.02 without ISO9660 and UDF 1.5 with ISO9660.
- BD-R must conform to UDF 2.5.

## Subtitles text file of DivX

<b>File format</b>	<b>Subtitles text file of DivX</b>
<b>File format</b>	MicroDVD, SubRip, or TMLayer
<b>Extension</b>	Files must have the extension ".SRT", ".srt", ".SUB", ".sub", ".TXT", or ".txt"
<b>Reference</b>	<ul style="list-style-type: none"> <li>• The DivX video file and subtitles text file are inside the same folder, and the file names are the same except for the file extensions.</li> <li>• Depending on the methods used to create the file or the state of the recording, only parts of the subtitles may be displayed, or the subtitles may not be displayed at all.</li> </ul>

## AVCHD

<b>File format</b>	<b>AVCHD format (V1.0) used on High Definition Video Camera</b> (Panasonic and some other's)
<b>Codec</b>	MPEG-4 AVC/H.264
	<ul style="list-style-type: none"> <li>• Discs must conform to UDF 2.5.</li> </ul>

## MPEG2

<b>File format</b>	<b>SD-Video format* used on Standard Definition Video Camera</b> (Panasonic and some other's)
<b>Codec</b>	MPEG2

\* SD-Video Entertainment Video Profile



- With certain recording states and folder structures, the play order may differ or playback may not be possible.
- CD-R, CD-RW : ISO9660 level 1 or 2 (except for extended formats), Joliet  
This unit is compatible with multi-session.  
This unit is not compatible with packet writing.
- DVD-R, DVD-R DL (except for AVCHD) : ISO9660 level 1 or 2 (except for extended formats), Joliet, UDF bridge (UDF 1.02/ISO9660)  
This unit is not compatible with multi-session.  
This unit is not compatible with packet writing.

# Structure of folders that can be played in this unit

You can play files on this unit by structure of folders as shown below. However depending on the method of writing data (writing software), play may not be in the order you numbered the folders.

 : Folder which can be displayed with this unit

\*\*\*: Numbers

XXX: Letters

\*1 \*\*\*: from 001 to 999

\*2 \*\*\*: from 100 to 999

XXXXX: 5 figures

\*3 \*\*\*: from 0001 to 9999

XXXX: 4 figures

## Structures of still picture (JPEG) folders

in DVD-R<sup>\*4</sup>/DVD-R DL<sup>\*4</sup>/CD-R<sup>\*5</sup>/CD-RW<sup>\*5</sup>

Files inside a folder are displayed in the order they were updated or taken.

Root e.g.,

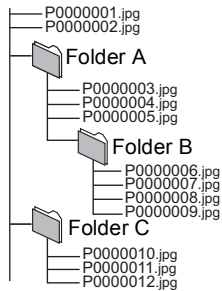

in BD-RE<sup>\*6</sup>/DVD-RAM<sup>\*4</sup>

● Folder structure is not displayed.

Root e.g.,

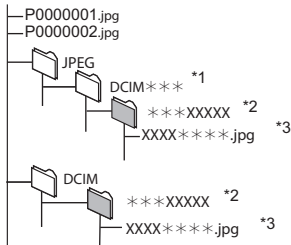

in SD card<sup>\*4</sup>/USB device<sup>\*4</sup>

Displays JPEG files in all folders.

● Folder structure is not displayed.

Root e.g.,

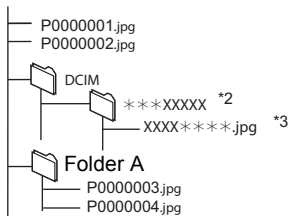

## Structure of MP3 folders

in DVD-R/DVD-R DL/CD-R/CD-RW/USB device

Prefix the file names with 3-digit numbers in the order you want to play them.

Root e.g.,

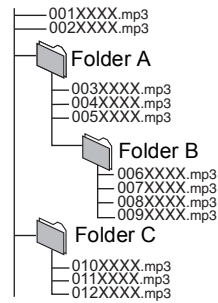

## Structure of DivX folders

in BD-R<sup>\*7</sup>/DVD-R<sup>\*7</sup>/DVD-R DL<sup>\*7</sup>/CD-R<sup>\*7</sup>/CD-RW<sup>\*7</sup>/USB device<sup>\*7</sup>

Files inside a folder are displayed in the order they were updated or taken.

Root e.g.,

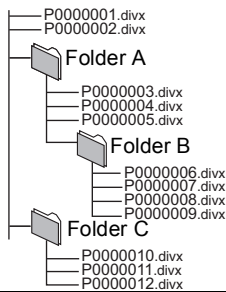

<sup>\*4</sup> The total combined maximum number of recognizable picture contents and folders: 3000 picture contents and 300 folders.

<sup>\*5</sup> The total combined maximum number of recognizable picture contents and folders: 999 picture contents and 99 folders.

<sup>\*6</sup> The total combined maximum number of recognizable picture contents and folders: 9999 picture contents and 300 folders.

<sup>\*7</sup> The total combined maximum number of recognizable file contents and folders: 200 file contents and 300 folders.

# Specifications

<b>Signal system:</b>	PAL/NTSC
<b>Operating temperature range:</b>	+5 °C to +35 °C
<b>Operating humidity range:</b>	10 % to 80 % RH (no condensation)
<b>Video output:</b>	1.0 Vp-p (75 Ω)/Pin jack :1 system
<b>BD65 Component video output (Y: green, Pb: blue, Pr: red):</b>	Y :1.0 Vp-p (75 Ω)/Pb, Pr : 0.7 Vp-p (75 Ω)/Pin jack:1 system
<b>Audio output:</b>	2 Vrms (1 kHz, 0 dB)/Pin jack
Number of connectors :	2 channel:1 system
<b>Digital audio output:</b>	Optical digital output :Optical terminal
<b>HDMI AV output:</b>	Type A (19 pin) HDMI (V.1.4, Content Type) This unit supports "HDAVI Control 5" function.
<b>SD card slot:</b>	Connector : 1 system
<b>USB slot:</b>	USB2.0 : 1 system
<b>BD65 : Ethernet:</b>	10BASE-T/100BASE-TX : 1 system
<b>LASER Specification</b>	
<b>Class 1 LASER Product:</b>	
Wave length:	790 nm (CDs)/655 nm (DVDs)/405 nm (BDs)
Laser power:	No hazardous radiation is emitted with the safety protection
<b>Power supply:</b>	AC 220 to 240 V, 50 Hz
<b>Power consumption:</b>	
BD65:	Approx. 20 W
BD45:	Approx. 19 W
<b>Power consumption in standby mode: Approx. 0.2 W</b>	
<b>Power consumption in quick start standby mode: Approx. 7 W</b>	
<b>Dimensions (W×D×H) : Including the projecting parts</b>	
	430 mm×207 mm×49 mm
<b>Mass:</b>	Approx. 1.9 kg

---

Specifications are subject to change without notice.

# Safety precautions

## ■ Placement

Set the unit up on an even surface away from direct sunlight, high temperatures, high humidity, and excessive vibration. These conditions can damage the cabinet and other components, thereby shortening the unit's service life. Do not place heavy items on the unit.

## ■ Voltage

Do not use high voltage power sources. This can overload the unit and cause a fire. Do not use a DC power source. Check the source carefully when setting the unit up on a ship or other place where DC is used.

## ■ AC mains lead protection

Ensure the AC mains lead is connected correctly and not damaged. Poor connection and lead damage can cause fire or electric shock. Do not pull, bend, or place heavy items on the lead.

Grasp the plug firmly when unplugging the lead. Pulling the AC mains lead can cause electric shock. Do not handle the plug with wet hands. This can cause electric shock.

## ■ Foreign matter

Do not let metal objects fall inside the unit. This can cause electric shock or malfunction.

Do not let liquids get into the unit. This can cause electric shock or malfunction. If this occurs, immediately disconnect the unit from the power supply and contact your dealer.

Do not spray insecticides onto or into the unit. They contain flammable gases which can ignite if sprayed into the unit.

## ■ Service

Do not attempt to repair this unit by yourself. If sound is interrupted, indicators fail to light, smoke appears, or any other problem that is not covered in these instructions occurs, disconnect the AC mains lead and contact your dealer or an authorized service centre. Electric shock or damage to the unit can occur if the unit is repaired, disassembled or reconstructed by unqualified persons.

Extend operating life by disconnecting the unit from the power source if it is not to be used for a long time.

# Supplemental information

## ■ TV/Amplifier/Receiver code list

Brand	TV Code	Brand	TV Code
Panasonic	01/02/03/04	NEC	36
AIWA	35	NOBLEX	33
AKAI	27/30	NOKIA	25/26/27/60/61
BEKO	05/71/72/73/74	NORDMENDE	10
BENQ	58/59	OLEVIA	45
BRANDT	10/15	ONWA	30/39/70
BUSH	05	ORION	05
CENTREX	66	PEONY	49/69
CURTIS	05	PHILCO	41/48/64
DAEWOO	64/65	PHILIPS	05/06/46
DESMET	05	PHONOLA	05
DUAL	05	PIONEER	37/38
ELEMIS	05	PROVIEW	52
FERGUSON	10/34	PYE	05
FINLUX	61	RADIOLA	05
FISHER	21	SABA	10
FUJITSU	53	SALORA	26
FUNAI	63/67	SAMSUNG	32/42/43/65/68
GOLDSTAR	05/50/51	SANSUI	05
GOODMANS	05	SANYO	21/54/55/56
GRADIENTE	36	SCHNEIDER	05/29/30
GRUNDIG	09	SEG	05/69/75/76/77/78
HITACHI	05/22/23/40/41	SELECO	05/25
IRRADIO	30	SHARP	18
ITT	25	SIEMENS	09
JVC	17/30/39/70	SINUDYNE	05
KDS	52	SONY	08
KOLIN	45	TCL	31/33/66/67/69
KONKA	62	TELEFUNKEN	10/11/12/13/14
LG	05/50/51	TEVION	52
LOEWE	07/46	THOMSON	10/15/44
MAG	52	TOSHIBA	16/57
METZ	05/28	WHITE	
MITSUBISHI	05/19/20/47	WESTINGHOUSE	05
MIVAR	24	YAMAHA	18/41

Brand	Amplifier/ Receiver Code	Brand	Amplifier/ Receiver Code
Panasonic	01/02/03	MARANTZ	20/21
TECHNICS	35	MCINTOSH	54
ADCOM	62	NAD	22/55
AIWA	04/05/06/48/49	NAKAMICHI	60/61
ALPINE	63	ONKYO	23
ARCAM	57/58	OUTLAW	56
BOSE	07	PREAMP	
DENON	08/09/10/11/50/51/52	PHILIPS	24/44
HARMAN	12	PIONEER	25/26/27/28
KARDON	12	SAMSUNG	45/46/47
JVC	13/14	SONY	29/30/31
KENWOOD	15/16/17	TEAC	32/33/34
KLH	18	THOMSON	43/53
LG	19	YAMAHA	36/37/38/39/40/41/42
LUXMAN	59		

## ■ Video attribute

Display	Meaning
MPEG-2/MPEG-4 AVC/VVC-1	Video recording method

## ■ Audio attribute

Display	Meaning
LPCM/ <input checked="" type="checkbox"/> Digital/ <input checked="" type="checkbox"/> Digital+/ <input checked="" type="checkbox"/> TrueHD/DTS/DTS 96/DTS-HD HI RES/ DTS-HD MSTR/MPEG	Signal type
ch (channel)	Number of channels
k (kHz)	Sampling frequency
b (bit)	Number of bits

## ■ Display languages list

Display Language	Display Language	Display Language
ENG English	JPN Japanese	ARA Arabic
FRA French	CHI Chinese	HIN Hindi
DEU German	KOR Korean	PER Persian
ITA Italian	MAL Malay	IND Indonesian
ESP Spanish	VIE Vietnamese	MRI Maori
NLD Dutch	THA Thai	BUL Bulgarian
SVE Swedish	POL Polish	RUM Romanian
NOR Norwegian	CES Czech	GRE Greek
DAN Danish	SLK Slovak	TUR Turkish
POR Portuguese	HUN Hungarian	* Others
RUS Russian	FIN Finnish	

## ■ Language code list

Language Code	Language Code	Language Code
Abkhazian: 6566	Gujarati: 7185	Rhaeto-Romance: 8277
Afar: 6565	Hausa: 7265	Romanian: 8279
Afrikaans: 6570	Hebrew: 7387	Russian: 8285
Albanian: 8381	Hindi: 7273	Samoan: 8377
Amharic: 6577	Hungarian: 7285	Sanskrit: 8365
Arabic: 6582	Icelandic: 7383	Scots Gaelic: 7168
Armenian: 7289	Indonesian: 7378	Serbian: 8382
Assamese: 6583	Interlingua: 7365	Serbo-Croatian: 8372
Aymara: 6589	Irish: 7165	Shona: 8378
Azerbaijani: 6590	Italian: 7384	Sindhi: 8368
Bashkir: 6665	Japanese: 7465	Singhalese: 8373
Basque: 6985	Javanese: 7487	Slovak: 8375
Bengali; Bangla: 6678	Kannada: 7578	Slovenian: 8376
	Kashmiri: 7583	Somali: 8379
Bhutani: 6890	Kazakh: 7575	Spanish: 6983
Bihari: 6672	Kirghiz: 7589	Sundanese: 8385
Breton: 6682	Korean: 7579	Swahili: 8387
Bulgarian: 6671	Kurdish: 7585	Swedish: 8386
Burmese: 7789	Laotian: 7679	Tagalog: 8476
Byelorussian: 6669	Latin: 7665	Tajik: 8471
Cambodian: 7577	Latvian, Lettish: 7686	Tamil: 8465
Catalan: 6765	Lingala: 7678	Tatar: 8484
Chinese: 9072	Lithuanian: 7684	Telugu: 8469
Corsican: 6779	Macedonian: 7775	Thai: 8472
Croatian: 7282	Malagasy: 7771	Tibetan: 6679
Czech: 6783	Malay: 7783	Tigrinya: 8473
Danish: 6865	Malayalam: 7776	Tonga: 8479
Dutch: 7876	Maltese: 7784	Turkish: 8482
English: 6978	Maori: 7773	Turkmen: 8475
Esperanto: 6979	Marathi: 7782	Tw: 8487
Estonian: 6984	Moldavian: 7779	Ukrainian: 8575
Faroese: 7079	Mongolian: 7778	Urdu: 8582
Fiji: 7074	Nauru: 7865	Uzbek: 8590
Finnish: 7073	Nepali: 7869	Vietnamese: 8673
French: 7082	Norwegian: 7879	Volapük: 8679
Frisian: 7089	Oriya: 7982	Welsh: 6789
Galician: 7176	Pashto, Pushto: 8083	Wolof: 8779
Georgian: 7565	Persian: 7065	Xhosa: 8872
German: 6869	Polish: 8076	Yiddish: 7473
Greek: 6976	Portuguese: 8084	Yoruba: 8979
Greenlandic: 7576	Punjabi: 8065	Zulu: 9085
Guarani: 7178	Quechua: 8185	

# Glossary

## **AVCHD**

AVCHD is a new format (standard) for high definition video cameras that can be used to record and play high-resolution HD images.

## **BD-J**

Some BD-Video discs contain Java applications, and these applications are called BD-J. You can enjoy various interactive features in addition to playing normal video.

## **Deep Colour**

This unit incorporates HDMI (V.1.4, Content Type) technology that can reproduce greater colour gradation (4096 steps) when connected to a compatible TV.

You can enjoy exceptionally rich, natural-looking colours, with smooth, detailed gradation and minimal colour banding.

[A lower colour gradation (256 steps), without Deep Colour, will be reproduced if connected to a TV which does not support Deep Colour.

The unit will automatically set appropriate output to suit the connected TV.]

## **Dolby Digital**

This is a method of coding digital signals developed by Dolby Laboratories. Apart from stereo (2-channel) audio, these signals can also be multi-channel audio.

## **Dolby Digital Plus**

Multi-channel audio and higher audio quality is made possible using Dolby Digital Plus. BD-Video supports up to 7.1 channel output.

## **Dolby TrueHD**

Dolby TrueHD is a very high quality audio format that reproduces the studio master audio. BD-Video supports up to 7.1 channel output.

## **DTS (Digital Theater Systems)**

This surround system is used in many movie theatres. There is good separation between the channels, so realistic sound effects are possible.

## **DTS-HD**

DTS-HD is a high-quality, sophisticated audio format used in movie theatres. Previous DTS Digital Surround-compatible equipment can play DTS-HD as DTS Digital Surround audio. BD-Video supports up to 7.1 channel output.

## **DTS-HD High Resolution Audio**

This is a signal format achieved by improving the previous DTS, DTS-ES and DTS 96/24 formats. It is compatible with sampling frequency 96 kHz/48 kHz. BD-Video supports up to 7.1 channel output.

## **DTS-HD Master Audio**

This is a lossless audio format and compatible with 96 kHz/7.1ch or less. In addition, faithful reproduction of the master audio is enabled using lossless audio encoding technology. BD-Video supports up to 7.1 channel output.

## **HDMI (High-Definition Multimedia Interface)**

HDMI is a digital interface for consumer electronic products. Unlike conventional connections, it transmits uncompressed digital video and audio signals on a single cable.

## **Local storage** BD65

This storage area is used as a destination for sub contents for playing BD-Live on BD-Video.

## **LPCM (Linear PCM)**

These are a kind of PCM format.

These are uncompressed digital signals, similar to those found on CDs.

## **P4HD (Pixel Precision Progressive Processing for HD)**

This is a processor which makes use of an exclusive Panasonic algorithm. Various processing is supported, including a high-level conversion of the TV scanning format from interlace to progressive and a high-level conversion of standard resolution (480i or 576i) video signal to a 1080 High Definition video signal.

Consequently, this unit is able to provide video of optimal resolution to the connected TV.

## **PCM (Pulse Code Modulation)**

This is one format for converting analogue audio into digital audio, enabling you to enjoy digital audio with no hassle.

## **x.v.Colour™**

x.v.Colour™ is a name for devices that are compatible with the xvYCC format, an international standard for expanded colour in motion pictures, and that follow the rules for signal transmission.

You can enjoy vivid colours of wider colour ranges for a more realistic picture when connected to a TV that supports the x.v.Colour™ with HDMI cable.

## **24p**

This is a progressive image recorded at a rate of 24 frames per second (motion-picture film). Many BD-Video movie contents are recorded in 24 frames/second in accordance with the film materials.

Java and all Java-based trademarks and logos are trademarks or registered trademarks of Sun Microsystems, Inc. in the United States and other countries.
Manufactured under license from Dolby Laboratories. Dolby and the double-D symbol are trademarks of Dolby Laboratories.
Manufactured under license under U.S. Patent #'s: 5,451,942; 5,956,674; 5,974,380; 5,978,762; 6,226,616; 6,487,535; 7,392,195; 7,272,567; 7,333,929; 7,212,872 & other U.S. and worldwide patents issued & pending. DTS and the Symbol are registered trademarks, & DTS-HD, DTS-HD Master Audio   Essential and the DTS logos are trademarks of DTS, Inc. Product includes software. © DTS, Inc. All Rights Reserved.
This product incorporates copyright protection technology that is protected by U.S. patents and other intellectual property rights. Use of this copyright protection technology must be authorized by Macrovision, and is intended for home and other limited viewing uses only unless otherwise authorized by Macrovision. Reverse engineering or disassembly is prohibited.
HDMI, the HDMI Logo, and High-Definition Multimedia Interface are trademarks or registered trademarks of HDMI Licensing LLC in the United States and other countries.
This product is licensed under the AVC patent portfolio license and VC-1 patent portfolio license for the personal and non-commercial use of a consumer to (i) encode video in compliance with the AVC Standard and VC-1 Standard ("AVC/VC-1 Video") and/or (ii) decode AVC/VC-1 Video that was encoded by a consumer engaged in a personal and non-commercial activity and/or was obtained from a video provider licensed to provide AVC/VC-1 Video. No license is granted or shall be implied for any other use. Additional information may be obtained from MPEG LA, LLC. See <a href="http://www.mpegla.com">http://www.mpegla.com</a> .
HDAVI Control™ is a trademark of Panasonic Corporation.
x.v.Colour™ is a trademark.
VIERA CAST™ is a trademark of Panasonic Corporation.
"AVCHD" and the "AVCHD" logo are trademarks of Panasonic Corporation and Sony Corporation.
SDXC Logo is a trademark of SD-3C, LLC.
DivX® is a registered trademark of DivX, Inc., and is used under license.
"Blu-ray Disc" is trademark.

"BD-LIVE" logo is trademark of Blu-ray Disc Association.
"BONUSVIEW" is trademark of Blu-ray Disc Association.
YouTube and Picasa are trademarks of Google, Inc.
This product incorporates the following software: (1) the software developed independently by or for Panasonic Corporation, (2) the software owned by third party and licensed to Panasonic Corporation, (3) the software licensed under the GNU General Public License, Version 2 (GPL v2), (4) the software licensed under the GNU LESSER General Public License, Version 2.1 (LGPL v2.1) and/or, (5) open sourced software other than the software licensed under the GPL v2 and/or LGPL v2.1 For the software categorized as (3) and (4), please refer to the terms and conditions of GPL v2 and LGPL v2.1, as the case may be at <a href="http://www.gnu.org/licenses/old-licenses/gpl-2.0.html">http://www.gnu.org/licenses/old-licenses/gpl-2.0.html</a> and <a href="http://www.gnu.org/licenses/old-licenses/lgpl-2.1.html">http://www.gnu.org/licenses/old-licenses/lgpl-2.1.html</a> . In addition, the software categorized as (3) and (4) are copyrighted by several individuals. Please refer to the copyright notice of those individuals at <a href="http://www.am-linux.jp/dl/JPRCBW98">http://www.am-linux.jp/dl/JPRCBW98</a> The GPL/LGPL software is distributed in the hope that it will be useful, but WITHOUT ANY WARRANTY, without even the implied warranty of MERCHANTABILITY or FITNESS FOR A PARTICULAR PURPOSE. At least three (3) years from delivery of products, Panasonic will give to any third party who contact us at the contact information provided below, for a charge no more than our cost of physically performing source code distribution, a complete machine-readable copy of the corresponding source code covered under GPL v2/LGPL v2.1. Contact Information <a href="mailto:cdrequest@am-linux.jp">cdrequest@am-linux.jp</a> Source code is also freely available to you and any other member of the public via our website below. <a href="http://www.am-linux.jp/dl/JPRCBW98">http://www.am-linux.jp/dl/JPRCBW98</a>

**Information for Users on Collection and Disposal of Old Equipment and used Batteries**

 These symbols on the products, packaging, and/or accompanying documents mean that used electrical and electronic products and batteries should not be mixed with general household waste.  
For proper treatment, recovery and recycling of old products and used batteries, please take them to applicable collection points, in accordance with your national legislation and the Directives 2002/96/EC and 2006/66/EC.  
By disposing of these products and batteries correctly, you will help to save valuable resources and prevent any potential negative effects on human health and the environment which could otherwise arise from inappropriate waste handling.  
For more information about collection and recycling of old products and batteries, please contact your local municipality, your waste disposal service or the point of sale where you purchased the items.  
Penalties may be applicable for incorrect disposal of this waste, in accordance with national legislation.

 **For business users in the European Union**  
If you wish to discard electrical and electronic equipment, please contact your dealer or supplier for further information.

 **[Information on Disposal in other Countries outside the European Union]**  
These symbols are only valid in the European Union. If you wish to discard these items, please contact your local authorities or dealer and ask for the correct method of disposal.

 **Note for the battery symbol (bottom two symbol examples):**  
This symbol might be used in combination with a chemical symbol. In this case it complies with the requirement set by the Directive for the chemical involved.

 Cd

# Index

<b>A</b> AC mains lead..... 11	<b>I</b> IP address..... 29	<b>C</b> Quick Start..... 29
Angle..... 24	<b>J</b> JPEG..... 20, 34	<b>R</b> Random play..... 24
Audio	<b>L</b> LAN..... 10	Re-master..... 17, 25
Changing audio..... 16	Language	Remote control..... 4, 5, 14
Channel..... 24	Audio..... 24, 26	Repeat play..... 24
Language..... 24, 26	Menu..... 26	Resume play function..... 16
<b>AVCHD</b> ..... 34	On-Screen..... 27	<b>S</b> SD card..... 7, 18
<b>B</b> BD-Live..... 18	Soundtrack..... 24	Setup menu..... 26
<b>BD-Video Ratings</b> ..... 26	Subtitle..... 24, 26	Slideshow..... 20
<b>BONUSVIEW</b> ..... 18	Local storage..... 38	Slow-motion..... 16
<b>C</b> Chapter..... 17	<b>M</b> MPEG2..... 34	Soundtrack..... 24
Cleaning..... 4	MP3..... 21, 34	Status Message..... 16
Connection..... 8, 9, 10, 11	<b>N</b> Network	Still picture..... 20
<b>D</b> Deep Colour..... 38	Connection..... 10	Subtitle..... 24
<b>Default Settings</b> ..... 29	Setting..... 12, 29	<b>U</b> USB device..... 7
<b>DIRECT NAVIGATOR</b> ..... 16	<b>O</b> On-Screen Language..... 27	<b>V</b> VIERA CAST™..... 23
<b>DivX</b> ..... 19, 34	<b>P</b> Picture-in-picture..... 18	VIERA Link
<b>DNS Server</b> ..... 29	Playback	“HDAVI Control™”..... 22
<b>Dolby Digital</b> ..... 27, 33	AVCHD..... 16	<b>W</b> Wireless LAN..... 10
<b>Dolby Digital Plus</b> ..... 27, 33	DivX..... 16	<b>X</b> x.v.Colour™..... 38
<b>Dolby TrueHD</b> ..... 27, 33	JPEG..... 20	
<b>DTS</b> ..... 27, 33	MPEG2..... 16	24p..... 25, 28
<b>DTS-HD</b> ..... 27, 33	MP3..... 21	
<b>DVD-Video Ratings</b> ..... 26	Playlists..... 15	
<b>F</b> Finalize..... 7	Pop-up menu..... 16	
<b>Firmware update</b> ..... 14	Proxy Server..... 29	
<b>Frame-by-frame</b> ..... 16	P4HD..... 38	
<b>H</b> HDMI..... 8, 9		

<b>CAUTION</b>	VISIBLE AND INVISIBLE LASER RADIATION WHEN OPEN. DO NOT STARE INTO BEAM. FDA 21 CFR/Class II (IIa)
<b>CAUTION</b>	CLASS 1M VISIBLE AND INVISIBLE LASER RADIATION WHEN OPEN. DO NOT VIEW DIRECTLY WITH OPTICAL INSTRUMENTS. IEC60825-1: A2/CLASS 1M
<b>ATTENTION</b>	RAYONNEMENT LASER VISIBLE ET INVISIBLE, CLASSE 1M. EN CAS D'OUVERTURE, NE PAS REGARDER DIRECTEMENT À L'AIDE D'INSTRUMENTS D'OPTIQUE.
<b>FORSIGTIG</b>	SYNLIG OG USYNLIG LASERSTRÅLING KLASSE 1M. NÅR LÅGET ER ÅBENT, UNDGÅ AT SE UD I PÅ MED OPTISKE INSTRUMENTER.
<b>VARO</b>	AVATTAESSA OLET ALTIIN LUOKAN 1M NÄKYVÄÄ JA NÄKYMÄTÖNTÄ LASERSÄTELYÄ. ÄLÄ KATSO OPTISELLA LAITTEELLA SUORAAN SÄTEESEEN.
<b>WARNING</b>	CLASS 1M SYNLIIG OCH OSYNLIIG LASERSTRÅLNING NÅR DENNA DEL ÄR ÖPPNAD. BETRÄKTA EJ STRÅLEN DIREKT GENOM OPTISKT INSTRUMENT.
<b>VORSICHT</b>	SICHTBARE UND UNSICHTBARE LASERSTRAHLUNG KLASSE 1M. WENN ABDECKUNG GEÖFFNET, NICHT DIREKT MIT OPTISCHEN INSTRUMENTEN BETRACHTEN.
<b>注意</b>	→ 打开时有可见及不可见激光辐射。避免光束照射。
<b>注意</b>	→ ここを開くと可視及び不可視レーザー光が出ます。 ビームを見たり、触れたりしないでください。 VQL-1V70

(Inside of product)



(Back of product)

EU



Environment friendly printed on chlorine free bleached paper.

Panasonic Corporation

Web Site: <http://panasonic.net>

Pursuant to at the directive 2004/108/EC, article 9(2)  
Panasonic Testing Centre  
Panasonic Marketing Europe GmbH  
Winsbergring 15, 22525 Hamburg, Germany



\*VQT2H94\*

VQT2H94  
F0110SS0