

## Automatic Breadmaker

OPERATING INSTRUCTIONS AND RECIPES (Household Use)

Model No. **SD-257/SD-256**

Thank you for purchasing this Panasonic product.

- Please read these instructions carefully before using this product and save this manual for future use.
- These operating instructions are intended to be used for two different models. The explanations inside mainly focus on the SD-257 model. (See page 2 for the differences in functions between the two)
- This product is intended for household use only.



SD-257 pictured

Before Use

How to Use

Recipes

How to Clean

Troubleshooting



# Contents

## Before Use

- Safety Instructions ..... 3
- Accessories/Parts Identification ..... 4
- Bread-making Ingredients ..... 6

## How to Use

- Baking Bread [BAKE] ..... 8
- Making Dough [DOUGH] ..... 10
- When adding extra ingredients... ..... 11
- Baking Brioche ..... 12
- Baking Cakes ..... 14
- List of Bread Types and Baking Options ..... 15

## Recipes



- Bread Recipes
  - basic ..... 16
  - whole wheat ..... 17
  - rye ..... 19
  - french ..... 20
  - italian ..... 21
  - brioche ..... 21
  - sandwich ..... 21



- Gluten Free Recipes ..... 22
- Dough Recipes ..... 24
  - basic
  - whole wheat
  - rye
  - french
  - pizza



- Cake Recipes ..... 30
  - cakes
  - teabreads

## How to Clean

- Care & Cleaning ..... 34

## To Protect the Non-stick Finish

- To protect the non-stick finish ..... 35

## Troubleshooting

- Troubleshooting ..... 36

## These instructions are for two different breadmaker models

### ■ SD-257

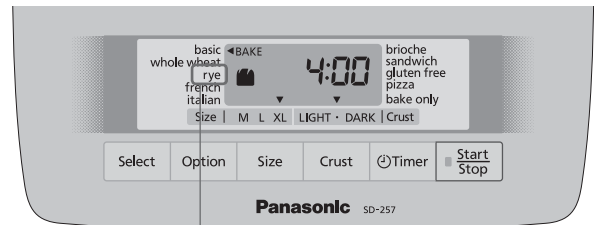

Rye bread mode is available

### ■ SD-256

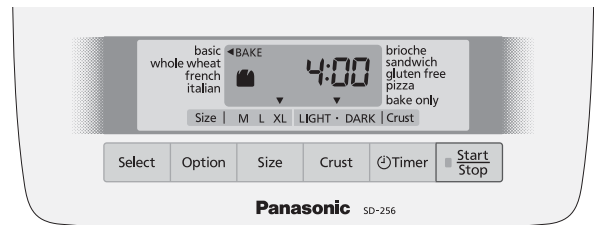

### ■ SD-257



If using dried fruit such as raisins, nuts, or seeds, these are added automatically. (P.11)

### ■ SD-256

Additional ingredients should be added manually when the beep sounds. (P.11)



● The photographs and illustrations in this manual are of the SD-257 model.

# Safety Instructions

## Important Safety Precautions

### ■ Location

- Do not use the appliance outdoors or in the immediate vicinity of heat sources or in rooms where humidity is high.
- **Position the breadmaker on a firm, dry, clean, flat heatproof worktop at least 10 cm (4 inches) from the edge of the worktop.**
- Do not place on unstable surfaces, or on electrical items such as fridges or on materials such as tablecloths.
- During baking the casing heats up, the breadmaker should be placed at least 5 cm (2 inches) from walls and other objects.

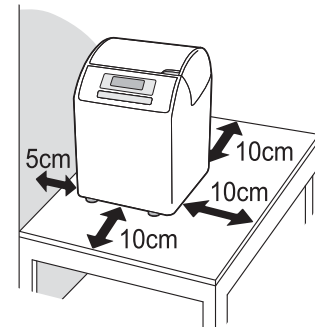

### ■ Caution

1. If the supply cord is damaged, it must be replaced by the manufacturer, its service agent or a similarly qualified person in order to avoid a hazard.
2. Do not attempt to repair the breadmaker. Consult a Panasonic dealer and have it serviced by an authorised technician.
3. Do not immerse the unit, power cord, or plug in water or any kind of liquid.
4. Do not allow the power cord to hang over the edge of the worktop or touch a hot surface.
5. Do not remove the bread pan or unplug the breadmaker during its operation. (If the electricity supply is switched off the program sequence stops. However the appliance has a 10 minute memory so if the power is restored within 10 minutes, the program will resume.)
6. Do not touch, block or cover steam vent during use.
7. The surfaces are liable to get hot during use.
8. To avoid burns, always use oven gloves when removing the bread pan and the finished bread. Also take care when removing the kneading blade.
9. Always keep the inside of the unit and the bread pan clean to ensure programs work successfully. (See page 34 for care and cleaning.)
10. This appliance is not intended for use by persons (including children) with reduced physical, sensory or mental capabilities, or lack of experience and knowledge, unless they have been given supervision or instruction concerning use of the appliance by a person responsible for their safety. Children should be supervised to ensure that they do not play with the appliance.
11. This appliance is only intended to be used to make bread, dough and cakes as detailed in the following instructions.
12. This appliance is not intended to be operated by means of an external timer or separate remote-control system.



Before Use



## Electrical Requirement

### FOR YOUR SAFETY PLEASE READ THE FOLLOWING TEXT CAREFULLY.

This appliance is supplied with a moulded three pin mains plug for your safety and convenience.

A 13-amp fuse is fitted in this plug.

Should the fuse need to be replaced please ensure that the replacement fuse has a rating of 13 amps and that it is approved by ASTA or BSI to BS1362.

Check for the ASTA mark  or the BSI mark  on the body of the fuse.

If the plug contains a removable fuse cover you must ensure that it is refitted when the fuse is replaced.

If you lose the fuse cover the plug must not be used until a replacement cover is obtained.

A replacement fuse cover can be purchased from your local Panasonic Dealer.

IF THE FITTED MOULDED PLUG IS UNSUITABLE FOR THE SOCKET OUTLET IN YOUR HOME, THEN THE FUSE SHOULD BE REMOVED AND THE PLUG CUT OFF AND DISPOSED OF SAFELY.

THERE IS A DANGER OF SEVERE ELECTRICAL SHOCK IF THE CUT OFF PLUG IS INSERTED INTO ANY 13-AMP SOCKET.

## Raisin nut dispenser (SD-257 only)

The ingredients placed in the raisin nut dispenser will drop into the bread pan automatically upon selecting the 'BAKE RAISIN' or 'RAISIN DOUGH' mode.

Turn to P.11 for ingredients which may be placed in the raisin nut dispenser.

Never operate the breadmaker without the dispenser being in place.

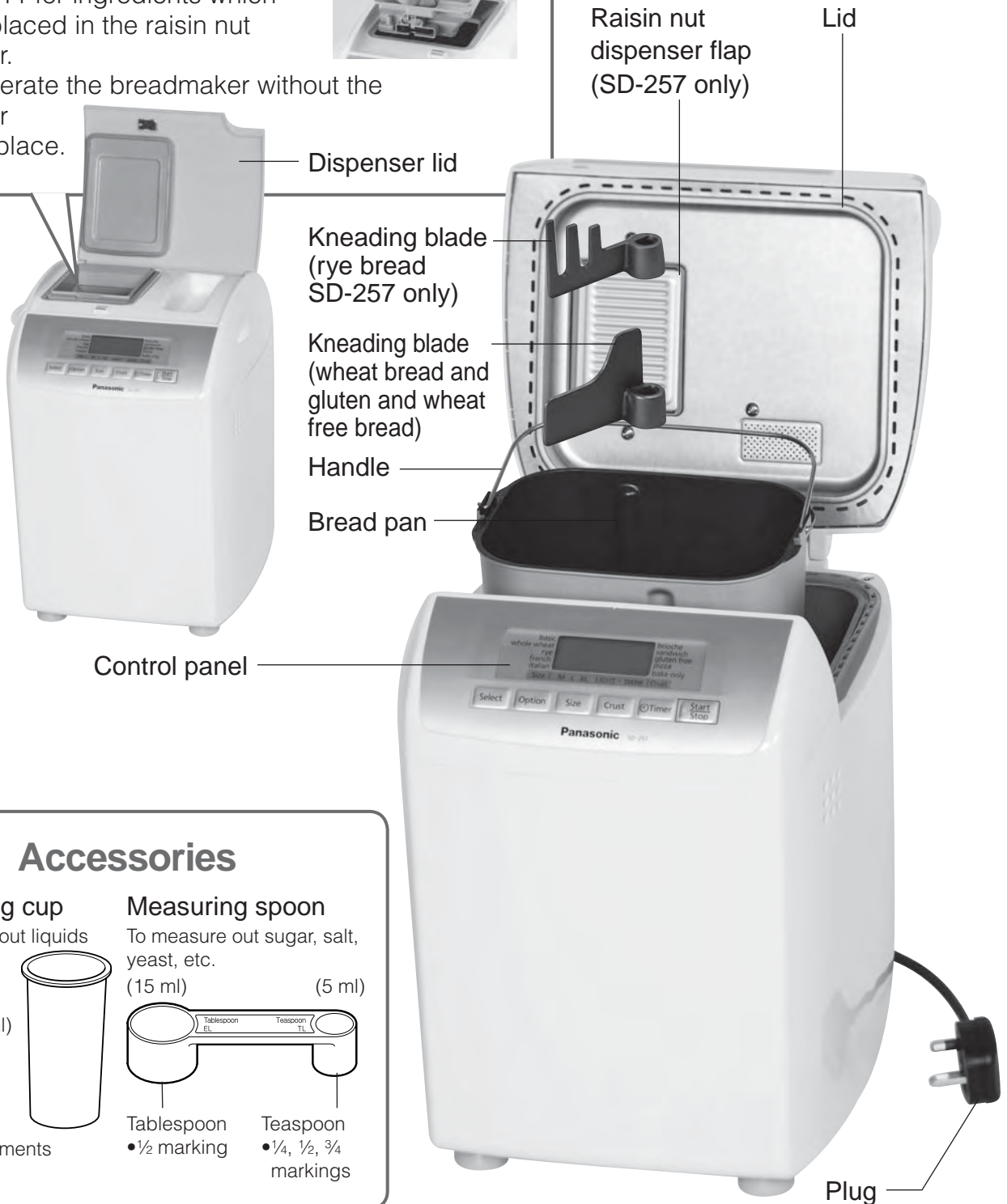

## Accessories

### Measuring cup

To measure out liquids

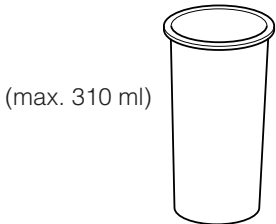

(max. 310 ml)

•10 ml increments

### Measuring spoon

To measure out sugar, salt, yeast, etc.

(15 ml) (5 ml)

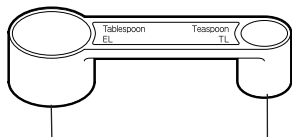

Tablespoon  
•½ marking

Teaspoon  
•¼, ½, ¾ markings

# Control Panel

## ■ Operation status

- **REST:** Displayed during the initial stage or with timer operation when the temperature of the bread pan and ingredients is being regulated before kneading
- **POWER ALERT:** displayed when there has been an interruption in the power supply
- **TEMP:** Displayed when the unit is hot – allow to cool before use

## ■ Options

As the option pad is pressed the option chosen will flash.

## ■ Time remaining until program finished

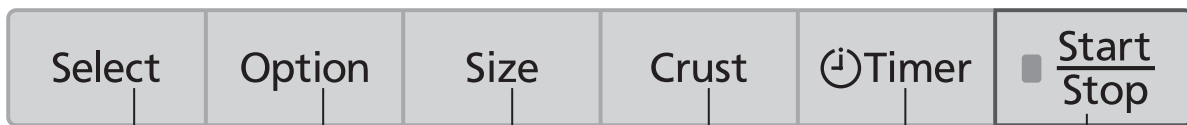
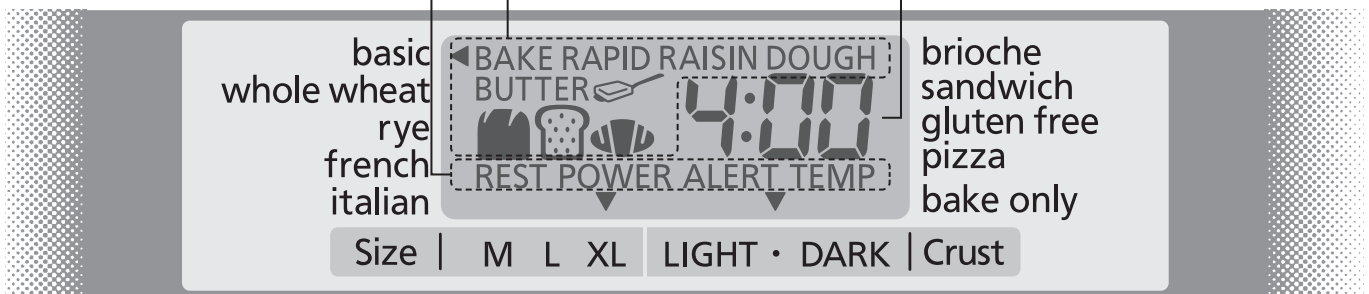

● **Select:** Choose type of bread or dough. Each time this pad is pressed, the arrow on the right of the display will move down to the next choice.

- basic
- whole wheat
- rye (SD-257 only)
- french
- italian
- brioche
- sandwich
- gluten free
- pizza
- bake only

● **Option:** For Standard Bake or Pizza Dough it is not necessary to press this pad. Press the option pad to choose Bake Rapid, Bake Raisin, Dough, Raisin Dough, Bake Butter.

- e.g. (basic)
- **BAKE** Bake bread (knead, rise, bake)
- **BAKE RAPID** Faster baking process
- **BAKE RAISIN** Bake bread with added ingredients
- **DOUGH** Make dough (knead, rise)
- **DOUGH RAISIN** Make dough with added ingredients
- **BAKE BUTTER**

● **Size:** Available on basic and whole wheat

- M
- L
- XL

● **Timer:** Set delay timer (time until bread is ready) or set the baking time for 'bake only' mode

● **Crust:** Crust Colour available on Basic and Gluten Free only

- LIGHT
- MEDIUM\*
- DARK

\* Medium crust is indicated by the black dot between light and dark.

● **Start/Stop:** The start/stop light will flash during program selection. Press the start pad when programming is completed. When the start pad is pressed, the start/stop light will stop flashing and become constant. If you wish to change the program, you must stop the operation by holding down the stop pad for 1–2 seconds. The display will go blank and the start/stop light will go off. Press the select pad to reactivate the screen and then re-program accordingly. If you press this pad without selecting any programs, basic/BAKE XL size program will start.

• SD-257 display shown. This picture shows all words and symbols, but during operation only those relevant will be displayed.

# Bread-making Ingredients

## Flour

Main ingredient of bread. The protein in flour forms gluten during kneading. Gluten provides structure and texture and helps the bread to rise.

- Use strong bread flour only.
- Flour must be weighed on scales.

## Water

- Use normal tap water.
- Use tepid water if using 'RAPID', 'rye' or 'gluten free' settings in a cold room.
- Use chilled water if using 'rye', 'french' or 'brioche' settings in a hot room.
- Always measure out liquids using the measuring cup provided.

## Salt

Improves the flavour and strengthens gluten to help the bread rise.

- The bread may lose size/flavour if measuring is inaccurate.

## Dairy Products

Add flavour and nutritional value.

- If you use milk instead of water, the nutritional value of the bread will be higher, but do not use in timer setting as it may not keep fresh overnight.  
→ Reduce the amount of water proportionally to the amount of milk.

## Fat

Adds flavour and softness to the bread.

- Use butter, margarine or oil.  
2 tbsps oil are equivalent to 25 g butter.

## Sugar

(granulated sugar, brown sugar, honey, treacle etc)  
Adds softness and gives crust colour.

## Yeast

Enables the bread to rise.

- Yeast which has 'Easy Blend', 'Fast Action' or 'Easy Bake' written on the packet is recommended.
- Do not use dried yeast that requires preliminary fermentation.
- When using yeast from sachets, seal the sachet again immediately after use. To store follow manufacturers instructions but use opened individual sachets within 48 hours.



■ You can make your bread taste better by adding other ingredients:

Eggs	Improve the nutritional value and colouring of the bread. (Water amount must be reduced proportionally) Beat eggs when adding eggs.
Bran	Increases the bread's fibre content. ● Use max. 50 g (2 oz).
Wheat germ	Gives the bread a nuttier flavour. ● Use max. 50 g (2 oz).
Spices, herbs	Enhance the flavour of the bread. ● Only use a small amount (1-2 tsp).

## Main Flours Used in Bread

Strong flour is milled from hard wheat and has a high content of protein which is necessary for the development of gluten. Carbon dioxide produced during fermentation is trapped within the elastic network of gluten, thus making the dough rise.

### White flour:

Made by grinding wheat kernel, excluding bran and germ. Used in e.g. 'basic', 'french' modes.

- Always use strong flour when using the recipes in this book.
- Do NOT use plain or self-raising flour as a substitute for bread flour.

### Wholemeal flour:

Made by grinding entire wheat kernel, including bran and germ.

Makes bread rich in minerals, but lower in height and denser than bread baked with white flour because the gluten strands are cut by the edges of bran flakes and germ.

### Rye flour:

Contains some proteins, but these do not produce as much gluten as wheat flour.

Makes dense, heavy bread with a flat or slightly sunken top crust (use in rye mode).

- Do not use more than stated quantity, 100 g maximum rye out of 500 g flour in SD-256.

### Spelt flour:

In the wheat family but is a completely different species genetically. Although it contains gluten some gluten-intolerant people can digest it. Makes loaves with a flat/slightly sunken crust.

**Brown flour:** 10-15% of wheat grain removed during milling.

### Softgrain flour:

Strong white flour with wheat and rye grains added. Provides extra fibre, texture, and flavour.

- Do not use with 'Timer' option (grains can absorb water and swell up, spoiling texture of loaf).

### Granary® or Malted Grain flour:

Has crushed wheat or rye grains added together with malted whole wheat.

Makes brown bread coarser and moister with nuttier flavour.

- Do not use more than stated quantity (could damage bread pan's non-stick finish).

### Stoneground flour:

Grains are crushed between two large millstones rather than with steel rollers.

- Do not use more than stated quantity (could damage bread pan's non-stick finish, or overload motor).

### Other flour:

Products milled from other grains (i.e. corn meal, rice, millet, soy, oat, buckwheat, barley flours).

- Do not use more than stated quantity (hinders rising and texture).
- Should not be used as substitute for bread flour.
- Gluten Free - see page 22.

- Coarse ingredients such as flours with whole grains or the addition of nuts and seeds may damage the non-stick finish of the bread pan.

## If using a bread mix...

### ■ Bread mixes including yeast

- ① Place a 500 g mix in the bread pan, then add water. (Follow instructions on the packet for the quantity of water)
- ② Select the 'basic' – 'BAKE RAPID' – 'Large' size setting.
  - With some mixes, it is not clear how much yeast is included, so results may vary.

### ■ Baking brioche with brioche mix

- Select the 'brioche' or 'basic' – 'BAKE RAPID' – 'Medium' size – 'LIGHT'.

### ■ Bread mix with separate yeast sachet

- ① First place the measured yeast in the bread pan, then the bread mix, then the water.
  - Bread Bakery Capacity  
400-550 g mix (for a loaf), 250-600 g mix (for a dough)
- ② Set the machine according to the type of flour included in the mix, and start the baking.
  - White flour, brown flour → basic
  - Whole wheat, multi grain flour → whole wheat
  - rye flour → rye (SD-257 only)

# Baking Bread

Turn to P.16-21 for bread recipes



## Place the ingredients in the bread pan

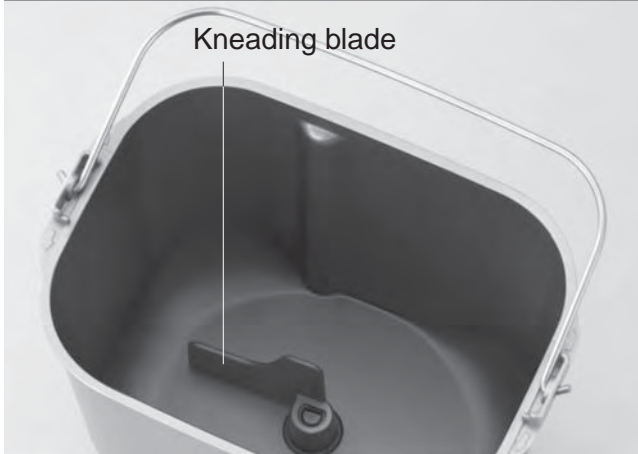

### 1 Remove the bread pan and set the kneading blade

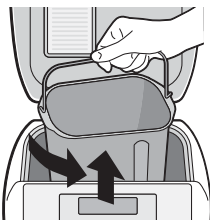

① Twist the bread pan anti-clockwise and lift up to remove

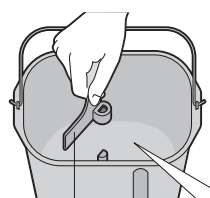

② Ensure the kneading blade is firmly on the kneader mounting shaft

Ensure that the shaft and kneading blade are clean, see page 34 for cleaning.

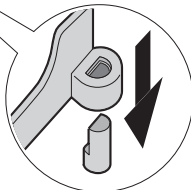

- Use the specified kneading blade when baking rye bread. (SD-257 only)
- The kneading blade is designed to fit loosely on the shaft.





■ **Baking bread with added ingredients**  
(P.11)  
(SD-257 only)

Clean and dry beforehand

### 2 Place the measured ingredients in the bread pan

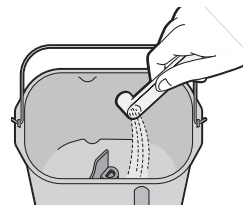

① Place the dry yeast at the bottom (so that it does not mix with the liquid until later)

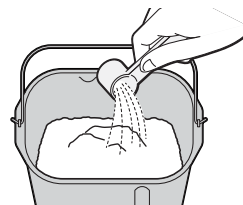

② Cover the yeast with all the dry ingredients (flour, sugar, salt, etc.)

- Flour must be weighed on scales.



③ Pour in the water and any other liquids

- Wipe the outside of the pan to remove any flour or liquid

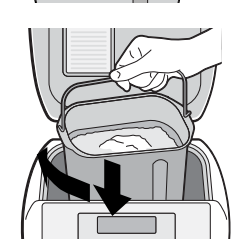

④ Put the bread pan into the breadmaker and turn slightly clockwise

⑤ Close the lid

- For optimum results, don't open the lid until bread is complete as it affects bread quality.

### 3 Plug the breadmaker into a 230-240V socket

- Make sure the start/stop light is off before selecting a program.

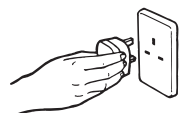



## Set the program and start

## Remove the bread

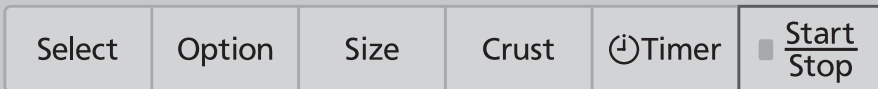

**Panasonic** SD-257

\* SD-257 display shown.

### 4 Select a bread type



### 5 Press Option pad to choose a baking option



● See page 15 for availability of size and crust.

■ To change the size → Size M L XL

■ To change the crust colour → Crust LIGHT • DARK

■ To set the timer →

e.g. It is 9:00 PM now, and you want the bread to be ready at 6.30 the next morning.

→ Set the timer to '9:30' (9 hours 30 minutes from now).

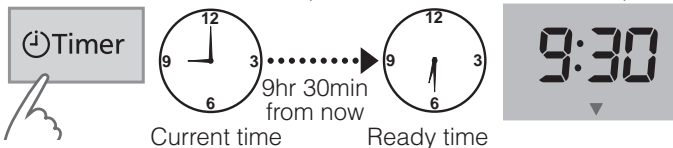

● Pressing the button once will advance the timer by 10 minutes (hold to advance more quickly)

### 6 Press Start pad to start the machine



Time until the selected program is complete

● The start/stop light will come on.

### 7 Press Stop pad and remove bread

when machine beeps 8 times



● The flashing start/stop light will go off.

### 8 Remove the bread immediately,

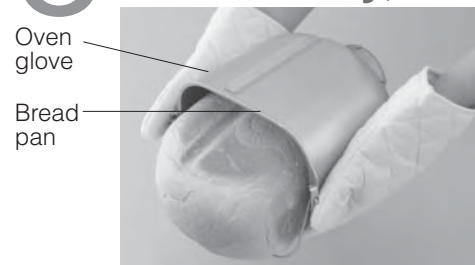

allow to cool, for example, on a wire rack

### 9 Unplug after use

- The breadmaker has a keep warm facility to reduce condensation of steam within the loaf which operates if the stop pad is not pressed on completion of the program.
- However, this will accelerate the browning of the crust, therefore, upon completion of baking, switch off the unit, remove the bread immediately from the unit to cool it.
- If you leave the bread to cool down in the bread pan, moisture will be retained within the loaf which will affect the finished quality of the loaf. Therefore, cool on a wire rack to ensure optimum quality of the loaf.

# Making Dough

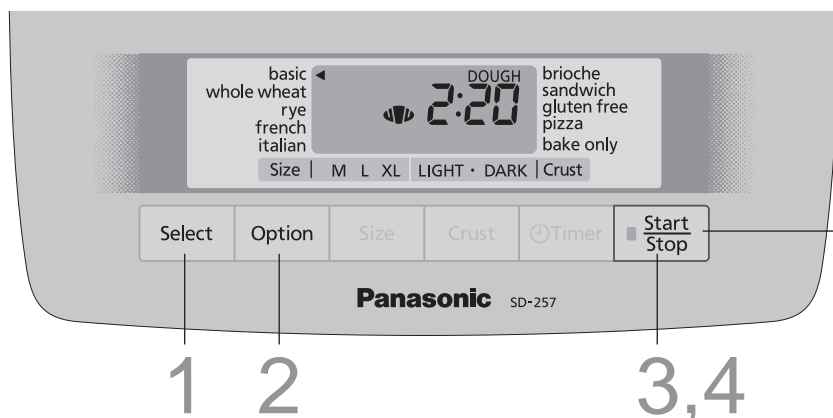

- Preparation (P.8)
- ① Put the kneading blade into the bread pan.
  - ② Place the ingredients in the bread pan in the order listed in the recipe.
  - ③ Set the bread pan into the main unit, and plug the machine into the socket. (Make sure the start/stop light is off.)

## 1 Select a dough type



- Timer is not available on Dough Options. (except pizza)
- You can select between 'basic', 'whole wheat', 'rye' (SD-257 only), 'french', and 'pizza' dough types.

## 2 Press Option pad to choose 'DOUGH'

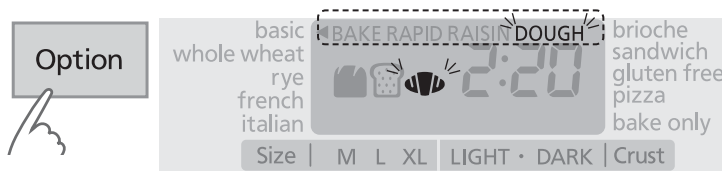

- Options available include 'DOUGH RAISIN' on 'basic' or 'whole wheat'.
- Select 'DOUGH RAISIN' if you would like to add extra ingredients to your dough by pressing the option pad. (P.11)

## 3 Press Start pad to start the machine



Time until the selected program is complete

- The start/stop light will come on.

## 4 Press Stop pad and remove dough

when machine beeps 8 times

- The flashing start/stop light will go off.

- For modes other than 'pizza', a 'resting' process will begin immediately after starting, followed by 'kneading' and 'rising'.

- Shape the finished dough and allow it to prove until doubled in size. Then bake in the oven according to recipe.

# When adding extra ingredients...

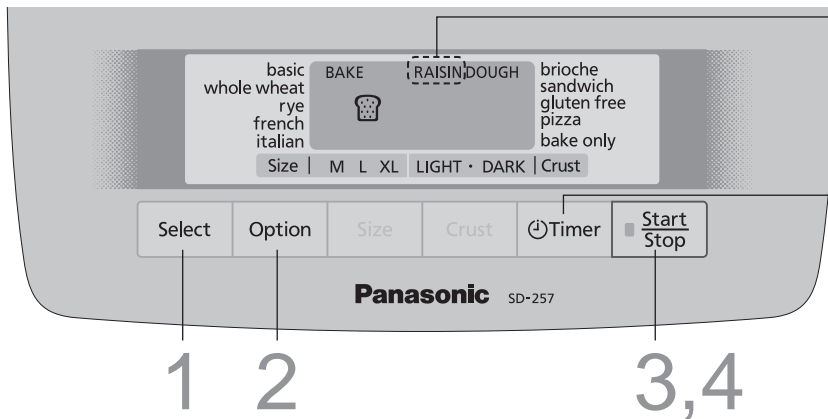

(Select when baking bread)

'BAKE RAISIN'  will be displayed

(Select when making dough)

'DOUGH RAISIN'  will be displayed

Press this pad after you've pressed start and the light is on, to see how long to wait until the selection of program is complete. (SD-256 only)

- Preparation (P.8)
- ① Put the kneading blade into the bread pan.
  - ② Place the ingredients in the bread pan in the order listed in the recipe.
  - ③ Set the bread pan into the main unit, and plug the machine into the socket. (Make sure the start/stop light is off.)

## 1 Select 'basic' or 'whole wheat'

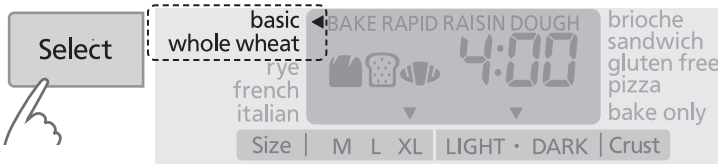

- Press once for 'basic', twice for 'whole wheat'.

## 2 Press Option pad to choose 'BAKE RAISIN' or 'DOUGH RAISIN'

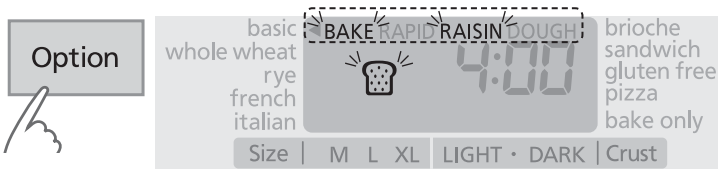

- Press twice for 'BAKE RAISIN', 4 times for 'DOUGH RAISIN'.

## 3 Press Start pad to start the machine

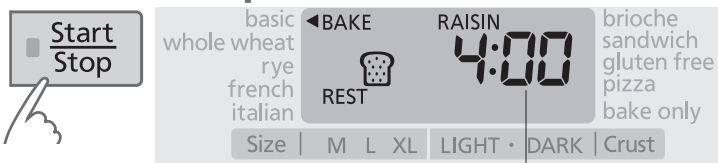

Time until the selected program is complete

(SD-256)

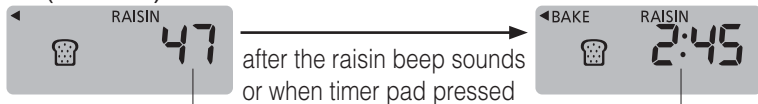

Time until additional ingredients are added

Time until the selected program is complete

- The start/stop light will come on.

## 4 Press Stop pad and remove bread or dough

when machine beeps 8 times

- The flashing start/stop light will go off.

## Adding extra ingredients

(SD-257)

- Moist Ingredients

e.g. chocolate, cheese, fresh fruits, fruits packed in alcohol.

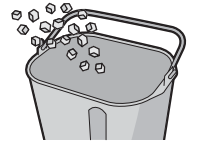

→ Moist Ingredients should be added directly into the bread pan with the other ingredients at the beginning of the cycle.

- Dry Ingredients

e.g. dried fruits, nuts

→ Dry ingredients can be added into the dispenser at the beginning of the cycle.



(SD-256)

- Moist/Dry Ingredients

→ Extra ingredients can be added directly into the bread pan when the raisin beep sounds.

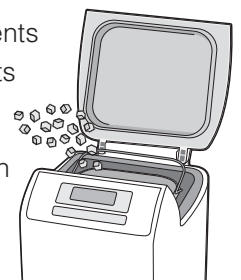

# Baking Brioche

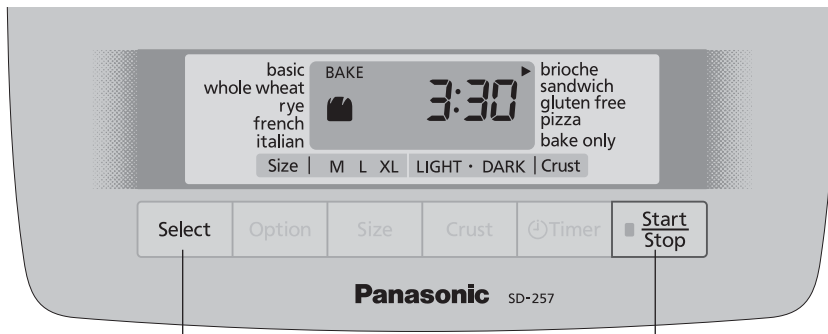

Yeast	1¼ tsp
Strong White Flour	400 g (14 oz)
Sugar	2 tbsp
Salt	1 tsp
Skimmed milk	2 tbsp
Butter (Cut into 2 cm cubes and keep in fridge)	100 g (4 oz)
Water	220 ml
Egg, medium	1 (50 g)

- Preparation (P.8)
- Put the kneading blade into the bread pan.
  - Place the ingredients in the bread pan in the order listed in the recipe.
  - Set the bread pan into the main unit, and plug the machine into the socket. (Make sure the start/stop light is off.)

## 1 Select 'brioche'

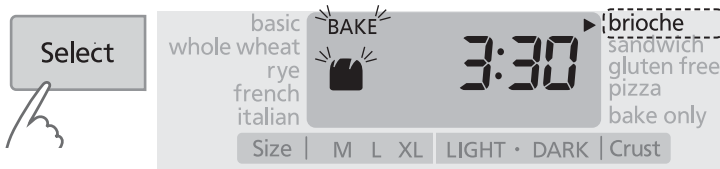

## 2 Press Start pad to start the machine



Time until the selected program is complete

- The start/stop light will come on.



## 3 Press Stop pad and remove bread

when machine beeps 8 times

- The flashing start/stop light will go off.

**[When making rich butter flavored brioche or adding extra ingredients...]**

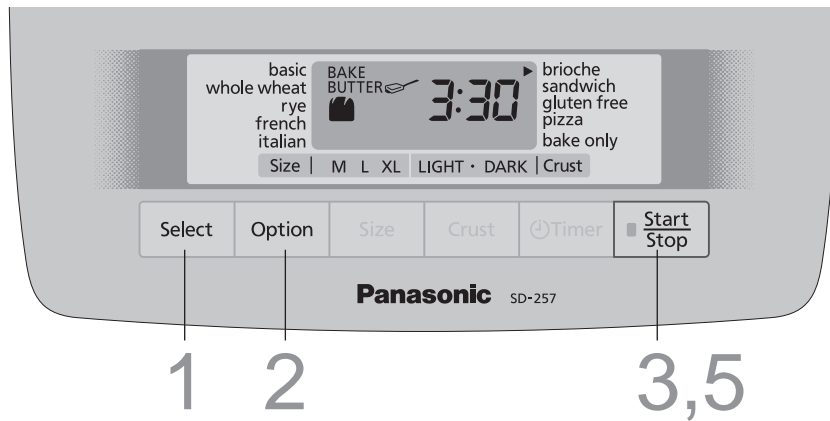

Yeast	1¼ tsp
Strong White Flour	400 g (14 oz)
Sugar	2 tbsp
Salt	1 tsp
Skimmed milk	2 tbsp
Butter (Cut into 2 cm cubes and keep in fridge)	50 g (2 oz)
Water	220 ml
Egg, medium	1 (50 g)
Butter for added later (Cut into 1–2 cm cubes and keep in fridge)	50 g (2 oz)

- Preparation (P.8)
- ① Cut the butter for adding later into 1–2 cm cubes and keep them in fridge.
  - ② Put the kneading blade into the bread pan.
  - ③ Place the ingredients in the bread pan in the order listed in the recipe.
  - ④ Set the bread pan into the main unit, and plug the machine into the socket. (Make sure the start/stop light is off.)

# 1 Select 'brioche'

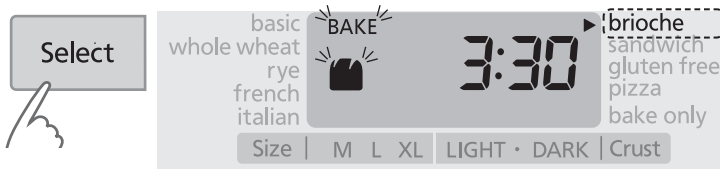

# 2 Press Option pad to choose 'BAKE' 'BUTTER'

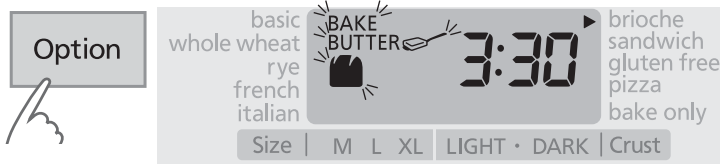

# 3 Press Start pad to start the machine

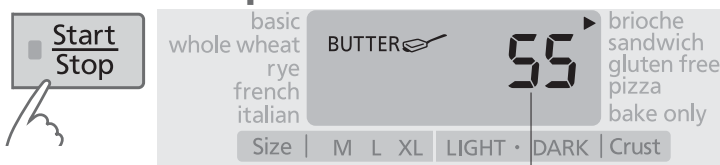

Time displayed indicating minutes until butter is added

- The start/stop light will come on.

# 4 Adding Additional Butter

Place the additional cubed butter when the beep sounds. The display will show '0' in the display for 5 min. After 5 min, kneading will continue.



Display indicates remaining time until completion of the program

# 5 Press Stop pad and remove bread when machine beeps 8 times

- The flashing start/stop light will go off.

- When adding extra ingredients such as raisins add them with the butter. (Use max. 150 g for ingredients)
- Do not add butter after display shows remaining time. (P.38)

# Baking Cakes

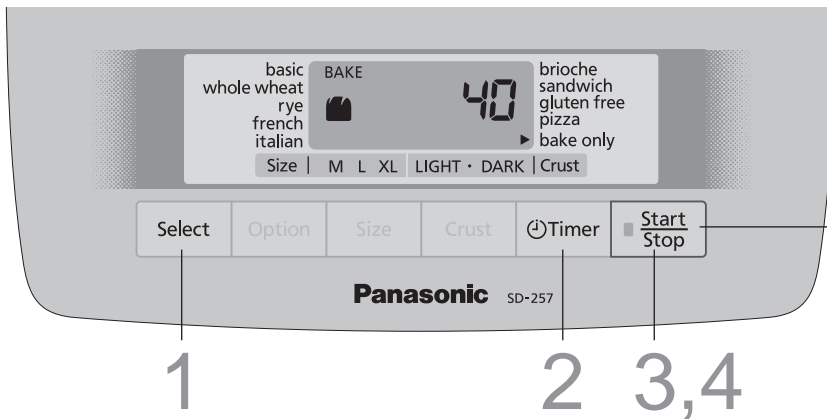

Turn to P.30-33 for cake recipes



■ To cancel/stop once started (hold for more than 1 second)

- Remove the kneading blade



- Line with parchment paper (Cake or teabread will burn if it directly touches the pan.)

- Preparation
- ① Prepare the ingredients according to the recipe.
  - ② Line the bread pan with parchment paper or loaf tin liners and pour in the mixed ingredients.
  - ③ Set the bread pan into the main unit, and plug the machine into the socket. (Make sure the start/stop light is off.)

## 1 Select 'bake only'

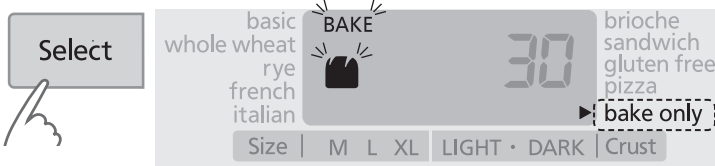

## 2 Press Timer pad to set the baking time



- You cannot use the timer function for 'bake only'. (This pad only sets the duration of the cooking time.)

## 3 Press Start pad to start the machine



Time until the selected program is complete

- The start/stop light will come on.

## 4 Press Stop pad when the machine beeps, check that baking is complete, and remove the pan

- The flashing start/stop light will go off.
- If baking is not complete → Repeat steps 1-3 (The total baking time, including any additional baking, must be within 90 minutes. The timer will start again from 1 minute when the unit is hot. Increase the time by pressing the timer pad as required.)

Take care!  
It's hot!

- To check whether baking is complete, insert a skewer into the centre of the cake or teabread – it is ready if there is no mixture stuck to the skewer when you remove it.

# List of Bread Types and Baking Options

## ■ Function Availability and Time Required

• Time required for each process will differ according to room temperature.

Bread type	Options				Processes				
	Baking option	Size	Crust	Timer	REST	KNEAD	RISE	BAKE	Total
<b>basic</b> Makes bread with strong white, brown, soft grain or spelt (SD-256) bread flour.	BAKE	●	●	●	25 min–60 min	15–30 min	1 hr 50 min–2 hr 20 min	50 min	4 hours
	BAKE RAPID	●	●	—	—	15–20 min	approx. 1 hour	35–40 min	1 hr 55 min–2 hours
	BAKE RAISIN	●	●*1	●*3	25 min–60 min	15–30 min	1 hr 50 min–2 hr 20 min	50 min	4 hours
	DOUGH	—	—	—	25 min–50 min	15–30 min	1 hr 10 min–1 hr 30 min	—	2 hr 20 min
	DOUGH RAISIN	—	—	—	25 min–50 min	15–30 min	1 hr 10 min–1 hr 30 min	—	2 hr 20 min
<b>whole wheat</b> Makes bread with strong whole wheat flour or multigrain bread flour.	BAKE	●	—	●	1 hour–1 hr 40 min	15–25 min	2 hr 10 min–2 hr 50 min	50 min	5 hours
	BAKE RAPID	●	—	—	15 min–25 min	15–25 min	1 hr 30 min–1 hr 40 min	45 min	3 hours
	BAKE RAISIN	●	—	●*3	1 hour–1 hr 40 min	15–25 min	2 hr 10 min–2 hr 50 min	50 min	5 hours
	DOUGH	—	—	—	55 min–1 hr 25 min	15–25 min	1 hr 30 min–2 hours	—	3 hr 15 min
	DOUGH RAISIN	—	—	—	55 min–1 hr 25 min	15–25 min	1 hr 30 min–2 hours	—	3 hr 15 min
<b>rye</b> (SD-257 only) Makes bread with rye flour and spelt flour.	BAKE	—	—	●	45 min–60 min	approx. 10 min	1 hr 20 min–1 hr 35 min	1 hour	3 hr 30 min
	DOUGH	—	—	—	45 min–60 min	approx. 10 min	—	—	2 hours
<b>french</b> Makes bread with strong white bread flour for a crispier crust and open texture.	BAKE	—	—	●	40 min–2 hr 5 min	10–20 min	2 hr 45 min–4 hr 10 min	55 min	6 hours
	DOUGH	—	—	—	40 min–1 hr 45 min	10–20 min	1 hr 35 min–2 hr 40 min	—	3 hr 35 min
<b>italian</b> Makes light bread for enjoying with pasta, etc.	BAKE	—	—	●	30 min–1 hour	10–15 min	2 hr 25 min–3 hours	50 min	4 hr 30 min
<b>brioche</b> Makes rich flavored bread with eggs and butter	BAKE	—	—	—	30 min	25–30 min	1 hr 30 min	50 min	3 hr 30 min
<b>sandwich</b> Makes bread with a soft crust and texture.	BAKE	—	—	●	1 hour–1 hr 40 min	15–25 min	2 hr 10 min–2 hr 50 min	50 min	5 hours
<b>gluten free</b> Makes bread using gluten-free bread mix/flour.	BAKE	—	●*2	—	—	15 min	1 hour	45 min	2 hours
<b>pizza</b> Makes pizza dough.	DOUGH	—	—	●	(KNEAD) 10–18 min	(RISE) 7–15 min	(KNEAD) approx. 10 min	(RISE) approx. 10 min	45 min
<b>bake only</b> Bakes teabreads and cakes.	BAKE	—	—	—	—	—	—	30 min–1 hr 30 min	30 min–1 hr 30 min

\*1 Only 'LIGHT' or 'MEDIUM' available. \*2 Only 'MEDIUM' or 'DARK' available. \*3 The timer can only be used on the SD-257.

• The breadmaker will operate for a short time during the rise period (to ensure optimal gluten development).

# Bread Recipes



**[basic]**

(white or brown flour)

⌚ : Timer can be used for recipes with this symbol (4-13 hours)

Turn to P.24-29 for dough recipes



## White Loaf

'Basic'-'Bake' (4hr) ⌚

	M	L	XL
Yeast	¾ tsp	1 tsp	1¼ tsp
Strong White Flour	400 g (14 oz)	475 g (1 lb 1 oz)	550 g (1 lb 4 oz)
Sugar	1 tsp	1½ tsp	2 tsp
Butter	15 g (½ oz)	25 g (1 oz)	25 g (1 oz)
Salt	1 tsp	1¼ tsp	1½ tsp
Water	280 ml	320 ml	360 ml

## Rapid White Loaf

'Basic'-'Bake Rapid' (1hr 55min-2hr) ⌚

	M	L	XL
Yeast	1 tsp	1¼ tsp	1½ tsp
Strong White Flour	400 g (14 oz)	475 g (1 lb 1 oz)	550 g (1 lb 4 oz)
Sugar	1 tsp	1½ tsp	2 tsp
Butter	15 g (½ oz)	25 g (1 oz)	25 g (1 oz)
Salt	1 tsp	1¼ tsp	1½ tsp
Water	280 ml	320 ml	360 ml

## Spicy Fruit Loaf

'Basic'-'Bake Raisin' (4hr) ⌚

	M
Yeast	1 tsp
Strong White Flour	400 g (14 oz)
Sugar	2 tsp
Butter	75 g (3 oz)
Salt	1 tsp
Cinnamon	2 tsp
Mixed Spice	1 tsp
Eggs, medium	2
Water	110 ml
Milk	110 ml
*Mixed Dried Fruit	150 g (5 oz)

## Cider Apple Bread

'Basic'-'Bake Raisin' (4hr) ⌚

	M
Yeast	1 tsp
Strong White Flour	500 g (1 lb 2 oz)
Apple, grated	1
Sugar	1 tsp
Salt	1 tsp
Ground White pepper	½ tsp
Cider	350 ml
Rosemary	1 tsp

## Apricot and Almond Loaf

'Basic'-'Bake Raisin' (4hr) (Timer can be used on SD-257)

	L
Yeast	1 tsp
Strong White Flour	400 g (14 oz)
Sugar	1½ tsp
Butter	25 g (1 oz)
Salt	1 tsp
Ground Almonds	50 g (2 oz)
Water	270 ml
*Dried Apricots, chopped	100 g (4 oz)
*Flaked Almonds	50 g (2 oz)

## Milk Loaf

'Basic'-'Bake' (4hr) ⌚

	M	L	XL
Yeast	¾ tsp	1 tsp	1¼ tsp
Strong White Flour	400 g (14 oz)	475 g (1 lb 1 oz)	550 g (1 lb 4 oz)
Sugar	1 tsp	1½ tsp	2 tsp
Butter	15 g (½ oz)	25 g (1 oz)	25 g (1 oz)
Salt	1 tsp	1¼ tsp	1½ tsp
Milk	280 ml	340 ml	380 ml

## Wheat Germ Loaf

'Basic'-'Bake' (4hr) ⌚

	L
Yeast	1¼ tsp
Strong White Flour	500 g (1 lb 2 oz)
Sugar	1½ tsp
Oil	2 tbsp
Salt	1¼ tsp
Wheat Germ	50 g (2 oz)
Water	350 ml

## Oat and Bran Loaf

'Basic'-'Bake' (4hr) ⌚

	L
Yeast	1 tsp
Strong White Flour	400 g (14 oz)
Sugar	1½ tsp
Oil	2 tbsp
Salt	1¼ tsp
Bran	50 g (2 oz)
Porridge Oats	50 g (2 oz)
Water	350 ml

## Pizza Loaf

'Basic'-'Bake Raisin'-'Medium' Crust' (4hr) (Timer can be used on SD-257)

	M
Yeast	¾ tsp
Strong White Flour	400 g (14 oz)
Sugar	1 tsp
Oil	1 tbsp
Salt	1 tsp
Oregano Dried	2 tsp
Water	260 ml
*Pepperoni, chopped	75 g (3 oz)
*Stuffed Olives, chopped	75 g (3 oz)

## 5 Seeded Bread Loaf

'Basic'-'Bake Raisin' (4hr) (Timer can be used on SD-257)

	M	L	XL
Yeast	¾ tsp	1 tsp	1¼ tsp
Strong White Flour	400 g (14 oz)	475 g (1 lb 1 oz)	550 g (1 lb 4 oz)
Sugar	1 tsp	1½ tsp	2 tsp
Butter	15 g (½ oz)	25 g (1 oz)	25 g (1 oz)
Salt	1 tsp	1¼ tsp	1½ tsp
Sesame Seeds	1 tbsp	1½ tbsp	2 tbsp
Poppy Seeds	1 tbsp	1½ tbsp	2 tbsp
Water	270 ml	320 ml	360 ml
*Linseeds	1 tbsp	1½ tbsp	2 tbsp
*Pumpkin Seeds	1 tbsp	1½ tbsp	2 tbsp
*Sunflower Seeds	1 tbsp	1½ tbsp	2 tbsp



### Brown Loaf

'Basic'-'Bake' (4hr) (⌚)

	M	L	XL
Yeast	¾ tsp	1 tsp	1¼ tsp
Strong Brown Flour	400 g (14 oz)	475 g (1 lb 1 oz)	550 g (1 lb 4 oz)
Sugar	1 tsp	1½ tsp	2 tsp
Butter	15 g (½ oz)	25 g (1 oz)	25 g (1 oz)
Salt	1 tsp	1¼ tsp	1½ tsp
Water	270 ml	320 ml	360 ml

### Rapid Brown Loaf

'Basic'-'Bake Rapid' (1hr 55min-2hr) (⌚)

	M	L	XL
Yeast	1 tsp	1¼ tsp	1½ tsp
Strong Brown Flour	400 g (14 oz)	475 g (1 lb 1 oz)	550 g (1 lb 4 oz)
Sugar	1 tsp	1½ tsp	2 tsp
Butter	15 g (½ oz)	25 g (1 oz)	25 g (1 oz)
Salt	1 tsp	1¼ tsp	1½ tsp
Water	280 ml	320 ml	360 ml

### Malted Fruit Loaf

'Basic'-'Bake Raisin' (4hr) (Timer can be used on SD-257)

	L
Yeast	1 tsp
Strong White Flour	500 g (1 lb 2 oz)
Sugar	1½ tsp
Salt	1¼ tsp
Malt Extract	3 tbsp
Water	320 ml
*Sultanas	150 g

### Curry and Mango Loaf

'Basic'-'Bake' (4hr) (⌚)

	M
Yeast	¾ tsp
Strong Brown Flour	400 g (14 oz)
Sugar	1 tsp
Butter	15 g (½ oz)
Salt	1 tsp
Curry Paste	3 tsp
Mango Chutney	2 tbsp
Water	270 ml

### Cheese and Bacon Loaf

'Basic'-'Bake Raisin' (4hr) (Timer can be used on SD-257)

	M	L	XL
Yeast	¾ tsp	1 tsp	1¼ tsp
Strong White Flour	400 g (14 oz)	475 g (1 lb 1 oz)	550 g (1 lb 4 oz)
Sugar	1 tsp	1½ tsp	2 tsp
Salt	1 tsp	1¼ tsp	1½ tsp
Cheddar Cheese, grated	50 g (2 oz)	75 g (3 oz)	100 g (4 oz)
Water	270 ml	320 ml	360 ml
*Cooked Bacon, chopped	50 g (2 oz)	75 g (3 oz)	100 g (4 oz)

### Fresh Yeast White Loaf

'Basic'-'Bake' (4hr) (⌚)

	L
Fresh Yeast	8 g (½ oz)
Strong White Flour	500 g (1 lb 2 oz)
Sugar	1½ tsp
Oil	2 tbsp
Salt	1¼ tsp
Water	330 ml

## [whole wheat]

(wholemeal flour)

(⌚) : Timer can be used for recipes with this symbol (5-13 hours)

### Wholemeal Loaf 100%

'Whole Wheat'-'Bake' (5hr) (⌚)

	M	L	XL
Yeast	¾ tsp	1 tsp	1¼ tsp
Strong Wholemeal Flour	400 g (14 oz)	475 g (1 lb 1 oz)	550 g (1 lb 4 oz)
Sugar	1 tsp	1½ tsp	2 tsp
Butter	15 g (½ oz)	25 g (1 oz)	25 g (1 oz)
Salt	1 tsp	1¼ tsp	1½ tsp
Water	290 ml	350 ml	390 ml

### Wholemeal Loaf 70%

'Whole Wheat'-'Bake' (5hr) (⌚)

	M	L	XL
Yeast	¾ tsp	1 tsp	1¼ tsp
Strong Wholemeal Flour	300 g (11 oz)	350 g (12 oz)	400 g (14 oz)
Strong White Flour	100 g (4 oz)	125 g (4½ oz)	150 g (5 oz)
Sugar	1 tsp	1½ tsp	2 tsp
Butter	15 g (½ oz)	25 g (1 oz)	25 g (1 oz)
Salt	1 tsp	1¼ tsp	1½ tsp
Water	290 ml	350 ml	390 ml

### Wholemeal Loaf 50%

'Whole Wheat'-'Bake' (5hr) (⌚)

	M	L	XL
Yeast	¾ tsp	1 tsp	1¼ tsp
Strong Wholemeal Flour	200 g (7 oz)	250 g (9 oz)	275 g (10 oz)
Strong White Flour	200 g (7 oz)	225 g (8 oz)	275 g (10 oz)
Sugar	1 tsp	1½ tsp	2 tsp
Butter	15 g (½ oz)	25 g (1 oz)	25 g (1 oz)
Salt	1 tsp	1¼ tsp	1½ tsp
Water	290 ml	350 ml	390 ml

### Rapid Wholemeal Loaf 100%

'Whole Wheat'-'Bake Rapid' (3hr) (⌚)

	M	L	XL
Yeast	1¼ tsp	1½ tsp	1¾ tsp
Strong Wholemeal Flour	400 g (14 oz)	475 g (1 lb 1 oz)	550 g (1 lb 4 oz)
Sugar	1 tsp	1½ tsp	2 tsp
Butter	15 g (½ oz)	25 g (1 oz)	25 g (1 oz)
Salt	1 tsp	1¼ tsp	1½ tsp
Water	280 ml	340 ml	380 ml

• For addition of ingredients with\*, follow programming instructions on P.11.

# Bread Recipes

## [whole wheat]

(wholemeal flour)

 : Timer can be used for recipes with this symbol (5-13 hours)

### Rapid Wholemeal Loaf 70%

'Whole Wheat'-'Bake Rapid' (3hr) 

	M	L	XL
Yeast	1 tsp	1¼ tsp	1½ tsp
Strong Wholemeal Flour	300 g (11 oz)	350 g (12 oz)	400 g (14 oz)
Strong White Flour	100 g (4 oz)	125 g (4½ oz)	150 g (5 oz)
Sugar	1 tsp	1½ tsp	2 tsp
Butter	15 g (½ oz)	25 g (1 oz)	25 g (1 oz)
Salt	1 tsp	1¼ tsp	1½ tsp
Water	280 ml	340 ml	380 ml

### Rapid Wholemeal Loaf 50%

'Whole Wheat'-'Bake Rapid' (3hr) 

	M	L	XL
Yeast	1 tsp	1¼ tsp	1½ tsp
Strong Wholemeal Flour	200 g (7 oz)	250 g (9 oz)	275 g (10 oz)
Strong White Flour	200 g (7 oz)	225 g (8 oz)	275 g (10 oz)
Sugar	1 tsp	1½ tsp	2 tsp
Butter	15 g (½ oz)	25 g (1 oz)	25 g (1 oz)
Salt	1 tsp	1¼ tsp	1½ tsp
Water	280 ml	340 ml	380 ml

### Olive Loaf

'Whole Wheat'-'Bake Raisin' (5hr) (Timer can be used on SD-257)

	M
Yeast	¾ tsp
Strong Wholemeal Flour	200 g (7 oz)
Strong White Flour	200 g (7 oz)
Sugar	1 tsp
Oil	3 tbsp
Salt	1 tsp
Oregano, dried	1 tbsp
Water	270 ml
*Whole Black Olives, pitted	75 g (3 oz)

### Fresh Yeast Wholemeal Loaf 100%

'Whole Wheat'-'Bake' (5hr) 

	L
Fresh Yeast	8 g (½ oz)
Strong Wholemeal Flour	500 g (1 lb 2 oz)
Sugar	1½ tsp
Oil	2 tbsp
Salt	1¼ tsp
Water	350 ml

### Honey and Sunflower Loaf

'Whole Wheat'-'Bake Raisin' (5hr) (Timer can be used on SD-257)

	L
Yeast	1 tsp
Strong Wholemeal Flour	250 g (9 oz)
Strong White Flour	225 g (8 oz)
Honey	2 tbsp
Butter	25 g (1 oz)
Salt	1¼ tsp
Water	320 ml
*Sunflower Seeds	4 tbsp

### Pesto and Pine Nut Loaf

'Whole Wheat'-'Bake Raisin' (5hr) (Timer can be used on SD-257)

	M	L	XL
Yeast	¾ tsp	1 tsp	1¼ tsp
Strong Wholemeal Flour	200 g (7 oz)	250 g (9 oz)	300 g (11 oz)
Strong White Flour	200 g (7 oz)	225 g (8 oz)	250 g (9 oz)
Sugar	1 tsp	1½ tsp	2 tsp
Salt	1 tsp	1¼ tsp	1½ tsp
Pesto	2 tbsp	3 tbsp	4 tbsp
Water	280 ml	340 ml	380 ml
*Pine Nuts	75 g (3 oz)	100 g (4 oz)	125 g (5 oz)

### Maple and Pecan Nut Loaf

'Whole Wheat'-'Bake Raisin' (5hr) (Timer can be used on SD-257)

	L
Yeast	¾ tsp
Strong Wholemeal Flour	200 g (7 oz)
Strong White Flour	200 g (7 oz)
Butter	15 g (½ oz)
Salt	1 tsp
Maple Syrup	3 tbsp
Water	280 ml
*Pecan Nuts, chopped	75 g (3 oz)

### Spicy Fruit Loaf

'Whole Wheat'-'Bake Raisin' (5hr) 

	M
Yeast	1 tsp
Strong Wholemeal Flour	400 g (14 oz)
Sugar	2 tsp
Butter	75 g (3 oz)
Salt	1 tsp
Cinnamon	2 tsp
Mixed Spice	1 tsp
Eggs, medium	2
Water	120 ml
Milk	120 ml
*Mixed Dried Fruit	150 g (5 oz)

### Seeded Wholemeal Loaf

'Whole Wheat'-'Bake Raisin' (5hr) (Timer can be used on SD-257)

	M	L	XL
Yeast	¾ tsp	1 tsp	1¼ tsp
Strong Wholemeal Flour	400 g (14 oz)	475 g (1 lb 1 oz)	550 g (1 lb 4 oz)
Sugar	1 tsp	1½ tsp	2 tsp
Butter	15 g (½ oz)	25 g (1 oz)	25 g (1 oz)
Salt	1 tsp	1¼ tsp	1½ tsp
Sesame Seeds	1 tbsp	1½ tbsp	2 tbsp
Poppy Seeds	1 tbsp	1½ tbsp	2 tbsp
Water	280 ml	340 ml	360 ml
*Linseeds	1 tbsp	1½ tbsp	2 tbsp
*Pumpkin Seeds	1 tbsp	1½ tbsp	2 tbsp
*Sunflower Seeds	1 tbsp	1½ tbsp	2 tbsp

• For addition of ingredients with\*, follow programming instructions on P.11.

### Onion Loaf

'Whole Wheat'-'Bake' (5hr) ⌚

	M
Yeast	¾ tsp
Strong Wholemeal Flour	300 g (11 oz)
Strong White Flour	100 g (4 oz)
Sugar	1 tsp
Oil	1 tbsp
Salt	1 tsp
Onion, chopped and softened with 1 tsp oil	50 g (2 oz)
Garlic Puree	1 tsp
Creamed Horseradish	2 tsp
Water	270 ml

### Granary® Loaf

'Whole Wheat'-'Bake' (5hr) ⌚

	M	L	XL
Yeast	¾ tsp	1 tsp	1¼ tsp
Strong Granary® Flour	400 g (14 oz)	475 g (1 lb 1 oz)	550 g (1 lb 4 oz)
Sugar	1 tsp	1½ tsp	2 tsp
Butter	15 g (½ oz)	25 g (1 oz)	25 g (1 oz)
Salt	1 tsp	1¼ tsp	1½ tsp
Water	280 ml	320 ml	360 ml

### Malted Brown Loaf

'Whole Wheat'-'Bake' (5hr) ⌚

	M	L	XL
Yeast	¾ tsp	1 tsp	1¼ tsp
Strong Granary® Flour	250 g (9 oz)	300 g (11 oz)	350 g (12 oz)
Strong White Flour	150 g (5 oz)	200 g (7 oz)	250 g (9 oz)
Sugar	1 tsp	1½ tsp	2 tsp
Butter	15 g (½ oz)	25 g (1 oz)	25 g (1 oz)
Salt	1 tsp	1¼ tsp	1½ tsp
Water	270 ml	320 ml	360 ml

### Seeded Soya Loaf

'Whole Wheat'-'Bake' (5hr) ⌚

	M
Yeast	1 tsp
Strong White Flour	300 g (11 oz)
Soya Flour	100 g (4 oz)
Sugar	2 tsp
Butter	25 g (1 oz)
Salt	1 tsp
Poppy Seeds	3 tbsp
Sesame Seeds	2 tbsp
Water	280 ml
Soya Milk	120 ml
*Linseeds	50 g (2 oz)
*Sunflower Seeds	1 tbsp
*Pumpkin Seeds	1 tbsp

- This loaf is made with strong white flour but benefits from the 5 hour cycle.

### [rye] (SD-257 only) (rye flour and spelt flour)

- Remember to use the rye kneading blade for all these recipes.
- As a result of the consistency some flour may remain on the sides of the loaf, but this is normal.
- Due to their consistency, the kneading blade will often become embedded in Rye Bread loaves. Wait for the loaf to cool (to avoid burning your hands), before removing the blade by pressing on the base of the loaf and manipulating it out gently to avoid damaging the loaf.

⌚ : Timer can be used for recipes with this symbol (3hr 30min-13 hours)

### Rye 100%

'Rye'-'Bake' (3hr 30min) ⌚

Yeast	2½ tsp
Rye Flour	500 g (1 lb 2 oz)
Sugar	2 tsp
Oil	2 tbsp
Salt	2 tsp
Water	440 ml

### Rye and White

'Rye'-'Bake' (3hr 30min) ⌚

Yeast	2 tsp
Rye Flour	250 g (9 oz)
Strong White Flour	250 g (9 oz)
Sugar	2 tsp
Oil	2 tbsp
Salt	2 tsp
Water	360 ml

### Rye and Wholemeal

'Rye'-'Bake' (3hr 30min) ⌚

Yeast	2 tsp
Rye Flour	250 g (9 oz)
Strong Wholemeal Flour	250 g (9 oz)
Sugar	2 tsp
Oil	2 tbsp
Salt	2 tsp
Water	380 ml

### Rye and Stout

'Rye'-'Bake' (3hr 30min) ⌚

Yeast	2½ tsp
Rye Flour	500 g (1 lb 2 oz)
Sugar	2 tsp
Oil	2 tbsp
Salt	2 tsp
Water	220 ml
Guinness®/Stout	220 ml

- For addition of ingredients with\*, follow programming instructions on P.11.

# Bread Recipes

## [rye] (SD-257 only) (rye flour and spelt flour)

- Remember to use the kneading blade (rye bread) for all these recipes.
- The Raisin nut dispenser does not operate on the Rye program.
- Put any additional ingredients directly into the bread pan at the start.
- As a result of the consistency some flour may remain on the sides of the loaf, but this is normal.
- Due to their consistency, the kneading blade will often become embedded in Rye Bread loaves. Wait for the loaf to cool (to avoid burning your hands), before removing the blade by pressing on the base of the loaf and manipulating it out gently to avoid damaging the loaf.

⌚ : Timer can be used for recipes with this symbol (3hr 30min-13 hours)

## [french] (white flour/wholemeal flour)

Make bread with a crispy crust and texture.

⌚ : Timer can be used for recipes with this symbol (6-13 hours)

### Seeded Rye

'Rye'-'Bake' (3hr 30min) ⌚

Yeast	2½ tsp
Rye Flour	500 g (1 lb 2 oz)
Sugar	2 tsp
Oil	2 tbsp
Salt	2 tsp
Poppy Seeds	2 tbsp
Linseeds	3 tbsp
Sunflower Seeds	3 tbsp
Water	430 ml

### Rye and Spelt

'Rye'-'Bake' (3hr 30min) ⌚

Yeast	2 tsp
Rye Flour	250 g (9 oz)
Spelt Flour	250 g (9 oz)
Honey	2 tsp
Oil	2 tbsp
Salt	2 tsp
Water	360 ml

- This loaf has a flat or slightly sunken top.

### Spelt

'Rye'-'Bake' (3hr 30min) ⌚ or 'Bake Rapid' (1hr 55min) ⌚

Yeast	1½ tsp
Spelt Flour	400 g (14 oz)
Honey	1 tsp
Oil	2 tbsp
Salt	1 tsp
Water	300 ml

- This loaf has a flat or slightly sunken top.

### Fruity Spelt

'Rye'-'Bake' (3hr 30min) ⌚ or 'Bake Rapid' (1hr 55min) ⌚

Yeast	1½ tsp
Spelt Flour	500 g (1lb 2 oz)
Honey	1 tsp
Oil	2 tbsp
Salt	1 tsp
Mixed Dried Fruit	150 g (5 oz)
Mixed Spice	3 tsp
Water	360 ml

- This loaf has a flat or slightly sunken top.

### French

'French'-'Bake' (6hr) ⌚

Yeast	1 tsp
Strong White Flour	400 g (14 oz)
Butter	15 g (½ oz)
Salt	1 tsp
Water	300 ml

### Seeded Spelt

'Rye'-'Bake' (3hr 30min) ⌚ or 'Bake Rapid' (1hr 55min) ⌚

Yeast	1½ tsp
Spelt Flour	400 g (14 oz)
Honey	1 tsp
Oil	2 tbsp
Salt	1 tsp
Linseeds	3 tbsp
Poppy Seeds	2 tbsp
Sesame Seeds	2 tbsp
Water	300 ml

- This loaf has a flat or slightly sunken top.

### Lemon and Poppy Seed Spelt

'Rye'-'Bake' (3hr 30min) or 'Bake Rapid' (1hr 55min) ⌚

Yeast	1½ tsp
Spelt Flour	400 g (14 oz)
Milk Powder	2 tbsp
Honey	1 tsp
Oil	2 tbsp
Salt	1 tsp
Poppy Seeds	3 tbsp
Grated Zest from Lemon	1
Lemon Juice	30 ml
Water	280 ml

- The lemon and poppy seed loaf will have a closer texture than the standard spelt loaf.

### Rustic French

'French'-'Bake' (6hr) ⌚

Yeast	1 tsp
Strong White Flour	275 g (10 oz)
Strong Wholemeal Flour	75 g (3 oz)
Rye Flour	50 g (2 oz)
Butter	15 g (½ oz)
Salt	1 tsp
Water	310 ml

## [italian]

(white flour)

Make light bread for enjoying with pasta, etc.

- The Raisin nut dispenser does not operate on the Italian program.
- Put any additional ingredients directly into the bread pan at the start.
- Passata is a thick tomato sauce that is usually near the pasta sauces in supermarkets.

 : Timer can be used for recipes with this symbol (4hr 30min-13 hours)

### Easy Ciabatta

'Italian'-'Bake' (4hr 30min) 

Yeast	1 tsp
Strong White Flour	500 g (1 lb 2 oz)
Sugar	1 tsp
Olive Oil	3 tbsp
Salt	1 tsp
Water	310 ml

### Green Pesto, Onion and Garlic

'Italian'-'Bake' (4hr 30min) 

Yeast	¾ tsp
Strong White Flour	350 g (12 oz)
Polenta	50 g (2 oz)
Sugar	1 tsp
Salt	½ tsp
Green Pesto	2 tbsp
Onion, chopped and softened with 1 tsp oil	75 g (3 oz)
Garlic clove, finely chopped	2
Water	250 ml

### Sundried Tomato and Parmesan

'Italian'-'Bake' (4hr 30min) 

Yeast	¾ tsp
Strong White Flour	400 g (14 oz)
Sugar	1 tsp
Salt	½ tsp
Parmesan Cheese, grated	50 g (2 oz)
Sundried Tomatoes in Oil, chopped	75 g (3 oz)
Water	270 ml

### Mushroom and Pancetta

'Italian'-'Bake' (4hr 30min) 

Yeast	¾ tsp
Strong White Flour	400 g (14 oz)
Sugar	1 tsp
Butter	15 g (½ oz)
Salt	½ tsp
Cep Mushrooms, soaked	25 g (1 oz)
Pancetta, cooked and chopped	25 g (1 oz)
Water	280 ml

### Oregano and Olive

'Italian'-'Bake' (4hr 30min) 

Yeast	¾ tsp
Strong White Flour	400 g (14 oz)
Sugar	1 tsp
Olive Oil	2 tbsp
Salt	½ tsp
Oregano	1 tsp
Black Olives, chopped	50 g (2 oz)
Water	280 ml

### Three Cheeses

'Italian'-'Bake' (4hr 30min) 

Yeast	¾ tsp
Strong White Flour	400 g (14 oz)
Sugar	1 tsp
Salt	½ tsp
Dolcelatte	50 g (2 oz)
Parmesan Cheese,grated	25 g (1 oz)
Mozzarella	50 g (2 oz)
Water	240 ml

### Tomato Focaccia

'Italian'-'Bake' (4hr 30min) 

Yeast	¾ tsp
Strong White Flour	400 g (14 oz)
Sugar	1 tsp
Olive Oil	1 tbsp
Salt	1 tsp
Passata	150 ml
Water	120 ml
Green Pitted Olives	50 g (2 oz)
Sundried Tomatoes, chopped	50 g (2 oz)

## [brioche]

### Brioche Bake loaf

'Brioche'-'Bake' (3hr 30min) 

Yeast	1¼ tsp
Strong White Flour	400 g (14 oz)
Sugar	2 tbsp
Salt	1 tsp
Skimmed milk	2 tbsp
Butter (Cut into 2 cm cubes and keep in fridge)	100 g (4 oz)
Water	220 ml
Egg, medium	1 (50 g)

### Brioche Bake Butter loaf

'Brioche'-'Bake Butter' (3hr 30min) 

Yeast	1¼ tsp
Strong White Flour	400 g (14 oz)
Sugar	2 tbsp
Salt	1 tsp
Skimmed milk	2 tbsp
Butter (Cut into 2 cm cubes and keep in fridge)	50 g (2 oz)
Water	220 ml
Egg, medium	1 (50 g)
Butter for added later (Cut into 1-2 cm cubes and keep in fridge)	50 g (2 oz)

## [sandwich]

Make bread with a soft crust and texture.

 : Timer can be used for recipes with this symbol (5-13 hours)

### White Sandwich

'Sandwich'-'Bake' (5hr) 

Yeast	½ tsp
Strong White Flour	400 g (14 oz)
Sugar	1 tsp
Butter	15 g (½ oz)
Salt	1 tsp
Water	290 ml

### Brown Sandwich

'Sandwich'-'Bake' (5hr) 

Yeast	½ tsp
Strong Brown Flour	400 g (14 oz)
Sugar	1 tsp
Butter	15 g (½ oz)
Salt	1 tsp
Water	290 ml

### Wholemeal Sandwich

'Sandwich'-'Bake' (5hr) 

Yeast	½ tsp
Strong Wholemeal Flour	400 g (14 oz)
Sugar	1 tsp
Butter	15 g (½ oz)
Salt	1 tsp
Water	310 ml

### Granary® Sandwich

'Sandwich'-'Bake' (5hr) 

Yeast	½ tsp
Strong Granary® Flour	400 g (14 oz)
Sugar	1 tsp
Butter	15 g (½ oz)
Salt	1 tsp
Water	280 ml

# Gluten Free Recipes

## [basic]

### [gluten free]

(gluten free bread mix / wheat free bread mix)

⌘ : Timer cannot be used

- The Raisin Nut Dispenser does not operate on the Gluten Free program.
- Put any additional ingredients directly into the bread pan at the start.
- You can bake gluten free cakes following our recipes on pages 30-33 by substituting gluten free plain flour for standard plain flour. If self-raising flour is required also add 1 tsp of gluten free baking powder.
- You can purchase gluten free bread mix at:
  - Pharmacies
  - Health food shops
  - Major supermarkets

#### Note

- Making gluten free bread is very different from the normal way of producing bread in the breadmaker. Please read through the guidelines on the right.
- Please consult flour manufacturers for detailed information.
- As a result of consistency some flour may remain on the sides of the loaf, but this is normal.

## Before making gluten free bread

### ■ Consult your doctor and follow the guidelines below!

If you make gluten free bread as part of dietary therapy, it is important that you avoid cross-contamination with flour that does contain gluten.

Please take particular care when washing the bread pan and the kneading blade, etc.

→ You can order extra bread pans and kneading blades at the following:

- Customer Care Centre: 0844 8443868
- Direct Online:  
<http://www.panasonic.co.uk>

### ■ It is made differently to other types of bread!

#### The order of putting in ingredients is different

Please put in the ingredients in the following order so that the gluten free bread mix is well mixed. (The wrong order may result in poor rising)

→ Water, salt, fat → gluten free bread mix → dry yeast

#### The outcome differs depending on the type of flour

The recipes above have been developed with particular types of bread mix, and so the final outcome may differ depending on the actual bread mix used. (There may be greater variation with wheat free bread mixes.)

#### If kneading blade becomes embedded in bread

Due to their consistency, the kneading blade will often become embedded in Gluten and Wheat Free Bread loaves. Wait for the loaf to cool (to avoid burning your hands), before removing the blade by pressing on the base of the loaf and manipulating it out gently to avoid damaging the loaf.

#### Consume within two days

Store your finished bread in a cool, dry place, and consume within two days. If you cannot finish it all in time, cut it into slices, place in a freezer bag and into the freezer.

### ■ Flavoured Gluten Free Loaves

Use one quantity of chosen mix and add the following ingredients to your Bread pan to produce the loaf of your choice.

- Select Medium crust unless otherwise stated.

#### Spicy Fruit Loaf

- 100 g (4 oz) mixed fruit
- 2 tsp cinnamon

#### Date & Raisin Loaf

- juice of 2 oranges (made up to the quantity of water required), placed in the pan before gluten free mix
- 2 tsp mixed spice
- 150 g (5 oz) chopped dates
- 100 g (4 oz) raisins
- rind of 2 oranges

#### Maple & Pecan Loaf

- 2 tbsp Maple syrup
- 50 g (2 oz) Pecans

#### Five Seeds Loaf (Dark Crust)

- 1 tbsp linseeds
- 2 tbsp sesame seeds
- 1 tbsp pumpkin seeds
- 1 tbsp poppy seeds
- 1 tbsp sunflower seeds

#### Sundried Tomato & Parmesan Loaf (Dark Crust)

- 50 g (2 oz) parmesan cheese grated
- 50 g (2 oz) sundried tomatoes in oil, drained and chopped

## Gluten Free Bread

### Glutafin Gluten Free Bread Mix

'Gluten Free'-'Bake'-'Dark' Crust (2hr) 

Cold Tap Water	400 ml
Oil	2 tsp
Bread Mix	500 g (1 lb 2 oz)
Yeast	2 tsp

### Glutafin Gluten Free Fibre Bread Mix

'Gluten Free'-'Bake'-'Dark' Crust (2hr) 

Hot Water from the Kettle	200 ml
Cold Tap Water	200 ml
Oil	1½ tbsp
Bread Mix	500 g (1 lb 2 oz)
Yeast	2 tsp

### Juvela Bread Mixes

'Gluten Free'-'Bake'-'Dark' Crust (2hr) 

	Gluten Free Mix	Fibre Mix
Water	400 ml	430 ml
Salt	½ tsp	½ tsp
Oil	1 tbsp	1 tbsp
Bread Mix	500 g (1 lb 2 oz)	500 g (1 lb 2 oz)
Yeast	1 tsp	1 tsp

## Gluten and Wheat Free

Wheat Free bread is quite different from gluten free bread as it does not contain gluten or wheat starch. Some wheat free mixes are better suited to longer cycles. Please check all ingredients listing for computability with your diet. Barley contains gluten.

### Glutafin Gluten Free/Wheat Free

'Basic'-'Bake'-'Large' Size-'Dark' Crust (4hr) 

	Bread Mix	Fibre Bread Mix
Cold Tap Water	450 ml	480 ml
Oil	1 tbsp	1 tbsp
Bread Mix	500 g (1 lb 2 oz)	500 g (1 lb 2 oz)
Yeast	1½ tsp	1 tsp

### Gluten and Wheat Free Bread

'Basic'-'Bake'-'Medium' Crust (4hr) 

Warm Water + 1 Egg + 1 Egg White made up to	430 ml
Melted Butter	60 ml
Cider Vinegar	1 tsp
Brown Rice Flour	300 g (11 oz)
Potato Starch	100 g (4 oz)
Skimmed Milk Powder	50 g (2 oz)
Xanthum Gum	1 tbsp
Sugar	1 tbsp
Salt	1 tsp
Yeast	1 tsp

- The milk powder may be omitted.

### Doves Farm Gluten Free

'Gluten Free'-'Bake'-'Dark' Crust (2hr) 

	Brown Bread Flour	White Bread Flour
Water	330 ml	310 ml
Cider Vinegar	1 tsp	1 tsp
Vegetable Oil	4 tbsp	4 tbsp
Egg, medium	1	1
Medium Sized Egg, white	1	1
Flour	450 g (1 lb)	450 g (1 lb)
Sugar	1 tbsp	1 tbsp
Salt	1 tsp	1 tsp
Yeast	1½ tsp	1½ tsp

### Juvela Bread Mixes

'Gluten Free'-'Bake'-'Dark' Crust (2hr) 

	Harvest Mix Wheat Free
Water	420 ml
Salt	½ tsp
Oil	1 tbsp
Bread Mix	500 g (1 lb 2 oz)
Yeast	1 tsp

### Sainsbury's Free from Gluten and Wheat Free Bread Mix with Added Fibre

'Gluten Free'-'Bake'-'Dark' Crust (2hr) 

Water	440 ml
Vegetable Oil	2 tbsp
Mix	500 g (1 lb 2 oz)
Yeast	1 tsp

# Dough Recipes



**[basic]**  
**[whole wheat]**  
**[rye] [french] [pizza]**

The Dough setting mixes and gives the dough its first rising before you shape and bake it in your conventional oven.

: Timer cannot be used (except pizza)

Prepare your ingredients according to the recipe and select the correct mode. When your dough is ready, shape it, allow it to rise, and then bake it yourself.

- The maximum load of the Bread Maker is 600 g (1 lb 5 oz).  
Dough recipes using 300 g (11 oz) of flour may be doubled.
- When the DOUGH program has completed its operation, you may find that the prepared dough is easier to shape if it is tipped onto a lightly floured board before handling.

## Example – making plain bread rolls

### ① Shaping

Dough can be shaped into round rolls, plaits, knots, French sticks, large or small cobs or put in a traditional loaf tin.

#### ● Rolls

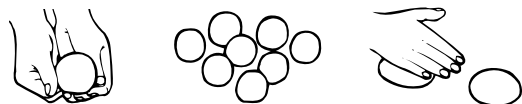

#### ● Knot



#### ● Hedgehogs

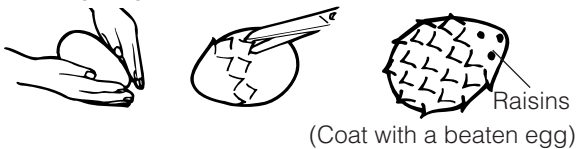

### ② Proving

Most recipes require the dough to be left to prove i.e. to be left to rise after shaping, before the final baking. Generally the dough should be left to prove in a warm place (at approximately 40°C/90°F) until the dough has doubled in size.

- Approximate proving time-Rolls 25 mins, Whole breads e.g. Panettone etc 50 mins
- To prevent a hard dry skin forming, cover the dough with a large polythene bag or cover with lightly oiled cling film.

### ③ Glazing/Baking

Brush with milk, salted water, beaten egg or oil. Sprinkle with poppy seeds, sesame seeds. Bake following recipe guidelines.

## Rolls

- Select one of the following recipes and follow the method below.

### 1 Shape dough.



### 2 Place onto a greased baking tray and allow to prove until doubled in size.



### 3 Brush with beaten egg.

### 4 Bake in a preheated oven at 220°C/425°F/Gas Mark 7 for 10-15 mins or until golden brown.

## White Dough

'Basic'-'Dough' (2hr 20min)

Yeast	1¼ tsp
Strong White Flour	550 g (1 lb 4 oz)
Sugar	2 tsp
Oil	2 tbsp
Salt	1½ tsp
Water	320 ml

## Brown Dough

'Basic'-'Dough' (2hr 20min)

Yeast	1¼ tsp
Strong Brown Flour	550 g (1 lb 4 oz)
Sugar	2 tsp
Oil	2 tbsp
Salt	1½ tsp
Water	320 ml

## Wholemeal Dough 100%

'Whole Wheat'-'Dough' (3hr 15min)

Yeast	1¼ tsp
Strong Wholemeal Flour	550 g (1 lb 4 oz)
Sugar	2 tsp
Oil	2 tbsp
Salt	1½ tsp
Water	340 ml

## Wholemeal Dough 70%

'Whole Wheat'-'Dough' (3hr 15min)

Yeast	1¼ tsp
Strong Wholemeal Flour	400 g (14 oz)
Strong White Flour	150 g (5 oz)
Sugar	2 tsp
Oil	2 tbsp
Salt	1½ tsp
Water	340 ml



### Wholemeal Dough 50%

'Whole Wheat'-'Dough' (3hr 15min) 

Yeast	1¼ tsp
Strong Wholemeal Flour	275 g (10 oz)
Strong White Flour	275 g (10 oz)
Sugar	2 tsp
Oil	2 tbsp
Salt	1½ tsp
Water	340 ml

### Granary® Dough

'Whole Wheat'-'Dough' (3hr 15min) 

Yeast	1¼ tsp
Strong Granary® Flour	550 g (1 lb 4 oz)
Sugar	2 tsp
Oil	2 tbsp
Salt	1½ tsp
Water	320 ml

### Rye Dough 100%

'Rye'-'Dough' (2hr) 

Yeast	2 tsp
Rye Flour	500 g (1 lb 2 oz)
Sugar	2 tsp
Oil	3 tbsp
Salt	2 tsp
Water	360 ml

- Use kneading blade (rye bread).
- Prove for 15 mins.

### Spelt Dough

'Rye'-'Dough' (2hr) 

Yeast	1½ tsp
Spelt Flour	500 g (1 lb 2 oz)
Honey	1 tsp
Oil	3 tbsp
Salt	1 tsp
Water	270 ml

- Use kneading blade (rye bread).
- Prove for 15 mins.

### French Sticks

'French'-'Dough' (3hr 35min) 

Yeast	½ tsp
Strong White Flour	250 g (9 oz)
Butter	15 g (½ oz)
Salt	½ tsp
Water	150 ml

### Ciabatta

Stage 1 Culture : 'Pizza'-'Dough' (45min) 

Yeast	½ tsp
Strong White Flour	175 g (6 oz)
Water	200 ml

Stage 2 : 'Basic'-'Dough' (2hr 20min) 

Yeast	¼ tsp
Strong White Flour	325 g (11½ oz)
Sugar	½ tsp
Olive Oil	2 tbsp
Salt	1½ tsp
Water	80 ml

- 1 Put all culture ingredients in bread pan and select Pizza Dough program 45 mins.
- 2 Turn off at the start/stop pad after 15 mins.  
 (12 hours later)
- 3 Add all ingredients listed in stage 2 and select Basic Dough program 2 hrs 20 mins.
- 4 Divide dough into 2 and roll each half out to a rough oblong loaf shape about 2.5 cm thick.
- 5 Place on a greased baking tray and sprinkle with flour. Allow to prove at 40°C/90°F until doubled in size (approx. 20 mins).
- 6 Bake in a preheated oven at 220°C/425°F/Gas Mark 7 for 20-25 mins or until golden brown.

- This dough can also be made as a loaf. Follow method for points 1 and 2. Increase water on stage 2 from 80-110 ml and select Italian Bake program 4 hrs 30 mins.

# Dough Recipes

## Rye and White Rolls

Stage 1 Culture : 'Pizza'-'Dough' (45min) Ⓙ

Yeast	1 tsp
Strong White Flour	75 g (3 oz)
Rye flour	150 g (5 oz)
Water	200 ml

Stage 2 : 'Rye'-'Dough' (2hr) ⓧ

Yeast	1 tsp
Rye Flour	150 g (5 oz)
Strong White Flour	100 g (4 oz)
Sugar	2 tsp
Oil	3 tbsp
Salt	2 tsp
Water	60 ml

- 1 Put all culture ingredients in bread pan and select Pizza Dough program 45 mins.
  - Use kneading blade (rye bread).
- 2 Turn off at the start/stop pad after 15 mins.
  - (12 hours later)
- 3 Add all ingredients listed in stage 2 and select Rye Dough program 2 hrs.
- 4 Divide dough into 12-15 pieces and shape into rolls.
- 5 Place on a greased baking tray and sprinkle with flour. Allow to prove at 40°C/90°F until doubled in size (approx. 20 mins).
- 6 Glaze with oil and bake in a preheated oven at 220°C/425°F/Gas Mark 7 for 10-15 mins or until golden brown.

- This dough can also be made as a loaf. Follow method for Points 1 and 2. Increase water on stage 2 from 80-110 ml and select Italian Bake program 4 hrs 30 mins.

## Panettone

'Basic'-'Dough Raisin' (2hr 20min) ⓧ

Yeast	½ tsp
Strong White Flour	300 g (11 oz)
Sugar	2 tbsp
Butter	15 g (½ oz)
Salt	¼ tsp
Ground Cardamom	½ tsp
Grated Lemon Zest	1
Medium Sized Egg, yolk	1
Milk	140 ml
*Mixed Peel	50 g (2 oz)
*Raisins	100 g (4 oz)

- 1 Place dough in a greased 18 cm (7") cake tin. Allow to prove at 40°C/90°F for approx. 30-40 mins or until doubled in size.
- 2 Bake in a preheated oven at 150°C/300°F/Gas Mark 2 for about 30 mins.

## Chelsea Buns

Enriched Dough : 'Basic'-'Dough' (2hr 20min) ⓧ

Yeast	½ tsp
Strong White Flour	250 g (9 oz)
Sugar	1 tsp
Butter	25 g (1 oz)
Milk Powder	1 tbsp
Salt	½ tsp
Egg, medium	1
Water	100 ml

### Additional Ingredients

Butter	15 g (½ oz)
Mixed Dried Fruit	100 g (4 oz)
Soft Brown Sugar	50 g (2 oz)
Mixed Spice	1 tsp

- 1 Knead the dough lightly and roll out to an oblong 26 cm x 20 cm (10" x 8").
- 2 Mix together the mixed dried fruit, soft brown sugar and mixed spice. Brush the dough with melted butter and spread the fruit mixture on top. Roll up from the long edge and cut into 8-10 slices. Arrange in a greased 23 cm (9") sandwich tin and allow to prove at 40°C/90°F until doubled in size (approx. 20 mins).
- 3 Bake in a preheated oven at 220°C/425°F/Gas Mark 7 for 15 mins or until golden brown.
- 4 Allow to cool. Drizzle with glaze icing.

## Hot Cross Buns

'Basic'-'Dough Raisin' (2hr 20min) ⓧ

Enriched Dough Ingredients (above)	One batch
Cinnamon	1 tsp
Mixed Spice	½ tsp
*Mixed Dried Fruit	100 g (4 oz)

- 1 Divide mixture into eight balls. Place on a lightly greased baking tray and allow to prove at 40°C/90°F until doubled in size (approx. 20 mins). Make a paste with approx. 2 tbsp flour mixed with 2 tbsp water and pipe a cross over the buns, or top with thin slices of shortcrust pastry.
- 2 Bake in a preheated oven at 220°C/425°F/Gas Mark 7 for 15-20 mins or until golden brown.
- 3 While still HOT, brush with a sugar glaze — 40 g (1½ oz) sugar in 4 tbsp water, boiled until a syrup is reached — (approx. 5 mins).

• For addition of ingredients with\*, follow programming instructions on P.11.

## Croissants

'Basic'-Dough' (2hr 20min) 

Yeast	½ tsp
Strong White Flour	300 g (11 oz)
Sugar	1 tsp
Butter	25 g (1 oz)
Salt	½ tsp
Egg, medium	1
Water	150 ml
Butter chilled to add when rolling	150 g (5 oz)

- 1** Roll dough to 20 cm x 25 cm (8" x 10") rectangle.



- 2** Divide butter into three portions. Dot one portion over the top two thirds of the dough.

- 3** Fold the bottom one third up and the top one third down, sealing the edges with a rolling pin. Turn the dough so that the folded edge is on the side.



- 4** Roll out to an oblong, dot the second portion of butter and continue as before. Repeat with the third portion.



- 5** Cover and allow the dough to rest in the refrigerator for 30 mins.

- 6** Repeat the rollings three more times, cover and chill for 30 mins.

- 7** Roll out pastry and divide into four squares. Cut each square into two triangles. Reroll the triangles so that they are the shape of those pictured below.

- 8** Loosely roll up each triangle towards the point, finishing with tip underneath. Curve into a crescent shape.



- 9** Place on a greased baking tray. Allow to prove at 40°C/90°F until doubled in size (approx. 20 mins).



- 10** Brush with beaten egg and bake in a preheated oven at 220°C/425°F/Gas Mark 7 for 15 mins or until crisp and well browned.

## Soft Rolls/Baps

'Basic'-Dough' (2hr 20min) 

Yeast	1 tsp
Strong White Flour	450 g (1 lb)
Sugar	½ tsp
Butter	25 g (1 oz)
Salt	½ tsp
Egg, medium	1
Water	**250 ml

\*\* For a slightly denser roll try 125 ml water and 125 ml milk.

## Sweet Rolls/Buns Suitable for Devonshire Splits

'Basic'-Dough' (2hr 20min) 

Yeast	1 tsp
Strong White Flour	450 g (1 lb)
Sugar	2 tbsps
Butter	75 g (3 oz)
Salt	½ tsp
Egg, medium	1
Milk	250 ml

- 1** Choose one of the above recipes.
- 2** Place the ingredients into the bread pan in the order listed above.
- 3** Select Basic Dough program 2 hrs 20 mins.
- 4** Divide dough into 8-10 pieces and shape into baps.
- 5** Place on a greased baking tray and allow to prove at 40°C/90°F until doubled in size (approx. 20 mins).
- 6** Dust with flour.
- 7** Bake in a preheated oven at 220°C/425°F/Gas Mark 7 for 15 mins or until golden brown.
  - For Devonshire splits, split bun and fill with cream and jam. Top with glaze icing.

# Dough Recipes

## Viennese Rolls

'Basic'-Dough' (2hr 20min) 

Yeast	¾ tsp
Strong White Flour	400 g (14 oz)
Sugar	50 g (2 oz)
Butter	100 g (4 oz)
Salt	½ tsp
Medium Sized Eggs, yolk	2
Egg, medium	1
Milk warmed	150 ml
Filling (jam or mincemeat)	½ jar
Glaze (milk)	45 ml (3 tbsp)

- 1 Put all the main ingredients in the bread pan in the order listed above. Select Basic Dough program 2 hrs 20 mins.
- 2 Remove dough from bread pan and divide into 20 pieces.
- 3 Roll out each piece of dough to a square shape approximately 10 cm x 10 cm (4" x 4") in size.
- 4 Place a teaspoon of filling in the centre of each piece of dough. Draw up the corners and edges to make a parcel. Repeat with all 20 pieces.
- 5 Place parcels in two 8" (20 cm) greased cake tins, with the gathered side down. Glaze with milk and allow to prove at 40°C/90°F until doubled in size (approx. 20-30 mins).
- 6 Bake in a preheated oven on Convection 190°C/375°F/Gas Mark 5 for 15-20 mins or until golden brown.

- Serve just warm as a breakfast or tea-time treat.

## Sweet Brioche Dough

'Basic'-Dough' (2hr 20min) 

Yeast	1 tsp
Strong white flour	250 g (9 oz)
Sugar	3 tbsp
Butter	75 g (3 oz)
Salt	½ tsp
Egg, medium	2
Milk	2 tbsp
Egg, medium to glaze	1

- 1 Select Basic Dough program 2 hrs 20 mins.
- 2 Tip dough out of the bread pan and shape three quarters into a ball and place in the bottom of a lightly greased brioche tin. Press a hole in the centre. Shape the remainder of the dough into a ball and place in the centre.
- 3 Allow to prove for 30 mins at 40°C/90°F.
- 4 Glaze with beaten egg and bake in a preheated oven at 190°C/375°F/Gas Mark 5 for 25 mins or until golden brown.

## Wholemeal Walnut Rolls 70%

'Whole Wheat'-Dough' (3hr 15min) 

Yeast	1 tsp
Strong Wholemeal Flour	350 g (12 oz)
Strong White Flour	100 g (4 oz)
Medium Oatmeal	50 g (2 oz)
Maple Syrup	2 tbsp
Oil	2 tbsp
Salt	1½ tsp
Water	320 ml
Walnut	100 g (4 oz)

- 1 Divide dough into 12 large rolls or 20 dinner rolls.
- 2 Place on a greased baking trays and sprinkle with flour. Allow to prove at 40°C/90°F until doubled in size (approx. 20 mins).
- 3 Bake in a preheated oven at 220°C/425°F/Gas Mark 7 for 12-15 mins or until golden brown.

## Dough for Tear & Share Bread

'Basic'-Dough' (2hr 20min) 

Yeast	1¼ tsp
Strong White Flour	550 g (1 lb 4 oz)
Sugar	2 tsp
Olive Oil	2 tbsp
Salt	1½ tsp
Water	310 ml

## Olive Tear & Share Bread

Dough for Tear & Share Bread (above)	One batch
Tapenade (green or black)	6 tbsp
Olives, chopped	25 g (1 oz)
Olive Oil	2 tbsp

- 1 Roll dough out into a rectangular sheet 1½ cm (½") thick, approximately 24 cm x 46 cm (9" x 18").
- 2 Spread the Tapenade over the dough, sprinkle the chopped olives and drizzle with 1 tbsp of the oil. Roll up from the short end like a swiss roll.
- 3 Cut the dough into 4 cm (1½") slices with a sharp knife and place close together in a 20 cm (8") round greased cake or flan tin, cut sides up.
- 4 Drizzle with the remaining tbsp of oil and allow to prove at 40°C/90°F until doubled in size (approx. 25 mins).
- 5 Bake in a preheated oven at 220°C/425°F/Gas Mark 7 for 15-20 mins or until golden brown.

- Delicious served warm with tapas or pasta dishes.

### Pepperoni Tear & Share Bread

Dough for Tear & Share Bread (P.28)	One batch
Tomato Puree or Sun Dried Tom Puree	4 tbsp
Pepperoni, chopped	50 g (2 oz)
Mozarella Cheese, grated	100 g (4 oz)
Dried Oregano or Basil	1 tsp
Olive Oil	1 tbsp

- 1 Roll dough out into a rectangular sheet 1½ cm (½") thick, approximately 24 cm x 46 cm (9" x 18").
- 2 Spread the tomato puree over the dough and scatter the pepperoni and cheese. Roll up from the short end like a swiss roll.
- 3 Cut the dough into 4 cm (1½") slices with a sharp knife and place close together in a 20 cm (8") round greased cake or flan tin, cut sides up.
- 4 Drizzle with the olive oil and sprinkle with the dried herbs and allow to prove at 40°C/90°F until doubled in size (approx. 25 mins).
- 5 Bake in a preheated oven at 220°C/425°F/Gas Mark 7 for 15-20 mins or until golden brown.

- Delicious served warm with pasta dishes. Use sundried tomatoes in place of pepperoni for vegetarians.

### Picnic Tear & Share Bread

Dough for Tear & Share Bread (P.28)	One batch
Grainy Mustard	2 tbsp
Cooked Ham, chopped	75 g (3 oz)
Strong Cheddar Cheese, grated	75 g (3 oz)

- 1 Roll dough out into a rectangular sheet 1½ cm (½") thick, approximately 24 cm x 46 cm (9" x 18").
- 2 Spread the mustard over the dough and scatter the ham and cheese—reserve a little of the cheese to sprinkle on top. Roll up from the short end like a swiss roll.
- 3 Cut the dough into 4 cm (1½") slices with a sharp knife and place close together in a 20 cm (8") round greased cake or flan tin, cut sides up.
- 4 Sprinkle with the remaining cheese and allow to prove at 40°C/90°F until doubled in size (approx. 25 mins).
- 5 Bake in a preheated oven at 220°C/425°F/Gas Mark 7 for 15-20 mins or until golden brown.

- Delicious served warm with soup or with a Ploughmans lunch.

### Focaccia

#### 'Pizza'-Dough (45min) ⌚

Yeast	½ tsp
Strong White Flour	300 g (11 oz)
Olive Oil	1 tbsp
Salt	1 tsp
Water	170 ml

- 1 Roll and pat the dough into a 30 cm x 25 cm (12" x 10") rectangle on a greased baking tray.
- 2 Make indentations over the whole dough using your fingertips.
- 3 Add one of the following toppings:
  - 1 small red onion sliced and softened with 1 tsp olive oil and 1 tsp balsamic vinegar. (Do this in a bowl covered in cling film in the microwave for 1-2 min).
  - 2 tbsp chopped black or green olives.
  - 2 chopped cloves of garlic, sea salt and cracked black pepper corns.
  - 2 tbsp chopped sundried tomatoes.
- 4 Allow to prove at 40°C/90°F until doubled in size (approx. 30 mins).
- 5 Drizzle with olive oil and bake in a preheated oven at 190°C/375°F/Gas Mark 5 for 20-30 mins or until golden at the edges and cooked well in the centre.

- Serve warm with pasta dishes.

### Pizza

#### 'Pizza'-Dough (45min) ⌚

Yeast	½ tsp
Strong White Flour	300 g (11 oz)
Olive Oil	1 tbsp
Salt	1 tsp
Water	170 ml

- 1 Press out dough using the heel of your hand to a 25 cm (10") circle or two 25 cm (10") circles for thin and crispy base on to a greased baking tray.
  - 2 Allow to prove at 40°C/90°F until doubled in size (approx. 20 mins).
  - 3 Add topping of your choice and bake in a preheated oven at 220°C/425°F/Gas Mark 7 for 15-20 mins, depending on amount of topping.
- To freeze pizza bases follow method to stage 2 and bake without toppings for 5 mins. Allow to cool, freeze. To use remove from freezer immediately add topping (not too much) and bake as above stage 3.

# Cake Recipes



## [bake only]

Bake cakes and teabreads.

: Timer cannot be used

- Use BAKE ONLY mode for these recipes.
- This mode is not suitable for all types of cake, such as Victoria sandwich or those that require going into a hot oven.
- Always use our tablespoon and teaspoon measure in these recipes.

The cake is made according to the recipe in a separate mixing bowl and then baked inside the bread pan.

①



Mix the ingredients in a bowl.

②



Line the bottom and sides of the bread pan with baking parchment and pour in the mixture.

- Make sure that the kneading blade is removed from the pan before the cake mixture is added.
- Ensure that the cake mixture is kept inside the baking parchment.

③



Set the breadmaker. (P.14)

- The maximum baking time is 1 hour and 30 mins.

## Apple and Ginger Cake 'Bake only' (55min)

Butter	100 g (4 oz)
Golden Syrup	200 g (8 oz)
Self Raising Flour	300 g (11 oz)
Baking Powder	3 ml (½ tsp)
Ground Cinnamon	3 ml (½ tsp)
Ground Cloves	3 ml (½ tsp)
Medium Sized Eggs, beaten	2
Tart Dessert Apples e.g. Granny Smiths, grated	2
Preserved Stem Ginger, drained and finely chopped	75 g (3 oz)
Demerara Sugar	1½ tbsp

- 1 Warm the butter and syrup until just melted. This can be done on the hob or in the microwave oven. (High power for 1 min).
- 2 Sieve the flour, baking powder and spices into a bowl. Add the syrup mixture and the beaten eggs.
- 3 Add the grated apple and the chopped ginger and mix well.
- 4 Remove the kneading blade from the bread pan and line the bottom and sides with baking parchment.
- 5 Place the mixture in the bread pan, being careful to ensure that the mixture is inside the baking parchment.
- 6 Carefully sprinkle the Demerara sugar on top of the mixture.
- 7 Select Bake Only program and enter 55 mins on the timer.
- 8 After baking test with a skewer to see if the cake is cooked. If the cake does require extra time, select the Bake Only program again and enter a further 3-5 mins on the timer. If it is still just slightly sticky this will cook through during the stand period.
- 9 Take the bread pan out of the breadmaker using oven gloves. Leave to stand for 5-10 mins before removing from the bread pan and allowing to cool.

## Banana and Walnut Loaf 'Bake only' (45min)

Soft Light Brown Sugar	50 g (2 oz)
Butter	75 g (3 oz)
Egg, medium	1
Plain Flour	225 g (8 oz)
Baking Powder	2 tsp
Grated Rind	1 lemon
Lemon Juice	1 tbsp
Medium Bananas, peeled & mashed	4
Walnuts, roughly chopped	50 g (2 oz)
Walnuts, finely chopped	15 g (½ oz)

- 1 Cream the butter and sugar together until soft then beat in the egg.
  - 2 Add the sieved flour and baking powder together with the lemon rind and juice.
  - 3 Add the mashed bananas and the roughly chopped walnuts and mix to a soft consistency.
  - 4 Remove the kneading blade from the bread pan and line the bottom and sides with baking parchment.
  - 5 Place the mixture in the bread pan, being careful to ensure that the mixture is inside the baking parchment.
  - 6 Carefully sprinkle the finely chopped walnuts on top of the mixture.
  - 7 Select Bake Only program and enter 45 mins on the timer.
  - 8 After baking test with a skewer to see if the cake is cooked. If the cake does require extra time, select the Bake Only program again and enter a further 3-5 mins on the timer. If it is still just slightly sticky this will cook through during the stand period.
  - 9 Take the bread pan out of the bread maker using oven gloves. Leave to stand for 5-10 mins before removing from the bread pan and allowing to cool.
- Delicious spread with butter.

### Boozy Cake 'Bake only' (45min)

Butter	125 g (4 oz)
Mixed Dried Fruit	300 g (11 oz)
Light Brown Soft Sugar	50 g (2 oz)
Juice of 1 Orange	45 ml (3 tbsps)
Zest of 1 Orange	
Guinness® or Caffreys®	120 ml (4floz)
Bicarbonate of Soda	5 ml (1 tsp)
Medium Sized Eggs, beaten	2
Plain Flour	200 g (7 oz)
Mixed Spice	8 ml (1½ tsp)
Topping (flaked almonds)	15 g (½ oz)
Topping (demerara sugar)	15 g (½ oz)

- 1 Heat the butter, dried fruit, sugar, zest and juice of an orange and Guinness® together until the fruit plumps up. This can be done on the hob by bringing the ingredients to the boil, stirring and then simmering for 10-15 mins or heating in the microwave oven on High power for 8 mins, stirring twice.
- 2 Leave to cool for 10 mins, then stir in the bicarbonate of soda, this will make the mixture foam.
- 3 Stir in the eggs, flour and mixed spice, and mix well.
- 4 Remove the kneading blade from the bread pan and line the bottom and sides with baking parchment.
- 5 Place the mixture into the bread pan, being careful to ensure that the mixture is inside the baking parchment.
- 6 Sprinkle the flaked almonds and demerara on the top of the mixture.
- 7 Select Bake Only program and enter 45 mins on the timer.
- 8 After baking test with a skewer to see if the cake is cooked. If the cake does require extra time, select the Bake Only program again and enter a further 3-5 mins on the timer. If it is still just slightly sticky this will cook through during the stand period.
- 9 Take the bread pan out of the breadmaker using oven gloves. Leave to stand for 5-10 mins before removing from the bread pan and allowing to cool.

### Fruit Tea Bread 'Bake only' (55min)

Mixed Dried Fruit	350 g (12 oz)
Chopped Dates	50 g (2 oz)
Chopped Walnuts	50 g (2 oz)
Chopped Cherries	100 g (4 oz)
Strong tea	300 ml (10 floz)
Butter	75 g (3 oz)
Medium Sized Eggs, beaten	3
Plain Flour	250 g (9 oz)
Bicarbonate of Soda	5 ml (1 tsp)

- 1 Place the fruit, dates, walnuts, cherries, water and butter together and heat until the fat has melted and the liquid is hot. This can be done on the hob or in the microwave oven. (High power for 3-4 mins)
- 2 Allow to cool slightly, then add eggs, flour and the bicarbonate of soda. Mix well.

- 3 Remove the kneading blade from the bread pan and line the bottom and sides with baking parchment.
- 4 Place the mixture into the bread pan, being careful to ensure that the mixture is inside the baking parchment.
- 5 Select Bake Only program and enter 55 mins on the timer.
- 6 After baking test with a skewer to see if the cake is cooked. If the cake does require extra time, select the Bake Only program again and enter a further 3-5 mins on the timer. If it is still just slightly sticky this will cook through during the stand period.
- 7 Take the bread pan out of the breadmaker using oven gloves. Leave to stand for 5-10 mins before removing from the bread pan and allowing to cool.

### Gingerbread 'Bake only' (35min)

Demerara Sugar	25 g (1 oz)
Butter	75 g (3 oz)
Golden Syrup	50 g (2 oz)
Black Treacle	75 g (3 oz)
Plain Flour	225 g (8 oz)
Ground Ginger	8 ml (1½ tsp)
Baking Powder	8 ml (1½ tsp)
Bicarbonate of Soda	3 ml (½ tsp)
Salt	3 ml (½ tsp)
Milk	150 ml (¼ pint)
Medium Sized Egg, beaten	1

- 1 Warm sugar, butter, golden syrup and treacle together until just melted. This can be done on the hob or in the microwave oven (High power for 1min).
- 2 Stir in all of the sieved dry ingredients.
- 3 Mix in the milk and the beaten egg.
- 4 Beat thoroughly with a wooden spoon.
- 5 Remove the kneading blade from the bread pan and line the bottom and sides with baking parchment.
- 6 Place the mixture into the bread pan, being careful to ensure that the mixture is inside the baking parchment.
- 7 Select Bake Only program and enter 35 mins on the timer.
- 8 After baking test with a skewer to see if the cake is cooked. If the cake does require extra time, select the Bake Only program again and enter a further 3-5 mins on the timer. If it is still just slightly sticky this will cook through during the stand period.
- 9 Take the bread pan out of the breadmaker using oven gloves. Leave to stand for 5-10 mins before removing from the bread pan and allowing to cool.

# Cake Recipes

## Hazelnut and Honey Loaf 'Bake only' (50min)

Butter	175 g (6 oz)
Dark Brown Sugar	50 g (2 oz)
Honey	50 g (2 oz)
Eggs, medium	3
Hazelnuts, finely chopped	100 g (4 oz)
Self Raising Flour	225 g (8 oz)
Milk	60 ml (4 tbsp)
Topping (chocolate & hazelnut spread)	100 g (4 oz)
Topping (cream cheese)	50 g (2 oz)

- 1 Cream together the butter, sugar and honey until soft and fluffy.
- 2 Add the eggs one at a time, beating well after each addition. Stir in the hazelnuts.
- 3 Fold in the flour and mix to a soft consistency with the milk.
- 4 Remove the kneading blade from the bread pan and line the bottom and sides with baking parchment.
- 5 Place the mixture in the bread pan, being careful to ensure that the mixture is inside the baking parchment.
- 6 Select Bake Only program and enter 50 mins on the timer.
- 7 After baking test with a skewer to see if the cake is cooked. If the cake does require extra time, select the Bake Only program again and enter a further 3-5 mins on the timer. If it is still just slightly sticky this will cook through during the stand period.
- 8 Take the bread pan out of the breadmaker using oven gloves. Leave to stand for 5-10 mins before removing from the bread pan and allowing to cool.
- 9 Beat the chocolate spread & cream cheese together & spread on the top of the cooled loaf.

## Coffee & Pecan Nut Cake 'Bake only' (50min)

Butter	225 g (8 oz)
Light Muscovado Sugar	100 g (4 oz)
Eggs, medium	3
Pecan Nuts, finely chopped	75 g (3 oz)
Self Raising Flour	225 g (8 oz)
Baking Powder	1 tsp
Strong Fresh Coffee	2-3 tbsp

- Optional Topping:
 

Mascarpone Cheese	150 g (5 oz)
Icing Sugar	100 g (4 oz)
Strong Fresh Coffee	1 tbsp

- 1 Cream together the butter, sugar until soft and fluffy.
- 2 Add the eggs one at a time, beating well after each addition. Stir in the Pecan nuts.

- 3 Fold in the flour and mix to a soft consistency with the coffee.
- 4 Remove the kneading blade from the bread pan and line the bottom and sides with baking parchment.
- 5 Place the mixture in the bread pan, being careful to ensure that the mixture is inside the baking parchment.
- 6 Select Bake Only program and enter 50mins on the timer.
- 7 After baking test with a skewer to see if the cake is cooked. If the cake does require extra time, select the Bake Only program again and enter a further 3-5 mins on the timer. If it is still just slightly sticky this will cook through during the stand period.
- 8 Take the bread pan out of the breadmaker using oven gloves. Leave to stand for 5-10 mins before removing from the bread pan and allowing to cool.
- 9 Beat the mascarpone cheese and icing sugar together with the coffee & spread on the top of the cooled loaf.

## Cherry & Marzipan Cake 'Bake only' (55min)

Golden Caster Sugar	50 g (2 oz)
Butter	175 g (6 oz)
Eggs, medium	3
Self Raising Flour	225 g (8 oz)
Glace Cherries, chopped	100 g (4 oz)
Marzipan, grated	75 g (3 oz)
Milk	60 ml (4 tbsp)
Toasted, Flaked Almonds	15 g (½ oz)

- 1 Cream the butter and sugar together until soft then beat in the eggs, one at a time.
- 2 Add the flour with the cherries & grated marzipan, mix well with the milk to a soft consistency.
- 3 Remove the kneading blade from the bread pan and line the bottom and sides with baking parchment.
- 4 Place the mixture in the bread pan, being careful to ensure that the mixture is inside the baking parchment.
- 5 Carefully sprinkle the toasted almonds on top of the mixture.
- 6 Select Bake Only program and enter 55mins on the timer.
- 7 After baking test with a skewer to see if the cake is cooked. If the cake does require extra time, select the Bake Only program again and enter a further 3-5 mins on the timer. If it is still just slightly sticky this will cook through during the stand period.
- 8 Take the bread pan out of the breadmaker using oven gloves. Leave to stand for 5-10 mins before removing from the bread pan and allowing to cool.



### Soda Bread 'Bake only' (45min)

Plain Flour	400 g (14 oz)
Bicarbonate of Soda	1 tsp
Sugar	1 tsp
Salt	½ tsp
Buttermilk	270 ml
Milk	30 ml

- 1 Sieve the flour and bicarbonate of soda into a bowl and mix well. Then add sugar and salt.
- 2 Add the buttermilk and milk, mixing quickly to form a soft dough.
- 3 Remove the kneading blade from the bread pan and line the bottom and sides with baking parchment.
- 4 Place the mixture into the bread pan, being careful to ensure that the mixture is inside the baking parchment.
- 5 Select Bake Only program and enter 45 mins on the timer.
- 6 After baking test with a skewer to see if the bread is cooked. If the bread does require extra time, select the Bake Only program again and enter a further 3-5 mins on the timer.
- 7 Remove the bread out of the pan using oven gloves and allow to cool.

### Wholemeal Soda Bread 'Bake only' (45min)

Self Raising Wholemeal Flour	400 g (14 oz)
Bicarbonate of Soda	1 tsp
Salt	1 tsp
Medium Sized Eggs, beaten	2
Buttermilk	320 ml

- 1 Place flour and bicarbonate of soda into a bowl and mix well. Then add salt.
- 2 Add the beaten eggs and buttermilk, mixing quickly to form a soft dough.
- 3 Remove the kneading blade from the bread pan and line the bottom and sides with baking parchment.
- 4 Place the mixture into the bread pan, being careful to ensure that the mixture is inside the baking parchment.
- 5 Select Bake Only program and enter 45 mins on the timer.
- 6 After baking test with a skewer to see if the bread is cooked. If the bread does require extra time, select the Bake Only program again and enter a further 3-5 mins on the timer.
- 7 Remove the bread out of the pan using oven gloves and allow to cool.

### Yeast and Dairy Free Spelt Loaf 'Bake only' (45min)

Spelt Flour	400 g (14 oz)
Bicarbonate of Soda	1 tsp
Salt	1 tsp
Medium Sized Eggs, beaten	2
Soya milk	320 ml

- 1 Place flour and bicarbonate of soda into a bowl and mix well. Then add salt.
- 2 Add the beaten eggs and soya milk, mixing quickly to form a soft dough.
- 3 Remove the kneading blade from the bread pan and line the bottom and sides with baking parchment.
- 4 Place the mixture into the bread pan, being careful to ensure that the mixture is inside the baking parchment.
- 5 Select Bake Only program and enter 45 mins on the timer.
- 6 After baking test with a skewer to see if the bread is cooked. If the bread does require extra time, select the Bake Only program again and enter a further 3-5 mins on the timer.
- 7 Remove the bread out of the pan using oven gloves and allow to cool.

### Cornbread 'Bake only' (50min)

Plain Flour	150 g (5 oz)
Fine Cornmeal or Polenta	150 g (5 oz)
Baking Powder	1 tbsp
Salt	1 tsp
Eggs, medium	2
Carton Buttermilk	284 ml
Milk	100 ml
Butter, melted and cooled	50 g (2 oz)

- 1 Combine flour, cornmeal, baking powder and salt into a bowl and mix well.
- 2 Beat the eggs with the buttermilk, milk and butter in another bowl.
- 3 Pour the egg mixture into the dry ingredients and stir to a smooth batter.
- 4 Remove the kneading blade from the bread pan and line the bottom and sides with baking parchment.
- 5 Place the mixture into the bread pan, being careful to ensure that the mixture is inside the baking parchment.
- 6 Select Bake Only program and enter 50 mins on the timer.
- 7 After baking test with a skewer to see if the bread is cooked. If the bread does require extra time, select the Bake Only program again and enter a further 3-5 mins on the timer.
- 8 Remove the bread out of the pan using oven gloves and allow to cool.

# Care & Cleaning

Before cleaning, unplug your breadmaker and allow it to cool down.

■ To avoid damaging your breadmaker...

- Do not use anything abrasive! (cleansers, scouring pads etc)  
Use a soft damp cloth when cleaning bread pan and kneading blade.
- Do not wash any part of your breadmaker in the dishwasher!
- Do not use benzene, thinners, or alcohol!
- Keep your breadmaker clean and dry.

## Bread pan & kneading blade

Twist the bread pan anti-clockwise to remove.  
Remove the kneading blade and wash in warm soapy water.



- Ensure the area around the shaft and inside the kneading blade are cleaned thoroughly.
- If the kneading blade is difficult to remove from the pan, place a small quantity of warm water into the pan and soak for 5-10 minutes. Do not submerge the pan in water.



## Measuring spoon & cup

Wash with water.

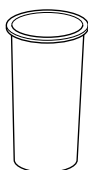
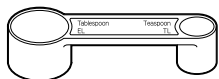

- Not dishwasher safe

## Lid

Wipe with a damp cloth.



## Steam vent

Wipe with a damp cloth.



## Body

Wipe with a damp cloth.

- Wipe gently to avoid damaging the temperature sensor.

Temperature sensor

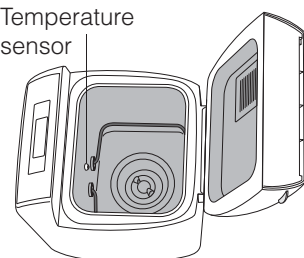

• The colour of the inside of the unit may change with use.

### Dispenser lid (SD-257 only)

Remove and wash with water.

- Raise the dispenser lid to an angle of approximately 75 degrees. Align the connections and pull towards you to remove or push carefully back at the same angle to attach. (Wait until the machine has cooled down first, because it will be very hot immediately after use)
- Take care not to damage the seal. (Damage could lead to leakage of steam, condensation, or deformation)

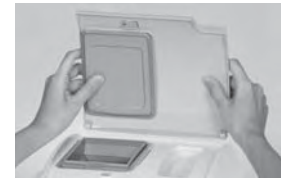

### Raisin nut dispenser

(SD-257 only)

Remove and wash with water.

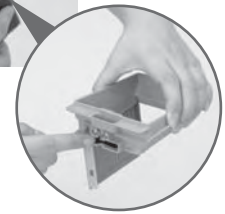

- Wash after each use to remove any residue.

## To protect the non-stick finish

Bread pan and kneading blade are coated with a non-stick finish to avoid stains and to make it easier to remove bread.

To avoid damaging it, please follow the instructions below.

- Do not use hard utensils such as a knife or a fork when removing bread from the bread pan. (If the bread cannot be easily removed from the bread pan, leave the bread pan for 5-10 minutes to cool, making sure that it is not left unattended where somebody or something may get burnt.)  
After that, shake the pan several times using oven gloves.  
(Hold the handle down so that it does not get in the way of bread.)
- Ensure that the kneading blade is not embedded in the bread loaf before slicing it. If it is embedded, wait for the loaf to cool and remove it. In removing the blade, press on the base of the loaf and manipulate the blade gently to avoid damaging the loaf. (Do not use hard or sharp utensils such as a knife or a fork.)  
Be careful not to get burns as the kneading blade may still be hot.
- Use the soft sponge when cleaning bread pan and kneading blade. Do not use anything abrasive such as cleansers or scouring pads.
- Hard, coarse or large ingredients such as flours with whole or ground grains, sugar, or the addition of nuts and seeds may damage the non-stick finish of the bread pan. If using large chunk of ingredient, break into small pieces. Please make sure to follow the recipe quantities stated.

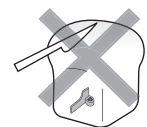

# Troubleshooting

Before calling for service, please check through this section.

Problem	Cause → Action
<p>My bread does not rise.</p> <hr/> <p>The top of my bread is uneven.</p>	<ul style="list-style-type: none"> <li>● The quality of the gluten in your flour is poor, or you have not used strong flour. (Gluten quality can vary depending on temperature, humidity, how the flour is stored, and the season of harvest)               <ul style="list-style-type: none"> <li>→ Try another type, brand or another batch of flour.</li> </ul> </li> <li>● The dough has become too firm because you haven't used enough liquid.               <ul style="list-style-type: none"> <li>→ Stronger, Organic and Stoneground flour with higher protein content absorbs more water than others, so try adding an extra 10-20 ml of water.</li> </ul> </li> <li>● You are not using the right type of yeast.               <ul style="list-style-type: none"> <li>→ Use dry yeast from a sachet, which has 'Easy Blend', 'Fast Action' or 'Easy Bake' written on it.</li> <li>This type does not require pre-fermentation.</li> </ul> </li> <li>● You are not using enough yeast, or your yeast is old.               <ul style="list-style-type: none"> <li>Make sure yeast sachets not open for longer than 48 hours.</li> <li>→ Use the measuring spoon provided. Check the yeast's expiry date.</li> </ul> </li> <li>● The yeast has touched the liquid before kneading.               <ul style="list-style-type: none"> <li>→ Check that you have put in the ingredients in the correct order according to the instructions, adding the water and liquids last of all. (P.8)</li> </ul> </li> <li>● You have used too much salt, or not enough sugar.               <ul style="list-style-type: none"> <li>→ Check the recipe and measure out the correct amounts using the measuring spoon provided.</li> <li>→ Check that salt and sugar is not included in other ingredients.</li> </ul> </li> </ul>
<p>My bread is full of air holes.</p>	<ul style="list-style-type: none"> <li>● You have used too much yeast.               <ul style="list-style-type: none"> <li>→ Check the recipe and measure out the correct amount using the measuring spoon provided.</li> </ul> </li> <li>● You have used too much liquid.               <ul style="list-style-type: none"> <li>→ Some types of flour absorb more water than others, so try using 10-20 ml less water.</li> </ul> </li> </ul>
<p>My bread seems to have collapsed after rising.</p>	<ul style="list-style-type: none"> <li>● The quality of your flour isn't very good.               <ul style="list-style-type: none"> <li>→ Try using a different brand of flour.</li> </ul> </li> <li>● You have used too much liquid.               <ul style="list-style-type: none"> <li>→ Try using 10-20 ml less water.</li> </ul> </li> </ul>
<p>My bread has risen too much.</p>	<ul style="list-style-type: none"> <li>● You have used too much yeast/water.               <ul style="list-style-type: none"> <li>→ Check the recipe and measure out the correct amount using the measuring spoon (yeast)/cup (water) provided.</li> <li>→ Check that excess water amount is not included in other ingredients.</li> </ul> </li> <li>● You have not used enough flour.               <ul style="list-style-type: none"> <li>→ Carefully weigh the flour using scales.</li> </ul> </li> </ul>
<p>Why is my bread pale and sticky?</p>	<ul style="list-style-type: none"> <li>● You are not using enough yeast, or your yeast is old.               <ul style="list-style-type: none"> <li>→ Use the measuring spoon provided. Check the yeast's expiry date.</li> </ul> </li> <li>● There has been a power failure, or the machine has been stopped during breadmaking.               <ul style="list-style-type: none"> <li>→ The machine switches off if it is stopped for more than ten minutes. You will need to remove the bread from the pan and start again with new ingredients.</li> </ul> </li> </ul>
<p>There is excess flour around the bottom and sides of my bread.</p>	<ul style="list-style-type: none"> <li>● You have used too much flour, or you are not using enough liquid.               <ul style="list-style-type: none"> <li>→ Check the recipe and measure out the correct amount using scales for the flour or the measuring cup provided for liquids.</li> </ul> </li> </ul>

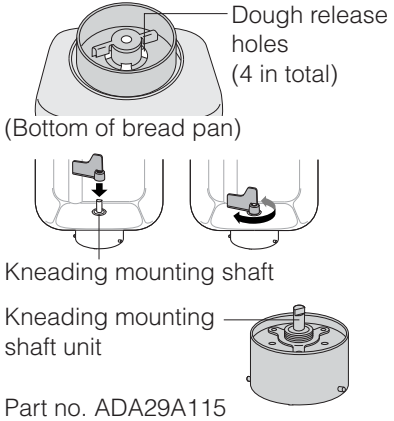
Problem	Cause → Action
<p>Why has my bread not mixed properly?</p>	<ul style="list-style-type: none"> <li>● You haven't put the kneading blade in the bread pan.               <ul style="list-style-type: none"> <li>→ Make sure the blade is in the pan before you put in the ingredients.</li> </ul> </li> <li>● There has been a power failure, or the machine has been stopped during breadmaking.               <ul style="list-style-type: none"> <li>→ The machine switches off if it is stopped for more than ten minutes. You might be able to start the loaf again, though this might give poor results if kneading had already begun.</li> </ul> </li> <li>● The kneading mounting shaft in the bread pan is stiff and does not rotate.               <ul style="list-style-type: none"> <li>→ If the kneading mounting shaft does not rotate when the blade is attached, you will need to replace the kneading mounting shaft unit (consult the place of purchase or a Panasonic service centre: 0844 8443868 or order online at <a href="http://www.panasonic.co.uk">www.panasonic.co.uk</a>).</li> </ul> </li> </ul>
<p>My bread has not been baked.</p>	<ul style="list-style-type: none"> <li>● The 'DOUGH' option was selected.               <ul style="list-style-type: none"> <li>→ The 'DOUGH' option does not include a baking process.</li> </ul> </li> <li>● There has been a power failure, or the machine has been stopped during breadmaking.               <ul style="list-style-type: none"> <li>→ The machine switches off if it is stopped for more than approx. ten minutes. You can try baking the dough in your oven if it has risen and proved.</li> </ul> </li> <li>● There is not enough water and the motor protection device has activated. This only happens when the unit is overloaded and excessive force is applied to the motor.               <ul style="list-style-type: none"> <li>→ Visit place of purchase for a service consultation. Next time, check the recipe and measure out the correct amount using the measuring cup provided for liquid and scales for weighing flour.</li> </ul> </li> </ul>
<p>Dough leaks out of the bottom of the bread pan.</p>	<ul style="list-style-type: none"> <li>● A small amount of dough will escape through the four holes (so that it does not stop the rotating parts from rotating). This is not a fault, but check occasionally that the kneading mounting shaft rotate properly.               <ul style="list-style-type: none"> <li>→ If the kneading mounting shaft does not rotate when the blade is attached, you will need to replace the kneading mounting shaft unit (from our Customer Support dept on 0844 8443868 or write to the UK address on the back cover or order online at <a href="http://www.panasonic.co.uk">www.panasonic.co.uk</a>).</li> </ul> </li> </ul> <div data-bbox="1027 1144 1422 1563" style="text-align: right;">  <p>Dough release holes (4 in total) (Bottom of bread pan) Kneading mounting shaft Kneading mounting shaft unit Part no. ADA29A115</p> </div>
<p>The sides of my bread have collapsed and the bottom is damp.</p>	<ul style="list-style-type: none"> <li>● You have left the bread in the bread pan for too long after baking.               <ul style="list-style-type: none"> <li>→ Remove the bread promptly after baking.</li> </ul> </li> <li>● There has been a power failure, or the machine has been stopped during breadmaking.               <ul style="list-style-type: none"> <li>→ The machine switches off if it is stopped for more than ten minutes. You may try baking the dough in your oven.</li> </ul> </li> </ul>
<p>The kneading blade rattles.</p>	<ul style="list-style-type: none"> <li>● This is because the blade fits loosely on the shaft. (This is not a fault)</li> </ul>
<p>I can smell burning while the bread is baking. Smoke is coming out of the steam vent.</p>	<ul style="list-style-type: none"> <li>● Ingredients may have been spilt on the heating element.               <ul style="list-style-type: none"> <li>→ Sometimes a little flour, raisins or other ingredients may be flicked out of the bread pan during mixing. Simply wipe the element gently after baking once the breadmaker has cooled down.</li> <li>→ Remove the bread pan from the breadmaker to place ingredients.</li> </ul> </li> </ul>

# Troubleshooting

Before calling for service, please check through this section.

Problem	Cause → Action
<p>The kneading blade stays in the bread when I remove it from the bread pan.</p>	<ul style="list-style-type: none"> <li>● The dough is a little stiff. → Allow the bread to cool completely before removing the blade carefully. Some types of flour absorb more water than others, so try adding an extra 10-20 ml of water next time.</li> <li>● Crust has built up underneath the blade. → Wash the blade and its spindle after each use.</li> </ul>
<p>The crust creases and goes soft on cooling.</p>	<ul style="list-style-type: none"> <li>● The steam remaining in the bread after cooking can pass into the crust and soften it slightly. → To reduce the amount of steam, try using 10-20 ml less water. Remove loaf from pan immediately after baking completed.</li> </ul>
<p>How can I keep my crust crispy?</p>	<ul style="list-style-type: none"> <li>● To make your bread crispier, you could use the 'french' mode or the 'DARK' crust colour option, or even bake it in the oven at 200°C/gas mark 6 for an extra 5-10 minutes.</li> </ul>
<p>My bread is sticky and slices unevenly.</p>	<ul style="list-style-type: none"> <li>● It was too hot when you sliced it. → Allow your bread to cool on rack before slicing to release the steam.</li> </ul>
<p>TEMP appears on the display.</p>	<ul style="list-style-type: none"> <li>● The unit is hot (above 40°C/105°F). → Allow the unit to cool down to below 40°C/105°F before using it again (TEMP will disappear).</li> </ul>
<p>POWER ALERT appears on the display.</p>	<ul style="list-style-type: none"> <li>● There has been a power failure for approx. 10 minutes (the plug has been accidentally pulled out, or the breaker has been activated), or there is another problem with the power supply. → The operation will not be affected if the problem with the power supply is only momentary. The breadmaker will operate again if its power is restored within 10 minutes, but the end result may be affected.</li> </ul>
<p>0:00 appears on the display.</p>	<ul style="list-style-type: none"> <li>● There has been a power failure for a certain amount of time (differs depending on the circumstances-e.g. mains power failure, unplugging, malfunctioning fuse or breaker). → Remove the ingredients and start again using new.</li> </ul>
<p>Extra ingredients are not mixed properly in brioche.</p>	<ul style="list-style-type: none"> <li>● Did you add extra ingredients within 5 min of the beep? → Butter must be added when '0' shows in the display.</li> </ul>
<p>There is excess oil on the bottom of brioche. The crust is oily. My bread has big holes.</p>	<ul style="list-style-type: none"> <li>● Did you add butter within 5 min of the beep? → Butter must be added when '0' shows in the display.</li> </ul>



# Specification

Power supply	230-240 V ~ 50 Hz		
Power consumed	505-550 W		
Capacity	(Strong flour for a loaf)	max. 550 g	min. 400 g
	(Strong flour for a dough)	max. 600 g	min. 250 g
	(Yeast)	max. 8 g	min. 0.75 g
Capacity of raisin nut dispenser	max. 150 g dried fruit/nuts		
Timer	Digital timer (up to 13 hours)		
Dimensions (H × W × D)	approx. 37.0 × 28.0 × 33.0 cm		
Weight	(SD-257) approx. 6.8 kg	(SD-256) approx. 6.4 kg	
Accessories	Measuring cup, measuring spoon		

## Information on Disposal for Users of Waste Electrical & Electronic Equipment (private households)



This symbol on the products and/or accompanying documents means that used electrical and electronic products should not be mixed with general household waste. For proper treatment, recovery and recycling, please take these products to designated collection points, where they will be accepted on a free of charge basis. Alternatively, in some countries you may be able to return your products to your local retailer upon the purchase of an equivalent new product. Disposing of this product correctly will help to save valuable resources and prevent any potential negative effects on human health and the environment which could otherwise arise from inappropriate waste handling. Please contact your local authority for further details of your nearest designated collection point. Penalties may be applicable for incorrect disposal of this waste, in accordance with national legislation.

## Information on Disposal in other Countries outside the European Union

This symbol is only valid in the European Union.

If you wish to discard this product, please contact your local authorities or dealer and ask for the correct method of disposal.

### Panasonic Test and Development Kitchen

Panasonic Consumer Electronics U.K.

A Division of Panasonic U.K. Ltd

Willoughby Road, Bracknell, Berks, RG12 8FP

Importer's name & address pursuant to the EU GPSD directive 2001/95/EC/Art.5

**Panasonic Marketing Europe GmbH**

Hagenauer Str.43 65203 Wiesbaden F.R.GERMANY

Panasonic Corporation

Web Site: <http://www.panasonic.co.uk/>

DZ50E160

F0210S0

Printed in China