

Panasonic®

Model No.
TX-L32G20B
TX-L37G20B

Operating Instructions LCD Television

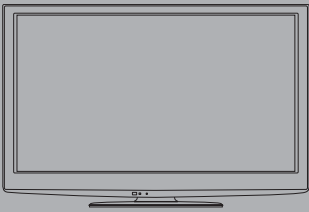

VIERA



Thank you for purchasing this Panasonic product.
Please read these instructions carefully before operating this product and retain them for future reference.
The images shown in this manual are for illustrative purposes only.
"B" model no. suffix denotes UK model.

English

U.K. Standard



TQB0E0945-1

Features

■ freesat HD tuner built-in

Receives freesat - free digital satellite broadcasts in the UK

This TV has a built-in freesat HD tuner.

freesat is a free digital TV service which broadcasts via satellite so you can receive TV, radio, interactive TV, and HD TV with crystal clear reception.

You can enjoy sharp pictures, vivid colours, multi-channel sound, and various services with the interactive content.

■ DVB-T / DVB-T2 tuner built-in

Receives DVB (Digital Video Broadcasting) digital terrestrial broadcasts

DVB-T2 is an advanced digital terrestrial system for more efficient transmission.

Available DVB-T2 broadcasts will be tuned automatically when you perform DVB Auto Setup.

■ GUIDE Plus+ (p. 20)

This TV supports Gemstar-TV Guide sent from the GUIDE Plus+ system.

■ HD TV 1080p

This TV supports high definition TV signals.

■ Sharp pictures and clear sound with HDMI connection (p. 97)

Enjoy high definition digital picture and high quality sound by using an HDMI cable.

- This TV incorporates HDMI (Version 1.4 with Content Type, Audio Return Channel) and HDMI (Version 1.3a with Deep Colour) technology.

■ Using USB devices

Enjoy recording and playback the digital TV programmes to the USB HDD. (p. 62 and p. 71)

Enjoy the photo, video and music in the USB Flash Memory on Media Player. (p. 66)

Wireless LAN Adaptor for the network connection. (p. 6 and p. 13)

Entering characters with the USB Keyboard in VIERA CAST. (p. 83)

■ Timer Programming (p. 22 and p. 52)

Timer Programming enables you to use functions such as programme reminder and programme recording to the external recorder / registered USB HDD.

■ Dolby Digital Plus decoder

It is possible to decode Dolby Digital Plus audio track (multi-channel sound) and output as a Dolby Digital multi-channel sound signal from the DIGITAL AUDIO OUT terminal.

■ VIERA IMAGE VIEWER - SD Card viewer in Media Player (p. 66 - 73)

Enjoy your photos or videos recorded on an SD Card on the TV screen.

■ SDXC Card

This TV supports SDXC Card. SDXC is the latest standard of SD Card and a higher storage capacity card.

■ AVCHD

It is possible to play moving pictures recorded on an SD Card or a USB Flash Memory in AVCHD format.

AVCHD is a high definition video recording format. (p. 70)

■ DivX

Offers good compatibility when going from PC to TV, etc. for easy enjoyment of moving pictures. DivX is a video codec that was developed by DivX, Inc. (p. 95)

■ DLNA

DLNA is a standard that makes digital electronics easier and more convenient to use on a home network. For example, you can enjoy watching photos and videos stored in the PC connected to your home network by accessing from the TV. (p. 80)

■ VIERA CAST - Enjoy great web entertainment (p. 83)

Enjoy the internet contents on the TV such as photos, videos, weather, video communication (ex. Skype™), etc. through an easy-to-use web interface that is built into the TV.

■ Link up and control the connected equipment with “Q-Link” and “VIERA Link” (p. 84 - 91)

Q-Link and VIERA Link provide easy recording and playback, creation of a home theatre without complicated settings, etc.

■ VIERA TOOLS - Display special feature icons for easy accessibility (p. 30)

Special features (such as VIERA Link, Media Player and DLNA operations) can be accessed easily by using the VIERA TOOLS button.

■ Owner ID (p. 56)

Owner ID is an anti-theft function. Entering the PIN number and owner's personal information will help the Police to determine the owner in the case of theft.

■ Supports Audio Description signal (p. 17 and p. 33)

Audio Description (when broadcast) adds an additional soundtrack to describe events on screen (narration) and aids understanding and enjoyment, particularly for visually-impaired viewers. You can switch Audio Description service Auto or Off, and adjust the volume of the description soundtrack independently of the main volume.

Digital Switchover for Terrestrial broadcasts

Starting in late 2007 and ending in 2012, TV services in the UK will go completely digital, TV region by TV region.

If you have any questions, please call Digital UK on **08456 50 50 50** or visit **www.digitaluk.co.uk**

Digital Switchover will cover a period of several weeks. When it starts you will lose all Analogue TV channels and some Digital TV channels will be missing.

You will need to retune your TV each time this happens to recover your digital channels. Analogue channels are permanently turned off, it will not be possible to recover them.

- To retune your TV ➔ “Auto Setup” in “DVB Tuning Menu”-DVB mode (p. 41)

Users of cable or satellite boxes should still retune the TV to continue to receive Freeview channels via their aerial. (Your Analogue channel for viewing Cable or Satellite services will change to a new position.)

Contents



FULL HD

This TV uses a high definition panel to produce high definition pictures close to their original resolution.



Wide Viewing Angle

This LCD panel offers 178-degree viewing angle. This delivers beautiful images regardless of the viewing angle.



IPS panel

This TV uses IPS (In Plane Switching) panel.



Eco Mode

Adjusts picture settings automatically dependent on ambient lighting conditions.



Provides suitable images for playing games

Selecting "Game" in Viewing Mode provides fast response to the input signal and you can enjoy playing games. (p. 32)



V-Audio Surround

Utilises Panasonic's advanced digital amplification technology. (p. 33)



24p Smooth Film

This item is displayed instead of "Intelligent Frame Creation" when 24p signal input, and produces smoother playback of 24p source movies.



digital tick

The digital tick logo indicates that a digital tuner is built-in.



Freeview HD

Freeview HD is the way to enjoy high definition digital TV for free.

Be Sure to Read

- Safety Precautions (Warning / Caution) 4

Quick Start Guide

- Accessories / Options 6
- Identifying Controls 8
- Basic Connection 10
- Auto Setup 12

Quick Start Guide

Enjoy your TV!

Basic Features

- Watching TV 16
- Using TV Guide 20
- Viewing Teletext 25
- Watching External inputs 28
- How to Use VIERA TOOLS 30
- How to Use Menu Functions 31

Basic

Advanced Features

- Retuning from Setup Menu 40
- Tuning and Editing Channels 42
- Shipping Condition 51
- Timer Programming 52
- Child Lock 54
- Input Labels 55
- Owner ID 56
- Using Common Interface 57
- Updating the TV Software 58
- Displaying PC Screen on TV 59
- Advanced Picture Settings 60
- USB HDD Recording 62
- Using Media Player 66
- Using Network Services 74 (DLNA / VIERA CAST / freesat)
- Link Functions 84 (Q-Link / VIERA Link)
- External Equipment 92

Advanced

FAQs, etc.

- Technical Information 94
- FAQs 99
- On screen messages 102
- Maintenance 104
- Glossary 104
- Licence 105
- Index 106
- Specifications 107

FAQs, etc.

Safety Precautions

Warning

■ Mains plug and lead

To help avoid risk of electrical shock, fire, damage or injury, please follow the warnings below:

- This TV is designed to operate on AC 220-240 V, 50 Hz.
- Insert the mains plug fully into the socket outlet.
- Ensure that the mains plug is easily accessible.
- Remove the mains plug when cleaning the TV.

- Do not touch the mains plug with a wet hand. 

- Do not damage the mains lead.

- Do not place a heavy object on the lead. 



- Do not place the lead near a high temperature object. 



- Do not pull on the lead. Hold onto the mains plug body when disconnecting the plug. 

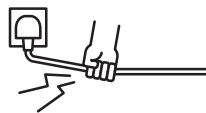

- Do not move the TV with the lead plugged into a socket outlet.
- Do not twist the lead, bend it excessively or stretch it.
- Do not use a damaged mains plug or socket outlet.
- Ensure the TV does not crush the mains lead.

If you detect anything unusual, immediately switch off the mains supply switch and remove the mains plug.



AC 220-240 V
50 Hz



IMPORTANT: THE MOULDED MAINS PLUG

FOR YOUR SAFETY, PLEASE READ THE FOLLOWING TEXT CAREFULLY.

This TV is supplied with a moulded three pin mains plug for your safety and convenience. A 5 amp fuse is fitted in this mains plug. Shall the fuse need to be replaced, please ensure that the replacement fuse has a rating of 5 amps and that it is approved by ASTA or BSI to BS1362.

Check for the ASTA mark  or the BSI mark  on the body of the fuse.

If the mains plug contains a removable fuse cover, you must ensure that it is refitted when the fuse is replaced. If you lose the fuse cover the mains plug must not be used until a replacement cover is obtained.

A replacement fuse cover may be purchased from your local dealer.

If the fitted moulded mains plug is unsuitable for the socket outlet in your home, then the fuse shall be removed and the mains plug cut off and disposed of safely. There is a danger of severe electrical shock if the cut off mains plug is inserted into any 13 amp socket.

If a new mains plug is to be fitted, please observe the wiring code as shown below.

If in any doubt, please consult a qualified electrician.

IMPORTANT: – The wires in this mains lead are coloured in accordance with the following code: –
Blue: Neutral Brown: Live

As the colours of the wire in the mains lead of this appliance may not correspond with the coloured markings identifying the terminals in your mains plug, proceed as follows.

The wire which is coloured BLUE must be connected to the terminal in the mains plug which is marked with the letter N or coloured BLACK.

The wire which is coloured BROWN must be connected to the terminal in the mains plug which is marked with the letter L or coloured RED.

Under no circumstances should either of these wires be connected to the Earth terminal of the three pin mains plug, marked with the letter E or the earth symbol .

How to replace the fuse

For plug type shown in example 1:

Lift out the removable fuse compartment with a screwdriver and replace the fuse, then refit securely into the mains plug (see example 1).

For plug type shown in example 2:

Lift open the fuse compartment, in the mains plug, with a screwdriver, and replace the fuse, then press the fuse cover down securely (see example 2).

Example 1

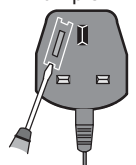



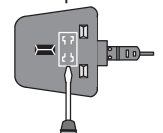

Example 2



Warning

Take care

To help avoid risk of electrical shock, fire, damage or injury, please follow the warnings below:

- Do not remove covers and never modify the TV yourself as live parts are accessible when they are removed. There are no user serviceable parts inside. 
- Do not expose the TV to rain or excessive moisture. This TV must not be exposed to dripping or splashing water and objects filled with liquid, such as vases, must not be placed on top of or above the TV. 
- Do not expose the TV to direct sunlight and other sources of heat. To prevent fire never place any type of candle or naked flame on top or near the TV. 
- Do not place the TV on sloped or unstable surfaces. 
- Do not insert foreign objects into the TV through the air vents.
- Do not use an unapproved pedestal / mounting equipment. Be sure to ask your local Panasonic dealer to perform the setup or installation of approved wall-hanging brackets.
- Do not apply strong force or impact to the display panel.

To prevent the spread of fire, keep candles or other open flames away from this product at all times



Small object

This product contains possibly dangerous parts that can be breathed in or swallowed by young children accidentally.

- Keep the dangerous parts out of reach of young children.
- Do not allow children to handle SD Card. As with any small object, the SD Card could be swallowed by young children. Please remove SD Card immediately after use and store out of reach of young children.



Caution

Ventilation

Allow sufficient space around the TV in order to help prevent excessive heat, which could lead to early failure of some electronic components.

- Ventilation should not be impeded by covering the ventilation openings with items such as newspapers, tablecloths and curtains. 
- Whether you are using the pedestal or not, always ensure the vents in the bottom of the TV are not blocked and there is sufficient space to enable adequate ventilation.

Minimum distance

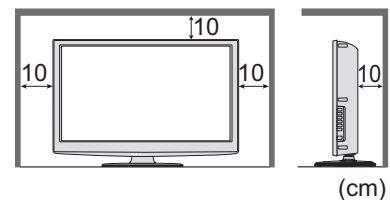

Moving the TV

Before moving the TV, disconnect all cables.

- Transport only in upright position.

When not in use for a long time

This TV will still consume some power even in the Off mode, as long as the mains plug is still connected to a live socket outlet.

- Remove the mains plug from the wall socket when the TV is not in use for a prolonged period of time.

Excessive volume

Do not expose your ears to excessive volume from the headphones. Irreversible damage can be caused.



Accessories / Options

Standard accessories

Check that you have the accessories and items shown

- Remote Control
 - N2QAYB000490



- Batteries for the Remote Control (2)
 - R6 (UM3)
 - ➔ p. 8



- Clamper
 - TMM8E18048
 - ➔ p. 10

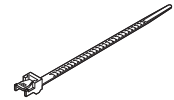

- Operating Instructions
- Product Registration Leaflet

- Pedestal
 - TBL0E0110 TX-L32G20B
 - TBL0E0125 TX-L32G20B
 - TBL0E0111 TX-L37G20B
 - TBL0E0123 TX-L37G20B
 - ➔ p. 7

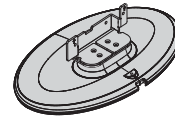

- Assembly screw for Pedestal (4)
 - XYN4+F12FJK

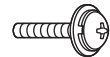

Optional accessories

Please contact your nearest Panasonic dealer to purchase the recommended optional accessories. For additional details, please refer to the manual of the optional accessories.

- Wireless LAN Adaptor
 - DY-WL10E-K

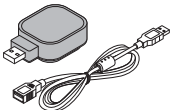

Caution

- To use the Wireless LAN Adaptor, an access point needs to be obtained.
- It is recommended to use the Wireless LAN Adaptor with the extension cable.
- To avoid malfunctions caused by radio wave interface, keep the TV away from the devices such as other wireless LAN devices, microwaves and the devices that use 2.4 GHz and 5 GHz signals when using the Wireless LAN Adaptor.
- Depending on the area, this optional accessory may not be available.
- Additional information for Wireless LAN Adaptor and access point may be on the following web site. (English only)
<http://panasonic.jp/support/global/cs/tv/>

- Communication Camera
 - TY-CC10W

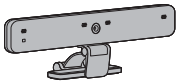

Caution

- This camera can be used on VIERA CAST (p. 83).
- Please also read the manual of the camera.
- Depending on the area, this optional accessory may not be available. For details, consult your local Panasonic dealer.

- Wall-hanging bracket
 - TY-WK3L2RW

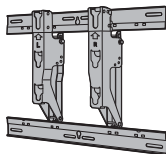

Rear of the TV

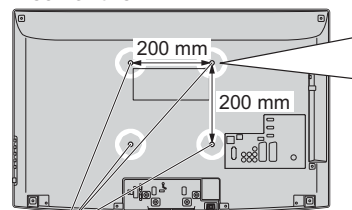

Holes for wall-hanging bracket installation

Screw for fixing the TV onto the wall-hanging bracket
(not supplied with the TV)

Depth of screw:
minimum 9 mm, maximum 12 mm

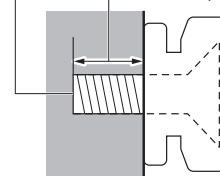

Diameter: M6

(View from the side)

Warning

- Using other wall-hanging brackets, or installing a wall-hanging bracket by yourself has the risk of personal injury and product damage. In order to maintain the unit's performance and safety, be sure to ask your dealer or a licenced contractor to secure the wall-hanging brackets. Any damage caused by installing without a qualified installer will void your warranty.
- Carefully read the instructions accompanying optional accessories, and be sure to take steps to prevent the TV from falling off.
- Handle the TV carefully during installation since subjecting it to impact or other forces may cause product damage which will void your warranty.
- Do not mount the unit directly below ceiling lights (such as spotlights or halogen lights) which typically give off high heat. Doing so may warp or damage plastic cabinet parts.
- Take care when fixing wall brackets to the wall. Wall mounted equipment must not be grounded by metal within the wall. Always ensure that there are no electrical cables or pipes in the wall before hanging bracket.
- To prevent fall and injury, remove the TV from its fixed wall position when it is no longer in use for an extended period of time.

Attaching the pedestal

To help avoid risk of damage or injury by the TV tipping or falling, please follow the warnings and cautions below:

Warning

- Do not disassemble or modify the pedestal.

Caution

- Do not use with any other TVs or displays.
- Do not use the pedestal if it becomes warped or physically damaged. If this occurs, contact your nearest Panasonic dealer immediately.
- During setup, make sure that all screws are securely tightened.
- Ensure that the TV does not suffer any impact during installation of the pedestal.
- Ensure that children do not climb onto the pedestal.
- Install or remove the TV from the pedestal with at least two people.

- (A) Assembly screw (4)
● XSS4+16FNK



- (B) Assembly screw (4)
● XYN4+F12FJK



- (C) Bracket (1)
● TUX0EA004 (TX-L32G20B)
● TUX0E198 (TX-L37G20B)



- (D) Base (1)
● TBL0E0110 (TX-L32G20B)
● TBL0E0111 (TX-L37G20B)



Assembling the pedestal

Use the four assembly screws (A) to fasten the bracket (C) to the base securely.

- Forcing the assembly screws the wrong way will strip the threads.
- Make sure that the screws are securely tightened.

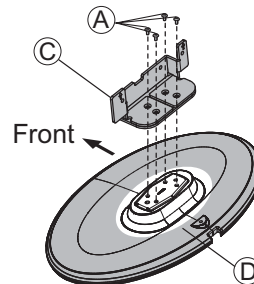

Securing the TV

Use only the supplied assembly screws (B) to fasten the pedestal securely to the TV.

- Make sure that the screws are securely tightened.
- Carry out the work on a horizontal and level surface.

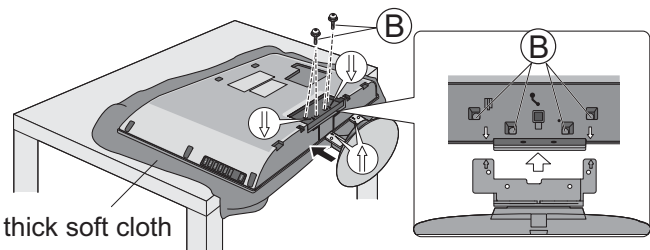

Foam mat or thick soft cloth

Adjust the panel to your desired angle

- Ensure that the pedestal does not hang over the edge of the base even if the TV swivels to the full rotation range.
- Do not place any objects or hands within the full rotation range.

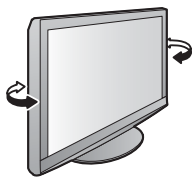

- TX-L32G20B
a: 358 mm / b: 230 mm
- TX-L37G20B
a: 399 mm / b: 296 mm

Set the mark at the centre as illustrated, to ensure full degree rotation in either direction.

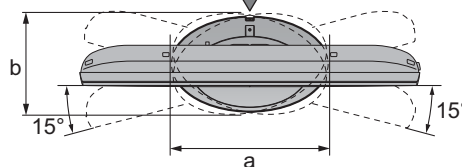

(View from the top)

Note

- Visible part of the pedestal will remain parallel to the TV even when rotated.

Identifying Controls

Remote Control

■ Installing / removing remote's batteries

1

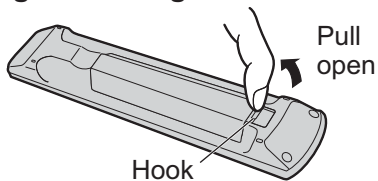

2

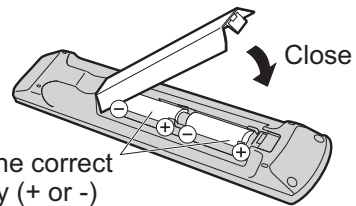

Caution

- Incorrect installation may cause battery leakage and corrosion, resulting in damage to the remote control.
- Do not mix old and new batteries.
- Replace only with same or equivalent type. Do not mix different battery types (such as alkaline and manganese batteries).
- Do not use rechargeable (Ni-Cd) batteries.
- Do not burn or break up batteries.
Batteries must not be exposed to excessive heat such as sunshine, fire, etc.
- Make sure you dispose of batteries correctly.
- Ensure batteries are replaced correctly, there is danger of explosion and fire if battery is reversed.
- Do not disassemble or modify the remote control.

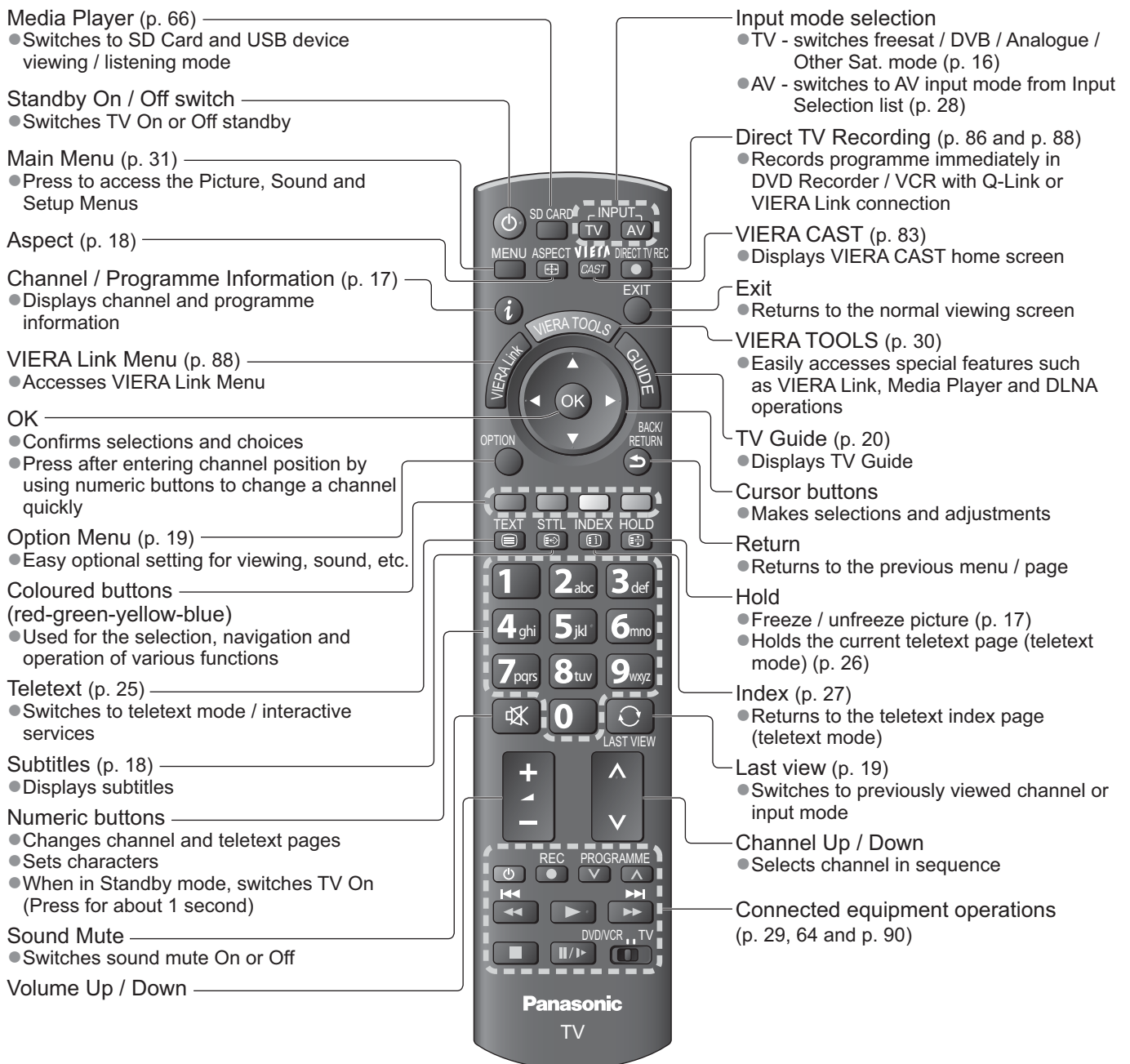

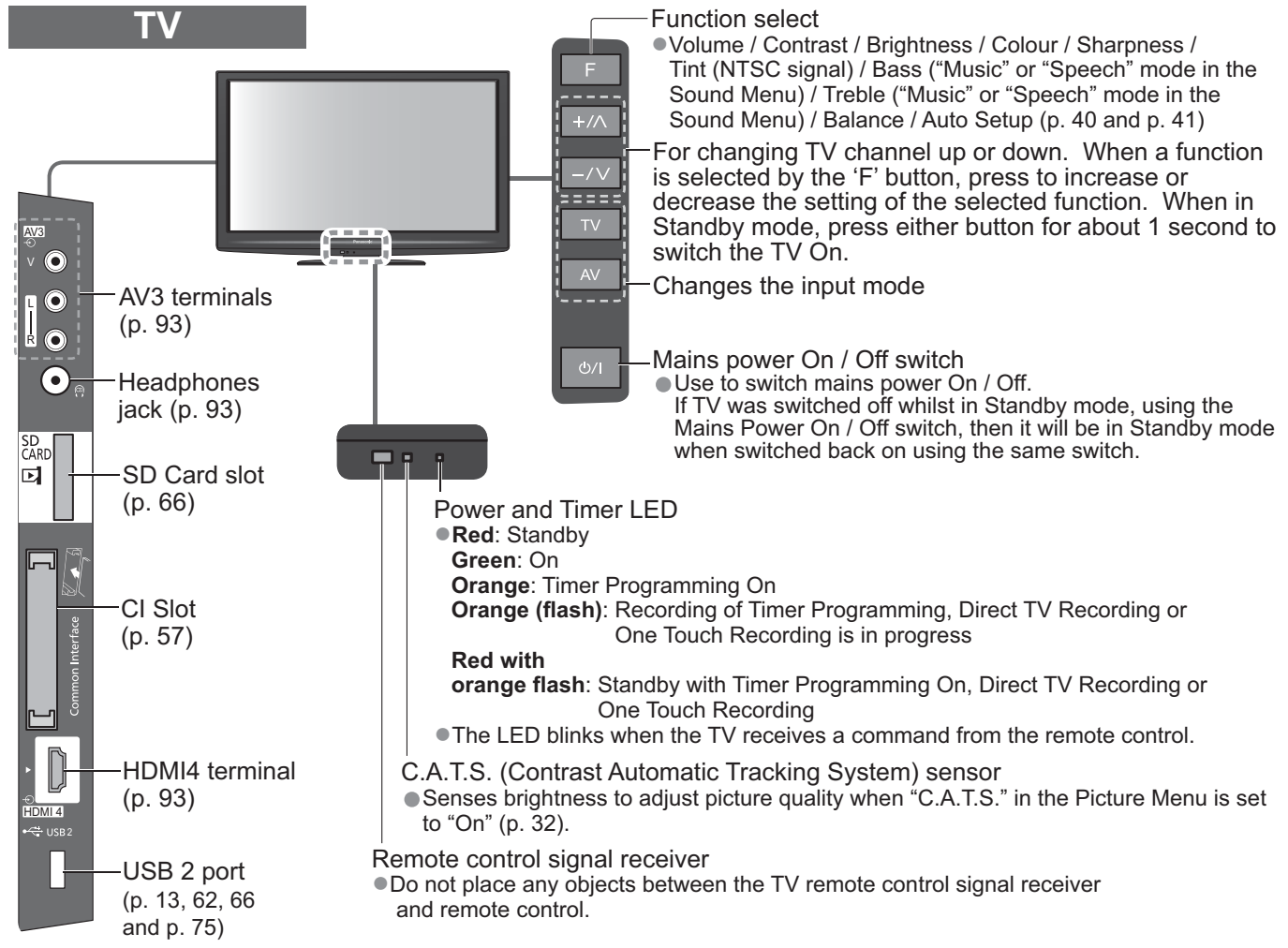

Auto power standby function

- The TV will automatically go to Standby mode in the following conditions:
 - no signal is received and no operation is performed for 30 minutes in Analogue TV mode
 - "Off Timer" is active in the Setup Menu (p. 19)
 - no operation is performed for the period selected in "Auto Standby" (p. 36)
- This function does not affect the recording of Timer Programming, Direct TV Recording and One Touch Recording.

Using the On Screen Displays

Many features available on this TV can be accessed via the On Screen Display menu.

How to use remote control

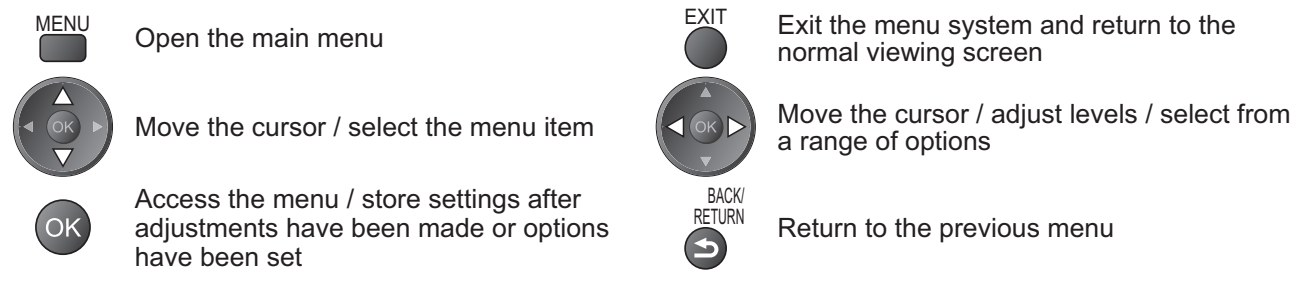

ON SCREEN HELP Instructions box - Operation guide

Example (Owner ID):

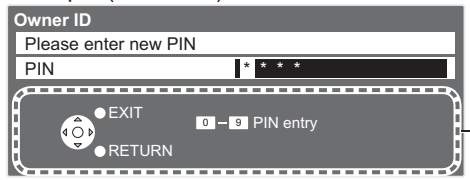

Operation guide will help you.

Basic Connection

External equipment and cables shown are not supplied with this TV. Please ensure that the unit is disconnected from the mains socket before attaching or disconnecting any leads.

Example 1 Connecting dish or aerial

TV only

- The freesat channel uses Astra 2 at 28.2° East, and Eurobird 1 at 28.5° East satellites. To ensure your satellite dish is correctly installed please consult your freesat registered dealer.

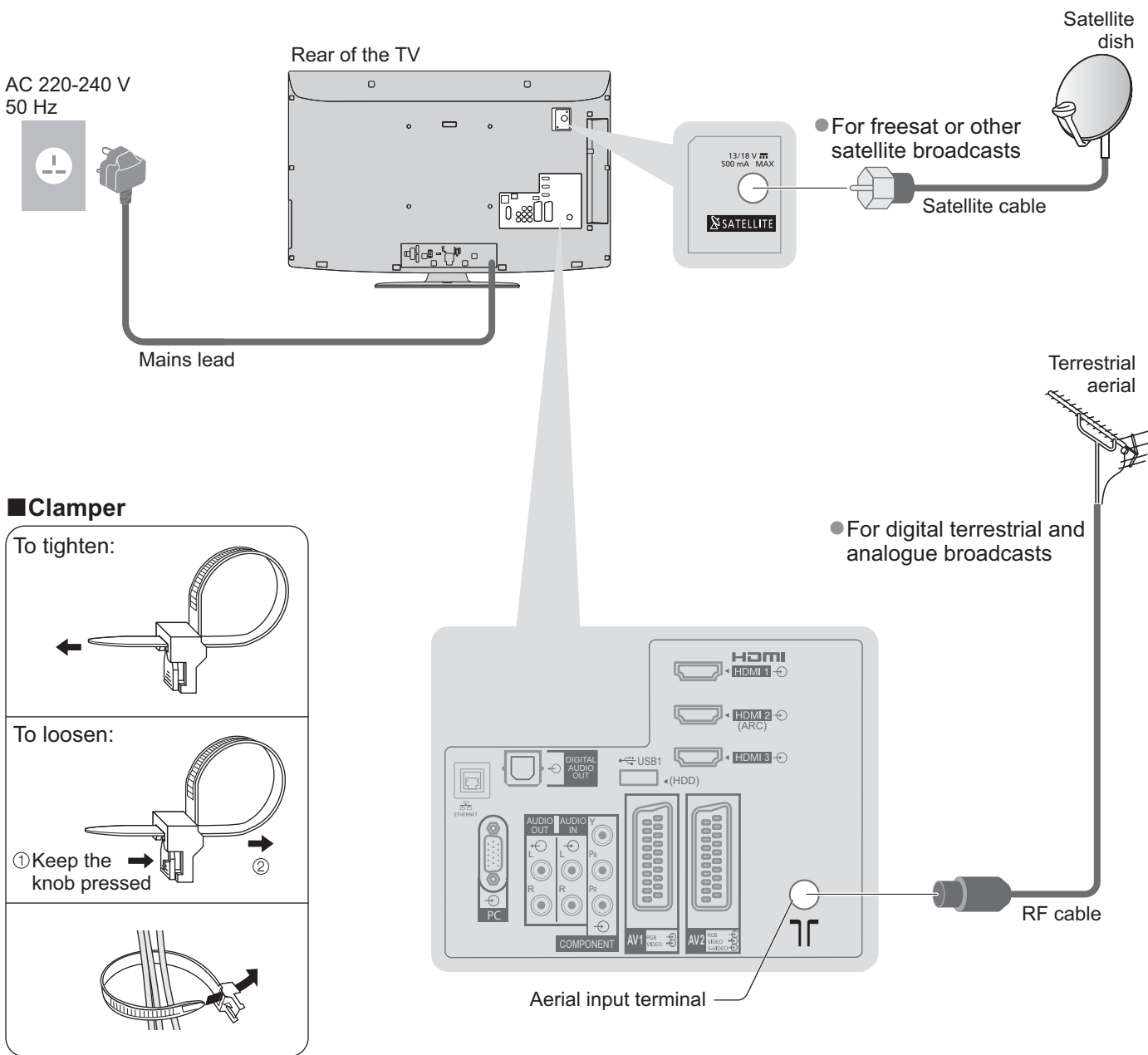

- Do not bundle the Satellite cable, RF cable and mains lead together (could cause distorted image).
- Fix cables with clammers as necessary.
- When using the optional accessory, follow the option's assembly manual to fix cables.

Example 2 Connecting DVD Recorder / VCR

TV, DVD Recorder or VCR

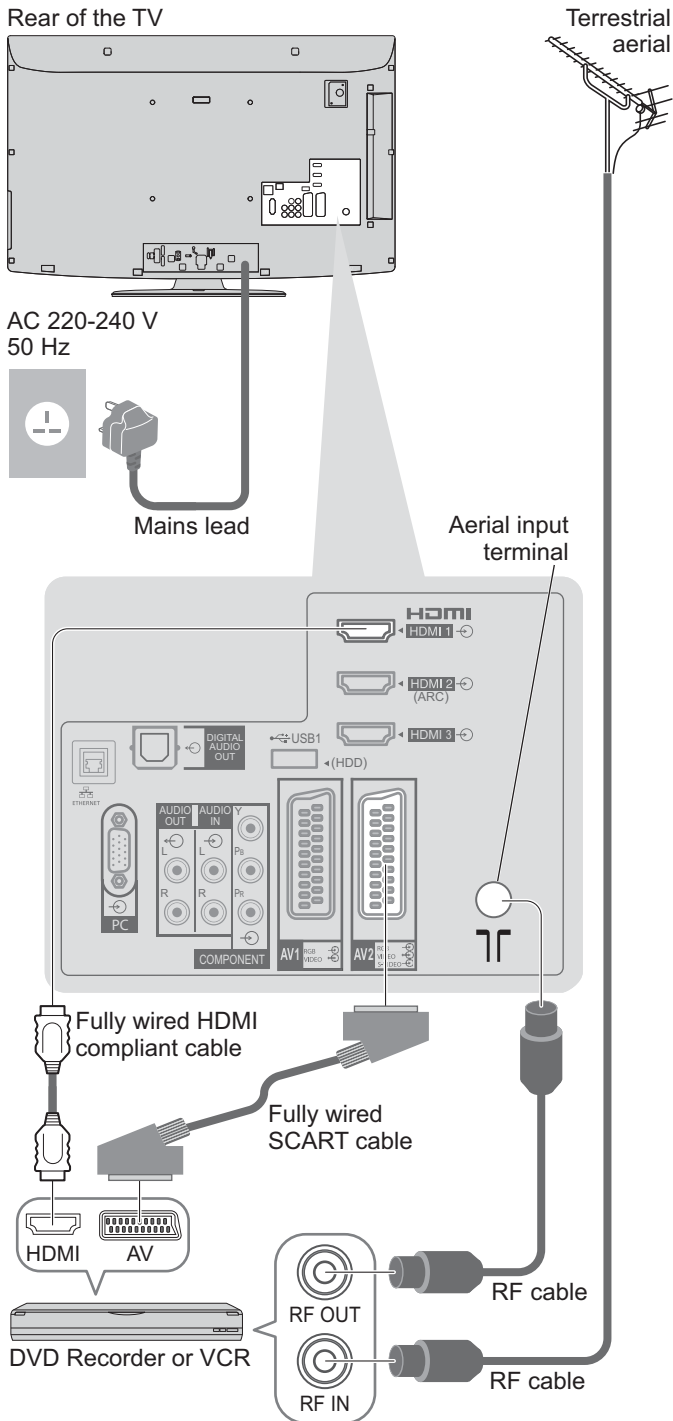

Example 3 Connecting DVD Recorder / VCR and Cable TV box

TV, DVD Recorder / VCR and Cable

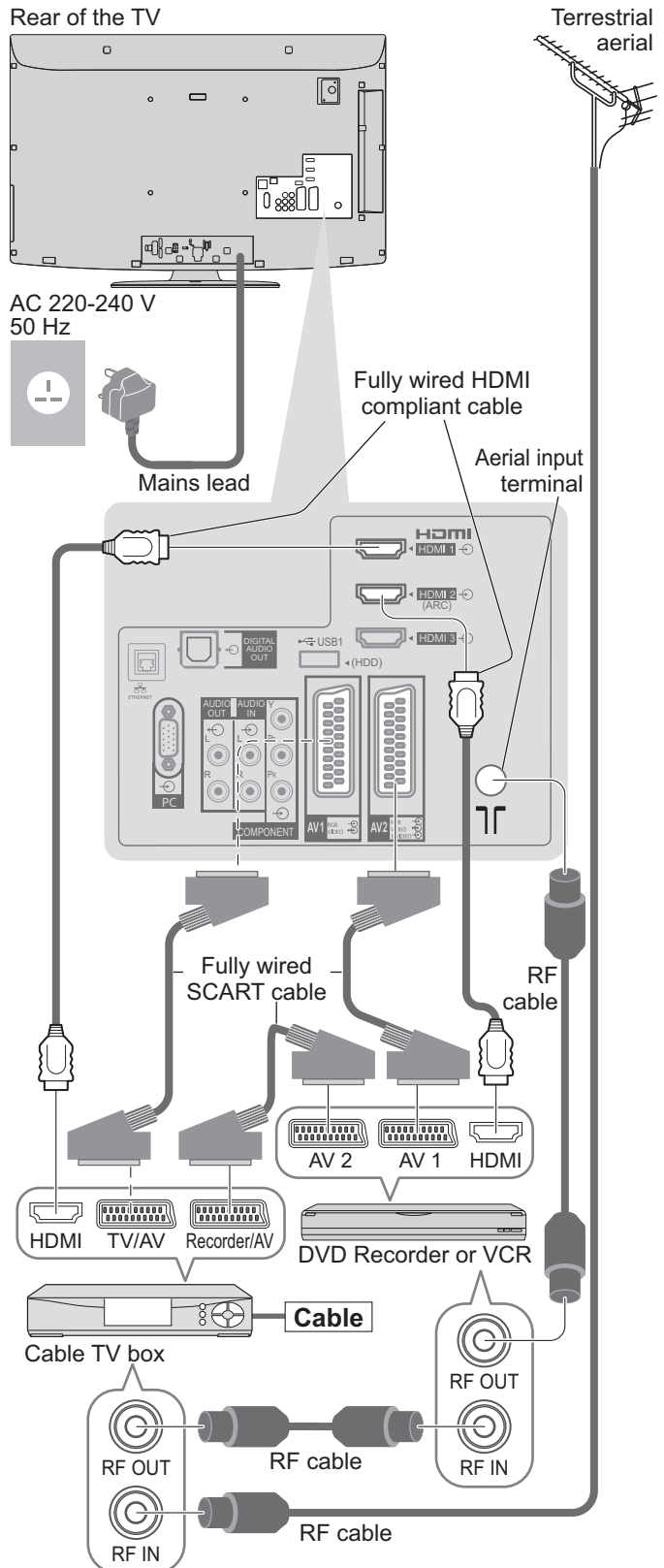

Note

- Connect to the TV's AV2 for a DVD Recorder / VCR supporting Q-Link (p. 86).
- Connect to the TV's AV1 for a Cable TV box.
- For HDMI-compatible equipment, it is possible to connect to HDMI terminals (HDMI1 / HDMI2 / HDMI3 / HDMI4) by using HDMI cable (p. 92 and p. 93).
- Network connection ➔ p. 13 and p. 75
- Q-Link connection ➔ p. 84
- VIERA Link connection ➔ p. 84 and p. 85
- Please also read the manual of the equipment being connected.

Auto Setup

Search and store TV channels automatically.

- These steps are not necessary if the setup has been completed by your local dealer.
- Please complete connections (p. 10 and p. 11) and settings (if necessary) of the connected equipment before starting Auto Setup. For details of settings for the connected equipment, read the appropriate manual.



1

Plug the TV into mains socket and switch On (Takes a few seconds to be displayed)



- If the red LED shows on the TV, press the Standby On / Off switch on the remote control for at least 1 second to turn the TV On.

Auto Setup will start to search for TV channels and store them in the numbered order as specified by the broadcasters.

- If "freesat Auto Setup" cannot be done completely
→ "FAQs" (p. 99)

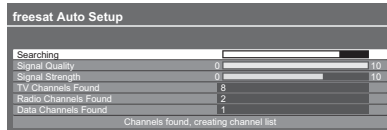

(freesat tuning)

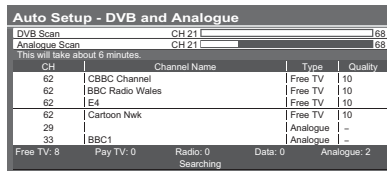

- Actual number of channels may differ due to channel duplication.

(DVB and Analogue tuning)

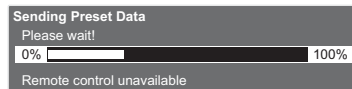

If Q-Link, or similar technology (p. 86), compatible recorder with analogue tuner is connected, analogue channel setting is automatically downloaded to the recorder. (Digital channel setting is not downloaded.)

- If downloading has failed, you can download later through the Setup Menu.
→ "Q-Link Download" (p. 34)

2

Enter your postcode

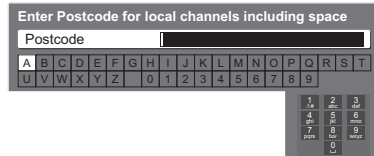

- Your postcode is required to receive local services and sort the channel order. Please ensure to include a space when entering your postcode.

- If you skip this step, the default postcode (central London) will be set.

How to enter the postcode

Set characters one by one

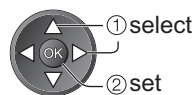

- You can set characters by using numeric buttons.
→ "Characters table for numeric buttons" (p. 96)

Exit to go to next step



(continued to the next page)

3

Setup the wireless LAN connection

Setup the wireless LAN connection to enable the network service functions (p. 74).
 (If you do not wish to use wireless LAN connection or the network service functions, skip this step.)

- To setup the wireless LAN connection, the Wireless LAN Adaptor (optional accessory) is required. For the information about the Wireless LAN Adaptor → “Optional accessories” (p. 6)
- Confirm the encryption key, settings and positions of your access point before starting setup. For details, read the manual of the access point.
- Please note that this TV does not support wireless public access points.
- To use a LAN cable instead of the Wireless LAN Adaptor → p. 77

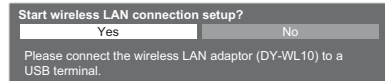

① connect the Wireless LAN Adaptor to the USB 1 (rear) or 2 port (side)

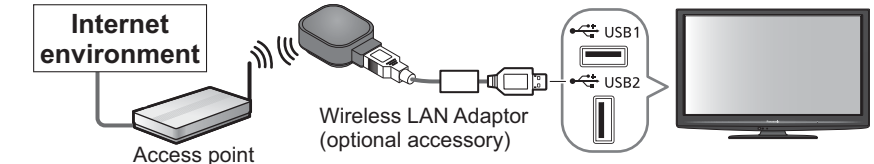

You can setup the wireless LAN connection later → “Network Setup” (p. 78)



- To skip this step → EXIT or select “No”

Wireless LAN connection setup starts

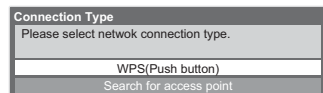

Select the connection type

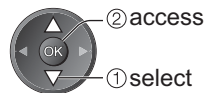

- If your access point supports WPS (Push button), then select this option. If not, select “Search for access point”.

WPS(Push button)

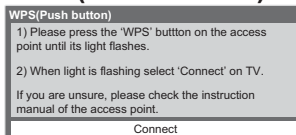

Press the WPS button on the access point until the light flashes. And then, press the OK button to connect the Wireless LAN Adaptor and the access point.

- Ensure that your access point supports WPS for this setup.
- WPS: Wi-Fi Protected Setup

Search for access point

Access points found automatically are listed.

No.	SSID	Encryption type	Encrypted	Access point
1	Access Point A	TKIP	☑	
2	Access Point B	TKIP	☐	
3	Access Point C	TKIP	☐	

Select your desired access point

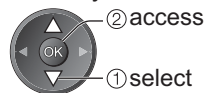

- To search access points again → yellow
- For the information of the highlighted access point → i
- To set manually (p. 79) → red

☑ : Encrypted access point

Access the encryption key input mode



- If the selected access point is not encrypted, the confirmation screen will be displayed. It is recommended to select the encrypted access point.

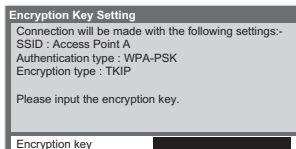

Enter the encryption key of the access point

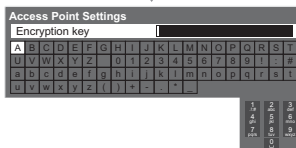

Set characters one by one

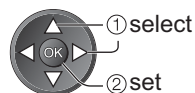

Store



- You can set characters by using numeric buttons. → “Characters table for numeric buttons” (p. 96)

Select “Yes”

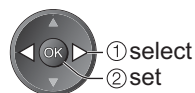

- To re-enter the encryption key, select “No”.

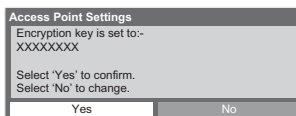

- If the connection has failed, check the encryption key, settings and positions of your access point. And then, follow the on screen instructions.
- If connection to the access point is successful, we recommend you perform the “Connection Test” to confirm connection to the internet has been made. The “Connection Test” can be found in the Network Setup menu (p. 78).

Exit to go to the next step OK

(continued to the next page)

Auto Setup

4 Input Owner ID



Please enter your own choice of PIN number, name, etc. to help the police to crack crime.

- Make a note of the PIN number in case you forget it. The PIN number cannot be reset.
- You can input or change the Owner ID later. ➔ “Owner ID” (p. 56)
- To skip this step ➔ 
- This step will be skipped in the Auto Setup after “Shipping Condition” (p. 51) is performed.

■ How to input Owner ID

① Enter the PIN number (4 digits)



- Enter the PIN number twice at first setting.

② Enter your name, house number, and postcode, in that order

Select the item (NAME / HOUSE NO / POSTCODE)

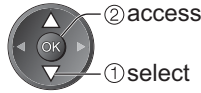
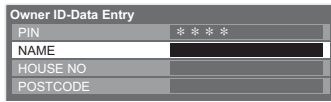

Set characters one by one

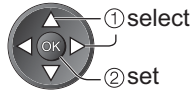

- You can set characters by using numeric buttons. ➔ “Characters table for numeric buttons” (p. 96)

Return to select other items



- Select the next item and repeat the operations.

③ Exit to go to next step



(continued to the next page)

5

Select "Home"

Select "Home" viewing environment (highlight "Home" in yellow) to use in your home environment.

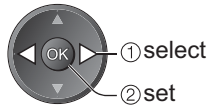
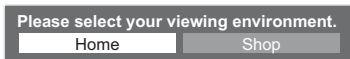

Auto Setup is now complete and your TV is ready for viewing.



- To check channel list at-a-glance → "Using TV Guide" (p. 20)
- To edit or hide (skip) channels → "Tuning and Editing Channels" (p. 42 - 50)
- If tuning has failed, check the connection of the Satellite cable, RF cable, and then, follow the on screen instructions.

■ "Shop" viewing environment (for shop display only)

"Shop" viewing environment is the demonstration mode to explain main features of this TV.

Select "Home" viewing environment to use in your home environment.

- You can return to viewing environment selection screen at the stage of Shop confirmation screen and Automatic Demo Off / On selection screen.

① Return to viewing environment selection screen

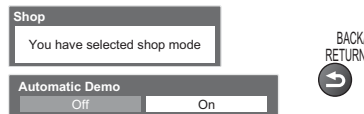

② Select "Home"



Auto Setup is complete

- To change viewing environment later on, you will need to initialise all settings by accessing Shipping Condition. → "Shipping Condition" (p. 51)

Note

- If tuning has failed or to retune all channels → "Auto Setup" (p. 40 and p. 41)
- If you wish to tune in other satellite channels → "Auto Setup" in "Other Sat. Tuning Menu" (p. 49)
- To re-initialise all settings → "Shipping Condition" (p. 51)
- If you turned the TV Off during Standby mode last time, the TV will be in Standby mode when you turn the TV On with Mains power On / Off switch.

If you connect the Wireless LAN Adaptor later on, the confirmation screen will be displayed for the setup.

- To setup the Wireless LAN connection → p. 78 and p. 79

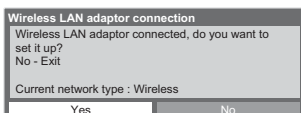

Watching TV



1 Turn power on
(Press for about 1 second)

- Mains power On / Off switch should be On. (p. 9)

2 Select the mode (freesat, DVB, Analogue or Other Sat.)

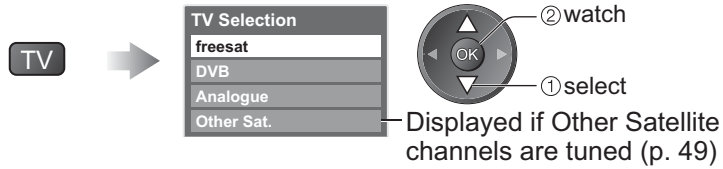

● Also possible by pressing the TV button repeatedly on the remote control or side panel of the TV. (p. 9)

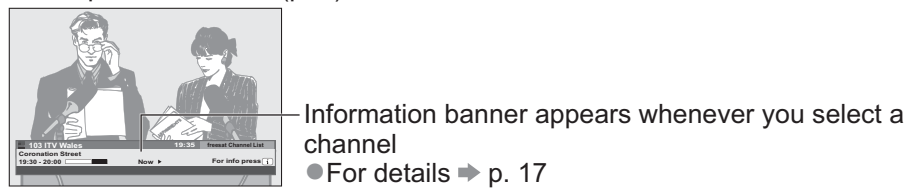

3 Select a channel

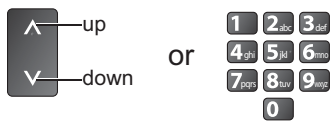

freesat channel position numbers run in the ranges 100 - 999 and 0100 - 0999.

● To select a three-digit channel position number, e.g. 133



● To select a four-digit channel position number, e.g. 0246



DVB and Other Sat. channel position numbers run from 1 onwards.

Analogue channel position numbers run in the ranges 0 - 99.

● To select a two or three-digit channel position number, e.g. 39



Volume

Note

- To watch pay-TV
→ "Using Common Interface" (p. 57)

Select a channel using Information banner (p. 17)
It is possible to confirm the channel name and programme information by using the Information banner before changing channels.

Display Information banner if it is not displayed

While the banner is displayed, select the channel

- Possible to set display timeout in "Banner Display Timeout" (p. 35).

Select a channel using TV Guide (p. 20)
It is possible to confirm the channel and programme information by using the TV Guide (EPG) before changing channels.

Display TV Guide

Select a current programme or channel

Select "View" (DVB mode)

- To use Timer Programming -> p. 22

Other useful functions

Hold

Freeze / unfreeze picture



Display Information banner

Display Information banner

Also appears when changing a channel

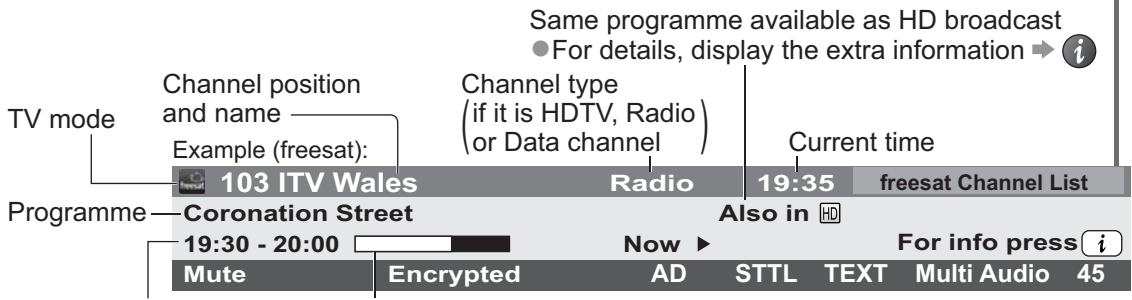

“All DVB Channels” or “Favourites1-4” (p. 45)
To switch → blue

Example (DVB):

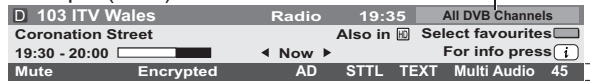

Example (Analogue):



Channel number

“All Other Sat. Channels” or “Favourites1-4” (p. 50)
To switch → blue

Example (Other Sat.):



Mute

Sound mute On

Bad signal

Poor TV signal quality

Encrypted

Scrambled programme

AD

Audio Description service available

This function can aid visually-impaired viewers by adding an additional audio track to describe events on-screen.

For settings → p. 33

STTL

Subtitle service available

TEXT

Teletext service available

Multi Audio

Multiple audio available

Stereo, Mono, NICAM

Audio mode

1 - 90

Off Timer remaining time

For settings → p. 19

To confirm another tuned channel name →



Information on the next programme (freesat, DVB, Other sat.) →



Extra information → (press again to hide the banner) (freesat, DVB, Other sat.)

“AD”, “STTL”, “TEXT”, “Multi Audio” indications are displayed as available on particular programmes, but may not be available for all individual programmes being broadcast. Display the extra information to confirm availability of these functions.

To watch the channel listed in the banner → OK

To hide → EXIT

To set display timeout → “Banner Display Timeout” (p. 35)

Example:

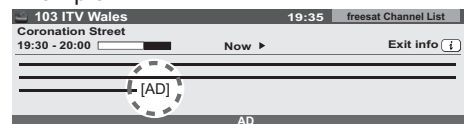

Watching TV

Other useful functions

Display subtitles

FreeSat, DVB or Other Sat. mode

Display / hide subtitles (if available)

- To change the language for DVB (if available)
 - "Preferred Subtitles" (p. 35)



Analogue mode

Display subtitles

- To hide subtitles →



Note

- This is the same as switching to Analogue teletext service and selecting "P888" (subtitle service). (p. 27)
- You cannot change the channel when this function is active.

Aspect

Change the aspect ratio (image size)



Enjoy viewing the image at its optimum size and aspect.

Programmes usually contain an Aspect Control Signal (Widescreen signal, etc.), and the TV will choose the aspect ratio automatically according to the Aspect Control Signal (p. 94).

If you would like to change the aspect ratio manually

Display Aspect Selection list

While the list is displayed, select the mode



- To change the mode using the ASPECT button only
 - (Press repeatedly until you reach the desired mode)

Auto



The best ratio is chosen and the image expanded to fill the screen.
For details → p. 94

16:9



Directly displays the image at 16:9 without distortion (anamorphic).

Zoom1

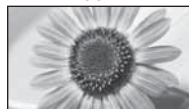

Displays a 16:9 letterbox or 4:3 image without distortion.

14:9

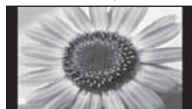

Displays the image at the standard 14:9 without distortion.

Zoom2

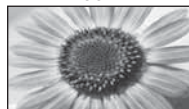

Displays a 16:9 letterbox (anamorphic) image full-screen without distortion.

4:3



Displays the image at the standard 4:3 without distortion.

Zoom3

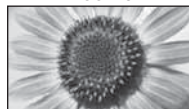

Displays a 2.35:1 letterbox (anamorphic) image full-screen without distortion. At 16:9, displays the image at its maximum (with slight enlargement).

Note

- Aspect is fixed to "16:9" when "Viewing Mode" is set to "Game" in the Picture Menu.
- Only "16:9" and "4:3" are available in PC input mode.
- Not available when the subtitle function is active.
- Not available in teletext service.
- Aspect mode can be memorized separately for SD (Standard definition) and HD (High definition) signals.

■ Other useful functions

Display the selectable settings for the current status

Check or change the current status instantly



● To change

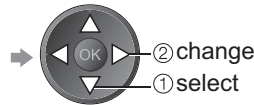

Multi Audio / AD (freesat mode)

Allows you to select between alternative language or Audio Description for sound tracks (if available)

- Set Audio Description "Auto" in the Sound Menu (p. 33) to select the audio description sound track. In freesat mode, Audio Description cannot be controlled separately from the audio description sound track.
- This setting is not memorized and it will return to the default setting once you exit the current programme.

Multi Audio (DVB or Other Sat. mode)

Allows you to select between alternative language for sound tracks (if available)

- This setting is not memorized and it will return to the default setting once you exit the current programme.

Monaural Audio (DVB mode)

Allows you to select stereo / monaural (if available)

- This setting is not memorized and it will return to the default setting once you exit the current programme.

Subtitle Language

(freesat, DVB or Other Sat. mode)

Allows you to select the language in which subtitles should appear (if available)

- This setting is not memorized and it will return to the default setting once you exit the current programme.

NICAM (Analogue mode)

Switches NICAM sound (if available)

➔ Sound Menu (p. 33)

Volume Correction

Adjusts volume of individual channel or input mode

Audio Description (DVB mode)

Set to "Auto" if the programme has Audio Description service, then you will hear an additional audio track to describe events on screen

- To adjust the volume for Audio Description ➔ "Audio Description Menu" (p. 33)

Safely remove USB

- Takes this operation to remove the connected USB device safely from the TV.

Note

- Also possible to change the settings in Menu list (p. 32 - 36).

Last view

Switch to previously viewed channel or input mode easily



- Press again to return to the present view.

Note

- Switching channel is not available while the recording of Timer Programming, Direct TV Recording or One Touch Recording is in progress.
- Watching less than 10 sec. is not regarded as the previously viewed channel or input mode.

Off Timer

Turn the TV off automatically after a fixed period (Off / 15 / 30 / 45 / 60 / 75 / 90 minutes)

Display the menu



Select "Setup"

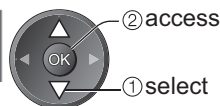
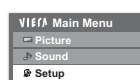

Select "Off Timer" and set the time

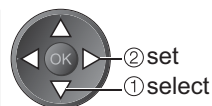
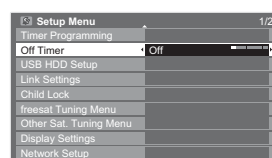

- To cancel ➔ Set to "Off" or turn the TV off.
- To display the remaining time ➔ Information banner (p. 17)

Note

- When the remaining time is within 3 minutes, the remaining time will flash on the screen.

Using TV Guide

TV Guide—Electronic Programme Guide (EPG) provides an on screen listing of the programmes currently broadcast and the forthcoming broadcasts over the next seven days (depending on the broadcasters).

- When this TV is turned on for the first time, or the TV is switched off for more than a week, it may take some time before the TV Guide is completely shown.

freesat mode



- 1 Select freesat** → p. 16
- 2 Display the Channel Genre selection list**
- 3 Select the genre and view TV Guide**

Example:

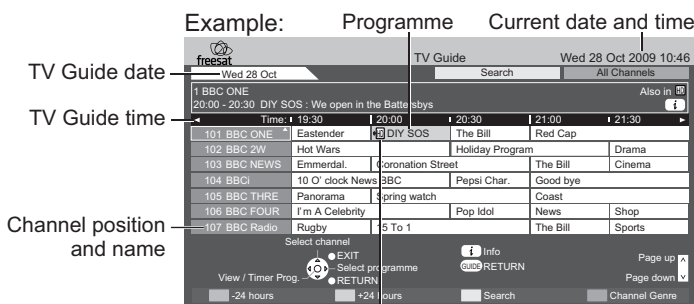
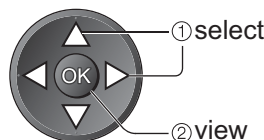
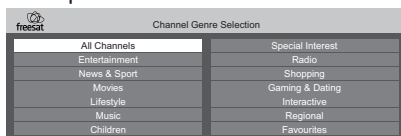

- There might be some programmes displayed as greyed-out in TV Guide. These are the Off-Air programmes (non-running programmes).

To return to TV

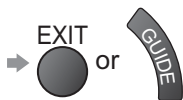

To watch the programme

Select a current programme or channel



Select "View"

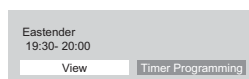

- If a programme exists in both HD and SD broadcasts, the "View Options" screen will be displayed to select HD or SD broadcast.

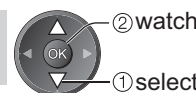

- To use Timer Programming → p. 22

To view a channel list of the selected genre



(Channel Genre list)

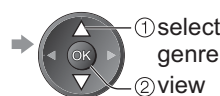

To the previous day



To search programme types and view a channel list of the searched programmes



(Search list)

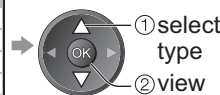

To the next day



To search programme titles and view a list of the searched programmes



(Search list)



Set characters one by one (maximum: 19 characters)

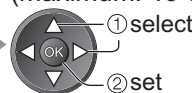

You can set characters by using numeric buttons. → "Characters table for numeric buttons" (p. 96)

- All the programme titles including the word you set will be listed.
- Searching without any characters will list all programmes including current programmes.

DVB or Analogue mode

- This TV supports the GUIDE Plus+ system.
- The Gemstar branding partner will supply the rating informations in the programme information and the recommended group in the Search list.
- DVB and Analogue channels are displayed on the same TV Guide screen. "D" means DVB channel and "A" means Analogue channel. There will be no programme listings for Analogue channels.



1 Select DVB or Analogue

→ p. 16



2 View TV Guide



Example:

Current date and time	TV Guide date	Programme	Logo of the Gemstar branding partner
Wed 28 Oct 2009 10:46	Wed 28 Oct	1 BBC ONE 20:00 - 20:30 DIY SOS - We open in the Ball...	RadioTimes
TV Guide time	Time: 19:30	20:00	20:30
Advertisement	D 1 BBC ONE D 7 BBC THREE D 14 E4 D 70 BBC FOUR D 72 BBC 2W D 105 BBC1 D 719 BBC Radi	Eastender Hot Wars Emmerdal. 10 O' clock News BBC Panorama I'm A Celebrity Rugby	DIY SOS Holiday News Holiday Program Coronation Street The Bill Pepsi Char. Good bye Coast News Sports
D: DVB A: Analogue	Select channel	Select programme	Select Advert
Channel position and name	Timer Programming	Search	Category

Some programmes may also be broadcast in HD
 • You can select HD or SD broadcast before viewing or setting Timer Programming.

To return to TV

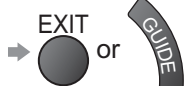

To watch the programme

Select a current programme or channel

Select "View" (DVB mode)

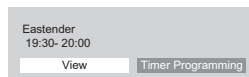

• If a programme exists in both HD and SD broadcasts, the "View Options" screen will be displayed to select HD or SD broadcast. (DVB mode)

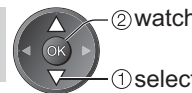

• To use Timer Programming → p. 22

To view a channel list of the selected category



Category list

- All Channels
- All DVB Channels
- All Analogue Channels
- Free DVB Channels
- TV/Data DVB Channels
- Favourites1
- Favourites2
- Favourites3
- Favourites4

Only Analogue channels are listed

• To list favourite channels → p. 45

To the previous day (DVB mode)



To search programme types and view a channel list of the searched programmes (DVB mode)



Search list

- Search Titles...
- Movie
- News and Factual
- Entertainment
- Sport
- Children's

To the next day (DVB mode)



To search programme titles and view a list of the searched programmes (DVB mode)



Search list

- Search Titles...
- Movie
- News and Factual
- Entertainment
- Sport
- Children's

Set characters one by one (maximum: 19 characters)

You can set characters by using numeric buttons.
 → "Characters table for numeric buttons" (p. 96)

- All the programme titles including the word you set will be listed.
- Searching without any characters will list all programmes including current programmes.

Using TV Guide

Other useful functions

Timer Programming (freesat or DVB mode)

Timer Programming can remind you to watch a programme or record one on an external recorder or an USB HDD.

Select the forthcoming programme

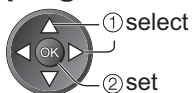

Select the function (Ext Rec., USB HDD Rec. or Reminder)

Timer Programming					
Function	No.	Channel Name	Date	Start	End
Ext Rec.	1	BBC ONE DIY SOS	Wed 28 Oct	20:00	20:30 (30 min.)
---	---	---	---	---	---
---	---	---	---	---	---
---	---	---	---	---	---
---	---	---	---	---	---

(Timer Programming screen)

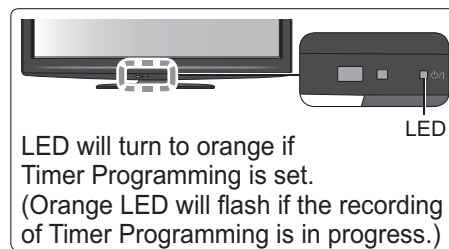
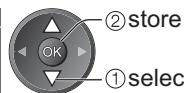

Ext Rec. / USB HDD Rec. : to record the programme to the external recorder (Ext Rec.) or the USB HDD (USB HDD Rec.)



When the start time comes, the channel will be switched automatically and the video and audio signals will be output. 2 mins. before the starting time, a reminder message appears if you are watching TV.

Reminder : to remind you to watch the programme



When you are watching TV, a reminder message appears 2 mins. before the start time. Press the OK button to switch to the programmed channel.

■ To check / change / cancel a timer programming event → “Timer Programming” (p. 53)

■ To return to TV Guide →



■ If you select a current programme

A confirmation screen asking whether you wish to watch or record the programme will appear. Select “Timer Programming” and set “Ext Rec.” or “USB HDD Rec.” to record from the time you finish programming the timer event setting.

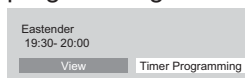

■ If a programme exists in both HD and SD broadcasts

The “Timer Options” screen will be displayed to select HD or SD broadcast.

Timer Options			
DIY SOS			
101	BBC ONE	19:30-20:00	Wed 28 Oct 2009
119	BBC HD	19:30-20:00	Wed 28 Oct 2009

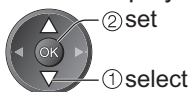

Timer Programming					
Function	No.	Channel Name	Date	Start	End
Ext Rec.	1	BBC ONE DIY SOS	Wed 28 Oct	20:00	20:30 (30 min.)
---	---	---	---	---	---
---	---	---	---	---	---
---	---	---	---	---	---
---	---	---	---	---	---

(Timer Programming screen)

“HD” will be displayed if HD broadcast is set.

Note

- This function is not available in Analogue mode.
- Timer Programming can store up to 15 events.
- Timer Programming reminder messages will remain displayed until one of the following occurs:
 - You press the OK button to view the programme or the EXIT button to cancel the reminder.
 - The timer programming event that the reminder is set for ends.
- No other channel can be selected while the recording of Timer Programming is in progress.
- When recording programmes, be sure to make the proper settings on the recorder connected to the TV. If a compatible recorder with Q-Link or similar technologies is connected to the TV (p. 86) and the “Link Settings” (p. 34) are completed, no setting of the recorder is required. Also read the manual of the recorder.
- When recording programmes to the USB HDD, be sure to register the USB HDD and enable it for recording in the “USB HDD Setup” (p. 62).

Guide link programming (Timer Programming from the TV Guide signal)

Guide link programming is Timer Programming which is controlled by information from the TV Guide; if programme start and end times are changed by the broadcaster, the timer programming event will follow the change. A Split Programme programming is a Guide link programming which is interrupted by one or more other programmes. Note that Guide link programming (including Split Programme programming) only works reliably if correct information is received from broadcasters.

Timer Programming				Wed 28 Oct 2009 10:46	
Function	No.	Channel Name	Date	Start	End
Ext Rec.	1	BBC ONE DIY SOS	Wed 28 Oct	20:00	20:30 (30 min.)
Reminder	14	E4 The Bill	Wed 28 Oct	21:00	22:30 (90 min.)
Ext Rec.	72	BBC 2W <TIMER>	Wed 28 Oct	22:45	23:00 (15 min.)
Ext Rec.	1	BBC ONE Red Cap	Thu 29 Oct	10:30	11:30 (60 min.)

(Timer Programming screen)

“Guide” is displayed if the timer is set from the TV Guide (Guide link programming)

“S/P” is displayed if the timer is set from the TV Guide and the programme is a Split Programme

“G” or “S/P” will be displayed in the TV Guide if Timer Programming is set as the Guide link programming.

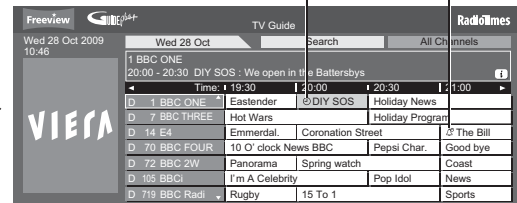

Note

- If you edit the start time or end time of a Guide link programming event by more than 10 minutes, it will no longer follow the broadcaster’s changes to the start or end time. The start and end times will become fixed.
- Whilst making the Split Programme programming event for Ext Rec. or USB HDD Rec., you cannot record any channels between the interrupted programmes.
- The Split Programme programming event for Reminder will be cleared by pressing the OK button once to view.
- The Split Programme programming event for Reminder will switch to the programmed channel by pressing the OK button even if it is between the interrupted programmes.
- The Split Programme programming does not work if the separated parts are broadcast on different channels.

View details of the programme (freesat or DVB mode)

Select the programme



View details

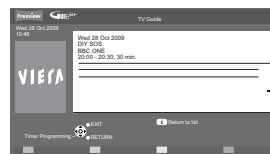

Details

- Press again to return to TV Guide.

View advertisement (DVB or Analogue mode)

Enter your postcode when using this function for the first time

➔ “Postcode” in “GUIDE Plus+ Settings” (p. 36)

If you have already entered your postcode in “Auto Setup” - when first using the TV (p. 12), you do not have to enter it again.

If you enter an incorrect postcode for your area, or no postcode is entered, advertisements may not be displayed correctly.

Display advertisement information

OPTION



- To display the latest advertisement, you will need to update the information. To update the information continuously, the TV must be left in Standby mode at night.

To change advertisements



To return to TV Guide



Note

- Some advertisements are for future programmes. In this case it is possible to use the Guide link programming function (above).
- The advertisements displayed on the TV Guide are sent from the GUIDE Plus+ system so that they cannot be deleted manually or will not be lost even when the TV is turned Off with Mains power On / Off switch.

Using TV Guide

Other Sat. mode

In Other Sat. mode, TV Guide is not available. In stead, Channel List will appear.

● To tune in Other Sat. Channels → p. 49

1 Select Other Sat.
→ p. 16

2 Display the Channel List

All Other Sat. Channels	
2	freesatHome
3	freesatSSU
4	Brit Shorts
5	HINRG LOWNRG
6	WELL Class
7	GROOVE
8	-

3 Select the channel

② watch
① select

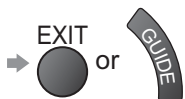

Panasonic
TV

■ To return to TV



Viewing Teletext

You can enjoy news, weather forecasts and subtitles, etc. (depending on the broadcaster)

- The availability of teletext services for a programme is indicated by "TEXT" in the information banner.

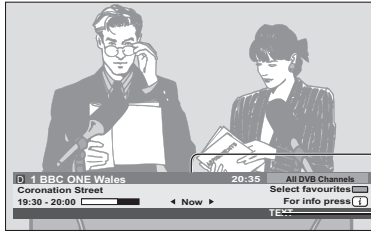

Information banner (p. 17)

Displayed if programme has teletext service

Digital teletext (MHEG)

Digital teletext services

Digital teletext services differ greatly from analogue teletext.

When you switch to a digital teletext service, the images you see can contain graphics and text, laid out and controlled in a manner decided by the broadcaster.

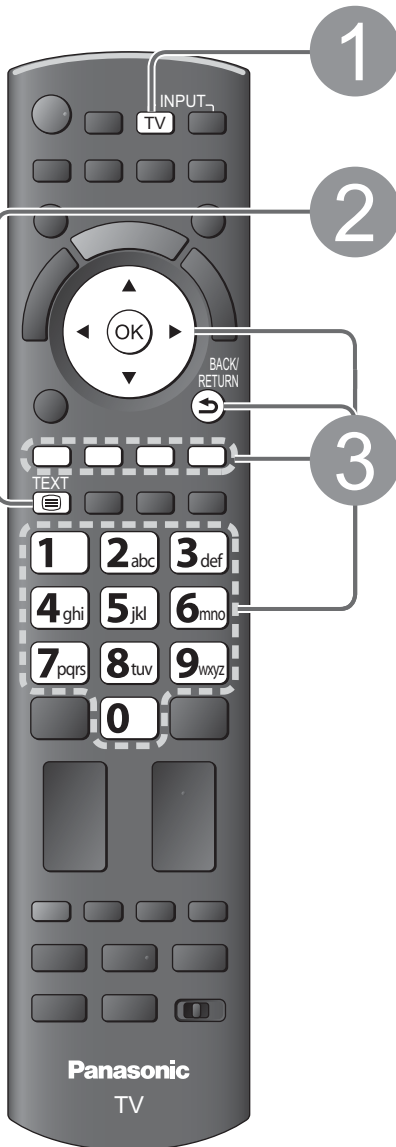

1

Select freesat or DVB

→ p. 16



- freesat and DVB programmes have digital teletext services (MHEG).

2

Switch to Teletext

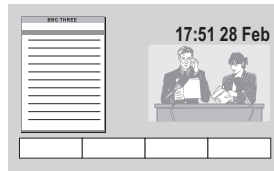

3

How to use

In all cases, it is possible to navigate the pages using buttons on the remote control, but because the commands available must apply to all manufacturers of digital equipment, some on screen commands may not correspond exactly to the remote control buttons.

For example:

- When "select" or "go" is displayed →
- When "◀", "▶", "▲", "▼" symbol is displayed →
- When "back key" is displayed →
- When the key words are displayed on colour bar →
- When options with numbers are displayed →

■ To return to TV →

Note

- As soon as you switch to a digital channel with links to a teletext service, software is downloaded in the background to enable the teletext function. This means that when switching to a digital channel, you should wait for approximately 5 seconds before pressing the TEXT button - this will allow the software to download. If you press the TEXT button before download is complete, it will be ignored and you will have to press the TEXT button again when the download is complete.
- While navigating digital teletext, you will find there is a short delay when moving between pages while the page downloads. There is often a prompt shown somewhere on the page (for example "Loading") to let you know that this is happening.

Viewing Teletext

Analogue teletext

Analogue teletext services

Analogue teletext services are the text information provided by the broadcasters. The features may vary depending on the broadcasters.

What is FASTEXT mode?

In FASTEXT mode, four differently coloured subjects are situated at the bottom of the screen. To access more information about one of these subjects, press the appropriately coloured button. This facility enables fast access to information on the subjects shown.

What is List mode?

In List mode, four differently coloured page numbers are situated at the bottom of the screen. Each of these numbers can be altered and stored in the TV's memory. ("Store frequently viewed pages", p. 27)

■ **To change mode** → "Teletext" in the Setup Menu (p. 35)

1 Select Analogue or Other Sat.
→ p. 16
TV

- Other Sat. programmes are digital broadcasts. The operations of the teletext services, however, are equal to Analogue teletext service.

2 Switch to Teletext
TEXT

- Displays the index page (content varies depending on the broadcasters)

3 Select the page

1 2 abc 3 def
4 ghi 5 jkl 6 mno
7 pqrs 8 tuv 9 wxyz
0

or up
down

or red green yellow blue
(Corresponds to the colour bar)

Sub page number
Current page number **P100** 17:51 28 Feb Time / date
TELETEXT INFORMATION
Colour bar

■ **To adjust contrast** → **MENU** (press twice) →

As the blue bar is displayed

■ **To return to TV** → **EXIT**

Reveal hidden data

Reveal hidden words e.g. quiz page answers

MENU → red • To rehide →

FULL / TOP / BOTTOM

MENU → green

(TOP) (BOTTOM) Normal (FULL)

(Expand the TOP half) → (Expand the BOTTOM half)

HOLD

Stop automatic updating

(If you wish to hold the current page without updating)

HOLD • To resume → **HOLD**

INDEX

Return to the main index page



Subtitles

View a favourite page stored



- Factory setting is "P888" (subtitle service) on the blue button (List mode).

View in multi window

Watch TV and Teletext in two windows at once



- Operations can be made only in Teletext screen.
- Each time pressed: Teletext → TV and Teletext



Store frequently viewed pages

Store frequently viewed pages in the colour bar

(List mode only)

As page is displayed

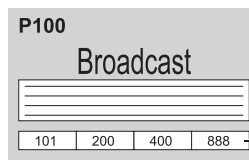
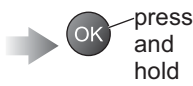

The number changes to white.

- If you wish to use Subtitles, do not change number on blue button.

■ To change stored pages

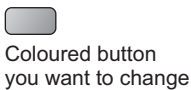

Enter new page number



View sub page

View sub page (Only when teletext is more than one page)



■ To view specific sub page

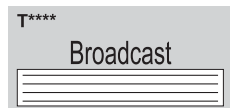

Enter the 4-digit number
example: P6
0 0 0 6

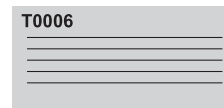

- Sub pages:
The number of sub pages varies depending on the broadcasters (up to 79 pages).
It may take some time for searching, during which time you can watch TV.

Watch TV while waiting for update

View the TV picture while searching for a teletext page

Teletext automatically updates itself when new information becomes available.



Changes to TV screen temporarily

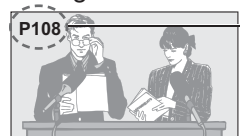

(You cannot change the channel.)

View the updated page



- The news page provides a function that indicates arrival of latest news ("News Flash").

Watching External inputs

Connect the external equipment (VCRs, DVD equipment, etc.) and you can watch through the AV input.

● To connect the equipment → p. 11 and p. 92 - p. 93

The Remote Control is capable of operating some functions of selected external equipment.

1 Turn the TV on

- **When connecting with SCART as example 2 or 3 (p. 11)**
 - ➔ Receives input signals automatically when playback starts
 - Input signals are automatically identified by the SCART (pin 8) terminal.
 - This function is also available for HDMI connections (p. 92 and p. 93).
- **If input mode is not switched automatically**
 - ➔ Perform ② and ③
 - Check the setup of the equipment.

2 Display the Input select menu

AV

3 Select the input mode connected to the equipment

Input Selection	
AV1	
AV2/S	---
AV3	
COMPONENT	
PC	
HDMI1	
HDMI2	
HDMI3	
HDMI4	
TV	
Media Server	

- You can also select the input using the AV button on the remote control or the side panel of the TV. Press the button repeatedly until the desired input is selected.
- You cannot select "Media Server" using the AV button on the side panel of the TV.
- In order to switch between AV2 and AV2S, move the indicator by pressing left and right cursor button.
- You can label or skip each input mode → "Input Labels" (p. 55)
Skipped inputs will not be displayed when the AV button is pressed.

4 View

Displays the selected mode

AV2

■ **To return to TV**

➔ TV

Note

- If the external equipment has an aspect adjustment function, set it to "16:9".
- For details, see the manual of the equipment or ask your local dealer.









Screen display

Terminal	AV1	AV2	AV3	COMPONENT	PC	HDMI1	HDMI2	HDMI3	HDMI4
Manual input (default setting in "Input Labels")	AV1 AV1-RGB	AV2 AV2-S-Video AV2-RGB	AV3	COMPONENT	PC	HDMI1	HDMI2	HDMI3	HDMI4
Auto input (EC mode or VIERA Link)	EC/AV1 EC/AV1-RGB	EC/AV2 EC/AV2-S-Video EC/AV2-RGB	—	—	—	EC/HDMI1 ● Applicable for EC mode and VIERA Link	EC/HDMI2 ● Applicable for VIERA Link	EC/HDMI3 ● Applicable for VIERA Link	EC/HDMI4 ● Applicable for VIERA Link

● If the above information is permanently displayed on the top left of the screen, press the **i** button to clear.



Operating the equipment with the TV remote control



The Panasonic equipment connected to the TV can be directly operated with the below buttons of this TV remote control.

	Selection Switch for operating the connected equipment Select "DVD/VCR" to operate Panasonic DVD Recorder, DVD Player, Player theatre, Blu-ray Disc theatre or VCR ➔ "How to change the code for the type of the equipment" (see below) Select "TV" to use USB HDD Recording, Media Player or VIERA Link ➔ "USB HDD Recording" (p. 64) ➔ "Media Player" (p. 70) ➔ "VIERA Link Control" (p. 90)
	Standby Set to Standby mode / Turn on
	Play Playback videocassette / DVD / video content
	Stop Stop the operations
	Rewind / Skip / Search VCR: Rewind, view the picture rapidly in reverse DVD / video content: Skip to the previous track or title (not available for the operation of USB HDD Recording) Press and hold to search backward
	Fast-forward / Skip / Search VCR: Fast-forward, view the picture rapidly forward DVD / video content: Skip to the next track or title (not available for the operation of USB HDD Recording) Press and hold to search forward
	Pause Pause / Resume DVD: Press and hold to play at slow speed
	Channel Up / Down Select channel
	Record Start recording

■ How to change the code for the type of the equipment

Each type of the Panasonic equipment has its own remote control code.
Please change the code according to the equipment you want to operate.

- ① Set the position to "DVD/VCR" 
- ② Press and hold  during the following operations

Enter the appropriate code, see table below  ➔ Press 

Type of the equipment	Code
DVD Recorder, DVD Player	70 (default)
Player theatre, Blu-ray Disc theatre	71
VCR	72

Note

- Confirm if the remote control works correctly after changing the code.
- The codes may be reset to default values if batteries are replaced.
- Some operations may not be possible on some equipment models.

How to Use VIERA TOOLS

You can access some special features easily by using the VIERA TOOLS function.

- For “VIERA Link Control” and “Pause Live TV” functions to operate correctly, ensure the connections and settings are completed.
 - ➔ “Summary of Q-Link and VIERA Link features” (p. 84 and p. 85), “Preparations” (p. 87)
 - After connection, turn the equipment on and then switch the TV on.
- For “Photo”, “Video” and “Music” functions to operate correctly, ensure the device has photo or video data on it and insert it into the SD Card slot or USB port properly.
 - ➔ “Using Media Player” (p. 66)



1 Display icons of the feature



2 Select a feature



- ① select
- ② access

3 Follow the operations of each feature

- VIERA Link Control ➔ “VIERA Link Control” (p. 90)



When two or more compatible equipment are connected, a selection screen will be displayed.

Please select the correct description and access.

- Pause Live TV ➔ “Pause Live TV” (p. 89)



- Photo ➔ “Photo mode” (p. 68)



When two or more available devices are connected, a selection screen will be displayed.

Please select the correct description and access.

- Video ➔ “Video mode” (p. 70)



When two or more available devices are connected, a selection screen will be displayed.

Please select the correct description and access.

- Music ➔ “Music mode” (p. 73)



When two or more available devices are connected, a selection screen will be displayed.

Please select the correct description and access.

- Media Server ➔ “Using DLNA® features” (p. 80)



■ To return to TV



Note

- If the selected feature is not available, the demonstration to explain how to use it can be displayed. Press the OK button to view the demonstration after selecting the unavailable feature.

How to Use Menu Functions

Various menus allow you to make settings for the picture, sound, and other functions.



1 Display the menu
 MENU • Displays the functions that can be set (varies according to the input signal)

2 Select the menu

VIERA Main Menu	
Picture	
Sound	
Setup	

② access
 ① select

3 Select the item
 Example (Picture Menu):

Picture Menu 1/2	
Viewing Mode	Dynamic
Contrast	
Brightness	
Colour	
Sharpness	
Tint	
Colour Balance	Warm
Vivid Colour	Off
C.A.T.S.	Off

select

4 Adjust or select
 Example (Picture Menu):

Picture Menu 1/2	
Viewing Mode	Dynamic
Contrast	
Brightness	
Colour	
Sharpness	
Tint	
Colour Balance	Warm
Vivid Colour	Off
C.A.T.S.	Off

① change
 ② store or access (Required by some functions)

To return to TV at any time
 EXIT

To return to the previous screen
 BACK/RETURN

To change menu pages
 up
 down

Choose from among alternatives

Number and positions of alternatives

Colour Balance	Normal
----------------	--------

Changed

Adjust using the slide bar

Sharpness	
-----------	--

Moved

Go to the next screen

Child Lock	Access
------------	--------

Displays the next screen

Enter characters by free input menu

You can enter names or numbers freely for some items.

User input	
Name	
A B C D E F G H I J K L M N O P Q R S T	
U V W X Y Z 0 1 2 3 4 5 6 7 8 9 # *	
a b c d e f g h i j k l m n o p q r s t	
u v w x y z () + - =	

Set characters one by one

① select
 ② set

Store BACK/RETURN

- You can set characters by using numeric buttons.
 - ➔ "Characters table for numeric buttons" (p. 96)

How to Use Menu Functions

■ Menu list

Menu	Item	Adjustments / Configurations (alternatives)
Picture	Viewing Mode	<p>Basic picture mode (Dynamic / Normal / Cinema / True Cinema / Game / Photo / Professional1 / Professional2)</p> <p>In each Viewing Mode, Contrast, Brightness, Colour, Sharpness, Tint, Colour Balance, Vivid Colour, C.A.T.S., P-NR and 3D-COMB can be adjusted and stored to suit your particular viewing requirement.</p> <ul style="list-style-type: none"> ● Set for each input signal. <p>Dynamic : Provides enhanced picture contrast and sharpness when viewing in a bright room.</p> <p>Normal : Recommended for viewing under normal ambient room lighting conditions.</p> <p>Cinema : For watching movies in a darkened room with the improved performance of contrast, black and colour reproduction</p> <p>True Cinema : Precisely reproduces the original quality of the image without any revision.</p> <p>Game : Fast response signal specifically to provide suitable images for playing games</p> <ul style="list-style-type: none"> ● Not valid on TV mode ● A continuous record of time spent using Game mode can be displayed in the top right of the screen. <ul style="list-style-type: none"> ➔ "Playing Time Display" (p. 35) <p>Photo : Set "Reversal Film" to "On" to provide the suitable image quality for photos</p> <ul style="list-style-type: none"> ● For HDMI input, Media Player and Network service operations <p>Professional : Allows you to set the professional picture settings in "Advanced Settings", "Lock Settings" and "Copy Adjustment"</p> <ul style="list-style-type: none"> ➔ p. 60 ● This mode is available only when "Advance(isfcc)" in the Setup Menu is set to "On". ● Not valid on VIERA CAST ● If the certified professional dealer sets these modes, "Professional1" and "Professional2" may be displayed as "isf Day" and "isf Night".
	Contrast, Brightness, Colour, Sharpness	Increases or decreases the levels of these options according to your personal preference
	Tint	<p>With an NTSC signal source connected to the TV, the picture hue can be adjusted to suit your taste</p> <ul style="list-style-type: none"> ● For NTSC signal reception only
	Colour Balance	<p>Allows you to set the overall colour tone of the picture (Cool / Normal / Warm)</p> <ul style="list-style-type: none"> ● Not valid when "Viewing Mode" is set to "True Cinema", "Professional1" or "Professional2".
	Vivid Colour	<p>Automatically adjusts colours to vivid ones (Off / On)</p> <ul style="list-style-type: none"> ● Not valid on PC signal. ● Not valid when "Viewing Mode" is set to "Professional1" or "Professional2".
	Reversal Film Effect	<p>Provides the picture effect such as the reversal film (Off / On)</p> <ul style="list-style-type: none"> ● This function is available when "Viewing Mode" is set to "Photo".
	C.A.T.S.	<p>Contrast Automatic Tracking System (Automatic Brightness Control function)</p> <p>Adjusts picture settings automatically dependent on ambient lighting conditions (Off / On)</p>
	P-NR	<p>Picture Noise Reduction</p> <p>Automatically reduces unwanted picture noise and flicker noise in the contoured parts of a picture (Off / Min / Mid / Max)</p> <ul style="list-style-type: none"> ● Not valid on PC signal.
	3D-COMB	<p>Makes still or slow moving pictures look more vivid (Off / On)</p> <ul style="list-style-type: none"> ● Occasionally, whilst viewing still or slow moving pictures, colour patterning may be seen. Set to "On" to display sharper and more accurate colours. ● Not valid on RGB, S-Video, Component, PC, HDMI and Media Player
	Picture Display	<p>Turns the screen off when you select "Off" (Off / On)</p> <ul style="list-style-type: none"> ● The sound is active even if the screen turns off. ● Press any button (except Standby) to turn the screen on. ● This function is effective in reducing power consumption when listening to the sound without watching the TV screen.
Reset to Defaults	Press the OK button to reset the present Picture Viewing Mode to the default settings	

Menu	Item	Adjustments / Configurations (alternatives)
Sound	Mode	<p>Selects the basic sound mode (Music / Speech / User)</p> <ul style="list-style-type: none"> ● The selected mode affects all input signals. <p>Music: Improves sound quality for watching music videos, etc. Speech: Improves sound quality for watching news, drama, etc.</p> <ul style="list-style-type: none"> ● In Music and Speech modes, you can adjust “Bass” and “Treble” settings, and those settings will be stored for each mode. <p>User: Adjusts the sounds manually by using the equalizer to suit your favourite sound quality.</p> <ul style="list-style-type: none"> ● For the User mode, “Equalizer” will appear on the Sound Menu instead of “Bass” and “Treble”. Select the “Equalizer” and adjust the frequency. ➔ “Equalizer” (below)
	Bass	Increases or decreases level to enhance or minimise lower, deeper sound output
	Treble	Increases or decreases level to enhance or minimise sharper, higher sound output
	Equalizer	<p>Adjusts the frequency level to suit your favourite sound quality</p> <ul style="list-style-type: none"> ● This function is available when “Mode” is set to “User”. ● Select the frequency and change the frequency level by using the cursor button. ● If you want to enhance the bass sound, raise the level of the lower frequency. If you want to enhance the treble sound, raise the level of the higher frequency. ● To reset the levels of each frequency to the default settings, select the “Reset to Defaults” by using cursor button, and then press the OK button.
	Balance	Adjusts volume level of right and left speakers
	Headphone Volume	Adjusts the volume of the headphones
	Surround	<p>Surround sound settings (Off / V-Audio / V-Audio Surround)</p> <p>V-Audio: Provides a dynamic enhancer of width to simulate improved spatial effects V-Audio Surround: Provides a dynamic enhancer of width and depth to simulate improved spatial effects</p>
	Volume Correction	Adjusts the volume of individual channel or input mode
	Speaker Distance to Wall	<p>Adjusts the low frequency sound (Over 30cm / Up to 30cm)</p> <ul style="list-style-type: none"> ● If the gap between the TV and wall is over 30 cm, “Over 30cm” is recommended. ● If the gap between the TV and wall is within 30 cm, “Up to 30cm” is recommended.
	Preferred Multi Audio	Selects the preferred language for digital channel multi audio (depending on the broadcaster) (English / Welsh / Gaelic)
	NICAM	<p>Near Instantaneous Companded Audio Multiplex Reproduces NICAM stereo sound (Off / On)</p> <ul style="list-style-type: none"> ● Off if reception is poor (FM monaural sound) ● Analogue mode only
	SPDIF Selection	<p>SPDIF : A standard audio transfer file format Selects the initial setting for digital audio output signal from DIGITAL AUDIO OUT terminal (Auto / PCM)</p> <p>Auto : Dolby Digital Plus and Dolby Digital are output as Dolby Digital Bitstream. MPEG is output as PCM.</p> <p>PCM : Digital output signal is fixed to PCM.</p> <ul style="list-style-type: none"> ● For freesat, DVB, Other Sat., Network video contents (p. 82) or Video mode (p. 72)
	MPEG Optical Level	<p>Adjusts the audio level of MPEG output from DIGITAL AUDIO OUT terminal as the initial setting (0 / -2 / -4 / -6 / -8 / -10 / -12dB)</p> <ul style="list-style-type: none"> ● Normally, MPEG sound is larger comparing with the other types of audio track. ● For freesat, DVB or Other Sat. mode
	HDMI1 / 2 / 3 / 4 Input	<p>Select to fit the input signal (Digital / Analogue) (p. 97)</p> <p>Digital : When sound is carried via the HDMI cable connection Analogue : When sound is not carried via the HDMI cable connection</p> <ul style="list-style-type: none"> ● HDMI input mode only
	Audio Description Menu	Audio Description
Volume		<p>Adjusts the volume for Audio Description</p> <ul style="list-style-type: none"> ● DVB mode only
Speakers		<p>Set to “On” to activate the description sound track from TV speakers (Off / On)</p> <ul style="list-style-type: none"> ● DVB mode only
Headphones		<p>Set to “On” to activate the description sound track from headphones (Off / On)</p> <ul style="list-style-type: none"> ● DVB mode only
Reset to Defaults		Press the OK button to reset the present Sound Mode, Balance, Headphone Volume and Surround to the default settings

- A different menu will be displayed when “Advance(isfcc)” in the Setup Menu is set to “On” or in the mode of PC input, Media Player or Network service operations. (p. 59 - 61, 67 - 73 and p. 82)
- Only available items can be selected.

How to Use Menu Functions

Menu	Item	Adjustments / Configurations (alternatives)	
Setup	Timer Programming	Sets a timer to remind watching or record forthcoming programmes (p. 52)	
	Off Timer	Sets the time until the TV automatically goes to Standby mode (Off / 15 / 30 / 45 / 60 / 75 / 90 minutes) (p. 19)	
	USB HDD Setup	Register the connected USB HDD and makes the settings for the recording (p. 62)	
	Link Settings	VIERA Link	Sets to use VIERA Link functions (Off / On) (p. 87)
		HDMI Content Detection	Adjusts the picture settings according to the content type signal from the connected equipment via HDMI cable (Off / Auto) <ul style="list-style-type: none"> ● This function is available if the connected equipment supports HDMI Content Type. ● The content type information will be displayed for several seconds when this function works.
		Q-Link	Selects which AV terminal is to be used for data communication between this TV and a compatible recorder (AV1 / AV2) (p. 86) <ul style="list-style-type: none"> ● Select the connected terminal to the recorder even it is not compatible with Q-Link.
		AV1 / AV2 out	Chooses the signal to be transmitted from the TV to Q-Link (TV / AV1 / AV2 / AV3 / Monitor) <ul style="list-style-type: none"> ● Monitor: Image displayed on screen ● Component, PC and HDMI signals cannot be outputted.
		Standby Power Save	Controls the power consumption in Standby mode of the connected equipment to reduce the consumption (Off / On) (p. 88) <ul style="list-style-type: none"> ● This function is available when "VIERA Link" is set to "On".
		Intelligent Auto Standby	Makes non-watched or non-used connected equipment go into Standby mode to reduce the power consumption (Off / On (With reminder) / On (No reminder)) (p. 88) <ul style="list-style-type: none"> ● This function is available when "VIERA Link" is set to "On".
		Q-Link Download	Downloads analogue channel information to a Q-Link compatible equipment connected to the TV
	Child Lock	Locks a channel / AV input to prevent access to it (p. 54)	
	Freesat Tuning Menu	Favourites Edit	Creates a list of favourite freesat channels (p. 43)
		Channel List	Skips the unwanted freesat channels (p. 43)
		Auto Setup	Automatically sets the freesat channels received in the area (p. 40)
		Signal Condition	Checks the freesat signal condition (p. 43)
	DVB Tuning Menu	Favourites Edit	Creates a list of favourite DVB channels (p. 45)
		Channel List	Skips the unwanted DVB channels or edits DVB channels (p. 45)
		Auto Setup	Automatically sets the DVB channels received in the area (p. 41)
		Channel Sorting by Region	Automatically sorts tuned channels according to the available region (p. 44)
		Manual Tuning	Sets the DVB channels manually (p. 44)
		Update Channel List	Updates DVB Channel List while keeping your settings (p. 46)
New Channel Message		Selects whether to give a notification message when a new DVB channel is found (Off / On) (p. 46)	
Signal Condition	Checks the DVB signal condition (p. 46)		

Menu	Item	Adjustments / Configurations (alternatives)	
Setup	Analogue Tuning Menu	Channel List	Skips the unwanted Analogue channels or edits Analogue channels (p. 47)
		Auto Setup	Automatically sets the Analogue channels received in the area (p. 41)
		Manual Tuning	Sets the Analogue channels manually (p. 47)
	Other Sat. Tuning Menu	Favourites Edit	Creates a list of favourite Other Satellite channels (p. 50)
		Channel List	Skips the unwanted Other Satellite channels or edits Other Satellite channels (p. 50)
		Auto Setup	Automatically sets the Other Satellite channels received in the area (p. 49)
		Manual Tuning	Sets the Other Satellite channels manually (p. 48) ● Please consult the received satellite broadcasting companies for the setting.
		Add New Channels	Adds new Other Satellite channels to Channel List (p. 49)
		Signal Condition	Checks the condition of Other Satellite signals (p. 48)
	Display Settings	Teletext	Analogue teletext display mode (FASTEXT / List) (p. 26)
		Preferred Subtitles	Selects the preferred language for digital channel subtitles (depending on the broadcaster) (English / Welsh / Gaelic) ● To display subtitles ➔ p. 17
		Input Labels	Labels or skips each input terminal (p. 55)
		Banner Display Timeout	Sets how long the Information banner (p. 17) stays on screen (0 (No display) / 1 / 2 / 3 / 4 / 5 / 6 / 7 / 8 / 9 / 10 seconds)
		Playing Time Display	Set to "On" to display a continuous record of time spent using Game mode every 30 mins (Off / On) ● This function is available when "Game" is selected in "Viewing Mode" (p. 32).
		Radio Mode	Sets the timer for turning off the screen automatically when a radio channel is selected (Off / 5 / 10 / 15 / 20 seconds) ● The sound is active even if the screen turns off. ● Press any button (except Volume Up / Down and Sound Mute buttons) to turn the screen on. ● This function is effective in reducing power consumption when listening to a radio channel.
		Network Setup	Sets the network setting to use in your network environment (p. 76)
		DivX® VOD	Displays DivX VOD registration code (p. 95)
		Advance(isfcc)	Enables the advanced picture settings (Off / On) ● Set to "On" to enable the mode of "Professional1" and "Professional2" in "Viewing Mode". ● Set to "On" to display the advanced items in the Picture Menu - "Advanced Settings", "Lock Settings" and "Copy Adjustment". "Copy Adjustment" will be displayed when "Viewing Mode" is set to "Professional1" or "Professional2". ● "isfcc" is the picture setting for the certified professional dealer. For details, consult your local dealer.

● A different menu will be displayed when "Advance(isfcc)" in the Setup Menu is set to "On" or in the mode of PC input, Media Player or Network service operations. (p. 59 - 61, 67 - 73 and p. 82)

● Only available items can be selected.

How to Use Menu Functions

Menu	Item	Adjustments / Configurations (alternatives)	
System Menu	USB Keyboard Layout	Selects the language that your USB Keyboard supports <ul style="list-style-type: none"> ● Use a USB Keyboard to enter characters in VIERA CAST (p. 83). ● Characters may not be displayed correctly on the TV screen depending on the connected keyboard or the keyboard layout setting. 	
	Shipping Condition	Resets all settings, for example, when moving house (p. 51)	
	Owner ID	Inputs the owner ID (p. 56)	
	Common Interface	Uses include to watch pay-TV (p. 57)	
	System Update	Downloads new software to TV (p. 58)	
	Software Licence	Displays the software licence information	
	System Information	Displays the system information of this TV	
Setup	GUIDE Plus+ Settings	Postcode	Sets your postcode to display advertisements in the GUIDE Plus+ system (p. 23)
		System Information	Displays the system information of the GUIDE Plus+ system
	Intelligent Frame Creation	Automatically compensates the picture frame rate and removes juddering movements to make the images smooth and clear (Off / Mid / Max) <ul style="list-style-type: none"> ● This function is not available for selection (default to "Off") when "Viewing Mode" is set to "Game" or in the mode of PC input, photo or Network service operations. 	
	24p Smooth Film	Automatically compensates the picture frame rate to make the 24p source movie images smooth (Off / Mid / Max) <ul style="list-style-type: none"> ● This is available only for 24p signal input and displayed instead of "Intelligent Frame Creation". ● This function is not available for selection (default to "Off") when "Viewing Mode" is set to "Game" or in the mode of PC input, photo or Network service operations. 	
	Resolution Enhancer	Enhances the picture resolution to make the image sharper (Off / Mid / Max) <ul style="list-style-type: none"> ● This function is available for SD (Standard definition) signal. ● As for HD (High definition) signal, this function is available when aspect mode is set to 16:9 (16:9 Overscan is set to "On") or Zoom. ● Not valid on PC, VIERA CAST and Media Player 	
	Power on Preference	Automatically selects the input when the TV is turned on (TV / AV) <ul style="list-style-type: none"> Set to "TV" to view picture from TV tuner. Set to "AV" to view input from an external equipment connected to a SCART terminal, e.g. cable TV box. ● The external equipment must be switched on and sending a control signal for automatic switching at power on to occur. 	
	Power on Channel List	Automatically selects All Channels or Favourites list in the Information banner (p. 17) when the TV is turned on (All Channel List / Last) <ul style="list-style-type: none"> Set to "All Channel List" to display all the channels. Set to "Last" to display the one you selected last time. ● Not available on freesat or analogue mode 	
	Auto Standby	Sets the time the TV automatically goes to Standby mode when no operation is performed for the selected times (Off / 2 / 4 hours) <ul style="list-style-type: none"> ● Starting Timer Programming automatically does not affect this function. ● Automatic input switching with the connected equipment affects this function and time-count will be reset. ● The notification message will appear 3 minutes before going to Standby mode. 	
	Power Save	Reduces brightness of picture to economise on power consumption (Off / On)	
	16:9 Overscan	Selects the screen area displaying the image (Off / On) <ul style="list-style-type: none"> On : Enlarges the image to hide the edge of the image. Off : Displays the image in the original size. ● Set to "On" if noise is generated on the edge of the screen. ● This function is available when aspect is set to Auto (16:9 signal only) or 16:9. ● This function can be memorized separately for SD (Standard definition) and HD (High definition) signals. 	
	DVI Input Setting	Changes the black level in the image for HDMI input mode with DVI input signal manually (Normal / Full) <ul style="list-style-type: none"> ● When the DVI input signal from the external equipment, especially from PC, is displayed, the black level may not be suitable. In this case, select "Full". ● The black level for HDMI input signal will be adjusted automatically. ● For HDMI input mode with DVI input signal only 	

- A different menu will be displayed when "Advance(isfcc)" in the Setup Menu is set to "On" or in the mode of PC input, Media Player or Network service operations. (p. 59 - 61, 67 - 73 and p. 82)
- Only available items can be selected.
- If "Demo Settings" item is displayed in the Setup Menu, the TV is in "Shop" viewing environment. To return to "Home" viewing environment initialise all settings by accessing Shipping Condition.
 - ➔ "Shipping Condition" (p. 51)

■ Overview (Picture, Sound)

● How to operate ➔ p. 31

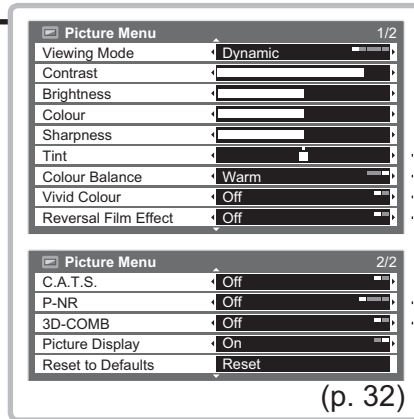
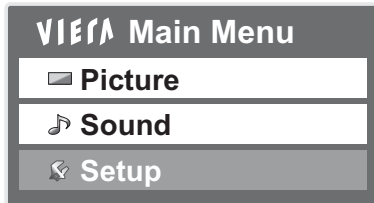

Available in NTSC

Not available when "Viewing Mode" is set to "True Cinema" or "Professional1 / 2"

Not available in PC or when "Viewing Mode" is set to "Professional1 / 2"

Available when "Viewing Mode" is set to "Photo"

Not available in PC

Available in NTSC / PAL

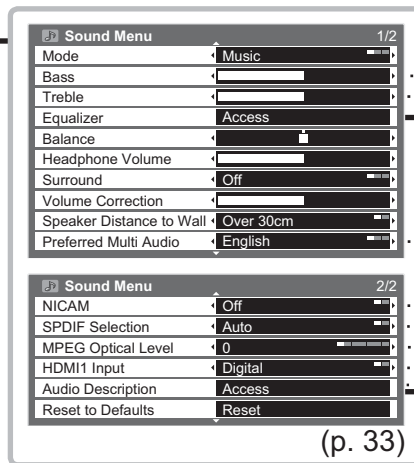

Available when "Mode" is set to "Music" or "Speech"

Available when "Mode" is set to "User"

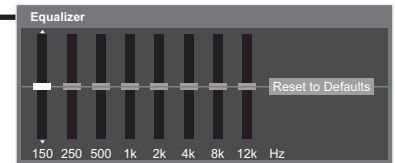

Available in digital

Available in Analogue

Available in digital, Network video contents or Video mode

Available in digital

Available in HDMI

Available in freesat or DVB freesat:



DVB:

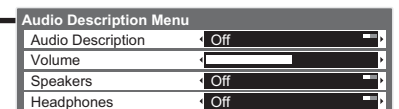

How to Use Menu Functions

Overview (Setup)

How to operate → p. 31

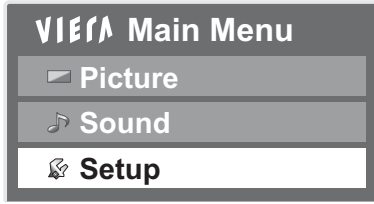

Function	No.	Channel Name	Date	Start	End
Ext Rec.	72	BBC 2TV <TIMER>	Wed 28 Oct	20:00	21:30 (90 min.)
Reminder	14	E4 This Bill	Wed 28 Oct	21:00	22:00 (60 min.)
Ext Rec.	1	BBC ONE DIV SOS	Wed 28 Oct	22:45	23:00 (15 min.)
Ext Rec.	1	BBC ONE <TIMER>	Thu 29 Oct	10:30	11:30 (60 min.)

(p. 52)

Function	Access
Timer Programming	Access
Off Timer	Off
USB HDD Setup	Access
Link Settings	Access
Child Lock	Access
freesat Tuning Menu	Access
DVB Tuning Menu	Access
Analogue Tuning Menu	Access
Other Sat. Tuning Menu	Access
Display Settings	Access
Network Setup	Access

(p. 34 - 36)

Function	Access
DivX® VOD	Access
Advance(isfcc)	Off
System Menu	Access
Other Settings	Access

Function	Access
Device Setup	Access
One Touch Recording	180 minutes
Rewind LIVE TV	On

(p. 62)

Function	Access
Child Lock-PIN Entry	Access
Please enter new PIN	***
PIN	***

(p. 54)

Available in freesat

Function	Access
freesat Tuning Menu	Access
Favourites Edit	Access
Channel List	Access
Auto Setup	Access
Signal Condition	Access

(p. 40 and p. 42 - p. 43)

Available in DVB

Function	Access
DVB Tuning Menu	Access
Favourites Edit	Access
Channel List	Access
Auto Setup	Access
Channel Sorting by Region	Access
Manual Tuning	Access
Update Channel List	Access
New Channel Message	On
Signal Condition	Access

(p. 41 and p. 44 - p. 46)

Function	Access		
DVB Update Channel List	Access		
Progress	CH 21 63		
CH	Channel Name	Type	Quality
Free TV: 0	Pay TV: 0	Radio: 0	Data: 0

(p. 46)

Available in Analogue

Function	Access
Analogue Tuning Menu	Access
Channel List	Access
Auto Setup	Access
Manual Tuning	Access

(p. 41 and p. 46 - p. 47)

Available in Other Sat.

Function	Access
Other Satellite Tuning Menu	Access
Favourites Edit	Access
Channel List	Access
Auto Setup	Access
Manual Tuning	Access
Add New Channels	Access
Signal Condition	Access

(p. 48)

Function	Access
System Menu	Access
USB Keyboard Layout	English(UK)
Shipping Condition	Access
Owner ID	Access
Common Interface	Access
System Update	Access
Software Licence	Access
System Information	Access

(p. 36)

Function	Access
Other Settings	Access
GUIDE Plus+ Settings	Access
Intelligent Frame Creation	Off
24p Smooth Film	Off
Resolution Enhancer	Off
Power on Preference	TV
Power on Channel List	Last
Auto Standby	Off
Power Save	Off
16:9 Overscan	On
DVI Input Setting	Normal

Available in DVB or Other Sat.

Available in HDMI with DVI input signal

Function	Access
Guide Plus+ Settings Menu	Access
Postcode	Access
System Information	Access

(p. 36)

Enter Postcode

Postcode

A	B	C	D	E	F	G	H	I	J	K	L	M	N	O	P	Q	R	S	T
U	V	W	X	Y	Z	0	1	2	3	4	5	6	7	8	9				

1 2 3
4 5 6
7 8 9
0

(p. 36)

Function	Access
Display Settings	Access
Teletext	FASTEXT
Preferred Subtitles	English
Input Labels	Access
Banner Display Timeout	3 seconds
Playing Time Display	On
Radio Mode	Off

(p. 35)

Available in Analogue
Available in freesat,
DVB or Other Sat.

Function	Access
Input Labels	Access
AV1	DVD
AV2/S	AV2/S
AV3	AV3
COMPONENT	COMPONENT
PC	PC
HDMI1	HDMI1
HDMI2	HDMI2
HDMI3	HDMI3
HDMI4	HDMI4

Function	Access
Input Labels	Access
freesat	freesat
DVB	DVB
Analogue	Analogue
Other Sat.	Other Sat.

(p. 55)

Link Settings 1/2

- VIERA Link On
- HDMI Content Detection Off
- Q-Link AV2
- AV2 out TV
- Standby Power Save On (No reminder)
- Intelligent Auto Standby On (No reminder)
- Q-Link Download Access

(p. 34)

Sending Preset Data
Please wait!

0% 100%

Remote control unavailable

(p. 34)

Child Lock

- Change PIN Access
- Child Lock List Access

(p. 54)

Child Lock List - TV and AV

Name	Input	Type	Lock
4 BBC 1 Wales	DVB	Free TV	🔒
7 BBC THREE	DVB	Free TV	🔒
14 E4	DVB	Free TV	🔒
VCR	Analogue	Analogue	
1 BBC1	Analogue	Analogue	
2 ****	Analogue	Analogue	🔒
AV1	External	AV	
AV2S	External	AV	

(p. 54)

freesat Auto Setup

Searching

Signal Quality 0/10

Signal Strength 0/10

TV Channels Found 8

Radio Channels Found 2

Data Channels Found 1

Channels found, creating channel list

(p. 40)

freesat Channel List

- 101 BBC 1 Scotland
- 102 BBC 2 Scotland
- 103 stv
- 104 stv
- 108 BBC THREE
- 109 BBC FOUR
- 110 BBC HD

(p. 43)

freesat Favourites Editor

All freesat Channels	Favourites
101 BBC 1 Wales	
102 BBC 2 Wales	
103 ITV1 WALES	
108 BBC THREE	
109 BBC FOUR	
110 BBC HD	
112 ITV2	
113 ITV2+1	

(p. 43)

DVB Auto Setup

Progress CH 21 68

This will take about 3 minutes.

CH	Channel Name	Type	Quality
62	CBBC Channel	Free TV	10
62	BBC Radio Wales	Free TV	10
62	E4	Free TV	10
62	Cartoon Nwk	Free TV	10

Free TV: 4 Pay TV: 0 Radio: 0 Data: 0

Searching

(p. 41)

All DVB Channels

- 70 CBBC Channel
- 72 Cartoon Nwk
- 105 BBC1
- 719 BBC Radio Wales
- 720 BBC Radio Cymru
- 1 BBC ONE Wales
- 7 BBC THREE

(p. 45)

DVB Favourites Editor

All DVB Channels	Favourites1
1 BBC One Wales	
7 BBC THREE	
14 E4	
70 CBBC Channel	
72 Cartoon Nwk	
105 BBC1	
719 BBC Radio Wales	
720 BBC Radio Cymru	

(p. 45)

DVB Manual Tuning

Frequency CH21 474MHz

Signal Quality 0/10

Signal Strength 0/10

No.	Channel Name	Type	New

Free TV: 0 Pay TV: 0 Radio: 0 Data: 0

Stopped

(p. 44)

Channel Sorting by Region

GBR>

Best signal quality (All Regions)

England Regions>

Region choice available

(p. 44)

Analogue Manual Tuning

1 BBC1 CH33

Manual Tuning 21-68

(p. 47)

Analogue Auto Setup

Scan CH 21 68

This will take about 3 minutes.

CH	Channel Name
29	
30	

Analogue: 2

Searching

(p. 41)

Analogue Channel List

- 1 BBC1
- 2 ****
- 3 ****
- 4
- 5
- 6
- 7

(p. 47)

Other Satellite Auto Setup - Satellite Selection

Satellite Selection Astra2/Eurobird

freesat and other channels

(p. 49)

Search Mode

Free Channels All Channels

(p. 49)

Other Satellite Auto Setup

Satellite Astra 2/Eurobird

Progress 0% 100%

This may take up to 20 minutes.

No.	Channel Name	Type	Quality
1	BBC 1 East (W)	Free TV	10
2	BBC 1 CI	Free TV	10
3	BBC HD	Free TV	10
4	6945	Free TV	10

Free TV: 4 Pay TV: 0 Radio: 0

Searching

(p. 49)

Available in DVB or Other Sat.

Common Interface

Slot 1: Module inserted

(p. 57)

Owner ID

Please enter PIN for access

PIN *****

(p. 56)

Shipping Condition

All tuning data will be erased
Are you sure?
Are you sure?

(p. 51)

System Update

Auto Update Search in Standby On

System Update Search Now Access

(p. 58)

Retuning from Setup Menu

Auto Setup retunes all channels automatically.

freesat channels

Automatically retune all the freesat channels received in the area.

- Only freesat channels are retuned.
- All the previous tuning settings (Favourites Edit and Channel List, etc.) are erased.
- If a Child Lock PIN number (p. 54) has been set, it must be entered.



- 1 Select freesat**
→ p. 16
TV
- 2 Display the menu**
MENU
- 3 Select "Setup"**

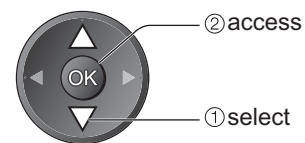
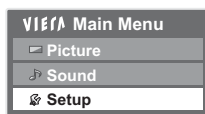

- 4 Select "freesat Tuning Menu"**

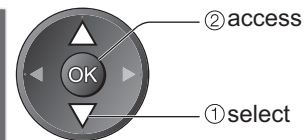
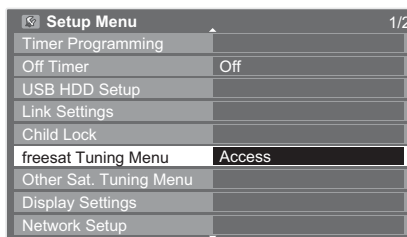

- 5 Select "Auto Setup"**

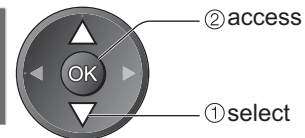
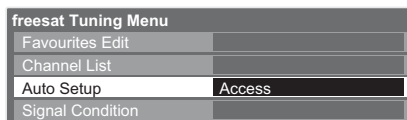

- 6 Start Auto Setup**

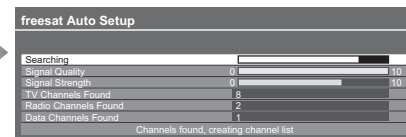
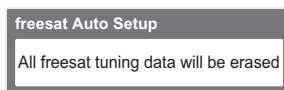

Settings are made automatically

- 7 Enter your postcode**

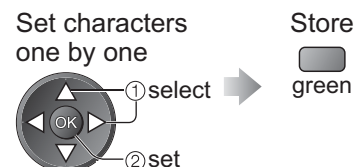
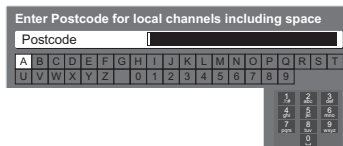

Your postcode is required to receive local services and sort the channel order. Please ensure to include a space when entering your postcode.

- You can set characters by using numeric buttons.
→ "Characters table for numeric buttons" (p. 96)

■ To return to TV



■ For Auto Setup, using the buttons on the side panel of the TV (p. 9)

- ① Press repeatedly until "Auto Setup" appears



- ② Access "Auto Setup"



- ③ Start "Auto Setup"

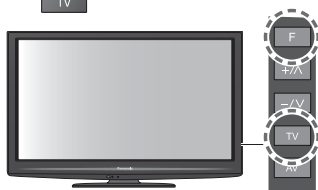

● To return to TV → **F**

Note

- You cannot set the postcode in this operation. The previous postcode setting is not erased.

When the operation is completed, the channel at the lowest position will be displayed.

DVB or Analogue channels

Automatically retune all DVB or Analogue channels received in the area.

- Only DVB channels are retuned in DVB mode.
- Only Analogue channels are retuned in Analogue mode.
- All the previous tuning settings (Channel List, etc.) are erased.
- If a Child Lock PIN number (p. 54) has been set, it must be entered.



1 Select DVB or Analogue

→ p. 16



2 Display the menu

MENU



3 Select "Setup"

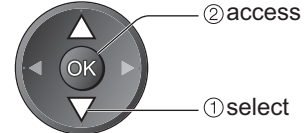
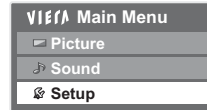

4 Select "DVB Tuning Menu" or "Analogue Tuning Menu"

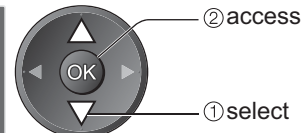
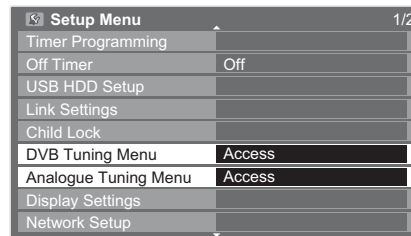

- "DVB Tuning Menu" is available in DVB mode only.
- "Analogue Tuning Menu" is available in Analogue mode only.

5 Select "Auto Setup"

DVB:

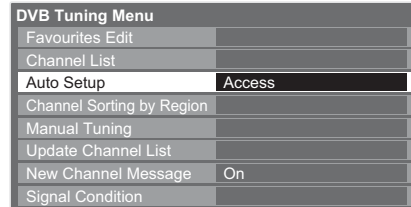

Analogue:

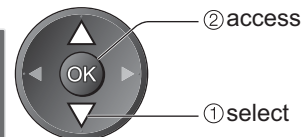
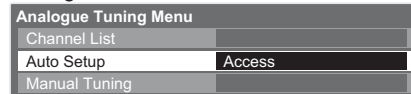

6 Start Auto Setup

DVB:

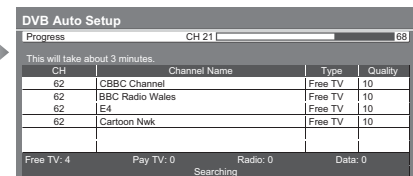
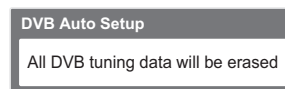

Analogue:

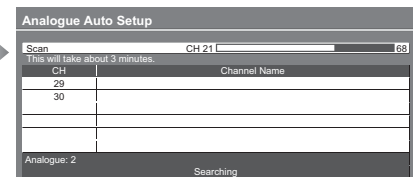
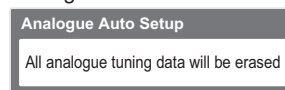

Settings are made automatically

- The analogue settings are downloaded to a Q-Link compatible equipment connected to the TV in Analogue mode.

When the operation is completed, the channel at channel position "1" will be displayed.

To return to TV



For Auto Setup, using the buttons on the side panel of the TV (p. 9)

① Press repeatedly until "Auto Setup" appears



② Access "Auto Setup"



③ Start "Auto Setup"



● To return to TV → F

Note

- If tuning has not been done completely → "Manual Tuning" (p. 44 and p. 47)

Tuning and Editing Channels

(freesat)

You can retune channels or make your favourite channel list, skip unwanted channels, etc.

- 1 Select freesat**
 → p. 16
- 2 Display the menu**
- 3 Select "Setup"**

VIERA Main Menu	
Picture	
Sound	
Setup	
- 4 Select "freesat Tuning Menu"**

Setup Menu 1/2	
Timer Programming	
Off Timer	Off
USB HDD Setup	
Link Settings	
Child Lock	
freesat Tuning Menu	Access
Other Sat. Tuning Menu	
Display Settings	
Network Setup	
- 5 Select one of the following functions**

freesat Tuning Menu	
Favourites Edit	Access
Channel List	Access
Auto Setup	Access
Signal Condition	Access

 → "Retuning from Setup Menu" (p. 40)
- 6 Set** _____

■ To return to TV
 EXIT

List favourite freesat channels **Favourites Edit**

Create your favourite channel list from various broadcasters.
The freesat Favourites list is available from "Channel Genre" in the TV Guide (p. 20).

① Select a channel to list

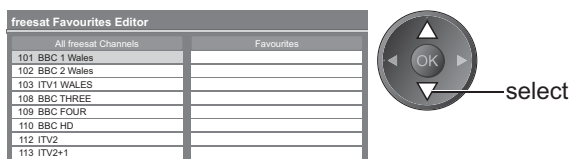

② Add it to the Favourites list

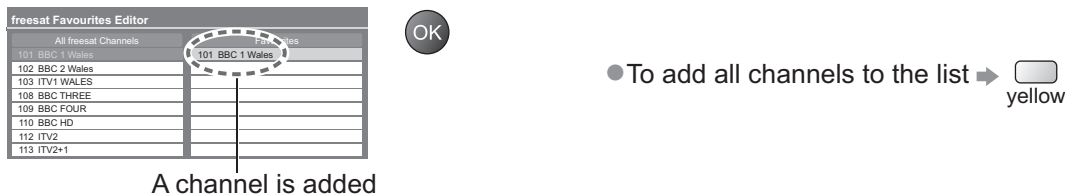

■ To edit Favourites list

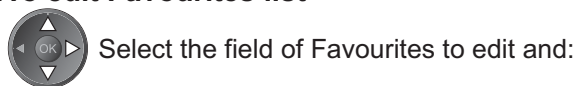

- To delete the channel →
- To delete all channels →

Note

- Channel position numbers (known as logical channel numbers) cannot be changed, due to broadcast restrictions.

③ Store



Skip unwanted freesat channels **Channel List**

You can hide unwanted freesat channels.
The hidden channels cannot be displayed except in this function. Use this function to skip unwanted channels.

Select a channel and reveal / hide

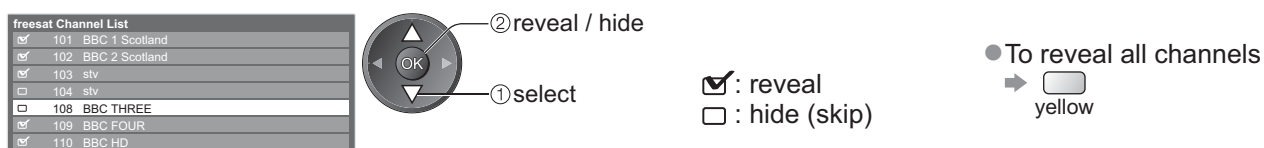

Check freesat signal **Signal Condition**

Selects a channel and checks the freesat signal condition.

- To change the channel →

freesat Signal Condition	
Channel Name	101 BBC 1 Wales
Signal Quality	0 10
Signal Strength	0 10
Bit Error Rate	0.00E+00
Satellite	Astra 28.2° E
Parameter	10847MHz, V, 22000kS/s

A good Signal Strength is not an indication of best signal for freesat reception. Please use the Signal Quality indicator as follows:

Signal Quality:

- Green bar → Good
- Yellow bar → Poor
- Red bar → Bad (Check the Satellite dish)

Tuning and Editing Channels

(DVB)

You can retune channels or make your favourite channel lists, skip unwanted channels, etc.

- 1 **Select DVB**
→ p. 16
TV
- 2 **Display the menu**
MENU
- 3 **Select “Setup”**

VIERA Main Menu	
Picture	
Sound	
Setup	
- 4 **Select “DVB Tuning Menu”**

Setup Menu 1/2	
Timer Programming	
Off Timer	Off
USB HDD Setup	
Link Settings	
Child Lock	
DVB Tuning Menu	Access
Display Settings	
Network Setup	
- 5 **Select one of the following functions**

DVB Tuning Menu	
Favourites Edit	Access
Channel List	Access
Auto Setup	Access
Channel Sorting by Region	Access
Manual Tuning	Access
Update Channel List	Access
New Channel Message	On
Signal Condition	Access

 - Auto Setup
→ “Retuning from Setup Menu” (p. 41)
- 6 **Set**

■ **To return to TV**
EXIT

Sort DVB channels according to the region **Channel Sorting by Region**

You can sort DVB channels so that those with the best signal quality, or those for your preferred region, appear nearer the top of your Channel List.

Normally, you should select “Best signal quality (All Regions)”.

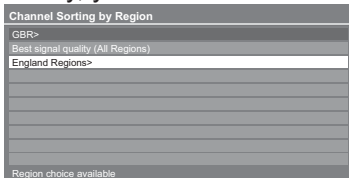

(select repeatedly until you reach the available region)

● If you choose to select your preferred region, you could find channels with a weaker signal appear nearer the top of your Channel List. If you have any image or sound problems, select “Best signal quality (All Regions)” instead.

Set DVB channel manually **Manual Tuning**

Normally use “Auto Setup” or “Update Channel List” to retune DVB channels.

If tuning has not been done completely or for adjusting the direction of the aerial, use this function.

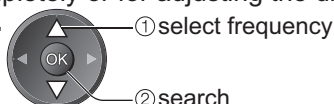
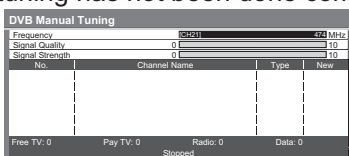

● All channels found will be added to the Channel List.

List favourite DVB channels **Favourites Edit**

Create your favourite channel lists from various broadcasters (up to 4: Favourites1 to 4). The DVB Favourites lists are available for switching in the Information banner (p. 17) and from "Category" in the TV Guide (p. 21).

① Select a channel to list

select

Encrypted channel

To display other Favourites → green

② Add it to the Favourites list

OK

To add all channels to the list → yellow

A channel is added

To edit Favourites list



Select the field of Favourites to edit and:

To delete a channel → Select the channel → OK To delete all channels →

To name the Favourites →

Set characters one by one (maximum: ten characters)

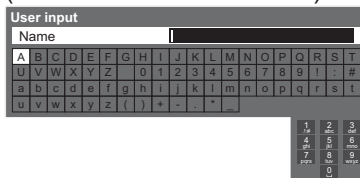

To name the Favourites → → Store BACK/RETURN

① select ② set

You can set characters by using numeric buttons.
→ "Characters table for numeric buttons" (p. 96)

To move the channel → → Select the new position → Confirm

or

Select the turn



③ Store



Note

- Channel position numbers (known as logical channel numbers) can be swapped in Channel List. To swap the channel position number → "Channel List" (below)

Skip unwanted DVB channels, Edit DVB Channels **Channel List**

You can hide unwanted DVB channels. The hidden channels cannot be displayed except in this function. Use this function to skip unwanted channels.

Select a channel and reveal / hide

② reveal / hide

① select

☑ : reveal To reveal all channels →

☐ : hide (skip)

To edit channels

You can also edit each channel in Channel List.



Select a channel to edit and:

To retune each channel - Manual Tuning (p. 44) (only for the revealed channels) →

To swap the channel position number → → Enter the new position number → Store

Channel position number

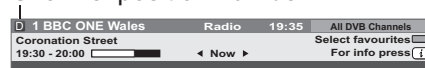

Tuning and Editing Channels

Update DVB channel automatically Update Channel List

You can add new channels, delete removed channels, update channel name and position automatically to Channel List.



- Channel List is updated while keeping your settings in Favourites Edit, Channel List, Child Lock, Timer Programming, etc.

Display a notification message New Channel Message

Selects whether to give a notification message when a new DVB channel is found. (Off / On)

New channels found!
Press OK to update channel list.
Press EXIT to ignore.

- Selecting OK will perform "Update Channel List".

Check DVB signal Signal Condition

Selects a channel and checks the DVB signal condition.

- To change the channel →

DVB Signal Condition	
Channel Name	70 CBBC Channel
Signal Quality	0
Signal Strength	0
Bit Error Rate	0.00E+00
Network Name	Wenvoe
Parameter	[CH62] 802 MHz

A good Signal Strength is not an indication of best signal for DVB reception. Please use the Signal Quality indicator as follows:

Signal Quality:

- Green bar → Good
- Yellow bar → Poor
- Red bar → Bad (Check the Terrestrial aerial)

(Analogue)

You can retune channels or skip unwanted channels, edit channels etc.



1 Select Analogue

→ p. 16



2 Display the menu

MENU



3 Select "Setup"

VIERA Main Menu	
Picture	
Sound	
Setup	

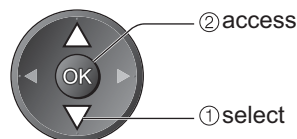

4 Select "Analogue Tuning Menu"

Setup Menu	
Timer Programming	
Off Timer	Off
USB HDD Setup	
Link Settings	
Child Lock	
Analogue Tuning Menu	Access
Display Settings	
Network Setup	

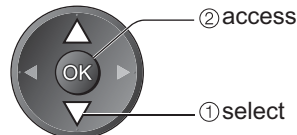

5 Select one of the following functions

Analogue Tuning Menu	
Channel List	Access
Auto Setup	Access
Manual Tuning	Access

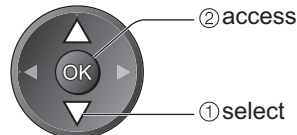

- Auto Setup → "Retuning from Setup Menu" (p. 41)

■ To return to TV

EXIT



6 Set

Skip unwanted Analogue channels, Edit Analogue channels Channel List

You can hide unwanted Analogue channels.
The hidden channels cannot be displayed except in this function. Use this function to skip unwanted channels.

Select a channel and reveal / hide

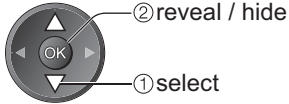
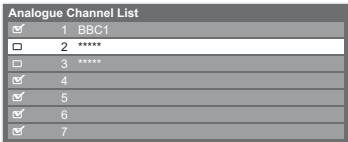

- : reveal
- : hide (skip)
- To reveal all channels
- yellow

To edit channels

You can also edit each channel in Channel List.



Select a channel to edit and:

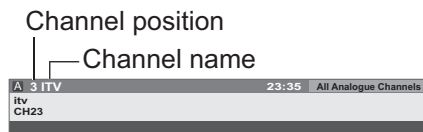

- To retune each channel - Manual Tuning (below) → red
 - To move the channel position → green → Select the new position → Store green
 - To rename the channel name → blue → Set characters one by one (maximum: five characters) → ① select → ② set → Store BACK/RETURN
- You can set characters by using numeric buttons.
→ “Characters table for numeric buttons” (p. 96)

Note

- If a VCR is connected only with the RF cable, edit “VCR”.

Set Analogue channel manually Manual Tuning

Set Analogue channel manually after Auto Setup.

- If a VCR is connected only with the RF cable, it is recommended to select channel position “0”.



Select the channel position



Select the channel



Search and store

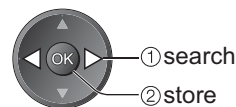

Tuning and Editing Channels

(Other Sat.)

You can tune all receivable digital satellite channels or skip unwanted channels, etc.

● Some of Other Sat. functions may work to differing specifications (depending on the broadcasters).

- 1 **Select freesat or Other Sat.**
→ p. 16
TV
- 2 **Display the menu**
MENU
- 3 **Select "Setup"**

VIERA Main Menu	
Picture	
Sound	
Setup	
- 4 **Select "Other Sat. Tuning Menu"**

Setup Menu 1/2	
Timer Programming	
Off Timer	Off
USB HDD Setup	
Link Settings	
Child Lock	
freesat Tuning Menu	
Other Sat. Tuning Menu	Access
Display Settings	
Network Setup	
- 5 **Select one of the following functions**

Other Satellite Tuning Menu	
Favourites Edit	Access
Channel List	Access
Auto Setup	Access
Manual Tuning	Access
Add New Channels	Access
Signal Condition	Access
- 6 **Set**

■ **To return to TV**
EXIT

Set Other Sat. channel manually **Manual Tuning**

Normally use "Auto Setup" or "Add New Channels" to tune Other Sat. channels.

Other Satellite Manual Tuning	
Transponder Frequency	10773
Polarisation	Horizontal
Symbol Rate (Ksym/s)	Auto

● Set tuning parameters for the required satellite, details can usually be found in a satellite TV magazine.

Check Other Sat. signal **Signal Condition**

Selects a channel and checks the Other Sat. signal condition.

● To change the channel →

Other Satellite Signal Condition	
Channel Name	1 BBC-1 East (W)
Signal Quality	0 / 10
Signal Strength	0 / 10
Bit Error Rate	0.00E+00
Satellite	Astra 28.2° E
Parameter	10847MHz, V, 22000Ks/s

A good Signal Strength is not an indication of best signal for Other Sat. reception. Please use the Signal Quality indicator as follows:

Signal Quality:

- Green bar → Good
- Yellow bar → Poor
- Red bar → Bad (Check the Satellite dish)

Set all receivable digital satellite channels Auto Setup

Any receivable digital compliant satellite channels can be tuned.

- Only Other Sat. channels are returned.
- All the previous tuning settings are erased.
- If a Child Lock PIN number (p. 54) has been set, it must be entered.

① Select the satellite

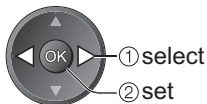

- Selectable satellites are Astra2/Eurobird, Astra1 and Hotbird.
Check the dish alignment for the satellite you want to select
 - Astra2/Eurobird → p. 10
 - Astra1, Hotbird → Please consult the received satellite broadcasting companies.
- If you want to tune from all available satellites, select "Any Satellite".

② Check the signal condition and the message

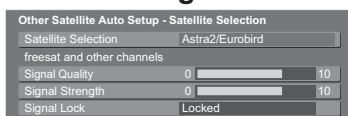

If you select "Any Satellite", this step is skipped.

- It takes a while to check the connection for your selected satellite.
- Ensure that the Signal Lock status is shown as "Locked". If it is not locked, the search cannot be executed.
- If the status is shown as "Not locked" and Signal Quality / Signal Strength have no indications, please check the dish alignment.
If the status is shown as "Not locked" but there are some levels of Signal Quality / Signal Strength indicated, select "Any Satellite" in Satellite Selection and try again.

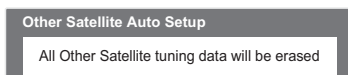

③ Set the search mode and start Auto Setup

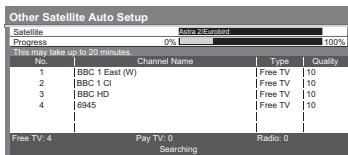
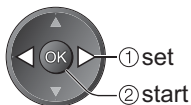

- If you select "Astra2/Eurobird" or "Any Satellite", freesat channels will also be searched. But the channels which have already been tuned in freesat will not be duplicated.

Settings are made automatically

When the operation is completed, the channel at channel position "1" will be displayed.

Add Other Sat. channel automatically Add New Channels

You can add any new channels found automatically to Channel List.

① Check the signal condition

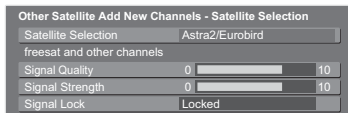

If you selected "Any Satellite" in Auto Setup, this step is skipped.

- It takes a while to check the connection for your selected satellite.
- Ensure that the Signal Lock status is shown as "Locked". If it is not locked, the search cannot be executed.
- If the status is shown as "Not locked" and Signal Quality / Signal Strength have no indications, please check the dish alignment.

② Set the search mode and start Add New Channels

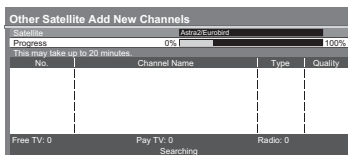
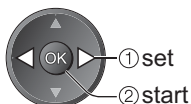

- New channels can only be added to the existing Channel List from the same satellite.

Tuning and Editing Channels

List favourite Other Sat. channels **Favourites Edit**

Create your favourite channel lists from various broadcasters (up to 4: Favourites1 to 4). The Other Sat. Favourites lists are available for switching in the Information banner (p. 17).

① Select a channel to list

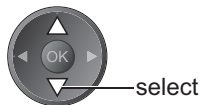
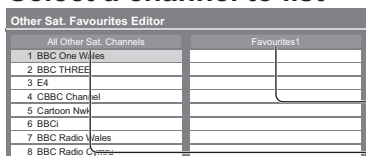

- To display other Favourites → green
- To change the category → red

② Add it to the Favourites list



A channel is added

- To add continuous block of channels to the list at once → yellow → Make the block → OK

■ To edit Favourites list



Select the field of Favourites to edit and:

- To delete the channel → OK
- To name the Favourites → red

Set characters one by one

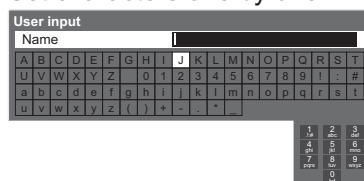

- To delete all channels → yellow
- ① select
- ② set



You can set characters by using numeric buttons. → "Characters table for numeric buttons" (p. 96)

- To move the channel → green → Select the new position → Confirm → green

or

Select the turn



③ Store



Skip unwanted Other Sat. channels, Edit Other Sat. Channels **Channel List**

You can hide unwanted Other Sat. channels.

The hidden channels cannot be displayed except in this function. Use this function to skip unwanted channels.

Select a channel and reveal / hide



- ② reveal / hide
- ① select

- To reveal all channels → yellow

- : reveal
- : hide (skip)

A channel that cannot be identified is shown as "Unknown"

■ To edit channels

You can also edit each channel in Channel List.



Select a channel to edit and:

- To delete the channel → red
- To swap the channel position → green → Enter the new position number → Store → green



Shipping Condition

Resets the TV to its original condition with no channels tuned in. All settings other than "Owner ID" and "USB HDD registration" are reset (channels, picture, sound settings, etc.).

- 1 Display the menu**
MENU
- 2 Select "Setup"**

VIERA Main Menu	
Picture	
Sound	
Setup	
- 3 Select "System Menu"**

Setup Menu 2/2	
DivX® VOD	
Advance(isfcc)	Off
System Menu	Access
Other Settings	
- 4 Select "Shipping Condition"**

System Menu	
USB Keyboard Layout	English(UK)
Shipping Condition	Access
Owner ID	
Common Interface	
System Update	
Software Licence	
- 5 Set**
EXIT

Restore Settings Shipping Condition

① Check the message and initialise

Shipping Condition

All tuning data will be erased
Are you sure?
Are you sure?

Confirm ● EXIT
● RETURN

OK (confirm)
OK (confirm)
OK (start Shipping Condition)

② Follow the on screen instructions

Reset to Factory Shipping Condition Completed.
Please switch off TV.

● "Auto Setup" will automatically start when Mains power On / Off switch is next turned On. (p. 12)

■ To retune TV channels only, e.g. after moving house

➔ "Retuning from Setup Menu" (p. 40 and p. 41)

Timer Programming

Timer Programming from Menu

The Timer Programming menu allows you to choose programmes that you wish to remind watching or record to the external recorder or the USB HDD. At the correct time, the TV will tune to the correct channel automatically to record even if the TV is in Standby mode.

TV Guide may also be used to set timer programming event (p. 22).

- Timer Programming can store up to 15 events.
- For recording using Timer Programming, the TV must be either On or in standby. For reminders to be displayed, the TV must be On.
- No other channel can be selected while the recording of Timer Programming is in progress.
- It may not be possible to record an encrypted programme (which is copy-protected).
- When recording programmes to the external recorder, be sure to make the proper settings on the recorder connected to the TV.

If a compatible recorder with Q-Link or similar technologies is connected to the TV (p. 86) and the “Link Settings” (p. 34) are correct, no setting of the recorder is required. Also read the manual of the recorder.

- If the recorder is not compatible with Q-Link or similar technologies, set “Q-Link” in the Setup Menu (p. 34) to the connected terminal (AV1 or AV2), and set the timer of the recorder in addition to the Timer Programming on the TV. For preparations of a recorder, read the manual of the recorder.
- When recording programmes to the USB HDD, be sure to register the USB HDD and enable it for recording in the “USB HDD Setup” (p. 62).
- Recordings are always in standard definition composite video via SCART, even if the original programme is in high definition.



1 Select the tuner you want to use

→ p. 16



2 Display the menu



3 Select “Setup”

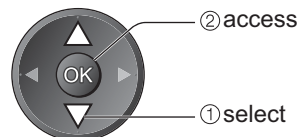
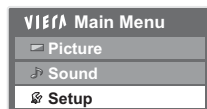

4 Select “Timer Programming”

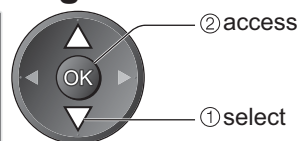
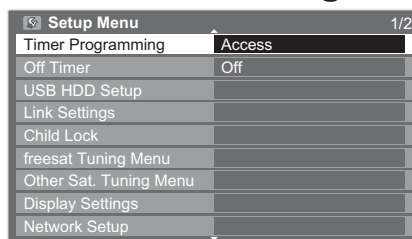

■ To return to TV



■ To unlock the tuner (stop recording)



5 Set _____

Note

- Check that the LED is orange. If not, timer programmes are not active or not stored.
- Timer Programming reminder messages will remain displayed until one of the following occurs:
 - You press the OK button to view the programme or the EXIT button to cancel the reminder.
 - The timer programming event that the reminder is set for ends.
- “!” identifies that any timer programming events have overlapped. “Ext Rec.” and “USB HDD Rec.” are given priority over “Reminder”. When two or more “Ext Rec.” / “USB HDD Rec.” overlap, the first timer programming event starts and finishes as programmed. The next timer programming event will then start.
- 2 mins. before the starting time, a reminder message appears if you are watching TV.
 - To remove the message and start the programme → • To cancel the Timer Programming →
- The recording of Timer Programming will automatically change to the programmed channel 10 seconds before the start time.
- To stop recording of the timer programming event, it may be necessary to stop the recorder manually.
- The recording of Timer Programming will be performed even if the TV is in Rewind LIVE TV recording (p. 65) and Pause Live TV recording (p. 89). In this case, these recordings will be cancelled.

Set timer programming event details Timer Programming

① Start making the settings



② Select the function (Ext Rec., USB HDD Rec. or Reminder)



select

Ext Rec. / : to record the programme to the external recorder (Ext Rec.) or the USB HDD Rec. (USB HDD Rec.)

When the start time comes, the channel will be switched automatically and the video and audio signals will be output. 2 mins. before the starting time, a reminder message appears if you are watching TV.

Reminder : to remind you to watch the programme
When you are watching TV, a reminder message appears 2 mins. before the start time. Press the OK button to switch to the programmed channel.

③ Set the channel, date and time (repeat the operations as below)

Set items in the order of ① to ④.



select the item



set

● ①, ③ and ④ can also be entered with numeric buttons.



Displayed if the timer programming events are overlapped

Information of the USB HDD (if available)

Timer programming - Programmes according to the time setting

Guide: Guide link programming - Programmes according to the TV Guide signal (p. 23)

S/P: Split Programme programming (p. 23)

Function	No.	Channel Name	Date	Start	End
Ext Rec.	72	BBC 2W <TIMER>	Wed 28 Oct	20:00 21:30 (90 min.)	
Reminder	14	E4 The Bill	Wed 28 Oct	21:00 22:00 (60 min.)	
Ext Rec.	1	BBC ONE DIY SOS	Wed 28 Oct	22:45 23:00 (15 min.)	
Ext Rec.	1	BBC ONE <TIMER>	STTL Thu 29 Oct	10:30 11:30 (60 min.)	

Records with subtitles (if available)

● To indicate this (press again to remove subtitles)

Duration (automatic display)

④ Ending time

③ Starting time

- ① Channel number
- ② Date
- : freesat
- : DVB
- : Analogue
- : Other Sat.
- You cannot change the mode within the menu.

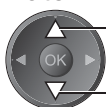

one day ahead

daily or weekly (press repeatedly)

- Daily Sun-Sat: Sunday to Saturday
- Daily Mon-Sat: Monday to Saturday
- Daily Mon-Fri: Monday to Friday
- Weekly Sat/Fri/Thu/Wed/Tue/Mon/Sun: Same time on the same day every week

④ Store



■ To change a timer programming event

➔ Select the programme to be changed

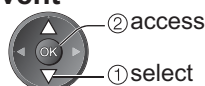

➔ Correct as necessary (as above)

■ To cancel a timer programming event

➔ Select the programme to be deleted



red



■ To record with subtitles (if available)

➔ Select the programme to record with subtitles



yellow

● Each time pressed: auto \longleftrightarrow off

■ To cancel a timer programming event temporarily

➔ Select the programme to be cancelled



blue

● Each time pressed: cancel \longleftrightarrow stop cancelling

■ To view details of the programming (only for Guide link programming)

➔ Select the programme to be viewed



● Press again to return to Timer Programming menu.

■ Guide link programming (Timer Programming from the TV Guide signal) ➔ p. 23

● This function is not available in Analogue or Other Sat. mode.

Guide link programming is Timer Programming which is controlled by information from the TV Guide; if programme start and end times are changed by the broadcaster, the timer programming event will follow the change. A Split Programme programming is a Guide link programming which is interrupted by one or more other programmes. Note that Guide link programming (including Split Programme programming) only works reliably if correct information is received from broadcasters.

Child Lock

You can lock specific channels / AV input terminals and control who watches them. When the locked channel / input is selected, a message appears; by entering the PIN number, you can watch it.



1 Display the menu



2 Select "Setup"

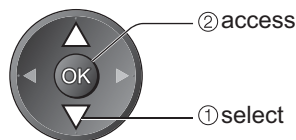
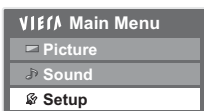

3 Select "Child Lock"

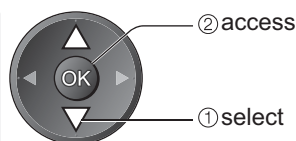
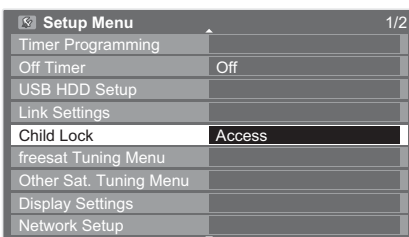

■ To return to TV



4 Set

Control channel audience **Child Lock**

1 Enter the PIN number (4 digits)



- Enter the PIN number twice at first setting.
- Make a note of the PIN number in case you forget it.

2 Select "Child Lock List"

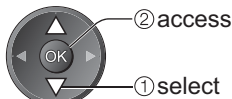
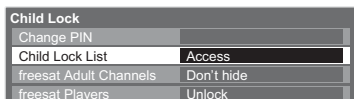

● In freesat mode, additional lock items will appear.

freesat Adult Channels: Select "Hide" to hide channels of the adult genre in TV Guide and Channel List. All the Timer Programming events of the adult genre will be cancelled.

freesat Players: Locks freesat content supplied through the internet.

Unlock: With this setting selected, you will not be required to enter your 4 digit child lock PIN when viewing freesat Player content. This is the default setting.

Lock Guidance Content: With this setting selected, you will be asked to enter your 4 digit child lock PIN whenever you wish to watch freesat Player content which is signalled as "Guidance" (i.e. originally broadcast post watershed).

Lock All Content: With this setting selected, you will be required to enter your 4 digit child lock PIN every time you wish to watch freesat Player content.

3 Select the channel / input to be locked

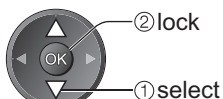
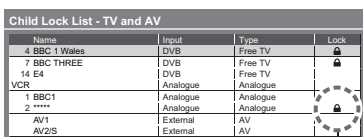

- To cancel → Select the locked channel / input → OK
- To jump to the top of the next input → red
- To lock all → green
- To cancel all locks → yellow

Appears when the channel / input is locked

■ To change the PIN number

Select "Change PIN"

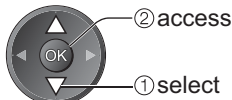
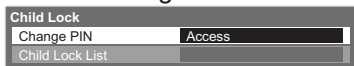

Enter a new PIN number twice



Note

- Setting "Shipping Condition" (p. 51) erases the PIN number and all settings.

Input Labels

For easier identification and selection of the input mode, you can label each input mode or skip terminals that are not connected to any equipment.

- To select the input mode → p. 28



1 Display the menu



2 Select "Setup"

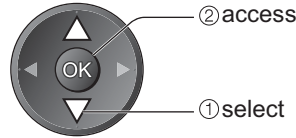
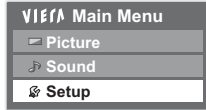

3 Select "Display Settings"

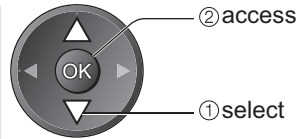
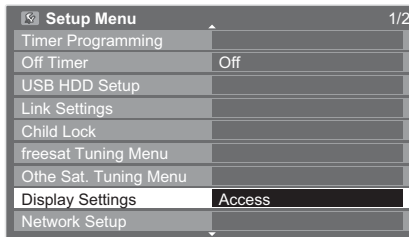

4 Select "Input Labels"

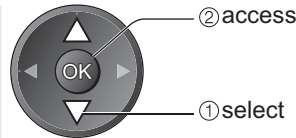
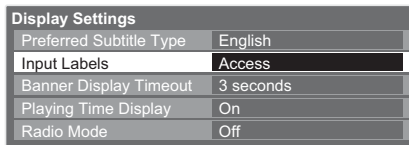

5 Select a input terminal and set

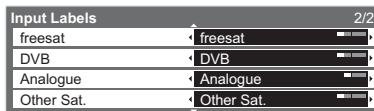
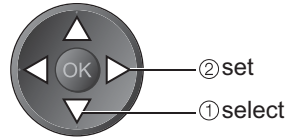
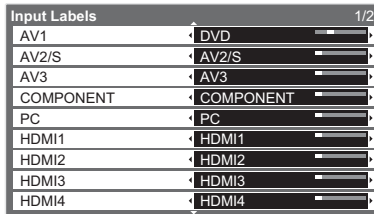

■ To return to TV



The labels you set will be displayed in the "Input Selection" menu (p. 28), "TV Selection" menu (p. 16) or banner.

- If "Skip" is selected, the input will not be displayed in the "Input Selection" menu and you cannot select the mode.

■ User input

You can name each input mode yourself.

Select "User input"

Set characters one by one (maximum: ten characters)

Store

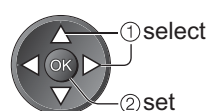
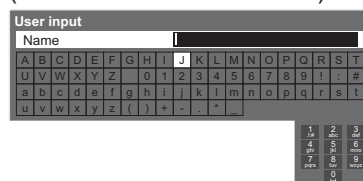
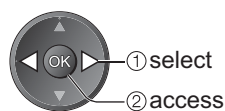

- You can set characters by using numeric buttons.
→ "Characters table for numeric buttons" (p. 96)

Owner ID

Entry of the PIN number and personal information (your name, address and postcode).
In the unfortunate event of theft, the Owner ID will help the Police to determine the owner.



1 Display the menu



2 Select "Setup"

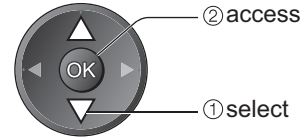
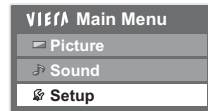

3 Select "System Menu"

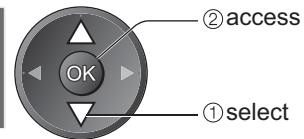
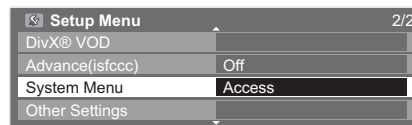

4 Select "Owner ID"

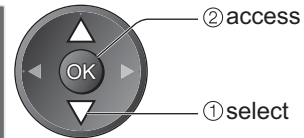
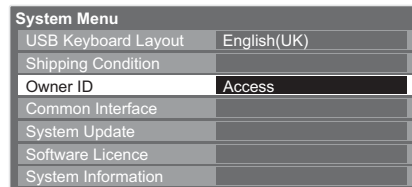

5 Set

■ To return to TV



Input owner ID Owner ID

1 Enter the PIN number (4 digits)

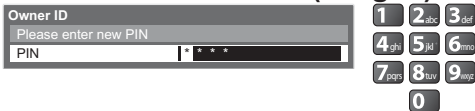

- Enter the PIN number twice at first setting.
- Make a note of the PIN number in case you forget it. The PIN number cannot be reset.

2 Enter your name, house number, and postcode, in that order

Select NAME / HOUSE NO / POSTCODE

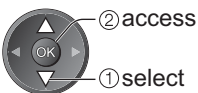
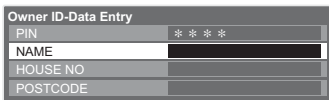

Set characters one by one

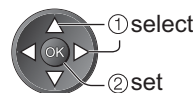
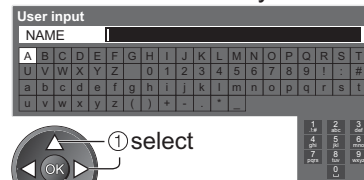

Return to select other items



or
Exit the menu



- You can set characters by using numeric buttons. → "Characters table for numeric buttons" (p. 96)

■ To check the personal information stored

Hold down for about 6 sec.



- The PIN number is not displayed.



■ To change the PIN number

Select "PIN"

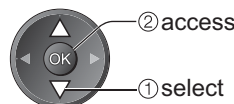
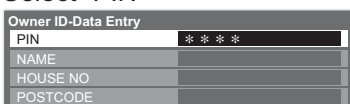

Enter a new PIN number twice



Using Common Interface

The Common Interface Module menu provides access to software contained on Common Interface (CI) Modules.

This TV works only Pay TV modules complying with CI standard.

- This function is not available for BSkyB's Sky channels.

Caution

- Turn Off Mains power On / Off switch whenever inserting or removing the CI module.
- If a viewing card and a card reader come as a set, first insert the card reader, then insert the viewing card into the card reader.
- Insert the module in the correct direction.

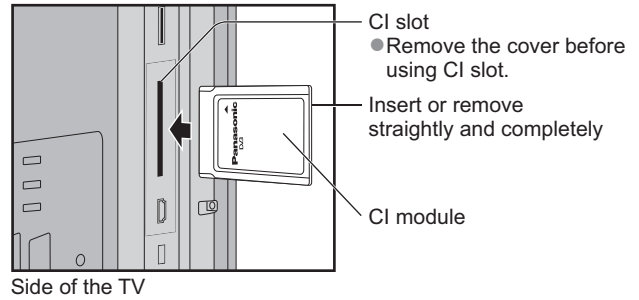

Insert the CI module (optional)

- The features that appear on screen are dependent on the contents of the selected CI module.
- Follow the instructions that came with the viewing card to tune in the pay-TV channels. If pay-TV channels do not appear, perform the below to verify the card is recognized by the TV.
- For more details, see the manual of the CI module, or check with the broadcaster.

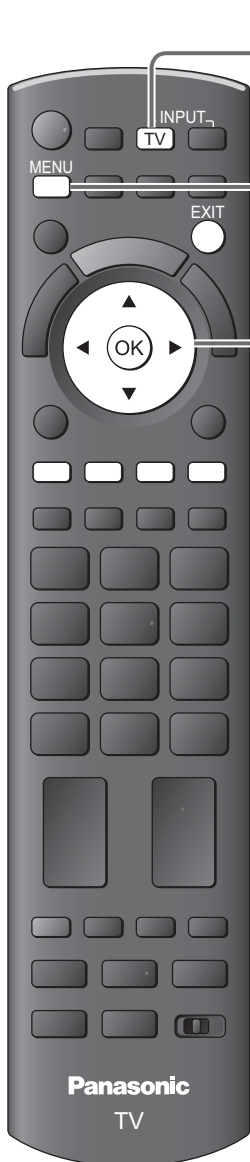

1 Select DVB or Other Sat.

→ p. 16



2 Display the menu



3 Select "Setup"

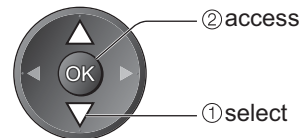
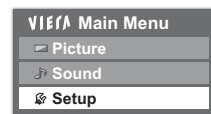

4 Select "System Menu"

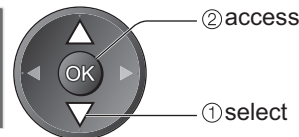
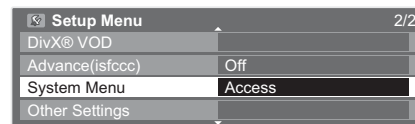

5 Select "Common Interface"

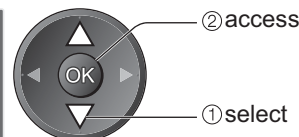
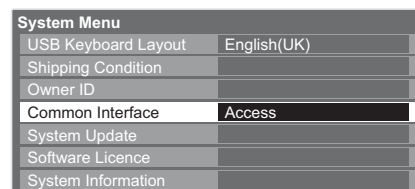

6 Access Common Interface



7 Follow the on screen operation guide (Check the instructions provided with the CI module)

For example: select, go →



Coloured characters →

■ To return to TV



- On screen operation guide may not correspond to the remote control buttons.

Updating the TV Software

From time to time, a new version of software may become available for download to enhance the performance or operations of the TV.

In DVB mode, a notification banner will appear when one of the BBC channels is turned to if a new available software is found.

- To download →
- If you choose not to download →

You can update any new software automatically, or manually.

- 1 Display the menu**
MENU
- 2 Select "Setup"**

VIEWA Main Menu	
Picture	
Sound	
Setup	
- 3 Select "System Menu"**

Setup Menu		2/2
DivX® VOD		
Advance(isfcc)	Off	
System Menu	Access	
Other Settings		
- 4 Select "System Update"**

System Menu	
USB Keyboard Layout	English(UK)
Shipping Condition	
Owner ID	
Common Interface	
System Update	Access
Software Licence	
System Information	
- 5 Set**
EXIT

Update TV's software system System Update

■ To update automatically

Select "Auto Update Search in Standby" and set to "On"

System Update	
Auto Update Search in Standby	On
System Update Search Now	

- Automatically performs a search in standby and downloads an update, if any software updates are available.
- The automatic updating is performed at night under the following conditions:
 - Standby (TV turned Off with the remote control)
 - Recording of Timer Programming, Direct TV Recording or One Touch Recording is not in progress.

If System Update is performed, the software will be updated (it may change TV functions). If you do not wish to do so, set "Auto Update Search in Standby" to "Off". The notification banner will keep appearing during the period of new software availability, usually 2 to 3 days.

■ To update immediately

Select "System Update Search Now"

System Update	
Auto Update Search in Standby	Off
System Update Search Now	Access

Searches for an update (for several mins.) and displays a corresponding message if any

Download



Note

- Download may take up to 60 mins.
- During software download and update, DO NOT perform any operations on the TV or switch Off the TV.

Displaying PC Screen on TV

The screen of the PC connected to the TV can be displayed on the TV.
You can also listen to PC sound with the audio cable connected.

● To connect PC → p. 92

1 Select the external input
AV

2 Select "PC"

Input Selection
AV1
AV2/S
AV3
COMPONENT
PC
HDMI1
HDMI2
HDMI3
HDMI4
TV
Media Server

■ To return to TV
→ TV

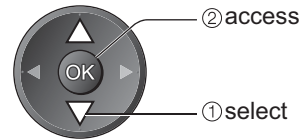

- Corresponding signals → p. 98
- If "H-freq." or "V-freq." is shown in red, the signals may not be supported.

■ PC menu setting

● To make settings → "How to Use Menu Functions" ① to ④ (p. 31)

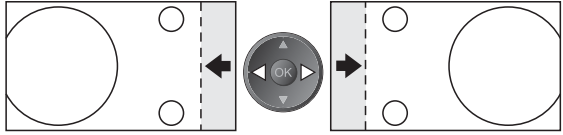
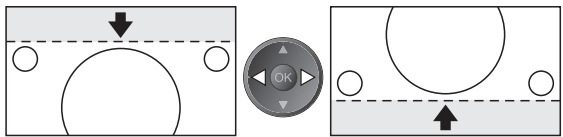
Menu	Item	Adjustments / Configurations (options)	
Picture	Advanced Settings	R-Gain	Adjusts the white balance of bright red area
		G-Gain	Adjusts the white balance of bright green area
		B-Gain	Adjusts the white balance of bright blue area
		R-Cutoff	Adjusts the white balance of dark red area
		G-Cutoff	Adjusts the white balance of dark green area
		B-Cutoff	Adjusts the white balance of dark blue area
		Gamma	Switches the gamma curve (1.8 / 2.0 / 2.2 / 2.4 / 2.6)
		Reset to Defaults	Press the OK button to reset to the default Advanced Settings
Setup	PC Setup	Input Resolution	Switches to a wide view ● VGA (640 × 480 pixels), WVGA (852 × 480 pixels), XGA (1,024 × 768 pixels), WXGA (1,280 × 768 pixels, 1,366 × 768 pixels) ● Options change depending on signals
		Clock	Set to the minimum level if noise occurs
		H-pos	Adjusts horizontal position 
		V-pos	Adjusts vertical position 
		Clock Phase	Eliminates flicker and distortion ● Adjust after Clock adjustment ● Set to the minimum level if noise occurs
		Sync	Chooses another synchronous signal if the image is distorted (H & V / On Green) ● H & V : by the horizontal and vertical signals from your PC On Green : by the green signal from your PC (if available)
		Reset to Defaults	Press the OK button to reset to the default PC Setup settings

● Other items → p. 32 - p. 36

Note

● For HDMI-compatible PC, possible to connect to HDMI terminals (HDMI1 / HDMI2 / HDMI3 / HDMI4) by using HDMI cable (p. 97).

Advanced Picture Settings

You can adjust and setup the detailed picture settings for each Viewing Mode.

- To use this function completely, set "Advance(isfcc)" to "On" in the Setup Menu. → p. 35
- For PC input mode, some functions are available without setting "Advance(isfcc)".

- Select the input mode to adjust and setup**
→ p. 16 and p. 28
TV AV
- Display the menu**
MENU
- Select "Picture"**

VIEW Main Menu	
Picture	
Sound	
Setup	
- Select "Viewing Mode" and set the mode**

Picture Menu 1/2	
Viewing Mode	Dynamic
Contrast	
Brightness	
Colour	
Sharpness	
Colour Balance	Warm
Vivid Colour	Off
C.A.T.S.	Off
P-NR	Off
- Select one of the following functions**

Picture Menu 2/2	
Picture Display	On
Advanced Settings	Access
Lock Settings	Access
Copy Adjustment	Access
Reset to Defaults	Reset
- Set**

● "Copy Adjustment" is available when "Viewing Mode" in the Picture Menu is set to "Professional1" or "Professional2".

■ **To return to TV**
EXIT

Lock the picture setting **Lock Settings**

Advanced Settings can be locked for each Viewing Mode.

Additionally, Contrast, Brightness, Colour, Sharpness, Tint and Reset to Defaults in the Picture Menu can be locked for "Professional1" and "Professional2".

"Professional1" and "Professional2" can be locked for each input.

① Enter the PIN number (4 digits)

Lock Settings-PIN Entry
Please enter new PIN
PIN

- Enter the PIN number twice at first setting.
- Make a note of the PIN number in case you forget it.

② Select "Adjustment Lock" and set to "On"

Lock Settings
Change PIN
Adjustment Lock On

■ To change the PIN number Select "Change PIN"

Lock Settings
Change PIN Access
Adjustment Lock On

Enter a new PIN number twice



Adjust the detailed picture settings **Advanced Settings**

- To make settings → “How to Use Menu Functions” ① to ④ (p. 31)

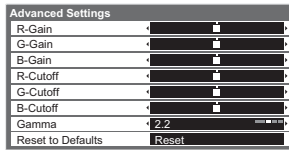

Menu	Item	Adjustments / Configurations (alternatives)	
Picture	Advanced Settings	R-Gain	Adjusts the white balance of bright red area
		G-Gain	Adjusts the white balance of bright green area
		B-Gain	Adjusts the white balance of bright blue area
		R-Cutoff	Adjusts the white balance of dark red area
		G-Cutoff	Adjusts the white balance of dark green area
		B-Cutoff	Adjusts the white balance of dark blue area
		Gamma	Switches the gamma curve (1.8 / 2.0 / 2.2 / 2.4 / 2.6)
		Reset to Defaults	Press the OK button to reset to the default Advanced Settings

■ For the mode of “Professional1” or “Professional2” in “Viewing Mode”

- “Professional1” and “Professional2” can be adjusted and set for each input.

● White Balance

● Colour Management

● Gamma

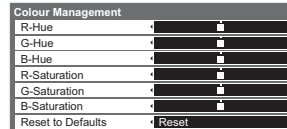
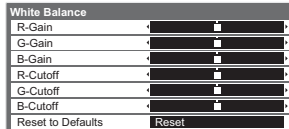
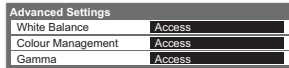

Menu	Item	Adjustments / Configurations (alternatives)		
Picture	Advanced Settings	White Balance	R-Gain	Adjusts the white balance of bright red area
			G-Gain	Adjusts the white balance of bright green area
			B-Gain	Adjusts the white balance of bright blue area
			R-Cutoff	Adjusts the white balance of dark red area
			G-Cutoff	Adjusts the white balance of dark green area
			B-Cutoff	Adjusts the white balance of dark blue area
			Reset to Defaults	Press the OK button to reset to the default White Balance
		Colour Management	R-Hue	Adjusts the picture hue of red area
			G-Hue	Adjusts the picture hue of green area
			B-Hue	Adjusts the picture hue of blue area
			R-Saturation	Adjusts the saturation of red area
			G-Saturation	Adjusts the saturation of green area
			B-Saturation	Adjusts the saturation of blue area
			Reset to Defaults	Press the OK button to reset to the default Colour Management
		Gamma	Gamma	Switches the gamma curve (1.8 / 2.0 / 2.2 / 2.4 / 2.6)
			Reset to Defaults	Press the OK button to reset to the default Gamma

Copy the settings to the other input **Copy Adjustment**

You can copy the selected “Professional1” or “Professional2” settings to that of the other input. The settings of Contrast, Brightness, Colour, Sharpness, Tint and Advanced Settings will be copied.

Select the destination to copy to

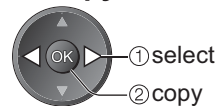

- You cannot copy to the locked mode.

USB HDD Recording

You can record the digital TV programmes to the connected USB HDD and enjoy playing back in various ways.

- Analogue TV programme cannot be recorded to the USB HDD.
- The data broadcasting (MHEG, etc.), radio broadcasting and the periods without any signal will not be recorded.
- Not all the programmes can be recorded depending on the broadcaster and service provider.
- This TV supports USB HDD with capacity from 160 GB up to 2 TB.
- If the remaining capacity of the USB HDD is run out, the recording cannot be done.
- Regarding the performance, not all USB HDDs are guaranteed.

Check the USB HDDs that have been tested for the performance with this TV at the following website. (English only)

<http://panasonic.jp/support/global/cs/tv/>

Caution

- Register the USB HDD with this TV in order to use it for recording. Please note that USB HDD will be formatted and all data (including the data from your PC, etc.) in it will be erased when you register it.
- In order to use the USB HDD with your PC after you use it with this TV for recording, format the drive on your PC. To format, refer to the manual of the PC. Please note that all data in the USB HDD will be erased when it is formatted.
- The data recorded to the USB HDD with this TV can only be played back on this TV. You cannot playback its contents with another TV (including the TV of the same model number) or any PCs.
- If your TV is repaired due to a malfunction, the registered USB HDD may not be available with your repaired TV. Register this USB HDD again to use it with your repaired TV. (All data in it will be erased.)

USB HDD connection

Connect the USB HDD to the USB 1 (rear) or 2 (side) port.

socket outlet

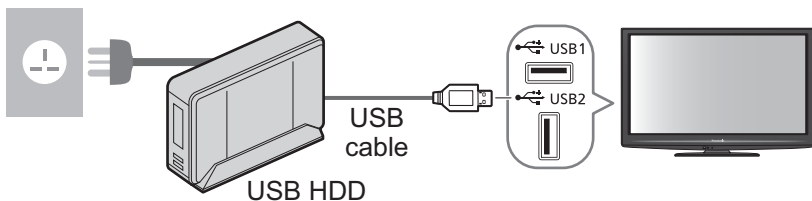

- Be sure to connect the USB HDD to the socket outlet.
- Do not turn off or disconnect the USB HDD during operation. It may cause malfunction of the drive or damage the recorded data.
- To remove the USB HDD safely from the TV → p. 63 and p. 67

Setting for USB HDD

Register and setup the USB HDD with this TV in order to use it for recording. Connect the USB HDD before starting this settings. → “USB HDD connection” (above)

- Before the settings, be sure to turn on the USB HDD.
- You cannot change the settings for the USB HDD while recording is in progress.
- Please note that USB HDD will be formatted and all data in it will be erased when you register it.



1 Display the menu



2 Select “Setup”

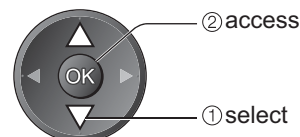
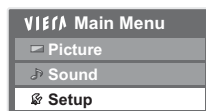

3 Select “USB HDD Setup”

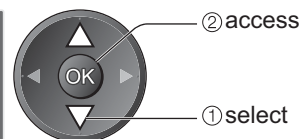
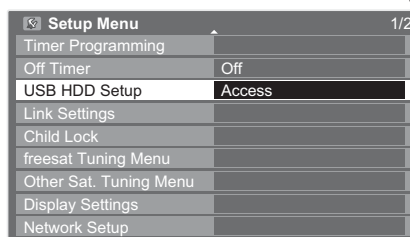

4 Select “Device Setup” and set

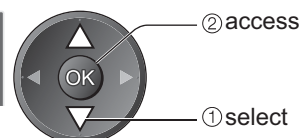
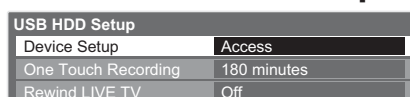

■ To return to TV



Register and setup the USB HDD Device Setup

All the USB devices recognized as a mass storage device will be listed. You can only register USB HDDs.

- Up to 8 USB HDDs can be registered with this TV. However you can only choose one USB HDD for recording at a time.
- Some USB HDD may not be registered.

Select the USB HDD for recording and start registration / setup

Connect	Product	Name	Mode
Yes	USB Drive A		
Yes	USB Flash Disk		

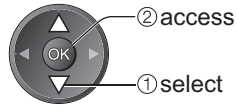

● For the information of the highlighted device →

Caution of USB HDD recording and playing back

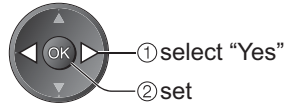
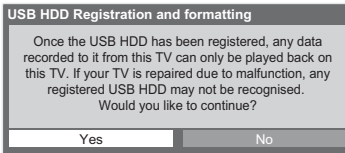

Confirmation of USB HDD registration

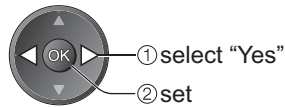
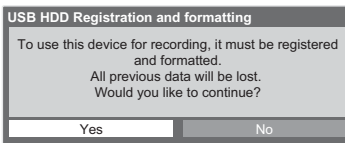

Confirmation of USB HDD format

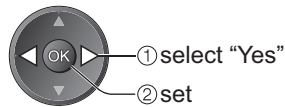
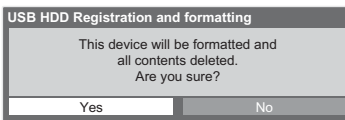

Confirmation of USB HDD name

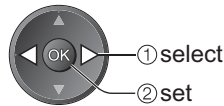
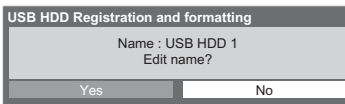

The name for the registered USB HDD is created automatically. If you want to edit the name, select "Yes". Set characters one by one

USB HDD

Name: USB HDD 1

A	B	C	D	E	F	G	H	I	J	K	L	M	N	O	P	Q	R	S	T
U	V	W	X	Y	Z	0	1	2	3	4	5	6	7	8	9				
a	b	c	d	e	f	g	h	i	j	k	l	m	n	o	p	q	r	s	t
u	v	w	x	y	z	()	+/-	*											

Store

BACK/RETURN

● You can set characters by using numeric buttons.
 ➔ "Characters table for numeric buttons" (p. 96)

Confirmation to enable USB HDD for recording

If the registered USB HDD for recording already exists, this confirmation screen will be displayed to switch to enable this USB HDD for recording.



Connect	Product	Name	Mode
Yes	USB Drive A	USB HDD 1	▶
Yes	USB Flash Disk		

- ▶ : The USB HDD is registered and available for recording / playing back if the connection status is "Yes". Only one registered USB HDD on the list can be available for recording.
 - ▶ : The USB HDD is registered and available for playing back if the connection status is "Yes".
 - Name is displayed if the registration is completed
 - Connection status (Yes: connected / No: not connected)
- To remove the USB HDD safely from the TV, ensure the status is "No" before removing.**

- To change the status → yellow
- You can also remove the USB HDD safely from Media Player
 ➔ "Remove the USB devices safely" (p. 67)

To unregister the registered USB HDD

- Once you unregister the USB HDD, it will not be possible to playback any of the recorded content on any TV. Select the USB HDD Unregister



- The confirmation screen will be displayed twice. Select "Yes" to unregister.

USB HDD Recording

Recording the TV programme to USB HDD

You can record the current programme immediately by using “One Touch Recording”. You can also record the current programme constantly for the selected period by using “Rewind LIVE TV” so that you can go back or pause the current programme.

- Ensure the connection, registration and setup are completed before start recording ➔ p. 62 and p. 63
- Ensure not to connect or disconnect any USB devices during USB HDD recording. Otherwise the recording may not work properly.



1 Display the menu
MENU



2 Select “Setup”

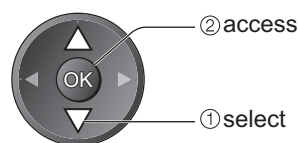
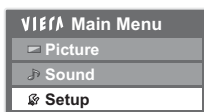

3 Select “USB HDD Setup”

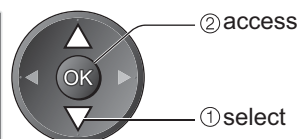
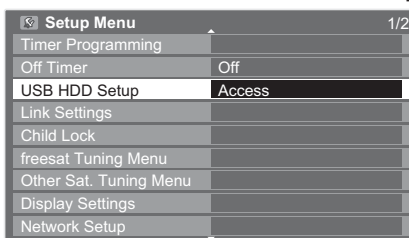

4 Select “One Touch Recording” or “Rewind LIVE TV”

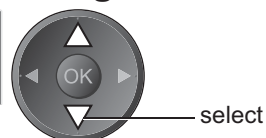
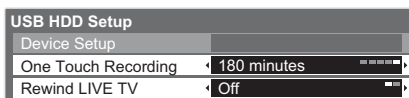

■ To return to TV



5 Set

One touch direct TV recording - What you see is What you record One Touch Recording

Recording the current programme in the USB HDD immediately.
Select the maximum recording time (30 / 60 / 90 / 120 / 180 minutes)

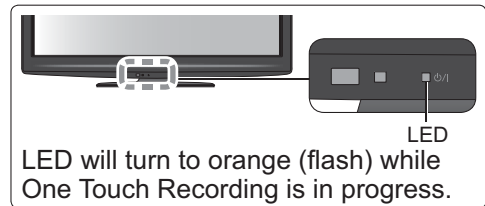
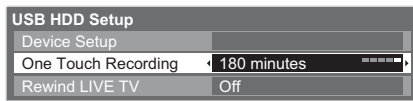

■ To start One Touch Recording

Set the position to "TV" Start



- No other channel can be selected while the recording is in progress.

■ To stop recording on the way



■ To playback or delete the recorded contents

- ➔ "Using Media Player" (p. 71) or "Video" in VIERA TOOLS (p. 30)
- Even if One Touch Recording is in progress, you can playback all the contents. However, the recording may not work properly while playback.

Record constantly Rewind LIVE TV

Recording the current programme constantly.

- This function will not work on MHEG Linked services, i.e. ITV HD and BBC Multiscreen.

Select "On" to start Rewind LIVE TV

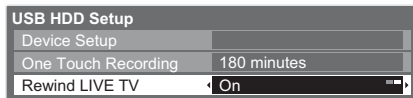

- When you select "On", the recording will start automatically.

■ To operate the Rewind LIVE TV

Set the position to "TV"



- To pause ➔
- To search backward ➔ (press and hold for about a second)
- After pausing or searching backward, the following buttons are available to operate.

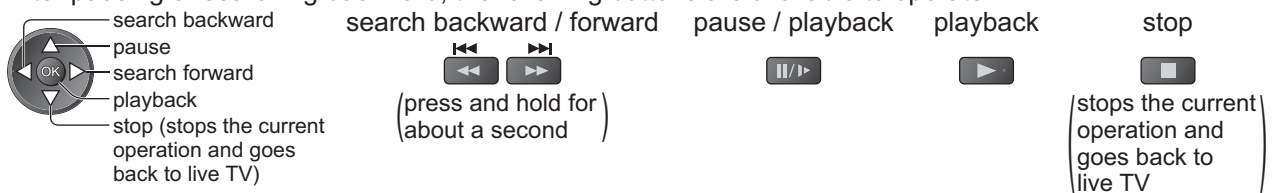

■ To stop the Rewind LIVE TV

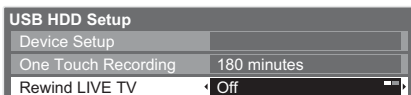

- If you stop the Rewind LIVE TV, the recorded content for the Rewind LIVE TV will be deleted.

- Rewind LIVE TV will be stopped and the recorded content deleted automatically in the following conditions: (Even if Rewind LIVE TV stops for the following conditions, as long as the setting is "On", the new recording will start automatically in a condition that makes the recording available.)
 - selected other channels
 - selected locked channel
 - selected invalid channel
 - no TV signal
 - when the other recording starts
 - when the TV is turned off or standby

Using Media Player

Media Player allows you to enjoy photo, video or music recorded on an SD Card and a USB Flash Memory, and recorded contents on the registered USB HDD.

VIERA IMAGE VIEWER is the function of the easy viewing for photos or videos recorded on an SD Card on the TV screen by simply inserting into the SD Card slot.

Photo mode : Still pictures recorded by digital cameras will be displayed.

Video mode : (For SD Card or USB Flash Memory) Moving pictures recorded by digital video cameras will be played back.
(For registered USB HDD) TV programmes recorded in USB HDD registered to this TV will be played back.

Music mode : Digital music data will be played back.

- During the operation, audio signal is output from AV1, AV2, AUDIO OUT and DIGITAL AUDIO OUT terminals, but no video signals are output. AV1 and AV2 can output audio signal if "AV1 / AV2 out" is set to "Monitor" in the Setup Menu (p. 34).
- "Date" shows the date on which the recording was made by the recording equipment. The file without record of the date is shown "***/**/*****".

■ Data format for SD Card / USB Flash Memory browsing

- Photo : Still images recorded with digital still cameras compatible with JPEG files of DCF* and EXIF standards
Data format - Baseline JPEG (Sub-sampling 4:4:4, 4:2:2 or 4:2:0)
Image resolution - 8 × 8 to 30,719 × 17,279 pixels
- Video : SD-Video Standard Ver. 1.2 [MPEG-2 (PS format)] and AVCHD Standard compatible files with an audio format that is either MPEG-1/Layer-2 format or Dolby Digital format
(A modified data with a PC may not be displayed correctly.)
DivX → p. 95
- Music : Data format - MP3 and AAC (Copy-protected files cannot be played back.)
- SD Card format : SDXC Card - exFAT
SDHC Card / SD Card - FAT16 or FAT32
- Compliant card type (maximum capacity): SDXC Card (64 GB), SDHC Card (32 GB), SD Card (2 GB), miniSD Card (2 GB) (requiring miniSD adapter)
- If miniSD Card is used, insert / remove it together with the adapter.
- Check the latest information on the card type at the following website. (English only)
<http://panasonic.jp/support/global/cs/tv/>
- USB Flash Memory format : FAT16, FAT32 or exFAT
(A USB HDD formatted by PC is not supported in Media Player.)

*DCF (Design rule for camera file system): Unified standard established by Japan Electronics and Information Technology Industries Association (JEITA).

Note

- Format the device with the recording equipment.
- The picture may not appear correctly on this TV depending on the recording equipment used.
- Display may take some time when there are many files and folders.
- This function cannot display Motion JPEG or still images that are not JPEG format (i.e. TIFF, BMP).
- Data modified with a PC may not be displayed.
- Images imported from a PC must be compatible with EXIF (Exchangeable Image File) 2.0, 2.1, and 2.2.
- Partly degraded files might be displayed at a reduced resolution.
- The folder and file names may be different depending on the digital camera or digital video camera used.
- Do not use two-byte characters or other special codes.
- The device may become unusable with this TV if the file or folder names are changed.

■ To insert or remove the SD Card / USB Flash Memory

- For the USB HDD Connection → p. 62

USB Flash Memory

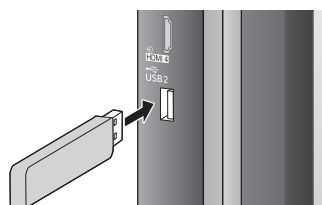

- Insert or remove straightly and completely.
- Before removing the USB Flash Memory, ensure to perform "Remove the USB device safely" (p. 67)



SD Card

- To insert the SD Card

Gently insert the SD Card label surface facing front.

Push until a click is heard

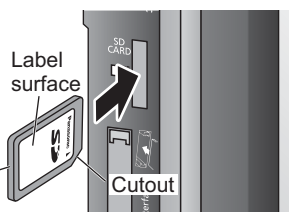

- To remove the SD Card

Push the centre of the card

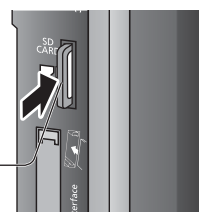

- For more information of the SD Card → p. 94

Starting Media Player



- 1 Insert the SD Card or USB Flash Memory**
 - For registered USB HDD, ensure the connection status is "Yes". → p. 63
- 2 Switch to Media Player**
 - SD CARD
 - When SD Card is inserted, switching will be done automatically.

- 3 Start Media Player**
 - Media Player
 - Signal output from all AV terminals will be disabled during Media Player view. Press OK to proceed. Press EXIT to return to TV viewing.

- 4 Select the icon you want to access to**
 - Media Player
 - Drive Select
 - selected device name
 - select
 - access
 - If two or more devices are not connected, this step will be skipped.
 - For the registered USB HDD, all the USB HDD of which the connection status is "Yes" is available.
 - "Register and setup the USB HDD" (p. 63)

- 5 Select the content**
 - Media Player
 - Contents Select
 - Photo
 - Video
 - Music
 - select
 - access
 - For registered USB HDD, this step will be skipped and recorded contents list will be displayed. → p. 71
 - Photo → "Photo mode" (p. 68)
 - Video → "Video mode" (p. 70)
 - Music → "Music mode" (p. 73)

■ To return to TV



■ To return to the previous screen



Change the device

You can change to the other device directly in the same mode if two or more devices are connected.

Display the menu → Select "Drive Select" → Select the icon you want to access to

Appears if the USB device is connected to the TV.

Remove the USB devices safely

Before remove the USB devices, please take the following steps in order to protect the devices.

Display the menu → Select "Safely remove USB" → Select the USB Flash Memory or USB HDD to remove

Appears if the USB device is connected to the TV.

Product	Name
USB Flash Disk	

Using Media Player

Photo mode

Photo mode will read all ".jpg" extension files in the SD Card or USB Flash Memory.

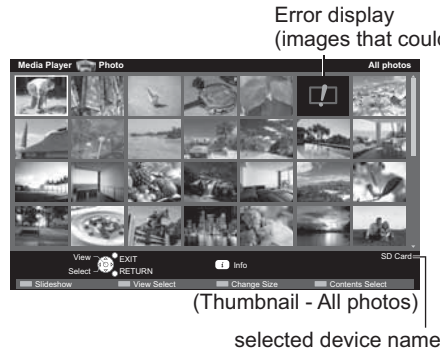

The thumbnail of all the photos on the SD Card or USB Flash Memory will be displayed.

- You can also access Photo mode directly by using VIERA TOOLS.

- "How to Use VIERA TOOLS" (p. 30)

- To change the background music

- "Photo Setup" (p. 69)

- To display the information of the highlighted photo

- File name 1/48 — file number / total file number

Date 23/10/2009
Size 1600X1200

- To change the number of photos on a thumbnail screen at a time

- yellow (7 × 4 ↔ 10 × 6)

■ To sort by folder, recorded date or recorded month

Folder view : Displays the thumbnail grouped by folder

- The files which are not into a folder will be collected to the folder named "/".

Sort by Date : Displays the thumbnail grouped by the same date

- The group of the photos without recorded date is shown as "Unknown".

Sort by Month: Displays the thumbnail grouped by the same month

- The group of the photos without recorded date is shown as "Unknown".

Display the view selection



Select the sort type

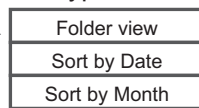

Select one of the sorted group to display the thumbnail of the selected group

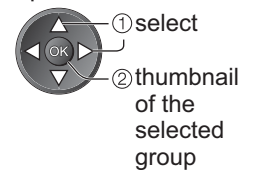
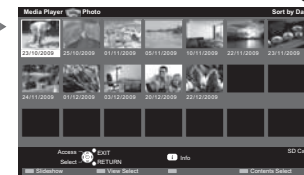

- To return to the thumbnail of all photos



- To display the information of the highlighted group

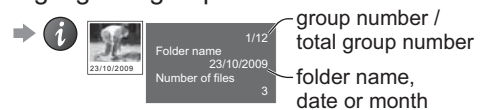

■ To return to TV



■ To return to the previous screen



■ Single view - Photos are displayed one at a time.

Select the file from the thumbnail of photos to be viewed

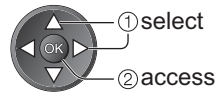

Operation guide

- To display / hide the operation guide



- To operate Single view

- To the previous photo

- Rotate 90° (anti-clockwise)

- To the next photo

- Slideshow

- Rotate 90° (clockwise)

- To return to thumbnail →

■ Slideshow - Slideshow will complete when all photos have been viewed within the present thumbnail.

Select the file from the thumbnail of photos for the first view



Start Slideshow



- To display / hide the operation guide →

- To pause (return to Single view) →

- To return to thumbnail →

Note

- Picture quality may become lower depending on the slideshow settings.

- Picture setting may not work depending on the slideshow settings.

Photo Setup

Choose the settings for Photo mode.

Display the menu

MENU

Select "Photo Setup"

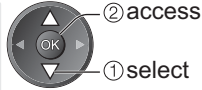
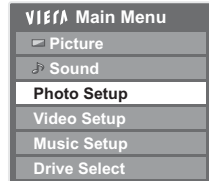

Select the items and set

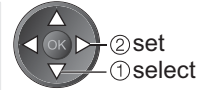
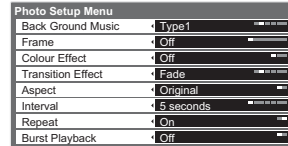

● Other items → p. 32, 33, 67, 72 and p. 73

Menu	Item	Adjustments / Configurations (alternatives)
Photo Setup	Back Ground Music	<p>Selects the back ground music during the Photo mode (Off / Type1 / Type2 / Type3 / Auto / User)</p> <ul style="list-style-type: none"> ● Type1, Type2 and Type3 are the fixed music each installed in this TV. Auto : Music data stored in the root folder of the SD Card will be played back randomly. <ul style="list-style-type: none"> ● If there is no available music data, no sound will be produced. User : Music data in the current device registered by yourself in Music mode will be played back. <ul style="list-style-type: none"> ● To register the music → "Set background music for Photo mode" (p. 68) ● If no music has been registered or the registered music device are removed, no sound will be produced.
	Frame	<p>Selects the frame type of the slideshow (Off / Multi / Collage / Drift (+ calendar) / Drift / Gallery (+ calendar) / Gallery / Cinema)</p> <p>Multi : 9 photos are displayed orderly at once. Collage : Each photo is displayed at a random position and random scale. Drift (+ calendar) / Drift : Photos are displayed like flow images. <ul style="list-style-type: none"> ● You can select to display the calendar or not. The month of calendar is turned by pressing up or down cursor button. Gallery (+ calendar) / Gallery : The various size of photos in the frame are displayed. <ul style="list-style-type: none"> ● You can select to display the calendar or not. The month of calendar is turned by pressing up or down cursor button. Cinema : Photos are displayed like old films (sepia tone)</p>
	Colour Effect	<p>Selects the colour effect of photos on Single view and Slideshow (Off / Sepia / Gray scale)</p> <ul style="list-style-type: none"> ● This function is not available when "Frame" is set to "Drift", "Gallery" or "Cinema".
	Transition Effect	<p>Selects the transition effect for switching the photo during the slideshow (Off / Fade / Slide / Dissolve / Motion / Random)</p> <p>Fade : The next photo fades in gradually. Slide : The next photo slides and appears from the left side. Dissolve : Each photo is dissolved when switching to the next photo. Motion : Each photo is displayed with an effect of enlarging, reducing, moving up or moving down. Random : Each transition is selected at random. <ul style="list-style-type: none"> ● This function is available when "Frame" is set to "Off". </p>
	Aspect	<p>Selects whether enlarged or original viewing on Single view and Slideshow (Original / Zoom)</p> <ul style="list-style-type: none"> ● This function is not available when "Frame" is set to "Collage", "Drift", "Gallery" or "Cinema". ● This function is not available when "Transition Effect" is set to "Motion". ● Depending on the photo size, it may not be fully enlarged to fill the screen, e.g. portrait style picture.
	Interval	<p>Selects slideshow interval (5 / 10 / 15 / 30 / 60 / 90 / 120 seconds)</p> <ul style="list-style-type: none"> ● This function is not available when "Frame" is set to "Drift", "Gallery" or "Cinema". ● This function is not available when "Transition Effect" is set to "Motion".
	Repeat	<p>Slideshow repeat (Off / On)</p>
	Burst Playback	<p>Selects whether the continuous shots are displayed in rapid interval during the slideshow (Off / On)</p> <ul style="list-style-type: none"> ● This function is not available when "Frame" is set to "Drift", "Gallery" or "Cinema". ● This function is not available when "Transition Effect" is set to "Motion".

Change the contents

You can switch to the other mode of the Media Player from the thumbnail view.

- The mode can be switched in the current device.
- To change the device → "Change the device" (p. 67)

While the thumbnail is displayed, display the contents selection

blue



Select the contents



- Photo → "Photo mode" (p. 68)
- Video → "Video mode" (p. 70)
- Music → "Music mode" (p. 73)

Using Media Player

Video mode

For SD Card or USB Flash Memory

Video mode supports AVCHD, MPEG2 and DivX® file formats.



Film icon will be displayed if the file does not support thumbnail view.

Error display (Images that could not be loaded, etc.)

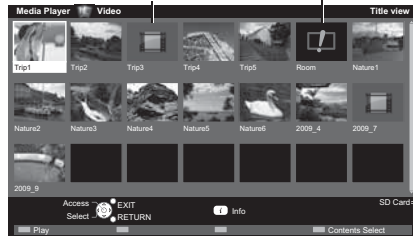

(Thumbnail - Title view)

The thumbnail of video titles on the SD Card or USB Flash Memory will be displayed.

The preview will start when the title is highlighted if it supports a preview.

● You can also access Video mode directly by using VIERA TOOLS

➔ "How to Use VIERA TOOLS" (p. 30)

● To turn off the preview ➔ "Video Setup" (p. 72)

● To display the information of the highlighted title

➔ file format
title number / total title number

■ Playback from Title view

Playback of the selected title will start.

Select the title Start playback



● DivX contents cannot be played back from Title view. Select DivX folder and press the OK button to display DivX files, and then select one of the file to be played back.

■ Playback from the selected scene in the title (AVCHD or MPEG2)

Playback will start from the selected scene to the end of the title.

Select the title Select the scene to start playback

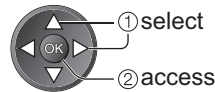

(Thumbnail - Scene view)

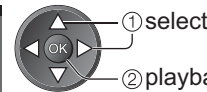

The preview will start when the scene is highlighted if it supports a preview.

● To turn off the preview

➔ "Video Setup" (p. 72)

● To repeat playback
➔ "Video Setup" (p. 72)

● To display the information of the highlighted scene

➔ file format
scene number / total scene number

■ To return to TV

➔ EXIT or SD CARD

■ To return to the previous screen

➔ BACK/RETURN

Note

● The structure of titles and scenes may vary depending on the digital video camera used.

■ How to operate in the playback

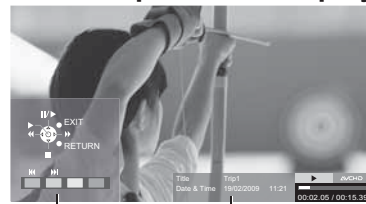

(Playback)

● To change aspect (only for the 4:3 video content)

➔ ASPECT

● To return to thumbnail ➔

● You can also use the following buttons. (p. 29)

Set the position to "TV"



● To confirm or change the current status (if available)

Example:

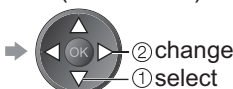

■ To change the content in the current device

➔ "Change the contents" (p. 69)

● To display / hide the operation guide and information banner ➔

● To operate the playback

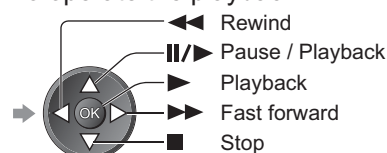

● To the previous scene ➔ red

● To the next scene ➔ green

For registered USB HDD

Remaining capacity of the HDD

● This value may not be accurate depending on the condition.



Contents list of the registered USB HDD will be displayed.

● You can also access the contents list directly by using VIERA TOOLS.

➔ “How to use VIERA TOOLS” (p. 30)

● To display the information of the highlighted content

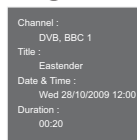

Content under recording

● You can playback this content even if under recording.

Content not played back

● Once you playback the content, this icon will disappear.

Appears when the recorded content has the guidance information (parental rating, etc.) or the channel of the content is restricted by Child Lock. This content requires entering PIN number to playback.

■ Playback the content from the list

Select the content

Start playback



■ Delete the selected content

Select the content

Delete the content

Confirm



■ How to operate in the playback

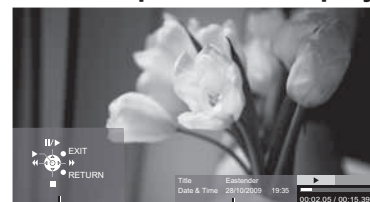

Operation guide

(Playback)

Information banner

● To display / hide the operation guide and information banner



● To operate the playback

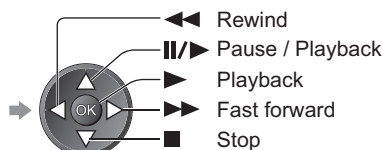

● To change aspect ➔ ASPECT



● To display the subtitle (if available) ➔ STTL



● To return to list ➔ BACK/RETURN



● You can also use the following buttons. (p. 29)

Set the position to “TV”



(press and hold)

● To confirm or change the current status (if available) ➔



Example:



Note

● Depending on the recorded programmes, some playback operations may not work properly.

Using Media Player

Sound Settings

You can enjoy the multi-channel sound via an amplifier connected to DIGITAL AUDIO OUT terminal.

■ **To confirm or change the current sound status** (during playback)

Display the Option menu

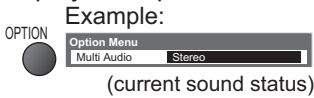

Change the sound (if the video has multiple audio signals)



● It may take several seconds to change the sound.

■ Audio output settings

Display the menu



Select "Sound"

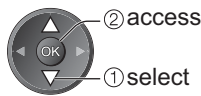

Select "SPDIF Selection" and set

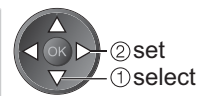
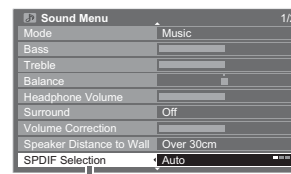

Menu	Item	Adjustments / Configurations (alternatives)
Sound	SPDIF Selection	SPDIF : A standard audio transfer file format Selects the initial setting for digital audio output signal from DIGITAL AUDIO OUT terminal (Auto / PCM) Auto: Dolby Digital is output as Dolby Digital Bitstream. MPEG is output as PCM. PCM: Digital output signal is fixed to PCM.

Video Setup

Choose the settings for Video mode.

● These settings are not available for the registered USB HDD.

Display the menu



Select "Video Setup"



● Other items
 ➔ p. 32, 33, 67, 69 and p. 73

Select "Other Settings"

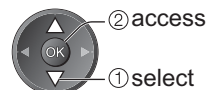

● Display Settings
 ➔ p. 35

Select the items and set

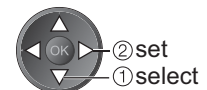
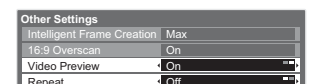

● Other items
 ➔ p. 36

Menu	Item	Adjustments / Configurations (alternatives)
Video Setup	Other Settings	Video Preview Sets to start the preview of the title or scene in the thumbnail screen (Off / On) ● Image may not be displayed for an instant in the thumbnail screen. Set the preview "Off" to resolve this.
		Repeat Playback repeat within the title (Off / On) ● Only the selected file will be repeated for DivX contents.

Music mode

Music mode supports MP3 and AAC file format.

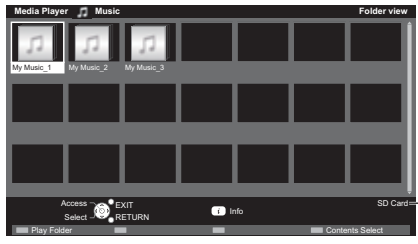

The thumbnail of music folders in the SD Card or USB Flash Memory will be displayed.

● You can also access Music mode directly by using VIERA TOOLS

➔ “How to use “VIERA TOOLS” (p. 30)

● To display the information of the highlighted title

➔ Folder name 1/3 — folder number / total folder number
Number of files My Music_1 11

selected device name

■ Playback from Folder view

Playback all the files in the selected folder will start.

Select the folder Start playback



■ Playback from File view

Playback of the selected file will start.

Select the folder Select the file to start playback



■ To return to TV



■ To return to the previous screen



■ How to operate in the playback

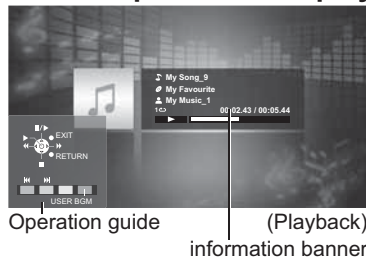

● To display / hide the operation guide and information banner



● To operate the playback

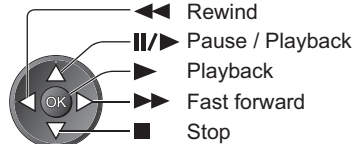

● To the previous track



● To the next track



● To return to thumbnail



■ To change the content in the current device

➔ “Change the contents” (p. 69)

Music Setup

Setup the setting for Music mode.

Display the menu

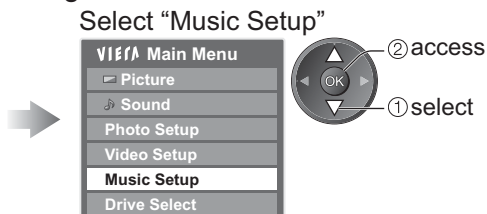

Set

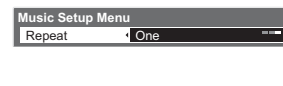

Folder : Playback repeat within the selected folder
One : Playback repeat of the selected one file

Set background music for Photo mode

You can register your favourite music as background music for Photo mode.

● Select “User” in “Back Ground Music” ➔ “Photo Setup” (p. 69)

● If you remove the device in which the registered music is stored, the setting of “User” will be reset.

While playing music, display the selection screen



Select “File” or “Folder” and set

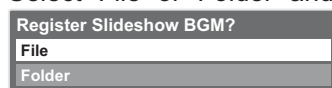

File : The current music will be registered as back ground music.
Folder : All the music in the current folder will be registered as back ground music.

Using Network Services

(DLNA / VIERA CAST / freesat)

DLNA®

This TV is a DLNA Certified™ product.

DLNA (Digital Living Network Alliance) is a standard that makes DLNA Certified digital electronics easier and more convenient to use on a home network. To learn more, visit www.dlna.org.

It allows you to share photos and videos stored in the DLNA Certified media server (for example, PC with windows 7 installed, DIGA Recorder etc.) connected to your home network, and enjoy watching them on the TV screen.

■ Applicable data format

Photo : JPEG (Sub-sampling 4:4:4, 4:2:2 or 4:2:0)

Image resolution - 8 × 8 to 30,719 × 17,279 pixels

- MOTION JPEG and Progressive JPEG are not supported.

Video : MPEG-2 (PS format and TS format)

- AVCHD and DivX files are not supported by DLNA, but can be played by Media Player (p. 70).

- Music files are not supported by DLNA, but MP3 and AAC files can be played back by Media Player (p. 73).

■ Media server

Ensure the connected equipment has a DLNA Certified media server.

To use the PC, install the server software on the PC for obtaining a media server.

Store photos or videos into the media server, and then you can watch them on the TV.

“TwonkyMedia server 5.1.x” and “Windows 7” are the server software that has been tested for the performance with this TV (current as of January, 2010).

For installing, read the manual of the server software.

- The DLNA control function of Windows 7 is not supported with this TV.

- When a server software for the media server is installed on the PC, the data may be at risk of being accessed by other people. Please take care of the settings and connections under the network circumstances at the office, hotel or even at home when not using a router.

By connecting a DLNA compatible DIGA Recorder to your home network, you can enjoy and control it as one of the media servers.

- For details, read the manual of the DIGA Recorder.

■ Network connection

- ➔ Example 1 or Example 2 in “Network connections” (p. 75)

■ Network setup

- ➔ p. 76 - 79

■ DLNA operations

- ➔ p. 80 - 82

VIERA CAST™

VIERA CAST is a gateway to the internet services unique to Panasonic.

By connecting the TV to the internet environment, VIERA CAST allows you to enjoy internet content on the TV screen such as photos, videos, weather, etc. from VIERA CAST home screen.

You can access VIERA CAST home screen directly by pressing the VIERA CAST button on the remote control.

■ Network connection

- ➔ Example 1 or Example 3 in “Network connections” (p. 75)

■ Network setup

- ➔ p. 76 - 79

■ VIERA CAST operations

- ➔ p. 83

freesat

freesat will give you access to the great interactive services and features through an internet connection.

- Please contact broadcasters for availability of services.

Network connections

To use only DLNA features, you can operate the features without Broadband network environment. To use VIERA CAST features or freesat interactive services, you need a Broadband network environment.

- If you do not have a Broadband network services, please consult your retailer for assistance.
- Confirm the terms and conditions of the contracts with your Internet Service Provider (ISP) or telecommunications company.
- Set up and connect any equipment required for the network environment.
- Required speed (effective): at least 1.5 Mbps for SD and 6 Mbps for HD picture quality, respectively.
- Read the manual of the network equipment, too.

Example 1

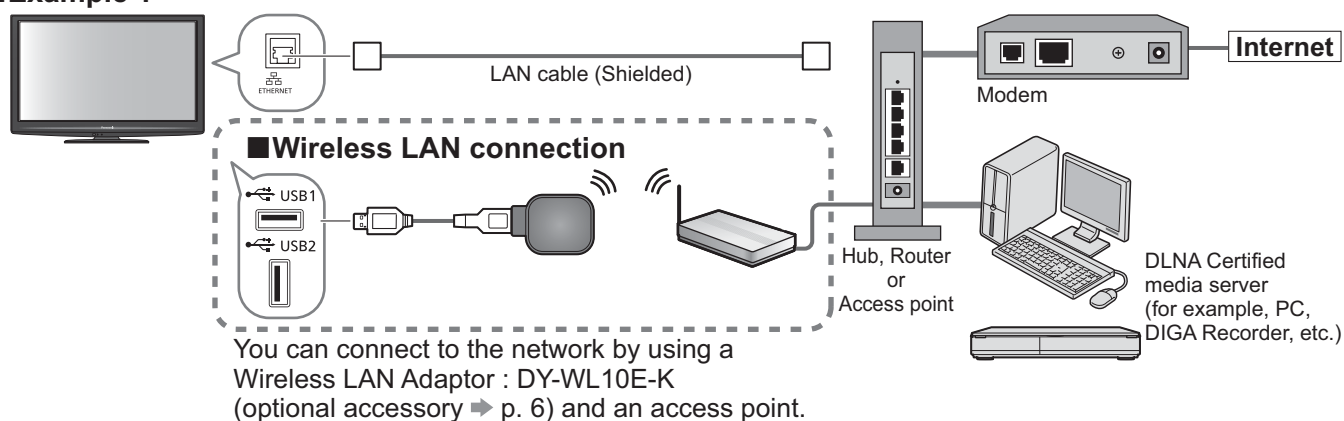

- Ensure to use a LAN straight cable for this connection.
- If your modem has no broadband router functions, use a broadband router.
- If your modem has broadband router functions but there are no vacant ports, use a hub.
- Ensure that the Broadband routers and hubs are compatible with 10BASE-T / 100BASE-TX.
- If you use the equipment compatible only with 100BASE-TX, category 5 LAN cables are required.

Example 2

You can connect the TV and the equipment directly to use DLNA features.

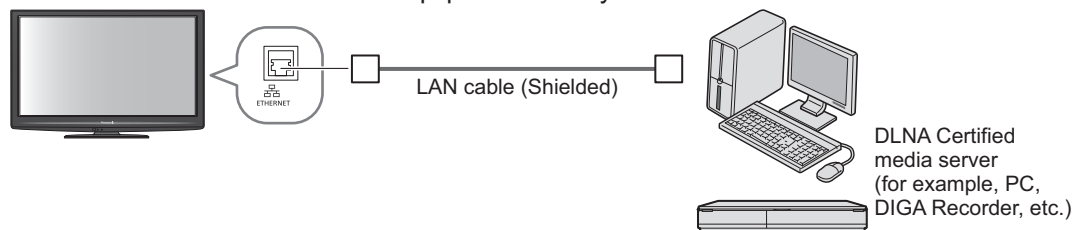

- Ensure to use a LAN cross cable for this connection.

Example 3

You can connect the TV and the telecommunication equipment directly to use VIERA CAST features.

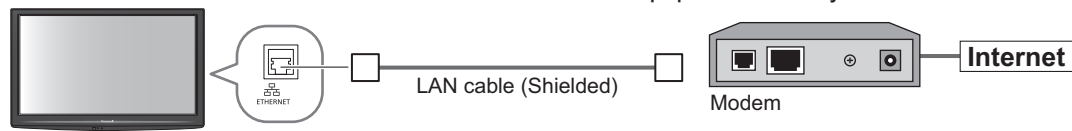

Note

- Depending on the ISP or telecommunications company, the required equipment and the internet connection procedure are different. Ensure that you use the network equipment that are authorized by your ISP and telecommunications company.
- You cannot make settings for the network equipment on this TV. You may be required to make settings on your computer.
- Depending on the terms and conditions of the contracts with your ISP or telecommunications company, additional fees may be charged or multiple connections to the internet may be impossible.
- Please contact your ISP or telecommunications company if you require further assistance regarding the network equipment.

Using Network Services

(DLNA / VIERA CAST / freesat)

Network Setup

- Ensure the connections are completed before starting Network Setup.
 - ➔ "Network connections" (p. 75)



1 Display the menu
MENU

2 Select "Setup"

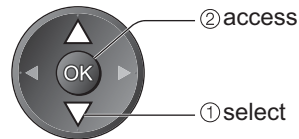
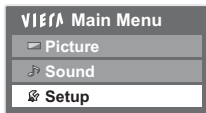

3 Select "Network Setup"

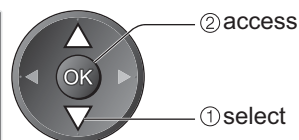
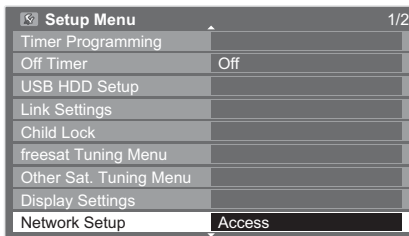

■ To return to TV
EXIT

4 Set

Edit the name of this TV

You can set your favourite name for this TV. This name will be used to display the name of this TV on the screen of the other DLNA compatible equipment.

Select "VIERA Name"

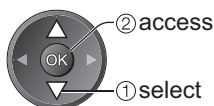
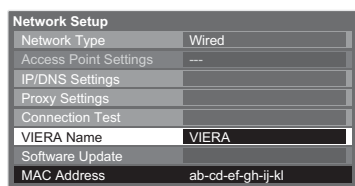

Edit the name
Set characters one by one

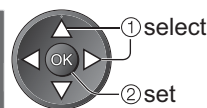
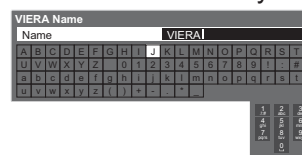

Store
BACK/RETURN

- You can set characters by using numeric buttons.
 - ➔ "Characters table for numeric buttons" (p. 96)

Update TV's software

Accesses the specific web site to update TV's software and search if any software updates are available.

Select "Software Update"

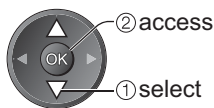
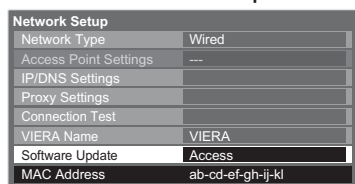

- Follow the on screen instructions

Note

MAC Address

- MAC address is a unique address that identifies hardware in the network. (for information only)

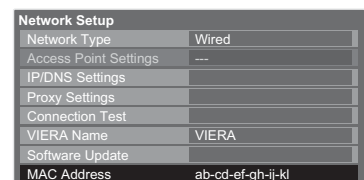

Network settings for the LAN Cable connection

This setting is for the network connection by using the LAN cable.

① Select "Network Type" and set to "Wired"

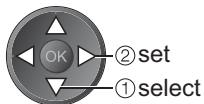
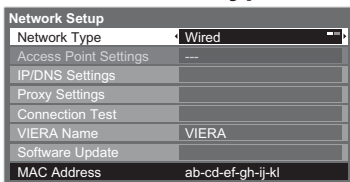

If you make the network connection like "Example2" (p. 63), you do not have to set "Acquire DNS Address", "Proxy" and "Proxy Port".

② Select "IP/DNS Settings" and set the items

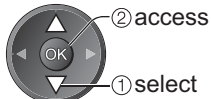
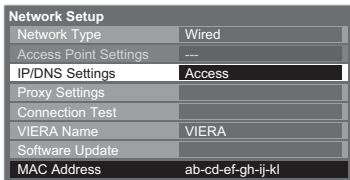

After settings, return to "Network Setup" screen →

■ Acquire IP Address

■ Acquire DNS Address

Sets IP Address, Subnet Mask, Gateway, Primary DNS and Secondary DNS.

For most users, the recommended method of connection to your network is by using Auto feature.

Select "Acquire IP Address" and then set to "Auto"

Select "Acquire DNS Address" and then set to "Auto"

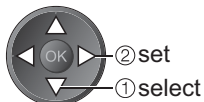
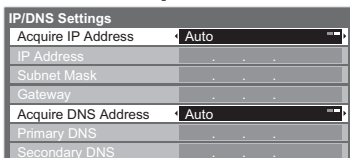

- The available settings are displayed automatically.

Manual settings

If you wish to set these functions manually, select "Manual".

Select "IP Address", "Subnet Mask", "Gateway", "Primary DNS" or "Secondary DNS"

Move the cursor and enter the number



③ Select "Proxy Settings" and set the items

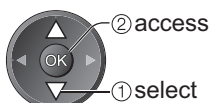
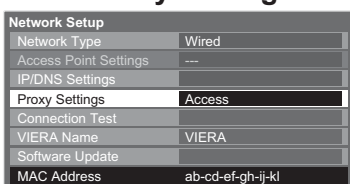

After settings, return to "Network Setup" screen →

■ Proxy

Sets Proxy address.

- This is the address of the relay server that is connected to the target server instead of the browser and sends data to the browser. Setting is required if specified by the provider.

Select "Proxy"

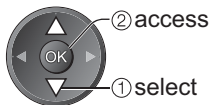

Enter the address

Set characters one by one

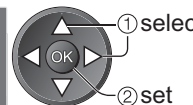
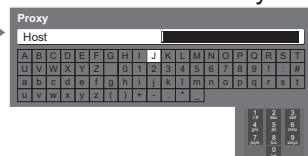

Store



- You can set characters by using numeric buttons.
 - ➔ "Characters table for numeric buttons" (p. 96)

■ Proxy Port

Sets Proxy port number.

- This number is also specified by the provider with the Proxy address.

Select "Proxy Port"



Move the cursor and enter the number

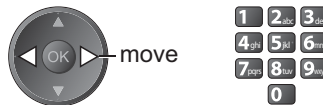

④ Select "Connection Test" and access to test

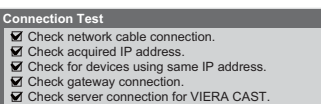
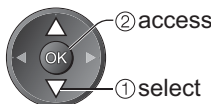
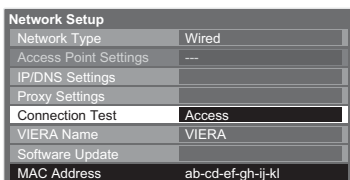

- : **succeeded**
The test is successful and the TV is connected to the network.
- : **failed**
Check the settings and connections, and then perform this function again.

Performs automatic testing of the network connection for the TV. (It takes a while to test.)

Using Network Services

(DLNA / VIERA CAST / freesat)

Network settings for the Wireless LAN connection

This setting is for the network connection by using Wireless LAN Adaptor. (Wireless LAN connection)

① Select "Network Type" and set to "Wireless"

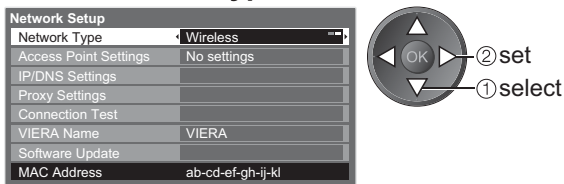

② Select "Access Point Settings"

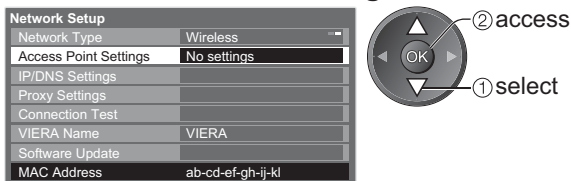

③ Select the connection type and set

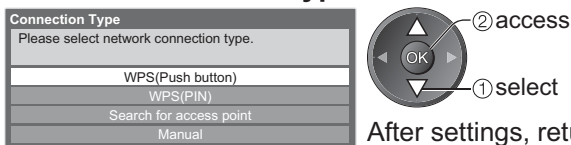

● For details of each connection type → p. 79

After settings, return to "Network Setup" screen →

④ Confirm the connection status of "Access Point Settings"

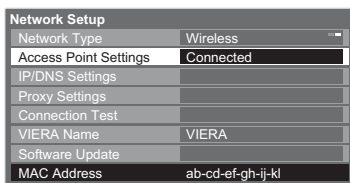

- : "Wired" is selected in "Network Type".
- No adaptor : Wireless LAN Adaptor is not connected.
- No settings : Setting for connecting to the access point has not been set.
- Connecting... : Connecting to the access point in progress.
- Connected : Wireless LAN connection to the access point succeeded.
 - To display the current access point settings, press the OK button.
 - To change the settings, select "No" on this screen.
 - Some access points do not allow access to the internet. Perform "Connection Test" (below) to check if internet connection is available.

USB overcurrent : Overcurrent error → p. 101

⑤ Select "Connection Test" and access to test

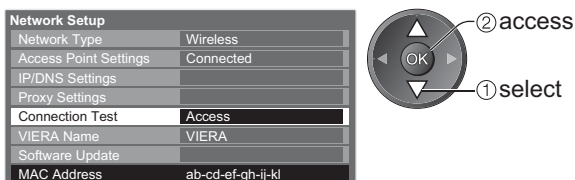

Performs automatic testing of the network connection for the TV. (This may take some time.)

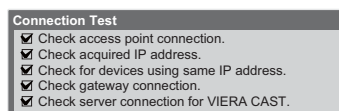

- : **succeeded**
The test is successful and the TV is connected to the network.
- : **failed**
Check the settings and connections, and then perform this function again.
If you continue to have difficulty, please contact your internet service provider.

WPS(Push button)

WPS(Push button)
 1) Please press the 'WPS' button on the access point until its light flashes.
 2) When light is flashing select 'Connect' on TV.
 If you are unsure, please check the instruction manual of the access point.

Connect

Press the WPS button on the access point until the light flashes. And then, press the OK button to connect the Wireless LAN Adaptor and the access point.



- Ensure that your access point supports WPS for this setup.
- WPS: Wi-Fi Protected Setup

Search for access point

Access points found automatically are listed.

No.	SSID	Wireless type	Encrypt	Description
1	Access Point A	11n(5GHz)	<input checked="" type="checkbox"/>	
2	Access Point B	11n(5GHz)	<input type="checkbox"/>	
3	Access Point C	11n(5GHz)	<input type="checkbox"/>	

Select your desired access point

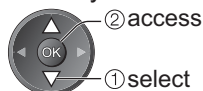

: Encrypted access point

- To search access points again → yellow
- For the information of the highlighted access point → i
- To set manually → red

Encryption Key Setting
 Connection will be made with the following settings:-
 SSID : Access Point A
 Authentication type : WPA-PSK
 Encryption type : TKIP
 Please input the encryption key.

Encryption key

Access the encryption key input mode



- If the selected access point is not encrypted, the confirmation screen will be displayed. It is recommended to select the encrypted access point.

Access Point Settings
 Encryption key

A	B	C	D	E	F	G	H	I	J	K	L	M	N	O	P	Q	R	S	T
1	2	3	4	5	6	7	8	9	0	*	#	!	@	#	\$	%	&	'	(
~	^	&	*	()	+	=	<	>	?	~	~	~	~	~	~	~	~	~

Enter the encryption key of the access point

Set characters one by one



- You can set characters by using numeric buttons.
 → "Characters table for numeric buttons" (p. 96)

Access Point Settings
 Encryption key is set to:-
 XXXXXXXX
 Select 'Yes' to confirm.
 Select 'No' to change.

Yes No

Select "Yes"



- To re-enter the encryption key, select "No".

WPS(PIN)

No.	SSID	Wireless type	Encrypt	Description
1	Access Point A	11n(5GHz)	<input checked="" type="checkbox"/>	
2	Access Point B	11n(5GHz)	<input type="checkbox"/>	
3	Access Point C	11n(5GHz)	<input type="checkbox"/>	

Select your desired access point



- Ensure that your access point supports WPS for this setup.
- To search access points again → yellow
- For the information of the highlighted access point → i
- To set manually → red

WPS(PIN)
 Please register the following PIN codes on the access point.
 PIN code : 12345678
 Select 'Connect' after entering and saving settings on the access point.

Connect

Enter the PIN code to the access point, and then select "Connect"



Manual

You can setup SSID, authentication type, encryption type, and encryption key manually. Follow the on screen instructions and set manually.

- When you use 11n (5GHz) for the wireless system between the Wireless LAN Adaptor and access point, please select "AES" for the encryption type.

Access Point Settings
 Please input the SSID.

SSID

XXXXXXXX

SSID Setting
 SSID is set to:-
 XXXXXXXX
 Select 'Yes' to confirm.
 Select 'No' to change.

Yes No

Authentication Type Settings
 Connection will be made with the following settings:-
 SSID : XXXXXXXX
 Please select the authentication type.

WPA2-PSK
 WPA-PSK
 Shared key
 Open

Using Network Services

(DLNA / VIERA CAST / freesat)

Using DLNA® features

- Ensure the preparation of media server, network connections and network settings are completed.
 - ➔ “Media server” (p. 74), “Network connections” (p. 75), “Network Setup” (p. 76 - 79)

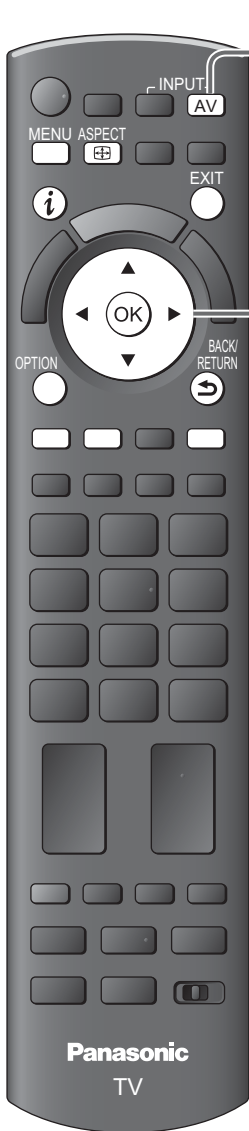

1 Display the Input select menu

AV

2 Select “Media Server”

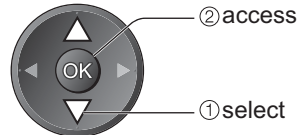
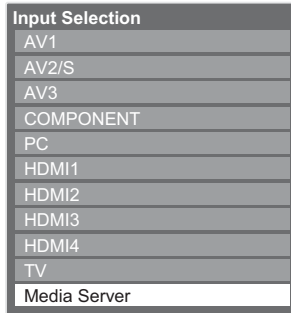

- You can also access directly by using VIERA TOOLS
 - ➔ “How to Use VIERA TOOLS” (p. 30)

3 Select one of the media servers you want to access

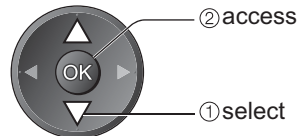
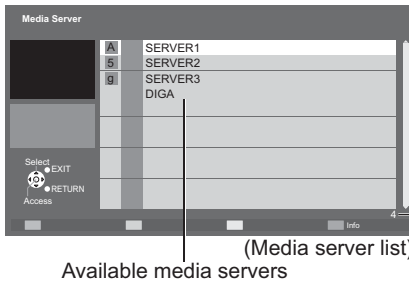

- To display the information of the highlighted media server
 - ➔ **i** or **blue**

4 Select the file (photo or video) to be viewed

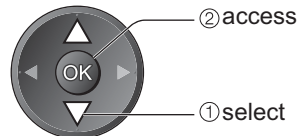
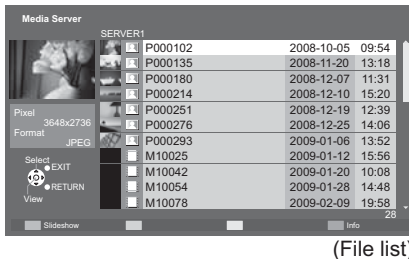

- Depending on the conditions of media server, you may need to select the folder before selecting the file.
- To display the information of the highlighted file
 - ➔ **i** or **blue**

■ To return to TV



■ To return to the previous screen



For photo file

■ **Single view** - Photos are displayed one at a time.

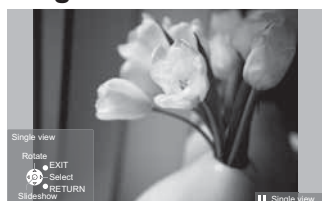

Operation guide

(Single view)

- To display / hide the operation guide →

- To operate Single view

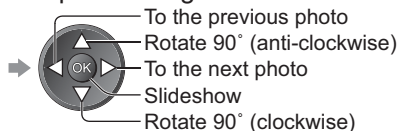

- To return to list →

■ **Slideshow** - Slideshow will be started from the selected photo file and completed within the list.

Start Slideshow



red

- To display / hide the operation guide →

- To pause (return to Single view) →

- To return to list →

For video file

■ **Playback** - Playback will start.

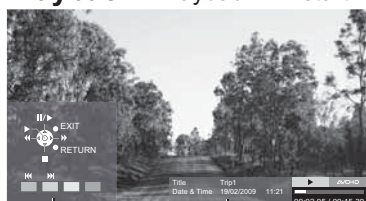

Operation guide

(Playback)
Information banner

- To display / hide the operation guide and information banner →

- To operate the playback

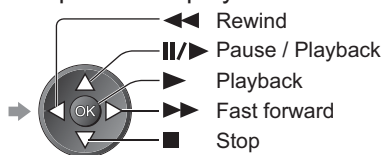

- To the previous scene →

red

- To the next scene →

green

- To change aspect (only for the 4:3 video content) →

ASPECT

- To return to list →

BACK/
RETURN

For DIGA Recorder

■ **Control the DIGA Recorder**

The screen of the DIGA Recorder will be displayed. You can control the functions of the DIGA Recorder with this TV remote control according to the operation guide.

- Before operating, register this TV on the DIGA Recorder.
- For details, read the manual of the DIGA Recorder.

Example:

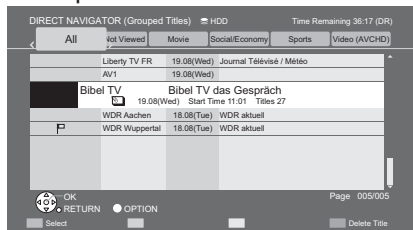

Note

- You may select and playback the music file.
- Non-playable files are also listed but cannot be selected.
- Turn the TV off, and then on again when changing or reconnecting the network connection.

Using Network Services

(DLNA / VIERA CAST / freesat)

Photo Setup (for photo contents) and Video Setup (for video contents)

Choose the settings for Photo and Video file operations.

Display the menu



Select "Photo Setup" or "Video Setup"



● Other items

➔ p. 32, 33, 35, 36 and p. 73

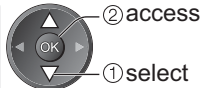

Select the items and set

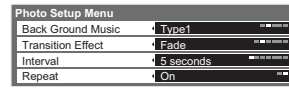

Select "Other Settings"



Select the items and set

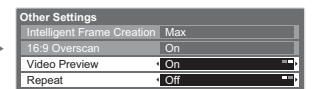

Menu	Item	Adjustments / Configurations (alternatives)
Photo Setup	Back Ground Music	<p>Selects the back ground music while photo (Off / Type1 / Type2 / Type3 / User)</p> <ul style="list-style-type: none"> ● Type1, Type2 and Type3 are the fixed music each installed in this TV. User : Music data registered by yourself in Music mode will be played back. ● To register the music ➔ "Set background music for Photo mode" (p. 68) ● Only available music files can be registered. ● If no music has been registered, or you change to the other media server, no sound will be produced.
	Transition Effect	<p>Selects the transition effect for switching the photo during the slideshow (Off / Fade / Slide / Dissolve / Motion / Random)</p> <p>Fade : The next photo fades in gradually. Slide : The next photo slides and appears from the left side. Dissolve : The photo is replaced by an indefinite block unit. Motion : The photo is replaced with enlarged, reduced, moved up or moved down. Random : Each transition is selected at random.</p>
	Interval	<p>Selects slideshow interval (5 / 10 / 15 / 30 / 60 / 90 / 120 seconds)</p> <ul style="list-style-type: none"> ● This function is not available when "Transition Effect" is set to "Motion".
	Repeat	<p>Slideshow repeat (Off / On)</p>
Video Setup	Other Settings	
	Video Preview	<p>Sets to start the preview of the title or scene in the thumbnail screen (Off / On)</p> <ul style="list-style-type: none"> ● Image may not be displayed for an instant in the thumbnail screen. Set the preview "Off" to resolve this.
	Repeat	<p>Playback repeat within the title (Off / On)</p>

Sound Settings (for video contents)

You can enjoy the multi-channel sound via an amplifier connected to DIGITAL AUDIO OUT terminal.

■ To confirm or change the current sound status (during playback)

Display the Option menu

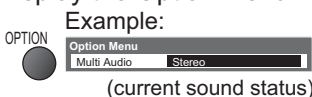

(current sound status)

Change the sound (if the video has multiple audio signals)



● It may take several seconds to change the sound.

■ Audio output settings

Display the menu



Select "Sound"



Select "SPDIF Selection" and set

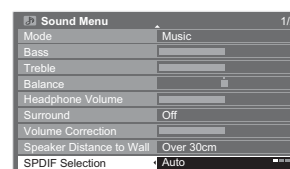

Menu	Item	Adjustments / Configurations (alternatives)
Sound	SPDIF Selection	<p>SPDIF : A standard audio transfer file format</p> <p>Selects the initial setting for digital audio output signal from DIGITAL AUDIO OUT terminal (Auto / PCM)</p> <p>Auto: Dolby Digital is output as Dolby Digital Bitstream. MPEG is output as PCM. PCM: Digital output signal is fixed to PCM.</p>

You can access a selection of internet services from VIERA CAST home screen. For example, YouTube, Picasa Web Albums (current as of March, 2010).

- VIERA CAST requires a broadband internet connection. Dial-up internet connections cannot be used.
- Ensure the network connections and network settings are completed.
 - ➔ “Network connections” (p. 75), “Network Setup” (p. 76 - 79)



Access VIERA CAST



- Depending on the usage conditions, it may take a while to read all the data.

Example:

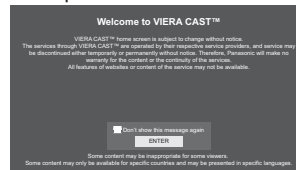

- Messages might be displayed before VIERA CAST home screen. Please read these instructions carefully and follow the on screen instructions.

Example:



VIERA CAST home screen

- Video communication (ex. Skype™) requires an exclusive Communication Camera TY-CC10W (optional accessory ➔ p. 6). For details, read the manual of the Communication Camera.

■ To return to TV



■ How to operate VIERA CAST (current as of March, 2010)

- To go to the next level ➔ Select “MORE”
- To back to the previous level ➔ Select “BACK”
- To move the cursor / select the item ➔
- To access ➔
- To return to the previous screen ➔
- To return to VIERA CAST home screen ➔
- When the key words are displayed on colour bar ➔
- When options with numbers are displayed ➔

- Setup & Help menu (Items in the “Setup & Help” may change without notice.)

Customize HomeScreen	Changes the position of each services on VIERA CAST home screen
My Account	Confirms or removes the account information of the TV you entered on VIERA CAST
Lock	Sets to restrict access to some services
Beep	Sets beep sound On or Off when operating VIERA CAST
Notices	Displays the information of VIERA CAST
Help	Explains the setup items and operations in VIERA CAST

■ USB Keyboard

You can input characters on VIERA CAST screen by using the USB Keyboard connected to the USB port.

- You cannot use two or more keyboards simultaneously.
- The USB Keyboard which requires the driver is not supported.
- To change the language type ➔ “USB Keyboard Layout” (p. 36)

Note

- Be sure to update the software when a software update notice is displayed on the TV screen. If the software is not updated, you will not be able to use VIERA CAST. You can update the software later manually ➔ “Software Update” in the Network Setup Menu (p. 76)
- VIERA CAST™ home screen is subject to change without notice.
- The services through VIERA CAST™ are operated by their respective service providers, and service may be discontinued either temporarily or permanently without notice. Therefore, Panasonic will make no warranty for the content or the continuity of the services.
- All features of websites or content of the service may not be available.
- Some content may be inappropriate for some viewers.
- Some content may only be available for specific countries and may be presented in specific languages.
- Depending on the connection environment, the internet connection may be slow or may not be successful.
- During the operation, audio signal is output from AV1, AV2, AUDIO OUT and DIGITAL AUDIO OUT terminals. But no video signals are output. AV1 and AV2 can output audio signal if “AV1 / AV2 out” is set to “Monitor” in the Setup Menu (p. 34).
- You can set to restrict using VIERA CAST ➔ “Child Lock” (p. 54)
- Turn the TV off, and then on again when changing or reconnecting the network connection.

Link Functions (Q-Link VIERA Link)

Q-Link connects the TV and DVD Recorder / VCR, and enables easy recording, playback, etc. (p. 86)
 VIERA Link (HDAVI Control™) connects the TV and the equipment with VIERA Link function, and enables easy control, convenient recording, playback, energy saving, creation of a home theatre, etc., without complicated setting. (p. 87 - 91)

You can use Q-Link and VIERA Link functions together.

- This TV supports "HDAVI Control 5" function. But available features are depending on the connected equipment's version of HDAVI Control. Please refer to the manual of the equipment to confirm the version.
- VIERA Link features may be available even with other manufacturers' equipment supporting HDMI CEC.

Summary of Q-Link and VIERA Link features

■ Q-Link (SCART connection only)

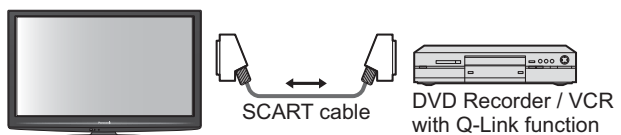
Features	Connected equipment DVD Recorder / VCR with Q-Link function	Connection
Analogue channel download	○	 <p>● Use a fully wired SCART cable. ● Connect the DVD Recorder / VCR supporting Q-Link to the TV's AV1 or AV2 terminal via a SCART cable.</p>
Easy playback	○	
Power on link	○	
Power off link	○	
Direct TV Recording	○	

■ VIERA Link (HDMI connection only)

Features	Connected equipment DIGA Recorder with VIERA Link function	DVD Player / Blu-ray Disc Player with VIERA Link function	HD Video Camera / LUMIX Camera with VIERA Link function
Analogue channel download	-	-	-
Easy playback	○	○	○
Power on link	○	○	○
Power off link	○	○	○
Reduce unnecessary power consumption in standby	○*3	○*3	-
Auto standby for unnecessary equipment	○*3	○*3	-
Pause Live TV programme	○*2 ○*4	-	-
Direct TV Recording	○*2	-	-
Control the menu of the connected equipment by VIERA remote control	○*1	○*1	○*1
Speaker control	-	-	-

Connection

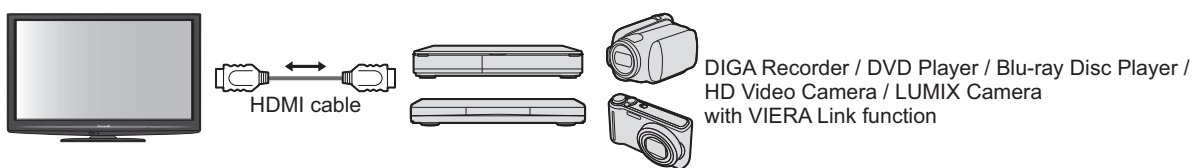

- Use a fully wired HDMI compliant cable.
- Connect the equipment supporting VIERA Link to the TV's HDMI1, HDMI2, HDMI3 or HDMI4 terminal via an HDMI cable.
- For information about using HDMI cables for connecting Panasonic HD Video Camera or LUMIX Camera, read the manual of the equipment.

■ VIERA Link (HDMI and SCART connections)

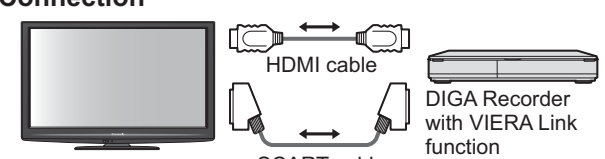
Features	Connected equipment DIGA Recorder with VIERA Link function	Connection
Analogue channel download	○	 <p>● Use a fully wired HDMI compliant cable. ● Connect the equipment supporting VIERA Link to the TV's HDMI1, HDMI2, HDMI3 or HDMI4 terminal via an HDMI cable. ● Use a fully wired SCART cable. ● Connect the equipment supporting VIERA Link to the TV's AV1 or AV2 terminal via a SCART cable.</p>
Easy playback	○	
Power on link	○	
Power off link	○	
Direct TV Recording	○*2	
Reduce unnecessary power consumption in standby	○*3	
Auto standby for unnecessary equipment	○*3	
Pause Live TV programme	○*2 ○*4	
Control the menu of the connected equipment by VIERA remote control	○*1	
Speaker control	-	

■ VIERA Link (HDMI and Audio out connections)

Connected equipment	Player theatre with VIERA Link function	Blu-ray Disc theatre with VIERA Link function	Amplifier with VIERA Link function
Features			
Analogue channel download	—	—	—
Easy playback	○*5	○*5	—
Power on link	○	○	—
Power off link	○	○	○
Reduce unnecessary power consumption in standby	—	○*3	—
Auto standby for unnecessary equipment	○*3 ○*6	○*3 ○*6	○*3
Pause Live TV programme	—	—	—
Direct TV Recording	—	—	—
Control the menu of the connected equipment by VIERA remote control	○*1	○*1	—
Speaker control	○	○	○

Connection

- To use Player theatre / Blu-ray Disc theatre:

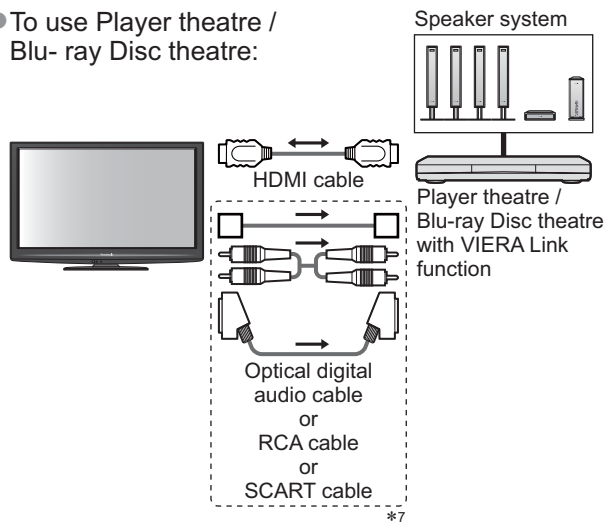

- To use Amplifier:

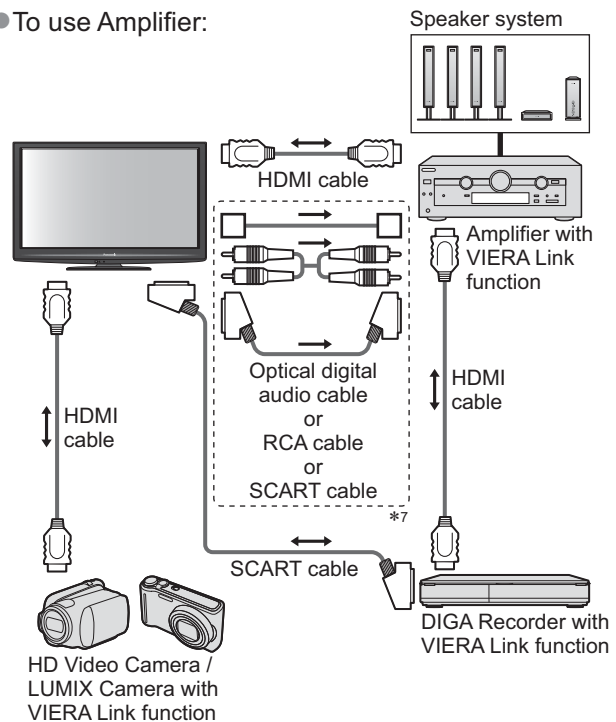

- Use a fully wired HDMI compliant cable.
- Connect the equipment supporting VIERA Link to the TV's HDMI2, HDMI3 or HDMI4 terminal via an HDMI cable.
- Use a fully wired SCART cable.
- If you use a SCART cable for audio output, connect the equipment supporting VIERA Link to the TV's AV1 or AV2 terminal and set "AV1 / AV2 out" to "Monitor" in the Setup Menu (p. 34).
- Use any one of the optical digital audio cable, RCA cable and SCART cable for audio output from the TV.

*1: Available with the equipment which has "HDAVI Control 2 or later" function.

*2: Available with the equipment which has "HDAVI Control 3 or later" function.

*3: Available with the equipment which has "HDAVI Control 4 or later" function.

*4: Available with DIGA Recorder which has HDD.

*5: while playingback a disc

*6: except for watching a disc

*7: If the connected equipment has "HDAVI Control 5" function, you do not have to use this audio cable (Optical digital audio cable, RCA cable or SCART cable). In this case, connect the equipment to the TV's HDMI2 terminal via an HDMI cable.

■ VIERA Link Control of compatible equipment (VIERA Link Control → p. 90)

- Table below displays maximum number of compatible equipment that can be controlled by VIERA Link Control. This includes connections to equipment already connected to the TV. For example, DIGA Recorder connected to Amplifier which is connected to the TV via an HDMI cable.

Type of the equipment	Maximum number
Recorder (DIGA Recorder, etc.)	3
Player (DVD Player, Blu-ray Disc Player, HD Video Camera, LUMIX Camera, Digital Camera, Player theatre, Blu-ray Disc theatre, etc.)	3
Audio system (Player theatre, Blu-ray Disc theatre, Amplifier, etc.)	1
Tuner (Set top box, etc.)	4

Link Functions (Q-Link VIERA Link)

Q-Link

■ Preparations

- Connect the DVD Recorder / VCR with the following logos: "Q-Link", "NEXTVIEWLINK", "DATA LOGIC", "Easy Link", "Megalogic" or "SMARTLINK"
- Q-Link connection → p. 84
- Use fully wired SCART cable.
- Set up the DVD Recorder / VCR. Read the manual of the recorder.
- Q-Link terminal setup in the Setup Menu → "Q-Link" (p. 34), "AV1 / AV2 out" (p. 34)
- Download Analogue channel setting → "Analogue channel download" (see below)

■ Features available

Analogue channel download

Analogue channel settings can be downloaded to a recorder with an analogue tuner (where Analogue is still broadcast). Digital channel settings are not downloaded.

- To download the Analogue channel settings → "Q-Link Download" (p. 34) or "Auto Setup" in Analogue mode (p. 41) or "Auto Setup" - when first using the TV (p. 12)

Direct TV Recording - What you see is What you record

Recording the current programme on a DVD Recorder / VCR immediately.



- Available conditions:

Picture source	Mode	Recording from
Analogue	TV	TV monitor out
	AV	Recorder's tuner
Freesat, DVB, Other Sat.	TV	TV monitor out
AV (watching recorder's tuner)	AV	Recorder's tuner
AV (watching recorder's external input)	AV	Recorder's external input
AV (watching TV's external input)	AV	TV monitor out

- When Direct TV Recording is performed, the recorder is automatically turned on if it is in Standby mode.
- Changing channel or turning off the TV is available while the recorder is recording from its own tuner.
- Changing channel is not available while the recorder is recording from the TV tuner.

■ To stop recording

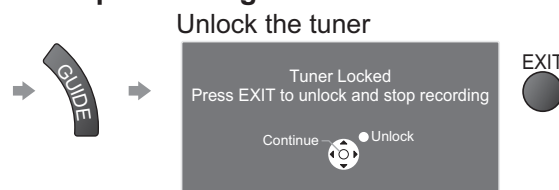

Power on link and Easy playback

When the DVD Recorder / VCR starts playback or the direct navigator / function menu for the equipment is activated, the TV is turned on and the input mode is switched automatically so that you can view the content. (Only when the TV is in Standby mode.)

Power off link

When the TV is set to Standby mode, the recorder is also automatically set to Standby. (Only when the videocassette or disc is not active.)

- This function will work even if the TV enters Standby mode automatically by auto power standby function.

- "DATA LOGIC" (a trademark of Metz Corporation)
- "Easy Link" (a trademark of Philips Corporation)

- "Megalogic" (a trademark of Grundig Corporation)
- "SMARTLINK" (a trademark of Sony Corporation)

Note

- Some recorders are not compatible. Read the manual of the recorder.

VIERA Link “HDAVI Control™”*

*Enjoy additional HDMI Inter-Operability with Panasonic products which have “HDAVI Control” function. This TV supports “HDAVI Control 5” function.

Connections to the equipment (DIGA Recorder, HD Video Camera, Player theatre, Amplifier, etc.) with HDMI and SCART cables allow you to interface them automatically (p. 84 and p. 85).

These features are limited to models incorporating “HDAVI Control” and “VIERA Link”.

- Some functions are not available depending on the equipment’s version of HDAVI Control. Please confirm the connected equipment’s version of HDAVI Control.
- VIERA Link “HDAVI Control”, based on the control functions provided by HDMI which is an industry standard known as HDMI CEC (Consumer Electronics Control), is a unique function that we have developed and added. As such, its operation with other manufacturers’ equipment that supports HDMI CEC cannot be guaranteed.
- Please refer to individual manuals for other manufacturers’ equipment supporting VIERA Link function.
- For information about applicable Panasonic equipment, consult your local Panasonic dealer or refer to www.panasonic.co.uk

■ Preparations

- Connect the equipment that supports VIERA Link.
- VIERA Link connection ➔ p. 84 and p. 85
- Use a fully wired HDMI compliant cable. Non-HDMI-compliant cables cannot be utilized.
Recommended Panasonic HDMI cables’ part numbers:
 - RP-CDHS15 (1.5 m)
 - RP-CDHS30 (3.0 m)
 - RP-CDHS50 (5.0 m)
- Use a fully wired SCART cable.
- Set up the connected equipment. Read the manual of the equipment.
- For optimal recording, the settings of the recorder may need to be changed. For details, read the manual of the recorder.
- Download Analogue channel setting ➔ “Analogue channel download” (see below)
- Set VIERA Link On in the Setup Menu ➔ “VIERA Link” (p. 34)
- Set up the TV
 - ➔ **After connection, turn the equipment on and then switch the TV on. Select the input mode to HDMI1, HDMI2, HDMI3 or HDMI4 (p. 28), and make sure that an image is displayed correctly.**
This setup should be done each time when the following conditions occur:
 - for the first time
 - when adding or reconnecting equipment
 - when changing setup

■ Features available

Analogue channel download

Analogue channel settings can be downloaded to a recorder with an analogue tuner (where Analogue is still broadcast). Digital channel settings are not downloaded.

- To download the Analogue channel settings ➔ “Q-Link Download” (p. 34) or “Auto Setup” in Analogue mode (p. 41) or “Auto Setup” - when first using the TV (p. 12)

Easy playback

Automatic Input switching - When the connected equipment is operated (during playback or menu operations, etc.), the input mode is switched automatically. When playback is stopped or menus are exited, the input mode returns to the original setting.

Power on link

When the connected equipment starts playback or the direct navigator / function menu for the equipment is activated, the TV is automatically turned on and the input mode is switched automatically so that you can view the content. (Only when the TV is in Standby mode.)

Power off link

When the TV is set to Standby mode, the connected equipment is also automatically set to Standby.

- This function will work even if the TV enters Standby mode automatically by auto power standby function.

Link Functions (Q-Link VIERA Link)

■ Features available

Reduce unnecessary power consumption in standby Standby Power Save

Set Standby Power Save "On" in the Setup Menu to use this function

➔ "Standby Power Save" (p. 34)

The power consumption in Standby mode of the connected equipment is controlled in synchronization with the TV On / Off state.

When the TV is set to Standby mode, the connected equipment is automatically set to Standby and the power consumption in Standby mode of the connected equipment is automatically minimized.

When the TV is turned on and the connected equipment is still in Standby mode, the power consumption of the connected equipment is increased to reduce the startup time.

- This function is effective if the connected equipment can change the power consumption in Standby mode and is set to higher consumption.

Auto standby for unnecessary equipment Intelligent Auto Standby

Set Intelligent Auto Standby "On (With reminder)" or "On (No reminder)" in the Setup Menu to use this function

➔ "Intelligent Auto Standby" (p. 34)

When the TV is On, non-watched or non-used connected equipment goes into Standby mode automatically to reduce power consumption. For example, when the input mode is switched from HDMI, the connected equipment will go into Standby mode / when Speaker Selection is changed to "TV", the Player theatre will go into Standby mode (except when watching a disc).

- If you select "On (With reminder)", the on screen message will be displayed before the connected equipment turns to Standby.
- This function may not work properly depending on the connected equipment. If required, set to "Off".

■ Features available (Using VIERA Link Menu)

Direct TV Recording - What you see is What you record Direct TV Rec

Recording the current programme on a DIGA Recorder immediately.

- If you connect a variety of recorders including other manufacturers' recorders at the same time, please connect the DIGA Recorder to the TV's lower HDMI terminal number. For example, if you use HDMI1 and HDMI2 for two recorders, connect the DIGA Recorder to HDMI1.
- If Direct TV Recording does not operate, check the settings and the equipment
➔ "Summary of Q-Link and VIERA Link features" (p. 84 and p. 85), "Preparations" (p. 87)
- If you wish to record a programme that the DIGA Recorder does not support, a SCART connection is required and the programme is recorded by Q-Link function (p. 86).
- Depending on the programme, a SCART connection may be required to record.
- Changing channel or turning off the TV is available while the recorder is recording from its own tuner.
- Changing channel is not available while the recorder is recording from the TV tuner.



1 Display "VIERA Link Menu"

2 Select "Direct TV Rec" and start recording

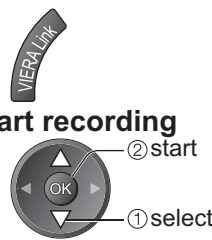
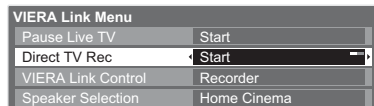

- You can also start recording directly ➔

■ To stop recording

Select "Stop" in "Direct TV Rec" and access

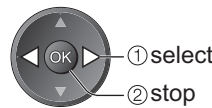

- You can also stop recording directly.

Unlock the tuner

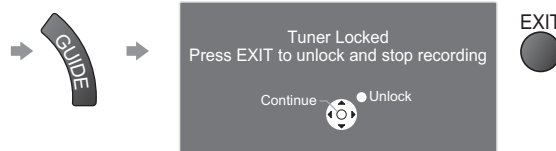

■ **Features available** (Using VIERA Link Menu)

Pause Live TV programme Pause Live TV

You can pause the live TV programme and resume the programme later.
The live TV programme will be recorded on HDD of the connected DIGA Recorder.

- This function is available with a DIGA Recorder which has HDD.
- If you connect a variety of recorders including other manufacturers' recorders at the same time, please connect the DIGA Recorder which has HDD to the TV's lower HDMI terminal number. For example, if you use HDMI1 and HDMI2 for two recorders, connect the DIGA Recorder which has HDD to HDMI1.
- If Pause Live TV does not operate, check the settings and the equipment
→ "Summary of Q-Link and VIERA Link features" (p. 84 and p. 85), "Preparations" (p. 87)

Access and pause the live TV programme



1 Display "VIERA Link Menu"



2 Select "Pause Live TV" and pause

VIERA Link Menu	
Pause Live TV	Start
Direct TV Rec	Start
VIERA Link Control	Recorder
Speaker Selection	Home Cinema

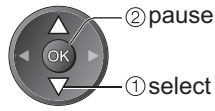

The TV picture will be paused.

- You can also pause directly by using VIERA TOOLS
→ "How to Use VIERA TOOLS" (p. 30)
- Live TV programme is recorded on HDD from where it was paused.
- If the paused TV picture disappears after a few minutes
→ (the paused picture will be restored)
- Follow the operation guide to operate Pause Live TV function.

■ **To operate Pause Live TV**

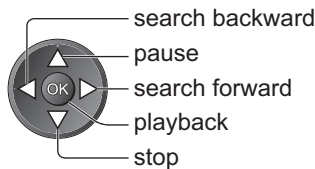

- Operations may be different depending on the recorder. In this case, follow the operation guide or read the manual of the recorder.

- If you stop playback, the recorded programme will be deleted from HDD.

■ **To return to Live TV**

(stop playback of Pause Live TV / cancel pause)

Select "Yes"

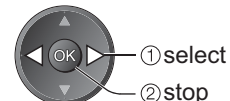
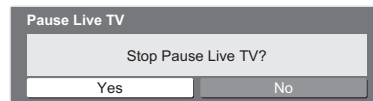

- If you stop playback or cancel pause, the recorded programme will be deleted from HDD.

Link Functions (Q-Link VIERA Link)

■ Features available (Using VIERA Link Menu)

Control the menu of the connected equipment by VIERA remote control

VIERA Link Control

You can control some functions of the connected equipment with this TV remote control (point the remote control at the TV's signal receiver).

- If you cannot operate the menu of the connected equipment, check the settings and the equipment
 - ➔ "Summary of Q-Link and VIERA Link features" (p. 84 and p. 85), "Preparations" (p. 87)
- For details of the operations for the connected equipment, read the manual of the equipment.

Access and operate the menu of the equipment



1 Display "VIERA Link Menu"

2 Select "VIERA Link Control"

VIERA Link Menu	
Pause Live TV	Start
Direct TV Rec	Start
VIERA Link Control	Recorder
Speaker Selection	Home Cinema

select

3 Select the equipment you want to access

The type of the connected equipment is displayed. Select the type of the equipment and access.

VIERA Link Menu	
Pause Live TV	Start
Direct TV Rec	Start
VIERA Link Control	Recorder
Speaker Selection	Home Cinema

① select
② access

Recorder / Player / Home Cinema / Video Camera / LUMIX / Digital Camera / Other

- You can also access directly by using VIERA TOOLS
 - ➔ "How to Use VIERA TOOLS" (p. 30)
- The displayed item may vary depending on the connected equipment.
- "Home Cinema" means Player theatre, Blu-ray Disc theatre or Recorder theatre.
- "Other" means Tuner set top box.

■ If multiple recorders or players are connected

VIERA Link Menu	
Pause Live TV	Start
Direct TV Rec	Start
VIERA Link Control	Recorder2
Speaker Selection	Home Cinema

Recorder1-3 / Player1-3

The number is given from the TV's lower HDMI terminal number connected to the same type equipment. For example, two recorders to HDMI2 and HDMI3, in this case the recorder connected to HDMI2 is displayed as "Recorder1", and the recorder connected to HDMI3 is displayed as "Recorder2".

■ If you access non-VIERA Link equipment

VIERA Link Menu	
Pause Live TV	Start
Direct TV Rec	Start
VIERA Link Control	Recorder
Speaker Selection	Home Cinema

The type of the connected equipment is displayed. You can access the menu of the equipment. But you cannot operate it. Use its own remote control to operate the equipment.

The menu of the accessed equipment (Input mode will be changed automatically)

4 Operate the menu of the equipment

Available VIERA remote control buttons: (depending on the connected equipment)



① Set the position to "TV"



② Follow the operation guide

- To display the operation guide ➔ OPTION
- If other manufacturers' equipment is accessed, Setup / Contents Selection menu may be displayed.
- When the key words are displayed on colour bar
 - ➔ red green yellow blue

Note

- Some operations may not be available depending on the equipment. In this case use its own remote control to operate the equipment.

■ **Features available** (Using VIERA Link Menu)

Speaker control **Speaker Selection**

You can control the home theatre speakers with this TV remote control (point the remote control at the TV's signal receiver).

- If you cannot control the home theatre speakers with this remote control, check the settings and the equipment
 - ➔ "Summary of Q-Link and VIERA Link features" (p. 84 and p. 85), "Preparations" (p. 87)

Access and control the speaker volume

1 Display "VIERA Link Menu"

2 Select "Speaker Selection"

VIERA Link Menu	
Pause Live TV	Start
Direct TV Rec	Start
VIERA Link Control	Recorder
Speaker Selection	Home Cinema

3 Set to "Home Cinema" or "TV"

■ **Home Cinema**

The Player theatre, Blu-ray Disc theatre or Amplifier will be automatically turned on if it is in Standby mode and the sound will be output from theatre speakers connected to the equipment.

- Volume up / down ➔
- Mute ➔

- The sound of the TV speakers is muted.
- When the equipment is turned off, the TV speakers will be activated.

■ **TV**

TV speakers are active.

Note

- If you wish to enjoy multi-channel sound (e.g. Dolby Digital 5.1ch) via an Amplifier, connect the Amplifier to the TV with an HDMI cable and an Optical digital audio cable (p. 85), and then select "Home Cinema". If your Amplifier has "HDAVI Control 5" function, you only need to connect with an HDMI cable. In this case, connect your Amplifier to the TV's HDMI2 terminal. To enjoy the sound from the DIGA Recorder in multi-channel sound, connect an HDMI cable from the DIGA Recorder to the Amplifier (p. 85).

Note

- These functions may not work properly depending on the connected equipment.
- Image or sound may not be available for the first few seconds when Input mode is switched.
- Easy playback may be available by using the remote control for Player theatre, Blu-ray Disc theatre or Amplifier. Read the manual of the equipment.
- "HDAVI Control 5" is the newest standard (current as of December, 2009) for HDAVI Control compatible equipment. This standard is compatible with conventional HDAVI equipment.
- To confirm this TV's version of HDAVI Control ➔ "System Information" (p. 36)

External Equipment

These diagrams show our recommendations for connection of your TV to various pieces of equipment. For other connections, consult the instructions for each piece of equipment, the table below, and the specifications (p. 107).

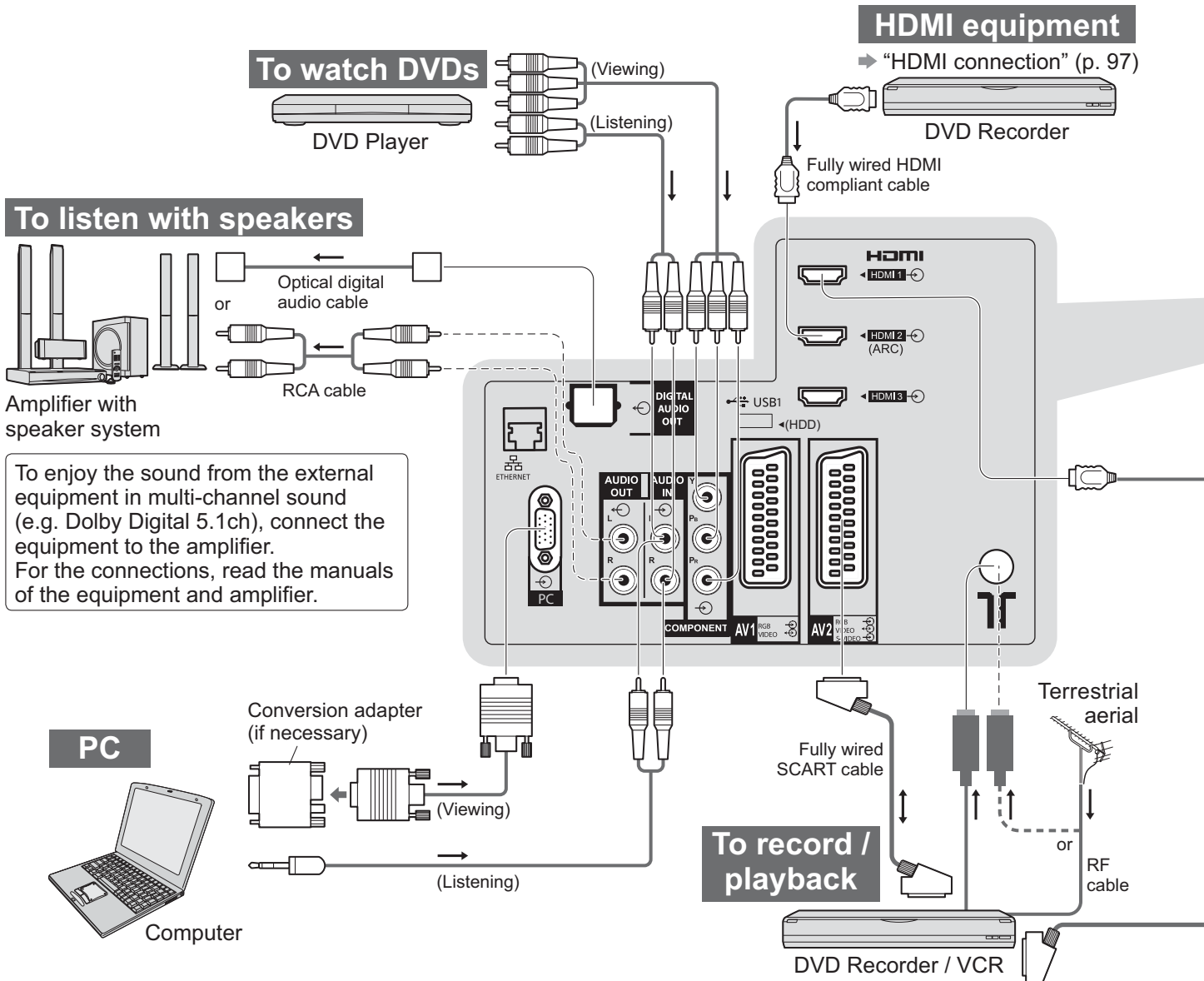

Types of connectable equipment to each terminal

Terminal	AV1	AV2	AV3 (Side panel of the TV)
Recording / Playback (equipment)			
To record / playback videocassettes / DVDs (VCR / DVD Recorder)	○	○	
To watch DVDs (DVD Player)	○	○	○
To watch camcorder images (Video camera)	○	○	○
To watch cable broadcasts (Cable TV box)	○	○	○
To play games (Game equipment)	○	○	○
To use amplifier with speaker system			
To use Network services			
USB HDD Recording			
Q-Link	○	○	
VIERA Link	○ (with HDMI)	○ (with HDMI)	
Direct TV Recording	○	○	

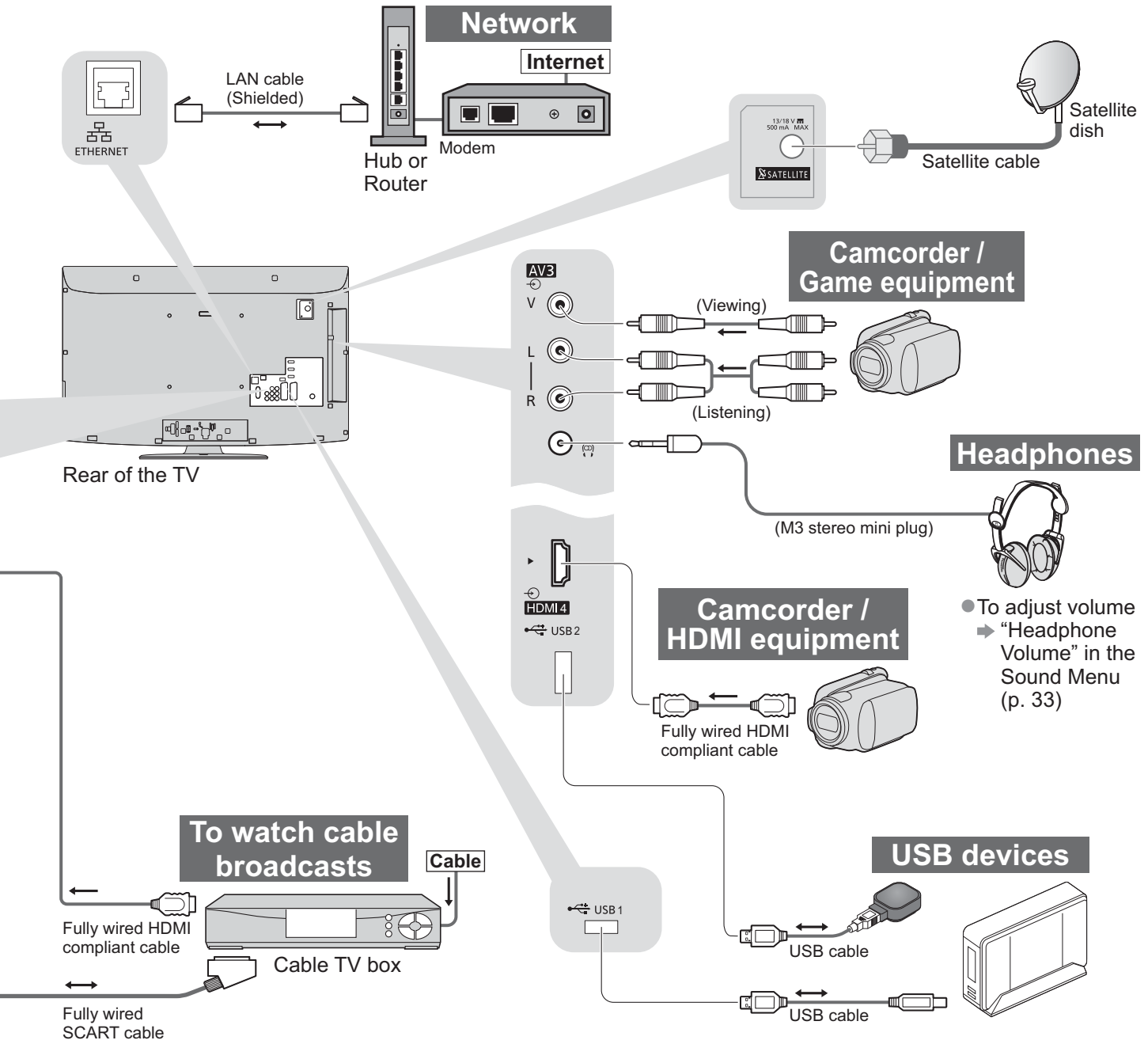

To adjust volume
 → "Headphone Volume" in the Sound Menu (p. 33)

COMPONENT	AUDIO OUT	DIGITAL AUDIO OUT	ETHERNET	HDMI				USB	
				1	2	3	4	1	2
				<input type="checkbox"/>	<input type="checkbox"/>	<input type="checkbox"/>	<input type="checkbox"/>	<input type="checkbox"/>	<input type="checkbox"/>
<input type="checkbox"/>	<input type="checkbox"/>	<input type="checkbox"/>	<input type="checkbox"/>	<input type="checkbox"/>	<input type="checkbox"/>	<input type="checkbox"/>	<input type="checkbox"/>	<input type="checkbox"/>	<input type="checkbox"/>
<input type="checkbox"/>	<input type="checkbox"/>	<input type="checkbox"/>	<input type="checkbox"/>	<input type="checkbox"/>	<input type="checkbox"/>	<input type="checkbox"/>	<input type="checkbox"/>	<input type="checkbox"/>	<input type="checkbox"/>
<input type="checkbox"/>	<input type="checkbox"/>	<input type="checkbox"/>	<input type="checkbox"/>	<input type="checkbox"/>	<input type="checkbox"/>	<input type="checkbox"/>	<input type="checkbox"/>	<input type="checkbox"/>	<input type="checkbox"/>
<input type="checkbox"/>	<input type="checkbox"/>	<input type="checkbox"/>	<input type="checkbox"/>	<input type="checkbox"/>	<input type="checkbox"/>	<input type="checkbox"/>	<input type="checkbox"/>	<input type="checkbox"/>	<input type="checkbox"/>
<input type="checkbox"/>	<input type="checkbox"/>	<input type="checkbox"/>	<input type="checkbox"/>	<input type="checkbox"/>	<input type="checkbox"/>	<input type="checkbox"/>	<input type="checkbox"/>	<input type="checkbox"/>	<input type="checkbox"/>
<input type="checkbox"/>	<input type="checkbox"/>	<input type="checkbox"/>	<input type="checkbox"/>	<input type="checkbox"/>	<input type="checkbox"/>	<input type="checkbox"/>	<input type="checkbox"/>	<input type="checkbox"/>	<input type="checkbox"/>
<input type="checkbox"/>	<input type="checkbox"/>	<input type="checkbox"/>	<input type="checkbox"/>	<input type="checkbox"/>	<input type="checkbox"/>	<input type="checkbox"/>	<input type="checkbox"/>	<input type="checkbox"/>	<input type="checkbox"/>

Technical Information

Auto Aspect

The optimum size and aspect can be chosen automatically, and you can enjoy finer images. (p. 18)

■ Aspect Control Signal

"WIDE" will appear in the top left of the screen if a Widescreen signal (WSS) or a Control signal through SCART / HDMI terminal is found.

The aspect will switch to the appropriate 16:9 or 14:9 widescreen ratio.

This function will work in any aspect mode.

Input terminal	Input signal format	Aspect Control Signal		
		Widescreen signal (WSS)	Control signal through SCART (pin8) / HDMI terminal	
RF	DVB	○		
	PAL I	○		
	PAL 525/60 6.0 MHz	—		
	M.NTSC 6.0 MHz	—		
Satellite	freesat, Other Sat.	○		
AV1 (Composite) AV2 (Composite or S-Video) AV3	PAL	○		○
	PAL 525/60	—		○
	M.NTSC	—		○
COMPONENT	NTSC	—		○
	525 (480) / 60i	—		
	525 (480) / 60p	—		
	625 (576) / 50i	○		
	625 (576) / 50p	○		
	750 (720) / 60p	—		
	750 (720) / 50p	—		
	1,125 (1,080) / 60i	—		
1,125 (1,080) / 50i	—			
HDMI1 HDMI2 HDMI3 HDMI4	525 (480) / 60i	—	○	
	525 (480) / 60p	—	○	
	625 (576) / 50i	—	○	
	625 (576) / 50p	—	○	
	750 (720) / 60p	—	○	
	750 (720) / 50p	—	○	
	1,125 (1,080) / 60i	—	○	
	1,125 (1,080) / 50i	—	○	
	1,125 (1,080) / 60p	—	○	
	1,125 (1,080) / 50p	—	○	
	1,125 (1,080) / 24p	—	○	

■ Auto mode

Auto mode determines the best aspect ratio to fill the screen. It does this using a four step process (WSS, Control signal through SCART / HDMI terminal, Letterbox detection, or Justify to fill the screen).

This process may take several minutes, depending on the darkness of the image.

Letterbox detection: If black bands at the top and bottom of the screen are detected, Auto mode chooses the best ratio and expands the image to fill the screen.

If no aspect signals are detected, Auto mode enhances the image for optimum viewing pleasure.

Note

- The ratio varies depending on the programme, etc. If the ratio is out of the standard 16:9, black bands at the top and bottom of the screen may appear.
- If the screen size looks unusual when a widescreen-recorded programme is played back on a VCR, adjust the tracking of the VCR. Read the manual of the VCR.

SD Card

- If the SD Card does not meet SD standards, it may cause the TV to malfunction.
- Do not remove the card while the TV is accessing data (this can damage card or TV).
- Do not touch the pins on the back of the card.
- Do not subject the card to a high pressure or impact.
- Insert the card in the correct direction (otherwise the card or TV may be damaged).
- Electrical interference, static electricity, or erroneous operation may damage the data or card.
- Back up the recorded data at regular intervals in case of deteriorated or damaged data or erratic operation of the TV. (Panasonic is not liable for any deterioration or damage of recorded data.)

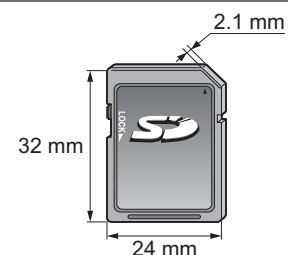

ABOUT DIVX VIDEO:

DivX® is a digital video format created by DivX, Inc. This is an official DivX Certified device that plays DivX video. Visit www.divx.com for more information and software tools to convert your files into DivX video.

■ DivX video file

DivX Certified to play DivX video up to HD 1080p, including premium content.

Extension - ".divx" or ".avi"

Image resolution - Up to 1,920 × 1,080 pixels

Video

- Number of stream: Up to 1
- Codec: DIV3, DIV4, DIVX, DX50, DIV6
- FPS (Frame Per Second): Up to 60 fps

Audio

- Number of stream: Up to 8
- Format: MP3, MPEG, AC3
- Multi channel: AC3 is possible. MPEG multi is 2 ch conversion.
- GMC (Global Motion Compensation) is not supported.

■ Subtitle text file of DivX

Subtitles format - MicroDVD, SubRip, TMLayer

- The DivX video file and subtitles text file are inside the same folder, and the file names are the same except for the file extensions.
- If there are more than one subtitles text files inside the same folder, they are displayed in the following order of priority: ".srt", ".sub", ".txt".
- To confirm or change the current subtitle status while playing DivX content, press the OPTION button to display Option Menu.
- Depending on the methods used to create the file or the state of recording, only parts of the subtitles may be displayed, or the subtitles may not be displayed at all.

Note

- Depending on how you make SD Card or USB Flash Memory, files and folders may not be displayed in the order you numbered.
- Depending on the software you use to create DivX files, the files may not play.
- Depending on how you create the files and the structure of folders, the files and folders may not be displayed.
- When there are many files and folders, operation may take time to complete or some files may not be displayed or playable.

ABOUT DIVX VIDEO-ON-DEMAND:

This DivX Certified® device must be registered in order to play DivX Video-on-Demand (VOD) content.

To generate the registration code, locate the DivX VOD section in the Setup Menu. Go to vod.divx.com with this code to complete the registration process and learn more about DivX VOD.

■ To show DivX VOD registration code

➔ "DivX® VOD" in the Setup Menu (p. 35)

- If you want to generate the new registration code, you have to deregister the present registration code. After playing DivX VOD content once, the confirmation screen to deregister will be displayed in "DivX® VOD" in the Setup Menu. If you press the OK button on the confirmation screen, the deregistration code will be generated and you will not be able to play any contents that you purchased using the present registration code.

You will obtain the new registration code by pressing the OK button on the deregistration code screen.

- If you purchase DivX VOD content using a registration code different from this TV's code, you will not be able to play this content. ("Your device is not authorized to play this DivX protected video." is displayed.)

■ Regarding DivX content that can only be played a set number of times

Some DivX VOD content can only be played a set number of times.

When you play this content, the remaining number of plays is displayed. You cannot play this content when the number of remaining plays is zero. ("This DivX rental has expired." is displayed.)

- When playing this content, the number of remaining plays is reduced by one in the following conditions:
 - If you exit the current application.
 - If you play the other content.
 - If you go to the next or previous content.

Technical Information

Characters table for numeric buttons

You can enter characters by using numeric buttons for free input items.
Press the numeric button repeatedly until you reach the desired character.

- The character is set automatically if you do not press the button for one second.
- You can also set the character by pressing the OK button or other numeric buttons within one second.

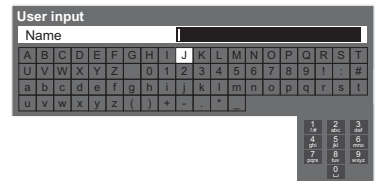

Characters table:

Numeric buttons	The number of times to press										
	1	2	3	4	5	6	7	8	9	10	11
1	.	1	!	:	#	+	-	*	_	()
2 _{abc}	a	b	c	2	A	B	C				
3 _{def}	d	e	f	3	D	E	F				
4 _{ghi}	g	h	i	4	G	H	I				
5 _{jkl}	j	k	l	5	J	K	L				
6 _{mno}	m	n	o	6	M	N	O				
7 _{pqrs}	p	q	r	s	7	P	Q	R	S		
8 _{tuv}	t	u	v	8	T	U	V				
9 _{wxyz}	w	x	y	z	9	W	X	Y	Z		
0	Space	0									

SCART and HDMI terminal information

■ AV1 SCART terminal (RGB, VIDEO, Q-Link)

Suitable inputs for AV1 include RGB (Red / Green / Blue).

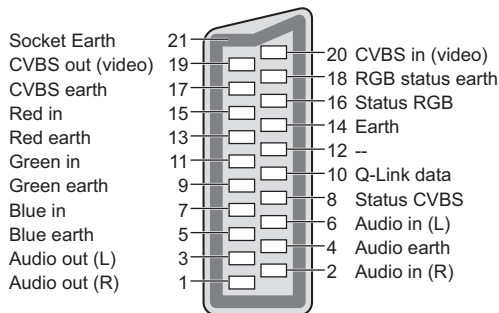

■ AV2 SCART terminal (RGB, VIDEO, S-VIDEO, Q-Link)

AV2 - Pins 15 and 20 are dependent on AV2 S-VHS / VIDEO switching.

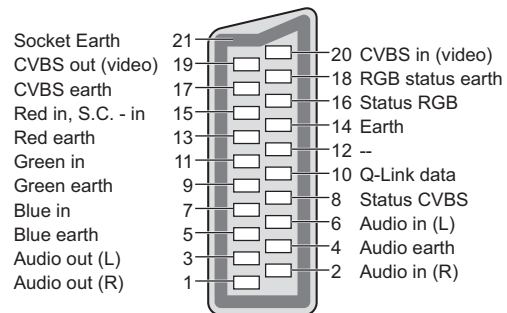

■ HDMI terminal

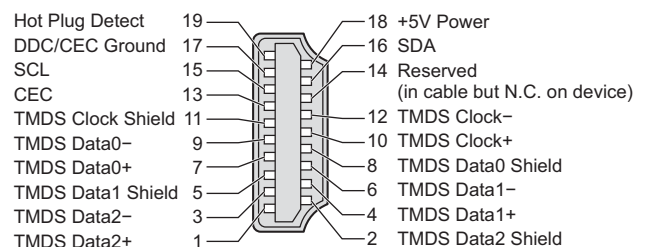

HDMI connection

HDMI (high-definition multimedia interface) is the world's first complete digital consumer AV interface complying with a non-compression standard.

HDMI allows you to enjoy high-definition digital images and high-quality sound by connecting the TV and the equipment.

HDMI-compatible equipment^(*1) with an HDMI or DVI output terminal, such as a DVD player, a set top box or a game equipment, can be connected to the HDMI terminal using an HDMI compliant (fully wired) cable.

For information about connections, see "External Equipment" (p. 92).

■ Applicable HDMI features

- Input audio signal : 2ch Linear PCM (sampling frequencies - 48 kHz, 44.1 kHz, 32 kHz)
- Input video signal : 480i, 480p, 576i, 576p, 720p, 1080i and 1080p
 - ➔ "Input signal that can be displayed" (p. 98)
 - Match the output setting of the digital equipment.
- Input PC signal : ➔ "Input signal that can be displayed" (p. 98)
 - Match the output setting of the PC.
- VIERA Link (HDAVI Control 5) : ➔ "VIERA Link" (p. 87)
- Content Type
- Deep Colour
- Audio Return Channel^(*3) (HDMI2 terminal only)

■ DVI connection

If the external equipment has only a DVI output, connect to the HDMI terminal via a DVI to HDMI adapter cable^(*2).

When the DVI to HDMI adapter cable is used, connect the audio cable to the audio input terminal (HDMI1 / 2 / 3: use COMPONENT-AUDIO terminals / HDMI4: use AV3 audio terminals).

Note

- Audio settings can be made on the "HDMI1 / 2 / 3 / 4 Input" in the Sound Menu. (p. 33)
- If the connected equipment has an aspect adjustment function, set the aspect ratio to "16:9".
- These HDMI connectors are "type A".
- These HDMI connectors are compatible with HDCP (High-Bandwidth Digital Content Protection) copyright protection.
- Equipment having no digital output terminal may be connected to the input terminal of either "COMPONENT", "S-VIDEO", or "VIDEO" to receive analogue signals.
- This TV incorporates HDMI™ technology.

(*1): The HDMI logo is displayed on HDMI-compliant equipment.

(*2): Enquire at your local digital equipment retailer shop.

(*3): Audio Return Channel (ARC) is a function to be able to send digital sound signals via an HDMI cable.

PC connection

A PC may be connected to this TV so that the PC screen is displayed and sound is heard from the TV.

- PC signals that can be inputted: Horizontal scanning frequency 31 to 69 kHz; vertical scanning frequency 59 to 86 Hz (more than 1,024 signal lines could result in incorrect display of the image).
- A PC adapter is not necessary for the DOS/V-compliant D-sub 15-pin connector.

Note

- Some PC models cannot be connected to this TV.
- When using PC, set the colour display quality of PC to the highest position.
- For details of the applicable PC signals
 - ➔ "Input signal that can be displayed" (p. 98)
- Max. display resolution

Aspect	4:3	1,440 × 1,080 pixels
	16:9	1,920 × 1,080 pixels

- D-sub 15-pin connector signal



Pin No.	Signal Name	Pin No.	Signal Name	Pin No.	Signal Name
①	R	⑥	GND (Ground)	⑪	NC (not connected)
②	G	⑦	GND (Ground)	⑫	NC (not connected)
③	B	⑧	GND (Ground)	⑬	HD (HSYNC)
④	NC (not connected)	⑨	NC (not connected)	⑭	VD (VSYNC)
⑤	GND (Ground)	⑩	GND (Ground)	⑮	NC (not connected)

Technical Information

USB connection

- It is recommended to connect the USB HDD or USB Flash Memory directly to the TV's USB ports.
- Some USB devices or USB HUB may not be used with this TV.
- You cannot connect any devices by using USB card reader.

■ The combination of USB devices that have been tested for each TV's USB port.

Combination of USB port 1 + port 2 (and vice versa):

- USB HDD + USB Flash Memory
- USB HDD + Wireless LAN Adaptor
- USB HDD + USB Keyboard
- USB Flash Memory + Wireless LAN Adaptor
- USB Flash Memory + USB Keyboard
- Wireless LAN Adaptor + USB Keyboard

Note

- Additional information for USB devices may be on the following web site. (English only)
<http://panasonic.jp/support/global/cs/tv/>

Input signal that can be displayed

COMPONENT (Y, P_B, P_R), HDMI

* Mark: Applicable input signal

Signal name	COMPONENT	HDMI
525 (480) / 60i	*	*
525 (480) / 60p	*	*
625 (576) / 50i	*	*
625 (576) / 50p	*	*
750 (720) / 60p	*	*
750 (720) / 50p	*	*
1,125 (1,080) / 60i	*	*
1,125 (1,080) / 50i	*	*
1,125 (1,080) / 60p	*	*
1,125 (1,080) / 50p	*	*
1,125 (1,080) / 24p		*

PC (from D-sub 15P)

Applicable input signal for PC is basically compatible to VESA standard timing.

Signal name	Horizontal frequency (kHz)	Vertical frequency (Hz)
640 × 400 @70 Hz	31.47	70.07
640 × 480 @60 Hz	31.47	59.94
640 × 480 @75 Hz	37.50	75.00
800 × 600 @60 Hz	37.88	60.32
800 × 600 @75 Hz	46.88	75.00
800 × 600 @85 Hz	53.67	85.06
852 × 480 @60 Hz	31.44	59.89
1,024 × 768 @60 Hz	48.36	60.00
1,024 × 768 @70 Hz	56.48	70.07
1,024 × 768 @75 Hz	60.02	75.03
1,024 × 768 @85 Hz	68.68	85.00
1,280 × 768 @60 Hz	47.70	60.00
1,280 × 1,024 @60 Hz	63.98	60.02
1,366 × 768 @60 Hz	48.39	60.04
Macintosh13" (640 × 480)	35.00	66.67
Macintosh16" (832 × 624)	49.73	74.55
Macintosh21" (1,152 × 870)	68.68	75.06

PC (from HDMI terminal)

Applicable input signal for PC is basically compatible to HDMI standard timing.

Signal name	Horizontal frequency (kHz)	Vertical frequency (Hz)
640 × 480 @60 Hz	31.47	60.00
750 (720) / 60p	45.00	60.00
1,125 (1,080) / 60p	67.50	60.00

Note

- Signals other than above may not be displayed properly.
- The above signals are reformatted for optimal viewing on your display.
- PC signal is magnified or compressed for display, so that it may not be possible to show fine detail with sufficient clarity.

FAQs

Before requesting service or assistance, please follow these simple guides to resolve the problem. If the problem still persists, please contact your local Panasonic dealer or Panasonic Customer Care Centre for assistance. For details → p. 108

Block noise, frozen or disappearing image occurs in digital mode / White spots or shadow image (ghosting) occurs in analogue mode / Some channels cannot be tuned

- Keep the space between the TV and RF cable.
- Check the position, direction and connection of the aerial or dish.
- Check “Signal Condition” (p. 43, 46 or p. 48). If “Signal Quality” is displayed in red, the digital signal is weak.
- Check your postcode area is able to receive the Freeview channels at www.freeview.co.uk
- Digital signals may be relatively low to prevent interference with analogue signals for the period of Digital Switchover. Check the schedule of Digital Switchover at www.digitaluk.co.uk
- Weather conditions will affect signal reception (heavy rain, snow, etc.), in particular in poor reception areas. Even during good weather, high pressure can cause poor reception of some channels.
- Due to the digital reception technologies involved, quality of the digital signals may be relatively low in some cases, despite good reception of analogue channels.
- Turn the TV off with the Mains power On / Off switch, and then on again.
- If problem persists, consult your local dealer.

Neither image nor sound is produced

- Is the TV in AV mode?
- Check the correct AV input mode is selected.
- Check the mains lead is plugged into the socket outlet.
- Has the TV been turned On?
- Check the Picture Menu (p. 32) and volume.
- Check all required cables and connections are firmly in place.

Auto aspect

- Auto aspect is designed to provide you with the best ratio to fill the screen. (p. 94)
- Press the ASPECT button if you would like to change the aspect ratio manually (p. 18).

freesat Auto Setup cannot be done completely

- Check connections and dish alignment. The dish needs to be pointing at Astra 2 at 28.2° East, and Eurobird 1 at 28.5° East.
- If the problem persists, consult your freesat registered retailer or call Freesat (UK) Ltd on 08450 990 990 or visit www.freesat.co.uk



S-Video / black and white picture

- A black and white picture may be seen when the TV is set to S-Video when the connected equipment is not. Change the setting on the TV (p. 28).
- Check that the output of the external equipment matches the input of the TV. If the output of the external equipment is set to S-Video, the TV must also be set to S-Video (p. 28).

Input mode, i.e. EC/AV1 remains on the screen

- Press the **i** button to clear this message. Press again to redisplay.

Q-Link function does not work

- Confirm SCART cable and connection. Also set “AV1 / AV2 out” in the Setup Menu (p. 34).

“VIERA Link” function does not work and an error message appears

- Confirm the connection. (p. 84 and p. 85)
- Turn the connected equipment on and then switch the TV on. (p. 87)

Recording does not start immediately

- Check the settings of the recorder. For details, read the manual of the recorder.

FAQs

	Problem	Actions
Screen	Chaotic image, noisy	<ul style="list-style-type: none"> ● Set "P-NR" in the Picture Menu (to remove noise). (p. 32) ● Check nearby electrical products (fluorescent lamp, DECT phones, mobile phones, microwave, etc.).
	No image can be displayed	<ul style="list-style-type: none"> ● Is "Contrast", "Brightness" or "Colour" in the Picture Menu set to the minimum? (p. 32) ● Please also refer to "Neither image nor sound is produced" (p. 99).
	Blurry or distorted image (no sound or low volume)	<ul style="list-style-type: none"> ● Reset channels. (p. 40 and p. 41) ● Please also refer to "Neither image nor sound is produced" (p. 99).
	Unusual image is displayed	<ul style="list-style-type: none"> ● Turn the TV Off with Mains power On / Off switch, then turn it On again. ● If the problem persists, perform "Shipping Condition" (p. 51).
Sound	No sound is produced	<ul style="list-style-type: none"> ● Is "Sound mute" active? (p. 8) ● Is the volume set to the minimum? ● Is Speaker Selection (VIERA Link) set to "TV"? ● Please also refer to "Neither image nor sound is produced" (p. 99).
	Sound level is low or sound is distorted	<ul style="list-style-type: none"> ● Sound signal reception may be deteriorated. ● Set "NICAM" (p. 33) in the Sound Menu to "Off". (Analogue only) ● Please also refer to "Neither image nor sound is produced" (p. 99).
	Unusual sound from the TV	<ul style="list-style-type: none"> ● When power is on, drive noise may be heard from inside the TV (not a sign of faulty operation).
Digital Channel	No programmes shown on TV Guide	<ul style="list-style-type: none"> ● Reset channels. (p. 40 and p. 41) ● Check the digital transmission by contacting Digital UK on 08456 50 50 50 or at www.digitaluk.co.uk ● Check the analogue broadcast (if still available in your area). ● Consult an aerial or dish engineer to check the alignment of your aerial or dish.
	Cannot find a channel you have previously watched	<ul style="list-style-type: none"> ● The channel may broadcast for part of the day. ● Check the channel in the TV Guide. (p. 20) ● Channel position numbers may be changed by broadcasters. ● Reset channels. (p. 40 and p. 41)
HDMI	Sound is unusual	<ul style="list-style-type: none"> ● Set the sound setting of the connected equipment to "2ch L.PCM". ● Check the "HDMI1 / 2 / 3 / 4 Input" setting in the Sound Menu. (p. 33) ● If digital sound connection has a problem, select analogue sound connection. (p. 97)
	Pictures from external equipment are unusual when the equipment is connected via HDMI	<ul style="list-style-type: none"> ● Check the HDMI cable is connected properly. (p. 92 - p. 93) ● Turn the TV and equipment Off, then turn them On again. ● Check an input signal from the equipment. (p. 97) ● Check the output resolution of the equipment. ● Use equipment compliant with EIA/CEA-861/861B.

	Problem	Actions
Network	Cannot connect to the network	<ul style="list-style-type: none"> ● Check the LAN cable or Wireless LAN Adaptor is connected properly. (p. 75) ● Check the connections and settings. (p. 75 - 79) ● Check the network equipment and network environment. ● The router may not be set to issue IP address automatically. If the network administrator prefers to allocate an IP address, set an IP address manually. (p. 77) ● The router may be using MAC address filtering (security setting). Confirm the MAC Address of this TV (p. 76) and set the router to be able to use it. ● If the problem persists, consult your Internet Service Provider or telecommunications company.
	Cannot select the file during DLNA operations	<ul style="list-style-type: none"> ● Is media server of the connected equipment prepared? (p. 74) ● Check applicable data format. (p. 74)
	Cannot operate VIERA CAST	<ul style="list-style-type: none"> ● Check the connections and settings. (p. 75 - 79) ● The server or connected line might be busy now.
Other	The TV does not switch On	<ul style="list-style-type: none"> ● Press and hold the standby On / Off switch on the remote control for about 1 second if Power LED is red. ● Check the mains lead is plugged into the socket. ● The fuse in the mains plug may have blown. Replace it with one of an identical rating (p. 4).
	The TV goes into Standby mode	<ul style="list-style-type: none"> ● Auto power standby function is activated. (p. 9) ● The TV enters Standby mode about 30 mins. after analogue broadcast ends.
	The remote control does not work or is intermittent	<ul style="list-style-type: none"> ● Are the batteries installed correctly? (p. 8) ● Has the TV been switched On? ● The batteries may be running low. Replace them. ● Point the remote control directly at the front of the TV (within about 7 m and a 30 degree angle of the front of the TV). ● Situate the TV so that sunshine or other sources of bright light do not shine on the TV's remote control signal receiver.
	Parts of the TV become hot	<ul style="list-style-type: none"> ● Temperature rises of parts of the front, top and rear panels will not pose any problems in terms of performance or quality of the TV.
	The LCD panel moves slightly when it is pushed with a finger Clattered sound might be heard	<ul style="list-style-type: none"> ● There is some flexibility around the panel to prevent damage to the panel. ● The panel might move slightly when it is pushed with a finger, and clattered sound might be heard. This is not a malfunction.
	There may be red spots, blue spots, green spots and black spots on the screen	<ul style="list-style-type: none"> ● This is a characteristic of liquid crystal panels and is not a problem. The liquid crystal panel is built with very high precision technology giving you fine picture details. Occasionally, a few non-active pixels may appear on the screen as a fixed point of red, green, blue or black. Please note this does not affect the performance of your LCD.
	Overcurrent error message appears	<ul style="list-style-type: none"> ● The connected USB device might cause this error. Remove the device and turn the TV Off with Mains power On / Off switch, then turn it On again. ● Check if foreign objects are inside the USB port.
	An error message appears	<ul style="list-style-type: none"> ● Follow the message's instructions. ● If the problem persists, contact your local Panasonic dealer or the authorized Service Centre.

On screen messages

Message	Meaning / Action
All contents will be lost. Are you sure to delete this device?	▶ ● Once you unregister the USB HDD, all the recorded programme will be erased.
All tuning data will be erased	▶ ● "Shipping Condition" will erase all tuning data (p. 51).
Are you sure ?	▶ ● Confirm correct operation.
Are you sure you want to delete this timer ? Press OK to delete timer. Press RETURN to return.	▶ ● Confirm correct operation.
Bad signal	▶ ● The signal is weak. Check the aerial is plugged in properly. It may be necessary to have an aerial installer check the signal and aerial alignment. ● Reset channels. (p. 40 and p. 41)
Cannot register another device because the list is full.	▶ ● Up to 8 USB HDDs can be registered with this TV.
Child Lock is active! Press OK to enter PIN.	▶ ● The selected channel is locked in Child Lock (p. 54). You must enter the PIN number before the channel will be displayed.
Faulty dish	▶ ● The satellite cable might be short-circuited or there might be connection problems of the cable. Check the cable and connection and then turn the TV Off with the Mains power On / Off switch, and turn it On again. ● If the message still persists, it may be necessary to have a dish installer check the dish and cable.
Feature not available.	▶ ● It is not possible to record from COMPONENT or HDMI. Connect the recorder to the TV using a fully wired SCART cable for recording from the TV tuner. ● Confirm Q-Link or VIERA Link settings (p. 84 - 87).
Feature not available. Press OK to view how it works.	▶ ● The selected feature on VIERA TOOLS is not available. Press the OK button to view the demonstration to explain how to use it.
Found new software version ***. Press OK to start update (may take 40 mins) or Press EXIT to ignore and you can update when TV is in standby	▶ ● There is a new software available.
Invalid operation - Please check settings and connections.	▶ ● Check the Q-Link or VIERA Link connection and setting (p. 84 - 87).
Invalid system time. Please exit !	▶ ● Cannot get the time information and cannot edit Timer Programming screen. Check the connection of the RF cable.
Invalid system time, Timer Programming will not work. Please press TV button on remote control and check time display on Banner	▶ ● Cannot get the time information. If there is no time displayed on the Information banner, check the connection of the RF cable.
Max. number of timers already set !	▶ ● The maximum number of timer programming events is 15.
New channels found! Press OK to update channel list. Press EXIT to ignore.	▶ ● There may be new channels available. ● This message will appear each time a change is made by the broadcasters. This message can be deactivated by setting "New Channel Message" to Off in "DVB Tuning Menu". Selecting OK will perform "Update Channel List".
No channel found. Please check aerial or local signal availability. Press OK to start Auto Setup.	▶ ● Follow the on screen instructions. ● Please also refer to p. 99. ● If channels are still not found, consult your local Panasonic dealer.
No module inserted	▶ ● Check the CI module is inserted completely (p. 57).
No recording - Already recording	▶ ● The equipment may already be recording.
No recording - Check media	▶ ● The tape or disc may be "write protected", full, missing or damaged.
No recording - Playing	▶ ● The equipment may be playing the tape or disc.
No recording - Unknown reason	▶ ● The recording may not be performed. Check the equipment.
No service	▶ ● The broadcaster has stopped the service. Check the channel in the TV Guide. (p. 20)
No signal	▶ ● The TV cannot detect the signal. Check the connection of the RF cable.
Overcurrent error on USB device occurred. Please remove the USB device, and switch off the TV by mains power switch.	▶ ● The connected USB device might cause overcurrent error. Follow the on screen instructions. ● Check if foreign objects are inside the USB port.

Message	Meaning / Action
PIN incorrect!	▶ ● The PIN number you entered is wrong.
Please check settings and connections on HDMI devices.	▶ ● Communication error in VIERA Link function (p. 87).
Please enter a frequency between 10700 and 12750 MHz.	▶ ● The frequency you entered is out of range. Consult the received satellite broadcasting company. (p. 48).
Please wait.	▶ ● A function is in progress.
Recording this channel now	▶ ● The recorder is recording the programme from its own tuner. You can turn the TV off and leave the equipment recording in the normal way.
Reset to Factory Shipping Condition Completed. Please switch off TV.	▶ ● "Auto Setup" will automatically start when Mains power On / Off switch is next turned On. (p. 12)
Sending Preset Data	▶ ● Q-Link or VIERA Link channel download is in progress.
Software successfully updated. Press EXIT to continue.	▶ ● The software updating is finished.
Software update failed. Please try again later. Press EXIT to continue.	▶ ● Perform "System Update Search Now" in System Update (p. 58). If this is still unsuccessful, there may not be any new software available.
The device is not directly connected to the TV. The device may not work correctly.	▶ ● Please do not connect the device via a USB HUB.
This timer will not follow the TV Guide information. Press OK to continue, RETURN to restore original timer.	▶ ● If you edit the start time or end time of Guide link programming by more than 10 minutes, it will no longer be performed as Guide link programming. The programming will be performed according to the time setting.
Timer already expired !	▶ ● The starting time in Timer Programming has already passed. Set the timer correctly (p. 53).
Timer Event Due to Start ***:*** has been programmed for External (USB HDD) recording at **:***	▶ ● This message will appear 2 mins. before timer programming event for external (USB HDD) recording due to start.
Timer incorrect !	▶ ● Set the start and end times in Timer Programming correctly (p. 53).
Timer overlap. Press OK to keep, RETURN to edit.	▶ ● Timer programming events are overlapped. Press the OK button to keep the overlapped setting. "Ext Rec." and "USB HDD Rec." are given priority over "Reminder". When two or more "Ext Rec." / "USB HDD Rec." overlap, the first timer programming event starts and finishes as programmed. The next timer programming event can then start.
Tuner Locked Press EXIT to unlock and stop recording	▶ ● If you want to unlock the tuner, cancel Direct TV Recording (p. 86 and p. 88), the recording of Timer Programming (p. 53) or One Touch Recording.
Unable to download, please check equipment	▶ ● The tape or disc is active. Stop the equipment and try again.
■ Media Player	
Cannot read file	▶ ● The file is damaged or unreadable. ● The TV does not support the format.(For the applicable formats and data ▶ p. 66)
No Device Inserted	▶ ● Confirm the SD Card or USB device is inserted correctly.
No valid file to play	▶ ● The card has no data.
Please confirm the Device is OK	▶ ● The inserted SD Card or USB device has a problem.
This operation is not possible	▶ ● The selected operation is not available.
■ Network	
An internal error occurred.	▶ ● Check the settings. (p. 76 - p. 79)
Cannot read file	▶ ● The file is broken or unreadable. Check applicable data format. (p. 74)
Communication with the server failed.	▶ ● This might be a problem of the media server. Read the manual of the server software.
Connection to the server failed.	▶ ● Check the connections and settings. (p. 75 - p. 79)
Server not found	▶ ● There are no available media server on your home network. Check the connections and settings. (p. 75 - p. 79)
The software update is not completed.	▶ ● Network download failed. Check the connections and settings. (p. 75 - p. 79)
Ethernet cable not connected	▶ ● Check the connection of the LAN cable. If you use a hub, also check the light on the hub is lit. ● The LAN cable might be defective.

Maintenance

First, remove the mains plug from the socket outlet.

Display panel, Cabinet, Pedestal

Regular care:

Gently wipe the surface of the display panel, cabinet, or pedestal by using a soft cloth to clean the dirt or fingerprints. For stubborn dirt:

Dampen a soft cloth with clean water or diluted neutral detergent (1 part detergent to 100 parts water). Then wring the cloth and wipe the surface. Finally, wipe away all the moisture.

Caution

- Do not use a hard cloth or rub the surface too hard. This may cause scratches on the surface.
- Take care not to subject the TV's surfaces to water or detergent more than requires. A liquid inside the TV could lead to product failure.
- Take care not to subject the surfaces to insect repellent, solvent, thinner or other volatile substances. This may degrade surface quality or cause peeling of the paint.
- The surface of the display panel is specially treated and may be easily damaged. Take care not to tap or scratch the surface with your fingernail or other hard objects.
- Do not allow the cabinet or pedestal to make contact with a rubber or PVC substance for a long time. This may degrade surface quality.

Mains plug

Wipe the mains plug with a dry cloth at regular intervals. Moisture and dust may lead to fire or electrical shock.

Glossary

■ AAC

Advanced Audio Coding - An advanced audio compression method

■ AVCHD

Advanced Video Codec High Definition - A standard for high definition video cameras that can be used to record and play high resolution HD images

■ DLNA

Digital Living Network Alliance

■ DVB

Digital Video Broadcasting

■ DVD

Digital Versatile Disc

■ DVI

Digital Visual Interface - A high quality video interface standard to connect to the display

■ EPG

Electronic Programme Guide - A digital guide showing scheduled programmes

■ HDMI

High-Definition Multimedia Interface - A digital audio and video interface for transmitting uncompressed digital signals on a single cable

■ JPEG

Joint Photographic Experts Group - A standard for compressing colour still pictures

■ LAN

Local Area Network

■ MAC Address

Media Access control Address

■ MPEG2

Moving Picture Experts Group phase 2 - A standard for efficiently compressing and expanding colour videos

■ MP3

MPEG Audio Layer 3 - A method for compressing audio data

■ NICAM

Near Instantaneous Companded Audio Multiplex - A format for digital sound over television

■ NTSC

National Television System Committee - One of the television signals used in USA, etc.

■ RF

Radio Frequency - Signal received from terrestrial aerial

■ RGB / S-Video / Video

Choose between these three video formats depending on personal preference and equipment requirement (RGB - Red, Green and Blue)

■ SCART

21 pin connection used for video, audio and switching signals (Also known as Euro SCART and Peritel)

■ Shop viewing environment

Shop viewing environment is the demonstration mode to explain main features of this TV in an easy understandable way. This mode will work if you select "Shop" in "Auto Setup" (p. 15).

■ SPDIF

A standard audio transfer file format

■ USB

Universal Serial Bus - An interface specification to connect devices

■ VCR

Video Cassette Recorder

Licence

Even if no special notation has been made of company or product trademarks, these trademarks have been fully respected.

- “freesat” is a registered trademark and the “freesat” logo is a trademark of Freesat (UK) Ltd.
- DVB and the DVB logos are trademarks of the DVB Project.
- VGA is a trademark of International Business Machines Corporation.
- Macintosh is a registered trademark of Apple Inc., USA.
- S-VGA is a registered trademark of the Video Electronics Standard Association.
- SDXC Logo is a trademark of SD-3C, LLC.
- HDMI, the HDMI Logo, and High-Definition Multimedia Interface are trademarks or registered trademarks of HDMI Licensing LLC in the United States and other countries.
- HDAVI Control™ is a trademark of Panasonic Corporation.
- “AVCHD” and the “AVCHD” logo are trademarks of Panasonic Corporation and Sony Corporation.
- Manufactured under license from Dolby Laboratories.
Dolby and the double-D symbol are trademarks of Dolby Laboratories.
- GUIDE Plus+ is (1) a registered trademark or trademark of, (2) manufactured under license from and (3) subject of various international patents and patent applications owned by, or licensed to, Gemstar-TV Guide International, Inc. and/or its related affiliates.
- VIERA CAST™ is a trademark of Panasonic Corporation.
- DLNA®, the DLNA Logo and DLNA CERTIFIED™ are trademarks, service marks, or certification marks of the Digital Living Network Alliance.
- Windows is a registered trademark of Microsoft Corporation in the United States and/or other countries.
- DivX® is a registered trademark of DivX, Inc., and is used under license.
- YouTube and Picasa are trademarks of Google, Inc.
- Skype™ is a trademark of Skype Limited.

The recording and playback of content on this or any other device may require permission from the owner of the copyright or other such rights in that content. Panasonic has no authority to and does not grant you that permission and explicitly disclaims any right, ability or intention to obtain such permission on your behalf. It is your responsibility to ensure that your use of this or any other device complies with applicable copyright legislation in your country. Please refer to that legislation for more information on the relevant laws and regulations involved or contact the owner of the rights in the content you wish to record or playback.

This product is licensed under the AVC patent portfolio license for the personal and non-commercial use of a consumer to (i) encode video in compliance with the AVC Standard (“AVC Video”) and/or (ii) decode AVC Video that was encoded by a consumer engaged in a personal and non-commercial activity and/or was obtained from a video provider licensed to provide AVC Video. No license is granted or shall be implied for any other use.
Additional information may be obtained from MPEG LA, LLC.
See <http://www.mpegla.com>.

GEMSTAR-TV GUIDE INTERNATIONAL, INC. AND/OR ITS RELATED AFFILIATES ARE NOT IN ANY WAY LIABLE FOR THE ACCURACY OF THE PROGRAM SCHEDULE INFORMATION PROVIDED BY THE GUIDE PLUS+ SYSTEM. IN NO EVENT SHALL GEMSTAR-TV GUIDE INTERNATIONAL, INC. AND/OR ITS RELATED AFFILIATES BE LIABLE FOR ANY AMOUNTS REPRESENTING LOSS OF PROFITS, LOSS OF BUSINESS, OR INDIRECT, SPECIAL, OR CONSEQUENTIAL DAMAGES IN CONNECTION WITH THE PROVISION OR USE OF ANY INFORMATION, EQUIPMENT, OR SERVICES RELATING TO THE GUIDE PLUS+ SYSTEM.

<http://www.europe.guideplus.com/>

Index

- A** Accessories 6
 - Advanced Picture Settings 60
 - Analogue Tuning Menu 41, 46
 - Aspect 18, 94
 - Astra 1 49
 - Astra 2 10, 49, 99
 - Audio Description 19, 33
 - Auto Setup 12, 40, 41
 - Auto Standby 36
 - AV1 / AV2 out 34, 86
- B** Banner Display Timeout 35
- C** Cable TV box 11, 93
 - Category list 21
 - C.A.T.S. 32
 - Channel Genre 20
 - Channel List 43, 45, 47, 50
 - Channel Sorting by Region 44
 - Child Lock 54
 - Clamper 8
 - Common Interface 57
 - COMPONENT 93, 98
 - Connection 10, 11, 62, 66, 75, 84, 85, 92, 93
- D** Direct TV Recording 86, 88
 - Dish alignment 10, 99
 - DivX 95
 - DLNA 74
 - D-sub 15-pin 97
 - DVB Tuning Menu 41, 44
 - DVI 97
 - DVI Input Setting 36
 - DVD Recorder 11, 29, 92
- E** EPG 20, 21
 - Eurobird 1 10, 99
 - External equipment 11, 28, 92, 93
 - External input 28, 29
- F** FAQs 99-101
 - Favourites Edit 43, 45, 50
 - Free input menu 31, 96
 - freesat Tuning Menu 40, 42
- G** Glossary 104
 - Guide link programming 23
 - GUIDE Plus+ Settings 36
- H** HDMI 96, 97, 107
 - HDMI Content Detection 34
 - Hold 17, 26
 - Home Cinema 91
 - Hotbird 49
- I** Information banner 17
 - Input Labels 55
 - Input signal 98
 - Intelligent Frame Creation 36
- L** Last view 19
 - Licence 105
- M** Mains Lead 10
 - Mains power On / Off switch 9, 12
 - Maintenance 104
 - Manual Tuning 44, 47, 48
 - Media Player 66-73
 - Menu Functions 31-39
 - Mode 33
 - Monaural Audio 19
 - Multi Audio 19
 - Music Mode 73
- N** Network connections 75
 - Network Setup 76
 - New Channel Message 46
 - NICAM 33
 - NTSC 32, 107
- O** Off Timer 19, 34
 - One Touch Recording 65
 - Other Sat. Tuning Menu 48
 - Optional accessories 6
 - Owner ID 14, 56
- P** PAL 107
 - PC 59, 97
 - Pedestal 7
 - Photo mode 68
 - PIN number 14, 54, 56
 - Playing Time Display 35
 - P-NR 32
 - Power and Timer LED 9, 22, 52, 65
- Q** Q-Link 34, 84, 86
 - Q-Link Download 12, 34
 - Quick Start Guide 6-15
- R** Radio Mode 35
 - Remote control 6, 8
 - Reset to Defaults 32, 33
 - Reversal Film Effect 32
 - Rewind LIVE TV 65
 - RGB 107
- S** Safely remove USB 19, 63, 67
 - Sales and Support Information 108
 - SCART 96, 107
 - SD Card 66, 94
 - Search list 20, 21
 - Shipping Condition 51
 - Signal Condition 43, 46, 48
 - Slideshow 68, 81
 - Specifications 107
 - Split Programme 23
 - Subtitles 18, 27
 - S-Video 96, 107
 - System Update 58
- T** Teletext 25-27
 - Timer Programming 22, 52
 - True Cinema 32
 - TV Guide 20-24
- U** Update Channel List 46
 - USB Flash Memory 66
 - USB HDD 62
 - USB Keyboard 83
- V** V-Audio Surround 33
 - VCR 11, 29, 92
 - Video mode 70
 - VIERA CAST 83
 - VIERA Link 84, 85, 87-91
 - VIERA TOOLS 30
 - Viewing Mode 32
 - Vivid Colour 32
 - Volume Correction 19, 33
- W** Wireless LAN Adaptor 6, 13, 75
 - WSS 94
- Z** Zoom 18

Specifications

		TX-L32G20B	TX-L37G20B	
Power Source		AC 220-240 V, 50 Hz		
Rated Power Consumption		105 W	146 W	
Standby Power Consumption		0.25 W 23 W (With monitor out recording)	0.25 W 19 W (With monitor out recording)	
Display panel	Aspect Ratio	16:9		
	Visible screen size	80 cm (diagonal) 697 mm (W) × 392 mm (H)	94 cm (diagonal) 819 mm (W) × 460 mm (H)	
	Number of pixels	2,073,600 (1,920 (W) × 1,080 (H))		
Sound	Speaker	160 mm × 42 mm × 2 pcs, 8 Ω		
	Audio Output	20 W (10 W + 10 W), 10% THD		
	Headphones	M3 (3.5 mm) stereo mini Jack × 1		
PC signals		VGA, SVGA, WVGA, XGA SXGA, WXGA (compressed) Horizontal scanning frequency 31 - 69 kHz Vertical scanning frequency 59 - 86 Hz		
Receiving Systems / Band name		DVB-S / S2 (freesat / Other Sat.) : freesat services via Satellite dish input. Receiver frequency range - 950 MHz to 2,150 MHz LNB Power and Polarisation - Vertical: +13 V Horizontal: +18 V Current: Max. 500 mA (overload protection) 22 kHz Tone - Frequency: 22 kHz ± 2 kHz Amplitude: 0.6 V ± 0.2 V Symbol Rate - Max. 30 MS/s FEC Mode - 1/2, 3/5, 2/3, 3/4, 4/5, 5/6, 8/9, 9/10 Demodulation- QPSK, 8PSK Not available for DiSEqC control. DVB-T / T2 : Digital terrestrial services via UHF aerial input. PAL I : UHF E21-68 PAL 525/60 : Playback of NTSC tape from some PAL Video recorders (VCR) or NTSC disc playback from DVD player and recorder. M.NTSC : Playback from M.NTSC Video recorders (VCR). NTSC (AV input only) : Playback from NTSC Video recorders (VCR).		
Satellite dish input		Female F-type 75 Ω		
Aerial input		UHF		
Operating Conditions		Temperature : 0 °C - 35 °C Humidity : 20 % - 80 % RH (non-condensing)		
Connection Terminals	AV1 (SCART terminal)	21 Pin terminal (Audio/Video in, Audio/Video out, RGB in, Q-Link)		
	AV2 (SCART terminal)	21 Pin terminal (Audio/Video in, Audio/Video out, RGB in, S-Video in, Q-Link)		
	AV3	VIDEO	RCA PIN Type × 1	1.0 V[p-p] (75 Ω)
		AUDIO L - R	RCA PIN Type × 2	0.5 V[rms]
	COMPONENT	VIDEO	Y	1.0 V[p-p] (including synchronization)
		AUDIO L - R	P_B, P_R	±0.35 V[p-p]
	Others	HDMI 1 / 2 / 3 / 4	TYPE A Connectors HDMI1 / 3 / 4: HDMI (Version 1.4 with Content Type) and HDMI (Version 1.3a with Deep Colour) HDMI2 : HDMI (Version 1.4 with Content Type, Audio Return Channel) and HDMI (Version 1.3a with Deep Colour) ● This TV supports "HDAVI Control 5" function.	
			PC	HIGH-DENSITY D-SUB 15PIN R,G,B/0.7 V[p-p] (75 Ω) HD, VD/TTL Level 2.0 - 5.0 V[p-p] (high impedance)
		Card slot	SD Card slot × 1 Common Interface slot × 1	
		ETHERNET	RJ45, IEEE802.3 10BASE-T / 100BASE-TX	
		USB 1 / 2	USB2.0 DC 5 V, Max 500 mA ● For available USB devices → p. 98	
		Output	AUDIO L - R	RCA PIN Type × 2
DIGITAL AUDIO OUT	PCM / Dolby Digital, Fiber optic			
Dimensions (W × H × D)		779 mm × 542 mm × 217 mm (With Pedestal) 779 mm × 503 mm × 86 mm (TV only)	896 mm × 612 mm × 287 mm (With Pedestal) 896 mm × 569 mm × 90 mm (TV only)	
Mass		11.5 kg Net (With Pedestal) 10.0 kg Net (TV only)	15.5 kg Net (With Pedestal) 13.0 kg Net (TV only)	

- Design and Specifications are subject to change without notice. Mass and Dimensions shown are approximate.
- This equipment complies with the EMC standards listed below.
EN55013, EN61000-3-2, EN61000-3-3, EN55020, EN55022, EN55024

Information for Users on Collection and Disposal of Old Equipment and used Batteries



These symbols on the products, packaging, and/or accompanying documents mean that used electrical and electronic products and batteries should not be mixed with general household waste. For proper treatment, recovery and recycling of old products and used batteries, please take them to applicable collection points, in accordance with your national legislation and the Directives 2002/96/EC and 2006/66/EC.

By disposing of these products and batteries correctly, you will help to save valuable resources and prevent any potential negative effects on human health and the environment which could otherwise arise from inappropriate waste handling.

For more information about collection and recycling of old products and batteries, please contact your local municipality, your waste disposal service or the point of sale where you purchased the items.

Penalties may be applicable for incorrect disposal of this waste, in accordance with national legislation.



For business users in the European Union

If you wish to discard electrical and electronic equipment, please contact your dealer or supplier for further information.

[Information on Disposal in other Countries outside the European Union]

These symbols are only valid in the European Union. If you wish to discard these items, please contact your local authorities or dealer and ask for the correct method of disposal.



Note for the battery symbol (bottom two symbol examples):

This symbol might be used in combination with a chemical symbol. In this case it complies with the requirement set by the Directive for the chemical involved.

Cd

Sales and Support Information

Customer Care Centre

- For customers within the UK: **0844 844 3852**
- For customers within the Republic of Ireland: **01 289 8333**
- Visit our website for product information: **www.panasonic.co.uk**
- E-mail: **customer.care@panasonic.co.uk**

Direct Sales at Panasonic UK

- For customers: **0844 844 3856**
- Order accessory and consumable items for your product with ease and confidence by phoning our Customer Care Centre Monday – Thursday 9:00am – 5:30pm, Friday 9:30am – 5:30pm (Excluding public holidays).
- Or go on line through our Internet Accessory ordering application at **www.pas-europe.com**.
- Most major credit and debit cards accepted.
- All enquiries transactions and distribution facilities are provided directly by Panasonic UK Ltd.
- It couldn't be simpler!
- Also available through our Internet is direct shopping for a wide range of finished products, take a browse on our website for further details.



Declaration of Conformity (DoC)

If you want to get a copy of the original DoC of this TV, please visit the following website:

<http://www.doc.panasonic.de>

Authorized Representative:

Panasonic Testing Centre

Panasonic Marketing Europe GmbH

Winsbergring 15, 22525 Hamburg, Germany

Customer's Record

The model number and serial number of this product may be found on its rear panel. You should note this serial number in the space provided below and retain this book, plus your purchase receipt, as a permanent record of your purchase to aid in identification in the event of theft or loss, and for Warranty Service purposes.

Model Number

Serial Number

Panasonic (U. K.) Ltd.

Willoughby Road, Bracknell, Berks RG12 8FP

Web Site : <http://panasonic.net>

© Panasonic Corporation 2010

Printed in Czech Republic