

**Panasonic**

Telephone Answering System  
with Facsimile

**KX-F2700E-G**

Model No. **KX-F2700E-W**

# **O**PERATING **I**NSTRUCTIONS



Please read these Operating  
Instructions before using the unit.

# Table of Contents

<b>1 Installation and Connection to the Telephone Line</b> .....	5	<b>7 Automatic Dialling</b> .....	30
Installing your unit .....	5	Storing tel/fax numbers for automatic dialling .....	30
Installing the recording paper .....	6	Making voice calls using automatic dialling .....	32
Installing the batteries .....	7	Transmitting documents using automatic dialling .....	32
Location of controls .....	8	<b>8 Copier Function</b> .....	33
Answering control buttons .....	9	Making a copy .....	33
Recording greeting messages .....	10	<b>9 Advanced Operations</b> .....	34
<b>2 Setting the Date, Time, Logo and ID</b> .....	12	Electronic telephone directory .....	34
Setting the date and time .....	12	Polling .....	35
Setting your logo .....	12	Delayed transmission .....	36
How to enter letters and symbols .....	13	Remote fax receiving using an extension phone .....	37
Setting your facsimile telephone number/ID number .....	15	Junk mail prohibitor .....	38
Setting the transmission report printing .....	15	Special settings .....	40
<b>3 Selecting the Receiving Mode</b> .....	16	Voice contact .....	46
ANS/FAX mode .....	17	TONE, RECALL and PAUSE buttons .....	47
TEL/FAX mode .....	18	Voice mailbox .....	48
FAX only mode .....	20	Operating the answering device from a remote phone .....	52
<b>4 Making/Receiving Voice Calls</b> .....	21	Pager alert .....	57
Making voice calls .....	21	The Mercury Residential Service .....	58
Helpful hint for setting the dialling mode .....	21	Printing reports and lists .....	62
Adjusting volumes .....	22	User programmable features .....	66
Voice muting .....	22	<b>10 Troubleshooting and Maintenance</b> .....	68
Redialling the last dialled number .....	22	Error messages on the display .....	68
Answering voice calls .....	22	General corrective measures .....	69
<b>5 Making/Receiving Fax Calls</b> .....	23	Explanation of communication result on the report .....	70
Documents you can send .....	23	Clearing a recording paper jam .....	71
Loading documents .....	24	Clearing a document jam .....	72
Setting resolution .....	24	Adjusting the feeder pressure .....	72
Sending 16 or more sheets .....	24	Cleaning the document feeder unit .....	73
Transmitting documents .....	25	Cleaning the thermal head .....	73
Receiving documents .....	25	<b>11 General Information</b> .....	74
<b>6 Operating the Answering Device</b> .....	26	Important Safety Instructions .....	74
Setup of voice message and document reception .....	26	Important Information .....	75
Listening to recorded messages .....	26	Fitting a plug to the mains lead .....	76
Functions during playback .....	27	Specifications .....	77
Erasing recorded messages .....	27	Index .....	78
Recording a memo message .....	28	FAX CORRESPONDENCE .....	79
Recording a telephone conversation .....	28	Speed dialler list .....	80
Setting the message alert .....	29	Answering device remote control card .....	81
Setting the recording time alert .....	29	Guarantee .....	83

# Flow Chart for Basic Operations

The operating instructions are set out in the following order:

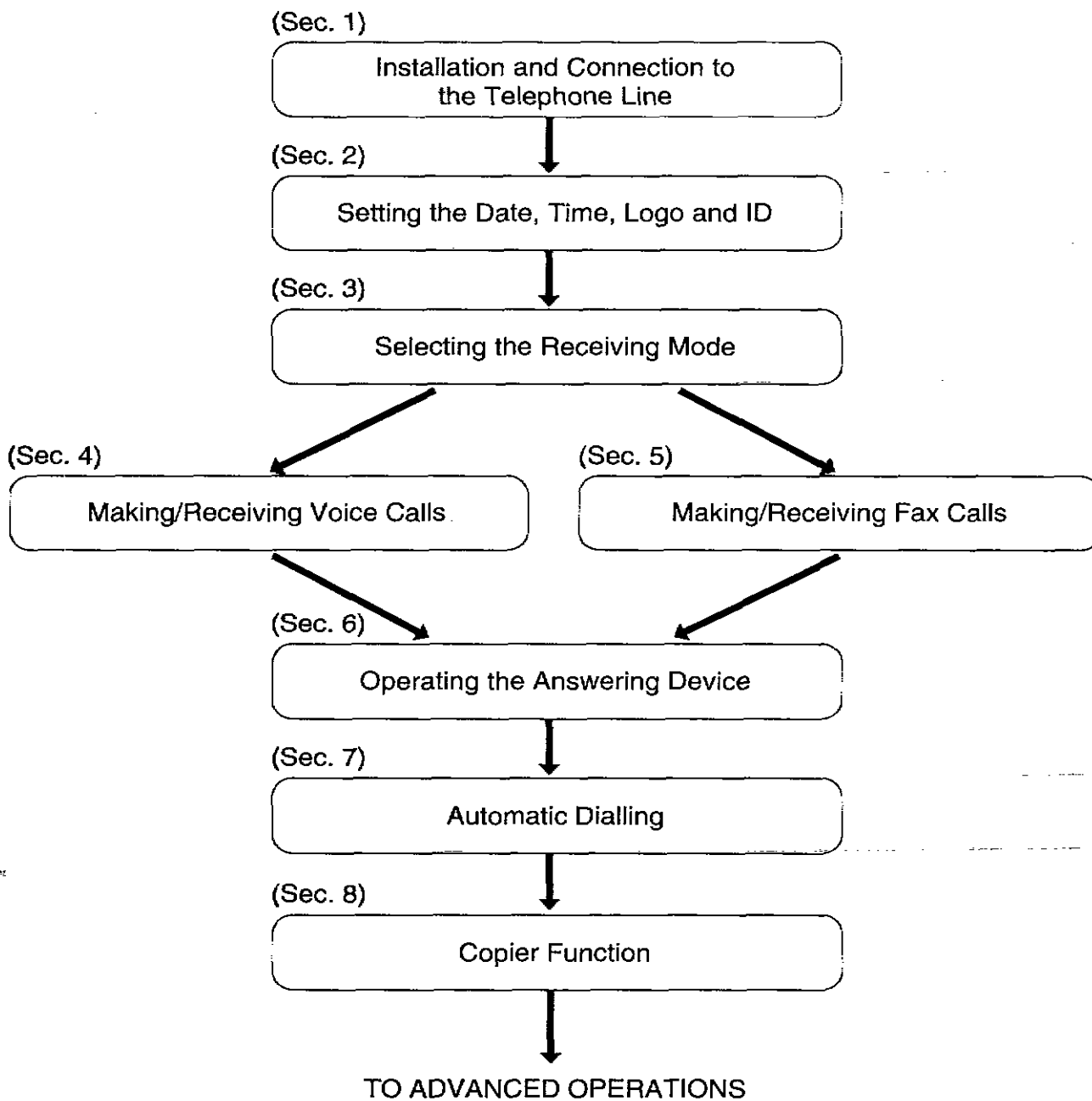

**Thank you for purchasing the Panasonic Telephone Answering System with Facsimile.**

The product is available in either grey (KX-F2700E-G) or white (KX-F2700E-W).  
 The photo on the cover page shows KX-F2700E-G and it may vary slightly from the actual product.

### HELP function

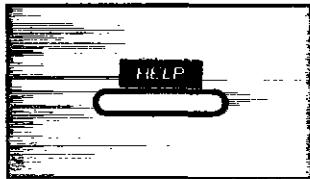

Use this function if the instructions are lost while using the unit. It will provide the user with instructions.

When the HELP button is pressed, the unit will print a quick reference.

### Accessories

Mains lead . . . . . 1 pc.  
 (Part No. PQJA10013Z)

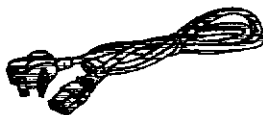

(page 5)

Telephone line cord . . . . . 1 pc.  
 (Part No. PQJA87T)



(page 5)

Paper stacker . . . . . 1 pc.  
 (Part No. PQUS10136Z)

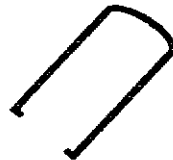

(page 5)

R6 (UM-3, AA) size battery . . . . . 4 pcs.



(Page 7)

Recording paper . . . . . 1 pc.  
 (210 mm width, 1 inch core)

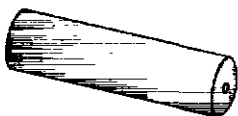

(page 6)

Handset . . . . . 1 pc.  
 (Part No. PQJXD1207Z for grey, PQJXD1205Z for white)

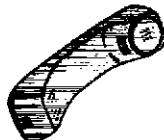

(page 5)

Handset cord . . . . . 1 pc.  
 (Part No. PQJA212N for grey, PQJA212M for white)



(page 5)

- For further accessory orders please contact either your local Panasonic Authorised Dealer or our spare parts distributor SEME Ltd. on 01280 823523 (or fax 01280 814916).
- Any part numbers listed above are subject to change without notice.

# 1 Installation and Connection to the Telephone Line

## Installing your unit

### Front view

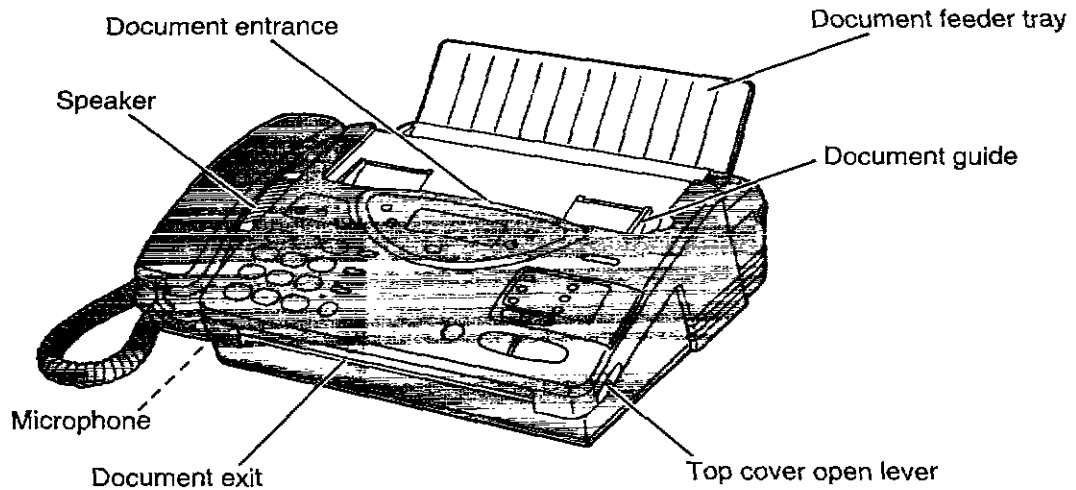

### Rear view

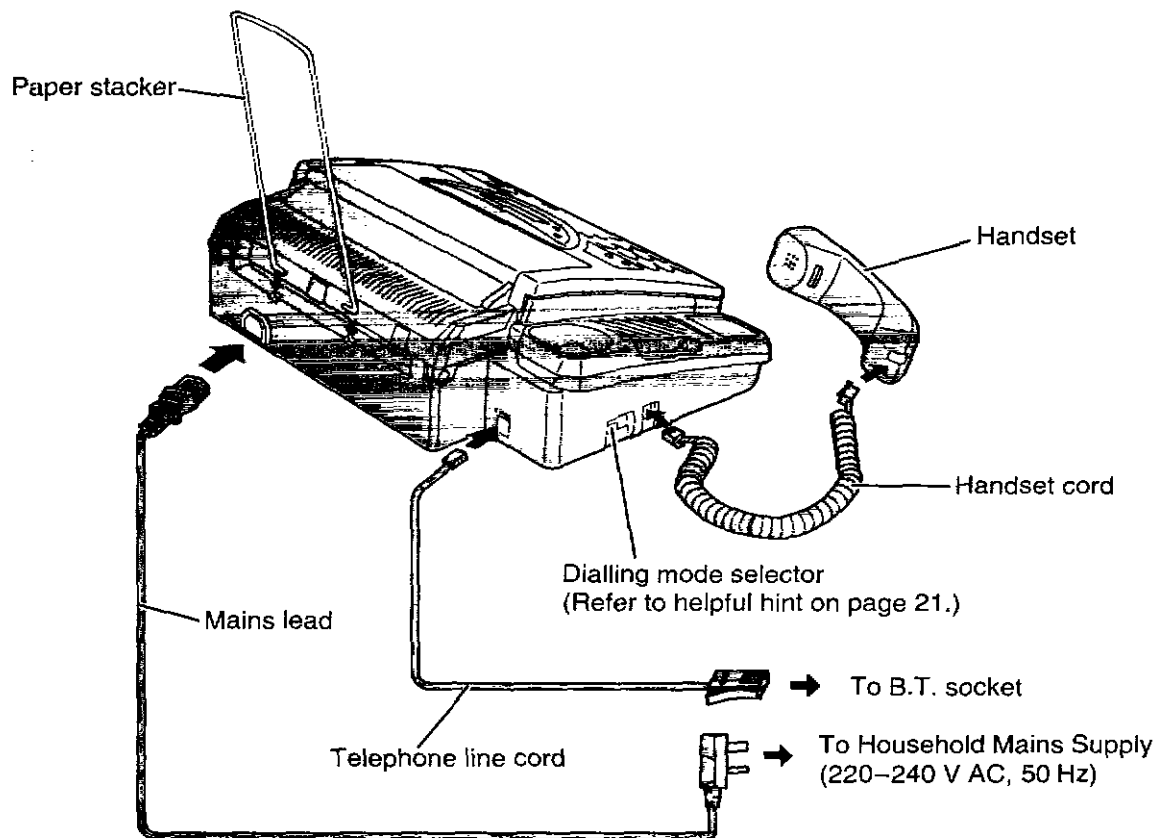

### Notes:

- When a mains power failure takes place, you are only able to use the unit as a standard telephone.
- When you operate this product, the mains socket outlet should be near the product and be easily accessible.
- Telephone line connection and handset connection are at TNV (Telecommunication Network Voltage).

## Installing the recording paper

When the recording paper is not installed or the unit runs out of paper, the display will show "OUT OF PAPER". Install the recording paper by following the steps below.

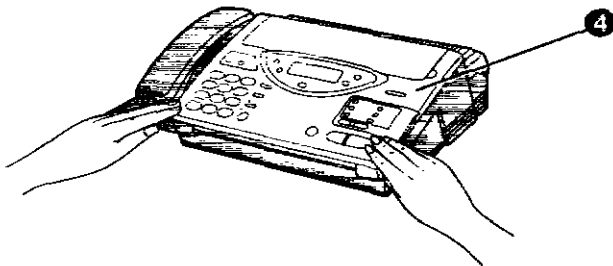
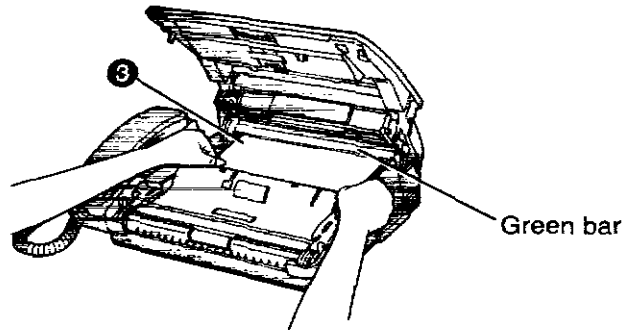
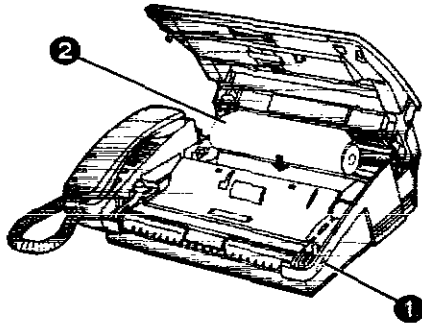

- 1 Slide the lever toward you to open the top cover.
- 2 Insert the recording paper roll in the unit.  
—Make sure that the shiny side of the paper is facing up and that there is no slack, tape or glue residue on the paper roll. (See notes below.)
- 3 Insert the leading edge of the recording paper under the green bar.
- 4 Close the top cover carefully by gently pressing down on both ends.  
—Do not slam the lid.

### Notes:

- Use only the included roll or equivalent recording paper, or else the print quality may be affected and/or excessive thermal head wear may occur.  
Equivalent recording paper sizes are; 210 mm x 30 m roll with 1 inch core, 210 mm x 50 m roll with 1 inch core.
- The start of some recording paper is secured using glue or tape. Residue from this glue/tape may cause the paper cutter to jam immediately following installation of a new roll. To prevent this, cut approximately 150 mm (6 inches) from the new roll of paper prior to installation.

## Installing the batteries

The batteries are required to retain voice messages in memory when the power cord is disconnected or during a power failure. If you do not install the batteries or if the battery power is low, the display will show "BATTERY LOW". Install four R6 batteries by following the steps below.

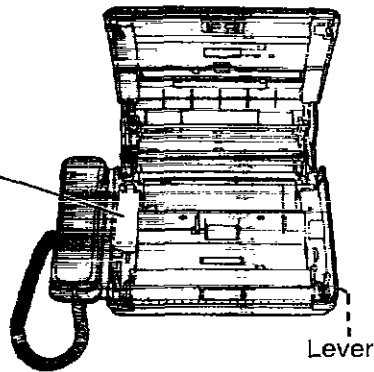
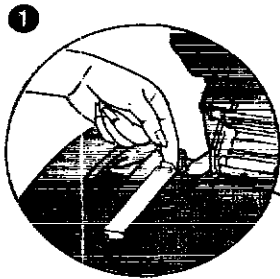

- 1 Slide the lever toward you to open the top cover and remove the battery compartment cover by pulling the hook toward you and lifting it up.
- 2 Install four batteries ensuring that the polarity is correct.
- 3
  - A Replace the battery compartment cover by installing the tab of the cover into the hole first.
  - B Press down the part marked "PRESS" until it clicks.
- 4 Close the top cover.

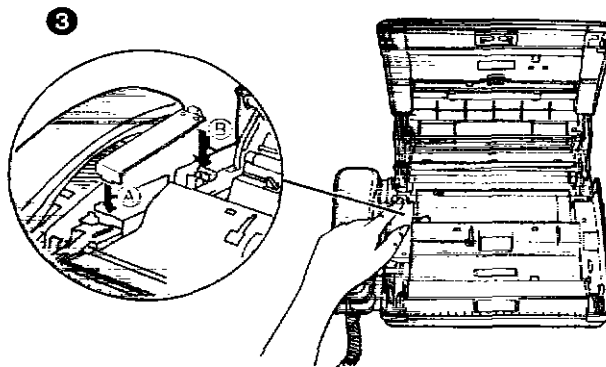
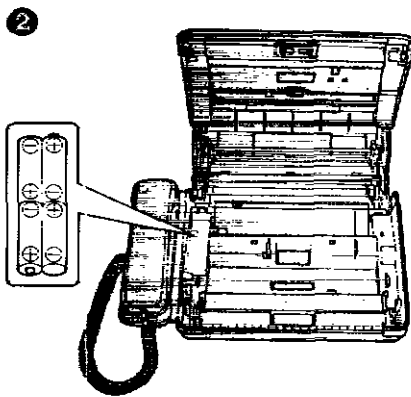

### Battery precautions:

- The batteries should be used correctly, otherwise, the unit may be damaged due to battery leakage.
- Do not mix different types of batteries.
- Do not charge, short-circuit, disassemble, heat or dispose in fire.
- Remove all the batteries when replacing.

### Notes:

- If you do not install the batteries, or if the battery power is low, the greeting and incoming message will be erased when a power failure occurs.
- Batteries should be installed in order to provide message retention during a power failure. Message retention time is approximately 1 day with new batteries.
- To avoid losing the greeting and all messages saved in memory, the power cord must remain connected when replacing batteries.
- Disconnect the telephone line cord before opening the battery compartment cover.
- Replace all the batteries once a year or after a major power failure.
- Do not use Nickel-Cadmium batteries.

## Location of controls

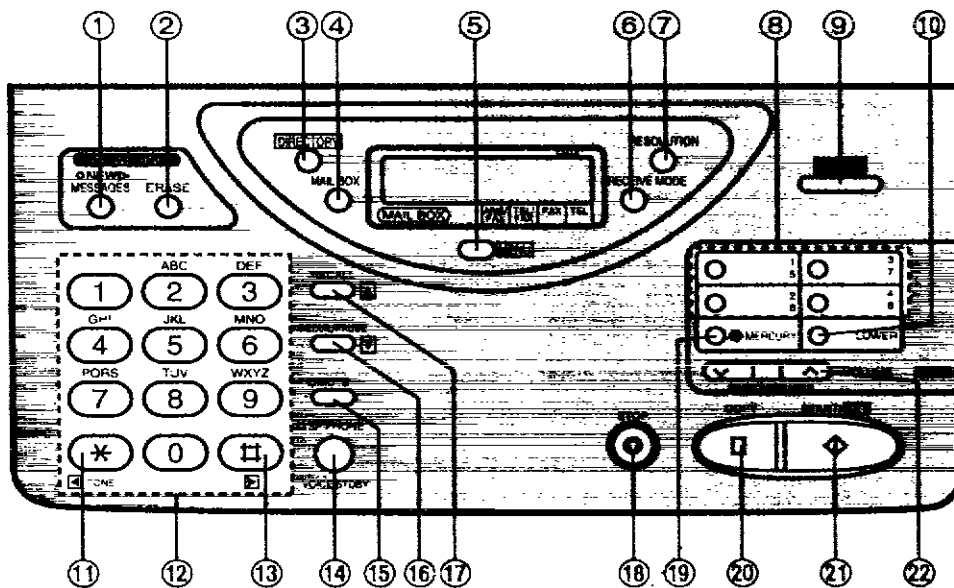

- ① **NEW MESSAGES button** (page 26)  
Used to play back only new messages.
- ② **ERASE button** (page 27)  
Used to erase recorded incoming messages.
- ③ **DIRECTORY button** (pages 32 and 34)  
Used for speed dialling. Also used for the electronic telephone directory.
- ④ **MAIL BOX button** (page 50)  
Used to select a voice mailbox number.
- ⑤ **MENU button**  
Used to start and exit various programming.
- ⑥ **RECEIVE MODE button** (page 16)  
Used to select the desired receiving mode.
- ⑦ **RESOLUTION button** (page 24)  
Used to adjust scanning line density.
- ⑧ **Direct call station keys** (pages 14, 30 and 32)  
Used for one-touch dialling. Also used as character keys when logo and station names are programmed.
- ⑨ **HELP button** (page 4)  
Used to print an easy guide for operations.
- ⑩ **LOWER key** (pages 30 and 32)  
Used to access lower stations (5 to 8) for one-touch dialling.
- ⑪ **TONE/◀ button** (pages 13 and 47)  
Used to temporarily change the dialling mode from pulse to tone during a dialling operation. Also used to move the cursor to the left while programming.
- ⑫ **Dial keypad**  
Used for dialling operation and parameter setting. Also used as character keys.
- ⑬ **Hash/▶ button** (pages 13 and 15)  
Used to enter a space in your telephone number while programming. Also used to move the cursor to the right while programming.
- ⑭ **SP-PHONE/VOICE STDBY button** (pages 21 and 46)  
Used for on-hook dialling, handsfree speech and voice contact features.
- ⑮ **MUTE button** (page 22)  
Used for voice muting.
- ⑯ **REDIAL/PAUSE button** (pages 22 and 47)  
Used to redial the last dialled number. Also used to insert a pause into a phone number.
- ⑰ **RECALL button** (page 47)  
Used to access some features of your host exchange.
- ⑱ **STOP button** (page 25)  
Used to stop fax communication.
- ⑲ **MERCURY button** (page 59)  
Used to store the Mercury access number and authorisation (PIN) code, and make calls using the Mercury network.
- ⑳ **COPY button** (page 33)  
Used to start copying.
- ㉑ **START/SET button**  
Used to start fax communication. Also used to store parameters during programming.
- ㉒ **VOLUME buttons** (page 22)  
Used to adjust the volume level of the ringer and speaker.



## Answering control buttons

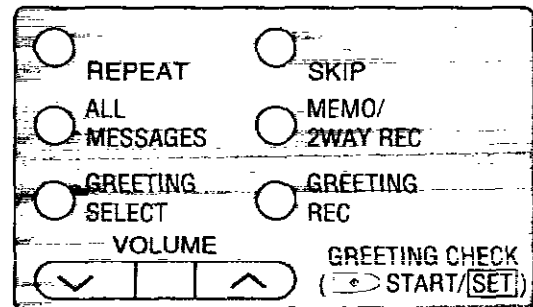
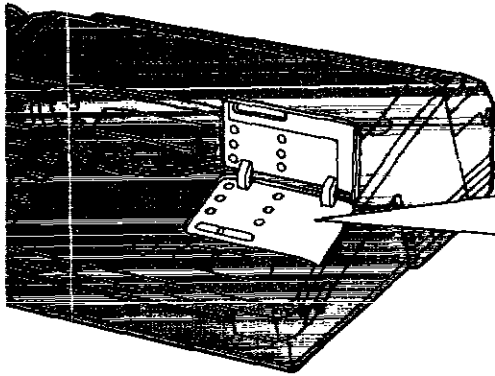

- ① **REPEAT button** (page 27)  
Used to replay the previous message during the message playback.
- ② **ALL MESSAGES button** (page 26)  
Used to play back all the recorded messages.
- ③ **GREETING SELECT button** (pages 10 and 48)  
Used to select a desired greeting message when recording or checking that message.
- ④ **SKIP button** (page 27)  
Used to skip to the next message during playback.
- ⑤ **MEMO/2WAY REC button** (page 28)  
Used to start and stop recording a memo message or a telephone conversation.
- ⑥ **GREETING REC button** (pages 10 and 48)  
Used to start recording a greeting message.

## Recording greeting messages

Before using the unit as an answering device and a facsimile, record two types of greeting messages, referring to the examples on page 11.

One is the message for the *ANS/FAX* mode, and the other is for the *TEL/FAX* mode.

The greeting message for the *ANS/FAX* mode tells a caller that you are unable to answer, and allows the caller to leave a voice message or to send a fax message.

The greeting message for the *TEL/FAX* mode tells a caller that the unit is ringing and allows the caller to wait until you answer the call or to send a fax message.

## How to record greeting messages

Recording time is limited to 16 seconds for each message. However, for optimum performance, it is recommended to record a greeting message within 12 seconds. Perform the following steps to record each of the messages.

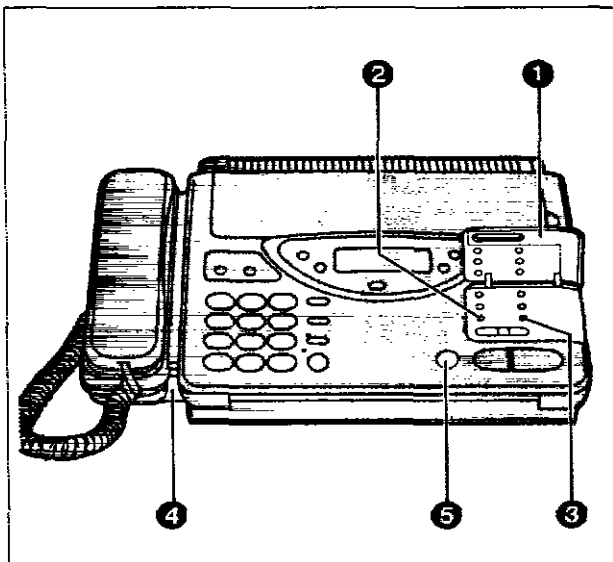

- 1 Open the station key panel.

- 2 ■ For the *ANS/FAX* mode:  
Press **GREETING SELECT**.

ANS-GREETING

- For the *TEL/FAX* mode:  
Press **GREETING SELECT** repeatedly until the following is displayed.

TEL-GREETING

- 3 Press **GREETING REC**.

*Example: Recording for the ANS/FAX mode.*

ANS REC. 16s

—A beep will be heard.

- 4 Immediately after the beep, speak clearly and loudly into the microphone from a distance of approximately 200 mm (8 inches).

- 5 When finished, press **STOP**.

—After the beep, the unit will playback the message so that you can confirm it.  
Adjust the speaker's volume to a suitable level by pressing the **VOLUME** buttons.

### Notes:

- If you make a mistake while recording, repeat from step 2.
- You can record the greeting message for the *ANS/FAX* mode by directly pressing the **GREETING REC** button without pressing the **GREETING SELECT** button.
- It is helpful to include a statement of your answering telephone number with the town name or code in the greeting message. The greeting message should begin within 3 seconds of answering the call.

## Suggested messages

### ■ For the ANS/FAX mode:

"This is (your name, business and/or telephone number). We are unable to answer right now. To send a fax, start transmission. To leave a message, speak for up to 2 minutes 30 seconds (or 'speak for up to 1 minute') after the long beep. If the beep sounds 6 times, your message will not be recorded. Please call back tomorrow. Thank you."

### ■ For the TEL/FAX mode:

"This is (your name, business and/or telephone number). Please wait for someone to answer the line. To send a fax, start transmission."

## Checking greeting messages

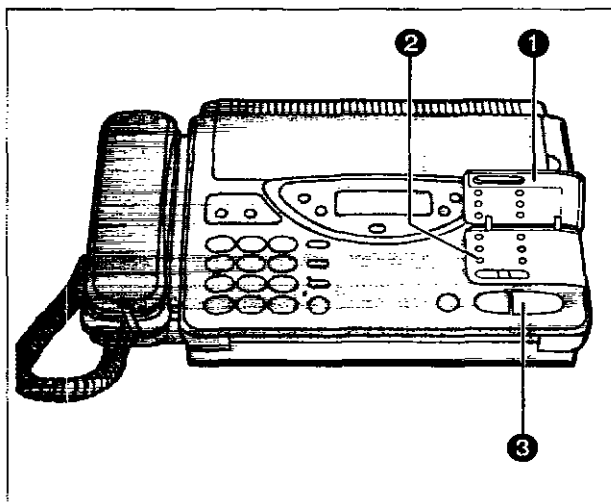

① Open the station key panel.

② ■ Checking the greeting message for the ANS/FAX mode:  
Press GREETING SELECT.

ANS-GREETING

■ Checking the greeting message for the TEL/FAX mode:  
Press GREETING SELECT repeatedly until the following is displayed.

TEL-GREETING

③ Press START/SET.  
—After the beep, the unit will play back the message.

### Notes:

- Adjust the speaker volume using the VOLUME button (see page 22).
- You can check the greeting message for the ANS/FAX mode by directly pressing the START/SET button without pressing the GREETING SELECT button.

## Setting the caller's recording time

You can choose from two lengths of recording times for incoming messages.

**LONG:** The unit will record an incoming message up to 2 minutes 30 seconds per message (pre-selected setting).

**SHORT:** The unit will record an incoming message up to 1 minute per message.

To change the recording time, proceed as follows:



Press MENU.

1.SYSTEM SET UP

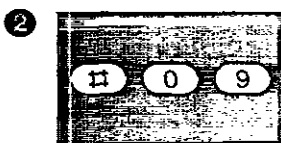

Press #09.

RECORDING TIME

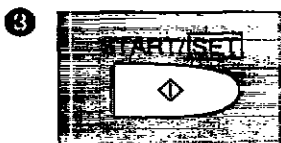

Press START/SET.

MODE=LONG [▲▼]

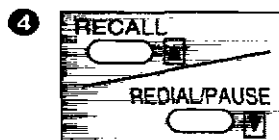

Press ▲ or ▼ to select the desired mode.



Press START/SET to store the setting.

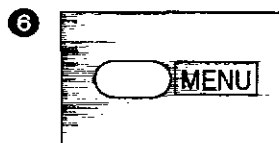



Press MENU to end the program.

## 2 Setting the Date, Time, Logo and ID

### Setting the date and time

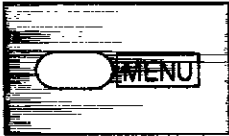
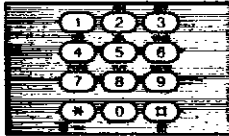
The internal clock of the unit will print the date and time, on the top line of all fax messages you transmit, and on the fax communication reports such as the journal report and the transmission report.

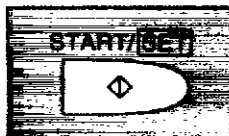
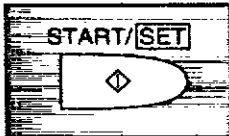
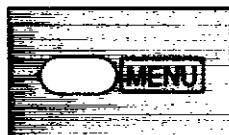



<p><b>1</b></p> 	<p>Press <b>MENU</b>.</p> <div style="border: 1px solid black; padding: 2px; width: fit-content;">1.SYSTEM SET UP</div>	<p><b>4</b></p> 	<p>Enter the current month/day/year/hour/minute by selecting each 2 digits. Then press * for AM or press # for PM.</p> <p><b>Example:</b>                  Aug. 10 1995, 3:00 PM                  Press 08 10 95 03 00,                  then press # to select PM.</p>
<p><b>2</b></p> 	<p>Press <b>#01</b>.</p> <div style="border: 1px solid black; padding: 2px; width: fit-content;">SET DATE &amp; TIME</div>	<p><b>5</b></p> 	<p>Press <b>START/SET</b> to store the setting.</p>
<p><b>3</b></p> 	<p>Press <b>START/SET</b>.</p> <div style="border: 1px solid black; padding: 2px; width: fit-content;">01/01/95 12:00A</div>	<p><b>6</b></p> 	<p>Press <b>MENU</b> to end the program.</p>

**Notes:**

- Do not enter 24 hour clock time as this unit will only accept 12 hour clock entries.
- When you make a mistake while programming, press the STOP button, then make the correction.
- The accuracy of the clock will be approximately  $\pm 45$  seconds a month at room temperature.

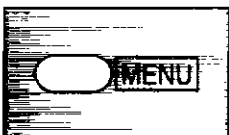
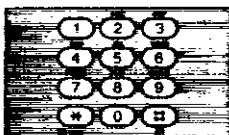
### Setting your logo

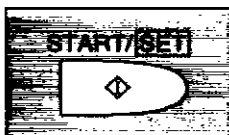
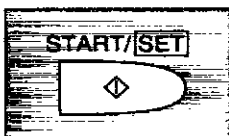
The logo is used to identify fax messages that are being transmitted by your unit. It may consist of numbers, letters and symbols. Usually the logo is a company, division or personal name in an abbreviated form.

<p><b>1</b></p> 	<p>Press <b>MENU</b>.</p> <div style="border: 1px solid black; padding: 2px; width: fit-content;">1.SYSTEM SET UP</div>	<p><b>4</b></p> 	<p>Enter your logo up to 30 characters by following the instructions on page 13.</p>
<p><b>2</b></p> 	<p>Press <b>#02</b>.</p> <div style="border: 1px solid black; padding: 2px; width: fit-content;">YOUR LOGO</div>	<p><b>5</b></p> 	<p>Press <b>START/SET</b> to store the setting.</p>
<p><b>3</b></p> 	<p>Press <b>START/SET</b>.</p> <div style="border: 1px solid black; padding: 2px; width: fit-content;">LOGO=</div>	<p><b>6</b></p> 	<p>Press <b>MENU</b> to end the program.</p>

**Note:**

- When the first character is entered, the preset logo will be cleared.

## How to enter letters and symbols

The dial keypad and the direct call station 1 are used as alphabet and symbol character input keys when you enter your logo and station names for automatic diallers.

### To enter characters

Pressing each key will alternately select a character as shown below. When the desired character is displayed, press # to move the cursor to the right and enter the next character.

Keys	Number of pressing times												
	1	2	3	4	5	6	7	8	9	10	11	12	13
1	1	[	]	{	}	+	-	/	=	,	.	_	'
2	A	B	C	a	b	c	2						
3	D	E	F	d	e	f	3						
4	G	H	I	g	h	i	4						
5	J	K	L	j	k	l	5						
6	M	N	O	m	n	o	6						
7	P	Q	R	S	p	q	r	s	7				
8	T	U	V	t	u	v	8						
9	W	X	Y	Z	w	x	y	z	9				
0	0	(	)	<	>	!	"	#	\$	%	&	¥	
⓪	:	;	?		*	@	^	'	→				
*	◀ key (Used to move the cursor to the left)												
#	▶ key (Used to move the cursor to the right)												

For example, when entering "Mike" as your logo:

- ① Press 6 once, then press #.

LOGO=M

- ② Press 4 six times, then press #.

LOGO=Mi

- ③ Press 5 five times, then press #.

LOGO=Mik

- ④ Press 3 five times.

LOGO=Mike

#### Notes:

- If you make a mistake while programming, use # or \* key to move the cursor to the incorrect character, then make the correction.
- Alternatively, see page 14 for special command keys for changing entered data.

### Special uses of the direct call station keys

Direct call stations 2, 3 and 4 are used as command keys.

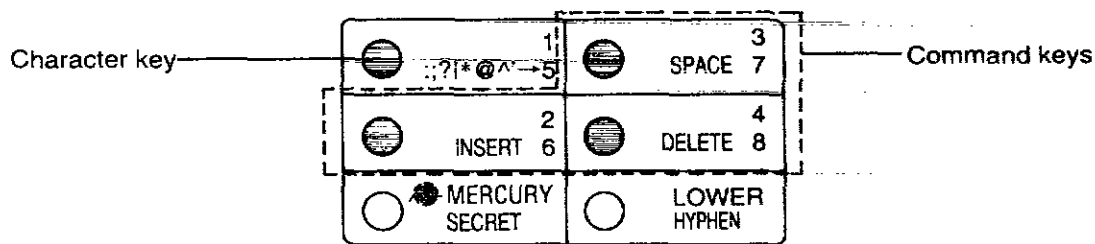

The layout of the direct call station keys is printed on the reverse side of the directory card.

1. Remove the directory card cover with a pencil or similar object as shown.
2. Turn over the directory card. You will find how each command is assigned to the direct call station keys.

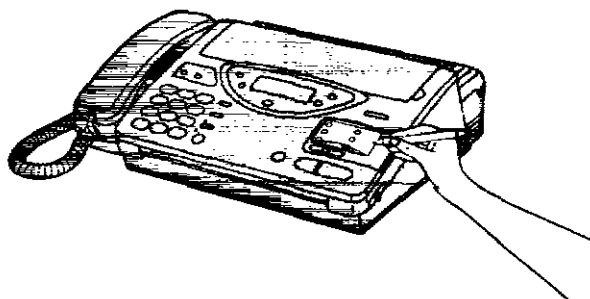

■ **Direct call station 2 (INSERT):**

This key is used to insert one character (or one space) in the programmed logo.

**Example:** Compny → Company

1. Press # or \* repeatedly until the cursor is positioned on "n".

LOGO=Compny

2. Press INSERT.

LOGO=Compny

3. Press 2 repeatedly until "a" is shown.

LOGO=Company

■ **Direct call station 3 (SPACE):**

This key is used to replace one character with a space.

■ **Direct call station 4 (DELETE):**

This key is used to delete one character from the programmed logo.

**Example:** Company → Company

1. Press # or \* repeatedly until the cursor is positioned on "n".

LOGO=Company

2. Press DELETE.

LOGO=Comany

## Setting your facsimile telephone number/ID number

Your programmed phone number will be printed on the top of each page transmitted from your unit.

- 1**

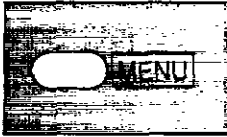

Press **MENU**.

1. SYSTEM SET UP

**4**

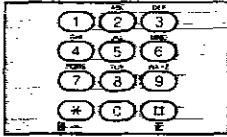

Enter your facsimile telephone number up to 20 digits.  
—The # button provides a space and the \* button provides "+".
- 2**

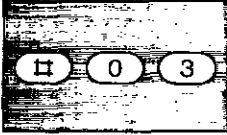

Press **#03**.

YOUR TEL NO.

**5**

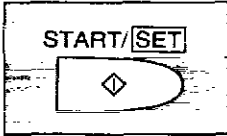

Press **START/SET** to store the setting.
- 3**



Press **START/SET**.

NO. =

**6**

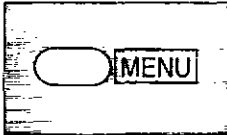

Press **MENU** to end the program.

## Setting the transmission report printing

Each time a document is transmitted, this feature will give you a printed record of the transmission.

The following choices are available:

**ERROR:** The report will print only when the transmission fails.

**ON:** The report will print, indicating whether the transmission is successful or not.

**OFF:** The report will not print.

**Sample of transmission report:**

TRANSMISSION REPORT						
						Jan. 01 1995 12:09AM
NO.	OTHER FACSIMILE	START TIME	USAGE TIME	MODE	PAGES	RESULT
01	COMPANY ABC	Jan. 01 12:08AM	01'05	TX	01	OK

- 1**

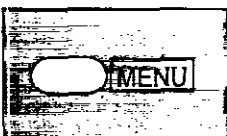

Press **MENU**.

1. SYSTEM SET UP

**4**

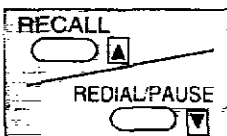

Press **▲** or **▼** to select the desired mode.
- 2**

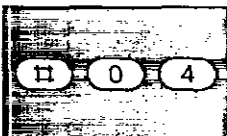

Press **#04**.

TX-REPORT MODE

**5**

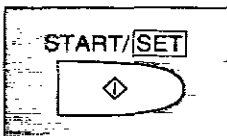

Press **START/SET** to store the setting.
- 3**

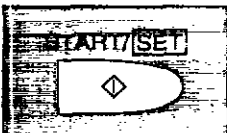

Press **START/SET**.

MODE=ERROR! ▲▼

**6**

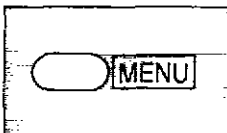

Press **MENU** to end the program.

### 3 Selecting the Receiving Mode

Select a desired receiving mode by pressing the **RECEIVE MODE** button repeatedly until the arrow in the display is positioned on the desired function.

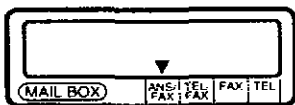
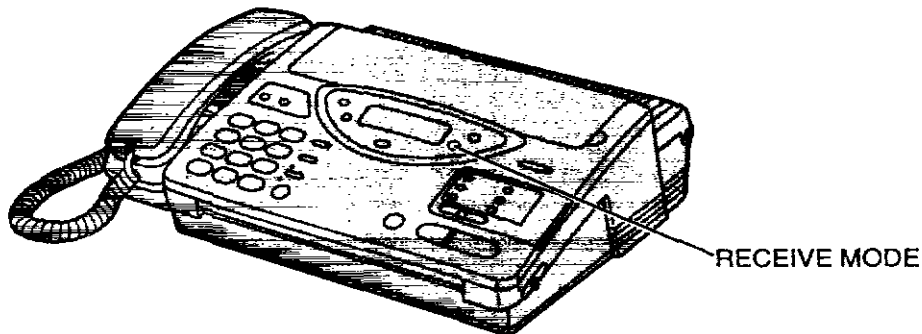

**ANS/FAX mode:**

Select this mode when you wish to receive voice and/or fax calls automatically. Please refer to page 17.

**Note:**

- Transmit the leaflet found on page 79 to several of your associates. This way, the user can confirm that the unit is functioning correctly and inform them of the procedure of transmitting documents and/or recording voice messages on the unit.

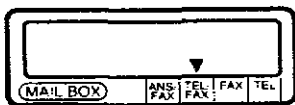

**TEL/FAX mode:**

Select this mode when you wish to receive mainly fax calls and occasional voice calls. The fax calls will be answered without ringing so as not to disturb you unnecessarily. Please refer to page 18 for further details.

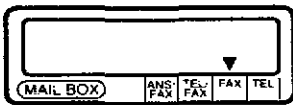

**FAX mode:**

Select this mode when you wish to receive only fax calls. This mode is normally used on dedicated fax lines. Please refer to page 20 for details of changing the number of rings before the fax machine answers the call.

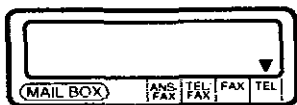

**TEL mode:**

Select this mode when you wish to receive mainly voice calls. The machine will not answer automatically.

**Notes:**

- If a call is received and fax reception is required, press the **START/SET** button to receive documents.
- If a call is received on an extension phone and fax reception is required, press **\* \*** on your touch tone telephone to receive documents.
- If no one answers the call within 20 rings, the receiving mode will switch to the **ANS/FAX** mode automatically.



## ANS/FAX mode

When a call comes in, the unit will automatically answer the call and distinguish between a fax and voice call. The number of rings is adjustable as detailed below.

When receiving a fax call, the unit will automatically activate the fax function to receive documents.

When receiving a voice call, the unit will play the greeting message and record an incoming voice message.

### Setting the number of rings to answer in the ANS/FAX mode

This feature determines the number of rings after which the unit answers a call in the ANS/FAX mode.

The following choices are available:

- 1: The unit will answer after the first ring.
  - 2: The unit will answer after the second ring. (Pre-selected setting)
  - 3: The unit will answer after the third ring.
  - 4: The unit will answer after the fourth ring.
- Toll saver:** (see below)  
**Ringer off:** The unit will answer without ringing.

Two rings may be referred to as "NORMAL" position as it enables the unit to answer incoming calls in a reasonably short time. This position should be selected unless you specifically wish to take advantage of the "toll saver facility".

#### Toll saver:

- When you call the unit from a remote location, the number of rings will tell you if there are any new voice messages.  
 If the unit answers on the second ring, there is at least one newly recorded message.  
 Hang up immediately when you hear the third ring. The third ring indicates that there are no new messages. This will save you being charged for the call.

Callers generally expect their calls to be answered within 10 seconds and most callers would abandon a call in under 45 seconds if no reply is obtained. This unit will answer incoming calls in under 10 seconds if required.

#### Helpful hints:

- If you wish to have the opportunity to pick up the handset before the call is answered by the unit, increase the number of rings.
- If you find difficulty in receiving fax messages from machines that have an automatic transmission feature, decrease the number of rings.

To change the setting, proceed as follows:

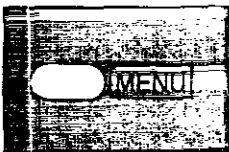
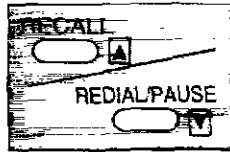
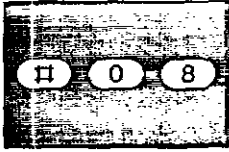
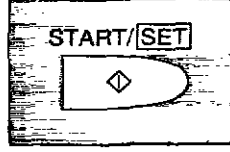
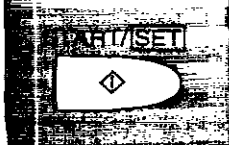
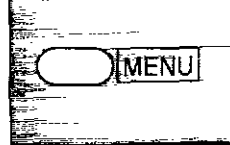
<p><b>1</b> </p>	<p>Press <b>MENU</b>.</p> <div style="border: 1px solid black; padding: 2px; width: fit-content; margin: 5px auto;">1. SYSTEM SET UP</div>	<p><b>4</b> </p>	<p>Press <b>▲</b> or <b>▼</b> to select the desired setting.</p>
<p><b>2</b> </p>	<p>Press <b>#08</b>.</p> <div style="border: 1px solid black; padding: 2px; width: fit-content; margin: 5px auto;">ANS/FAX RING</div>	<p><b>5</b> </p>	<p>Press <b>START/SET</b> to store the setting.</p>
<p><b>3</b> </p>	<p>Press <b>START/SET</b>.</p> <div style="border: 1px solid black; padding: 2px; width: fit-content; margin: 5px auto;">RING=2 [▲▼]</div>	<p><b>6</b> </p>	<p>Press <b>MENU</b> to end the program.</p>

## TEL/FAX mode

When a call comes in, the unit will work as follows.

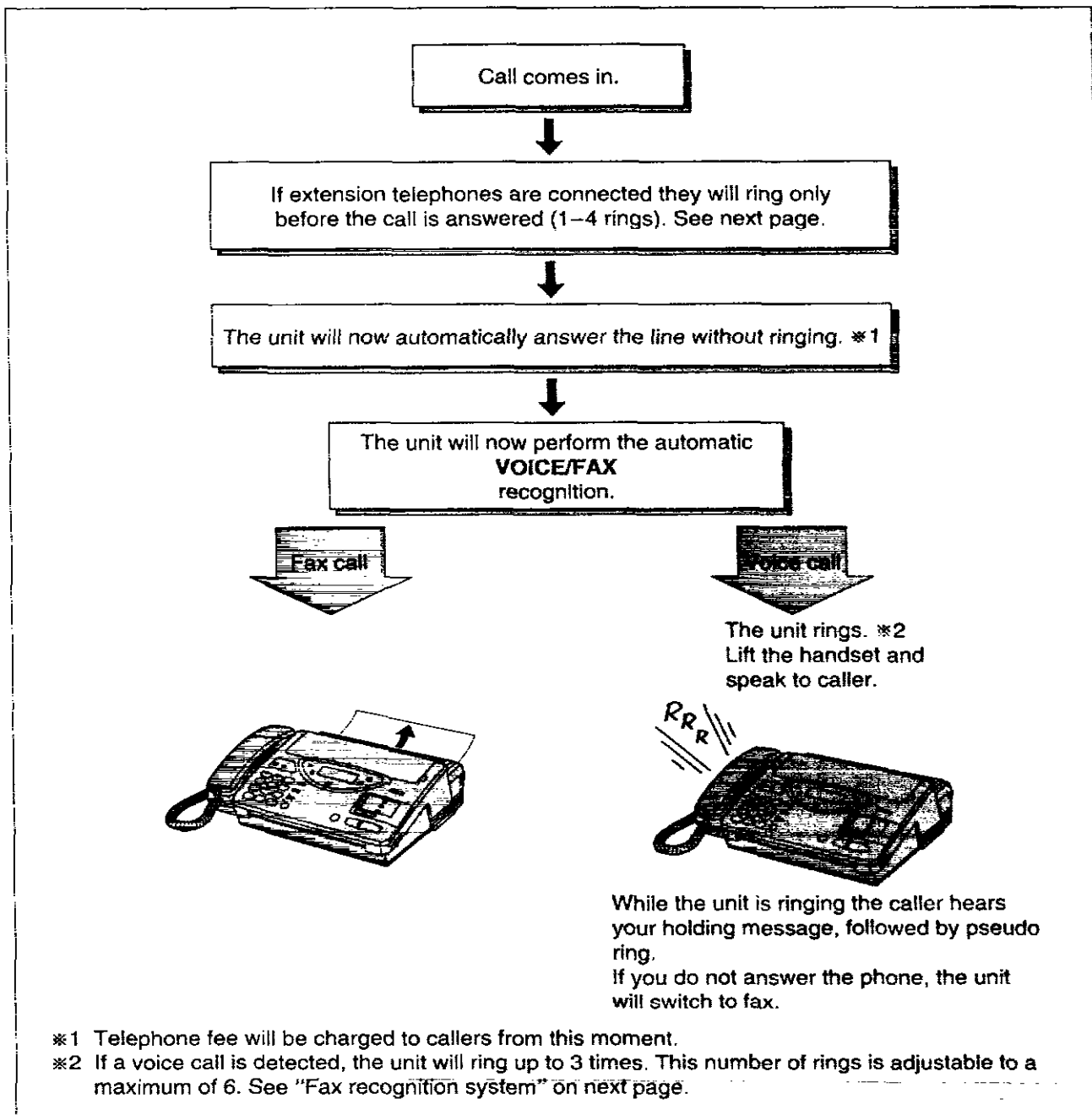

**Notes:**

- In TEL/FAX mode, the unit may not receive fax messages from some fax machines because the sending machine does not send a CNG signal. Start the reception manually to receive documents.
- If you hear the facsimile unit ringing, you can pick up the handset on the facsimile unit or another extension (if connected on the same line) to answer the call.

## Setting the number of rings to answer in the TEL/FAX mode

The number of rings can be varied from 1–4 as follows:

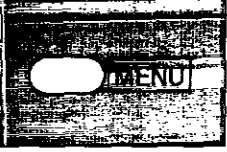
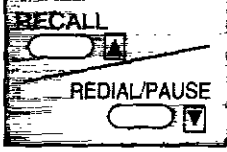
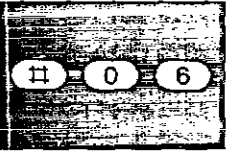
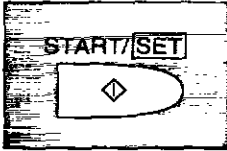
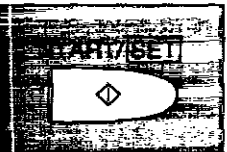
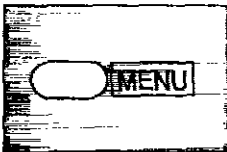
- |  |  |   |  |
|--|--|---|--|
| <p>① </p> | <p>Press <b>MENU</b>.</p> <div style="border: 1px solid black; padding: 2px; width: fit-content; margin: 5px auto;">1. SYSTEM SET UP</div> | <p>④ </p> | <p>Press <b>▲</b> or <b>▼</b> to select the desired number of rings.</p> |
| <p>② </p> | <p>Press <b>#06</b>.</p> <div style="border: 1px solid black; padding: 2px; width: fit-content; margin: 5px auto;">TEL/FAX RING</div>      | <p>⑤ </p> | <p>Press <b>START/SET</b> to store the setting.</p>                      |
| <p>③ </p> | <p>Press <b>START/SET</b>.</p> <div style="border: 1px solid black; padding: 2px; width: fit-content; margin: 5px auto;">RING=2 [▲▼]</div> | <p>⑥ </p> | <p>Press <b>MENU</b> to end the program.</p>                             |

**Note:**

- If an external telephone with a call display feature is connected, set the number of rings to more than 2.

## Fax recognition system

In the *TEL/FAX* mode, when a fax call is received, the unit will automatically activate the fax function without ringing (we call this "silent fax recognition"). If the unit detects a voice call, it will ring 3 times.

This can be adjusted to a maximum of 6 rings as follows:

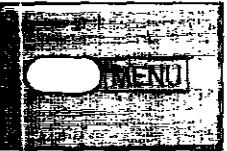
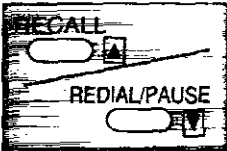
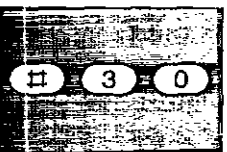
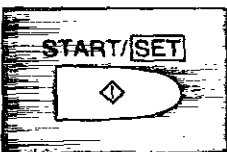
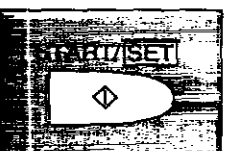
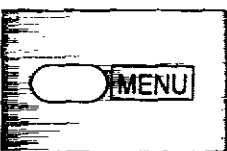
- |  |  |   |  |
|--|--|---|--|
| <p>① </p> | <p>Press <b>MENU</b>.</p> <div style="border: 1px solid black; padding: 2px; width: fit-content; margin: 5px auto;">1. SYSTEM SET UP</div> | <p>④ </p> | <p>Press <b>▲</b> or <b>▼</b> to select the desired number of rings.</p> |
| <p>② </p> | <p>Press <b>#30</b>.</p> <div style="border: 1px solid black; padding: 2px; width: fit-content; margin: 5px auto;">SILENT FAX RING</div>   | <p>⑤ </p> | <p>Press <b>START/SET</b> to store the setting.</p>                      |
| <p>③ </p> | <p>Press <b>START/SET</b>.</p> <div style="border: 1px solid black; padding: 2px; width: fit-content; margin: 5px auto;">RING=3 [▲▼]</div> | <p>⑥ </p> | <p>Press <b>MENU</b> to end the program.</p>                             |

## FAX only mode





When a call comes in, the unit will automatically answer the line after 1 to 4 rings (user programming) and activate the fax function.

### Setting the number of rings in the FAX mode

This feature determines the number of rings after which the unit answers a call in the FAX mode. The number of rings is adjustable from 1 to 4.

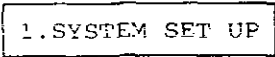
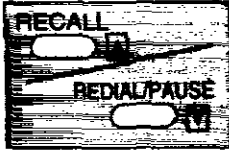
#### Helpful hints:

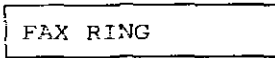
- If you wish to have an opportunity to answer a call before the unit does, increase the number of rings.
- If you find there is difficulty in fax receiving from machines that have an automatic transmission feature, decrease the number of rings.
- If an external telephone with a call display feature is connected, set the number of rings to more than 2.

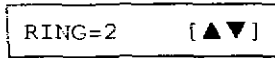
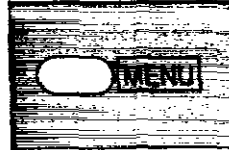
<b>1</b>		Press <b>MENU</b> .		<b>4</b>		Press <b>▲</b> or <b>▼</b> to select the desired number of rings.
<b>2</b>		Press <b>#07</b> .		<b>5</b>		Press <b>START/SET</b> to store the setting.
<b>3</b>		Press <b>START/SET</b> .		<b>6</b>		Press <b>MENU</b> to end the program.

## 4 Making/Receiving Voice Calls

### Making voice calls

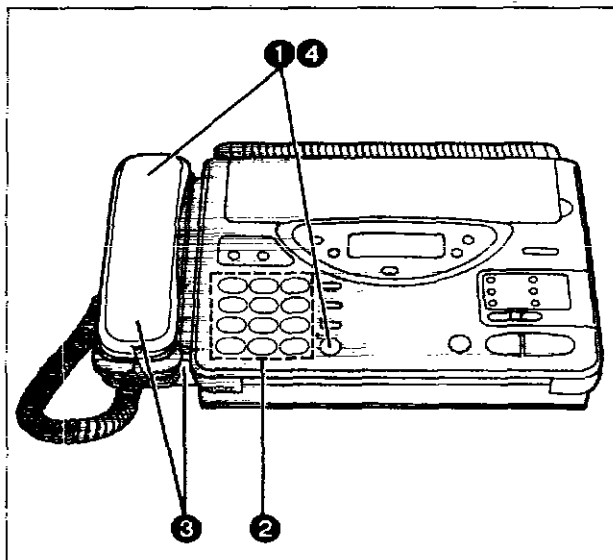

- 1 Press **SP-PHONE** or lift the handset, then listen for the dial tone.
- 2 Dial a phone number.
- 3 When the other party answers, speak through the microphone or handset.
- 4 When finished, press **SP-PHONE** again or place the handset on the cradle.

**Notes:**

- Adjust the volume to a suitable level. See page 22.
- If you wish to switch to the handset from the speakerphone, lift the handset. To switch to the speakerphone, press the **SP-PHONE** button.

### Helpful hint for setting the dialling mode

If your telephone line has touch tone service, set the selector to **TONE**.  
If your telephone line has rotary pulse dial service, set the selector to **PULSE**.

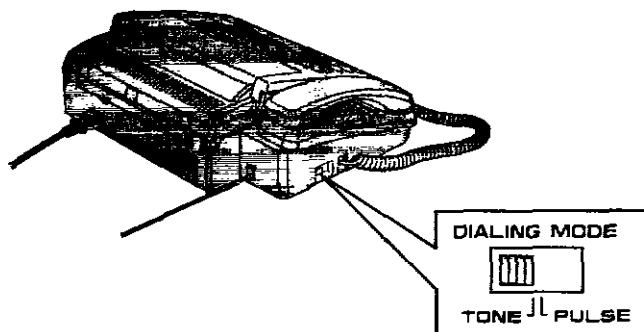

You can ascertain what type of exchange the unit is connected to by using the following procedure:

1. Ensure that the dialling mode selector is set to **TONE**.
2. Lift the handset or press the **SP-PHONE** button, then listen for the dial tone.
3. Dial a familiar number.
4. If the call is successful, the unit is connected to a tone exchange. Leave the selector set to **TONE**.
5. If the call is not successful, the unit is connected to a pulse exchange. Switch the selector to **PULSE**.

## Adjusting volumes

You can adjust the volume level of the ringer and the speaker. These volume levels should be adjusted respectively.

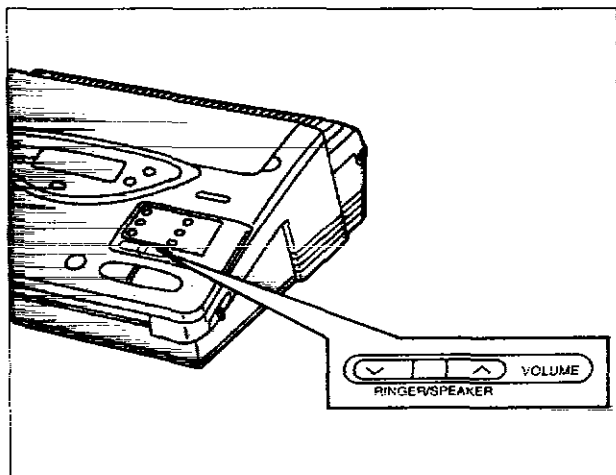

### ■ Ringer volume

Press the **VOLUME** buttons ( $\wedge/\vee$ ) while the unit is in idle status. 3 levels (high/low/off) are available.

- To turn the ringer off, press  $\vee$  repeatedly and press the **START/SET** button when the display shows "RINGER OFF=OK?".
- If the ringer volume is set to off, the unit will not ring and the display will show "RINGER OFF" in idle status.

### ■ Speaker volume

Press the **VOLUME** buttons ( $\wedge/\vee$ ) when the speakerphone is in use. 8 levels are available.

### ■ Answering device volume

Press the **VOLUME** buttons ( $\wedge/\vee$ ) while listening to messages recorded on the answering device. 9 levels are available.

## Voice muting

The **MUTE** button will mute your voice during a telephone conversation. Using this feature, you can hear the voice of the other party, but the other party cannot hear your voice.

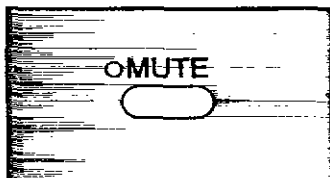

Press **MUTE** and confirm the **MUTE** indicator light is on. To resume the conversation, press **MUTE** again.

#### Note:

- If you are using the handset, you cannot hear the other party's voice. If you are using the **SP-PHONE**, you can hear the other party's voice through the speaker.

## Redialling the last dialed number

If the line is busy or you wish to redial the last dialed number, use the **REDIAL/PAUSE** button.

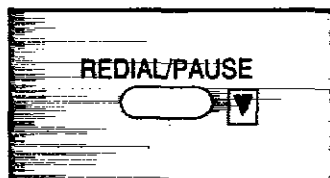

Press **SP-PHONE** or lift the handset, then press **REDIAL/PAUSE**.

- When using the handset, the unit will redial the last dialed number once.
- When using the speaker phone, the unit will automatically redial the last dialed number up to 3 times.

## Answering voice calls

When the unit rings, lift the handset or press **SP-PHONE** to answer the call.

When you have finished, replace the handset on the cradle or press **SP-PHONE**.

## 5 Making/Receiving Fax Calls

### Documents you can send

The unit can transmit documents that meet the following conditions.

- Document width should be from 128 to 216 mm (5 to 8½").
- Maximum document length should not exceed 600 mm (23⅝").
- Effective scanning width can be up to 208 mm (8⅜").
- Number of pages that can be set in the document feeder tray must not exceed 15 sheets.
- Document weight:
  - Single sheet: 45 to 90 g/m<sup>2</sup> (12 to 24 lb.)
  - Multiple sheet: 60 to 80 g/m<sup>2</sup> (16 to 21 lb.)
  - (80 g/m<sup>2</sup> is equivalent to normal photocopier paper.)

Minimum document size

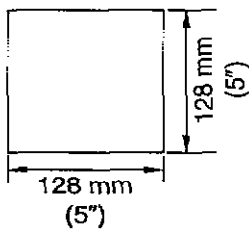

Maximum document size

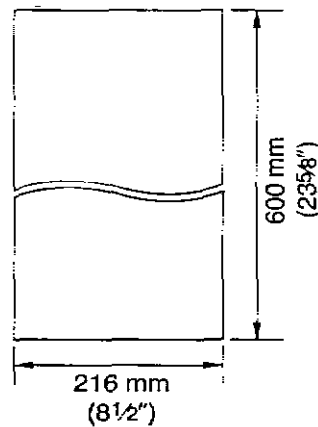

Effective scanning width

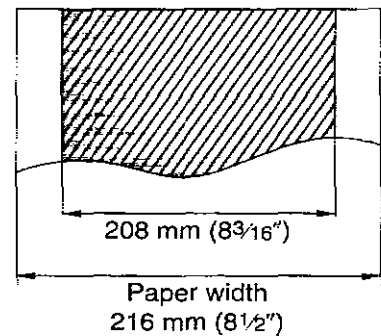

**Note:**

- Do not feed the following types of documents. Make a copy of these documents with a copier machine and feed the copy into the unit.
  - Paper with a chemically treated surface such as carbon paper or carbonless duplicating paper
  - Electrostatically charged paper
  - Heavily curled, creased or torn paper
  - Paper with a coated surface
  - Small-sized paper such as a slip or voucher
  - Thin paper less than 45 g/m<sup>2</sup> (12 lb.)
  - Thick paper over 90 g/m<sup>2</sup> (24 lb.)
  - Paper with faint contrast between the printing and the background
  - Paper with printing on the reverse side that can be seen through the front (e.g. newspaper)

## Loading documents

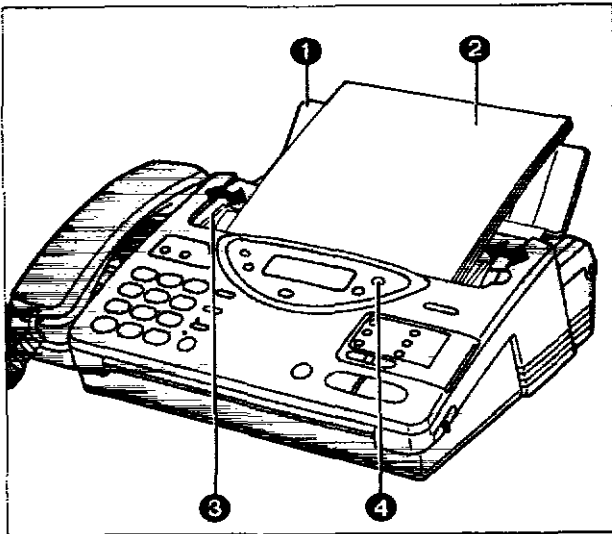

- ① Open the document feeder tray.
- ② Insert the documents **FACE DOWN** until a beep tone is heard.  
—The unit can accept up to 15 sheets of paper at a time.
- ③ Adjust the document guides to the width of the documents.
- ④ Adjust the resolution by pressing **RESOLUTION** if needed (see below).

**Notes:**

- Remove clips, staples or other similar objects from a document before feeding it into the unit. Also check that all ink, paste or correction fluid on the document has completely dried.
- If the top edge of the document is curled, make it flat and insert the document.

## Setting resolution

Depending on the quality of the originals, you can select the desired resolution by pressing the **RESOLUTION** button repeatedly. Use the button when the document has been fed into the unit.

STANDARD	Suitable for printed or typewritten originals with normal-sized characters.
FINE	Suitable for originals with small printing.
SUPER FINE	Suitable for originals with minute printing.
HALF TONE	Useful for originals containing photographs, shaded drawings, etc.

**Notes:**

- Using these features except the standard resolution will increase the transmission time.
- The super fine resolution only works between other compatible machines.
- If the setting is changed during feeding, it will be effective from the next sheet.
- To enhance the resolution settings, see page 45.

## Sending 16 or more sheets

If you wish to send 16 or more sheets at a time, insert the first 15 sheets of the document. Add the extra sheets, up to 15 sheets at a time, before the last sheet is fed into the unit.



## Transmitting documents

You can transmit documents without using the handset or the SP-PHONE button.

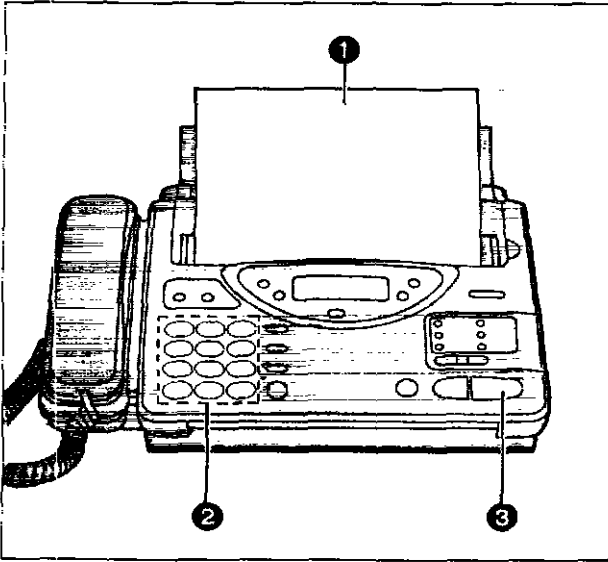

- ① Insert the documents **FACE DOWN** until a beep tone is heard.
- ② Enter the phone number.  
—If incorrect, press the **STOP** button, then enter the correct number.
- ③ Press **START/SET**.  
—The unit will start to dial and transmit the documents.

**Note:**

- If there is no answer or the line is busy, the unit will automatically redial the number up to 3 times. To cancel the redialling, press the **STOP** button.

## Receiving documents

### Manual reception

When in the **TEL** mode or during a telephone conversation, you can receive documents as follows.

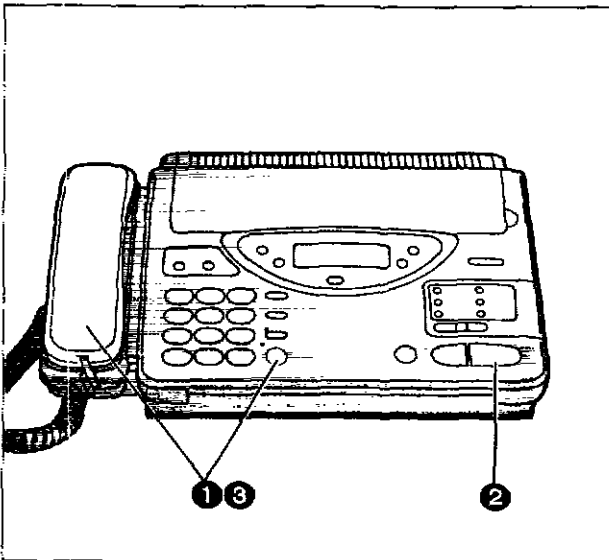

- ① When the unit rings, press **SP-PHONE** or lift the handset to answer the call.
- ② Press **START/SET** when document reception is required or when you hear a slow beep or silence.
- ③ If using the handset, replace on the cradle.  
—The unit will start reception.

**Note:**

- To interrupt reception, press the **STOP** button. The unit will stop receiving.

### Automatic reception

Set the receive mode to **ANS/FAX**, **TEL/FAX** or **FAX** by pressing **RECEIVE MC DE**.

When a fax call comes in, the unit will automatically activate the fax function to receive documents.

## 6 Operating the Answering Device

### Setup of voice message and document reception

The unit can save a total of 15 minutes of voice recordings in memory. The unit has four memory locations—common memory and three mailbox memories.

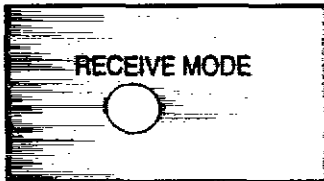

To set the unit to record incoming voice messages and receive documents, select **ANS/FAX** mode by pressing **RECEIVE MODE**.

—The display will show the time remaining for recording incoming messages for about 2 seconds.

TIME LEFT=12MIN

#### Notes:

- If the incoming messages are noisy, the recording time might be less than 15 minutes.
- The recording time for incoming messages can be set to either **LONG** (2 minutes 30 seconds) or **SHORT** (1 minute). It is preset to **LONG**. To change the setting, see page 11.
- To maximise recording time, erase messages that are no longer required.

### Listening to recorded messages

When new incoming messages have been recorded, the **NEW MESSAGES** indicator will flash and the call counter will show the total number of messages.

If the message alert feature is set to on, the unit will alert the user with a slow beep if a caller's message has been recorded (see page 29).

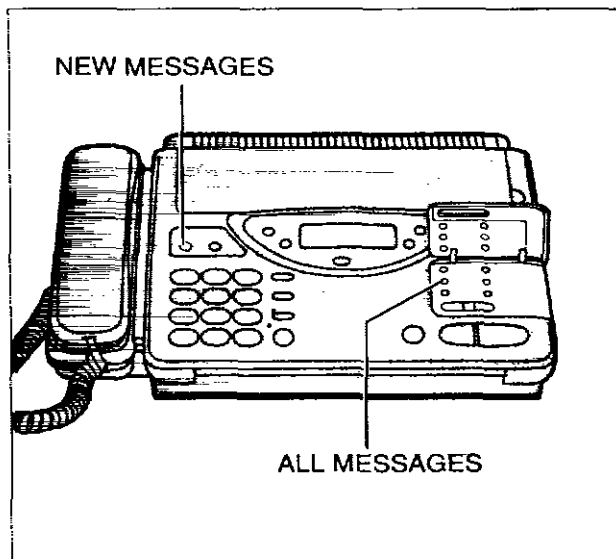

#### ■ Playing back newly recorded messages:

Press **NEW MESSAGES**.

—The unit will begin to play back new messages.

At the end of the last message, 3 beeps will sound.

#### ■ Playing back all the recorded messages:

Open the station key panel and press **ALL MESSAGES**.

—The unit will begin to play back all the recorded messages.

At the end of the last message, 3 beeps will sound.

During playback, the display will show the number of the message being played.

ICM PLAYING 01

#### Saving messages:

The unit will save the incoming messages automatically, if the user does not erase them.

#### Note:

- The time remaining for recording incoming messages will appear on the display for about 2 seconds whenever the station key panel is opened.

## Functions during playback

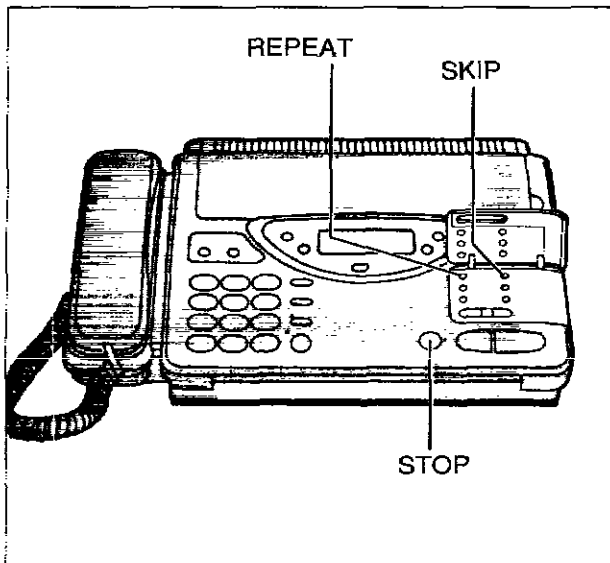

■ **Repeating a message:**

Press **REPEAT** to play back the previous message.

■ **Skipping a message:**

Press **SKIP** to skip to the next message.

■ **Stopping playback:**

Press **STOP**.

—If you wish to resume playback, press the **NEW MESSAGES** or **ALL MESSAGES** button within 1 minute after pressing the **STOP** button.

**Note:**

- These functions can be used while recorded messages in a mailbox are being played back (see page 50).

## Erasing recorded messages

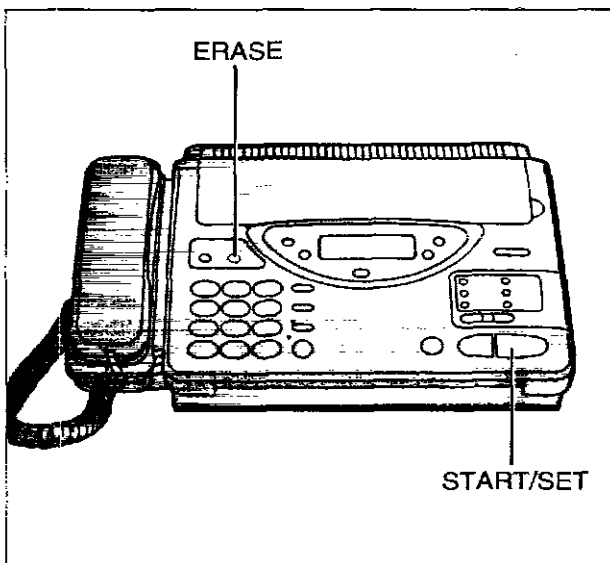

■ **Erasing a specific message from memory:**

Press **ERASE** while the message you want to delete is being played.

■ **Erasing all messages from memory:**

1. Press **ERASE** after listening to all the messages.

ICM ERASE OK?

2. Press **START/SET** for confirmation.

ERASE COMPLETED

—The unit will delete all the recorded messages in the common memory.  
—If this feature is not required, press the **ERASE** button again or the **STOP** button instead of the **START/SET** button.

**Note:**

- These features can be used for the mailbox feature. To erase messages in a mailbox, you must first select the mailbox by pressing the **MAIL BOX** button (see page 50).

## Recording a memo message

If the user is going out and wants to leave a private message for someone, they can record a voice memo in the unit. This can be played back afterward either directly or remotely, exactly like any other messages.

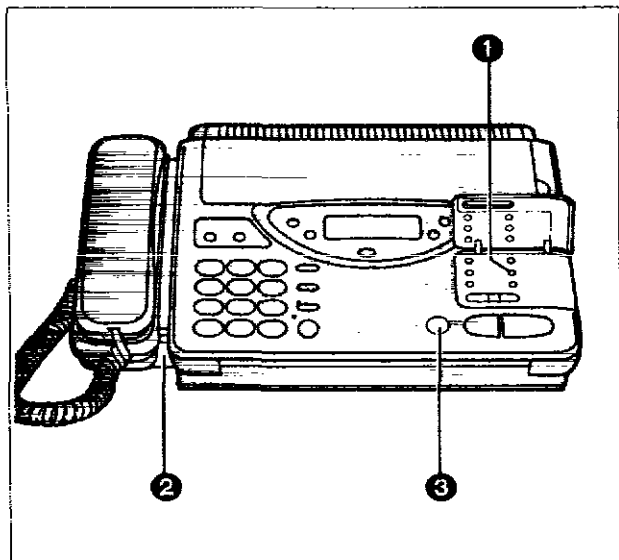

- 1 Open the station key panel, then press **MEMO/2WAY REC**.
- 2 Immediately after the beep, speak clearly and loudly into the microphone.
- 3 When finished, press **MEMO/2WAY REC** again or **STOP**.  
—The call counter on the display will increase by one.

**Notes:**

- When memory becomes full while recording, the unit will stop recording automatically and 6 beeps will be heard. Erase some or all messages (see page 27).
- This feature can be used for the mailbox feature. To record, you must first select the required mailbox by pressing the **MAIL BOX** button. Then follow the steps detailed above.

## Recording a telephone conversation

While speaking with someone on the telephone, the conversation can be recorded.

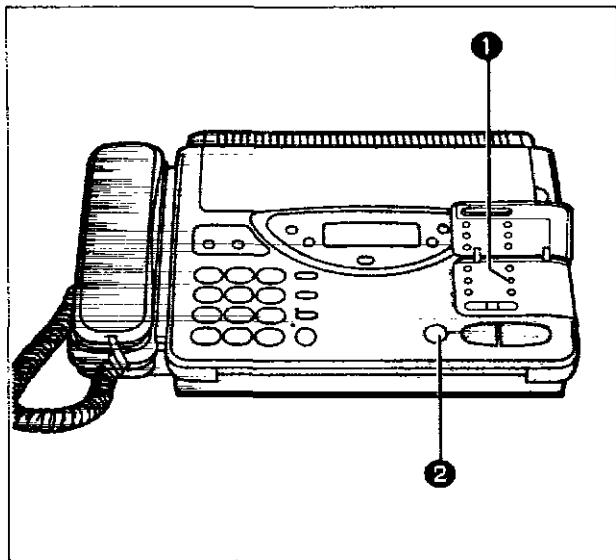

- 1 During the conversation, open the station key panel and press **MEMO/2WAY REC**.

2WAY RECORDING

—A beep sounds every 15 seconds to notify the caller that the conversation is being recorded.



- 2 To stop recording, press **MEMO/2WAY REC** again or **STOP**.  
or  
Hang up after the conversation.  
—The call counter on the display will increase by one.

**Note:**

- This feature can be used for the mailbox feature. To record, you must first select the required mailbox by pressing the **MAIL BOX** button. Then follow the steps detailed above.

## Setting the message alert

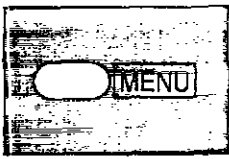
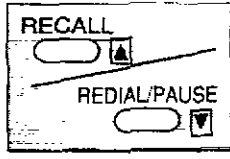
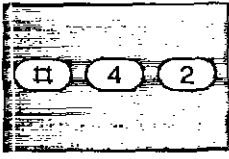
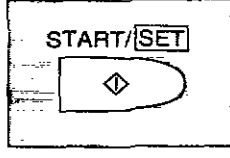
When this feature is set, the unit will emit a slow beep if a caller's message has been recorded in the common memory.

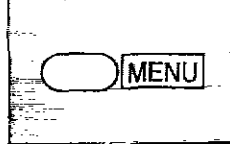
<p><b>1</b> </p>	<p>Press <b>MENU</b>.</p> <div style="border: 1px solid black; padding: 2px; width: fit-content; margin: 5px auto;">1. SYSTEM SET UP</div>	<p><b>4</b> </p>	<p>Press <b>▲</b> or <b>▼</b> to select "ON".</p> <div style="border: 1px solid black; padding: 2px; width: fit-content; margin: 5px auto;">MODE=ON [▲▼]</div> <p>—If this feature is not required, select "OFF".</p>
<p><b>2</b> </p>	<p>Press <b>#42</b>.</p> <div style="border: 1px solid black; padding: 2px; width: fit-content; margin: 5px auto;">MESSAGE ALERT</div>	<p><b>5</b> </p>	<p>Press <b>START/SET</b> to store the setting.</p>
<p><b>3</b> </p>	<p>Press <b>START/SET</b>.</p> <div style="border: 1px solid black; padding: 2px; width: fit-content; margin: 5px auto;">MODE=OFF [▲▼]</div>	<p><b>6</b> </p>	<p>Press <b>MENU</b> to end the program.</p>

**Note:**

- This feature does not work when an incoming message is recorded in the mailbox.



## Setting the recording time alert

When this feature is set and the remaining time to record incoming messages becomes less than 60 seconds, the unit will alert the user with a slow beep.

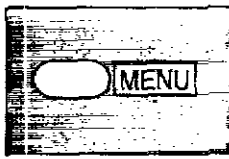
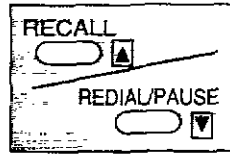
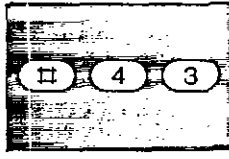
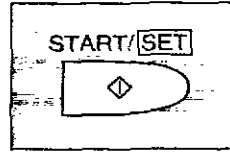
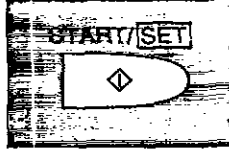
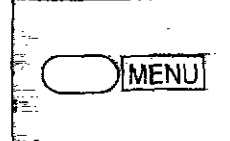
<p><b>1</b> </p>	<p>Press <b>MENU</b>.</p> <div style="border: 1px solid black; padding: 2px; width: fit-content; margin: 5px auto;">1. SYSTEM SET UP</div>	<p><b>4</b> </p>	<p>Press <b>▲</b> or <b>▼</b> to select "ON".</p> <div style="border: 1px solid black; padding: 2px; width: fit-content; margin: 5px auto;">MODE=ON [▲▼]</div> <p>—If this feature is not required, select "OFF".</p>
<p><b>2</b> </p>	<p>Press <b>#43</b>.</p> <div style="border: 1px solid black; padding: 2px; width: fit-content; margin: 5px auto;">REC. TIME ALERT</div>	<p><b>5</b> </p>	<p>Press <b>START/SET</b> to store the setting.</p>
<p><b>3</b> </p>	<p>Press <b>START/SET</b>.</p> <div style="border: 1px solid black; padding: 2px; width: fit-content; margin: 5px auto;">MODE=OFF [▲▼]</div>	<p><b>6</b> </p>	<p>Press <b>MENU</b> to end the program.</p>

# 7 Automatic Dialling

The unit's memory allows you to use both one-touch dialling (up to 8 phone numbers) and speed dialling (up to 22 phone numbers) for rapid access to your most frequently dialled numbers.

**One-touch dialling:** The unit is equipped with 4 direct call station keys, each of which is divided into an upper station and a lower station.

**Speed dialling:** The unit is equipped with additional 22 dialling stations. These stations are assigned to 2-digit numbers (00–21).

## Storing tel/fax numbers for automatic dialling

Turn over the directory card first. See page 14.

**1**  Press **MENU** repeatedly until the following is displayed.

2. STORE TEL NO.

**2-a For one-touch dialling:**

**For upper stations 1 to 4:** Press one of the direct call station keys.

*Example: Station 4*

<S04>=

or

**For lower stations 5 to 8:** Press **LOWER**, then press one of the direct call station keys.

*Example: Station 8*

<LWR>

<S08>=

**2-b For speed dialling:**

Press **#**, then press a 2-digit number (00–21).

*Example: Station #00*

<A00>=

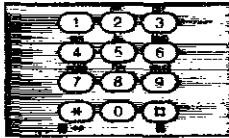
**3**  Enter a phone number up to 30 digits in length.

**4**  Press **START/SET** to store the number.

NAME=

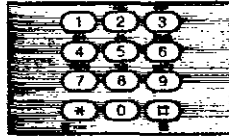
**5**  Enter the station name (up to 10 alpha-numeric characters) by following the instructions on page 31.

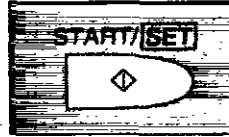
**6**  Press **START/SET** to store the station name. —To program other stations, repeat from step 2.

**7**  Press **STOP** to end the program.

**Notes:**

- To enter a hyphen in a phone number, press the **LOWER** key. A hyphen is counted as 2 digits.
- If you make a mistake while programming, press the **STOP** button, then make the correction.
- To erase a programmed phone number, press the **STOP** button in step 3 when the cursor is positioned on the beginning of the number.
- Confirm that phone numbers and their station names have been correctly stored by printing the telephone number list. See page 62.
- When you wish a phone number not to appear on the display and the telephone number list, you can keep a whole or a portion of the number secret. Press the **SECRET** key before and behind the phone number you wish to keep secret. Pressing the **SECRET** key once counts as two digits.

## To enter characters

The dial keypad and the direct call station 1 are used as alphabet and symbol character input keys when you enter station names for automatic diallers.

Pressing each key will alternately select a character as shown below.

When the desired character is displayed, press # to move the cursor to the right and enter the next character.

Keys	Number of pressing times												
	1	2	3	4	5	6	7	8	9	10	11	12	13
1	1	[	]	{	}	+	-	/	=	,	.	_	'
2	A	B	C	a	b	c	2						
3	D	E	F	d	e	f	3						
4	G	H	I	g	h	i	4						
5	J	K	L	j	k	l	5						
6	M	N	O	m	n	o	6						
7	P	Q	R	S	p	q	r	s	7				
8	T	U	V	t	u	v	8						
9	W	X	Y	Z	w	x	y	z	9				
0	0	(	)	<	>	!	"	#	\$	%	&	¥	
○	:	:	?		×	@	^	'	→				
*	◀ key (Used to move the cursor to the left)												
□	▶ key (Used to move the cursor to the right)												

For example, when entering "Kate" as the station name:

- ① Press 5 twice, then press #.

NAME=K

- ② Press 2 four times, then press #.

NAME=Ka

- ③ Press 8 four times, then press #.

NAME=Kac

- ④ Press 3 five times.

NAME=Kate

**Notes:**

- If you make a mistake while programming, use # or \* key to move the cursor to the incorrect character, then make the correction.
- See page 14 for special command keys for changing entered data.

## Making voice calls using automatic dialling

You can dial a phone number automatically using one-touch dialling and speed dialling. Before using automatic dialling, make sure that the desired telephone numbers have been stored in memory. For storing phone numbers, see page 30.

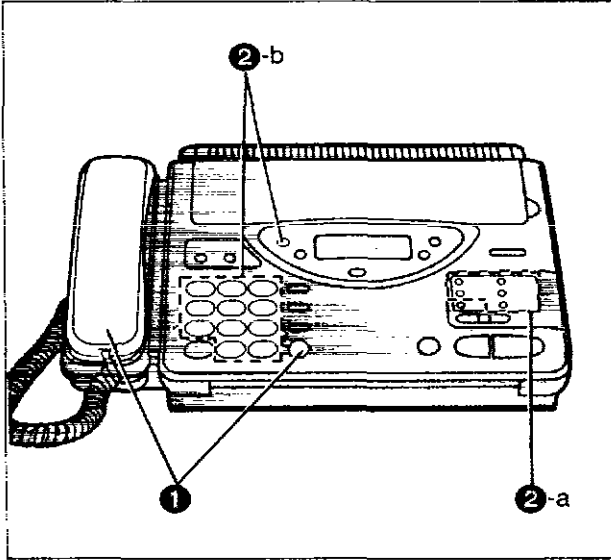

- 1 Press **SP-PHONE** or lift the handset.
- 2-a **Using one-touch dialling:**
  - **When using the upper stations 1 to 4:**  
Press the desired direct call station key.
  - **When using the lower stations 5 to 8:**  
Press **LOWER**, then press the desired direct call station key.
- 2-b **Using speed dialling:**  
Press **DIRECTORY**, then press # and the desired 2-digit number (00–21).

**Helpful hint:**

- You can also use the electronic telephone directory to make a voice call (see page 34).

## Transmitting documents using automatic dialling

You can transmit documents automatically using one-touch dialling and speed dialling. Before using automatic dialling, make sure that the desired telephone numbers have been stored in memory. For storing phone numbers, see page 30.

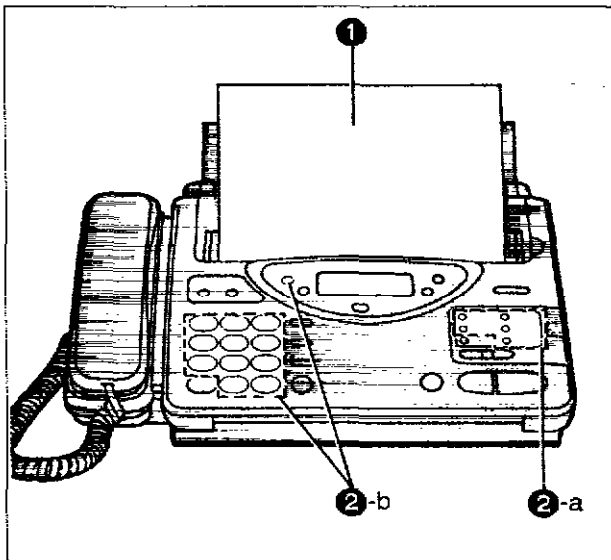

- 1 Insert the documents **FACE DOWN** until a beep tone is heard.
- 2-a **Using one-touch dialling:**
  - **When using the upper stations 1 to 4:**  
Press the desired direct call station key.
  - **When using the lower stations 5 to 8:**  
Press **LOWER**, then press the desired direct call station key.
- 2-b **Using speed dialling:**  
Press **DIRECTORY**, then press # and the desired 2-digit number (00–21).

**Note:**

- If there is no answer or the line is busy, the unit will automatically redial the number up to 3 times. To cancel the redialling, press the **STOP** button.



## 8 Copier Function

### Making a copy

Any transmittable document can be copied (see page 23). To make a copy, follow the steps below.

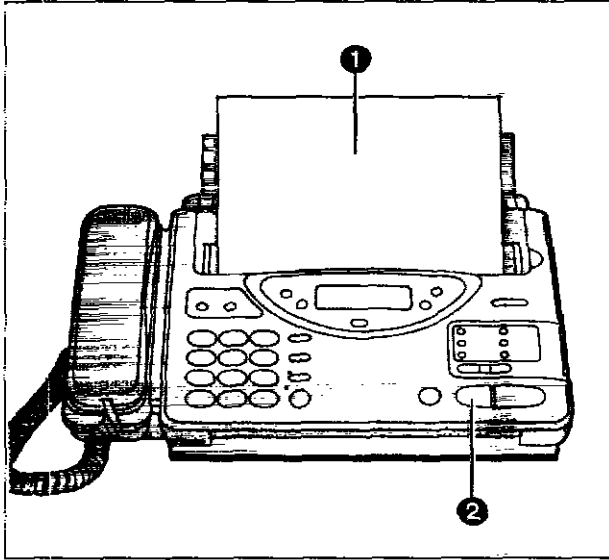

① Insert the documents FACE DOWN.

② Press **COPY**.  
—The unit will start copying.

**Notes:**

- When copying, the unit will automatically select the FINE resolution. Depending on the originals, select the desired resolution (see page 24).
- You can make or receive voice calls while making a copy.
- To interrupt a copy, press the STOP button. The unit will stop copy operation and eject the documents.

## 9 Advanced Operations

### Electronic telephone directory

The station names stored in memory for automatic dialling will be automatically registered in the electronic telephone directory in alphabetical order.

With the electronic telephone directory feature, you can make a fax or voice call by selecting the desired station name on the display.

#### How to use the electronic telephone directory

To search a station name and make a voice or fax call, proceed as follows.  
If you wish to send a fax, insert the documents into the document feeder first.

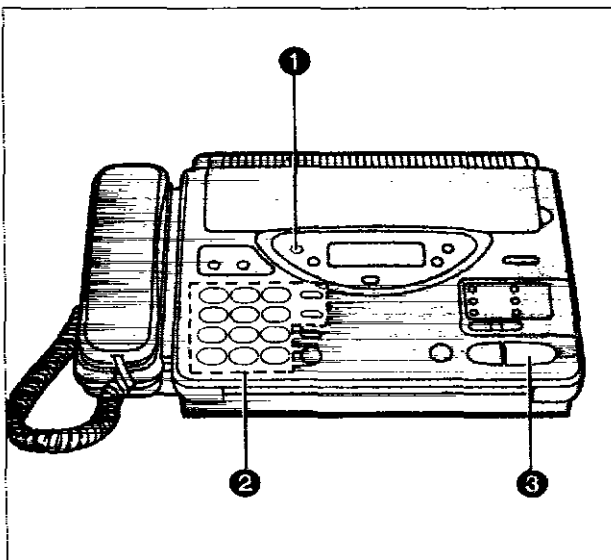

- 1 Press **DIRECTORY**.

SELECT INDEX

- 2 ■ Press a dial key to which the initial of a station name is assigned (see Index table).

*Example: To search a name with the initial "N"*

Press **6** repeatedly until the first station name with the initial "N" is displayed and press **▼** until the desired name is displayed.

or

- Press **▲** or **▼** repeatedly until the desired name is displayed.

- 3 Press **START/SET**.

—The unit will start dialling.

—If a document has been fed into the unit, the transmission will start.

Index table

Dial key	Index	Dial key	Index
1	1	7	P, Q, R, S, 7
2	A, B, C, 2	8	T, U, V, 8
3	D, E, F, 3	9	W, X, Y, Z, 9
4	G, H, I, 4	0	0
5	J, K, L, 5	*	Other symbols
6	M, N, O, 6	#	(Used for speed dialling. See page 32.)

## Polling



The polling feature allows you to receive a document from another compatible machine where you pay for the call as opposed to the document being sent to you, thereby saving the other party call charges. Your machine can perform both transmit and receive polling.

### Receive Polling

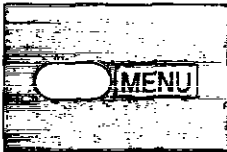
You place the call and recover a document from another machine. Make sure that no documents have been fed into your unit and that the other party's machine is ready for your call.

- 1**  Press **MENU** repeatedly until the following is displayed.

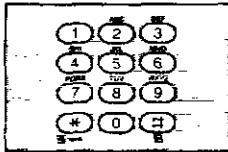
4. POLLING
- 2**  Press **START/SET**.

NO. =
- 3**  Enter the phone number by using one-touch dialling, speed dialling or a full number.
- 4**  Press **START/SET**.  
 —When using speed dialling, press **START/SET** again.  
 —The unit will start polling.

**Notes:**

- The receiving unit incurs any telephone charges.
- If there is no answer or the line is busy, the unit will automatically redial the number up to 3 times. To cancel the redialling, press the **STOP** button.
- Some information services may not work in polling mode. In this case manual reception should be used. Dial the number of the service. When the voice says to press the start button, press the **START/SET** button.

### Transmit polling

A document stored in your machine can be recovered by another parties machine. To let other machines retrieve documents loaded on your unit, proceed as follows.

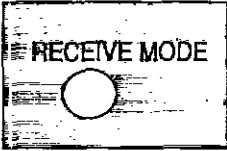
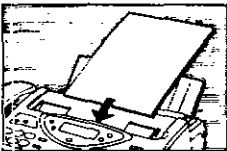
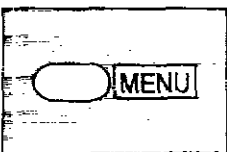
- 1**  Set the unit in the **ANS/FAX, TEL/FAX** or **FAX** mode by pressing **RECEIVE MODE**.
- 2**  Insert the documents **FACE DOWN**.
- 3**  Press **MENU** repeatedly until the following is displayed.

5. POLLED
- 4**  Press **START/SET**.

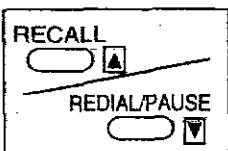
MODE=OFF [▲▼]
- 5**  Press **▲** or **▼** to select "ON".

MODE=ON [▲▼]

—If this feature is not required, select "OFF".
- 6**  Press **START/SET**.





POLLED ON

**Note:**

- When delayed transmission (see page 36) is set to ON, this feature is not available.

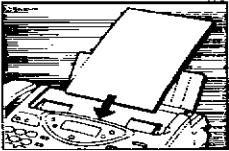
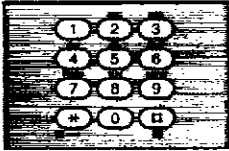
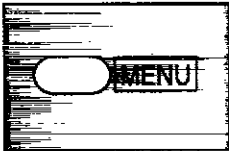
## Delayed transmission

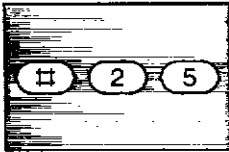
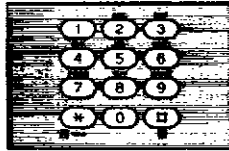
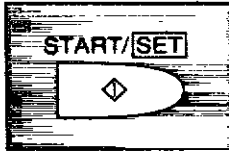
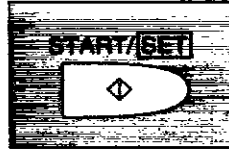
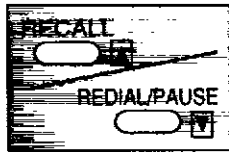
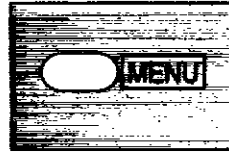
Using a built-in clock, this unit can send documents automatically at a specific time. This allows you to take advantage of low-cost calling rates given by some telephone companies. The delayed transmission can be reserved to take place up to 24 hours ahead.

- |   |  |   |  |
|---|--|---|--|
| <p><b>1</b> </p>   | <p>Insert the documents<br/>FACE DOWN.</p>   | <p><b>7</b> </p>    | <p>Enter the phone number<br/>using one-touch dialling,<br/>speed dialling or a full<br/>number.<br/>— You can use the<br/>electronic telephone<br/>directory (see<br/>page 34).</p>   |
| <p><b>2</b> </p>   | <p>Press <b>MENU</b>.</p> <div style="border: 1px solid black; padding: 5px; width: fit-content; margin: 5px auto;">1. SYSTEM SET UP</div>   | <p><b>8</b> </p>    | <p>Press <b>START/SET</b> to<br/>store the number.<br/>— When using speed<br/>dialling, press<br/><b>START/SET</b> again.</p> <div style="border: 1px solid black; padding: 5px; width: fit-content; margin: 5px auto;">TIME=12:00AM</div> |
| <p><b>3</b> </p>   | <p>Press #25.</p> <div style="border: 1px solid black; padding: 5px; width: fit-content; margin: 5px auto;">DELAYED XMT</div>  | <p><b>9</b> </p>   | <p>Enter the transmission<br/>start time.</p> <p><b>Example: 11:00PM</b><br/>Press 1100, then press #<br/>to select PM.<br/>— To select AM, press *.</p>   |
| <p><b>4</b> </p>  | <p>Press <b>START/SET</b>.</p> <div style="border: 1px solid black; padding: 5px; width: fit-content; margin: 5px auto;">MODE=OFF [▲▼]</div>   | <p><b>10</b> </p> | <p>Press <b>START/SET</b> to<br/>store the setting.</p>  |
| <p><b>5</b> </p> | <p>Press ▲ or ▼ to select<br/>"ON".</p> <div style="border: 1px solid black; padding: 5px; width: fit-content; margin: 5px auto;">MODE=ON [▲▼]</div> <p>— If this feature is not<br/>required, select "OFF".</p> | <p><b>11</b> </p> | <p>Press <b>MENU</b> to end the<br/>program.</p> <p>— When the<br/>programmed time has<br/>come, the unit will<br/>automatically start<br/>transmission.</p>   |
| <p><b>6</b> </p> | <p>Press <b>START/SET</b>.</p> <div style="border: 1px solid black; padding: 5px; width: fit-content; margin: 5px auto;">NO. =</div>   |   |  |

**Notes:**

- Do not enter 24 hour clock time as this unit will only accept 12 hour clock entries.
- If there is no answer or the line is busy, the unit will automatically redial the number up to 3 times.
- You can receive, transmit and copy documents while the delayed transmission is set. To copy or transmit documents, remove documents from the tray and replace them when you have finished.
- If the programmed start time has passed during a power failure, delayed transmission will be attempted soon after the power is restored.
- When polling transmission feature (see page 35) is set to ON, this feature is not available.

## Remote fax receiving using an extension phone

If you have an extension phone connected to the same line, it is possible to receive a fax message into your facsimile unit by using the extension phone.

This saves you the trouble of going to the facsimile unit and pressing the START button.

### Important:

- This feature is available when you receive a call.
- To activate this feature, use a **touch tone telephone** as an extension phone and dial the remote fax activation code. The remote fax activation code is set to “\*\*” as a preselected setting.

### Using an extension phone

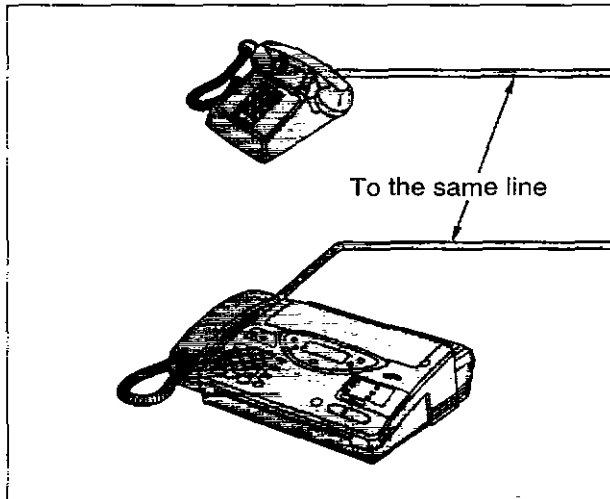



- ➊ When a call comes in, lift the handset of the extension phone.
- ➋ If a slow beep (fax calling tone) is heard or the other party wishes to send you a fax, press the remote fax activation code.
- ➌ Replace the handset on the cradle. —The facsimile unit will activate the fax function to receive documents.

### Notes:

- When pressing remote fax activation code, please press and hold the button for 1 second at a time.
- The number of the remote fax activation code can be changed to another one. See below.

## Changing the remote fax activation code

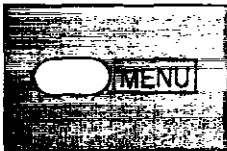
Your code can be from 1 to 4 digits long. The numbers 0 through 9 and character \* may be used. (e.g. \*\*, 123, 123\*)

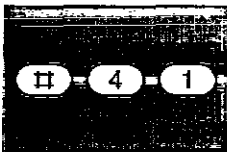
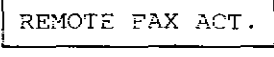
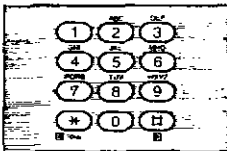
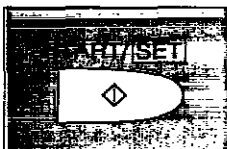
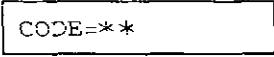
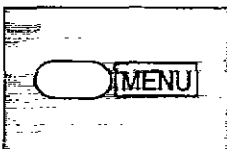
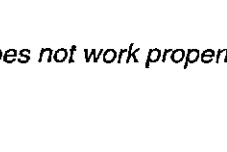
<p>➊ </p>	<p>Press <b>MENU</b>.</p> 	<p>➋ </p>	<p>Press <b>#41</b>.</p> 	<p>➌ </p>	<p>Enter the new code number.</p>
<p>➍ </p>	<p>Press <b>START/SET</b>.</p> 	<p>➎ </p>	<p>Press <b>START/SET</b> to store the number.</p>	<p>➏ </p>	<p>Press <b>MENU</b> to end the program.</p>

### Note:

- If the remote fax activation code is set to “0000”, the unit does not work properly.

## Junk mail prohibitor

This feature will prohibit reception from unauthorised fax machines.

With this feature set, this unit will only receive from facsimile machines whose numbers are stored for automatic dialling.

If you wish to receive documents from other machines, advise the caller to use manual transmission and enter the prohibitor ID (see page 39) before initiating transmission.

### Important:

- To activate this feature, set the unit in the ANS/FAX, TEL/FAX or FAX mode and let the unit receive documents automatically.
- When in the ANS/FAX or TEL/FAX mode, transmission using the prohibitor ID is available (see page 39).
- When manual reception is used, the documents from any transmitting station will be received.
- If the transmitting machines have not been programmed with their facsimile telephone numbers, the unit will not be able to receive documents automatically.

### Setting the junk mail prohibitor

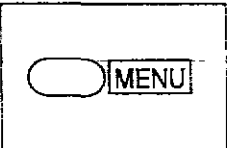
- 

Press **MENU**.

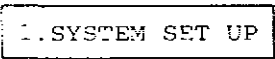
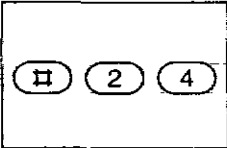
- 

Press **#24**.

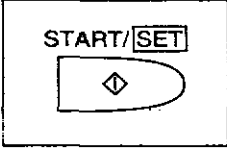

- 

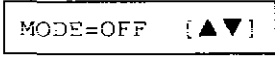
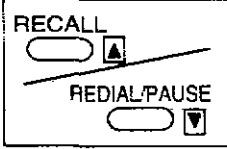
Press **START/SET**.

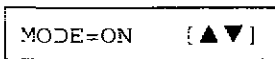

- 

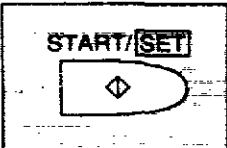
Press **▲** or **▼** to select "ON".

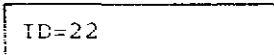
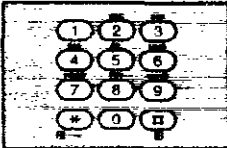

—If this feature is not required, select "OFF".
- 

Press **START/SET** to store the setting.

- 

If you wish to change the junk mail prohibitor ID, enter the desired 2-digit number.  
—0, # and \* cannot be used.
- 

Press **START/SET** to store the number.
- 

Press **MENU** to end the program.

### Note:

- The junk mail prohibitor ID must be different from the first 2 digits of the remote ANS ID (see page 53). For example, if the remote ANS ID is set to "321", do not use "32" as a junk mail prohibitor ID.

## Transmitting documents to your unit with the prohibitor ID

If the junk mail prohibitor feature is activated, automatic fax reception from unauthorised stations will not be available. However, in this instance, a caller can transmit documents to your unit manually by entering the prohibitor ID.

Issue the prohibitor ID to callers with priority status.

### Important:

- Transmission with the prohibitor ID is activated when your unit is in the **ANS/FAX** or **TEL/FAX** mode.

### Instructions for caller:

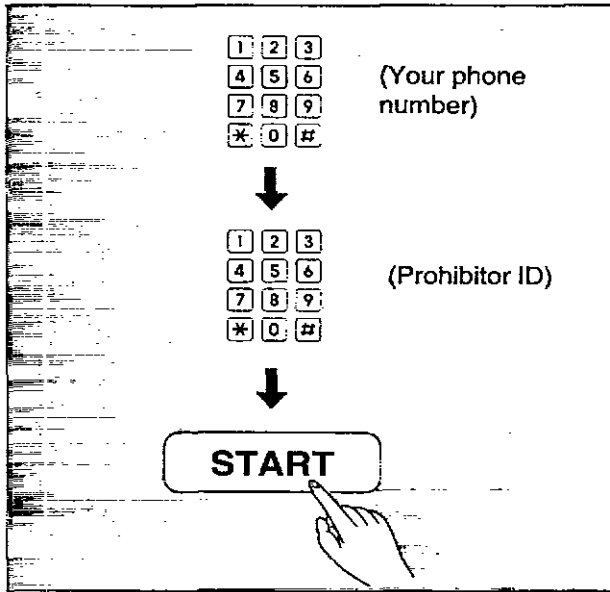

- 1 A caller may call your unit.
  - 2 ■ **When your unit is in the *ANS/FAX* mode:**  
They may enter the prohibitor ID while the greeting message is being played or during incoming message recording mode.
- OR
- 2 ■ **When your unit is in the *TEL/FAX* mode:**  
They may enter the prohibitor ID while the different ring back tone is heard.
  - 3 When a fax tone is heard, they may press their start or transmit button to start the fax transmission.



## Special settings





### Logo print position

Your logo, telephone number, date, time and page number will be printed on the transmitted document from your unit in the following manner.

**OUT:** Outside of the transmitted document's image area.

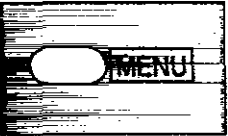
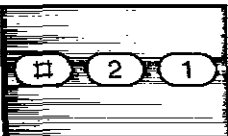

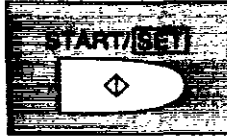

**IN:** Inside of the transmitted document's image area.

**OFF:** Not printed.

<p><b>1</b> </p> <p><b>2</b> </p> <p><b>3</b> </p>	<p>Press <b>MENU</b>.</p> <div style="border: 1px solid black; padding: 2px; width: fit-content; margin: 5px 0;">1.SYSTEM SET UP</div> <p>Press <b>#21</b>.</p> <div style="border: 1px solid black; padding: 2px; width: fit-content; margin: 5px 0;">LOGO POSITION</div> <p>Press <b>START/SET</b>.</p> <div style="border: 1px solid black; padding: 2px; width: fit-content; margin: 5px 0;">MODE=OUT [▲▼]</div>	<p><b>4</b> </p> <p><b>5</b> </p> <p><b>6</b> </p>	<p>Press <b>▲</b> or <b>▼</b> to select the desired setting.</p> <p>Press <b>START/SET</b> to store your selection.</p> <p>Press <b>MENU</b> to end the program.</p>
---	--	--	--

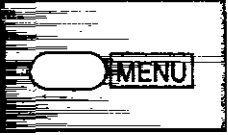
### Overseas transmission mode

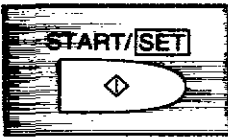
You may experience difficulty in transmitting documents overseas. When this feature is set to on, it will become easy to send documents as the transmission speed is slowed down.

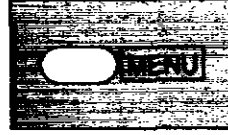
<p><b>1</b> </p> <p><b>2</b> </p> <p><b>3</b> </p>	<p>Press <b>MENU</b>.</p> <div style="border: 1px solid black; padding: 2px; width: fit-content; margin: 5px 0;">1.SYSTEM SET UP</div> <p>Press <b>#23</b>.</p> <div style="border: 1px solid black; padding: 2px; width: fit-content; margin: 5px 0;">OVERSEAS MODE</div> <p>Press <b>START/SET</b>.</p> <div style="border: 1px solid black; padding: 2px; width: fit-content; margin: 5px 0;">MODE=OFF [▲▼]</div>	<p><b>4</b> </p> <p><b>5</b> </p> <p><b>6</b> </p>	<p>Press <b>▲</b> or <b>▼</b> to select "ON".</p> <div style="border: 1px solid black; padding: 2px; width: fit-content; margin: 5px 0;">MODE=ON [▲▼]</div> <p>—If this feature is not required, select "OFF".</p> <p>Press <b>START/SET</b> to store your selection.</p> <p>Press <b>MENU</b> to end the program. Then start transmission procedure (see pages 25 and 32).</p>
---	--	--	---

**Notes:**

- After the transmission has completed, this feature will be turned off automatically.
- When using this feature, transmission time will increase.



## Setting the day/night mode

You may wish to use the unit as a telephone and facsimile (TEL/FAX mode) during the business hours and switch to the answering device (ANS/FAX mode) during off hours. With this feature on, the unit will automatically switch the receiving mode at a preprogrammed time without the operator's assistance.

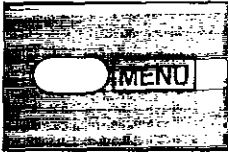
- 1**  Press **MENU**.

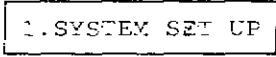
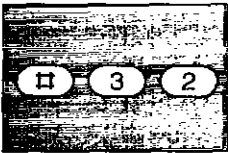

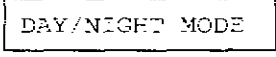
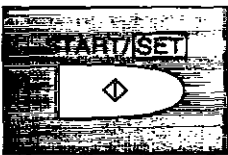
- 2**  Press **#32**.

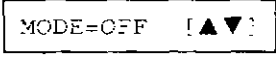
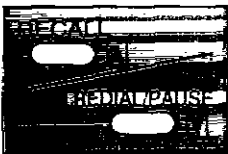
- 3**  Press **START/SET**.

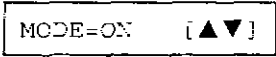

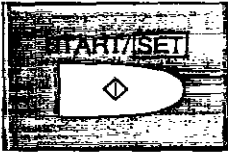
- 4**  Press **▲** or **▼** to select "ON".

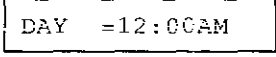
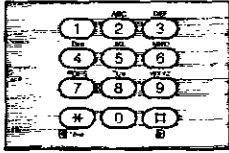

—If this feature is not required, select "OFF".
- 5**  Press **START/SET** to store the selection.

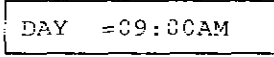
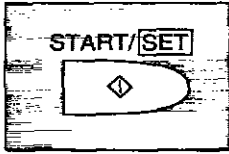

- 6**  Enter the time at which the day mode (TEL/FAX mode) starts.

**Example:**  
The TEL/FAX mode starts at 9:00AM. Press 0900, then press \* to select AM.

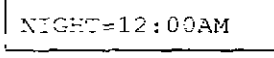
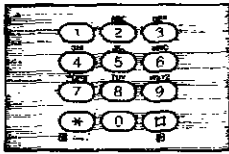
- 7**  Press **START/SET**.

- 8**  Enter the time at which the night mode (ANS/FAX mode) starts.

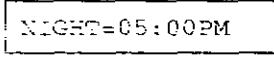
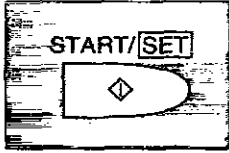
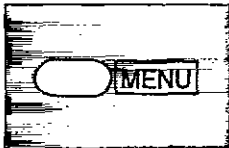
**Example:**  
The ANS/FAX mode starts at 5:00PM. Press 0500, then press # to select PM.

- 9**  Press **START/SET** to store the setting.
- 10**  Press **MENU** to end the program.

**Notes:**

- Do not enter 24 hour clock time as this unit will only accept 12 hour clock entries.
- If you select another receiving mode manually when this feature is on, the unit will keep the receiving mode that you selected until either day or night mode starts.

## Paper save reception/copy

When this feature is set, the unit will print faxes and copies half their original length.



**Important:**

- This feature will not work,
  - when receiving documents sent in fine resolution or other nonstandard resolution.
  - when making a copy in the fine, super fine or half tone resolution.

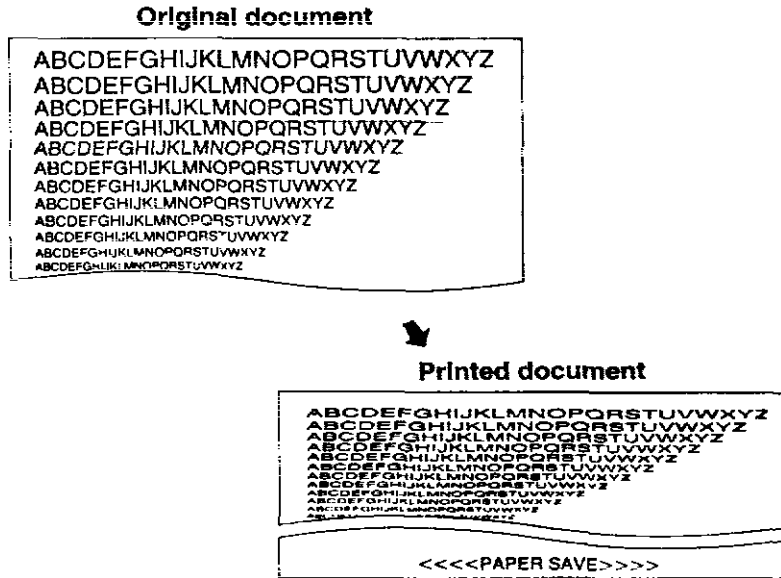
**Sample of paper save print:**

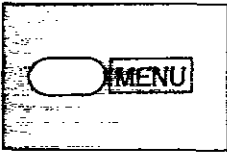
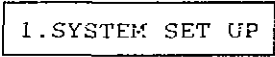
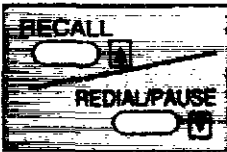
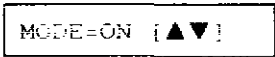
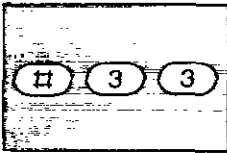
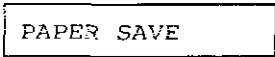
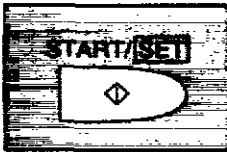
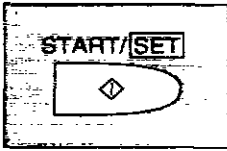
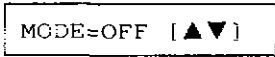

To activate this feature, proceed as follows:

- |   |  |  |   |
|---|--|--|---|
| <p><b>1</b></p>  | <p>Press <b>MENU</b>.</p>       | <p><b>4</b></p>  | <p>Press <b>▲</b> or <b>▼</b> to select "ON".</p>  |
| <p><b>2</b></p>  | <p>Press <b>#33</b>.</p>        | <p><b>5</b></p>  | <p>— If this feature is not required, select "OFF".</p> <p>Press <b>START/SET</b> to store your selection.</p>                          |
| <p><b>3</b></p>  | <p>Press <b>START/SET</b>.</p>  | <p><b>6</b></p>  | <p>Press <b>MENU</b> to end the program.</p>  |

## Extension copy

When this feature is set, the unit will produce copies twice the length of the original. This feature is useful for restoring faxes and copies made in the paper save mode (see page 42) to the length of the original document.

Sample of extended copy:

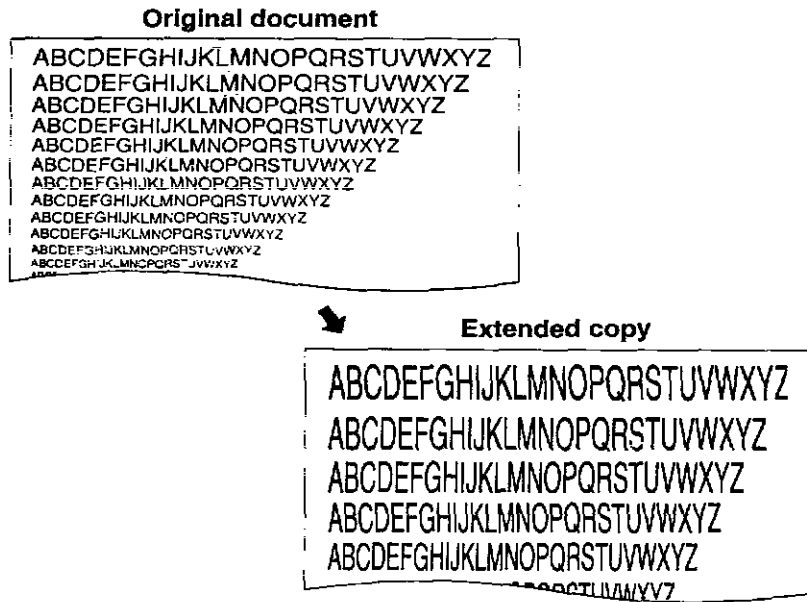

To make an extension copy, proceed as follows:

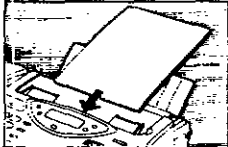
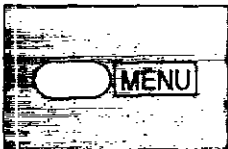
- 1**  Insert the documents **FACE DOWN**.
- 2**  Press **MENU**.

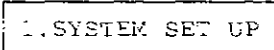
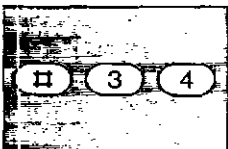
- 3**  Press **#34**.

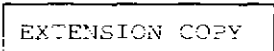
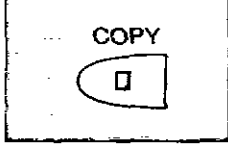
- 4**  Press **COPY**.

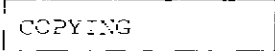

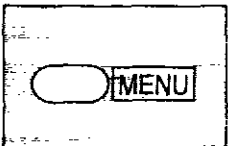
—The unit will start printing.
- 5**  Press **MENU** to end the operation.

## Setting the recall mode

When this unit is used as an extension of a PABX (Private Automatic Branch Exchange), the **RECALL** button will allow access to PABX functions such as call transfer and hold. If you are unsure of which setting to use please consult the supplier of the PABX.



The following choices are available:

**T\_BR**: Time Break Recall

**E\_RE**: Earth Recall

**Note:**

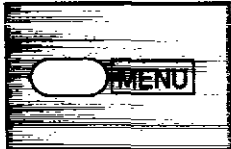
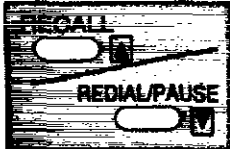
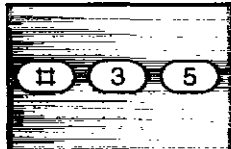
• For British Telecom "Star Services", set your Recall to Time Break.

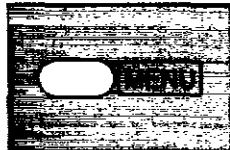
<p>① </p>	<p>Press <b>MENU</b>.</p> <div style="border: 1px solid black; padding: 2px; width: fit-content; margin: 5px auto;">1.SYSTEM SET UP</div>	<p>④ </p>	<p>Press <b>▲</b> or <b>▼</b> to select the desired mode.</p>
<p>② </p>	<p>Press <b>#35</b>.</p> <div style="border: 1px solid black; padding: 2px; width: fit-content; margin: 5px auto;">RECALL MODE</div>	<p>⑤ </p>	<p>Press <b>START/SET</b> to store the setting.</p>
<p>③ </p>	<p>Press <b>START/SET</b>.</p> <div style="border: 1px solid black; padding: 2px; width: fit-content; margin: 5px auto;">MODE=T_BR [▲▼]</div>	<p>⑥ </p>	<p>Press <b>MENU</b> to end the program.</p>

## Setting the contrast mode

Use this feature when you need to transmit and copy a document with very faint writing/print or very dark writing/print.

The following choices are available:

- NORMAL:** Used for a document with normal writing/print.
- LIGHT:** Used for a document with very faint writing/print.
- DARKER:** Used for a document with very dark writing/print.

These settings are available in the standard, fine and super fine resolutions. Set this feature before starting transmission or copying by following the steps below.

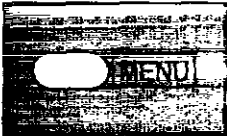
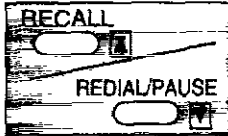
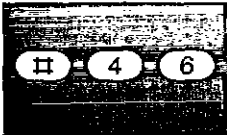
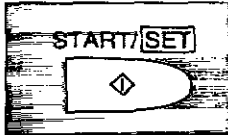
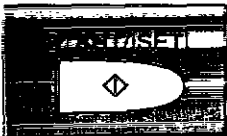
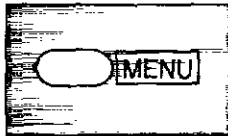

<p><b>1</b> </p>	<p>Press <b>MENU</b>.</p> <div style="border: 1px solid black; padding: 2px; width: fit-content; margin: 5px auto;">1. SYSTEM SET UP</div>	<p><b>4</b> </p>	<p>Press <b>▲</b> or <b>▼</b> to select the desired mode.</p>
<p><b>2</b> </p>	<p>Press <b>#46</b>.</p> <div style="border: 1px solid black; padding: 2px; width: fit-content; margin: 5px auto;">ORIGINAL</div>	<p><b>5</b> </p>	<p>Press <b>START/SET</b> to store the setting.</p>
<p><b>3</b> </p>	<p>Press <b>START/SET</b>.</p> <div style="border: 1px solid black; padding: 2px; width: fit-content; margin: 5px auto;">MODE=NORMAL [▲▼]</div>	<p><b>6</b> </p>	<p>Press <b>MENU</b> to end the program.</p>

**Note:**

- This feature will return to the normal mode after the transmission or copying has completed.

## Resetting the advanced features

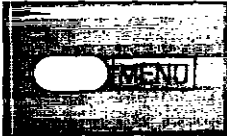
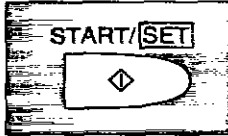
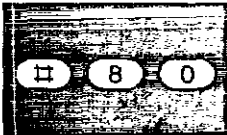
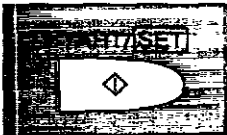
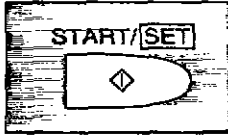
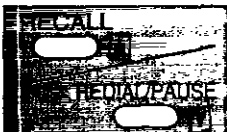
Use this feature to return the advanced features of #21 through #63 (see page 67) to their initial settings.

<p><b>1</b> </p>	<p>Press <b>MENU</b>.</p> <div style="border: 1px solid black; padding: 2px; width: fit-content; margin: 5px auto;">1. SYSTEM SET UP</div>	<p><b>5</b> </p>	<p>Press <b>START/SET</b>.</p> <div style="border: 1px solid black; padding: 2px; width: fit-content; margin: 5px auto;">RESET OK?</div>
<p><b>2</b> </p>	<p>Press <b>#80</b>.</p> <div style="border: 1px solid black; padding: 2px; width: fit-content; margin: 5px auto;">SET DEFAULT</div>	<p>—If this feature is not required, press the <b>STOP</b> button.</p>	
<p><b>3</b> </p>	<p>Press <b>START/SET</b>.</p> <div style="border: 1px solid black; padding: 2px; width: fit-content; margin: 5px auto;">RESET=NO [▲▼]</div>	<p><b>6</b> </p>	<p>Press <b>START/SET</b> again for confirmation.</p> <div style="border: 1px solid black; padding: 2px; width: fit-content; margin: 5px auto;">RESET COMPLETED</div>
<p><b>4</b> </p>	<p>Press <b>▲</b> or <b>▼</b> to select "YES".</p> <div style="border: 1px solid black; padding: 2px; width: fit-content; margin: 5px auto;">RESET=YES [▲▼]</div>	<p><b>7</b> </p>	<p>Press <b>MENU</b> to end the program.</p>

## Voice contact

You can have a voice conversation on the same call after fax transmission or reception is completed. This saves the extra expense and time of making a subsequent telephone call to discuss the information sent over the fax.

### Important:

- This feature works only when the other party's unit is equipped with the voice contact/call reservation feature.

### Initiating voice contact

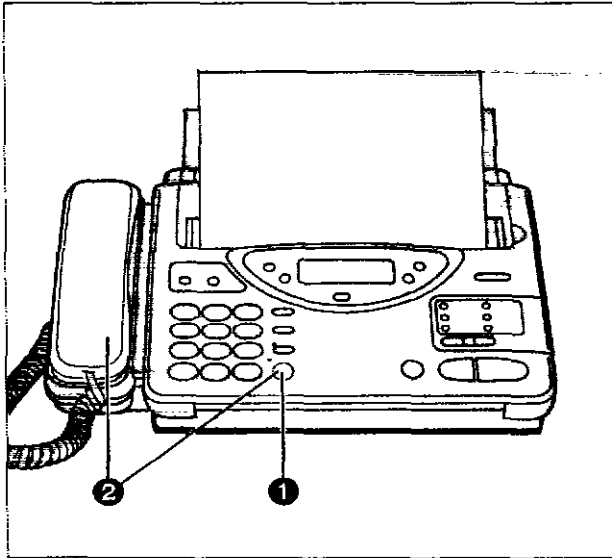

- 1 Press **SP-PHONE/VOICE STDBY** while transmitting or receiving documents.

VOICE STANDBY

—Your unit will call the other party with a distinctive ring.

- 2 When the other party answers, the unit will emit a distinctive ring. While ringing, press **SP-PHONE/VOICE STDBY** again or lift the handset to start speaking.

### Notes:

- If you initiate voice contact while transmitting documents, you can speak after all the documents have been transmitted.
- If you initiate voice contact while receiving documents, you can speak after the current page of the documents is received.
- You can initiate the voice contact by lifting the handset during transmission or reception.
- If the other party does not answer, the line will be disconnected automatically.

### Receiving a request for voice contact

If the other party initiates voice contact, your unit will emit a distinctive ring after the transmission or reception is completed.

When a distinctive ring is heard, press **SP-PHONE/VOICE STDBY** or lift the handset, then start speaking.

### Note:

- If you do not answer within 10 seconds of hearing the distinctive ring, one of the following occurs:
  - When the unit is in the **ANS/FAX** mode, it will play back your greeting message and record the incoming voice message.
  - When the unit is in the **TEL/FAX, FAX** or **TEL** mode, the line will be disconnected.

## TONE, RECALL and PAUSE buttons

### TONE button

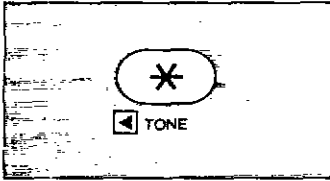

The TONE (\*) button is used when your line has a rotary pulse dial service. Pressing the button allows you to change temporarily from pulse to tone mode during a dialling operation. When you hang up, the unit will automatically return to pulse mode.

**Note:**

- TONE can be stored into a phone number for automatic dialling.

### RECALL button

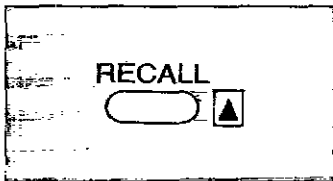

The RECALL button is used to access some of the features of your host PABX (Private Automatic Branch Exchange) or special telephone company services (optional) such as call waiting. Contact your telephone company for details.

**Note:**

- RECALL can be stored into a phone number for automatic dialling.

**Example:** British Telecom call waiting

1. Ensure that you have set the RECALL MODE to the T-BR (Time Break Recall). See page 44.
2. When the call waiting tone is heard during a conversation, press the RECALL button.
3. When the dial tone is heard, dial 2.  
The first party is put on hold and you can have a conversation with the second party.
4. To keep the present call and return to the first call:  
Press the RECALL button, and when dial tone is heard dial 2.  
To terminate the first call:  
Press the RECALL button, and when dial tone is heard dial 0.  
To terminate the present call and return to the first call:  
Press the RECALL button, and when dial tone is heard dial 1.

### PAUSE button

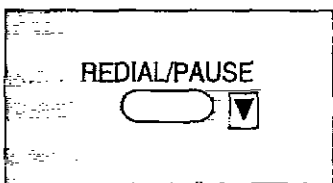

Pressing the REDIAL/PAUSE button causes a dialling delay of 3½ seconds in the dialling sequence.

**Example-1:** When your unit is connected to a host exchange, insert a pause as follows to get an outside line.



**Example-2:** If a transmission error occurs frequently when making an overseas transmission, add two pauses at the end of the phone number.

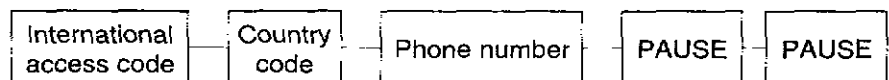

**Note:**

- PAUSE can be stored into a phone number for automatic dialling.

## Voice mailbox

The unit has four memory locations—common memory and three mailbox memories. The greeting messages and incoming calls can be recorded into each memory location.

This feature is useful when the unit is shared with other people and you wish the caller to record directly to your mailbox.

Your caller can leave a message in a specific mailbox, and only the person who knows the password can retrieve the message from the mailbox.

This unit has three personal mailboxes and you can program a password for each one of them.

### To use mailbox

1. Record common greeting message into the common memory (see page 10).
2. Record personal greeting message(s) into the mailbox(es) (see below).
3. Program each mailbox password (see page 49).
4. In order to leave a message into a mailbox, the owner(s) of the mailbox(es) must inform callers in advance of their mailbox number.

**Note:**

- Greeting messages and incoming calls will be recorded in common memory unless the user selects a mailbox.

### Recording a personal greeting message for a mailbox

Record a personal greeting message for each mailbox. This will be played back to the caller who selects the specific mailbox. Each greeting message can be recorded up to 16 seconds.

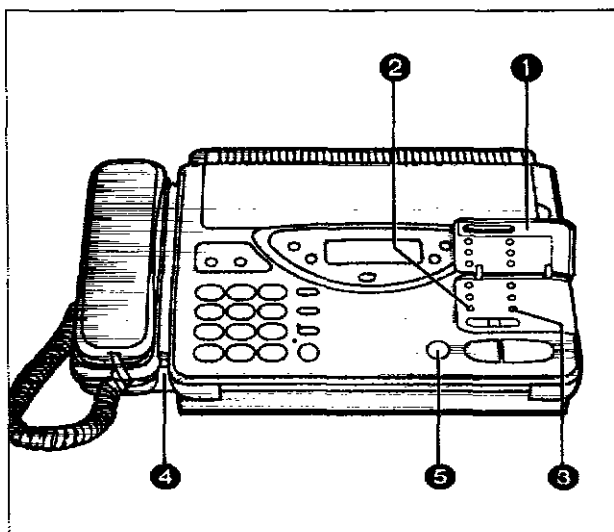

- 1 Open the station key panel.
- 2 Press **GREETING SELECT** until the desired mailbox number is displayed.  
*Example: Mailbox 2*

BOX2 - GREETING

- 3 Press **GREETING REC.**  
—A long beep will be heard.

BOX2 REC. 16s

- 4 Immediately after the long beep, speak clearly and loudly into the microphone.
- 5 When finished, press **STOP**.

**Note:**

- We recommend a brief greeting message to leave more time for incoming messages. If you do not record a mailbox greeting message, incoming messages can be recorded after the long beep.



## Programming the mailbox password

Program your own password for your mailbox to prevent other users from retrieving messages. You can choose any 3-digit number except a number including "0".



Press **MENU**.

1.SYSTEM SET UP

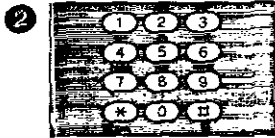

For the mailbox 1, press #51.  
For the mailbox 2, press #52.  
For the mailbox 3, press #53.

**Example: Mailbox 1**

BOX1 PASSWORD

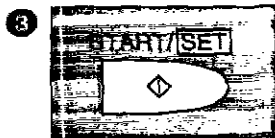

Press **START/SET**.

NEW NO. =

—When you have programmed the password before and wish to change it:

OLD NO. =

1. Enter the current password.
2. Press **START/SET**.

NEW NO. =

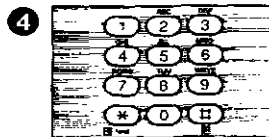

Enter the new password (111-999).

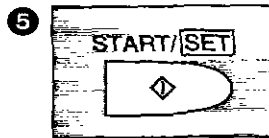

Press **START/SET** to store the setting.  
—To program other passwords, repeat from step 2.



Press **MENU** to end the program.

### Notes:

- We recommend that you do not use seven (7) as a password number, because this number is used as the greeting message re-recording command for remote operations.
- If you forget your password, consult with your service centre.

## How incoming messages are recorded into each mailbox

In order to leave a message in a mailbox, the owner(s) of the mailbox(es) must inform their callers of their mailbox number in advance and set the unit in the **ANS/FAX** mode.

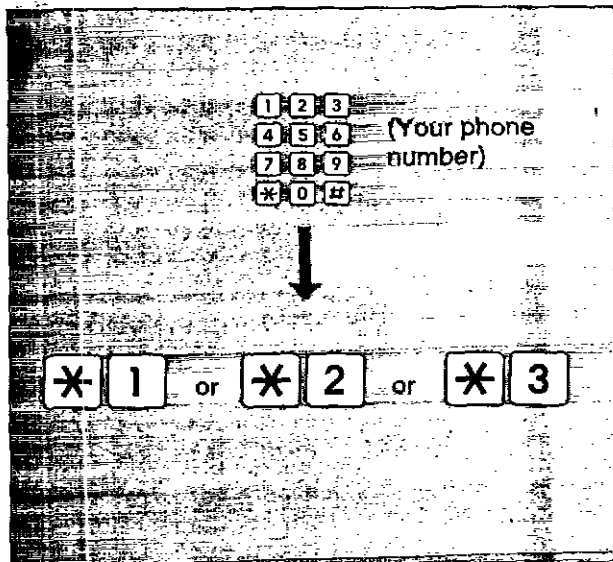

- ① A caller may call your unit (from a touch tone telephone only).  
—The common greeting message will be heard.
- ② They may press \*, then enter the desired mailbox number (1-3).  
—The personal greeting message will be heard, followed by a long beep.
- ③ They may leave a message in the mailbox.

### Note:

- If a caller does not specify the mailbox in step 2, the message will be recorded into the common memory.

## Retrieving messages in the mailbox

When there is a new message in a mailbox, the mailbox indicator will flash on the display.

**Example:** A new incoming message has been recorded in mailbox 2.

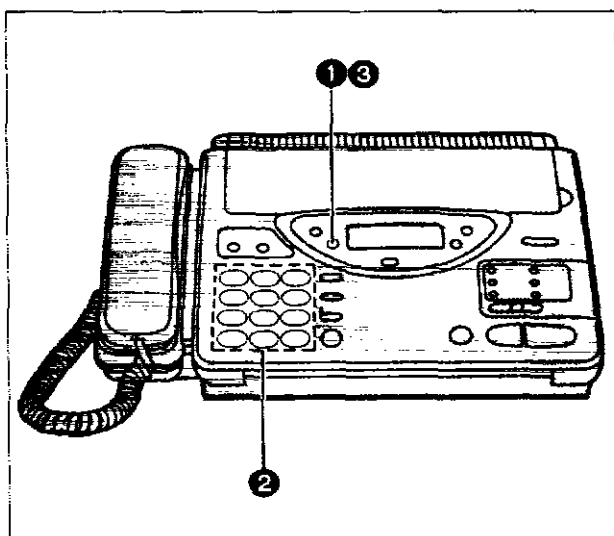
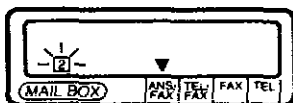

- 1 Press **MAIL BOX** repeatedly until the desired mailbox number is displayed.

**Example:** The mailbox number is 2.

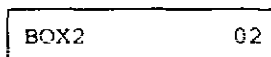

- 2 Enter the mailbox password.

**Example:** The password is 555 (factory setting).

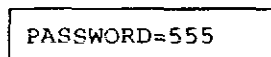

—The unit will automatically play back newly recorded messages.

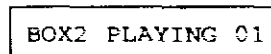

- 3 To exit the mailbox, press **MAIL BOX**.

### Notes:

- If no new messages are recorded, the unit will play back all the messages recorded in the mailbox.
- The ALL MESSAGES, REPEAT, SKIP and STOP buttons can be used.
- If you leave the mailbox password set to "555" (factory setting), you need not enter the password in step 2. To listen to the recorded messages, press the NEW MESSAGES or ALL MESSAGES button.

## Erasing recorded messages in the mailbox

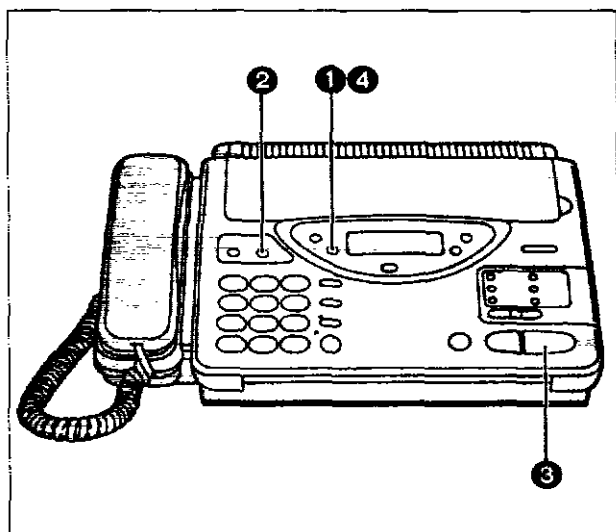

- Erasing specific messages in the mailbox: Press **ERASE** while the message you want to erase is playing.

- Erasing all messages in the mailbox:

- 1 Press **MAIL BOX** repeatedly until the desired mailbox number is displayed.

**Example:** Mailbox 1

- 2 Press **ERASE**.

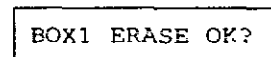

- 3 Press **START/SET** for confirmation.

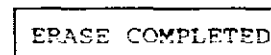

- 4 To exit the mailbox, press **MAIL BOX**.

## Retrieving messages in the mailbox from a remote location

The following operation allows the unit to play back voice messages stored in the mailbox from a remote location.

The feature is available when the unit is in the *ANS/FAX* mode.

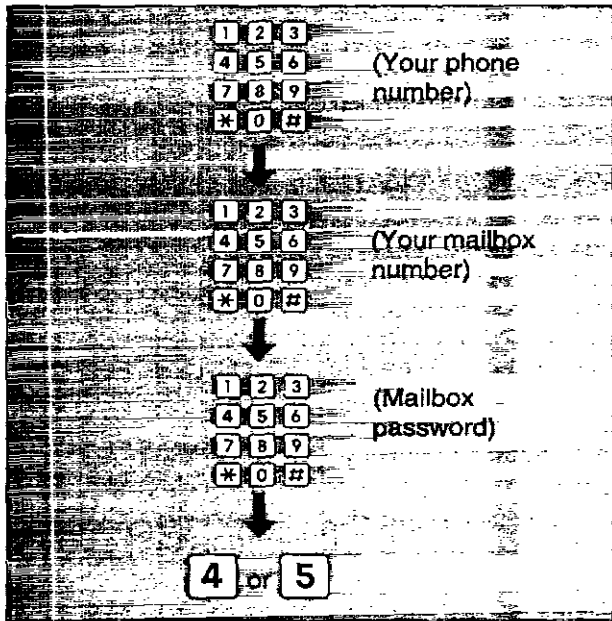

- 1 Call your unit from a touch tone telephone.  
—The common greeting message will be heard.
- 2 Press \*, then press the desired mail box number (1–3).  
—The personal greeting message will be heard.
- 3 Press the mailbox password (3-digit).  
—A long beep and short beep(s) will sound.  
Short beep(s) indicate(s) the number of newly recorded message(s).  
Short beeps will sound up to 8 times even if 9 or more calls are recorded.
- 4 Press 4 for new message playback.  
or  
Press 5 or wait for 4 seconds for all message playback.

## Setting the mailbox alert

When this feature is set, the unit will emit a slow beep if a message has been recorded in a mailbox.

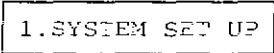
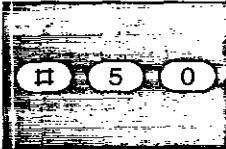
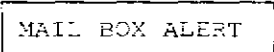
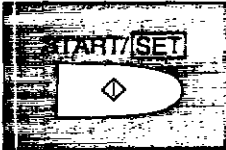
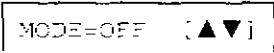
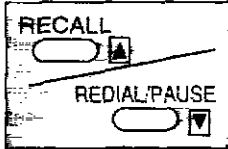
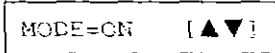
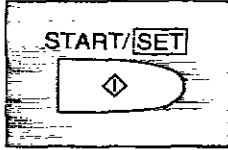
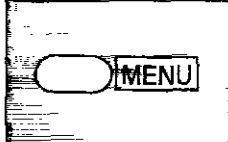
- 1  Press **MENU**.  

- 2  Press **#50**.  

- 3  Press **START/SET**.  

- 4  Press **▲** or **▼** to select "ON".  
  
—If this feature is not required, select "OFF".
- 5  Press **START/SET** to store the setting.
- 6  Press **MENU** to end the program.

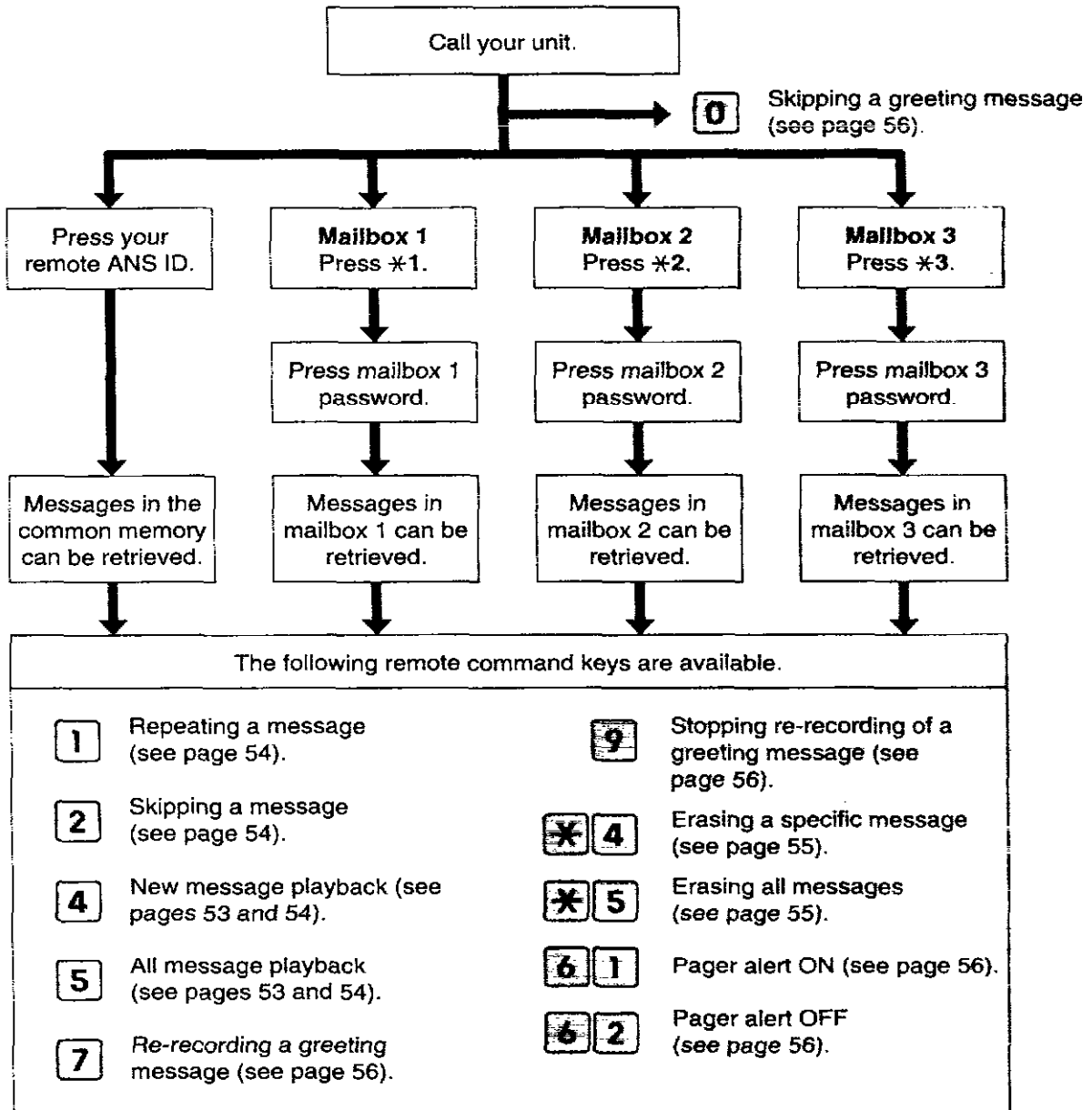
## Operating the answering device from a remote phone

You can access your unit and retrieve the incoming messages from a remote location with a touch tone telephone.

### Summary of remote operations



**Note:**



- During remote operation, the unit will be stopped and 2 beeps will be heard in the following conditions:
    - 2 minutes 40 seconds after your unit answered.
    - Every 2 minutes 40 seconds after pressing the command button.
- To listen to further messages, dial "8" within 10 seconds after hearing two beeps.

## Programming the remote ANS ID

The remote ANS ID is used to access your answering device from a remote location with a touch tone telephone.

Choose any number from 111 to 999 except a number including "0".

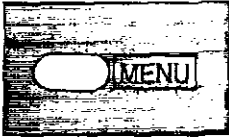
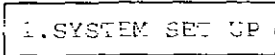
Make sure that the first 2 digits of the remote ANS ID are different from the junk mail prohibitor ID.

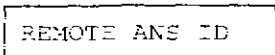
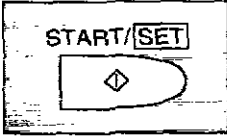
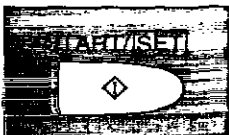
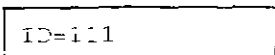
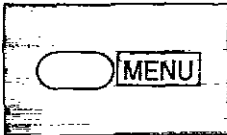
<p><b>1</b> </p>	<p>Press <b>MENU</b>.</p> 	<p><b>4</b> </p>	<p>Enter the desired number (111-999).</p>
<p><b>2</b> </p>	<p>Press <b>#10</b>.</p> 	<p><b>5</b> </p>	<p>Press <b>START/SET</b> to store the setting.</p>
<p><b>3</b> </p>	<p>Press <b>START/SET</b>.</p> 	<p><b>6</b> </p>	<p>Press <b>MENU</b> to end the program.</p>

**Note:**

- We recommend that you do not use seven (7) as an ID number, because this number is used as the greeting message re-recording command for remote operations.

## Listening to the recorded messages in the common memory

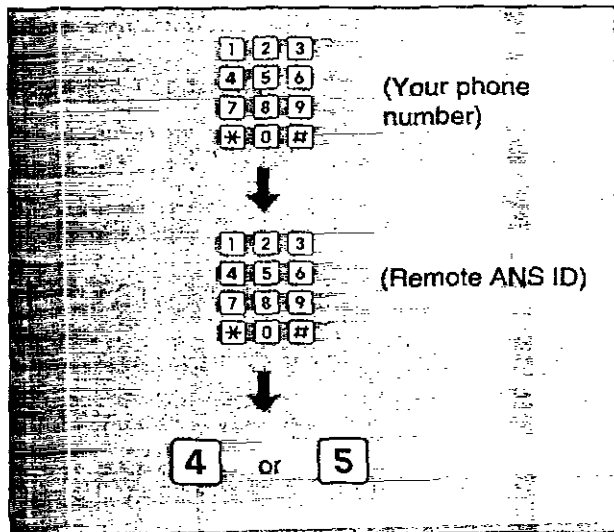

- 1 Call your unit.  
—The unit will play the greeting message.
- 2 Press the remote ANS ID during the common greeting message.  
—A long beep and short beep(s) will sound. Short beep(s) indicate(s) the number of newly recorded messages. Short beeps will sound up to 8 times even if 9 or more calls are recorded.
- 3 Press 4 to listen to newly recorded messages. OR Press 5 or wait for 4 seconds to listen to all the recorded messages.

**Note:**

- If you hear 6 beep tones after playing back messages, the memory is full. You must erase some or all messages.

**If you want to listen to messages in the mailbox after playing back messages in the common memory;**

1. Press \* and 1, 2 or 3 (desired mailbox number).
2. Press the mailbox password.
3. Press 4 (for new message playback) or 5 (for all message playback) to play back messages.

### Retrieving the recorded messages in the mailbox

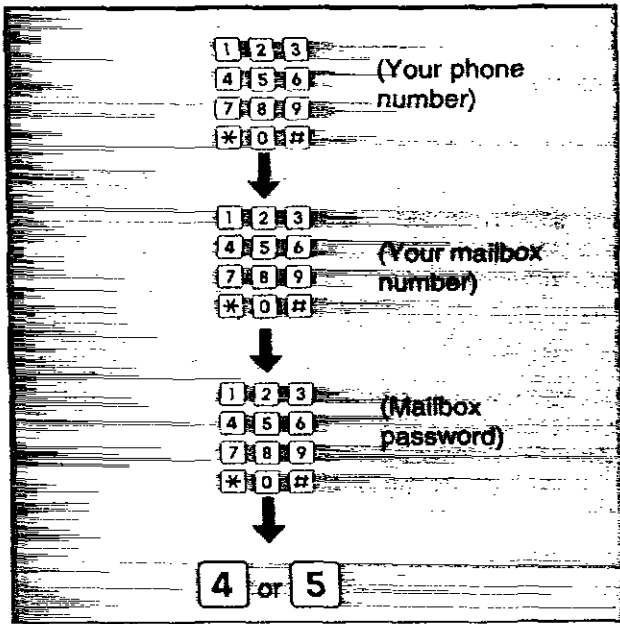

- 1 Call your unit.
- 2 Press \* and the desired mailbox number (1-3).
- 3 Enter a mailbox password during a personal greeting message.
  - A long beep and short beep(s) will sound. Short beep(s) indicate(s) the number of newly recorded messages. Short beeps will sound up to 8 times even if 9 or more calls are recorded.
- 4 Press 4 to listen to newly recorded messages. OR Press 5 or wait for 4 seconds to listen to all the recorded messages.

**If you want to listen to messages in the other memory after playing back:**

1. Press \*, and 0 (for common memory). Press \* and other mailbox number 1, 2 or 3.
2. Press the mailbox password if you selected the mailbox.
3. Press the direct remote command 4 or 5 to play back messages.

### Functions during playback

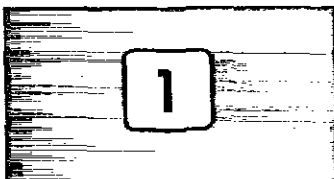

- **Repeating the current message:**  
Press 1 to repeat the message currently being played.

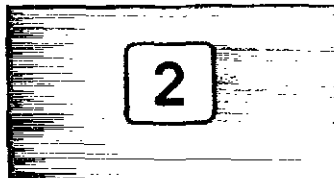

- **Skipping a message:**  
Press 2 to start to play the next message.

### Erasing a specific message from memory

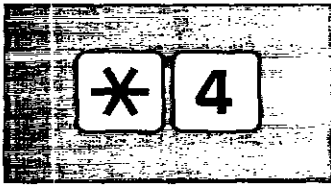

Press \* 4 when the message you want to erase is being played.

- The unit will erase the message just played back.
- A long beep followed by three short beeps will be heard. Then the unit will continue with the next message.

### Erasing all messages from memory

You can erase all the recorded messages in the accessing memory. To erase all messages in a mailbox, you must first select the mailbox.

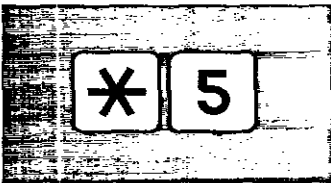

Press \* 5.

- A long beep followed by three short beeps will be heard.
- The unit will erase all the recorded messages.

**Note:**

- The greeting messages will not be erased in this operation.

### Recording a marker message

After playing back the recorded messages, you can leave an additional message during the same call. Wait for 3 beeps indicating the end of the remote operation and wait about 10 seconds for another 2 beeps indicating that the unit is ready for recording, then you can leave your message.

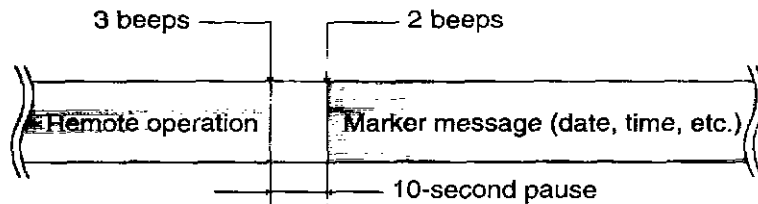

## Re-recording a greeting message

You can change the content of the greeting message from a remote location.

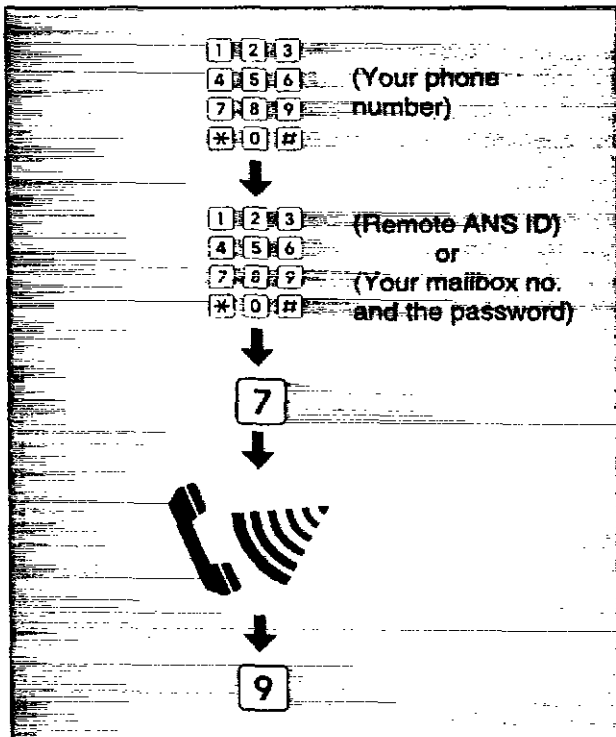

- 1 Call your unit.
- 2
  - For the common greeting message: Dial your remote ANS ID while the greeting message is playing.
  - For the mailbox greeting message: Press \* and 1, 2 or 3 (desired mailbox no.). Then enter the mailbox password.
- 3 Press 7 to start re-recording after hearing a beep.
  - A long beep will sound.
- 4 After hearing a long beep, speak clearly and loudly for up to 16 seconds.
  - If you pause for over 2 seconds while recording, the unit will beep and stop the greeting message recording. In this event, repeat from step 2 within 10 seconds.
- 5 When finished, press 9.
  - The new greeting message will be played back to confirm the content.

## Turning on/off pager alert

You can remotely turn on/off a pager alert feature which has been programmed with a pager number in advance (see page 57).

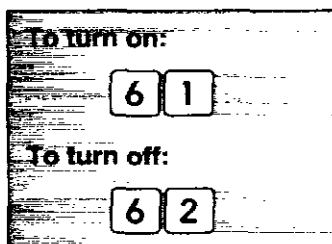

- 1 Call your unit.
- 2 For the common pager alert, press the remote ANS ID.  
or  
For a mailbox pager alert, press \* and the mailbox number (1, 2 or 3), then press the mailbox password.
- 3 To turn on the pager alert, press 61.  
To turn off the pager alert, press 62.

## To skip the greeting message

Callers can record their messages without listening to the greeting message.

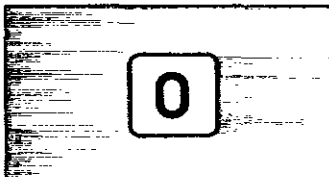

They may call your unit, then dial 0 during the greeting message playback.
   
—The unit will skip the rest of the greeting message and start recording.



## Pager alert

The feature allows your unit to call your pager automatically each time an incoming message is recorded on the unit.

You can set the pager number for each memory (common, mailbox 1, 2 and 3).

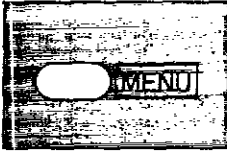
- 1**  Press **MENU**.

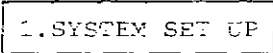
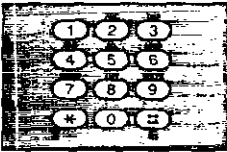
- 2**  For common pager alert, press #60.

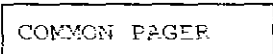

or

For mailbox 1 pager alert, press #61.

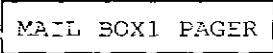

or

For mailbox 2 pager alert, press #62.

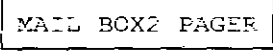

or

For mailbox 3 pager alert, press #63.

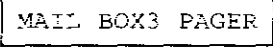
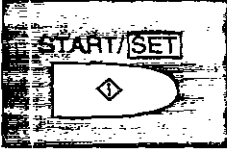

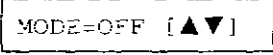
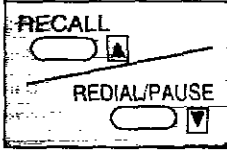
- 3**  Press **START/SET**.

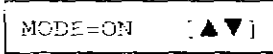
- 4**  Press **▲** or **▼** to select "ON".

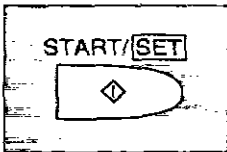

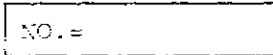
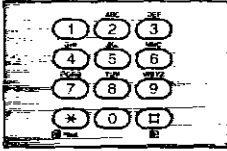
—If this feature is not required, select "OFF".
- 5**  Press **START/SET**.

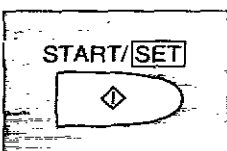
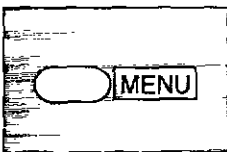
- 6**  Enter your pager phone number. If necessary, press the PAUSE button. Please contact your pager company regarding the proper pause time.

If your pager has the ability to display phone numbers, enter the number that you wish to appear in the display. Press "#" if required by your pager company.
- 7**  Press **START/SET** to store the setting.
- 8**  Press **MENU** to end the program.

When the pager beeps, call your unit from a touch tone telephone to retrieve the message.

**Notes:**

- You may enter a total of 30 digits and/or pauses in step 6 above.
- This feature can be turned on/off remotely from a touch tone phone (see page 56).

## **The Mercury Residential Service**

---

Mercury's Residential Service is a highly competitive telephone service for the residential and small business user.

Most UK long distance and international calls are cheaper over Mercury, especially in the Economy period.

Mercury calls are rounded to the second, and charged to the nearest tenth of a penny. You will also receive fully itemised bills. Mercury Customer Services are available 24 hours a day to provide the highest level of customer service.

There are two ways to access Mercury, the Residential 132 Service and the Mercury PIN Codes Service. You can find out the best method for you by calling Mercury Customer Services on FreeCall 0500-500 194 (24 hours). Most homes and businesses are now able to access the Mercury network via their existing BT line. Mercury Customer Services will be able to check whether Mercury is available in your area.

All Mercury's charges and tariffs are the same for both methods of accessing Mercury—the only difference is how you connect to the Mercury network.

### **For Residential 132 Service customers**

Once you have become a Mercury Residential 132 customer, you simply dial 132 before a long distance or international call to send it over the Mercury network.

The Mercury button on your unit comes with the digits '132' pre-stored in it.

To check that you have access to Mercury, press the SP-PHONE button, wait for the dial tone, press the MERCURY button, and dial 132. This call is free of charge. You should be connected to a recorded message welcoming you to the Mercury network. If you have any difficulties, please contact Mercury Customer Services (Fault Reporting) on FreeCall 0500-500 193 (24 hours).

To send your long distance and international calls over Mercury, press the MERCURY button before the STD code and telephone number of the person you are calling.  
*For further details on Mercury dialling operation, see page 60.*

## For Mercury PIN Codes Service customers—Programming the MERCURY button with your PIN Code

After you apply for Mercury PIN Codes Service you will receive a Mercury PIN Code in two separate parts. The PIN Code, which is similar to bank PIN number, identifies you as a Mercury customer and will need to be stored in the unit's memory using the MERCURY button.

Before programming your unit with the Mercury PIN Code, you must ascertain which type of local BT exchange you are connected. See page 21.

- 1 Ensure that the unit is plugged into the BT socket.  
Reset the Mercury dial memory (see page 61).

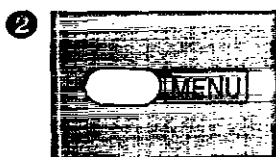

Press **MENU** until the following is displayed.

2. STORE TEL. NO.

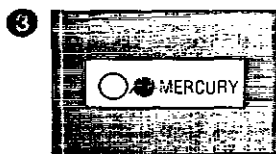

Press **MERCURY**.

<[M]>=132

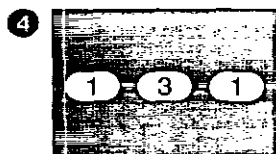

Dial 131.

<[M]>=131



**If you are connected to a Tone exchange:**  
Press **PAUSE** once (twice if programming proves unsuccessful).

or

or

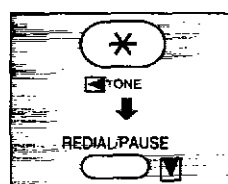

**If you are connected to a Pulse exchange:**  
Press **TONE** (\*), then press **PAUSE**.

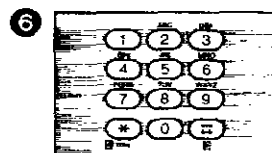

Dial the digits of the Mercury PIN Code (part 1 then part 2).



Press **START/SET** to store the setting.



Press **STOP** to end the program.

To check if the PIN Code has been programmed correctly, press the SP-PHONE button, wait for the dialling tone, and press the MERCURY button (followed by 2 or 3 digit Cost Centre Code\* if applicable) and dial 1500. This call is free of charge. During connection you will hear a series of short beeps. This is the Mercury dial tone. After a few seconds you should be connected to a recorded message welcoming you to the Mercury network. If you have any difficulties, please contact Mercury Customer Services on FreeCall 0500-500 193 (24 hours).

\*Cost centre code: See page 60.

## Confirming the Mercury dial memory

Program the Mercury code again into the MERCURY button using the procedure on previous page. When the START/SET button is pressed in step 7, you will hear a beep twice or six times for confirmation.

**2 beeps:** The code number newly entered is the same as that was previously stored.

**6 beeps:** The code number newly entered is different from the one that was previously stored. If you want to store the new code number, reset the Mercury dial memory, then reprogram it. For resetting the memory, see page 61.

**Note:**

- If you encounter a problem, see page 61.

## Making a call via Mercury

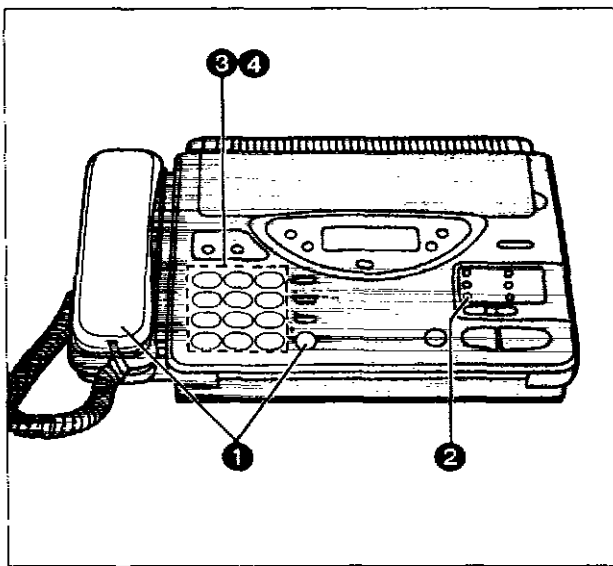

- 1 Press the **SP-PHONE** button or lift the handset, then identify the dial tone.
- 2 Press the **MERCURY** button.
- 3 Dial the chosen Cost Centre Code\* if applicable (see below).
- 4 Dial the phone number you wish to call by using a full number, one touch dialling or speed dialling.

### \*Cost Centre Codes

Cost Centre Codes are selectable on your Mercury order form. By keying in a code number (either 2 or 3 digits) before dialling each and every Mercury call, businesses can allocate calls to different jobs, or residential users can see who is responsible for each call. If you have requested this option, then to make a call via Mercury, you must;

1. Press the SP-PHONE button.
2. Press the MERCURY button.
3. Key in your chosen Cost Centre Code (any two or three digit number except 112 or 999).
4. Dial the number required.

**Please note that Cost Centre Codes are not currently available with Residential 132 Service.**

## Resetting Mercury dial memory—Returning to Residential 132 Service

If you wish to change your Mercury code to a new one or if you need to send your unit away for repair, you must reset the Mercury dial memory using the following procedure.

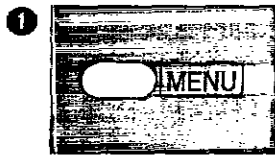

Press **MENU**.

1.SYSTEM SET UP

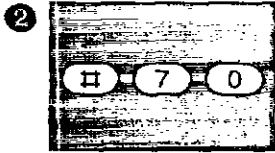

Press **#70**.

RESET MERCURY

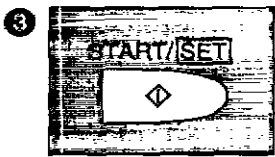

Press **START/SET**.

RESET=NO [▲▼]

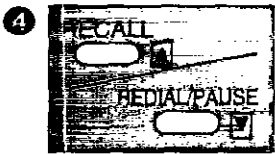

Press **▲** or **▼** to select "YES".

RESET=YES [▲▼]

—If you wish to confirm the Mercury dial memory, select "NO".

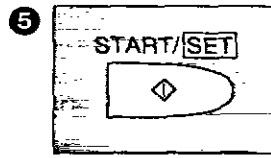

Press **START/SET**.

RESET OK?

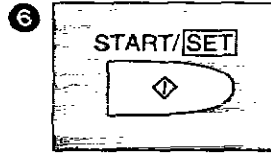

Press **START/SET**.

RESET COMPLETED

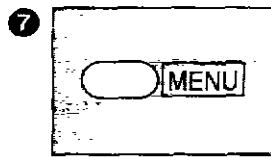

Press **MENU** to end the operation.



## Printing reports and lists

You can get the following reports and lists from your unit. See pages 63 and 64 for sample reports and lists.

**Basic Feature List:**

This provides you with the current settings of the basic programming features (#01 to #10).

**Advanced Feature List:**

This gives you a list of the current settings of the advanced programming features (#21 to #80).

**Telephone Number List:**

This is a list of phone numbers and station names that are stored for one-touch dialling and speed dialling.

**Journal Report:**

This gives you a record of all transmissions and receptions (up to 35 fax communications). This report is useful for keeping telephone records or for verifying telephone charges.

This report can be also printed automatically after every 35 fax communications (see page 65).

**Printer test list:**

This allows you to check the print quality of your unit.

If the test pattern has any blurred points or lines or dirty patterns, please clean the thermal head by following the instructions on page 73.

### How to print each report/list

1

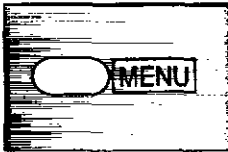

Press **MENU** repeatedly until the following is displayed.

3. PRINT LIST

2

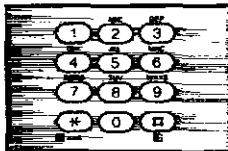

For the basic feature list, press #1.

BASIC LIST

For the advanced feature list, press #2.

ADVANCED LIST

For the telephone number list, press #3.

TEL NO. LIST

For the journal report, press #4.

JOURNAL REPORT

For the printer test list, press #5.

PRINTER TEST

3

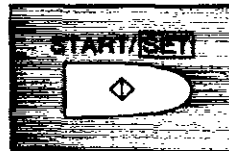

Press **START/SET** to start printing.

PRINTING

4



Press **MENU** to end the operation.

## Sample reports and lists

### Basic feature list

BASIC FEATURE LIST		
NO.	FEATURE	CURRENT SETTING
#01	SET DATE & TIME	Jan. 01 1995 12:13AM
#02	YOUR LOGO	Panasonic FAX SYSTEM
#03	YOUR TELEPHONE NUMBER	
#04	PRINT TRANSMISSION REPORT	ERROR [ERROR,ON,OFF]
#06	TEL/FAX DELAYED RING	2 [1...4]
#07	FAX RING COUNT	2 [1...4]
#08	ANS-FAX RING COUNT	2(NORMAL) [1...4,TOLL SAVER,RINGER OFF]
#09	RECORDING TIME	LONG [LONG,SHORT]
#10	REMOTE ANS ID	ID = 111

### Advanced feature list

ADVANCED FEATURE LIST		
NO.	FEATURE	CURRENT SETTING
#21	LOGO POSITION	OUT [OUT,IN,OFF]
#22	JOURNAL AUTO PRINT	ON [ON,OFF]
#23	OVERSEAS MODE	OFF [ON,OFF]
#24	JUNK MAIL PROHIBITOR	OFF [ON,OFF]
#25	DELAYED TRANSMISSION	OFF [ON,OFF]
	DESTINATION =	
	START TIME = 12:00AM	
#30	SILENT FAX RECOGNITION RING	3 [3...6]
#32	DAY/NIGHT MODE	OFF [ON,OFF]
	DAY MODE TIME = 12:00AM	
	NIGHT MODE TIME = 12:00AM	
#33	PAPER SAVE PLACEMENT	OFF [ON,OFF]
#34	EXTENSION	
#35	EXTENSION	[T, BR, E, RE]

### Telephone number list

STATION KEY LIST			
TELEPHONE NUMBER	NAME	TELEPHONE NUMBER	NAME
01 092-123-4567	COMPANY A	05 999-1234	
02 83-555-1234	COMPANY B	06 [ ]	
03 012-999-8877	COMPANY C	07	
04 83P4567		08	
AUTO KEY LIST			
TELEPHONE NUMBER	NAME	TELEPHONE NUMBER	NAME
00 111-2233*123		11 222-3344	COMPANY D
01 765-4321		12 092-555-6677	COMPANY E
02 345F6789		13	
03 092[ ]		14	
04		15	
05			

#### Codes in each phone number

\*: \* has been entered.

P: The pause has been entered.

F: The recall has been entered.

-: The hyphen has been entered.

[ ]: The secret phone number has been entered.  
(The telephone number is not printed.)

**Journal report**

JOURNAL							
Jan. 01 1995 06:05PM							
NO.	OTHER FACSIMILE	START TIME	USAGE TIME	MODE	PAGES	RESULT	*CODE
01	1234567	Jan. 01 11:20AM	01'20	TX	02	OK	
02	9998765	Jan. 01 11:52AM	00'56	TX	01	OK	
03	<< G3 >>	Jan. 01 11:58AM	00'32	RX	01	OK	
04	555556677	Jan. 01 00:19PM	01'48	TX	03	OK	
05	+987 1234	Jan. 01 00:35PM	01'42	RX	03	OK	
06	<S01>	Jan. 01 01:14PM	02'40	TX	05	OK	
07	7776543	Jan. 01 01:27PM	01'03	TX	01	OK	
08	4445566	Jan. 01 02:46PM	01'18	TX	02	OK	
09	<A17>	Jan. 01 03:17PM	00'35	TX	00	COMMUNICATION ERROR	011
10	<< G3 >>	Jan. 01 03:19PM	01'21	RX	03	OK	
11	.....	Jan. 01 03:38PM	02'25	TX	04	OK	
				TX	01	OK	
				RX	02	OK	



- ① Communication mode:  
TX...Transmission  
RX...Reception  
POL.TX...Polling transmission  
POL.RX...Polling reception
- ② Number of pages received or transmitted successfully
- ③ Communication result  
(For the explanation of communication results, see page 70.)
- ④ Error code (for the service personnel use only)

**Printer test list**







## Setting journal auto print

This feature allows the unit to print a record of the last 35 fax communications (transmissions and receptions) automatically.

After printing, the information will be erased and only subsequent activity will be recorded.

When this feature is deactivated, the journal report data is stored until the memory becomes full. When memory is full and a new communication takes place, the oldest data will be erased and the newest data will be stored.

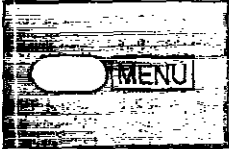
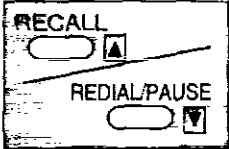
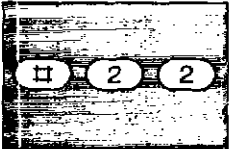
This feature is preset to ON. If you wish to deactivate the feature, proceed as follows:

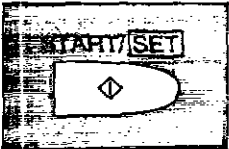
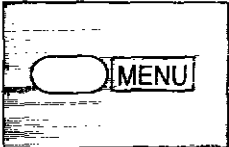
- |   |   |  |  |
|---|---|--|--|
| <p>① </p>  | <p>Press <b>MENU</b>.</p> <div style="border: 1px solid black; padding: 2px; width: fit-content; margin: 5px auto;">1.SYSTEM SET UP</div>                 | <p>④ </p>  | <p>Press <b>▲</b> or <b>▼</b> to select "OFF".</p> <div style="border: 1px solid black; padding: 2px; width: fit-content; margin: 5px auto;">MODE=OFF [▲▼]</div> <p>—If this feature is required, select "ON".</p> |
| <p>② </p>  | <p>Press <b>#</b>, then press <b>22</b>.</p> <div style="border: 1px solid black; padding: 2px; width: fit-content; margin: 5px auto;">AUTO JOURNAL</div> | <p>⑤ </p>  | <p>Press <b>START/SET</b> to store the setting.</p>  |
| <p>③ </p> | <p>Press <b>START/SET</b>.</p> <div style="border: 1px solid black; padding: 2px; width: fit-content; margin: 5px auto;">MODE=ON [▲▼]</div>               | <p>⑥ </p> | <p>Press <b>MENU</b> to end the program.</p>   |



## User programmable features

The unit has the following programming features.

**Basic features** are the settings that need to be programmed upon completing the installation. Most probable choices have been pre-selected, but some features, such as codes #01, #02 and #03, must be programmed by the user.

**Advanced features** should be programmed as the need arises.

### Programming feature table

#### Basic features

Code	Feature	Description	Selection	Page
#01	SET DATE & TIME	Setting the current date and time.		12
#02	YOUR LOGO	Setting your company name or personal name.	up to 30 digits	12
#03	YOUR TELEPHONE NUMBER	Setting your facsimile telephone number.	up to 20 digits	15
#04	PRINT TRANSMISSION REPORT	Setting individual transmission report printing.	ERROR/ ON/ OFF	15
#06	TEL/FAX DELAYED RING	Setting the number of rings on the extension phone (if connected) before the unit answers a call in the TEL/FAX mode.	1/ <u>2</u> /3/4	19
#07	FAX RING COUNT	Setting the number of rings to answer in the FAX mode.	1/ <u>2</u> /3/4	20
#08	ANS/FAX RING COUNT	Setting the number of rings to answer in the ANS/FAX mode.	1/2/3/4/ TOLL SAVER/ RINGER OFF	17
#09	RECORDING TIME FOR ANS	Setting the recording time for incoming message.	LONG (2 min. 30 sec.)/ SHORT (1minute)	11
#10	REMOTE ANS ID	Setting the remote control ID for remote operation of the answering device.	1-3 digits ( <u>111</u> )	53

**Note:** In the "Selection" column, the underlined print indicates the pre-selected settings.

**Advanced features**

Code	Feature	Description	Selection	Page
#21	LOGO POSITION	Setting the logo print position on the transmitted document.	<u>OUT</u> /IN/OFF	40
#22	JOURNAL AUTO PRINT	Printing journal report automatically.	<u>ON</u> /OFF	65
#23	OVERSEAS MODE	Setting the overseas transmission mode.	<u>ON</u> /OFF	40
#24	JUNK MAIL PROHIBITOR	Turning on the junk mail prohibitor feature. Also setting the prohibitor ID.	<u>ON</u> /OFF ID=2 digits (22)	38
#25	DELAYED TRANSMISSION	Setting the delayed transmission.	<u>ON</u> /OFF	36
#30	SILENT FAX RECOGNITION RING	Setting the number of rings when receiving a voice call in the TEL/FAX mode.	<u>3</u> to 6 rings	19
#32	DAY/NIGHT MODE	Turning on the day/night mode.	<u>ON</u> /OFF	41
#33	PAPER SAVE FUNCTION	Setting the paper save reception/copy.	<u>ON</u> /OFF	42
#34	EXTENSION COPY	Copying a document twice in length.		43
#35	RECALL MODE	Setting the recall mode.	<u>T_BR</u> /E_RE	44
#41	REMOTE FAX ACTIVATION CODE	Setting the remote fax activation code for remote receiving using an extension phone.	up to 4 digits (* *)	37
#42	MESSAGE ALERT	Turning on the message alert.	<u>ON</u> /OFF	29
#43	RECORDING TIME ALERT	Turning on the recording time alert.	<u>ON</u> /OFF	29
#46	ORIGINAL SETTING	Setting the contrast mode.	<u>NORMAL</u> / LIGHT/ DARKER	45
#50	MAIL BOX ALERT	Turning on the mailbox alert.	<u>ON</u> /OFF	51
#51	BOX1 PASSWORD	Setting password for mailbox-1.	<u>3</u> digits (555)	49
#52	BOX2 PASSWORD	Setting password for mailbox-2.	<u>3</u> digits (555)	49
#53	BOX3 PASSWORD	Setting password for mailbox-3.	<u>3</u> digits (555)	49
#60	COMMON PAGER	Setting the phone number for common pager.	<u>ON</u> /OFF	57
#61	MAIL BOX1 PAGER	Setting the phone number for mailbox-1 pager.	<u>ON</u> /OFF	57
#62	MAIL BOX2 PAGER	Setting the phone number for mailbox-2 pager.	<u>ON</u> /OFF	57
#63	MAIL BOX3 PAGER	Setting the phone number for mailbox-3 pager.	<u>ON</u> /OFF	57
#70	RESET MERCURY DIAL MEMORY	Resetting the Mercury dial memory.	<u>YES</u> /NO	61
#80	SET DEFAULT	Resetting the parameters of the advanced features.	<u>YES</u> /NO	45

**Note:** In the "Selection" column, the underlined print indicates the pre-selected settings.

## 10 Troubleshooting and Maintenance

### Error messages on the display

If the unit detects a problem, one of the following messages will appear on the display.

<b>ERROR MESSAGE</b>	<b>CAUSE AND REMEDY</b>
BATTERY LOW	<ul style="list-style-type: none"> <li>• Battery power is low. Replace the batteries with new ones (see page 7).</li> </ul>
CHECK COVER	<ul style="list-style-type: none"> <li>• The top cover is open. Close it.</li> </ul>
CHECK DOCUMENT	<ul style="list-style-type: none"> <li>• The document is not fed into the unit properly. Re-insert the document. If the misfeeding occurs frequently, clean the document feeder rollers inside the unit (see page 73). Problem remains unsolved, adjust the feeder pressure (see page 72).</li> </ul>
CHECK MEMORY	<ul style="list-style-type: none"> <li>• Memory (phone numbers, parameters, etc.) has been erased. Re-program them.</li> </ul>
MECHA ERROR	<ul style="list-style-type: none"> <li>• Mechanical error occurred. Open the cover and re-install the recording paper. Then press the STOP button and close the cover.</li> </ul>
MEMORY FULL	<ul style="list-style-type: none"> <li>• There is no room left in memory to record a message. Erase some or all messages (see page 27).</li> </ul>
NO ANS GREETING	<ul style="list-style-type: none"> <li>• The greeting message for the ANS/FAX mode has not been recorded. Record the greeting message (see page 10).</li> </ul>
NO RESPONSE	<ul style="list-style-type: none"> <li>• The receiving unit is busy or out of recording paper. Try again.</li> </ul>
NO TEL GREETING	<ul style="list-style-type: none"> <li>• The greeting message for the TEL/FAX mode has not been recorded. Record the greeting message (see page 10).</li> </ul>
OUT OF PAPER	<ul style="list-style-type: none"> <li>• The unit ran out of recording paper. Replace it with a new one (see page 6).</li> </ul>
PAPER JAMMED	<ul style="list-style-type: none"> <li>• The recording paper is jammed. Clear the jammed paper (see page 71).</li> </ul>
POLLING ERROR	<ul style="list-style-type: none"> <li>• The other unit does not provide the polling function. Check the other party.</li> </ul>
REMOVE DOCUMENT	<ul style="list-style-type: none"> <li>• The document is jammed. Open the cover, remove the jammed document (see page 72) and try again.</li> <li>• Attempted to transmit a document longer than 600 mm (23½"). Press the STOP button and remove the document (see page 72). When sending such a document, divide it into two or more sheets so that each sheet does not exceed 600 mm (23½") and try again.</li> </ul>
TRANSMIT ERROR	<ul style="list-style-type: none"> <li>• Transmission error occurred. Try again.</li> </ul>
UNIT OVERHEATED	<ul style="list-style-type: none"> <li>• The unit is too hot. Leave it as it is and allow it to cool down.</li> </ul>

## General corrective measures

---

### GENERAL

---

#### I cannot make and receive calls.

- The line cord is connected incorrectly or not connected. Confirm the connection (see page 5).

#### I cannot make calls.

- The setting of the dialling mode is wrong. Check the selector (see page 21).

#### The unit does not work.

- Disconnect the unit from the telephone line and connect a known working phone. If the known working phone operates properly, call your service personnel to have the unit repaired. If the known working phone does not operate properly, consult your telephone company.

#### The unit does not ring.

- The ringer volume is set to OFF. Raise it to a suitable level (see page 22).

#### The REDIAL/PAUSE button does not function properly.

- If this button is pressed during dialling, a pause will be inserted. If this button is pressed immediately after the dial tone is obtained, the last number dialled will be redialled.

#### I cannot program the remote ANS ID or the junk mail prohibitor ID.

- The whole or part of the number that is entered is the same as the other ID. Program a different number each other (see pages 38 and 53).

### FAX TRANSMISSION

---

#### The other party complains that letters on their received document are distorted.

- If your line has special telephone services such as call waiting, the service may have been activated during the fax reception. Connect the unit to a line that does not have such services.
- Another telephone connected to the same line is off the hook. Hang up and try again.

#### The other party complains that dirty patterns or a black line appear on their received documents.

- The glass or rollers on your unit are dirty. Clean them (see page 73).

#### I cannot make an international fax call.

- Use the overseas transmission mode (see page 40).
- Add two pauses at the end of the phone number (see page 47).

### FAX RECEPTION

---

#### I cannot receive documents automatically.

- The receive mode is set to *TEL*. Set the receive mode to *ANS/FAX*, *TEL/FAX* or *FAX*.
- The time to answer the call may be too long. Decrease the number of rings (see pages 17, 19 and 20).
- Junk mail prohibitor is set (see page 38).
- The greeting message may be too long. Shorten the message (see page 10) or ask the other party to press \* \* and then start transmission.

#### Recording image is faint.

- The sender transmitted a faint document. Request them to transmit a clearer copy of the document.
- The thermal head is dirty. Clean it (see page 73).

### ANSWERING DEVICE

---

#### No voice messages have been recorded in the ANS/FAX mode.

- The memory is full. Erase some or all messages (see pages 27 and 55).

#### I cannot retrieve recorded messages from a remote phone.

- Make sure that you use the remote ANS ID correctly (see page 53). When you dial it, press the buttons firmly.

#### Messages in the mailbox do not play back.

- You have programmed the mailbox password. Press the password and then try again (see page 49).

### COPYING

---

#### Dirty patterns or a black line appear on the copied documents.

- The glass or rollers on your unit are dirty. Clean them (see page 73).

#### Copied image is distorted.

- The thermal head is dirty. Clean it (see page 73).

## **Explanation of communication result on the report**

---

When trouble occurs, the following messages may be printed on the transmission report and the journal report.

<b>PRINTED MESSAGE</b>	<b>MEANING</b>
COMMUNICATION ERROR:	●Transmission or reception error occurred. Try again or check the other party.
DOCUMENT JAMMED:	●A document was jammed. Remove the jammed document (see page 72).
JUNKMAIL PROH. REJECT:	●The unit rejected fax reception when the junk mail prohibitor is activated.
NO DOCUMENT:	●The document was not fed into the unit properly.
NO RESPONSE:	●The receiving unit is busy or out of recording paper. Try again.
PAPER JAMMED:	●The recording paper was jammed.
PAPER OUT:	●The unit was out of recording paper.
PRESSED THE STOP KEY:	●The fax communication was interrupted because the STOP button was pressed.
PRINTER OVERHEATED:	●Printer was overheated.
THE COVER WAS OPENED:	●The top cover was open.
OK:	●Fax communication was successful.

## Clearing a recording paper jam

If the unit does not release any recording paper during reception or copying, the recording paper has jammed. Remove the jammed paper by following the steps below.

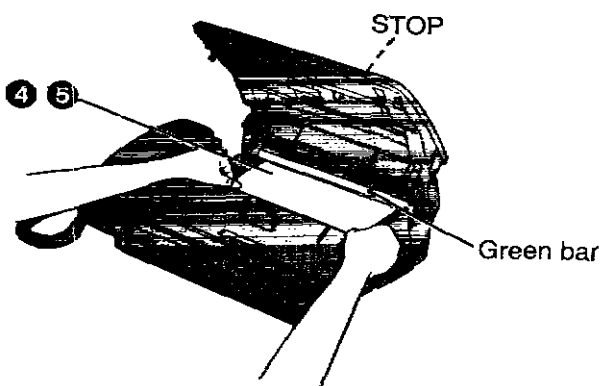
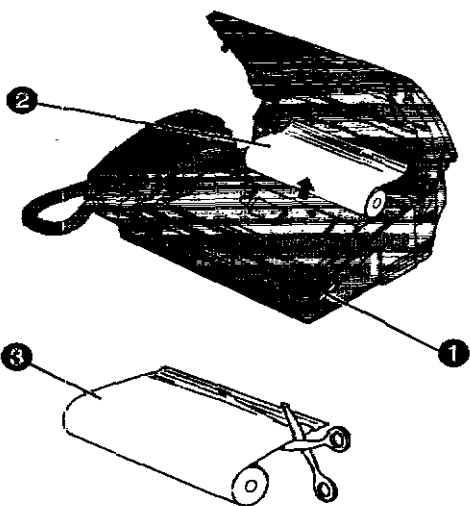

- 1 Slide the lever toward you to open the top cover.
- 2 Remove the jammed paper carefully.
- 3 Cut off the wrinkled portion.
- 4 Replace the recording paper roll in the proper direction.  
—Make sure that there is no slack in the paper roll.
- 5 Insert the leading edge of the paper under the green bar.  
—If the recording paper cannot be inserted, press the STOP button to reset the paper cutter and insert the paper again.
- 6 Close the cover carefully by gently pressing down on both ends.

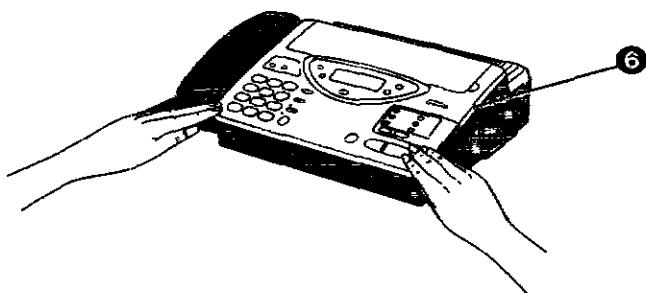

## Clearing a document jam

When an original document becomes jammed, remove the jammed document by following the steps below.

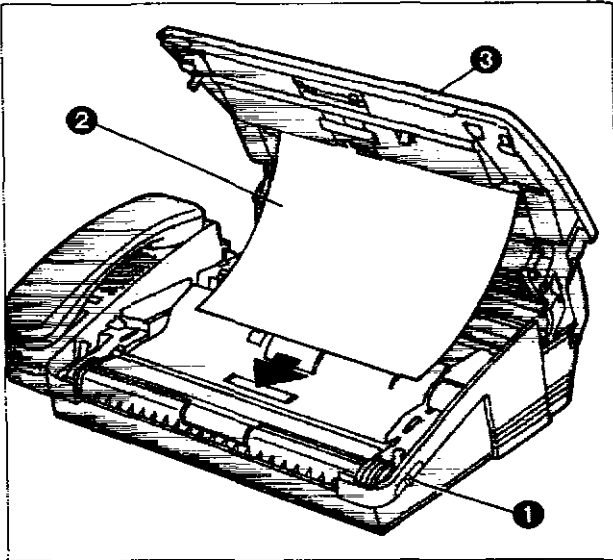

- 1 Slide the lever toward you to open the top cover.
- 2 Remove the jammed document carefully.
- 3 Close the cover carefully by gently pressing down on both ends.

## Adjusting the feeder pressure

If misfeeding of documents, such a multiple feeding or no feeding, occurs frequently, try to adjust the feeder pressure by following the steps below.

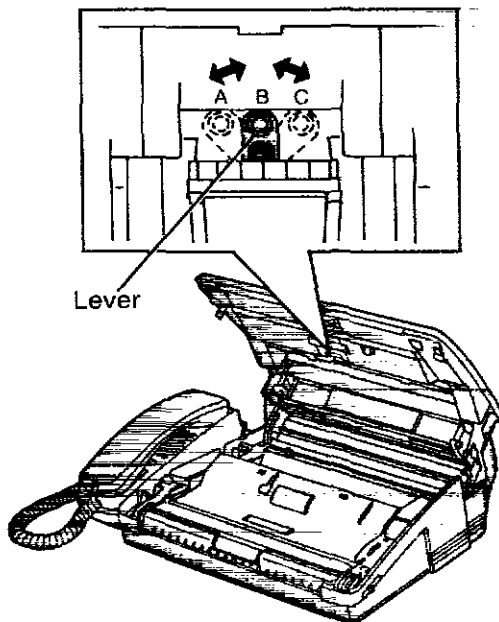

- 1 Open the top cover.
- 2 Shift the position of the lever by using an instrument with a pointed end, like a clip or ball-point pen.  
  
Position A: The case of no feeding  
Position B: Standard position  
Position C: The case of multiple feeding
- 3 Close the top cover carefully by gently pressing down on both ends.



## Cleaning the document feeder unit

When misfeeding occurs frequently or when dirty patterns or black bands appear on a copied or transmitted document, clean the sub roller, the document feeder rollers and the glass by following the steps below.

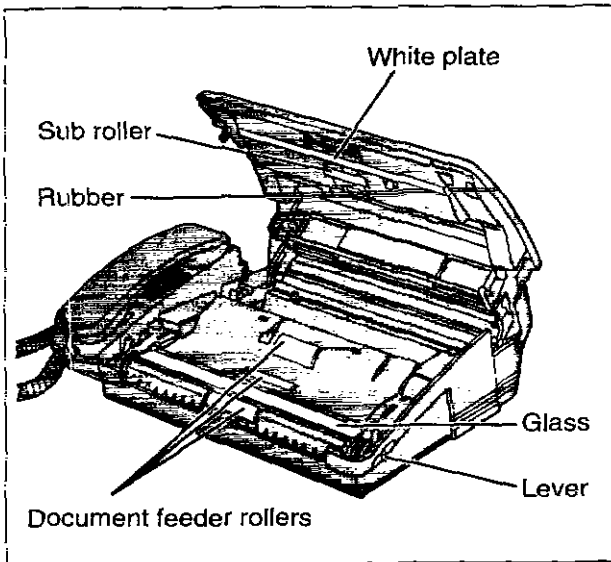

- ❶ Disconnect the power cord and the telephone line cord.
- ❷ Slide the lever toward you to open the top cover.
- ❸ Clean the rubber, the sub roller and the document feeder rollers with a cloth moistened with isopropyl rubbing alcohol, then dry thoroughly.
- ❹ Clean the glass and the white plate with a dry lint free soft cloth.
- ❺ Close the top cover carefully by gently pressing down on both ends.
- ❻ Connect the power cord and telephone line cord.

**Note:**

- Isopropyl rubbing alcohol can be obtained from most leading chemists.

## Cleaning the thermal head

If dirty patterns or black bands appear on a copied or received document, clean the thermal head by following the steps below.

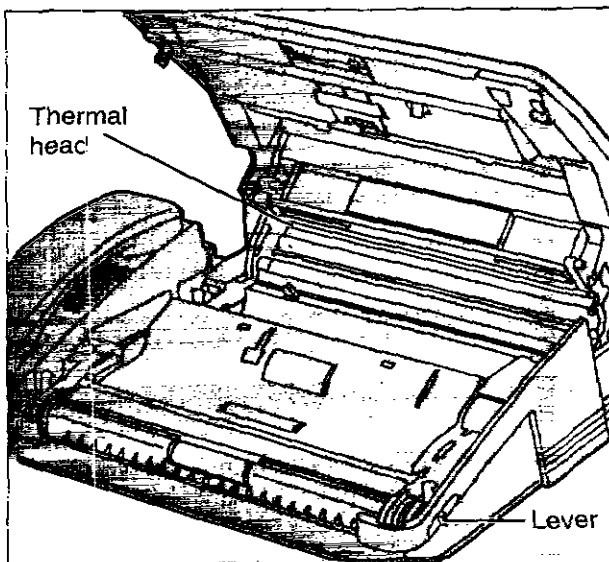

- ❶ Disconnect the power cord and the telephone line cord.
- ❷ Slide the lever toward you to open the top cover.
- ❸ Remove the recording paper roll from the unit.
- ❹ Clean the thermal head with a cloth moistened with isopropyl rubbing alcohol, then dry thoroughly.
- ❺ Re-install the recording paper roll, then close the top cover carefully by gently pressing down on both ends.
- ❻ Connect the power cord and telephone line cord.

**Note:**

- To prevent malfunction due to static electricity, only use a lint free cloth and do not touch the thermal head directly with your finger.

## 11 General Information

### Important Safety Instructions

When using this unit, basic safety precautions as below should always be followed to reduce the risk of fire, electric shock, or personal injury.

1. Read and understand all instructions.
2. Follow all warnings and instructions marked on this unit.
3. Unplug this unit from wall outlets before cleaning. Do not use liquid or aerosol cleaners. Use a damp cloth for cleaning.
4. Do not use this unit near water, for example, near a bath tub, wash bowl, kitchen sink, or the like.
5. Install this unit securely on a stable surface. Serious damage may result if the unit falls.
6. Do not cover slots and openings of the unit, for they are provided for ventilation and protection against overheating. Never place the unit near radiators, or in a place where proper ventilation is not provided.
7. Use only the power source as marked on the unit. If you are not sure of the type of power supply to your home, consult your dealer or local power company.
8. Do not place objects on the power cord. Install the unit where no one can step on the cord.
9. Do not overload wall outlets and extension cords as this can result in the risk of fire or electric shock.
10. Never push any objects into this unit through slots as they may result in risk of fire or electric shock. Never spill any liquid on the unit.
11. To reduce the risk of electric shock, do not disassemble this unit, but take it to an authorised Panasonic servicentre when some service or repair work is required. Opening or removing covers may expose you to dangerous voltages or other risks. Incorrect reassembly can cause electric shock when the appliance is subsequently used.
12. Unplug this unit from the wall outlet and refer servicing to qualified service personnel under the following conditions:
  - A. When the power supply cord or plug is damaged or frayed.
  - B. If liquid has been spilled into the unit.
  - C. If the unit has been exposed to rain or water.
  - D. If the unit does not work normally by following the operating instructions. Adjust only controls covered by the operating instructions. Improper adjustment may require extensive work by a qualified technician.
  - E. If the unit has been dropped or damaged.
  - F. If the unit exhibits a distinct change in performance.
13. During thunderstorms, avoid using telephones except cordless types. There may be a remote risk of electric shock from lightning.
14. Do not use this unit to report a gas leak in the vicinity of it.

### SAVE THESE INSTRUCTIONS

#### INSTALLATION:

1. Never install telephone wiring during a lightning storm.
2. Never install telephone jacks in wet locations unless the jack is specifically designed for wet locations.
3. Never touch uninsulated telephone wires or terminals unless the telephone line has been disconnected at the network interface.
4. Use caution when installing or modifying telephone lines.

#### WARNING:

TO PREVENT THE RISK OF FIRE OR ELECTRICAL SHOCK, DO NOT EXPOSE THIS PRODUCT TO RAIN OR ANY TYPE OF MOISTURE.

#### Other Information

- Keep the unit away from electrical noise-generating devices, such as fluorescent lamps and motors.
- The unit should be kept free from dust, moisture, high temperature, and vibration.
- The unit should not be exposed to direct sunlight.
- Do not place heavy objects on top of this unit.
- Do not use benzine, thinner, or any abrasive powder, to clean the cabinet. Wipe it with a soft cloth.
- Do not damage the power cord. Do not touch the plug with wet hands.

## Important Information

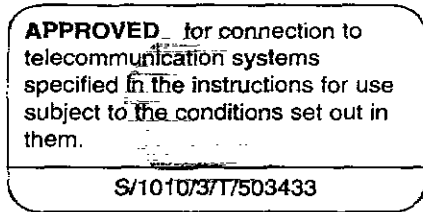

The connection to the telecommunication systems must not be hard wired and must be unplugged before the earth is disconnected.

### Method of connection

This apparatus is connected to the exchange line or PABX/PMBX extension by the new standard British Telecom plug and socket. Arrangements for provision of this type of termination can be made through the nearest British Telecom Sales Office.

This apparatus may be connected to the following types of installation. This apparatus has been approved for use under the following conditions;

- a) For connection to the public switched telephone network (PSTN) and compatible (Private Branch Exchange), which use loop disconnect signalling and DTMF signalling. (Please consult your supplier for an up to date list of compatible PBX's.)
- b) The apparatus can be used on extension sockets connected to a direct exchange line (D.E.L.).
- c) This apparatus is suitable for connection to the telecommunication system directly or via compatible private branch exchange as an extension.  
The supplier of the apparatus should be consulted for an up to date list of PBX's with which the apparatus is compatible.

It cannot be guaranteed that the apparatus will operate under all possible conditions of connection to compatible PBX's.

- This apparatus is suitable for connection to a PBX with or without initial proceed indication.
- This apparatus is suitable for connection to a PBX with or without secondary proceed indication.

Any cases of difficulty should be referred in the first instance to the supplier of the apparatus.

- d) The apparatus must not be connected in the following manner:
  - As an extension to a pay phone
  - As a party line with shared service

This apparatus has been approved for the use of the following facilities:

### Integrated Telephone System

- 1) Simple telephone facility
- 2) Auto-calling
- 3) Last number redial
- 4) PBX time break: Selectable time break/earth recall for PBX
- 5) Loop disconnect signalling
- 6) DTMF signalling
- 7) Mercury dialling compatibility
- 8) Speaker-phone

### Answering and Recording System

- 1) 2-step caller's recording time: LONG/SHORT
- 2) Monitoring a telephone call
- 3) Remote turning on the ANS/FAX mode
- 4) Auto disconnect

### Facsimile System

- 1) MODEM facility

Any other usage will invalidate the approval of the apparatus if as a result, it then ceases to conform to the standards against which approval was granted.

### Ringer Equivalence Number (REN)

This relates to the performance of the apparatus when used in combination with other items of apparatus. It enables the calculation of the maximum number of items of apparatus that may be connected simultaneously to the line by summing the REN values of each item. A BT supplied instrument has a REN value of 1 unless otherwise marked. A maximum REN value of 4 should not be exceeded. The REN value of this apparatus is 1.0.

The approval of this apparatus for connection to the telecommunication systems is invalidated if the apparatus is subject to any modification in any material way not authorised by BABT or it is used with or connected to internal software that has not been formally accepted by BABT.

All apparatus connected to the facsimile machine and thereby connected directly or indirectly to telecommunication systems must be approved apparatus as defined in Section 22 of the British Telecommunication Act 1984.

999 or 112 can be dialled on the apparatus for the purposes of making outgoing calls to the BT Emergency (999 or 112) Service.

**NOTES**

- If you experience any problems with the normal use of your apparatus, you should unplug it from the telephone outlet and connect a known working telephone in its place. If the known working telephone still gives problems, then call British Telecom Engineers; if it operates properly, then the problems are likely to be a fault in your apparatus. In this case, consult your supplier for advice.
- British Telecom will charge you if they attend a service call that is not due to apparatus supplied by them.



KX-F2700E-G  
KX-F2700E-W



73/23/EEC  
89/336/EEC  
92/31/EEC  
93/68/EEC

**Fitting a plug to the mains lead**

This appliance is supplied with a moulded three pin mains plug for your safety and convenience. A 5 amp fuse is fitted in this plug. Should the fuse need to be replaced please ensure that the replacement fuse has a rating of 5 amps and that it is approved by ASTA or BSI to BS1362.

Check for the ASTA mark  or the BSI mark  on the body of the fuse:

If the plug contains a removable fuse cover you must ensure that it is refitted when the fuse is replaced.

If you lose the fuse cover the plug must not be used until a replacement cover is obtained. A replacement fuse cover can be purchased from your local Panasonic dealer.

**IF THE FITTED MOULDED PLUG IS UNSUITABLE FOR THE SOCKET OUTLET IN YOUR HOME THEN THE FUSE SHOULD BE REMOVED AND THE PLUG CUT OFF AND DISPOSED OF SAFELY. THERE IS A DANGER OF SEVERE ELECTRICAL SHOCK IF THE CUT OFF PLUG IS INSERTED INTO ANY 13 AMP SOCKET.**

If a new plug is to be fitted please observe the wiring code as shown below. If in any doubt please consult a qualified electrician.

**WARNING: THIS APPLIANCE MUST BE EARTHED.**

**IMPORTANT:**

The wires in this mains lead are coloured in accordance with the following code:

- Green-and-Yellow: Earth
- Blue: Neutral
- Brown: Live

As the colours of the wire in the mains lead of this appliance may not correspond with the coloured markings identifying the terminals in your plug, proceed as follows.

The wire which is coloured **GREEN-AND-YELLOW** must be connected to the terminal in the plug which is marked with the letter **E** or by the Earth symbol  or coloured **GREEN** or **GREEN-AND-YELLOW**.

The wire which is coloured **BLUE** must be connected to the terminal in the plug which is marked with the letter **N** or coloured **BLACK**.

The wire which is coloured **BROWN** must be connected to the terminal in the plug which is marked with the letter **L** or coloured **RED**.

**How to replace the fuse:** Open the fuse compartment with a screwdriver and replace the fuse and fuse cover.

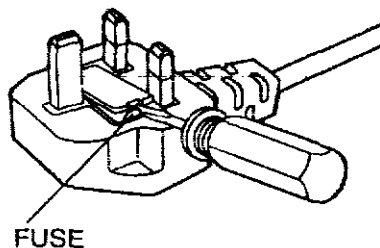

## Specifications

---

1. **Applicable Lines:** Public Switched Telephone Network
2. **Document Size:** Max. 216 mm (8½") in width  
Max. 600 mm (23⅝") in length
3. **Effective Scanning Width:** 208 mm (8⅜")
4. **Printing Paper Size:** 210 mm×30 m roll (8¼"×98' roll) with 25.4 mm (1") core  
210 mm×50 m roll (8¼"×164' roll) with 25.4 mm (1") core
5. **Effective Printing Width:** 208 mm (8⅜")
6. **Transmission Time\*:** Approx. 15 sec/page (Original mode)  
Approx. 30 sec/page (G3 Normal mode)
7. **Scanning Density:** Horizontal 8 pels/mm (203 pels/inch)  
Vertical 3.85 lines/mm (98 lines/inch)—Standard  
7.7 lines/mm (196 lines/inch)—Fine/Halftone  
15.4 lines/mm (392 lines/inch)—Superfine
8. **Scanner Type:** CCD image sensor
9. **Printer Type:** Thermal printing
10. **Data Compression System:** Modified Huffman (MH), Modified READ (MR)
11. **Modem Speed:** 9600/7200/4800/2400 bps; Automatic Fallback
12. **Operating Environment:** 5–35°C (41–95°F), 45%–85% RH
13. **Dimensions (H×W×D):** 122×362×287 mm (4⅓⅙"×14¼"×11⅕⅙")
14. **Mass (Weight):** Approx. 4.1 Kg (9.0 lb.)
15. **Power Consumption:** Transmission: Approx. 15 W / Reception: Approx. 35 W  
Copy: Approx. 40 W / Standby: Approx. 5 W  
Maximum: Approx. 100 W
16. **Power Supply:** 220–240 V AC, 50 Hz

\*Transmission Time: Transmission times apply to text data using the CCITT No. 1 test chart, between the same machine models at maximum modem speed.  
The transmission time does not include call setup, ringing, handshaking and sign off.  
Transmission times vary in actual usage.

Any details given in these instructions are subject to change without notice.



**Index**

<b>A</b>	Advanced feature list	62	MERCURY	59, 60	
	ALL MESSAGES	26	MUTE	22	
	ANS/FAX mode	16, 17	<b>N</b>	NEW MESSAGES	26
	ANS/FAX ring count	17	<b>O</b>	One-touch dialling	30, 32
	Automatic dialling	30, 32		Overseas transmission mode	40
<b>B</b>	Basic feature list	62	<b>P</b>	Pager alert	57
<b>C</b>	Cleaning	73		Paper save reception/copy	42
	Contrast mode	45		PAUSE	47
	COPY	33, 43		Polled	35
<b>D</b>	Date and time	12		Polling	35
	Day/night mode	41		Printer test list	62
	Delayed transmission	36	<b>R</b>	RECALL	47
	DELETE	14		Recall mode	44
	Dial keypad	13		RECEIVE MODE	16
	Dialling mode	21		REDIAL/PAUSE	22
	Direct call station keys	14, 30, 32		Remote-ANS ID	53
	DIRECTORY	32, 34		Remote fax activation code	37
<b>E</b>	Electronic telephone directory	34		REPEAT	27
	ERASE	27		RESOLUTION	24
	Error messages	68		Ringer volume	22
	Extension copy	43	<b>S</b>	SECRET	30
<b>F</b>	FAX mode	16, 20		Set default	45
	FAX ring count	20		Silent fax recognition ring	19
	Feeder pressure	72		SKIP	27
<b>G</b>	GREETING REC	10, 48		SPACE	14
	GREETING SELECT	10, 48		Speaker volume	22
<b>H</b>	HELP	4		Speed dialling	30, 32
<b>I</b>	INSERT	14		SP-PHONE/VOICE STDBY	21, 46
<b>J</b>	Journal auto print	65		START/SET	11, 25
	Journal report	62		STOP	10, 25
	Junk mail prohibitor	38	<b>T</b>	TEL mode	16
	Junk mail prohibitor ID	38, 39		TEL/FAX mode	16, 18
<b>L</b>	Logo position	40		TEL/FAX delayed ring	19
	LOWER	30, 32		Telephone number list	62
<b>M</b>	MAIL BOX	50		TONE	47
	MEMO/2WAY REC	28		TONE/PULSE	21
	MENU	11, 30, 35, 62		Transmission report	15
			<b>V</b>	VOLUME	22
			<b>Y</b>	Your logo	12
				Your telephone number	15

## FAX CORRESPONDENCE

TO: \_\_\_\_\_ DATE: \_\_\_\_\_

FROM: \_\_\_\_\_ OUR TEL. NO.: \_\_\_\_\_

We would like to take this opportunity to introduce you to our Panasonic telephone answering device with facsimile. Our unit will work as a facsimile, an answering device and a standard telephone, so you can send both documents and voice-messages on the same call.

### Leaving a voice-message and transmitting a document

1. Dial our phone number.
  - Our unit will play the greeting message.
2. Leave your message after the long beep.
3. Press your “\*” (asterisk) button **twice** to activate fax reception.
  - A fax tone will sound.
4. Start transmission to send a fax.

### Transmitting a document only

1. Dial our phone number.
  - Our unit will play the greeting message.
2. Press your “\*” button **twice** while the greeting message is being played.
  - A fax tone will sound.
3. Start transmission to send a fax.

### Leaving a voice-message and transmitting a document from a rotary (pulse) phone

1. Dial our phone number.
  - Our unit will play the greeting message.
2. Start transmission to send a fax.
3. Make a call reservation (e.g. ...lift the handset) during transmission of your document.
4. Leave your message after the long beep following the greeting message.

### Transmitting a document from a rotary (pulse) phone

1. Dial our phone number.
  - Our unit will play the greeting message.
2. Start transmission to send a fax while the greeting message is being played.

**Note:**

- If you wish to receive voice messages and documents automatically, set the unit in the ANS/FAX mode.

## Speed dialler list

Station No.	Name/Phone No.	Station No.	Name/Phone No.
00		11	
01		12	
02		13	
03		14	
04		15	
05		16	
06		17	
07		18	
08		19	
09		20	
10		21	



# Answering device remote control card

## Answering Device Remote Operation

1. Call your unit.
2. Press the remote ANS ID    during the greeting message.
3. Press remote command key (refer to right) within 4 seconds.  
or  
Wait for 4 seconds. All the recorded messages will be played back.

- To skip the greeting message, press **0**.
- To erase a specific message, press **\*4** when a message to be erased is being played back.
- To erase all the recorded messages, press **\*5**.

Key	Remote Command
<b>1</b>	Repeating a message
<b>2</b>	Skipping a message
<b>4</b>	New message playback
<b>5</b>	All message playback
<b>7</b>	Re-recording greeting message
<b>8</b>	Continuing operation
<b>9</b>	Stopping re-recording of greeting message
<b>*4</b>	Erasing a specific message
<b>*5</b>	Erasing all messages
<b>6 1</b>	Pager alert ON
<b>6 2</b>	Pager alert OFF

## Answering Device Remote Operation

1. Call your unit.
2. Press the remote ANS ID    during the greeting message.
3. Press remote command key (refer to right) within 4 seconds.  
or  
Wait for 4 seconds. All the recorded messages will be played back.

- To skip the greeting message, press **0**.
- To erase a specific message, press **\*4** when a message to be erased is being played back.
- To erase all the recorded messages, press **\*5**.

Key	Remote Command
<b>1</b>	Repeating a message
<b>2</b>	Skipping a message
<b>4</b>	New message playback
<b>5</b>	All message playback
<b>7</b>	Re-recording greeting message
<b>8</b>	Continuing operation
<b>9</b>	Stopping re-recording of greeting message
<b>*4</b>	Erasing a specific message
<b>*5</b>	Erasing all messages
<b>6 1</b>	Pager alert ON
<b>6 2</b>	Pager alert OFF

## Answering Device Remote Operation

1. Call your unit.
2. Press the remote ANS ID    during the greeting message.
3. Press remote command key (refer to right) within 4 seconds.  
or  
Wait for 4 seconds. All the recorded messages will be played back.

- To skip the greeting message, press **0**.
- To erase a specific message, press **\*4** when a message to be erased is being played back.
- To erase all the recorded messages, press **\*5**.

Key	Remote Command
<b>1</b>	Repeating a message
<b>2</b>	Skipping a message
<b>4</b>	New message playback
<b>5</b>	All message playback
<b>7</b>	Re-recording greeting message
<b>8</b>	Continuing operation
<b>9</b>	Stopping re-recording of greeting message
<b>*4</b>	Erasing a specific message
<b>*5</b>	Erasing all messages
<b>6 1</b>	Pager alert ON
<b>6 2</b>	Pager alert OFF

### Mailbox Remote Operation

### Notice of Remote Operation

#### ■ Recording a message into the mailbox:

1. Call your unit.
2. Press **x** and the mailbox no. (**1**, **2** or **3**).
3. Leave a message.

- The remote operation is available only from a touch tone phone when the unit is in the *ANS/FAX* mode.

#### ■ Retrieving messages from the mailbox:

1. Call your unit.
2. Press **x** and the mailbox no. (**1**, **2** or **3**).
3. Press the mailbox passcode   .
4. Press the remote command key (refer to the reverse side).

- When the unit is in the *TEL* mode, call your unit and wait for 20 rings. The unit will switch to *ANS/FAX* mode.

- When you press any key, press firmly.

- To send the document, press **x x**. When a fax tone is heard, start transmission.

Fold here

### Mailbox Remote Operation

### Notice of Remote Operation

#### ■ Recording a message into the mailbox:

1. Call your unit.
2. Press **x** and the mailbox no. (**1**, **2** or **3**).
3. Leave a message.

- The remote operation is available only from a touch tone phone when the unit is in the *ANS/FAX* mode.

#### ■ Retrieving messages from the mailbox:

1. Call your unit.
2. Press **x** and the mailbox no. (**1**, **2** or **3**).
3. Press the mailbox passcode   .
4. Press the remote command key (refer to the reverse side).

- When the unit is in the *TEL* mode, call your unit and wait for 20 rings. The unit will switch to *ANS/FAX* mode.

- When you press any key, press firmly.

- To send the document, press **x x**. When a fax tone is heard, start transmission.

Fold here

### Mailbox Remote Operation

### Notice of Remote Operation

#### ■ Recording a message into the mailbox:

1. Call your unit.
2. Press **x** and the mailbox no. (**1**, **2** or **3**).
3. Leave a message.

- The remote operation is available only from a touch tone phone when the unit is in the *ANS/FAX* mode.

#### ■ Retrieving messages from the mailbox:

1. Call your unit.
2. Press **x** and the mailbox no. (**1**, **2** or **3**).
3. Press the mailbox passcode   .
4. Press the remote command key (refer to the reverse side).

- When the unit is in the *TEL* mode, call your unit and wait for 20 rings. The unit will switch to *ANS/FAX* mode.

- When you press any key, press firmly.

- To send the document, press **x x**. When a fax tone is heard, start transmission.

Fold here

STAMP  
REQUIRED

# Panasonic Business Systems U.K.

WILLOUGHBY RD.  
BRACKNELL, BERKSHIRE  
RG12 4FP



## POST CARD

STAMP  
REQUIRED

**The Telephone Manager**  
**British Telecom Sales Department**

..... Area  
.....  
.....

116

**Panasonic Business Systems U.K.**  
Panasonic House, Willoughby Road, Bracknell,  
Berkshire RG12 4FP

Printed in the United Kingdom

**PQQX11353ZB-UK** F0595AJ1085