

Panasonic®

Operating Instructions for advanced features

Digital Camera

Model No. **DMC-TZ30**
DMC-TZ31
DMC-TZ27

LUMIX

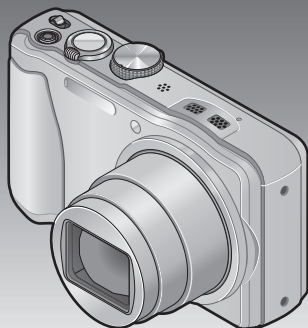

Before use, please read these instructions completely.



VQT4C04-1
M0212KZ1042

Contents

Before use		Basics	
Before use	6	Sequence of operations	25
About GPS DMC-TZ30 DMC-TZ31	8	Taking pictures with your own settings	
Standard Accessories	9	[Program AE] Mode	27
Names and Functions of Main Parts ...	10	How to adjust focus	28
Cursor button	11	Touching the screen and recording	
Touch operations	12	(Touch Shutter function)	29
Preparations		Touching the screen and adjusting	
Charging battery	13	the focus and exposure	
Inserting the battery	14	(Touch AF/AE function)	30
Charging the battery	15	Taking pictures with automatic settings	
Remaining battery	16	[Intelligent Auto] Mode	31
Guidelines for number of recordable		About flash	31
pictures and operating time	17	Automatic Scene Detection	32
Inserting and removing the card		About the Happy colour setting	32
(optional)	19	[Motion Deblur]	33
Picture save destination		[iHandheld Nite Shot]	33
(cards and built-in memory)	20	[iHDR] (intelligent High Dynamic Range)	34
Displaying the picture recording capacity	21	AF Tracking	35
Recording capacity guidelines		[Intelligent Auto] Mode restrictions	36
(pictures/recording time)	22	Taking motion pictures	37
Setting the clock	23	Recording still pictures while a motion	
To change time setting	24	picture is being recorded	41
		Viewing your pictures	
		[Normal Play]	42
		Zooming in and viewing	
		"Playback Zoom"	43
		Viewing a list of pictures	
		"Multi Playback"	43
		Viewing pictures by their recording date	
		"Calendar Playback"	44
		Viewing motion pictures	45
		Capturing still pictures from motion	
		pictures	47
		[Video Divide]	48
		Deleting pictures	49
		To delete multiple (up to 100/	
		To delete all pictures	50
		Setting the menu	51
		Menu type	52
		Using Quick menu	53

Using the [Setup] menu	54
[Clock Set]	54
[Auto Clock Set]	
DMC-TZ30 DMC-TZ31	54
[World Time]	54
[Travel Date]	54
[Beep]	54
[Volume]	55
[Cust. Set Mem.]	55
[LCD Display]	55
[LCD Mode]	55
[Guide Line]	56
[Histogram]	56
[Video Rec Area]	56
[Zoom Resume]	56
[Economy]	57
[Auto Review]	57
[No. Reset]	58
[Reset]	58
[USB Mode]	58
[Output]	59
[VIERA Link]	59
[3D Playback]	59
[Rotate Disp.]	60
[Version Disp.]	60
[Format]	60
[Language]	61
[Demo Mode]	61

Application (Record)

Changing recording information display	62
Using Zoom	63
Using the zoom by performing touch operations	64
Zoom types and use	65
Taking pictures with flash	66
Taking close-up pictures	68
Focus range	68
[Macro Zoom]	69
Taking pictures with self-timer	70
Taking pictures with Exposure Compensation	71
Recording while exposure is changed automatically ([Auto Bracket])	72
Determine aperture and shutter speed and record	73
[Aperture-Priority] Mode	73
[Shutter-Priority] Mode	73
[Manual Exposure] Mode	74
Taking Pictures with different picture effects	
[Creative Control] mode	75
Taking pictures according to the scene [Scene Mode]	77
[Portrait]	78
[Soft Skin]	78
[Scenery]	78
[Panorama Shot]	78
[Sports]	80
[Night Portrait]	80
[Night Scenery]	80
[Handheld Night Shot]	80
[HDR]	81
[Food]	81
[Baby]	81
[Pet]	81
[Sunset]	82
[High Sens.]	82
[Glass Through]	82
[Underwater]	82
[High Speed Video]	83
Taking 3D pictures	
[3D Photo Mode]	84

Register your own settings and record	
[Custom] Mode	85
[Cust.Set Mem.]	85
[Custom]	86
Burst function	87
Recording with the Face Recognition function	
[Face Recog.]	89
Registering face pictures	90
Editing or deleting information about registered persons	91
Useful features for travel	92
[Travel Date]	92
[World Time]	93
Entering Text	94
Using the [Rec] menu	95
[Aspect Ratio]	95
[Picture Size]	95
[Quality]	96
[Sensitivity]	96
[White Balance]	97
[AF Mode]	99
[Quick AF]	100
[Face Recog.]	101
[Metering Mode]	101
[i.Exposure]	101
[Min. Shtr Speed]	102
[i.Resolution]	102
[Digital Zoom]	102
[Burst]	103
[Color Mode]	103
[AF Assist Lamp]	103
[Red-Eye Removal]	104
[Stabilizer]	104
[Date Stamp]	105
[Clock Set]	105
Using the [Motion Picture] menu	106
[Rec Mode]	106
[Rec Quality]	107
[Continuous AF]	108
[Wind Cut]	108

Application (View)

Playing back still pictures recorded using the burst function	109
Different playback methods	
[Playback Mode]	111
[2D/3D Settings]	111
[Slide Show]	112
[Filtering Play]	114
[Calendar]	114
Retouching pictures	115
[Auto Retouch]	115
[Creative Retouch]	116
Using the [Playback] menu	117
[Upload Set]	117
[Title Edit]	118
[Edit GPS Data]	
DMC-TZ30 DMC-TZ31	118
[Text Stamp]	119
[Resize]	121
[Cropping]	122
[Favorite]	123
[Print Set]	124
[Protect]	125
[Face Rec Edit]	126
[Copy]	127

GPS and map functions

DMC-TZ30 DMC-TZ31

Using the GPS function to record the location of a picture 128

- Using the GPS function to execute positioning 129
- Executing the positioning function right away to update the current location 132
- Changing place name information to be displayed 134
- Disabling the positioning function when the camera is turned off 135

Changing the place name information to be recorded 136

Changing the recorded GPS information 137

- [Edit Location] 137
- [Edit Place Name] 138

Adjusting the time using GPS 140

Reducing the time required for positioning 141

- About the "GPS Assist Tool" 141
- Using the "GPS Assist Tool" 142
- Updating the GPS assist data 144
- Checking the expiration date of the GPS assist data 145

Using the map function 146

- Confirming the place where you took a picture using a map 146
- Displaying your current location on a map 147
- Displaying only pictures taken in the same area 148
- Displaying a map by selecting a country or region 149

Using the map data on the DVD (supplied) 150

- Installing "LUMIX Map Tool" 150
- Copying the map data to a memory card... 151

Registering my landmark 153

- Registering my landmark from a map 153
- Registering the recording location as my landmark 154
- Selecting My landmark and displaying it on a map 155
- Editing or deleting my registered landmark... 155

Connecting with other devices

Viewing on TV screen 156

- VIERA Link (HDMI) (HDAVI Control™) 158
- Viewing 3D still pictures 160

Keep the recorded still pictures and motion pictures 162

- Copy by inserting the SD card into the recorder 162
- Dubbing playback pictures via AV cables (optional) 162
- Use "PHOTOfunSTUDIO" to copy to your computer 163

Using with your PC 164

- Copying still pictures and motion pictures recorded in [MP4] and [High Speed Video] Scene Mode (except AVCHD motion pictures) 165
- Uploading pictures to image-sharing websites 167

Printing 168

- Printing multiple pictures 170
- Print with date and text 170
- Making print settings on the camera 171

Others

List of LCD monitor displays 172

Message displays 176

Q&A Troubleshooting 178

Usage cautions and notes 186

- Licence Agreement for Place Name and Map Data

DMC-TZ30 DMC-TZ31 190

Before use

■ Camera handling

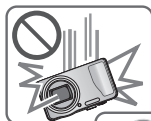

Keep the camera away from excessive vibration, force, or pressure.

- Avoid using the camera under the following conditions, which may damage the lens, LCD monitor, or camera body. This may also cause the camera to malfunction or prevent recording.
 - Dropping or hitting the camera against a hard surface
 - Sitting down with the camera in your pants pocket or forcing it into a full bag
 - Adding accessories to the camera strap
 - Pushing with excessive force on the lens or LCD monitor

The camera is not dust resistant, splash resistant, or waterproof.

Avoid using the camera in places with excessive dust or sand, or where water can come into contact with the camera.

- Avoid using the camera under the following conditions, which present a risk that sand, water, or foreign material may enter the camera through the lens or openings around buttons. Be especially careful because these conditions may damage the camera, and such damage may not be repairable.
 - In extremely dusty or sandy places
 - In the rain or by the shore, where the camera may be exposed to water

■ Condensation (When the lens or the LCD monitor is fogged up)

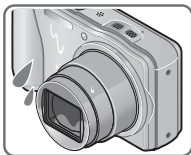

- Condensation may occur when the camera is exposed to sudden changes of temperature or humidity. Avoid these conditions, which may make the lens or LCD monitor dirty, cause mould, or damage the camera.
- If condensation does occur, turn off the camera and wait about two hours before using it. Once the camera adjusts to the surrounding temperature, fogginess will clear naturally.

■ Always take a test shot first

Before important events when you will use the camera (at weddings, for example), always take a test shot to make sure that pictures and sound record correctly.

■ No compensation for missed shots

We cannot compensate for missed shots if technical problems with the camera or card prevent recording.

■ Carefully observe copyright laws

Unauthorised use of recordings which contain works with copyright for purposes other than personal use is prohibited under copyright law. Recording of certain material may be restricted even for the purpose of personal use.

■ Also refer to “Usage cautions and notes” (→186)

● Please note that the actual controls and components, menu items, and other information for your digital camera may differ from those in the illustrations and screens provided in this manual. When operation or other information is more or less the same between models, DMC-TZ30/DMC-TZ31 is used as examples for the instructions provided in this manual.

● The operations, procedures, or functions that differ among models are indicated separately, together with the relevant model number.

(Example) **DMC-TZ30** **DMC-TZ31**
DMC-TZ27

● Recording mode icons

Recording mode: **IA** **P** **A** **S** **M** C1 C2 **SD** SCN

Available recording modes

Unavailable recording modes

About GPS **DMC-TZ30** **DMC-TZ31**

■ About the camera's location name information

Before using the camera, be sure to read "Licence Agreement for Place Name and Map Data". (→190)

■ When [GPS Setting] is [ON], the GPS function works even if the camera is turned OFF.

- Electromagnetic waves from the camera can affect instruments and meters. In airplane cabins (during takeoff and landing) or in other restricted areas, set [GPS Setting] to [OFF] or set [Airplane Mode] to [ON], and then turn off the camera. (→129, 135)
- When [GPS Setting] is [ON] and [Airplane Mode] is [OFF], power will drain from the battery even if the camera is turned OFF.

■ Recording location information

- The names of recording locations and landmarks (such as buildings) are current as of December 2011. These will not be updated.
- Depending on the country or area, limited location name and landmark information may be available.

■ Positioning

- Positioning will take time in environments where it is difficult to receive the signals from the GPS satellites. (→128)
- **Even if GPS reception is good, it will take approx. 2 to 3 minutes to successfully execute positioning under the following conditions: when positioning is executed for the first time, or when positioning is executed after the camera is turned off with the [GPS Setting] set to [OFF] or [Airplane Mode] set to [ON], and then turned on again.**
Positioning can be executed faster using GPS assist data. (→141)
- Because the positions of the GPS satellites are constantly changing, depending on the recording location and conditions, it may not be possible to position such satellites accurately, or positioning discrepancy may occur.

■ When using in another country

- The GPS function may not work in China or in the border regions of countries neighboring China. (Current as of December 2011)
- Some countries or regions may regulate the use of GPS or related technology. Because this camera has a GPS function, before taking it into another country, check with the embassy or your travel agency whether there are any restrictions on bringing cameras with a GPS function.

Standard Accessories

Check that all the accessories are supplied before using the camera.

- The accessories and their shape will differ depending on the country or area where the camera was purchased.
For details on the accessories, refer to Basic Operating Instructions.
- Battery Pack is indicated as battery pack or battery in the text.
- SD Memory Card, SDHC Memory Card and SDXC Memory Card are indicated as card in the text.
- Please dispose of all packaging appropriately.
- Keep small parts in a safe place out of the reach of children.

■ Optional accessories

- **Cards are optional.** You can record or play back pictures on the built-in memory when you are not using a card. (→20)
- Consult the dealer or your nearest Service Centre if you lose the supplied accessories.
(You can purchase the accessories separately.)

Names and Functions of Main Parts

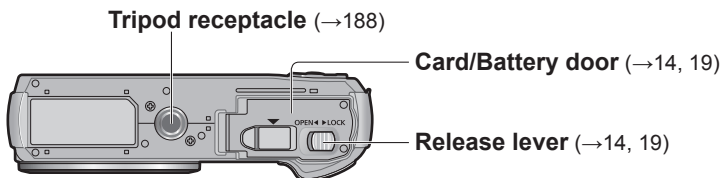
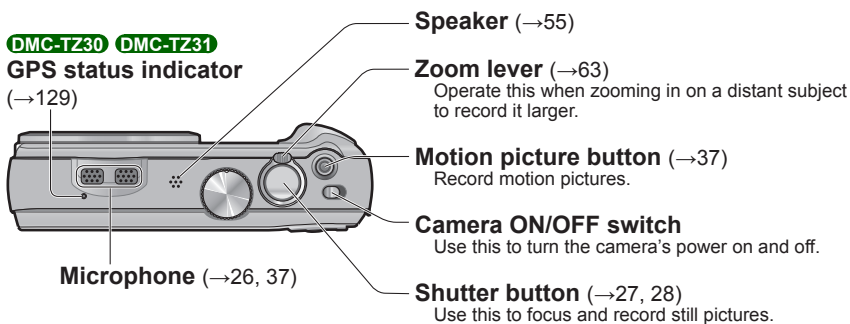
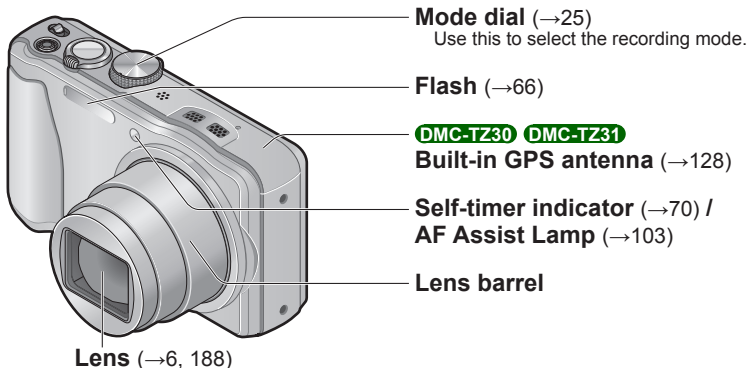

● The illustrations and screens in this manual may differ from the actual product.

LCD monitor
(→55, 62, 172)

REC/PLAY switch (→25)

Use this to select the recording mode or playback mode.

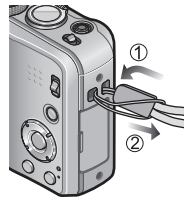

We recommend using the supplied hand strap to avoid dropping the camera.

[EXPOSURE] button (→73)

In the recording mode:
Operate this when setting the shutter speed or aperture value. (Only in the **ASM** mode)

DMC-TZ30 DMC-TZ31 [MAP] button (→146)

In the playback mode: Map is displayed.

[DISP.] button

(→62)
Use this to change display.

Charging lamp
(→16)

[Q.MENU] / [] / [] button

In the recording mode: Quick menu is displayed. (→53)
In the playback mode: Pictures are deleted. (→49)
During menu operations: The previous screen is restored.

[HDMI] socket
(→156, 158)



[AV OUT/DIGITAL] socket

(→15, 156, 165, 168)
This socket is also used when charging the battery.

Cursor button

[MENU/SET]

• Use this to display the menus, enter the settings, etc. (→51)

Left cursor button (◀)

• Self-timer (→70)

Down cursor button (▼)

• Macro Mode etc. (→68)



Up cursor button (▲)

• Exposure Compensation, Auto Bracket etc. (→71, 72)

Right cursor button (▶)

• Flash (→66)

● In this manual, the button that is used is indicated by ▲▼◀▶.

● The illustrations and screens in this manual may differ from the actual product.

Touch operations

This camera's touch screen senses pressure that is applied to the screen.

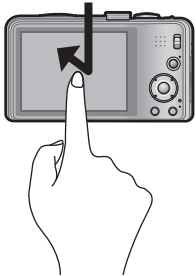
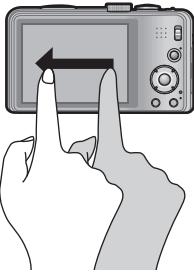
Touch	Drag
<p>To "touch" is to press the touch screen and then pull the finger back again.</p>	<p>To "drag" is to touch and slide your finger across the touch screen surface.</p>
	
<p>Touching is used to select icons or pictures, among other actions.</p> <ul style="list-style-type: none"> • Touch an icon near its centre. If multiple icons are touched simultaneously, the camera may not operate normally. 	<p>Dragging (sliding your finger across the screen) is used to scroll the pictures or change the range of the pictures displayed.</p>

- If the type of sheet made to protect LCD screens that are available in the market is to be used, observe the precautions that are contained with the sheet. (Some types of protective sheets may impair the screen's appearance and ease of operation.)
- If the camera is used with a protective sheet available on the market attached to its screen or if the screen is not very responsive, touch the screen with a little more pressure.
- If your hand is pressed against the touch screen when holding the camera, the touch screen will not work properly.
- Do not press on the LCD monitor with hard pointed tips, such as ballpoint pens.
- Do not press the touch screen with your fingernails.
- Clean the LCD monitor with a soft, dry cloth if there are fingerprints or other kinds of dirt on it.
- For details of the icons that appear on the touch screen, refer to "List of LCD monitor displays" (→172 - 175).

Charging battery

- Always use the dedicated AC adaptor (supplied), USB connection cable (supplied), and battery for this camera.

Always charge before first use! (battery shipped uncharged)

- Charge the battery while it is in the camera.

Camera status	Charge
Turn off (also in [Sleep Mode] (→57))	Yes
Turn on	No*

* During playback only, the camera operates using power supplied from the electrical outlet via the USB connection cable (supplied). (The battery is not charged.)

- When the battery does not have sufficient remaining power, charging may be done regardless of the camera ON/OFF switch setting.
- If the battery is not inserted, neither charging nor power supplying is made.

■ About batteries that you can use with this unit

It has been found that counterfeit battery packs which look very similar to the genuine products are made available to purchase in some markets. Some of these battery packs are not adequately protected with internal protection to meet the requirements of appropriate safety standards. There is a possibility that these battery packs may lead to fire or explosion. Please be advised that we are not liable for any accident or failure occurring as a result of use of a counterfeit battery pack. To ensure that safe products are used we recommend that a genuine Panasonic battery pack is used.

Inserting the battery

To charge the battery, insert it into the camera.

- Set the camera ON/OFF switch to OFF

- 1 Slide to the release lever to the [OPEN] position and open the card/battery door**

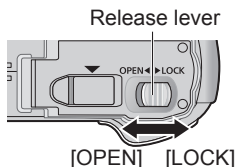

- 2 Insert the battery all the way**

- Make sure to insert the battery in the correct orientation.
- Insert all the way firmly until a locking sound is heard, and check that the lever is hooked over the battery.

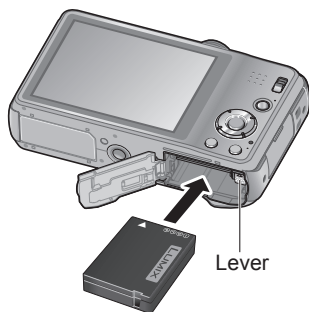

- 3 Close the card/battery door**

- Slide the release lever to the [LOCK] position.

■ To remove battery

Move the lever in the card/battery compartment in the direction of the arrow.

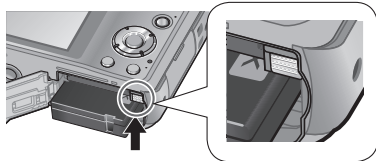

- Always use genuine Panasonic batteries.
- If you use other batteries, we cannot guarantee the quality of this product.
- **Remove battery from camera after use.**
 - Keep the battery in a plastic bag, making sure that it is kept away from metallic objects (such as clips) when carrying or storing the battery.
- To remove the battery, turn the camera off and wait until the LUMIX indicator on the LCD monitor goes off. (Failure to wait may cause the camera to malfunction and may damage the card or recorded data.)

Charging the battery

We recommend charging in a location where the ambient temperature is between 10 °C and 30 °C (50 °F to 86 °F) (same for the battery temperature).

Set the camera ON/OFF switch to OFF

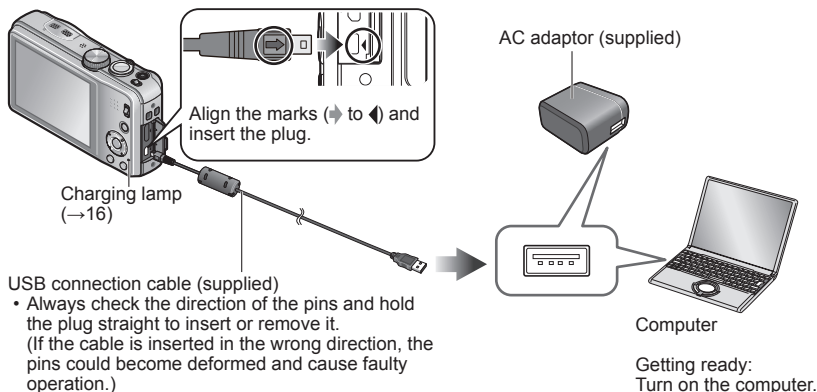

■ Charging the battery by connecting the camera to the electrical outlet

Connect the AC adaptor (supplied) and the camera using the USB connection cable (supplied), and plug the AC adaptor (supplied) into the electrical outlet.

- Be sure to only use the AC adaptor (supplied) indoors.

■ Charging the battery through the computer

Connect a computer to the camera using the USB connection cable (supplied).

- It may not be possible to charge the battery from some computers depending on the computer specifications.
- If the computer enters hibernation mode during charging, charging may be stopped.
- If a notebook computer that is not connected to an electrical outlet is connected to the camera, the battery of the notebook computer will be depleted. Do not leave the camera and notebook connected for a long period of time.
- Always connect the USB connection cable to the USB connector on your computer. Do not connect the USB connection cable to the USB connector of the monitor, keyboard, printer, or USB hub.

■ Charging lamp indications

On: Charging in progress

Off: Charging stops (After charging stops, disconnect the camera from the electrical outlet or your computer.)

■ Notes on charging time

When using the AC adaptor (supplied)

Charging time	Approx. 260 min
----------------------	-----------------

- The charging time indicated above is the time required for charging in case when the battery is completely used up. The time required for charging differs depending on conditions of battery usage. Charging takes longer in cases when temperatures are either high or low and when the battery has not been used for a long period of time.
- The time required for charging through the computer varies depending on the specifications of the computer.
- Do not use any other USB connection cables except the supplied one. Doing so may cause malfunction of the camera.
- Do not use a USB extension cable.
- Do not use any other AC adaptors except the supplied one.
- The AC adaptor (supplied) and the USB connection cable (supplied) are dedicated accessories of this camera. Do not use them for other devices.
- If there is any trouble related to the electrical outlet (i.e. power failure), charging may not complete properly. Disconnect the USB connection cable (supplied) and reconnect it to the camera.
- If the charging lamp does not light or flash even when the camera is properly connected to the AC adaptor (supplied) or your computer, charging has been put in pause status because the temperature is not in the appropriate range for charging. This is not a malfunction. Reconnect the USB connection cable (supplied) and retry charging in a place where ambient temperature is 10 °C to 30 °C (50 °F to 86 °F) (temperature conditions also apply to the battery itself).

Remaining battery



Remaining battery



If the battery mark flashes red, recharge or replace battery.

Guidelines for number of recordable pictures and operating time

The number of recordable pictures or available operating time may vary according to surrounding environment and usage conditions. Figures may be reduced if flash, zoom, or other functions are used frequently, or in colder climates.

■ Recording still pictures

Number of recordable pictures	Approx. 260 pictures	By CIPA standard
Recording time	Approx. 130 min	

● Recording conditions by CIPA standard

- CIPA is an abbreviation of [Camera & Imaging Products Association].
- [Program AE] Mode
- [GPS Setting] is set to [OFF] **DMC-TZ30 DMC-TZ31**
- Temperature: 23 °C (73.4 °F)/Humidity: 50%RH when LCD monitor is on.
- Using a Panasonic SD Memory Card (32 MB).
- Using the supplied battery.
- Starting recording 30 seconds after the camera is turned on. (When the Optical Image Stabiliser function is set to [ON].)
- Recording once every 30 seconds with full flash every second recording.
- Rotating the zoom lever from Tele to Wide or vice versa in every recording.
- Turning the camera off every 10 recordings and leaving it until the temperature of the battery decreases.

Number reduced if intervals are longer (e.g. to approx. one quarter for 2-minute intervals under the above conditions).

■ Recording motion pictures

[Rec Mode]	[AVCHD]		[MP4]
[Rec Quality]	[GPH]*1 [PSH]	[GFS]*1 [FSH]	[FHD]
Available recording time*2	Approx. 55 min	Approx. 65 min	Approx. 70 min
Actual available recording time*3	Approx. 30 min	Approx. 35 min	Approx. 40 min

*1 **DMC-TZ30** **DMC-TZ31**

● Recording conditions

- Temperature 23 °C (73.4 °F), humidity 50%RH
- [GPS Setting] is set to [OFF] **DMC-TZ30** **DMC-TZ31**

*2 Motion pictures can be recorded continuously for up to 29 minutes 59 seconds. Also, motion picture recorded continuously in [MP4] is up to 4 GB. (In this case, you can continuously record a motion picture in [FHD] for up to approx. 27 minutes 12 seconds.) Remaining time for continuous recording is displayed on the screen.

*3 The time you can actually record when repeatedly turning the power on and off, starting and stopping recording and using zoom.

■ Viewing pictures

Playback time	Approx. 160 min
---------------	-----------------

Inserting and removing the card (optional)

- Set the camera ON/OFF switch to OFF

- 1 Slide to the release lever to the [OPEN] position and open the card/battery door**

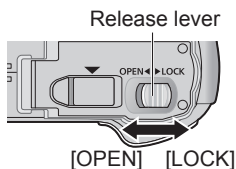

- 2 Insert the card all the way**

- Push in until it clicks.

- 3 Close the card/battery door**

- Slide the release lever to the [LOCK] position.

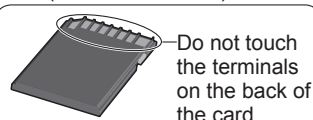
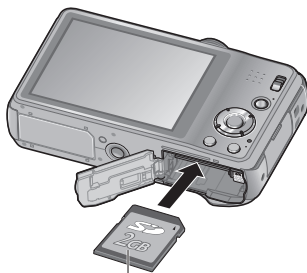

■ To remove card

Press the centre of the card

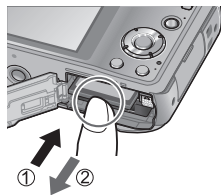

- Keep the Memory Card out of reach of children to prevent swallowing.
- To remove the card, turn the camera off and wait until the LUMIX indicator on the LCD monitor goes off. (Failure to wait may cause the camera to malfunction and may damage the card or recorded data.)

Picture save destination (cards and built-in memory)

Pictures will be saved to a card if one is inserted, or to the built-in memory  if not.

■ Built-in memory

(approx. 12 MB) **DMC-TZ30** **DMC-TZ31**

(approx. 70 MB) **DMC-TZ27**

- You can store only still pictures. **DMC-TZ30** **DMC-TZ31**
- Pictures may be copied between cards and the built-in memory. (→127)
- The access time for the built-in memory may be longer than the access time for a card.

■ Compatible memory cards (optional)

The following SD standard-based cards (Panasonic brand recommended)

Type of Card	Capacity	Notes
SD Memory Cards	8 MB – 2 GB	<ul style="list-style-type: none">• Can be used with devices compatible with the respective formats.• Before using SDXC Memory Cards, check that your computer and other devices support this type of card. http://panasonic.net/avc/sdcard/information/SDXC.html• Using a card of SD speed "Class 4"* or above is recommended for recording motion pictures.• Only the cards listed on the left with the given capacities are supported.
SDHC Memory Cards	4 GB – 32 GB	
SDXC Memory Cards	48 GB, 64 GB	

* SD speed class refers to a specification for sustained write speeds. Confirm the SD speed by checking the card label or other card related materials.

(Example)

CLASS 



- Please reformat the card with this camera if it has already been formatted with a computer or another device. (→60)
- If the write-protect switch is set to "LOCK", the card cannot be used to record or delete pictures, and it cannot be formatted.
- It is recommended that you copy important pictures to your computer (as electromagnetic waves, static electricity, or faults may cause data to be damaged).
- Latest information:
<http://panasonic.jp/support/global/cs/dsc/> (This Site is English only.)



Switch

Displaying the picture recording capacity



Estimated remaining pictures or recording time capacity
(press [DISP.] button to switch display)

Displayed when no card is inserted
(pictures will be saved to built-in memory)

While the camera is accessing the card or built-in memory (for an operation such as picture writing, reading, deletion, or formatting), do not turn off the camera or remove the battery, card, or AC adaptor (supplied). Do not subject the camera to vibrations, impact, or static electricity.

The card or the data on the card may be damaged, and this unit may no longer operate normally.

If operation fails due to vibration, impact or static electricity, perform the operation again.

Recording capacity guidelines (pictures/recording time)

The number of pictures you can take and the recording time vary in proportion to card capacity (and depending on recording conditions and type of card).

■ Recording picture capacity (still pictures)

[Picture Size]	Built-in memory		2 GB	32 GB	64 GB
	DMC-TZ30 DMC-TZ31	DMC-TZ27			
14M	1	12	330	5490	10980
5M	3	25	650	10620	21490
0.3M	67	398	10050	162960	247150

• When the number of recordable pictures exceeds 99,999, “+99999” is displayed.

■ Recording time capacity (motion pictures)

([h], [m] and [s] indicate “hour”, “minute” and “second”.)

When the [AVCHD] recording mode is used

[Rec Quality]	Built-in memory	2 GB	32 GB	64 GB
[GPH]* [PSH]	–	8m00s	2h31m00s	5h07m00s
[FSH] [SH] [GFS]* [GS]*	–	14m00s	4h10m00s	8h26m00s

* **DMC-TZ30** **DMC-TZ31**

When the [MP4] recording mode is used

[Rec Quality]	Built-in memory	2 GB	32 GB	64 GB
[FHD]	–	12m07s	3h23m02s	6h51m01s
[HD]	–	23m08s	6h27m38s	13h04m41s
[VGA]	– DMC-TZ30 – DMC-TZ31 1m47s DMC-TZ27	50m56s	14h13m08s	28h46m57s

• Motion pictures can be recorded continuously for up to 29 minutes 59 seconds. Also, motion picture recorded continuously in [MP4] is up to 4 GB. (In this case, you can continuously record a motion picture in [FHD] for up to approx. 27 minutes 12 seconds.) Remaining time for continuous recording is displayed on the screen.

- If you make Web upload settings, the recording picture capacity and the recording time capacity of the card may be reduced. (→117)
- When map data is copied to a memory card, the number of recordable pictures and recording time will decrease. **DMC-TZ30** **DMC-TZ31** (→150)

Setting the clock

The clock is not set when the camera is shipped.
Set REC/PLAY switch to  before turning on the power.
Disconnect the unit from the AC adaptor (supplied).

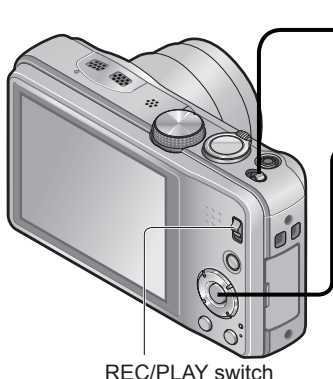

- 1 Turn on the power**
 The power is turned on.
If the language select screen is not displayed, proceed to step **4**.
- 2 Press [MENU/SET] while the message is displayed**
- 3 Press ▲ ▼ to select the language, and press [MENU/SET]**
- 4 The [Please set the clock] message appears. Press [MENU/SET]**
- 5 Press ◀ ▶ to select the items (year, month, day, hour, minute, display order or time display format), and press ▲ ▼ to set**



• To cancel → Press [◀ / ▶] button.

- 6 Press [MENU/SET] to set**
- 7 Press [MENU/SET]**
 - To return to the previous screen, press [◀ / ▶] button.

DMC-TZ30 DMC-TZ31

Go to step **8**.

DMC-TZ27

The clock setting procedure is completed with step **7**.

(Continued on the next page)

8 Press ◀ to select [Yes] and press [MENU/SET] if automatically correcting time of day using the GPS function

- To manually set date and time → select [No].
- When you select automatic time adjustment using the GPS function, [GPS Setting] is set to [ON].
- For details about [Auto Clock Set] (→140)

9 When [Please set the home area] is displayed, press [MENU/SET]

10 Press ◀▶ to set your home area and press [MENU/SET]

City or area name Current time



—Difference from GMT (Greenwich Mean Time)

To change time setting

When resetting date and time, select [Clock Set] from the [Setup] menu or [Rec] menu.

- Clock settings will be saved for approx. 3 months even after battery is removed, provided a fully-charged battery was installed in the camera for 24 hours beforehand.

1 Select [Clock Set] from the [Setup] menu or [Rec] menu

- For details about how to set the menu (→51)

2 Set the date and time (Perform steps 5 - 6. (→23))

- If the clock is not set, the correct date cannot be printed when you order a photo studio to print the picture, or when you stamp the date on the pictures with [Date Stamp] or [Text Stamp].
- If the clock is set, the correct date can be printed even if the date is not displayed on the screen of the camera.

Sequence of operations

1

Turn on the power



2

Set to 

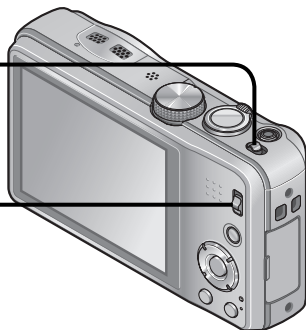

3 Set to the desired recording mode

Align the mode dial correctly to the mode that you want to use. →

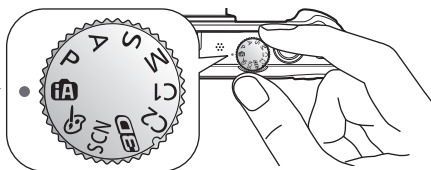

3

iA	[Intelligent Auto] Mode	Take pictures with automatic settings. (→31)
P	[Program AE] Mode	Record pictures with your own settings. (→27)
A	[Aperture-Priority] Mode	Determine aperture, then record pictures. (→73)
S	[Shutter-Priority] Mode	Determine shutter speed, then record pictures. (→73)
M	[Manual Exposure] Mode	Determine aperture and shutter speed, then record pictures. (→74)
C1 C2	[Custom] Mode	Record pictures using pre-registered settings. (→85)
ED	[3D Photo Mode]	Record 3D still pictures. (→84)
SCN	[Scene Mode]	Take pictures according to scene. (→77)
	[Creative Control] Mode	Take pictures by selecting your preferred picture effect. (→75)

Aim the camera and shoot

■ Taking still pictures

- ① Press the shutter button halfway to focus
- ② Press and hold the shutter button to take the picture

■ Recording motion pictures

- ① Press the motion picture button to start recording
- ② Press the motion picture button again to finish recording

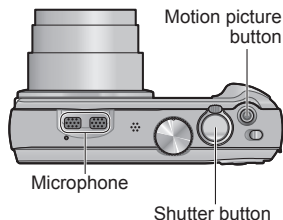

4

■ Holding the camera

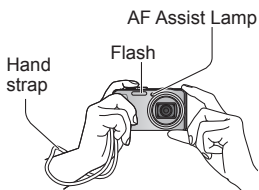

- To avoid camera shake, hold it with both hands keeping your arms close to your body while standing with your feet slightly apart.
 - Do not touch the lens.
 - Do not block the microphone when recording motion pictures.
 - Do not block the flash or the lamp. Do not look at it from close range.
 - Make sure that the camera does not move at the moment the shutter button is pressed.
- We recommend using the supplied hand strap to avoid dropping the camera.

Set to



5



View pictures (→42, 45)

6



- Press   to select a picture
- Press  to play back motion pictures or panorama pictures

Turn off the power

7



Taking pictures with your own settings

[Program AE] Mode

Recording mode: **P** A S M C1 C2 SCN

Using the [Rec] menu to change settings and set up your own recording environment.

- Slide the REC/PLAY switch to

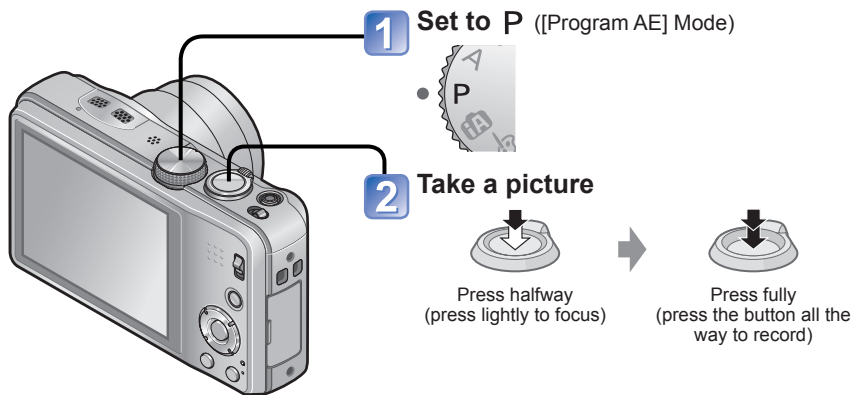

- If a warning is displayed about jitter, use [Stabilizer], a tripod, or [Selftimer].
- If aperture and shutter speed are shown in red, you do not have appropriate exposure. You should either use the flash, change [Sensitivity] settings or set [Min. Shtr Speed] to a slower speed.

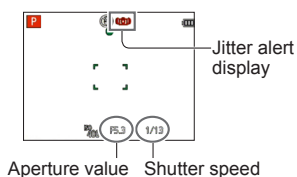

How to adjust focus

When [AF Mode] is set to  (1-area-focusing), focus on the AF area in the centre of the picture. If a subject you want to record is not in the centre, follow the steps below.

1 First adjust focus according to subject

Align the AF area with the subject



Hold down halfway

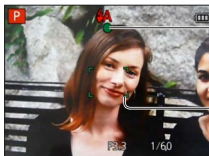

Focus display

(When focus is aligned: illuminated
When focus is not aligned: flashing)

AF area

(When focus is aligned: green
When focus is not aligned: red)

2 Return to desired composition



Press fully



AF area

- Subjects/environments which may make focusing difficult:
 - Fast-moving or extremely bright objects, or objects with no colour contrast.
 - Taking pictures through glass or near objects emitting light. In dark, or with significant jitter.
 - When too close to object or when taking pictures of both distant and close objects together in the same picture.

- The focus display flashes and beep sounds when focus is not aligned. Use the focus range displayed in red as a reference. Even if the focus display is lit, the camera may be unable to bring the subject into focus if it is out of range.
- The AF area display may be larger depending on recording conditions such as dark locations or zoom ratio.

Focus display

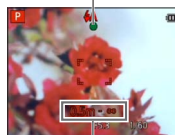

Focus range

Touching the screen and recording

(Touch Shutter function)

This function enables you to focus and record still pictures simply by touching the subjects that appear on the screen.

1 Touch on the screen



- The icon changes to , and you can now proceed with touch shutter recording.

2 Touch the subject you want to record

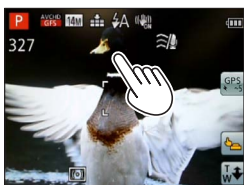

- The subject is recorded by setting the focus on the place that you touched.
- To release the touch shutter function → Touch .

- Motion pictures cannot be recorded.
- The touch shutter function will not work along the edges of the screen.
- Please note that the touch shutter will function even if you inadvertently touch the touch screen.
- The setting of the touch shutter function will be stored even if the power switch is turned to off.



Touching the screen and adjusting the focus and exposure (Touch AF/AE function)

This function enables the focus and exposure to be set when you touch the subject displayed on the screen.

- Perform these operations with the touch shutter function (→29) released.

1 Touch the place where you want to set the focus and exposure



- When [AF Mode] is set to  (Face Detection), the Face Detection function continues to operate, but the focus is adjusted to the place where you touched.
- When [AF Mode] is set to  (AF Tracking), the camera locks onto the subject, and it automatically continues to focus on the subject and adjusts the exposure of the subject as the subject moves.

2 Press the shutter button halfway to bring the subject into focus, and then press the button fully to record the subject

- To release the touch AF/AE function → Touch .

- The touch AF/AE function may fail to work under some recording conditions such as when the subject is too small or the recording location is too dark.
- The touch AF/AE function will not work along the edges of the screen.
- During [Intelligent Auto] Mode, the camera will determine the touched subject to be the optimal scene.

Taking pictures with automatic settings

[Intelligent Auto] Mode

Recording mode: **iA** P A S M C1 C2 ED SCN

Optimum settings are made automatically from information such as “face”, “movement”, “brightness”, and “distance” just by pointing the camera at the subject, meaning that clear pictures can be taken without the need to make settings manually.

- Slide the REC/PLAY switch to

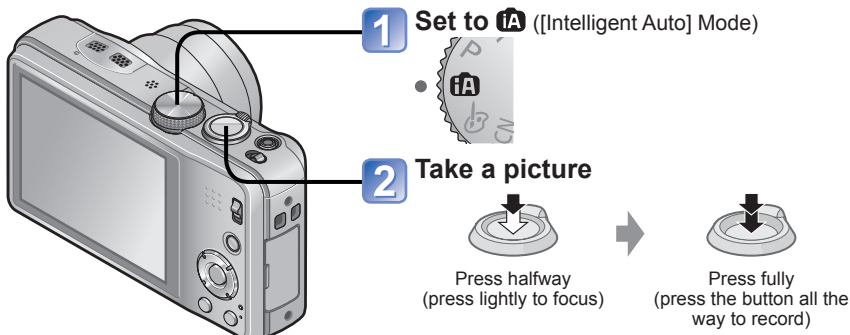

Focus display

(When focus is aligned: illuminated
When focus is not aligned: flashing)



About flash

Press to select **iA** or

- When **iA** is selected, the optimum flash is selected automatically depending on conditions (**iA**, **iA**^o, **iS**^o, **iS**).
- When **iA**^o or **iS**^o is selected, the red-eye reduction function is activated.
- When **iS**^o or **iS** is selected, the shutter speed is reduced.

Automatic Scene Detection

Camera reads scene when pointed at subject, and makes optimum settings automatically.



The icon of scene detected

	Recognises people
	Recognises babies* ¹
	Recognises landscapes
	Recognises night scenes and people in them (Only when iA is selected)* ²
	Recognises night scenes* ²
	Recognises night scenes without a tripod.* ³
	Recognises close-ups
	Recognises sunsets
	Reads subject movement to avoid blurring when scene does not correspond to any of the above.

*¹ When babies (under 3 years) that are registered with the Face Recognition function are recognised

*² We recommend using a tripod and the self-timer.

*³ When [iHandheld Nite Shot] is [ON]

- Depending on recording conditions, different scene types may be determined for the same subject.
- If desired scene type is not selected, we recommend manually selecting the appropriate scene mode.
- When , , or is detected, Face Detection is activated, and the focus and exposure are adjusted for the recognised faces.

■ About Backlight Compensation

Backlight is a condition where a light shines from behind a subject. When there is a backlight, the subject appears darker and the camera will automatically attempt to correct it by increasing the brightness of the picture. Backlight compensation is automatically activated in [Intelligent Auto] mode. When the camera detects backlight, is displayed on the LCD monitor. (Depending on the backlighting conditions, backlighting may not be detected correctly.)

About the Happy colour setting

When [Color Mode] is set to [Happy], pictures are recorded with vivid colouring.

■ Settings

- ① Press [MENU/SET]
- ② Use cursor button to select [Rec] menu and press [MENU/SET]
- ③ Use cursor button to select [Color Mode] and press [MENU/SET]
- ④ Use cursor button to select [Happy] and press [MENU/SET]

[Motion Deblur]

The camera automatically sets the optimum shutter speed in accordance with the movements of the subject to minimise the blur of the subject.

■ Settings

- ① Press [MENU/SET]
 - ② Use cursor button to select [Rec] menu and press [MENU/SET]
 - ③ Use cursor button to select [Motion Deblur] and press [MENU/SET]
 - ④ Use cursor button to select [ON] and press [MENU/SET]
- When [Motion Deblur] is set to [ON],  appears on the screen.
 - The subject may be recorded in a picture size smaller than the number of pixels that has been set.

[iHandheld Nite Shot]

If a night scene is detected automatically while the camera is handheld, the camera can record the still picture with less jitter and less noise by combining a burst of pictures.

■ Settings

- ① Press [MENU/SET]
 - ② Use cursor button to select [Rec] menu and press [MENU/SET]
 - ③ Use cursor button to select [iHandheld Nite Shot] and press [MENU/SET]
 - ④ Use cursor button to select [ON] and press [MENU/SET]
- When the camera is fixed in place on a tripod or by other means, [iHandheld Nite Shot] will not be identified.

[iHDR] (intelligent High Dynamic Range)

When [iHDR] is set to [ON] and there is, for example, strong contrast between the background and the subject, multiple still pictures are recorded with differing exposures and combined to create a single still picture rich in gradation.

■ Settings

- ① Press [MENU/SET]
 - ② Use cursor button to select [Rec] menu and press [MENU/SET]
 - ③ Use cursor button to select [iHDR] and press [MENU/SET]
 - ④ Use cursor button to select [ON] and press [MENU/SET]
- This function is automatically activated only when * is displayed on the LCD monitor.
* This icon is displayed when the camera detects a backlight.
 - The camera does not combine pictures in the following cases:
 - When the zoom ratio exceeds 20 times
 - [Burst] mode
 - In the case that a single picture is going to be composed from a burst, a message indicating that multiple pictures are to be recorded appears on the screen and burst recording is carried out. Note that burst recording will not take place if the camera determines that it can compensate for the difference in contrast without composing the picture from a burst.
 - In the case of composition from a burst, afterimages may appear if the subject was moving.

AF Tracking

This function enables the camera to continue to focus on the subject and adjust the exposure of the subject even when the subject is moving.

■With touch screen operations

Perform these operations with the touch shutter function (→29) released.

1 Touch the subject

- When switching to lock on to another subject → Touch the other subject.
- To release AF Tracking → Touch .



AF Tracking frame
AF Lock successful: Yellow
AF Lock failed: Red

■With cursor button operations

1 Press ▲ to set [AF Mode] to AF Tracking

- To cancel AF Tracking → Press ▲ again.

2 Align the AF Tracking frame with the subject, and then press ▼ to lock

- To cancel AF Lock → Press ▼.



AF Tracking frame
AF Lock successful: Yellow
AF Lock failed: Red

- The optimal scene for the AF locked subject is automatically identified.
- Face Recognition will be inactive while using AF Tracking.
- Under certain recording conditions, such as when the subject is small or when it is dark, [AF Tracking] may not operate correctly.

[Intelligent Auto] Mode restrictions





Only the menu items which are displayed in the [Intelligent Auto] Mode can be set. The settings selected in the [Program AE] or other modes will reflect on the menu items in the [Setup] menu that are not displayed.

- The settings for the following items are different from other recording modes: [Picture Size], [Burst] and [Color Mode] on the [Rec] menu, and [Beep] on the [Setup] menu
- The settings for the following functions are fixed:

[Setup] menu

- [Auto Review]: [2SEC]
- [Sleep Mode]: [5MIN.]
- [Guide Line]: 

[Rec] menu

- [Quality]:  [Fine]
- [Stabilizer]: [ON]
- [AF Assist Lamp]: [ON]
- [Metering Mode]:  [Multi Metering]
- [i.Resolution]: [i.ZOOM]
- [White Balance]: [AWB]
- [Sensitivity]:  ISO
- [AF Mode]:  [Face Detection]*
- [Quick AF]: [ON]
- [i.Exposure]: [STANDARD]
- [Red-Eye Removal]: [ON]

*  (23-area-focusing) when face cannot be recognised

[Motion Picture] menu

- [Continuous AF]: [ON]
- [Wind Cut]: [AUTO]

- The following functions cannot be used: [Histogram], [Exposure], [Auto Bracket], [WB Adjust.], [Min. Shtr Speed], [Digital Zoom]

Taking motion pictures

Recording mode: P A S M C1 C2 ED SCN

You can record motion pictures with audio (stereo).

- Slide the REC/PLAY switch to .
- Motion pictures cannot be recorded in the built-in memory. **DMC-TZ30** **DMC-TZ31**

Do not block the microphone when recording motion pictures.

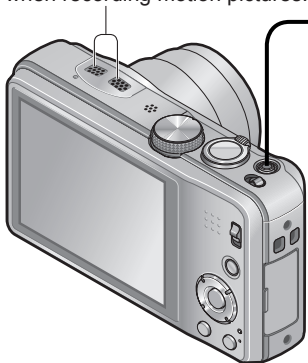

1 Press the motion picture button to start recording

[Rec Mode] (→106)/[Rec Quality] (→107)



Elapsed recording time

Remaining recording time (approx.)

- Immediately release the motion picture button after pressing it.
- You can also use zoom while recording motion pictures.
 - The zoom speed will be slower than normal.
 - When using zoom while recording motion pictures, it may take some time to focus.
- Still pictures can be taken during motion picture recording. (→41)

2 Press the motion picture button again to end recording

■ About the recording format for recording motion pictures

This unit can record motion pictures in either AVCHD or MP4 formats.

AVCHD:

You can record high definition quality images with this format. It is suitable for viewing on a large format TV or for saving to disc.

AVCHD Progressive:

The [GPH] **DMC-TZ30** **DMC-TZ31** or [PSH] in [AVCHD] is a mode that allows motion pictures to be recorded at 1920 x 1080/50p, the highest quality* that complies with the AVCHD standard.

Recorded motion pictures can be saved and played back using this unit or "PHOTOfunSTUDIO".

* This means the highest quality for this unit.

MP4:

This is a simpler video format best used when extensive editing is needed, or when uploading videos to the Internet.

- You can record a motion picture to the built-in memory only in [MP4] using the [VGA] setting. **DMC-TZ27**

■ About the compatibility of the recorded motion pictures

Motion pictures recorded in [AVCHD] or [MP4] may be played back with poor picture or sound quality or playback may not be possible even when played back with equipment compatible with these formats. Also, the recording information may not be displayed properly. In this case, use this unit.

- Motion pictures recorded with [GPH] **DMC-TZ30** **DMC-TZ31** or [PSH] in [AVCHD] can be played back on equipment that is compatible with AVCHD Progressive.
- For details on AVCHD Progressive and MP4 compatible devices, refer to the support site below.

<http://panasonic.jp/support/global/cs/dsc/>
(This Site is English only.)





■ Recording motion pictures in P



Records a motion picture at your preferred settings.

- Aperture and shutter speed are automatically set.

■ Recording motion pictures in IA

The camera automatically detects the scene to record motion pictures with optimal settings.

IA When scene does not correspond to any on the right.		
		

- In  mode, focus and exposure will be set according to the face detected.
-  will be selected for nightscapes and other dark scenes.
- If the camera does not select your desired Scene Mode, choosing an appropriate mode manually is recommended.
- The following menu options in the [Motion Picture] menu can be set:
 - [Rec Mode] • [Rec Quality]

■ Motion picture recording in other recording modes

For details, refer to the pages relating to the respective recording modes. (However, a motion picture cannot be recorded in [Panorama Shot] Scene Mode.)

- If the surrounding temperature is high, or a motion picture is recorded continuously,  is displayed and recording may be stopped halfway through to protect the camera. (Only when [Rec Quality] is set to [GPH] **DMC-TZ30** **DMC-TZ31**, [PSH], [GFS] **DMC-TZ30** **DMC-TZ31** or [FSH])
- Use a sufficiently charged battery.
- The available recording time displayed on the screen may not decrease regularly.
- If data is repeatedly recorded and deleted, the total available recording time on the SD card may be reduced. To restore the original capacity, use the camera to format the SD card. Be sure to save all important data to your computer or other media before formatting, as all data saved to the card will be erased.
- The Optical Image Stabiliser functions regardless of the settings before a motion picture is recorded.
- The following functions are not available:
Extra optical zoom, flash, [Face Recog.], [Rotate Disp.] for pictures taken vertically.
- For certain memory cards, recording may end while in progress.
- The recording range may become narrower in motion pictures compared to still pictures. Also, if the Aspect Ratio is different for still pictures and motion pictures, the angle of view will change when starting to record a motion picture. The recordable area is displayed by setting [Video Rec Area] (→56) to [ON].
- If Extra optical zoom is used before pressing the motion picture button, these settings will be cleared, and the recordable area will be changed significantly.
- Depending on the environment when recording motion pictures, the screen may turn black for an instant or noise may be recorded because of static electricity, electromagnetic waves, etc.

Recording still pictures while a motion picture is being recorded

Still pictures can be recorded even while a motion picture is being recorded.

1 Press the shutter button fully during the motion picture recording







Still pictures are recorded with [Aspect Ratio] setting of 16:9 and [Picture Size] setting of 3.5M. (Max.15 pictures)

Motion picture recording continues unchanged.

- The clicking sound made when the shutter button is operated may be recorded. If the noise of the camera operation is disturbing, use the touch shutter.
- When still pictures are recorded during zooming, the zooming may stop.

■ Burst function

When the burst function has been set in advance, a burst of still pictures can be recorded during motion picture recording.

- When the burst setting is set to , , or , still pictures are automatically recorded using the  setting.
- Even at the  or  setting, the focus is fixed at the first picture.

- If the touch shutter function has been set, still pictures will be recorded if the touch screen has been touched inadvertently during motion picture recording.
- The camera will refocus if the shutter button is pressed halfway during motion picture recording or if still pictures are recorded using the touch shutter function. This refocus movement is recorded even during motion picture recording. When priority is to be given to the motion picture videos, press the shutter button fully, and record the still pictures. Still pictures can also be created after motion picture recording. (→47)
- When the shutter button is pressed halfway, the picture size and the number of recordable pictures are displayed.
- Still pictures cannot be recorded in the following cases:
 - When [Rec Quality] is set to [VGA]
 - When recording [High Speed Video]
 - [Creative Control] Mode ([Soft Focus])
- The flash is set to  [Forced Flash Off].
- Since the electronic shutter is used for recording, the pictures recorded may be distorted.

Viewing your pictures [Normal Play]

When a card is in the camera, pictures are played back from the card, and without a card, pictures are played back from the built-in memory.

- Slide the REC/PLAY switch to .

1 Drag your finger across the screen, and select the picture to be played back

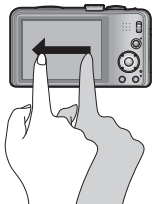

Scrolling to the next picture:

Drag your finger across the screen from right to left.

Returning to the previous picture:

Drag your finger across the screen from left to right.

- If you keep your finger touching the left or right edge of the screen after scrolling the pictures, the pictures will continue to be scrolled. (The pictures are displayed in a reduced size.)

- The pictures can also be scrolled by pressing the  cursor button. When the buttons are held down, the pictures can be scrolled quickly forward or backward.

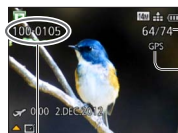

2 View pictures



Picture number/Total pictures

Location name information and latitude & longitude information are provided **DMC-TZ30 DMC-TZ31** (→131)

Folder/File number

- It may not be possible to view pictures on this camera that were previously edited on a computer.
- If the REC/PLAY switch is moved from  to  while the power is on, the lens barrel will be retracted after approx. 15 seconds.
- This camera is compliant with the unified DCF (Design rule for Camera File system) standard formulated by the Japan Electronics and Information Technology Industries Association (JEITA), and with Exif (Exchangeable image file format). Files that are not DCF-compliant cannot be played back.

Zooming in and viewing “Playback Zoom”

1 Touch the area that you want to magnify

Each time you touch an area, the camera magnifies the selected area by 2x, 4x, 8x, and 16x in succession. (The picture quality displayed becomes successively lower.)

- The area can also be magnified by moving the zoom lever toward T.

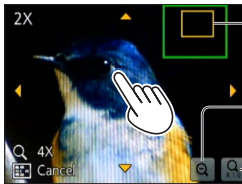
2 Drag your finger over the screen to move the position of the area magnified

Current zoom position

Reducing the display magnification rate

Return to the original size (1x)

- The magnification rate can also be reduced by moving the zoom lever toward W.
- The position of the area magnified can also be moved by operating the cursor button.

- Playback zoom cannot be used during motion picture playback.

Viewing a list of pictures “Multi Playback”

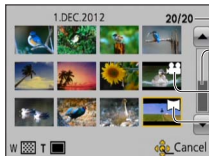
1 Move the zoom lever toward W side

Picture no./Total no.

Slide bar (drag this to change display)

Motion pictures

Panorama pictures

- Move the zoom lever further toward the W side and you can switch the display methods in the following order: 12-picture screen → 30-picture screen → Calendar playback. (Turn the lever to the T side to return.)
- When a picture is touched on the 12-picture or 30-picture screen, the picture touched is displayed on the 1-picture screen (full-screen).

- Pictures displayed with [!] cannot be played back.

Viewing pictures by their recording date “Calendar Playback”

1 Move the zoom lever toward W side several times

2 Touch the recording date to be displayed, and touch [Set] to enter the date

Select the month



The pictures recorded on the selected date appear on the 12-picture screen.

- The recording date can also be selected by using the cursor button, and press [MENU/SET].

- Only months when pictures were taken are shown on the calendar screen. Pictures taken without clock settings are displayed with the date 1st January, 2012.
- Pictures taken with destination settings made in [World Time] are displayed in the calendar screen using the appropriate date for the destination's time zone.

Viewing motion pictures

This unit was designed to play motion pictures using the AVCHD, MP4 and QuickTime Motion JPEG formats.

- Slide the REC/PLAY switch to .

1 Select a picture with the motion picture icon, and touch

Playback now starts.

- You can also press  to play back motion pictures.



Motion picture recording time
Example: After 10 minutes and 30 seconds: [10m30s]







Motion picture icon (differs depending on the recording mode and picture quality setting)

■ Operations during motion picture playback

- ① Touch the screen to display the control panel.
 - ② Touch the control panel to perform playback operations.
- If there is no operation for about 2 seconds, the control panel disappears.



Control Panel

- : Pause/Play
- : Stop
- : Capturing still pictures from motion pictures (→47)
- : Fast rewind (2 steps)
- : Single-frame rewind (while paused)
- : Fast forward (2 steps)
- : Single-frame forward (while paused)

Volume adjustment

Volume level

Playback bar

(The playback position can be moved by touch operation.)

Elapsed playback time

- You can also use the cursor button to perform playback operations.
 - ▲: Pause/play
 - ▼: Stop
 - ◀: Fast rewind (2 steps)/Single-frame rewind (while paused)
 - ▶: Fast forward (2 steps)/Single-frame forward (while paused)
 - [MENU/SET]: Capturing still pictures from motion pictures (→47)
- Volume can be adjusted with the zoom lever.

- It may not be possible to properly play back the motion pictures recorded using other cameras.
- Some information will not be displayed for motion pictures recorded in [AVCHD].
- Motion pictures can be viewed on your computer using "PHOTOfunSTUDIO" on the supplied disc.
- Motion pictures recorded with [Miniature Effect] in [Creative Control] Mode play back at approximately 8 times speed.

Capturing still pictures from motion pictures

Save a scene from a motion picture as a still picture.

1 Display the picture that you want to capture as a still picture by pausing a motion picture during playback

2 Touch



• A confirmation screen is displayed. Select [Yes] with cursor button and then press [MENU/SET].

• You can also capture still pictures from motion pictures by pressing [MENU/SET].

[Rec Quality] of the original motion picture	[Picture Size]	[Aspect Ratio]
[GPH]* [GFS]* [GS]* [PSH] [FSH] [SH] [FHD] [HD]	2M	16:9
[VGA] [High Speed Video]	0.3M	4:3

* **DMC-TZ30** **DMC-TZ31**

- The picture quality becomes slightly lower depending on the [Rec Quality] setting of the original motion picture.
- It may not be possible to capture still pictures from motion pictures that were recorded with a different camera.

[Video Divide]

A single motion picture can be split into 2 parts. This is convenient when you want to keep just the necessary scenes, or if you wish to delete unnecessary scenes to increase free space on your card, such as when travelling.

1 Select a motion picture to be split and then touch



- You can also press ▼ to move to the function for splitting a motion picture.

2 Pause at the place to split

3 Touch



- A confirmation screen is displayed. Select [Yes] with cursor button and then press [MENU/SET].
- **The original motion picture that was split does not remain.**
(There will only be the 2 motion pictures that were created after the split.)
- You can also press ▼ to split a motion picture.

- During splitting, do not turn off the camera's power or remove the card or battery. If you do so, the motion picture may be deleted.
- Splitting a motion picture recorded in [MP4] or [High Speed Video] changes the order of the pictures. It is recommended to display with [Calendar] (Calendar Playback) or [Filtering Play].
- It may not be possible to split motion pictures that were recorded with a different camera.
- Motion pictures with a short recording time cannot be divided.

Deleting pictures

Pictures will be deleted from the card if the card is inserted, or from the built-in memory if the card is not inserted. (Deleted pictures cannot be recovered.)



1 Press to delete displayed picture

Q.MENU



- A confirmation screen is displayed. Select [Yes] with cursor button and then press [MENU/SET].

- Do not turn off the power during deletion.
- Use a sufficiently charged battery.
- Pictures cannot be deleted in the following cases:
 - Protected pictures
 - Card switch is in "LOCK" position.
 - Pictures not of DCF standard (→42)

To delete multiple (up to 100)/To delete all pictures

A burst group is handled as one picture. (All the pictures in the selected burst group are deleted.)



1 Press to delete displayed picture

Q.MENU



2 Use ▲ ▼ to select [Delete Multi]/[Delete All] and press [MENU/SET]



● [Delete Multi]

Use cursor button to select picture and press [DISP.] button

Picture selected

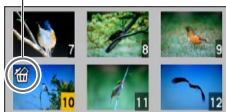

- To cancel → Press [DISP.] button again.
- To execute → Press [MENU/SET].
- You can select [All Delete Except Favorite] in [Delete All] if there are pictures that have been set as [Favorite] (→123).
- A confirmation screen is displayed. Select [Yes] with cursor button and then press [MENU/SET].
- May take time depending on number of pictures deleted.

Setting the menu

Refer to the procedure below for an example on how to operate the menus.

Example: Changing [AF Mode] in the [Rec] menu in [Program AE] Mode

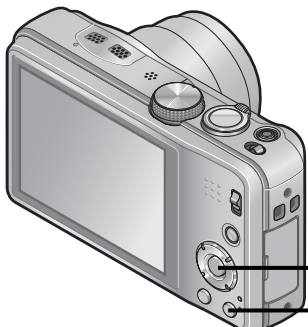

- 1 Press [MENU/SET]**
The menu selection screen is displayed.
- 2 Use cursor button to select a menu, and then press [MENU/SET]**
 - The menu type can also be selected by touch operations.
- 3 Use ▲ ▼ to select the menu item, and then press [MENU/SET]**

■ Menu selection screen

- In recording mode



- In playback mode

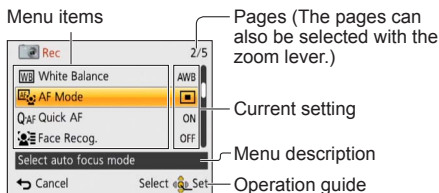
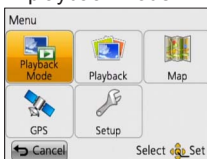

- To return to the previous screen, press [⏪ / ⏩] button.

- 4 Press ▲ ▼ to select a setting, and then press [MENU/SET]**

The selected setting is set.



- 5 Press [⏪ / ⏩] button several times**
The menu closes and the monitor returns to the previous screen.

Menu type

[Rec] menu (→95)

(Recording mode only)

- You can perform settings such as tones, Sensitivity, Aspect Ratio, and Picture Size.

[Motion Picture] menu (→106)

(Recording mode only)

- You can select the recording mode and picture quality and other settings.

[GPS] menu **DMC-TZ30** **DMC-TZ31** (→128)

- You can select the GPS setting, location name display and other settings.

[Setup] menu (→54)

- You can perform settings for convenience of use such as the clock setting and changing of the beep sounds.

[Playback Mode] menu (→111)

(Playback mode only)

- Choose [Playback Mode] to see Slide Shows or to narrow down the pictures for display, etc.

[Playback] menu (→117)

(Playback mode only)

- Enables you to specify picture protection, resizing, and other settings for pictures you have taken.

[Map] menu **DMC-TZ30** **DMC-TZ31** (→146)

(Playback mode only)

- You can display the current location on a map or edit the location information of a place where a picture was taken.

- The operation screen examples in this manual may differ from the actual screen display or some parts of the screen display are omitted.
- The menu types and items that are displayed vary according to the mode.
- The setting methods vary depending on the menu item.
- In recording mode, the menu screen can also be exited by pressing the shutter button halfway.
- The following menu is also displayed depending on the recording mode.
 - In the [Scene Mode] mode: [Scene Mode] menu (→77)
 - In the [Custom] mode: [Custom] menu (→85)
 - In the [Creative Control] mode: [Creative Control] menu (→75)

Using Quick menu

During recording, you can easily call some of the menu items and set them.



1 Press [Q.MENU] button

2 Press ◀▶ to select a menu item

- The menu items and setting items that are displayed differ depending on the recording mode.

3 Press ▲▼ to select the settings





















4 Press [MENU/SET]





Using the [Setup] menu

[Clock Set], [Economy] and [Auto Review] are important for clock setting and battery life. Please check these before use.







- For details about the setting procedure in the [Setup] menu (→51)

Item	Settings, notes
 [Clock Set] (→23)	Set time, date, and display format.
DMC-TZ30 DMC-TZ31  [Auto Clock Set] Setting the clock automatically using GPS. (→140)	[ON] / [OFF]
 [World Time] Set the local time at travel destination. (→93)	 [Destination]: Set the local time at travel destination.  [Home]: Set date and time at home area.
 [Travel Date] Record the number of days elapsed in your travels. (→92)	[Travel Setup] [SET] (Register departure and return dates) / [OFF]
	[Location] [SET] (Input name of location) / [OFF]
 [Beep] Change or mute the beep/shutter sounds.	[Beep Level]  /  /  : Low / High / Mute
	[Beep Tone]  ① /  ② /  ③ : Change beep tone.
	[Shutter Vol.]  ① /  ② /  ③ : Low / High / Mute
	[Shutter Tone]  ① /  ② /  ③ : Change shutter tone.



- For details about the setting procedure in the [Setup] menu (→51)

Item	Settings, notes
 [Volume] Adjust volume of sound from speakers (7 levels).	[0] / [1] / [2] / [3] / [4] / [5] / [6] <ul style="list-style-type: none"> • Cannot be used to adjust TV speaker volume when connected to TV.
 [Cust.Set Mem.] Register settings on current camera. (→85)	[C1] / [C2-1] / [C2-2] / [C2-3]
 [LCD Display] Adjust brightness and colour of the LCD monitor.	<ol style="list-style-type: none"> ① Press ▲ ▼ to select the setting item and press ◀ ▶ to make adjustments ② Press [MENU/SET] <ul style="list-style-type: none"> • Some subjects may look different from their actual appearance, but the recorded picture will not be affected.
 [LCD Mode] Make LCD monitor easier to see.	<input checked="" type="checkbox"/> [Auto Power LCD]: The brightness is adjusted automatically depending on how bright it is around the camera. <input type="checkbox"/> [Power LCD]: Makes screen brighter than normal (for outdoor use). [OFF] <ul style="list-style-type: none"> • Cannot select [Auto Power LCD] in playback mode. • [Power LCD] returns to ordinary brightness if there is no operation for 30 seconds when recording. (Press any button to make the screen brighter again.) • Because the picture shown on the LCD monitor screen emphasises brightness, some subjects may look different than their actual appearance, but this will not affect the recorded picture. • Setting [LCD Mode] reduces the operating time.







- For details about the setting procedure in the [Setup] menu (→51)

Item	Settings, notes
 [Guide Line] Select recording information display and types of guidelines.	<p>[Rec. Info.] [ON] (Display recording information with guidelines.) [OFF]</p> <p>[Pattern]  /  : Change the patterns of guidelines. <ul style="list-style-type: none"> • When [Intelligent Auto] Mode has been selected, only  is displayed. Also, recording information and guidelines cannot be displayed simultaneously. • This function cannot be used in the following case: [Panorama Shot] scene mode </p>
 [Histogram] Check brightness in picture on graph. (→62)	<p>[ON] / [OFF]</p>
 [Video Rec Area] Enables verification of the recordable area for a motion picture before recording.	<p>[ON] / [OFF]</p> <ul style="list-style-type: none"> • Recordable area displayed for motion pictures should be interpreted as a guideline. • When using Extra optical zoom, the recordable area may not always be displayed for certain zoom ratios. • This setting cannot be used with [Intelligent Auto] Mode.
 [Zoom Resume] Remember the zoom position when turning the power off.	<p>[ON] / [OFF]</p>





- For details about the setting procedure in the [Setup] menu (→51)

Item	Settings, notes
<p>ECO [Economy]</p> <p>Turn off the power or make the LCD monitor go dark while not using the camera to minimise battery consumption.</p>	<p> [Sleep Mode]</p> <p>[2MIN.] / [5MIN.] / [10MIN.] / [OFF]: Automatically shut off power while not in use.</p> <ul style="list-style-type: none"> • To restore → Press the shutter button halfway, or turn on the power again. • Cannot be used in the following cases: When connected to computer/printer, during motion picture recording/playback, during Slide Shows, during automatic demo playback • Settings fixed to [5MIN.] in [Intelligent Auto] Mode. <p> [LCD Power Save]</p> <p>[ON] / [OFF]: The LCD monitor goes dark to minimise power consumption.</p> <ul style="list-style-type: none"> • Reduces the picture quality of the LCD monitor display during recording to minimise battery consumption (except for the Digital Zoom area). Note, however, that there is no effect on the recorded picture. • The setting in [LCD Mode] is prioritised over the setting in [LCD Power Save] for the brightness of the LCD monitor.
<p> [Auto Review]</p> <p>Automatically display still pictures immediately after taking them.</p>	<p>[1SEC] / [2SEC]</p> <p>[HOLD]: Auto review screen remains until a button (other than the [DISP.] button) is pressed</p> <p>[OFF]</p> <ul style="list-style-type: none"> • The following cases are fixed to the settings indicated below. [Intelligent Auto] Mode: [2SEC] Scene Mode [Panorama Shot]: [2SEC] • Automatically displays still pictures immediately after they are taken regardless of the [Auto Review] setting in [Auto Bracket], [Burst] mode, and [Handheld Night Shot] and [HDR] Scene Modes. • Motion pictures cannot be automatically reviewed.







- For details about the setting procedure in the [Setup] menu (→51)

Item	Settings, notes
 [No.Reset] Reset picture file numbers.	<ul style="list-style-type: none"> • The folder number is updated and the file number starts from 0001. • A folder number between 100 and 999 can be assigned. Numbers cannot be reset once folder number reaches 999. In this case, save all necessary pictures to your computer, and format the built-in memory/card (→60). • To reset folder number to 100: First, format the built-in memory or card, and reset the file numbers using [No.Reset]. Then, select [Yes] on the folder number reset screen.
 [Reset] Reset to the default settings.	<p>[Reset Rec. settings?]</p> <p>[Reset setup parameters?]</p> <ul style="list-style-type: none"> • Information registered in [Face Recog.] is reset if recording settings are reset. • Resetting the setup parameters will also reset the following: <ul style="list-style-type: none"> - Age in years/months and names in [Baby] and [Pet] Scene Modes, [GPS] menu, [Map] menu DMC-TZ30 DMC-TZ31 - Age in years/months and names in [Baby] and [Pet] Scene Modes DMC-TZ27 • Folder numbers and clock settings will not be reset. • Camera movement may be audible as the lens function is reset. This is not a fault.
 [USB Mode] Select communication method for when connecting camera to a computer or printer with USB connection cable. DMC-TZ30 DMC-TZ31 Update the GPS assist data.	<p> [Select on connection]: Select communication method each time you connect to a computer or PictBridge-compatible printer.</p> <p> [PictBridge(PTP)]: Select when connecting to a PictBridge-compatible printer.</p> <p> [PC]: Select when connecting to a computer.</p> <p>DMC-TZ30 DMC-TZ31</p> <p> [GPS assist data]: Update the GPS assist data. (→141)</p>

- For details about the setting procedure in the [Setup] menu (→51)

Item	Settings, notes
 [Output] Change the settings to be used when the camera is connected to a TV or other device.	 [Video Out] [NTSC] / [PAL] If the default setting is changed, AVCHD motion pictures may not be played correctly.  [TV Aspect] (This setting performs when an AV cable (optional) is connected.) 16:9 / 4:3
 [VIERA Link] Enable automatic linking with other VIERA Link-compatible devices, and operability with a VIERA remote control when connecting via an HDMI mini cable (optional) (→158).	[ON]: Operations may be performed via the remote control of the VIERA Link-compatible device. (Not all operations will be available.) Operability of the camera's own buttons will be limited. [OFF]: Operations must be performed via the camera's own buttons.
 [3D Playback] Set how 3D still picture is output.	[3D] / [2D] <ul style="list-style-type: none"> • If you want to play back a picture in 2D (conventional picture) on a 3D television, set to [2D]. • This item of the menu functions when an HDMI mini cable (optional) is connected. • For the procedure for playing back a 3D still picture (→160).

- For details about the setting procedure in the [Setup] menu (→51)

Item	Settings, notes
 [Rotate Disp.] Automatically rotate portrait still pictures.	  : Rotate and display pictures displayed on a TV screen as well as those displayed on the LCD monitor of the camera in portrait orientation.  : Rotate and display only pictures displayed on a TV screen in portrait orientation. [OFF] <ul style="list-style-type: none"> • [Rotate Disp.] cannot be used with motion pictures. • Still pictures taken with the lens surface facing up or down, or still pictures taken on other cameras may not rotate. • Pictures cannot be rotated during Multi Playback. • Will only be displayed rotated on computer if in Exif-compatible (→42) environment (OS, software).
 [Version Disp.] Check the camera firmware version or display software information.	Current version is displayed. <ul style="list-style-type: none"> • When you press [MENU/SET] while the version is displayed, software information such as the licence is displayed.
 [Format] Use when [Built-In Memory Error] or [Memory Card Error] appears, or when formatting the built-in memory or card. When a card/built-in memory is formatted, the data cannot be restored. Check the content of the card/built-in memory carefully before formatting.	<ul style="list-style-type: none"> • This requires a sufficiently charged battery. When formatting the built-in memory, remove the cards. (Only inserted card will be formatted if present; built-in memory will be formatted if no card is inserted.) • Always format cards with this camera. • All data including protected pictures and copied map data will be deleted. DMC-TZ30 DMC-TZ31 • All protected pictures and other picture data will be deleted. DMC-TZ27 • Do not turn off power or perform other operations during formatting. • Formatting the built-in memory may take several minutes. • Consult the dealer or your nearest Service Centre if format cannot be successfully completed.

- For details about the setting procedure in the [Setup] menu (→51)

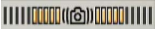
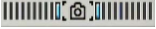
Item	Settings, notes
 [Language] Change display language.	Set the language displayed on the screen.
DEMO [Demo Mode] View demonstration of functions.	<p>[Stabilizer Demo.] Extent of jitter is shown on graph (estimate)</p>  Extent of jitter  Extent of jitter after correction
	<p>[Auto Demo]: View introductory Slide Show [ON] / [OFF]</p> <ul style="list-style-type: none"> • [Auto Demo] cannot be displayed on external devices such as TVs.

Changing recording information display

Change between different LCD monitor displays, such as Histograms.

1 Press [DISP.] button to change display

● In Recording Mode

Recording information*1

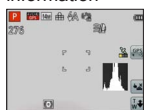

Motion picture recording information*1,*2



No display



Guide lines*1,*3



● In Playback Mode

Picture information



Recording information*1



No display

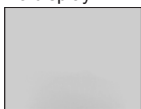

*1 Set [Histogram] to display a histogram. (→56)

*2 Return to the "Recording information" display by pressing the shutter button halfway.

*3 About [Guide Line] (→56)

● During Playback Zoom, Motion Picture Playback, Slide Show:

You can only turn on and turn off the display.

● During menu display, Multi Playback or Calendar Playback: Display cannot be changed.

■ Histogram

Displays distribution of brightness in picture – e.g. if the graph peaks at the right, this means there are several bright areas in the picture (Guide). A peak in the centre represents correct brightness (correct exposure). This can be used as a reference for exposure correction, etc. (→71)

(Example)

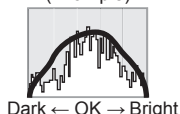

- Histogram from time of recording is different to Histogram in playback and displayed in orange, when recording with flash or in dark locations. Also, Histogram may differ from Histograms made with image editing software.
- Histogram is not displayed during a performance of IA ([Intelligent Auto] Mode) or Playback Zoom.

Using Zoom

Recording mode: 

You can adjust the area of a picture to be taken using zoom.

1 Zoom In/Out

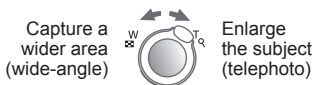

- The zoom speed can be set to one of 2 levels using the angle at which the zoom lever is moved.

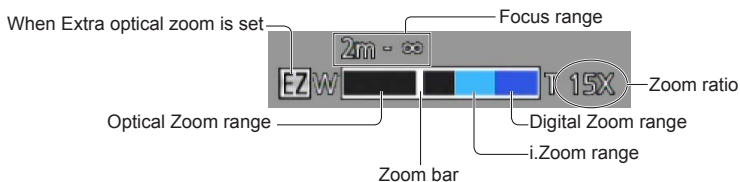



- Adjust the focus after adjusting the zoom.
- Do not touch the lens barrel during zooming.
- The zoom ratio and the zoom bar displayed on the screen are estimates.
- The camera may make a rattling noise and vibrate when the zoom lever is operated - this is not a malfunction.

Using the zoom by performing touch operations

1 Touch 

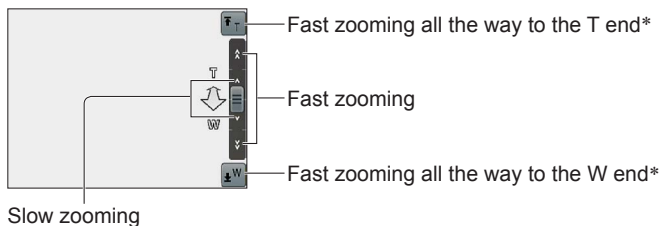
The zoom bar appears on the screen.

2 Touch the T or W edge of the zoom bar on the screen

* When  or  is touched again while zooming, zooming will stop.

Zoom types and use

The zoom ratio changes when the number of recording pixels is changed.



■ Optical Zoom

Zooming in up to 20x is possible if pictures without  have been selected by [Picture Size] on the [Rec] menu. (→95)

- Optical Zoom cannot be used in the following cases:
 - Scene Mode ([Panorama Shot])
 - [Macro Zoom]

■ Extra optical zoom



Zooming in up to 42.2x is possible when pictures with  have been selected by [Picture Size] on the [Rec] menu (→95). EZ is short for “Extra optical zoom”.

- Extra optical zoom cannot be used in the following cases:
 - [Intelligent Auto] Mode (when [Motion Deblur] is [ON])
 - [Macro Zoom] • Motion picture • When the [Burst] setting is set to ,  or 
 - Scene Modes ([Panorama Shot] [HDR] [High Sens.] [High Speed Video])
 - [Creative Control] Mode ([Toy Effect])

To increase the zoom ratio further, the following zoom can be used in combination.



■ [i.ZOOM]

You can use the camera's Intelligent Resolution technology to increase the zoom ratio up to 2x higher than the original zoom ratio with limited deterioration of picture quality. Set [i.Resolution] to [i.ZOOM] on the [Rec] menu. (→102)

- When [i.Resolution] is set to [i.ZOOM], Intelligent Resolution technology is applied to the picture.
- [i.ZOOM] does not function in the following cases.
 - [Intelligent Auto] Mode (when [Motion Deblur] is [ON])
 - Scene Modes ([Panorama Shot] [Handheld Night Shot] [HDR] [High Sens.])
 - When the [Burst] setting is set to ,  or 
 - [Creative Control] Mode ([Toy Effect])
 - [Macro Zoom]

■ [Digital Zoom]

Zoom 4x further than Optical/Extra optical zoom. Note that, with Digital Zoom, enlarging will decrease picture quality. Set the [Digital Zoom] in the [Rec] menu to [ON]. (→102)

- Digital Zoom cannot be used in the following modes:
 - [Intelligent Auto] Mode • When the [Burst] setting is set to ,  or 
 - Scene Modes ([Panorama Shot] [Handheld Night Shot] [HDR] [High Sens.] [High Speed Video])
 - [Creative Control] Mode ([Toy Effect] [Miniature Effect])
- When Digital Zoom is used simultaneously with i.Zoom, you can only increase the zoom ratio up to 2x.

Taking pictures with flash

Recording mode: PA S M C1 C2 ED SCN

- 1 Press to display [Flash]
- 2 Use cursor button to select the desired type and press [MENU/SET]

Type, operations	Uses
[Auto] *1 • Automatically judges whether or not to flash	Normal use
[Auto/Red-Eye]*2 • Automatically judges whether or not to flash (reduce red-eye)	Taking pictures of subjects in dark places
[Forced Flash On] • Always flash	Taking pictures with backlight or under bright lighting (e.g. fluorescent)
[Slow Sync./Red-Eye]*2 • Automatically judges whether or not to flash (reduce red-eye; slow shutter speed to take brighter pictures)	Taking pictures of subjects against a nightscape (tripod recommended)
[Forced Flash Off] • Never flash	Places where flash use is prohibited

*1 Only in the mode

*2 Two flashes will be emitted. Do not move until after the second flash. Interval between flashes varies according to brightness of subject.

If [Red-Eye Removal] on the [Rec] menu is [ON], the appears with the flash icon, red-eye is automatically detected and still picture data is corrected. (Only when [AF Mode] is (Face Detection))

- Do not put your hands over the light-emitting area of the flash (→10) or look at it from close range (a few centimetres away). Do not use the flash at close distances to other subjects (heat/light may damage subject).
- Edges of picture may become slightly dark if using flash at short distances without using zoom (close to max. W). This may be remedied by using a little zoom.
- The effect of red-eye reduction varies depending on the subject and is affected by factors such as distance to the subject, whether the subject is looking at the camera during preliminary flash, and so on. In some cases, the effect of red-eye reduction may be negligible.
- Flash settings may be changed when changing recording mode.
- Scene Mode flash settings are restored to default when Scene Mode is changed.
- No pictures may be taken if these marks (e.g.) are flashing (flash is charging).
- If light from the flash on a subject is insufficient, neither the proper exposure nor White Balance is achieved.
- The flash effect may not be sufficient in the following cases:
 - Slow shutter speed
 - [Flash Burst] is set
- Flash charging may take time if battery is low, or if using flash repeatedly.

Available types in each mode (○: Available, –: Not available, □: Default setting)

	iA	P A	S M	[Scene Mode]									
	○*1	○	○	○	○	○	–	○	○	○	○	○	○
	–	○	○	○	○	–	–	–	○	–	–	–	–
	–	○	○	○	○	○	–	○	○	○	○	○	○
	–	○	–	–	–	–	○	–	–	–	–	–	–
	○	○	○	○	○	○	○	○	○	○	○	○	○

*1 Set to , , or depending on the subject and brightness.

- The flash cannot be used when recording motion pictures or in the , , , , , , and Scene Modes.

The available flash range when [Sensitivity] setting is [AUTO]

Max. W	Approx. 0.6 m-6.4 m (2.0 - 21 feet)
Max. T	Approx. 1.0 m-3.3 m (3.3 - 11 feet)

Shutter speeds for each flash mode

	1/60*2 - 1/2000th
	1*2*3 - 1/2000th

*2 Varies according to [Min. Shtr Speed] setting.

*3 When [Min. Shtr Speed] is set to [AUTO], and a jitter is detected when [Stabilizer] is turned to [ON], the maximum speed is 1/4 second. Also varies according to [Intelligent Auto] Mode and Scene Modes, etc.

Taking close-up pictures

Recording mode: P A S M C L C 2 7D SCN

When you want to enlarge the subject, setting to [AF Macro] (AF👉) enables you to take pictures at an even closer distance than the normal focus range (up to 3 cm (0.098 feet) for max. W).

1 Press **▼** to display [Macro Mode]

2 Use cursor button to select [AF Macro] and press [MENU/SET]



AF👉 display

■ Taking close-up pictures without standing close to subject

“Tele macro” operates automatically when you increase the zoom ratio to 12 times or higher while [AF Macro] is set, enabling the camera to focus on a subject as close as 1 m (3.3 feet).

(AF👉 changes to TELE👉)

Focus range

When a subject is too close to the camera, the picture may not be properly focused. The shortest recording distance differs depending on the zoom ratio and the setting in macro recording mode.

■ Shortest recording distance

The shortest recording distance is the distance from the lens front to the subject. This distance changes gradually depending on the zoom position. At the time of zooming, even if [Macro Mode] is set to [AF Macro] (AF👉), the shortest recording distance is the same as when the mode is set to OFF (2 m (6.6 feet) when the optical zoom magnification of 5x to 7x is used).

Zoom	[Macro Mode]	
	AF👉	OFF
Max. W	3 cm (0.098 feet)	50 cm (1.6 feet)
Max. T	1 m (3.3 feet)	2 m (6.6 feet)

- Focus range is displayed when operating the zoom, etc.



- It may take some time until distant subjects come into focus.
- Using a tripod and [Selftimer] is recommended. Also, when recording a subject that is close to the camera, setting [Flash] to [Forced Flash Off] is recommended.
- Moving the camera after aligning the focus is likely to result in poorly focused pictures if subject is close to the camera, due to the margin for focus alignment being severely reduced.
- Resolution may be reduced around the edges of the picture.

[Macro Zoom]

To take even larger images of the subject, setting to [Macro Zoom] enables the subject to appear even larger than when using [AF Macro].

1 Press **▼** to display [Macro Mode]

2 Use cursor button to select [Macro Zoom] and press [MENU/SET]

3 Adjust the Digital Zoom magnification with the zoom lever

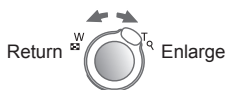

The zoom position is fixed at the Wide end.

Focus range is 3 cm (0.098 feet) - ∞.

Digital Zoom magnification (1 x to 3 x)

- You can also perform [Macro Zoom] by touch operations. (→64)

- In [Macro Zoom], higher magnification results in lower picture quality.
- When [Macro Zoom] is set, Extra optical zoom or [i.ZOOM] does not work.
- The [Macro Zoom] cannot be set in the following cases:
 - [Creative Control] Mode ([Toy Effect] [Miniature Effect])
 - [3D Photo Mode]
 - When the [Burst] setting is set to or .
- When [AF Tracking] is set, zoom macro is cancelled.

Taking pictures with self-timer

Recording mode: 

We recommend using a tripod. This is also effective for correcting jitter when pressing the shutter button, by setting the self-timer to 2 seconds.

1 Press  to display [Selftimer]

2 Use cursor button to select time duration and press [MENU/SET]

3 Take a picture

Press the shutter button fully to start recording after the preset time.



Self-timer indicator
(Flashes for set duration)

- To cancel while in operation → Press [MENU/SET]

- Focus will be automatically adjusted immediately before recording if the shutter button is pressed fully.
- After Self-timer indicator stops flashing, it may then be lit for AF Assist Lamp.
- This function cannot be used in the following cases:
 - [Underwater] and [High Speed Video] scene modes
 - Recording motion pictures

Taking pictures with Exposure Compensation

Corrects the exposure when there is a backlight or when the subject is too dark or too bright.

■ Recording mode:  **P A S** M     

1 Press **▲** to display [Exposure]

2 Use cursor button to select a value and press [MENU/SET]

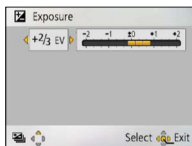

- If the picture is too dark, adjust the exposure to the “+” direction.
- If the picture is too bright, adjust the exposure to the “-” direction.
- After exposure adjustment, the adjustment value ( +2/3 for example) is displayed in the bottom-left corner of the screen.

- Depending on the brightness, this may not be possible in some cases.
- The Exposure Compensation value you set is retained even after the camera is turned off.

Recording while exposure is changed automatically ([Auto Bracket])

Records 3 pictures in continuous succession while exposure is changed automatically. After exposure adjustment, the adjustment value is set as the standard.

■ Recording mode: **(A) P A S M C1 C2** *ED* **SCN** 

1 Press **▲** several times to display [Auto Bracket]

2 Use cursor button to select a value and press [MENU/SET]

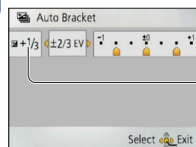

Value displayed after Exposure Compensation set

- The first still picture is recorded without compensation, the second still picture is recorded with exposure adjusted in the “-” direction, and the third still picture is recorded with exposure adjusted in the “+” direction.
- Cancelled when the power is turned off.

- Cannot be used with flash.
- When [Auto Bracket] is set, [Burst] is cancelled.
- [Auto Bracket] cannot be used in the following cases:
 - [Creative Control] Mode ([Miniature Effect] [Soft Focus])
 - Scene Modes ([Panorama Shot] [Handheld Night Shot] [HDR] [High Speed Video])
 - Recording motion pictures

Determine aperture and shutter speed and record

Recording mode:  P **A** S M C1 C2  SCN 

[Aperture-Priority] Mode

When recording, you can control the aperture value to meet your recording purposes. Shutter speed is automatically adjusted to be appropriate for the set aperture value.

1 Set mode dial to **A** ([Aperture-Priority] Mode)

2 Press [EXPOSURE] button and use cursor button to determine aperture value

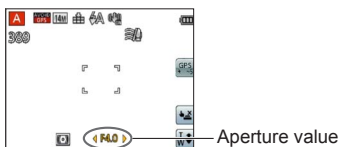

- When the aperture value is increased, the range of depth in focus expands, and the picture shows up clearly from the position of the camera to the background.
- When the aperture value is reduced, the range of depth in focus shrinks, and the background can get blurry.

3 Press [EXPOSURE] button

[Shutter-Priority] Mode

When recording, you can control the shutter speed to meet your recording purposes. Aperture is automatically adjusted to be appropriate for the set shutter speed.

1 Set mode dial to **S** ([Shutter-Priority] Mode)

2 Press [EXPOSURE] button and use cursor button to determine shutter speed

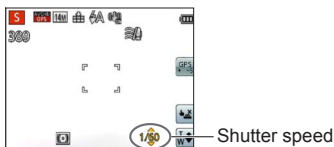

- At faster shutter speeds, movements by the subject show as if they are still.
- At slower shutter speeds, subjects that are moving show as jittery.

3 Press [EXPOSURE] button

[Manual Exposure] Mode

This mode of recording lets you set any aperture value and shutter speed when exposure adjustment prevents you from recording at the desired exposure (brightness/darkness). Also, long-exposure recording of up to 15 seconds is possible.

1 Set mode dial to **M** ([Manual Exposure] Mode)

- Manual exposure assist is displayed.

2 Press [EXPOSURE] button and use cursor button to determine aperture value and shutter speed

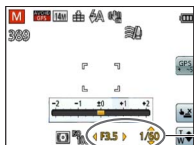

Aperture value/shutter speed

3 Press [EXPOSURE] button

■ Manual exposure assist (estimate)

If the shutter button is pressed halfway, manual exposure assist is displayed.

	Shows pictures with standard brightness.
	Shows brighter pictures. For standard brightness, either use a faster shutter speed or increase aperture value.
	Shows darker pictures. For standard brightness, either use a slower shutter speed or reduce aperture value.

■ Recording motion pictures in **A S M**

- Aperture and shutter speed are automatically set.
- When the picture is too bright or too dark or there is incorrect exposure, the numbers for the aperture value and shutter speed are shown in red.
- LCD monitor brightness may vary from the actual still picture recorded.

Taking Pictures with different picture effects

[Creative Control] mode

Recording mode: P A S M C1 C2 SCN

You can select your own settings from various effects and take pictures while confirming these effects on the LCD monitor.

1 Set mode dial to

2 Press to select a setting, and press [MENU/SET]



Setting	Effect
[EXPS] [Expressive]	This picture effect creates a pop art style picture that enhances the colour.
[RETR] [Retro]	This picture effect creates the soft appearance of a tarnished picture.
[HKEY] [High Key]	This picture effect creates a brighter and lighter toned appearance for the entire picture.
[LKEY] [Low Key]	This picture effect creates a darker sombre appearance for the entire picture to emphasise the bright portions.
[SEPI] [Sepia]	This picture effect creates a picture with sepia tone.
[MONO] [Dynamic Monochrome]	This picture effect creates a monochromatic picture with a higher contrast and more dramatic atmosphere.
[HDYN] [High Dynamic]	This picture effect creates a picture with a well-balanced brightness for the entire picture (from dark areas to bright areas).
[TOY] [Toy Effect]	This picture effect creates a picture that resembles pictures taken by a toy camera with a reduced amount of peripheral light. • About adjusting colour shade → Press the [DISP.] button and use the cursor button to select the shades of a colour.
[MINI] [Miniature Effect]	This picture effect creates a diorama-like picture by intentionally blurring the upper and lower edges of the picture. (Also known as Tilt Shift Focus)
[SOFT] [Soft Focus]	This picture effect creates a soft appearance by intentionally blurring the entire picture.

■ Changing the selected picture effects ([Creative Control] menu)

- ① Press [MENU/SET]
- ② Use cursor button to select [Creative Control] menu and press [MENU/SET]
- ③ Press ▲ ▼ to select a setting, and then press [MENU/SET]

■ Recording motion pictures in

Records a motion picture at the optimum settings for the selected effects.

- A setting that was selected in [Creative Control] mode is retained even after the camera is turned off.
- Following [Rec] menu settings will be automatically adjusted and cannot be selected manually.
[Sensitivity], [White Balance], [i.Exposure], [Min. Shtr Speed], [Color Mode]
- Notes on the [Miniature Effect] setting
 - The recording screen is displayed with a slight delay when compared to usual recording.
 - No audio is recorded for motion pictures.
 - Portrait orientation recording does not affect the blurred part. (The left and right edges will be blurred.)
 - When a motion picture is recorded, the finished recording will be approximately 1/8th of the actual recorded time period. (If you record a motion picture for 8 minutes, the resulting motion picture recording time will be approximately 1 minute.) The recordable time displayed on the camera is approx. 8 times longer than actual time needed for recording. When the recording mode is changed, be sure to check the recordable time.
 - If you stop recording motion pictures too soon, the camera may continue recording until a certain time. Hold the camera until the camera stops recording.
 - When you take a picture using a large picture size setting, the screen will become dark for a certain period of time after the picture is taken. However, this occurs due to signal processing and is not a defect.
- Notes on the [Soft Focus] setting
 - The recording screen is displayed with a slight delay when compared to usual recording. (When this effect is set, the recorded motion picture is played back like a frame dropping.)
 - When you take a picture using a large picture size setting, the screen will become dark for a certain period of time after the picture is taken. However, this occurs due to signal processing and is not a defect.

Taking pictures according to the scene

[Scene Mode]

Recording mode: P A S M C1 C2 **SCN**

Using [Scene Mode] enables you to take pictures with optimum settings (exposure, colouring, etc.) for given scenes.

1 Set mode dial to SCN

2 Use cursor button to select the scene and press [MENU/SET]

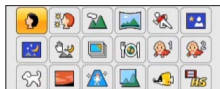

■ Changing the selected scene mode ([Scene Mode] menu)

- ① Press [MENU/SET]
- ② Use cursor button to select [Scene Mode] menu and press [MENU/SET]
- ③ Use cursor button to select the scene and press [MENU/SET]

■ Recording motion pictures in SCN





Records a motion picture at the optimum settings for the selected scene.

- Some scenes are switched to the following scenes:

Selected scene	Scenes for motion picture
[Baby]	Portrait motion picture
[Night Portrait], [Night Scenery], [Handheld Night Shot]	Low light motion picture
[Sports], [HDR], [Pet]	Normal motion picture

- Selecting a Scene Mode inappropriate for the actual scene may affect the colouring of your picture.
- Following [Rec] menu settings will be automatically adjusted and cannot be selected manually.
[Sensitivity], [Metering Mode], [i.Exposure], [Min. Shtr Speed], [i.Resolution], [Color Mode]
- Using flash in Scene Modes (→67)

- How to select a scene (→77)
- Using flash in Scene Modes (→66)

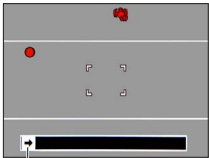
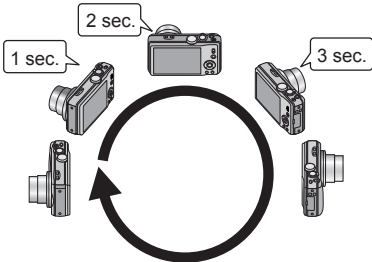
 [Portrait]	<p>Improves the skin tone of subjects for a healthier appearance in bright daylight conditions.</p> <p>Tips</p> <ul style="list-style-type: none"> • The closer the zoom is positioned to the T (telephoto) edge and the closer the camera is brought to the subject, the greater the effect will be.
 [Soft Skin]	<p>Smooths skin colours in bright, outdoor daylight conditions (portraits from chest upwards).</p> <p>Tips</p> <ul style="list-style-type: none"> • The closer the zoom is positioned to the T (telephoto) edge and the closer the camera is brought to the subject, the greater the effect will be.
 [Scenery]	<p>Takes clear pictures of wide, distant subjects.</p>
 [Panorama Shot]	<p>Creates a single panorama picture by stitching multiple still pictures taken in rapid succession.</p> <ol style="list-style-type: none"> ① Use cursor button to select the recording direction, and press [MENU/SET] to set. ② Check the recording direction and press [MENU/SET] <ul style="list-style-type: none"> • Special panorama guidelines will be displayed during recording. ③ Press the shutter button halfway to focus ④ Press the shutter button fully and pan the camera in a small circular motion in the selected direction to start recording <ul style="list-style-type: none"> • Taking pictures from left to right <div style="display: flex; align-items: center;">  <div style="margin-left: 20px;">  </div> </div> <p>Recording direction and progress status (approximate)</p> <ul style="list-style-type: none"> • Pan the camera so that you make a complete circuit in approx. 8 seconds <ul style="list-style-type: none"> - Pan the camera at a constant speed. - You may not be able to take pictures successfully if you move the camera too quickly or too slowly. - Pan the camera in a small circular motion. ⑤ Press the shutter button fully again to end recording <ul style="list-style-type: none"> • You can also end recording if you stop panning the camera while taking pictures.

- How to select a scene (→77)
- Using flash in Scene Modes (→66)

Tips

- Pan the camera in the recording direction as steadily as possible.

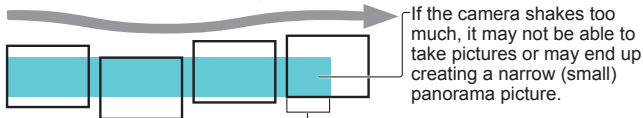

The subjects that are displayed in this range are recorded. (guideline)

Notes

- The zoom position is fixed to the W end.
- The focus, White Balance, and Exposure Compensation are all fixed to optimal values for the first picture.
If the focusing or brightness of pictures recorded as part of a Panorama picture after the first picture are significantly different from those of the first picture, the Panorama picture as a whole (when all pictures are stitched together) may not have consistent focus and brightness.
- The following functions are fixed to the settings indicated below.
[Stabilizer]: [OFF] [Date Stamp]: [OFF]
- Since several pictures are stitched together to create a Panorama picture, some subjects may be distorted or the joining portions of successively taken pictures that are stitched may be noticeable.
- The number of recording pixels per horizontal line and vertical line of a Panorama picture varies depending on the recording direction and number of stitched pictures.
The maximum number of recording pixels is as follows:
 - Taking pictures in landscape orientation: Approx. 8000 x 1080
 - Taking pictures in portrait orientation: Approx. 1440 x 8000
- Panorama pictures may not be created or pictures may not be recorded properly when taking pictures of the following subjects or when taking pictures in the following recording conditions:
 - Subjects that have a continuous monotone or pattern (sky, beach, etc.)
 - Moving subjects (person, pet, vehicle, waves, or flowers swaying in the wind, etc.)
 - Subjects whose colours or patterns change quickly (such as an image appearing on a display)
 - Dark locations
 - Locations with a flickering light source (fluorescent lamp, candle light, etc.)

About panorama playback

You can operate the zoom lever or perform touch operations to enlarge still pictures taken in [Panorama Shot] scene mode in the same way as with other still pictures. If you play back panorama pictures in the same way as playing back a motion picture, the panorama pictures are scrolled automatically. (→45)





- Unlike motion picture playback, you cannot perform fast forward or fast rewind while the panorama pictures are scrolling automatically. (You can perform single-frame forward or rewind while the automatic scrolling operation is paused.)







[Panorama Shot]

(Continued)







- How to select a scene (→77)
- Using flash in Scene Modes (→66)

 [Sports]	<p>Takes pictures of scenes with fast movement, e.g. sports.</p> <p>Tips</p> <ul style="list-style-type: none"> • Stand at least 5 m (16 feet) away. <p>Notes</p> <ul style="list-style-type: none"> • Shutter speed may slow down up to 1 second.
 [Night Portrait]	<p>Takes pictures of people and nightscapes with close to actual brightness.</p> <p>Tips</p> <ul style="list-style-type: none"> • Use flash. • Subject should not move. • Tripod, self-timer recommended. <p>Notes</p> <ul style="list-style-type: none"> • Shutter speed may slow down up to 8 seconds. • After recording, the shutter may stay closed (up to 8 seconds) to process the signal. This is not a malfunction.
 [Night Scenery]	<p>Takes clear pictures of night scenes.</p> <p>Tips</p> <ul style="list-style-type: none"> • Tripod, self-timer recommended. <p>Notes</p> <ul style="list-style-type: none"> • Shutter speed may slow down up to 8 seconds. • After recording, the shutter may stay closed (up to 8 seconds) to process the signal. This is not a malfunction.
 [Handheld Night Shot]	<p>Takes clear still pictures of night scenes with less jitter and less noise by combining a burst of still pictures.</p> <p>Tips</p> <ul style="list-style-type: none"> • Stand at least 5 m (16 feet) away. • After the shutter button has been pressed, do not move the camera during the burst operation. <p>Notes</p> <ul style="list-style-type: none"> • Since a burst of still pictures are combined after they have been recorded, it will be a few moments before you will be able to record another picture.

- How to select a scene (→77)
- Using flash in Scene Modes (→66)

 <p>[HDR]</p>	<p>The camera can combine several still pictures taken with different exposures into a single properly exposed picture with rich gradation.</p> <p>Tips</p> <ul style="list-style-type: none"> • After the shutter button has been pressed, do not move the camera during the burst operation. <p>Notes</p> <ul style="list-style-type: none"> • Since a burst of still pictures are combined after they have been recorded, it will be a few moments before you will be able to record another picture. • A subject that was in motion when it was recorded may be recorded as an afterimage. • The camera may take a single still picture instead of several pictures under certain recording conditions.
 <p>[Food]</p>	<p>Takes natural-looking pictures of food.</p>
  <p>[Baby]</p>	<p>Uses weak flash to bring out skin colours.</p> <p>■ To record age and name [Baby1] and [Baby2] can be set separately.</p> <ol style="list-style-type: none"> ① Use cursor button to select [Age] or [Name] and press [MENU/SET]. ② Select [SET] with cursor button and then press [MENU/SET]. ③ Set the birthday and name. Age: Set birthday with cursor button, and press [MENU/SET]. Name: (See "Entering Text": (→94)) ④ Use cursor button to select [Exit] and press [MENU/SET]. <p>Tips</p> <ul style="list-style-type: none"> • Make sure [Age] and [Name] are [ON] before taking a picture. <p>Notes</p> <ul style="list-style-type: none"> • Age display format depends on [Language] setting. • Shutter speed may slow down up to 1 second. • [Age] and [Name] print setting can be made on your computer using "PHOTOfunSTUDIO" on the supplied disc. Text may also be stamped onto the still picture using [Text Stamp].
 <p>[Pet]</p>	<p>Records pet's age and name when taking pictures.</p> <ul style="list-style-type: none"> • Refer to [Baby] for other tips and notes.

- How to select a scene (→77)
- Using flash in Scene Modes (→66)

 [Sunset]	<p>Takes clear pictures of scenes such as sunsets.</p>
 [High Sens.]	<p>Prevents blurring of subject in dark, indoor conditions.</p> <p>Select the aspect ratio and the picture size with cursor button and press [MENU/SET].</p>
 [Glass Through]	<p>Most suitable for taking pictures such as a landscapes through the transparent glass of a train/vehicle or building.</p> <p>Notes</p> <ul style="list-style-type: none"> • If there are stains such as dust or a reflection on the glass, the camera may focus on the glass instead of a subject. • The colour of pictures may appear unnatural due to the colour of the glass. (You may be able to reproduce the appropriate colour by adjusting the White Balance.)
 [Underwater]	<p>Takes pictures with natural colours suitable for an underwater scene.</p> <p>Tips</p> <ul style="list-style-type: none"> • For fast moving subjects, align with the AF area and press ◀ (AF Lock). (Press ◀ again to release.) <div style="display: flex; align-items: center; margin-left: 40px;"> <div style="margin-right: 10px;">[AF Lock] (focus fixed)</div>  </div> <p style="margin-left: 40px;">AF area</p> <ul style="list-style-type: none"> • If the zoom is operated after AF Lock is set, the AF Lock setting will be cancelled and must be set again. • AF Lock cannot be set if [AF Mode] is set to . <p>About [White Balance]</p> <ul style="list-style-type: none"> • You can adjust colours according to your preference by using the "White Balance fine adjustment" (→97). <p>Notes</p> <ul style="list-style-type: none"> • Always use marine case (optional). • Positioning is not possible underwater, because the GPS signals cannot reach the camera. DMC-TZ30 DMC-TZ31 • When there are many underwater objects, set the flash to .

- How to select a scene (→77)
- Using flash in Scene Modes (→66)



[High Speed Video]

Records rapid movements at a high speed of 220 fps.

- ① Press the motion picture button to start recording
- ② Press the motion picture button again to finish recording
 - Motion picture recording can also be started or finished by pressing the shutter button. (The touch shutter function will be disabled.)
 - During playback, the movements of a subject that cannot be seen by the naked eye can be made recognizable by playing back the motion pictures using slow motion.

Notes

- High-speed motion pictures cannot be recorded in the built-in memory.
- Motion pictures are recorded in Motion JPEG with a picture size of QVGA (320x240 pixels). (Up to 2 GB, about 7 minutes 20 seconds at one recording.)
- No sound is recorded.
- Still pictures cannot be recorded while high-speed motion pictures are being recorded.
- The settings for the focus, zoom, exposure and White Balance are fixed to the settings specified when recording was started.
- The Optical Image Stabiliser does not work.
- The [AF Mode] is set to  (1-area-focusing).
- Flickering or horizontal stripes may appear while recording under fluorescent lighting.

Taking 3D pictures [3D Photo Mode]

Recording mode: P A S M C1 C2 SCN

Pictures are recorded continuously while moving the camera horizontally, and two pictures selected automatically are combined to make a single 3D picture. To view 3D pictures, a television that supports 3D is required (This unit will play back in 2D). (→160)

1 Set mode dial to

- Description of recording method is displayed. Check the instructions, and then press [MENU/SET].

2 Start the recording and then pan the camera horizontally straight from left to right

- A guide is displayed while recording.
- Move the camera approximately 10 cm (0.33 feet) within approximately 4 seconds using the guide.

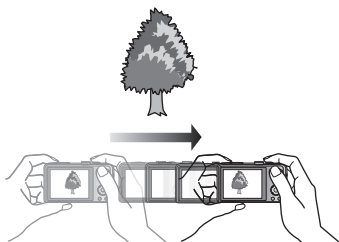

Tips for recording pictures

- Record a stationary subject.
- Record a picture outdoors or in other bright locations.
- Press the shutter button halfway to fix the focus and the exposure, press the shutter button fully, and then pan the camera.
- Hold the camera so that the subject is slightly to the right of the centre on the display at the start of the recording. This makes it easier to position the subject in the centre of the recorded picture.

- **3D still pictures cannot be recorded by holding this camera vertically.**
- 3D still pictures are recorded in MPO format (3D).
- The zoom position is fixed to the W end.
- The picture size is fixed to 2M [16-9](#).
- ISO Sensitivity is automatically adjusted. However, ISO Sensitivity is increased to make the shutter speed faster.
- Motion pictures cannot be recorded.
- When any of the recording conditions listed below exists, it may be impossible to record any images at all. Or there may be no 3D effect, or the image may be distorted even if a picture is recorded.
 - When the subject is too dark or too bright
 - When the subject's brightness changes
 - When the subject is moving
 - When pictures are recorded underwater
 - When the subject lacks contrast

Register your own settings and record

[Custom] Mode

Registering your preferred recording mode, [Rec] menu settings, etc. to [Cust.Set Mem.] and setting the mode dial to C1/ C2 allows you to switch quickly to those settings.

[Cust.Set Mem.]

Up to 4 current camera settings can be registered.

■ Recording mode:  **P** **A** **S** **M** **C1** **C2**  **SCN** 

1 Select the recording mode you wish to register and set the [Rec] menu, [Motion Picture] menu, [Setup] menu, etc.

2 Select [Cust.Set Mem.] from the [Setup] menu (→51)

3 Use cursor button to select custom set for registration and press [MENU/SET]

- A confirmation screen is displayed. Select [Yes] with cursor button and then press [MENU/SET].
- The custom settings registered in [C1] can be used with the C1 of the mode dial. It will be convenient if the custom setting used often is registered, since it can be used by just setting the mode dial.
- The custom settings registered in [C2-1], [C2-2] or [C2-3] can be selected in the C2 of the mode dial. Up to 3 custom settings can be registered, so select the one matching the needs.

- Self-timer is not stored in custom set.
- Since certain menu items would be reflected in other recording modes, they are not saved.

[Custom]

Settings registered in [Cust.Set Mem.] can be quickly called up by setting the mode dial to C1 / C2.

■ **Recording mode:** P A S M C1 C2 ED SCN

1 Set mode dial to C1 / C2 ([Custom] mode)

- When set to C1
→ The camera switches to the recording mode and settings registered in C1.
- When set to C2
→ Perform steps **2** - **3**

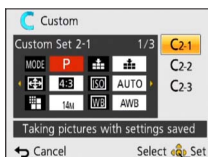
2 Use cursor button to select custom set

- Use ◀ and ▶ to confirm the registered settings.
- Only the main menu items are displayed.

3 Press [MENU/SET] to enter the settings

The camera switches to the recording mode and settings of the selected custom set.

■ When changing the menu settings

Even if the menu settings are changed temporarily when [C1], [C2-1], [C2-2] or [C2-3] is selected for using the custom set, the currently registered settings will remain unchanged.

To change the currently registered settings, overwrite the registered data using [Cust. Set Mem.] (→85) on the [Setup] menu.

■ Changing from one C2 custom setting to another C2 custom setting ([Custom] menu)

• To use a custom setting for other than the above case, operate the mode dial.

- ① Press [MENU/SET]
- ② Select [Custom] menu and press [MENU/SET]
- ③ Use ▲ ▼ to select custom set and press [MENU/SET]

■ Recording motion pictures in C1 / C2

Records motion pictures in registered recording mode.

Burst function

Recording mode: **P A S M C1 C2**

A burst of still pictures can be recorded while the shutter button is pressed fully.

1 Select **[Burst]** from the **[Rec]** menu (→51)

2 Use cursor button to select the burst setting, and press **[MENU/SET]**



Setting	Speed	Description	No. of pictures
*1	Approx. 2 - 10 pictures/sec.	<ul style="list-style-type: none">The burst speed is adjusted automatically in accordance with the movements of people, pets or other subjects. ([Intelligent Burst mode])When a fast-moving subject is recorded, the frame rate becomes faster and the number of pictures that can be recorded in a series is restricted to about 10.	100*2
	Approx. 2 pictures/sec.	<ul style="list-style-type: none">The subject is brought into focus as far as this is allowed by the burst speed. The pictures are taken with the burst function while the exposure and White Balance are being adjusted. (However, when the burst function is operating during motion picture recording, the focus is fixed to the first picture.)The burst speed may be reduced under certain recording conditions.	100*2
	Approx. 5 pictures/sec.		
	Approx. 10 pictures/sec.	<ul style="list-style-type: none">Focus, exposure and White Balance are fixed in the first picture.	10
	40 pictures/sec.	<ul style="list-style-type: none">Focus, exposure and White Balance are fixed in the first picture.Note on the picture size setting (→88)	40
	60 pictures/sec.	<ul style="list-style-type: none">Focus, exposure and White Balance are fixed in the first picture.The recordable range is reduced.Note on the picture size setting (→88)	60
*3	Complies with recording conditions	<ul style="list-style-type: none">The burst of still pictures can be recorded even in low light conditions as the flash is used. ([Flash Burst])The focus, exposure, and flash level are all fixed to the settings for the first picture.Note on the picture size setting (→88)	5
[OFF]	—	The burst function is released.	—













*1 Only in the **IA** mode

*2 The number of burst pictures is limited by the picture-taking conditions and the type and/or status of the card used.

*3 Only in the **P, A, S** mode

■ Note on the picture size setting

[Aspect Ratio]			
4:3	5 M, 3 M, 0.3 M	2.5 M, 0.3 M	3 M
3:2	4.5 M, 2.5 M, 0.3 M	3 M, 0.3 M	2.5 M
16:9	3.5 M, 2 M, 0.2 M	3.5 M, 0.2 M	2 M
1:1	3.5 M, 2.5 M, 0.2 M	2 M, 0.2 M	2.5 M

- Pictures taken with the  or  setting are recorded together as a group (burst group). (→109)
- Depending on changes in the brightness of the subject, the second and subsequent pictures may be recorded brighter or darker when using the burst function at the ,  or  setting.
- Burst speed may be reduced if shutter speed is reduced in darker locations.
- The pictures taken using the burst function at the  or  setting may be distorted if the subjects were moving or the camera was moved.
- [Auto Bracket] is released.
- The flash is set to  [Forced Flash Off]. (However, when  [Flash Burst] is selected, the flash is fixed to  [Forced Flash On].)
- Settings will be stored even if power is turned off.
- The burst function cannot be used in the following cases:
 - [Creative Control] Mode ([Toy Effect] [Miniature Effect] [Soft Focus])
 - Scene Modes ([Panorama Shot] [Handheld Night Shot] [HDR] [High Speed Video])
- When the scene mode is set to [Night Portrait], [Night Scenery] or [High Sens.], , or  cannot be selected.
- When [Selftimer] is set, 3 pictures are taken. (When [Flash Burst] is set, 5 pictures are taken.)
- It may take a while to store still pictures that were taken using the burst function. If you continue to record while storing, the number of burst pictures that can be taken will be reduced.
- You cannot use zoom during burst recording.

Recording with the Face Recognition function

[Face Recog.]

Recording mode:          

- Default [Face Recog.] setting is [OFF].
- When the face pictures are registered, the setting will be [ON] automatically.

■ How the Face Recognition function works

During recording

(When [AF Mode] is  (Face Detection))

- The camera recognises a registered face and adjusts focus and exposure.
- When registered faces that have set names are recognised, the names are displayed (up to 3 people).

During playback

- The name and age are displayed (if information is registered).
- The names that have been set for the recognised faces are displayed (up to 3 people).
- Only pictures of the selected registered people are played back ([Category Selection]).

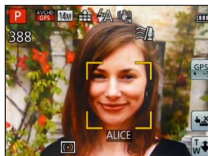

■ Recording tips when registering face pictures

- Make sure the subject's eyes are open and mouth closed; have the subject face the camera directly, and make sure the outline of the face, the eyes and eyebrows are not hidden by hair.
- Make sure there are no heavy shadows on the face. (During registration, the flash is not used.)

■ If the camera seems to have difficulty recognising faces when recording

- Register additional pictures of the same person's face, indoors and outdoors or with different expressions or angles.
- Register additional pictures at the place you are recording.
- If a registered person is no longer recognised, re-register that person.

- When Burst is performed, recording information relating to Face Recognition is put only on the first picture.
- If you press the shutter button halfway, then point the camera at a different subject and record, recording information for a different person may be put on the picture.
- Face Recognition does not work in the following cases:
 - [Creative Control] Mode ([Miniature Effect] [Soft Focus])
 - Scene Modes ([Panorama Shot] [Night Scenery] [Handheld Night Shot] [Food] [Underwater])
 - Motion picture
- Face Recognition searches for faces similar to those registered, but there is no guarantee it will always recognise these faces. In some cases, the camera cannot recognise or incorrectly recognises even registered people depending on their expression or the environment.
- Even if Face Recognition information is registered, pictures recorded when the name is [OFF] are not categorised for Face Recognition in [Category Selection].
- **Even if Face Recognition information is changed, Face Recognition information for previously recorded pictures is not changed.**
For example, if a name is changed, pictures recorded before the change are not categorised for Face Recognition in [Category Selection].
- To change name information for pictures already recorded, perform a [REPLACE] (→126) in [Face Rec Edit].

Registering face pictures

Up to 6 people's face pictures can be registered along with such information as name and birthdate.

You can facilitate Face Recognition by the way you register faces: for example, register multiple face pictures of the same person (up to 3 pictures in one registration).

1 Select [Face Recog.] from the [Rec] menu (→51)

2 Select [MEMORY] with cursor button and then press [MENU/SET]

3 Select [New] with cursor button and then press [MENU/SET]
 • If 6 people are already registered, first delete a registered person. (→91)

4 Record the face picture

- ① Align the face with the guide and record.
- ② Select [Yes] with cursor button and then press [MENU/SET].
 - If re-recording, select [No]
 - Faces of subjects other than people (e.g. pets) cannot be registered.
 - When [DISP.] button is pressed, an explanation is displayed.



5 Use cursor button to select the item for editing and press [MENU/SET]

[Name]	<ol style="list-style-type: none"> ① Select [SET] with cursor button and then press [MENU/SET] ② Enter the name (Entering text →94)
[Age]	Set the birthdate. <ol style="list-style-type: none"> ① Select [SET] with cursor button and then press [MENU/SET] ② Use ◀▶ to select year, month and day, set with ▲▼, and press [MENU/SET]
[Focus Icon]	Change the icon that is displayed when the subject is in focus. <ol style="list-style-type: none"> ① Select the focus icon with cursor button and then press [MENU/SET]
[Add Images]	Up to 3 face pictures of the person can be registered. <ol style="list-style-type: none"> ① Select an unregistered frame and press [MENU/SET] <ul style="list-style-type: none"> • When a registered face picture is selected with cursor button, a screen to confirm deletion is displayed. Select [Yes] to delete the face picture. (If only one picture is registered, it cannot be deleted.) ② Record the picture (Step 4 above.) ③ Press [⏏ / ↵] button

Editing or deleting information about registered persons

Information about registered people can be edited or deleted.

- 1** Select [Face Recog.] from the [Rec] menu (→51)
- 2** Select [MEMORY] with cursor button and then press [MENU/SET]
- 3** Use cursor button to select the face picture to be edited or deleted
- 4** Use cursor button to select the item and press [MENU/SET]

[Info Edit]	Edit name or other registered information. (→90)
[Priority]	Set priority order for focus and exposure. ① Select the registration order with cursor button and then press [MENU/SET]
[Delete]	Delete information and face pictures of registered persons.

Useful features for travel

[Travel Date]

- For [Setup] menu setting procedures (→51)

If you set your travel schedule and record pictures, the day of your trip on which the picture was taken will be recorded.

■ **Recording mode:** *

* Recording only. (Cannot set.)

- 1** Select [Travel Date] from the [Setup] menu (→51)
- 2** Use cursor button to select [Travel Setup] and press [MENU/SET]
- 3** Use cursor button to select [SET] and press [MENU/SET]
- 4** Use cursor button to select the departure date and press [MENU/SET]
- 5** Use cursor button to select the return date and press [MENU/SET]

■ To record [Location]

Once the [Travel Setup] is set, you can set the location.

- ① Select [Location] in step **2** above
- ② Use cursor button to select [SET] and press [MENU/SET]
- ③ Enter your location (Entering text →94)

- The travel date is calculated from the set departure date and the date set in the camera's clock. When destination is set in [World Time], days elapsed are calculated based on local destination time.
- When [Travel Setup] is set to [OFF], the number of days elapsed is not recorded. It is not displayed even if [Travel Setup] is set to [SET] after recording.
- If settings are made before departure date, number of days to departure are not recorded.
- [Location] is recorded separately from the location name information which is recorded on the pictures by the GPS function. **DMC-TZ30** **DMC-TZ31**
- To print [Location] or the number of days that have passed, either use [Text Stamp] or print using the software "PHOTOfunSTUDIO" on the supplied disc.
- [Travel Date] cannot be recorded for AVCHD motion pictures recorded when [Rec Quality] is set to [PSH], [FSH] or [SH].

[World Time]

• For [Setup] menu setting procedures (→51)
Set the recording date and time with the local time at your destination.

■ **Recording mode:** 

■ **Preparation:** Set [Auto Clock Set] to [OFF]. (→140)

1 Select [World Time] from the [Setup] menu (→51)

• Message will be displayed when setting for the first time. In this case, press [MENU/SET] and skip to step 3.

2 Use cursor button to select [Destination] and press [MENU/SET]

3 Use cursor button to select area and press [MENU/SET]



When [Destination] has been selected

■ To set summer time

Press ▲ in step 3. (Press again to release the setting)

• When summer time is set, the current time is advanced by 1 hour. If the setting is cancelled, the time automatically returns to the current time.

■ When you come back from your travel destination

Select [Home] in step 2 and press [MENU/SET].

- If you cannot find your destination in the area displayed on the screen, set based on difference with home time.
-  is displayed on the screen for pictures recorded at the destination when they are played back.
- When [Auto Clock Set] is set to [ON], you cannot change the area of [Destination]. (You can only change the summer time setting of [Destination].) **DMC-TZ30** **DMC-TZ31**

Entering Text

Use the cursor button to enter names with the Face Recognition function and in Scene Modes [Baby] and [Pet], or to register locations in [Travel Date] etc.

1 Use cursor button to select characters

2 Press [MENU/SET] several times until the desired character is displayed

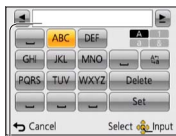



Text is inserted at the cursor position.

- To change the character type
→ Select , and press [MENU/SET].

Cursor position

■ Editing text

- ① Use cursor button to select   and press [MENU/SET]. Then, move the cursor to the text to edit
 - You can also use the zoom lever to reposition the cursor.
- ② Use cursor button to select [Delete], and then press [MENU/SET]
- ③ Use cursor button to select the correct text, and then press [MENU/SET]

3 When you are finished entering text, use cursor button to select [Set] and press [MENU/SET]

- A maximum of 30 characters can be entered. (Maximum of 9 characters for [Face Recog.] names)

Using the [Rec] menu

[Aspect Ratio]

- For [Rec] menu setting procedures (→51)

Set the aspect ratio of still pictures.

■ Recording mode: **IA** **P** **A** **S** **M** **C1** **C2** **ED** **SCN** **🔄**

■ Settings: **4:3** / **3:2** / **16:9** / **1:1**

- Edges may be cut off when printing – be sure to check in advance.

[Picture Size]

- For [Rec] menu setting procedures (→51)

Set the size (number of pixels) of still pictures. Number of pictures which can be recorded depends on this setting and on [Quality].

■ Recording mode: **IA** **P** **A** **S** **M** **C1** **C2** **ED** **SCN** **🔄**

■ Settings:

Picture Size ([Aspect Ratio]: 4:3)					
14 M 4320×3240	10 M 🔄 * 3648×2736	7 M 🔄 * 3072×2304	5 M 🔄 2560×1920	3 M 🔄 * 2048×1536	0.3 M 🔄 640×480

Picture Size ([Aspect Ratio]: 3:2)					
12.5 M 4320×2880	9 M 🔄 * 3648×2432	6 M 🔄 * 3072×2048	4.5 M 🔄 * 2560×1712	2.5 M 🔄 * 2048×1360	0.3 M 🔄 * 640×424

Picture Size ([Aspect Ratio]: 16:9)					
10.5 M 4320×2432	7.5 M 🔄 * 3648×2056	5.5 M 🔄 * 3072×1728	3.5 M 🔄 * 2560×1440	2 M 🔄 * 1920×1080	0.2 M 🔄 * 640×360

Picture Size ([Aspect Ratio]: 1:1)					
10.5 M 3232×3232	7.5 M 🔄 * 2736×2736	5.5 M 🔄 * 2304×2304	3.5 M 🔄 * 1920×1920	2.5 M 🔄 * 1536×1536	0.2 M 🔄 * 480×480

* This setting is not available in **IA** ([Intelligent Auto] Mode).

- Mosaic effect may appear depending on subject and recording conditions.

Setting guide

Larger picture size	← →	Smaller picture size
Crisper picture		Coarser picture
Lower recording capacity		Higher recording capacity

[Quality]

- For [Rec] menu setting procedures (→51)
Set quality of picture.

■ **Recording mode:** **P A S M C1 C2**

■ **Settings:** ((Fine)) High quality, priority to picture quality

((Standard)) Standard quality, priority to the number of pictures

- The setting is fixed to in [High Sens.] Scene Mode.

- When [3D Photo Mode] is selected, the displayed icons are different:

(([3D+Fine])): An MPO picture and a high quality JPEG picture are recorded simultaneously.

(([3D+Standard])): An MPO picture and a standard quality JPEG picture are recorded simultaneously.

[Sensitivity]

- For [Rec] menu setting procedures (→51)
Set ISO Sensitivity (sensitivity to lighting) manually.
We recommend higher settings to take clear pictures in darker locations.

■ **Recording mode:** **P A S M C1 C2**

■ **Settings:** [AUTO] / **ISO** [Intelligent ISO] / [100] / [200] / [400] / [800] / [1600] / [3200]

Setting guide

[Sensitivity]	[100] ←→ [3200]
Location (recommended)	Bright (outdoors) Dark
Shutter speed	Slow Fast
Interference	Low High
Subject blur	High Low

- [AUTO] is automatically set in a range up to 800 (1600 when flash is used) based on subject brightness.
- **ISO** [Intelligent ISO] is automatically set in a range up to 1600 based on subject movement and brightness.
- The [Sensitivity] is automatically set in the following cases:
 - When recording motion pictures
 - When [Burst] is set to [Flash Burst]

[White Balance]

- For [Rec] menu setting procedures (→51)
Adjust colouring to suit light source if colours otherwise appear unnatural.
- **Recording mode:**
- **Settings:** [AWB] (automatic) / (outdoor, clear sky) / (outdoor, cloudy sky) / (outdoor, shade) / (Incandescent lighting) / (uses value set in _SET) / _SET (set manually)
- When [AWB] (Automatic White Balance) is set, the colouring is adjusted in accordance with the light source. However, if the scene is too bright or too dark or if other extreme conditions apply, the pictures may appear reddish or bluish. The White Balance may not operate correctly if there is a multiple number of light sources.
- Under fluorescent lighting, LED lighting fixture etc., the appropriate White Balance will vary depending on the lighting type, so use [AWB] or _SET.
- White Balance setting is fixed to [AWB] in the following cases:
Scene Modes ([Scenery], [Night Portrait], [Night Scenery], [Handheld Night Shot], [Food], [Sunset], [Underwater])
- Even if the camera's power is OFF, the set White Balance is remembered. (If the Scene Mode is changed, the white balance setting returns automatically to [AWB].)
- **White Balance fine adjustment (excluding [AWB])**
White Balance settings can be individually fine-tuned if colours still do not appear as anticipated.
 - ① Select the white balance to be fine-tuned, and press the [DISP.] button to display the [WB Adjust.] screen
 - ② Adjust with if red is strong, adjust with if blue is strong.
 - ③ Press [MENU/SET]
 - Settings are remembered even if power is turned off.
 - Settings remain applied when using flash.
 - Even though the [AWB] setting is fixed in [Underwater] Scene Mode, fine adjustments may still be made.
 - Fine adjustments cannot be made when [Color Mode] (→103) is set to [B&W] or [SEPIA].

■ Setting White Balance manually ( SET)

① Select  SET and press [MENU/SET]

② Point the camera towards a white object (e.g. paper) and press [MENU/SET]

White Balance is set to .

- Even if the camera's power is OFF, the set White Balance is remembered.
- It may not be possible to set the correct White Balance if subjects are too bright or too dark. In this case, adjust the brightness and try to set the White Balance again.

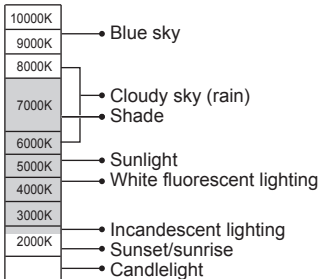
■ [AWB] operational range: 



[AF Mode]













- For [Rec] menu setting procedures (→51)

Method of aligning focus can be changed according to position and number of subjects.





■ Recording mode: **[A]** **[P]** **[AS]** **[M]** **[C]** **[C2]** **[SD]** **[SCN]** **[S]**

■ Settings: **[Face]** / **[AF Tracking]** / **[23-area]** / **[1-area]** / **[Spot]**

<p>Taking front-on pictures of people</p> <p>[Face] (Face Detection)</p>	<p>Recognises faces (up to 15 people) and adjusts exposure and focus accordingly.</p>  <p>AF area Yellow: When the shutter button is pressed halfway, the frame turns green when the camera is focused. White: Displayed when more than one face is detected. Other faces that are the same distance away as faces within the yellow AF area are also focused.</p>
<p>Automatically locking the focus on a moving subject</p> <p>[AF Tracking]</p>	<p>Touch the subject</p>  <p>AF Tracking frame When the subject is recognised, the AF Tracking frame changes from white to yellow, and the subject is automatically kept in focus. If AF Lock fails, a red frame flashes.</p> <ul style="list-style-type: none"> • Perform these operations with the touch shutter function (→29) released. • To release AF Tracking → Touch [Release]. • Focus range (same as macro recording) (→68) • You can also use [Down Arrow] to perform this function.
<p>Subject not centred in picture</p> <p>[23-area] (23-area-focusing)</p>	<p>Focuses on up to 23 points.</p>
<p>Determined position for focus</p> <p>[1-area] (1-area-focusing) [Spot] (Spot-focusing)</p>	<p>1-area-focusing: Focuses on AF area in centre of picture. (Recommended when focus is difficult to align) Spot-focusing: Focuses on smaller, limited area.</p>

- Focus is fixed to  (1-area-focusing) in the following cases:
 - [High Speed Video] scene mode
 - [Miniature Effect] in [Creative Control] mode
- Use  (1-area-focusing) if focus is difficult to align with  (Spot-focusing).
- Cannot set to  (Face Detection) in the following cases:
 - Scene Modes ([Panorama Shot] [Night Scenery] [Handheld Night Shot] [Food] [Underwater])
 - [Creative Control] Mode ([Soft Focus])
- If the camera misinterprets a non-human subject as a face in  (Face Detection) setting, switch to another setting.
- If conditions prevent the face from being recognised, such as when the movement of the subject is too rapid, the [AF Mode] setting switches to  (23-area-focusing).
- Under certain recording conditions, such as when the subject is small or dark,  (AF Tracking) may not operate correctly.
- When  (AF Tracking) does not work, focus will be on  (23-area-focusing).
- Cannot set to  (AF Tracking) in the following cases.
 - [Panorama Shot] Scene Mode
 - [B&W] and [SEPIA] in [Color Mode]
 - [Creative Control] Mode ([Sepia] [Dynamic Monochrome] [High Dynamic] [Toy Effect] [Soft Focus])
- When  (23-area-focusing) or  (Spot-focusing) is set, the [AF Mode] setting at the time of motion picture recording switches to  (1-area-focusing).

[Quick AF]

- For [Rec] menu setting procedures (→51)
- The focus is automatically adjusted when camera blurring is small even when the shutter button is not pressed. (Increases battery consumption)
- **Recording mode:**  **P A S M C1 C2**   
- **Settings:** [ON] / [OFF]
- Focus alignment may take time if zoom is suddenly changed from max. W to max. T, or if suddenly moving closer to subject.
 - Press shutter button halfway if focus is difficult to align.
 - The function will turn [OFF] in the following cases.
 - [Night Portrait], [Night Scenery], [Handheld Night Shot] and [High Speed Video] Scene Modes
 - [Quick AF] will not work while AF Tracking is operating.

[Face Recog.]

- For [Rec] menu setting procedures (→51)
For details (→89).

[Metering Mode]

- For [Rec] menu setting procedures (→51)
You can change the position for measuring brightness when correcting exposure.

■ Recording mode: **P A S M C1 C2** ED SCN

■ Settings:

[Metering Mode]	Brightness measurement position	Conditions
[Multi Metering]	Whole screen	Normal usage (produces balanced pictures)
[Center Weighted]	Centre and surrounding area	Subject in centre
[Spot]	Centre and close surrounding area	Great difference between brightness of subject and background (e.g. person in spotlight on stage, backlighting)

[i.Exposure]

- For [Rec] menu setting procedures (→51)
Automatically adjusts contrast and exposure to give more lifelike colours when there is significant contrast between background and subject.

■ Recording mode: **P A S M C1 C2** ED SCN

■ Settings: [LOW] / [STANDARD] / [HIGH] / [OFF]

- [LOW], [STANDARD] and [HIGH] indicate the maximum range of correction.
- When [i.Exposure] works, the colour of changes.
- Even if [Sensitivity] is set to [100], when [i.Exposure] is activated, pictures may be taken at a higher ISO Sensitivity than the setting.

[Min. Shtr Speed]

- For [Rec] menu setting procedures (→51)

Sets shutter speed to minimum. We recommend using slower shutter speeds to take brighter pictures in dark locations.

■ **Recording mode:** **P** **A** **S** **M**

■ **Settings:** [AUTO] [1/250] [1/125] [1/60] [1/30] [1/15] [1/8] [1/4] [1/2] [1]

- Slower shutter speeds allow for brighter pictures but increase risk of jitter, so we recommend using a tripod and the self-timer.
- As still pictures may become dark when using faster values such as [1/250], we recommend that still pictures are taken in bright locations (flashes red when shutter button is pressed halfway if still picture will be dark).
- displayed on screen for settings other than [AUTO].

[i.Resolution]

- For [Rec] menu setting procedures (→51)

You can use the camera's Intelligent Resolution technology to record still pictures with sharper outlines and clearer resolution. Also, when [i.ZOOM] is set, the zoom ratio can be increased two times higher than the original zoom ratio with limited deterioration of picture quality.

■ **Recording mode:** **P** **A** **S** **M**

■ **Settings:** [ON] / [i.ZOOM] / [OFF]

- About [i.ZOOM] (→65)

[Digital Zoom]

- For [Rec] menu setting procedures (→51)

Zoom 4 times further than Optical/Extra optical zoom. (Note that enlarging will decrease picture quality with Digital Zoom.)

■ **Recording mode:** **P** **A** **S** **M**

■ **Settings:** [ON] / [OFF]

- This is fixed to [ON] when [Macro Zoom] is set.
- When Digital Zoom is used simultaneously with i.Zoom, you can only increase the zoom ratio up to 2 times.

[Burst]

- For [Rec] menu setting procedures (→51)
For details (→87).

[Color Mode]

- For [Rec] menu setting procedures (→51)
Set colour effects.

■ **Recording mode:** **P A S M C1 C2**

■ **Settings:** **[STANDARD]** / **[VIVID]*1** (sharper) / **[B&W]** / **[SEPIA]** / **[Happy]*2**

*1 Except [Intelligent Auto] Mode

*2 [Intelligent Auto] Mode only

[AF Assist Lamp]

- For [Rec] menu setting procedures (→51)
Illuminates lamp when dark to facilitate focus alignment.

■ **Recording mode:** **P A S M C1 C2**

■ **Settings:** **[ON]** : Lamp illuminated with halfway press of shutter button (appears)

[OFF] : Lamp off (taking pictures of animals in the dark, etc.)

- The AF Assist Lamp has an effective distance of 1.5 m (4.9 feet).
 - Do not block the lamp with your fingers or look at it from close range.
- The setting is fixed to [OFF] in the following Scene Modes:
[Scenery] [Night Scenery] [Handheld Night Shot] [Sunset]
[Glass Through] [Underwater] [High Speed Video]



AF Assist Lamp

[Red-Eye Removal]

- For [Rec] menu setting procedures (→51)

Automatically detects red-eye and corrects still picture data when recording with flash red-eye reduction (⚡AⓄ ⚡SⓄ).

■ **Recording mode:** **P** **A** **S** **M** **C1** **C2** **SCN**

■ **Settings:** [ON] / [OFF]

- This setting will work only when [AF Mode] is (Face Detection).
- Depending on the circumstance, it may not be possible to correct red-eye.
- When the function setting is [ON], a appears with the flash icon.

[Stabilizer]

- For [Rec] menu setting procedures (→51)

Automatically detects and prevents jitter.

When recording motion pictures, [Active Mode] (stabiliser for motion pictures) will automatically function. This decreases the jitter of the image when recording motion pictures while walking, etc.

■ **Recording mode:** **P** **A** **S** **M** **C1** **C2** **SCN**

■ **Settings:** [ON] / [OFF]

- The setting is fixed to [ON] in [Handheld Night Shot] Scene Mode.
- The setting is fixed to [OFF] in the following Scene Modes:
 - [Panorama Shot] Scene Mode
 - [High Speed Video] Scene Mode
- Cases where Optical Image Stabiliser may be ineffective: Heavy jitter, high zoom ratio (also in the Digital Zoom range), fast-moving objects, indoors or in dark locations (due to low shutter speed)
- In [Active Mode], stronger effect of the correction can be achieved at the W end.
- In the following case, [Active Mode] will not function even when recording motion pictures.
 - When recording mode is set to [VGA] in [MP4].

[Date Stamp]

- For [Rec] menu setting procedures (→51)

Still pictures can be taken with the recording date and time stamped on the still picture.

■ **Recording mode:**          

■ **Settings:** [W/O TIME] / [WITH TIME] / [OFF]

- Date stamps on still pictures cannot be erased.
- The date cannot be stamped when [Auto Bracket] or [Burst] is set, when recording a motion picture, or when the [Panorama Shot] or [High Speed Video] Scene Modes are set.
- Do not request date printing in store or make date printing on printer for still pictures with date stamps. (Date printing may be overlapping.)
- Cannot change the setting in [Intelligent Auto] Mode. The setting in other Recording Mode is applied.

[Clock Set]

- For [Rec] menu setting procedures (→51)

Set the clock. Same function as that in [Setup] menu. (→23)

Using the [Motion Picture] menu

[Rec Mode]

- For [Motion Picture] menu setting procedures (→51)
Sets the data format of the motion picture that is recorded.

■ **Recording mode:**          

■ **Settings:**

[AVCHD]	• This is a data format suitable for playback on high-definition TVs.
[MP4]	• This data format is suited for playing back motion pictures on a computer and other such devices.

- For details (→38)

[Rec Quality]

• For [Motion Picture] menu setting procedures (→51)
Sets the picture quality of the motion picture that is recorded.

■ Recording mode:

■ Settings:

[AVCHD] in [Rec Mode]

DMC-TZ30 **DMC-TZ31**

Item	Picture size/Bit rate	fps	[Aspect Ratio]
[GPH]	1920×1080 pixels/Approx. 28 Mbps	50p	16:9
[PSH]*			
[GFS]	1920×1080 pixels/Approx. 17 Mbps	50i	
[FSH]*			
[GS]	1280×720 pixels/Approx. 17 Mbps	50p	
[SH]*			

* Even if positioning is executed successfully using the GPS function, the location information and place name information are not recorded.

DMC-TZ27

Item	Picture size/Bit rate	fps	[Aspect Ratio]
[PSH]	1920×1080 pixels/Approx. 28 Mbps	50p	16:9
[FSH]	1920×1080 pixels/Approx. 17 Mbps	50i	
[SH]	1280×720 pixels/Approx. 17 Mbps	50p	

[MP4] in [Rec Mode]

Item	Picture size/Bit rate	fps	[Aspect Ratio]
[FHD]	1920×1080 pixels/Approx. 20 Mbps	25	16:9
[HD]	1280×720 pixels/Approx. 10 Mbps		4:3
[VGA]	640×480 pixels/Approx. 4 Mbps		

● What is bit rate

This is the volume of data for a definite period of time, and the quality becomes higher when the number gets bigger. This unit is using the “VBR” recording method. “VBR” is an abbreviation of “Variable Bit Rate”, and the bit rate (volume of data for definite period of time) is changed automatically depending on the subject to record. Therefore, the recording time is shortened when a subject with fast movement is recorded.

● Motion pictures recorded using [High Speed Video] Scene Mode are recorded in Motion JPEG with a picture size of QVGA (320×240 pixels).

[Continuous AF]

- For [Motion Picture] menu setting procedures (→51)

Either allow the focus to be constantly adjusted during motion picture recording, or fix the focus position at the start of recording.

■ **Recording mode:**  **P A S M C1 C2**   

■ **Settings:** [ON]

[OFF]: Fix focus position at the start of motion picture recording.

[Wind Cut]

- For [Motion Picture] menu setting procedures (→51)

Automatically detects wind sounds (wind noise) captured by the microphone and suppresses the sound if the wind is blowing too strongly.

■ **Recording mode:**  **P A S M C1 C2**   

■ **Settings:** [AUTO] / [OFF]

- When [Wind Cut] is set to [AUTO], the sound quality may differ from that of normal recordings.
- The setting is fixed to [OFF] in the following cases:
 - [Miniature Effect] of the [Creative Control] Mode
 - [High Speed Video] scene mode

Playing back still pictures recorded using the burst function

Pictures taken with the or setting are recorded together as a group (burst group).

■ Representative picture display

A representative picture (first burst picture) is displayed when it is displayed together with other still pictures or with motion pictures.



Number of burst pictures

- All the still pictures in a burst group can be deleted or edited together.
- Continuous playback can be performed using the same operations as for motion pictures. (→45)

■ Display within each burst group

Still pictures recorded by a single burst can be displayed separately or as a list.

1

Touch while the representative first burst picture is being displayed

The display within each burst group appears on the screen.



- You can also display still pictures within each burst group using .

On the display within each burst group, only the series of burst still pictures are displayed.

- To return to the representative screen display
→ Touch (or press .

■ Re-acquiring the burst group information

When the power is turned on, the (acquiring information icon) may appear.

While is displayed, pictures cannot be deleted and the [Playback] menu cannot be used. Only [Normal Play] or [Calendar] is available as the [Playback Mode].

Playing back still pictures recorded using the burst function

- [Playback] menu items cannot be used while the display appears within each burst group.
- Burst pictures cannot be displayed as a burst group during [GPS Area Play] **DMC-TZ30** **DMC-TZ31** or [Favorite] playback with [Slide Show] or [Filtering Play].
- The following operation cannot be performed while a representative first burst picture is being displayed.
 - [Auto Retouch] • [Creative Retouch]
 - [Cropping] of [Playback] menu
- Burst pictures recorded after the total number of still pictures has exceeded 50,000 will not be grouped.

If only one still picture is left over in a burst group after deletion or other operations, it will not be formed into a group, either.
- The burst pictures recorded by another device may not be recognised as burst group pictures.
- Burst pictures will not be grouped if recorded without setting the clock.

Different playback methods [Playback Mode]

Recorded pictures can be played back in a variety of ways.

1 Press [MENU/SET] in playback mode

The menu selection screen is displayed.

2 Use cursor button to select [Playback Mode] menu and press [MENU/SET]

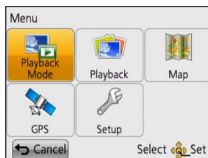

• The menu type can also be selected by touch operations.

3 Use cursor button to select the playback method and press [MENU/SET]

[Normal Play]	Plays back all pictures. (→42)
[2D/3D Settings]	Switches the output format between 2D and 3D pictures. (Only available during HDMI output.) (→160)
[Slide Show]	Automatically plays back recorded pictures, one after another. (→112)
[Filtering Play]	Plays back the pictures after narrowing them down according to various conditions. (→114)
[Calendar]	Displays the pictures according to the date on which they were taken. (→114)

- When no card is inserted, pictures are played back from the built-in memory.
- The [Playback Mode] automatically becomes [Normal Play] when the REC/PLAY switch is set to  and the power is turned on, or when switching from recording mode to playback mode.

[2D/3D Settings]

- For switching [Playback Mode] (above)

The playback method for the 3D pictures can be switched. This menu is only displayed during HDMI output. For the procedure for playing back a 3D still picture (→160).

[Slide Show]

- For switching [Playback Mode] (→111)

Automatically play pictures in order and to music. Recommended when viewing on TV screen.

1 Use cursor button to select the playback method and press [MENU/SET]

[All]	Play all.
[Picture Only]	Plays back still pictures.
[Motion Pic. Only]	Plays back motion pictures.
[3D Play]	Plays back only 3D still pictures that were recorded in [3D Photo Mode].
DMC-TZ30 DMC-TZ31 [GPS Area Play]	Selects place name or landmark to play back pictures recorded in the same place. (Use cursor button to select place name or landmark and press [MENU/SET].)
[Travel]	Play only pictures that were recorded with the [Travel Setup] or [Location]. (→114)
[Category Selection]	Select category and play back motion or still pictures. (Select category with cursor button and press [MENU/SET].) (→114)
[Favorite]	Play back pictures set as [Favorite]. (→123)

2 Use cursor button to set playback effects and press [MENU/SET]

[Effect] (Select music and effects according to picture atmosphere)	
[AUTO] (only available with [Category Selection] setting) / [NATURAL] / [SLOW] / [SWING] / [URBAN] / [OFF]*	
[Setup]	
[Duration]*	[1SEC] / [2SEC] / [3SEC] / [5SEC] (Only available when [Effect] is [OFF])
[Repeat]	[ON] / [OFF]
[Sound]	[OFF]: Music and audio will not play back. [AUTO]: With still pictures, music will play back, and with motion pictures, audio will play back. [Music]: Music effect will play back. [Audio]: Audio is played back from motion pictures.

* In the following case, [Effect] is fixed to [OFF]. The [Duration] setting is also disabled.

- [Motion Pic. Only]
- [Burst] of [Category Selection]

3 Select [Start] with cursor button and press [MENU/SET]

■ Operations during Slide Show

The operation guide appears on the bottom right of the LCD monitor.

- If you do not perform any operation for approx. 2 seconds, the operation guide is turned off. To display the guide again, press the [DISP.] button.

During motion picture/burst group/
panorama picture playback

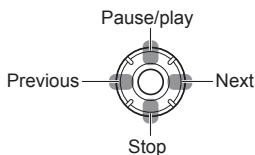

During still picture playback

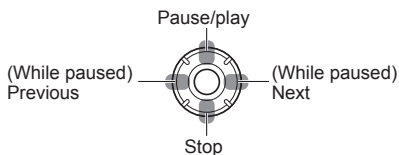































































- When [URBAN] has been selected, the picture may appear in black and white as a screen effect.
- When panorama pictures are played back, the [Duration] setting is disabled.
- Part of [Effect] cannot be used when displaying pictures on television using an HDMI mini cable (optional) or when displaying pictures recorded in portrait position.
- Screen effects do not operate during a [3D Play] slide show.
- Music effects cannot be added.

[Filtering Play]

- For switching [Playback Mode] (→111)

You can refine the selection of pictures to be viewed by narrowing them down to pictures in selected categories or to favourite pictures, and then view those pictures.

1 Select the filtering method using cursor button, and press [MENU/SET]

[Picture Only]	Play back still pictures																				
[Video Only]	Play back motion pictures																				
[3D Play]	Play back only 3D still pictures that were recorded in [3D Photo Mode].																				
DMC-TZ30 DMC-TZ31 [GPS Area Play]	<p>Select the location name of the place where the pictures were taken or the landmark name, and play the pictures back.</p> <p>① Select the region whose pictures are to be played back using cursor button, and press [MENU/SET].</p> <p>② Select the location name or landmark name using cursor button, and press [MENU/SET].</p>																				
[Travel]	<p>Play back pictures with [Travel Date] that have been set at the time of their recording.</p> <p>① Select whether to play back the pictures by date or by travel location using cursor button, and press [MENU/SET].</p> <ul style="list-style-type: none"> • When [All] is selected, the pictures recorded with [Travel Date] are played back. <p>② Select the date or travel location using cursor button, and press [MENU/SET].</p>																				
[Category Selection]	<p>Play back pictures that have been narrowed down by category, such as Scene Mode.</p> <p>① Select the category using cursor button, and press [MENU/SET].</p> <table border="1"> <tr> <td></td> <td>Pictures taken using Face Recognition</td> </tr> <tr> <td></td> <td>[Portrait] /  [Soft Skin] / [Night Portrait] /  [Baby] / </td> </tr> <tr> <td></td> <td>[Scenery] /  [Panorama Shot] / [Sunset] /  [Glass Through]</td> </tr> <tr> <td></td> <td>[Night Portrait] /  [Night Scenery] /  [Handheld Night Shot] / </td> </tr> <tr> <td></td> <td>[Sports]</td> </tr> <tr> <td></td> <td>[Baby] / </td> </tr> <tr> <td></td> <td>[Pet]</td> </tr> <tr> <td></td> <td>[Food]</td> </tr> <tr> <td></td> <td>[Underwater]</td> </tr> <tr> <td></td> <td>[Burst] ( or  only)</td> </tr> </table>		Pictures taken using Face Recognition		[Portrait] /  [Soft Skin] / [Night Portrait] /  [Baby] / 		[Scenery] /  [Panorama Shot] / [Sunset] /  [Glass Through]		[Night Portrait] /  [Night Scenery] /  [Handheld Night Shot] / 		[Sports]		[Baby] / 		[Pet]		[Food]		[Underwater]		[Burst] ( or  only)
	Pictures taken using Face Recognition																				
	[Portrait] /  [Soft Skin] / [Night Portrait] /  [Baby] / 																				
	[Scenery] /  [Panorama Shot] / [Sunset] /  [Glass Through]																				
	[Night Portrait] /  [Night Scenery] /  [Handheld Night Shot] / 																				
	[Sports]																				
	[Baby] / 																				
	[Pet]																				
	[Food]																				
	[Underwater]																				
	[Burst] ( or  only)																				
[Favorite]	Play back pictures set as [Favorite]. (→123)																				

[Calendar]

- For switching [Playback Mode] (→111)

Select the date from the calendar screen to view only the pictures taken on that day. (→44)

Retouching pictures

[Auto Retouch]

You can adjust the colour and brightness of a still picture to bring them into balance.

- New pictures are created after editing pictures with [Auto Retouch]. Before starting to edit, make sure that there is enough free space in the built-in memory or memory card.



• Example picture

1 Select a still picture to retouch during playback and press **▲**

2 Use cursor button to select **[Auto Retouch]** and press **[MENU/SET]**

3 Use cursor button to select **[ON]** and press **[MENU/SET]**

- A confirmation screen is displayed. If you select [Yes], the new retouched still picture is saved.
- When [OFF] is selected, you can restore a picture to its original condition (before retouching).

- The retouch effect may be less apparent in some still pictures.
- Some still pictures may have higher noise levels after retouching.
- It may not be possible to use [Auto Retouch] with still pictures that have already been retouched.
- It may not be possible to retouch still pictures recorded with other cameras.
- You cannot retouch the pictures in a burst group as a group. Retouch each picture in a burst group after displaying it.
- [Auto Retouch] is unable to perform in the following cases:
 - Motion pictures
 - Still pictures recorded in [Panorama Shot] Scene Mode
 - 3D still pictures

[Creative Retouch]

You can retouch recorded still pictures by selecting the effect that you want to apply.

- New pictures are created after editing pictures with [Creative Retouch]. Before starting to edit, make sure that there is enough free space in the built-in memory or memory card.

1 Select a still picture to retouch during playback and press ▲

2 Use cursor button to select [Creative Retouch] and press [MENU/SET]

3 Press ▲ ▼ to select a setting

- The picture retouched with the selected effect is displayed.
- When [OFF] is selected, you can restore a picture to its original condition (before retouching).

Setting	Effect
[EXPS] [Expressive]	This picture effect creates a pop art style picture that enhances the colour.
[RETR] [Retro]	This picture effect creates the soft appearance of a tarnished picture.
[HKEY] [High Key]	This picture effect creates a brighter and lighter toned appearance for the entire picture.
[MONO] [Dynamic Monochrome]	This picture effect creates a monochromatic picture with a higher contrast and more dramatic atmosphere.
[TOY] [Toy Effect]	This picture effect creates a picture that resembles pictures taken by a toy camera with a reduced amount of peripheral light. <ul style="list-style-type: none"> • About adjusting colour shade <ul style="list-style-type: none"> → Press the [DISP.] button and use the cursor button to select the shades of a colour.
[SOFT] [Soft Focus]	This picture effect creates a soft appearance by intentionally blurring the entire picture.

4 Press [MENU/SET]

- A confirmation screen is displayed. If you select [Yes], the new retouched still picture is saved.

- The retouch effect may be less apparent in some still pictures.
- It may not be possible to retouch still pictures recorded with other cameras.
- You cannot retouch the pictures in a burst group as a group. Retouch each picture in a burst group after displaying it.
- [Creative Retouch] is unable to be performed in the following cases:
 - Motion pictures
 - Still pictures recorded in [Panorama Shot] Scene Mode
 - 3D still pictures

Using the [Playback] menu

You can set the recorded picture to upload to the image-sharing websites, edit the picture (for example, trimming), and set a protection setting in the picture.

- For [Playback] menu display and operation methods (→51)
- Depending on the [Playback Mode], some [Playback] menu items are not displayed.
- It may not be possible to set or edit pictures taken with other cameras.
- New pictures are created after editing pictures with tools such as [Text Stamp], [Resize] and [Cropping]. Before starting to edit, make sure that there is enough free space in the built-in memory or memory card.

[Upload Set]

You can select pictures on the camera for uploading to image-sharing websites (Facebook or YouTube).

- You can only upload motion pictures to YouTube, while you may upload both motion pictures and still pictures to Facebook.
- Pictures on the built-in memory cannot be set. Copy pictures to a card (→127) before making [Upload Set] settings.

1 Use cursor button to select [SINGLE] or [MULTI], and then press [MENU/SET]

2 Select picture and make setting

● [SINGLE]

- ① Use cursor button to select picture and press [MENU/SET]



Web upload setting

- To cancel
→ Press [MENU/SET] again.

● [MULTI]

- ① Use cursor button to select picture and press [DISP.] button



Web upload setting

- To cancel
→ Press [DISP.] button again.

- ② To execute → Press [MENU/SET].
 - Confirmation screen is displayed. If you select [Yes], the operation is executed.

■ Uploading to image-sharing websites

When setting [Upload Set], the built-in uploading tool automatically makes copies on the card inside the camera. Connect the camera to your computer (→165) before performing uploading operations. For more details, refer to (→167).

■ To clear all

Select [CANCEL] in step 1 and select [Yes].

- Not available on cards with less than 512 MB.

[Title Edit]

• For [Playback] menu display and operation methods (→51).
You can give titles, etc. to your favourite still pictures.

1 Use cursor button to select [SINGLE] or [MULTI], and then press [MENU/SET]

2 Select a still picture

- [SINGLE]

Use cursor button to select a still picture and press [MENU/SET]

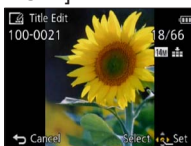

- [MULTI]

(up to 100 pictures with the same text)

Use cursor button to select a still picture and press [DISP.] button



[Title Edit] setting

[Title Edit] already set

- To cancel
→ Press [DISP.] button again.
- To execute
→ Press [MENU/SET].

3 Enter characters (Entering text (→94))

To delete a title, delete all the characters in the character input screen.

- Cannot be used in the following cases:
 - Motion pictures
 - 3D still pictures
- To print text, use [Text Stamp] or "PHOTOfunSTUDIO" on the supplied disc.

[Edit GPS Data] **DMC-TZ30** **DMC-TZ31**

For details (→138).

[Text Stamp]

- For [Playback] menu display and operation methods (→51).

The recording date and time, location name information and the text registered in the [Baby], [Pet] Scene Modes, [Travel Date] and [Title Edit] are stamped on the still picture.

DMC-TZ30 **DMC-TZ31**

The recording date and time, the text registered by [Baby] or [Pet] Scene Mode, [Travel Date] and [Title Edit] are stamped on the still picture. **DMC-TZ27**

1 Use cursor button to select [SINGLE] or [MULTI], and then press [MENU/SET]

2 Select a still picture

- [SINGLE]

Use cursor button to select a still picture and press [MENU/SET]



- [MULTI] (up to 100 pictures)

Use cursor button to select a still picture and press [DISP.] button

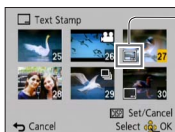

- ☐ [Text Stamp] setting

- To cancel
→ Press [DISP.] button again.
- To execute
→ Press [MENU/SET].

3 Use cursor button to select [Set] and press [MENU/SET]

4 Use cursor button to select items and press [MENU/SET] (→120)

5 Use cursor button to select settings and press [MENU/SET] (→120)

6 Press [⏪ / ⏩] button

7 Use cursor button to select [OK] and press [MENU/SET]

8 Use cursor button to select whether to stamp age and press [MENU/SET]

- If [Name] is [OFF] in step 5, this step will not be displayed.
- Confirmation screen is displayed. If you select [Yes], the operation is executed.

■ Items that can be stamped

[Shooting Date]	[W/O TIME]: Stamp recording date [WITH TIME]: Stamp recording date and time
[Name]	☺: Stamp name registered in Face Recognition 🐶/🐱: Stamp name registered in [Baby] or [Pet]
[Location]	Stamp location registered in [Setup] menu's [Travel Date]
[Travel Date]	Stamp Travel Date set in [Setup] menu's [Travel Date]
[Title]	Stamp text registered in [Title Edit]
[Country/Region]	DMC-TZ30 DMC-TZ31 Stamp place name information recorded by GPS function • If text such as the location name or landmark name is long, it may not be possible to stamp all the text.
[State/Prov./County]	
[County/Township]	
[City/Town/Village]	
[Landmark]	

- Items set to [OFF] are not stamped.
- Cannot stamp texts on the following pictures.
 - Motion pictures
 - 3D still pictures
 - Still pictures that date or other texts had already been stamped
 - Still pictures taken without setting clock
 - Still pictures recorded in [Panorama Shot] Scene Mode
- Characters may be cut off on certain printers.
- Text is difficult to read when stamped on pictures of 0.3M or less.
- **Do not request date printing in store or make date printing on printer for still pictures with date stamps. (Date printing may be overlapping.)**

[Resize]

- For [Playback] menu display and operation methods (→51).

Picture size can be reduced to facilitate e-mail attachment and use in web pages, etc. (Still pictures recorded at the smallest recording pixel level cannot be further reduced.)

■[SINGLE]

- 1 Use cursor button to select [SINGLE] and press [MENU/SET]
- 2 Use cursor button to select a still picture and press [MENU/SET]
- 3 Use cursor button to select size and press [MENU/SET]

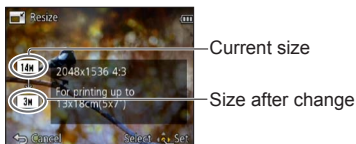

- Confirmation screen is displayed. If you select [Yes], the operation is executed.

■[MULTI]

- 1 Use cursor button to select [MULTI] and press [MENU/SET]
- 2 Use cursor button to select size and press [MENU/SET]
- 3 Use cursor button to select a still picture and press [DISP.] button (up to 100 pictures)

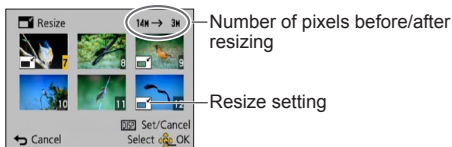

- To cancel
→ Press [DISP.] button again.
- To execute
→ Press [MENU/SET].

- Confirmation screen is displayed. If you select [Yes], the operation is executed.

- Picture quality is reduced after resizing.
- Cannot resize the following pictures.
 - Motion pictures
 - 3D still pictures
 - Still pictures that date or other texts had already been stamped
 - Still pictures recorded in [Panorama Shot] Scene Mode

[Cropping]

- For [Playback] menu display and operation methods (→51).
Enlarge your still pictures and crop unwanted areas.

1 Use cursor button to select a still picture, and then press [MENU/SET]

2 Select area to crop and press [MENU/SET]



Expand



Change position

- Confirmation screen is displayed. If you select [Yes], the operation is executed.
- Picture quality is reduced after cropping.
- Cannot crop the following pictures.
 - Motion pictures
 - Still pictures that date or other texts had already been stamped
 - Still pictures recorded in [Panorama Shot] Scene Mode
 - 3D still pictures
- Original Face Recognition information will not be copied when still pictures are cropped.

[Favorite]

- For [Playback] menu display and operation methods (→51).

By labelling your favourite pictures with a star (★), you can play back your favourite pictures only, or you can delete all pictures except your favourites.

1 Use cursor button to select [SINGLE] or [MULTI] and press [MENU/SET]

2 Use cursor button to select picture and press [MENU/SET]

● [SINGLE]

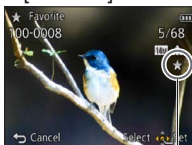

Favourite picture setting

● [MULTI]

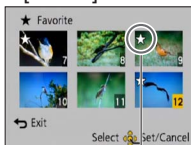

Favourite picture setting

- To cancel → Press [MENU/SET] again.

■ To clear all

Select [CANCEL] in step 1 and select [Yes].

[Print Set]

• For [Playback] menu display and operation methods (→51).
Picture/picture no./date printing settings can be made for when printing with DPOF print-compatible shops or printers. (Ask at the shop to check for compatibility.)

1 Use cursor button to select [SINGLE] or [MULTI] and press [MENU/SET]

2 Use cursor button to select picture and press [MENU/SET]

3 Use cursor button to set number of pictures and press [MENU/SET]

(repeat steps **2** and **3** when using [MULTI] (up to 999 pictures))

● [SINGLE]

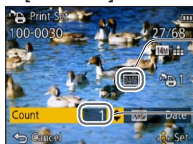

Date print set

No. to print

● [MULTI]



Date print set

No. to print

• Date print setting/release → Press [DISP.] button

■ To clear all

Select [CANCEL] in step **1** and select [Yes].

- Depending on the type of printer, the printer settings may take priority over camera settings.
- Cannot be set for files that are not compliant with the DCF standard.
- Some DPOF information set by other equipment cannot be used. In such cases, delete all of the DPOF information and then set it again with this camera.
- Date print setting cannot be made for still pictures that have been taken with [Date Stamp] and pictures with a [Text Stamp] applied.
- Print setting cannot be made for motion pictures.

[Protect]

- For [Playback] menu display and operation methods (→51).
Set protection to disable picture deletion. Prevents deletion of important pictures.

1 Use cursor button to select [SINGLE] or [MULTI] and press [MENU/SET]

2 Use cursor button to select picture and press [MENU/SET]

● [SINGLE]



Picture protected

● [MULTI]

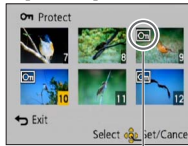

Picture protected

- To cancel → Press [MENU/SET] again.

■ To clear all

Select [CANCEL] in step **1** and select [Yes].

- May not be effective when using other devices.

[Face Rec Edit]

- For [Playback] menu display and operation methods (→51).
Edit or delete the recognition information for pictures with mistaken Face Recognition.

- 1 Use cursor button to select [REPLACE] or [DELETE] and press [MENU/SET]**
- 2 Use cursor button to select the picture and press [MENU/SET]**
- 3 Use cursor button to select a person and press [MENU/SET]**
 - If [DELETE], go to step **5**.
 - People whose Face Recognition information has not been registered cannot be selected.
- 4 Use cursor button to select the person to replace for another and press [MENU/SET]**
- 5 Use cursor button to select [Yes] and press [MENU/SET]**

- When Face Recognition information is deleted, it cannot be restored.
- Pictures for which all Face Recognition information has been deleted are not categorised in Face Recognition during [Category Selection].
- Recognition information cannot be edited in protected pictures.

[Copy]

- For [Playback] menu display and operation methods (→51).
You can copy pictures between built-in memory and memory card.

1 Use cursor button to select the copy method (direction) and press [MENU/SET]



Copy all pictures from built-in memory to card (go to step 3).



Copy 1 picture at a time from card to built-in memory.

2 Use cursor button to select picture and press [MENU/SET]

3 Use cursor button to select [Yes] and press [MENU/SET]

- To cancel → Press [MENU/SET].

- Copying pictures may take several minutes. Do not turn off power or perform other operations during copying.
- If identical names (folder/file numbers) are present in the copy destination, a new folder for copying will be created when copying from built-in memory to card (IN+SD). Identically-named files will not be copied from card to built-in memory (SD+IN).
- The following settings are not copied. Set them again after copying.
- [Print Set] - [Protect] - [Favorite]
- Only pictures from Panasonic digital cameras (LUMIX) may be copied.
- Motion pictures recorded in [AVCHD] format cannot be set.

Using the GPS function to record the location of a picture

Before using the GPS function, read "About GPS" (→8) and "Licence Agreement for Place Name and Map Data" (→190).

GPS stands for Global Positioning System. You can check your current location using GPS satellites. The camera receives radio signals that contain orbital information and time information from multiple GPS satellites, and uses them to calculate its current position. Calculating a position in this manner is known as "positioning".

This camera can record the location information of a place where a picture was taken on the pictures.

The camera can also automatically adjust the time or display a place where a picture was taken on a map during playback.

Precautions on properly receiving a GPS signal

- It is recommended to hold the camera steady with the built-in GPS antenna pointed at the open sky while updating the GPS. (→129)
- The camera cannot properly receive radio signals from the GPS satellites in the following places. As a result, the camera may not be able to execute positioning or a significant error in positioning may occur.
 - Inside buildings
 - Surrounded by trees, such as in a forest
 - Inside a moving train, vehicle, etc.
 - Near high-voltage electrical power lines
 - In building basements or underwater (when using the optional marine case)
 - Between tall buildings or in a valley
 - Inside tunnels
 - Near devices such as a 1.5 GHz band mobile phone lines

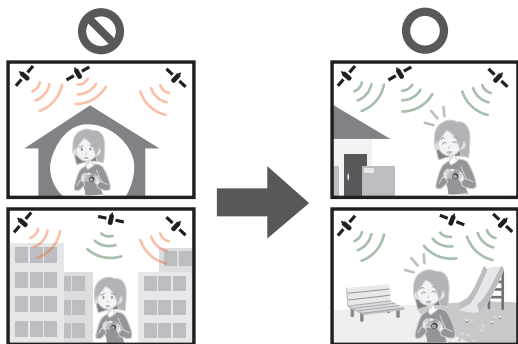

- Do not block the built-in GPS antenna with your hand or other objects.
- If you want to execute positioning while you carry the camera around, do not put it in a metallic bag or case. If the camera is enclosed in something metallic, it cannot execute positioning.

Using the GPS function to execute positioning

When [GPS Setting] is [ON], the camera periodically receives radio signals from the GPS satellites and executes positioning. When positioning is executed successfully, the place name and position (latitude and longitude) information are recorded in still pictures and motion pictures (except for the picture quality settings of [PSH], [FSH], and [SH]).

- If you select automatic time adjustment using the GPS function when you set the clock of this camera for the first time, [GPS Setting] is set to [ON].

1 Press [MENU/SET]

2 Use cursor button to select [GPS] menu and press [MENU/SET]

3 Use cursor button to select [GPS Setting] and press [MENU/SET]



4 Use cursor button to select [ON] and press [MENU/SET]

- A message appears on the screen. After confirming the message, press [MENU/SET].

[GPS Setting]	Description
[ON]	The camera periodically executes positioning. Even if the camera is turned off, positioning will be continued. (Positioning will stop after a certain period of time has elapsed.)
[OFF]	The GPS function is set to OFF.
[INFO]	You can check the current reception status.

■ About operations during positioning

The GPS status indicator lights up while positioning is being executed and the GPS reception icon appears on the screen. (→130)

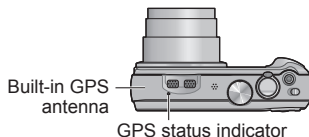

■ Displaying the status and result of positioning

The icons that indicate the status and result of positioning will appear on the LCD monitor. When positioning is successful, camera will search the place name information (name of place and landmark) inside its internal database and display it.

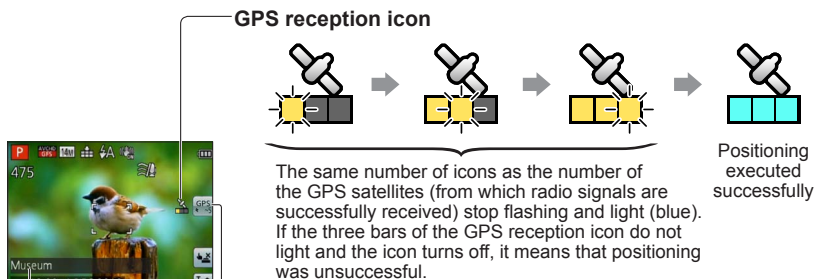

Place name information

- Country/region
- Province/state
- City/borough/county
- Town/village
- Landmark

Positioning result icons

Icon	Time elapsed after successful positioning
GPS ↕ ~5	Less than 5 minutes
GPS ↕ ~60	5 minutes to 1 hour have elapsed.
GPS ↕ ~120	1 hour to 2 hours have elapsed.
GPS ↕ ~120	2 hours or more have elapsed.
GPS ↕ ~	Positioning failed. No location information/place name information available.

Even if GPS reception is good, it will take approx. 2 to 3 minutes to successfully execute positioning in the following cases:

- When positioning is executed for the first time
- When [GPS Setting] is set to [OFF]
- When [Airplane Mode] is set to [ON] and the camera is turned off
- While the battery is removed

Positioning can be executed faster when you download GPS assist data to the camera using the "GPS Assist Tool". (→141)

■ Information to be recorded on the pictures

When the camera successfully executes positioning, it records the following information in still pictures and motion pictures* (except for the picture quality settings of [PSH], [FSH], and [SH]).

- Location information (latitude and longitude)
- Place name information (Country/region, province/state, city/borough/county, town/village, landmark)

* Only the information determined at the time when the recording was started is recorded.

Location information and place name information are stored in the camera after positioning is executed successfully. The information is updated when the camera executes a new positioning successfully.

- The GPS is displayed during playback for pictures that are recorded with location and place name information.
 - The location information and place name information are not recorded on pictures that are recorded when the positioning result icon  is displayed. [---] will appear during playback. (Since no location information is stored in the camera, you cannot perform [Edit GPS Data] (→137, 138).)
 - Only the location information will be recorded for pictures recorded immediately after positioning was executed successfully (until place name information appears). During playback, you can add the place name information to pictures recorded with only the location information.

■ Place name information

The most appropriate place name is displayed for place name information by searching for place names and landmarks from the database of this camera based on the latitude and longitude of positioning. (In some cases, the nearest place name or landmark may not be displayed.)

- If an appropriate place name or landmark is not found in the database of this camera, [---] will appear even if positioning is executed successfully. Even if [---] is displayed, in some cases you can select the place name information by using [GPS Area Select]. (→136)
 - There are also cases where the landmarks you are looking for may not be registered in the camera database. Place name information such as landmarks is current as of December 2011. (Type of landmarks (→196))
- Place name information (place name and landmark name) may be different from the official names in some cases.

Executing the positioning function right away to update the current location

If the displayed place name is different from the current location or a previous location is displayed, update the positioning information.

If some time has elapsed since the last time positioning was executed successfully (GPS \rightarrow -60, GPS \rightarrow -120, GPS \rightarrow 120-, or GPS is displayed), we recommend updating the positioning information.

Before starting the procedure, move to a place where positioning can be performed successfully. (\rightarrow 128)

1 (Recording mode only)
Touch the GPS icon

2 Touch [Repositioning]

The GPS status indicator lights up and the positioning reception icons appear on the screen while positioning is executed. (\rightarrow 130)



- The positioning information is also updated by the following operations.
 - Set [GPS] in the Quick menu to [GPS] again.
 - Select [Repositioning] from the [GPS] menu.



■ Interval between positioning operations

Even if the positioning information is not updated, the camera automatically tries to execute positioning immediately after it is turned on and subsequently at regular intervals when [GPS Setting] is [ON].

Also, when [Airplane Mode] is set to [OFF], the camera automatically tries to execute positioning periodically according to the environment, even if the camera is turned off. Note, however, that the positioning operation is interrupted in the following cases.

- When the battery power is low and  is displayed.
- When the battery charging is started.
- When the camera has not been turned on for a certain period of time.

■ Displaying the GPS reception status

- ① Select [GPS Setting] from the [GPS] menu: Perform steps **1** and **3** (→129)
 - ② Use cursor button to select [INFO] and press [MENU/SET]
 - Press [MENU/SET] again to update the positioning information
- Checking GPS reception status
 - : Time when positioning is executed
 - : Number of GPS satellites from which the camera has received signals
 - : Latitude
 - Longitude

Changing place name information to be displayed

You can change the recorded place name information items to be displayed on the screen.

- 1 Press [MENU/SET]
- 2 Use cursor button to select [GPS] menu and press [MENU/SET]
- 3 Use cursor button to select [Area Info. Set] and press [MENU/SET]
- 4 Use cursor button to select an item to be changed and press [MENU/SET]

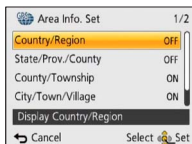

- 5 Use cursor button to set items that you want to display to [ON] and items that you do not want to display to [OFF] and press [MENU/SET]

Disabling the positioning function when the camera is turned off

When [GPS Setting] is [ON], the GPS function remains activated even if the camera is turned off.

To disable the positioning function when the camera is turned off, set [Airplane Mode] to [ON].

- 1 Press [MENU/SET]**
- 2 Use cursor button to select [GPS] menu and press [MENU/SET]**
- 3 Use cursor button to select [Airplane Mode] and press [MENU/SET]**
- 4 Use cursor button to select [ON] and press [MENU/SET]**

- Electromagnetic waves from the camera can affect instruments and meters. In airplane cabins (during takeoff and landing) or in other restricted areas, set [GPS Setting] to [OFF] or set [Airplane Mode] to [ON], and then turn off the camera.

Changing the place name information to be recorded

When there are other candidate locations as a result of positioning, you can change the location information to another place name or landmark in the neighbourhood.

- When there is a choice for differing place name information,  appears in front of the place name information.
- You can also perform this operation by touching [GPS Area Select] after touching the GPS icon.

1 Press [MENU/SET]

2 Use cursor button to select [GPS] menu and press [MENU/SET]

3 Use cursor button to select [GPS Area Select] and press [MENU/SET]

4 Use cursor button to select an item to be changed and press [MENU/SET]

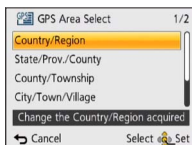

5 Use cursor button to select a place name or landmark from the displayed candidates and press [MENU/SET]

■ If you do not want to record a place name or landmark

When you select [Delete all place-names] in step **4** above, the place names and landmarks are not recorded.

You can also select the level of the place name and landmark information to be excluded in step **5** above. All place names and landmarks that are below the selected level will be deleted from the recording. (For example, if you delete [County/Township], the lower level [City/Town/Village] and [Landmark] data will not be recorded either.)

- Note, however, that the latitude and longitude data are recorded. If you do not want to record the latitude and longitude data, set [GPS Setting] to [OFF].
 - To restore the place names and landmarks that you set not to be recorded, perform the [GPS Area Select] procedure again.
- A landmark may not be displayed at all or a different landmark may be displayed in places such as a large park. If the landmark that you want cannot be selected using [GPS Area Select], perform the [My Landmark] procedure (→153) before recording a picture or the [Edit Place Name] procedure after recording a picture. (→138)

Changing the recorded GPS information

[Edit Location]

You can edit the location information (latitude and longitude) recorded on still pictures and motion pictures.

- You can edit the location information only on a picture (GPS appears on the screen when this picture is played back) recorded with GPS information (location and place name information) when it was taken.
- When you edit the location information, the place name information is deleted.

Preparation: Before editing the location information using map data, be sure to copy the map data on the supplied DVD to a memory card. (→151)

- 1** Press [MENU/SET]
- 2** Use cursor button to select [Playback] menu or [Map] menu and press [MENU/SET]
- 3** Use cursor button to select [Edit GPS Data] and press [MENU/SET]
- 4** Use cursor button to select a picture and press [MENU/SET]
- 5** Use cursor button to select [Edit Location] and press [MENU/SET]
- 6** Use cursor button to select an editing method and press [MENU/SET]

■ Specifying the location from the map

- ① Use cursor button to select [Point on map] and press [MENU/SET]
- ② Move the map to a new location that you want to record on the picture and press [MENU/SET]
 - About map operation (→146)
 - A confirmation screen will appear. Select [Yes] to overwrite the location information.

■ Using the location information of another picture for reference

- ① Use cursor button to select [Use another picture] and press [MENU/SET]
- ② Use cursor button to select a picture to be used as a reference for the recording location and press [MENU/SET]
A map is displayed with the location recorded on a picture at the centre.
- ③ Move a map to a new location that you want to record on the picture and press [MENU/SET]
 - About map operation (→146)
 - A confirmation screen will appear. Select [Yes] to overwrite the location information.

■ Applying the edited location information to other pictures

- ① Use cursor button to select [Repeat] and press [MENU/SET]
The location information that was edited last will be displayed.
 - A confirmation screen will appear. Select [Yes] to overwrite the location information.
- The location information of a position specified on a map may deviate from the actual latitude and longitude coordinates.
- You cannot edit pictures taken using a Panasonic digital camera (LUMIX) with GPS recording support released before 2010.

[Edit Place Name]

You can edit a place name or landmark name recorded in a picture.

- 1** Press [MENU/SET]
- 2** Use cursor button to select [Playback] menu or [Map] menu and press [MENU/SET]
- 3** Use cursor button to select [Edit GPS Data] and press [MENU/SET]
- 4** Use cursor button to select a picture and press [MENU/SET]
- 5** Use cursor button to select [Edit Place Name] and press [MENU/SET]
- 6** Use cursor button to select an editing method and press [MENU/SET]

■ Selecting a place name from candidates

- ① Use cursor button to select [Candidate] and press [MENU/SET]
 - ② Use cursor button to select an item to be edited and press [MENU/SET]
Place names or landmark names near the location information recorded in a picture are searched.
 - ③ Select a place name or landmark name and press [MENU/SET]
 - A confirmation screen will appear. Select [Yes] to overwrite the place name information.
- Place names and landmarks subordinate to the edited place name will be deleted (for example, if you edit [County/Township], then [City/Town/Village] and [Landmark] will be deleted).
 - If a landmark name is selected from My landmark (→153), the place name information other than landmark names will be deleted.

■ Directly editing a place name or landmark name

- ① Use cursor button to select [Direct] and press [MENU/SET]
- ② Use cursor button to select an item to be edited and press [MENU/SET]
- ③ Enter a name (Entering text: →94)
 - A confirmation screen will appear. Select [Yes] to overwrite the place name information.

■ Applying the edited place name and landmark name to other pictures

- ① Use cursor button to select [Repeat] and press [MENU/SET]
The place name or landmark name that was selected or entered last will be displayed.
 - A confirmation screen will appear. Select [Yes] to overwrite the place name information.

- You cannot edit pictures taken using a Panasonic digital camera (LUMIX) with GPS recording support released before 2010.

Adjusting the time using GPS

You can automatically update the [Clock Set] of the camera using the date and time information contained in GPS radio signals. When you move to a different time zone from your home area and positioning is executed successfully, the camera automatically adjusts the time to the local time.

1 Select [Auto Clock Set] from [Setup] menu and press [MENU/SET]

- Displaying the [Setup] menu (→51)

2 Use cursor button to select [ON] and press [MENU/SET]

3 (for the first time only)

3 When [Please set the home area] is displayed, press [MENU/SET]

4 Press ◀▶ to set your home area and press [MENU/SET]

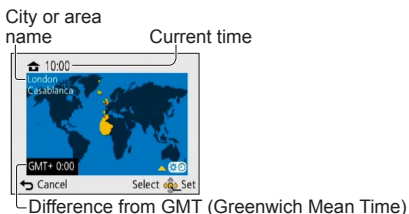

- When [Auto Clock Set] is set to [ON], the following settings are also changed automatically.
 - [GPS Setting]: [ON]
 - [World Time]: [Destination]
- You cannot select the area of [Destination]. (You can set the summer time for your destination.)
To select the area, set [Auto Clock Set] to [OFF], and set [World Time]. (→93)
- The date and time adjusted by [Auto Clock Set] are not as accurate as those of radio clocks. If the date and time are not adjusted accurately, use [Clock Set] to re-adjust the date and time.

Reducing the time required for positioning

You can reduce the time required for positioning by copying in advance the predicted satellite information (GPS assist data) of GPS satellites required for positioning to the camera.

- A computer that can be connected to the Internet is required to download the GPS assist data.
- If the camera's clock is not set, the GPS assist data cannot be used.
- The GPS assist data is valid for 30 days.
- The GPS assist data is updated once a day.
- The GPS assist data provider service may be changed or discontinued without prior notice. (The current service is provided as of January 2012.)

About the "GPS Assist Tool"

You can use the "GPS Assist Tool" to download the GPS assist data from the Internet and update the GPS assist data of the camera.

■ Operating environment

Supported OS	Windows® XP (32-bit) SP3 Windows Vista® (32-bit) SP2 Windows® 7 (32-bit, 64-bit) and SP1 Mac® OS X v10.4, v10.5, v10.6, and v10.7
---------------------	--

- You do not need to install the software on your computer.

■ Using the "GPS Assist Tool"

You can operate the "GPS Assist Tool" using the following methods.

Connecting the camera and a computer to execute the "GPS Assist Tool" stored in the camera142

Copying the "GPS Assist Tool" to a memory card and use the card reader/writer (commercially available) to execute the "GPS Assist Tool"143

- If the "GPS Assist Tool" cannot be used, download the GPS assist data from the support site and copy it to a memory card.
To access the support site, double-click "GPSASIST.HTM", which is displayed when the camera is connected to a computer or when the "GPS Assist Tool" is copied to a memory card.
For detailed procedures, such as downloading the GPS assist data, read the information displayed on the support site.

Using the “GPS Assist Tool”

■ Using “GPS Assist Tool” by connecting the camera and computer

Preparation: Turn on the computer and close all other open application programs.

- 1** Press [MENU/SET]
- 2** Use cursor button to select [GPS] menu and press [MENU/SET]
- 3** Use cursor button to select [Assist Data] and press [MENU/SET]
- 4** Use cursor button to select [Update] and press [MENU/SET]
- 5** Use cursor button to select [Connect USB] and press [MENU/SET]
- 6** Connect the camera to a computer

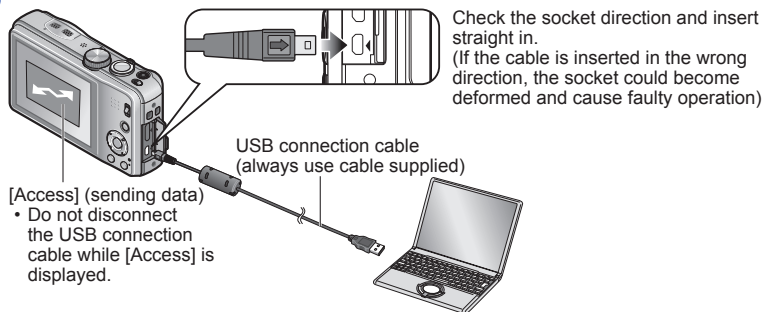

- 7** Start up the “GPS Assist Tool” on your computer and update the GPS assist data (→144)

The GPS assist data of the camera is updated.

- 8** Terminate the connection between the camera and computer and disconnect the USB connection cable

- You can also update the assist data if you select [GPS assist data] for [USB Mode] (→58) when you connect the camera to a computer.
- Do not use any other USB connection cables except the supplied one.

■ Using a card reader/writer (commercially available)

- Preparation:**
- Turn on the computer that is connected to a card reader/writer (commercially available) and close all other open application programs.
 - Insert a memory card in the camera before starting the updating procedure.

- 1 Press [MENU/SET]**
- 2 Use cursor button to select [GPS] menu and press [MENU/SET]**
- 3 Use cursor button to select [Assist Data] and press [MENU/SET]**
- 4 Use cursor button to select [Update] and press [MENU/SET]**
- 5 Use cursor button to select [SD card] and press [MENU/SET]**
The “GPS Assist Tool” is copied to a memory card.
- 6 Turn off the camera and remove the memory card**
- 7 Insert the memory card into a card reader/writer (commercially available) connected to the computer**
- 8 Start up the “GPS Assist Tool” stored in the memory card on the computer and update the GPS assist data (→144)**
- 9 Remove the memory card from the computer**
- 10 Insert the memory card into the camera and turn on the camera**
The GPS assist data of the camera is updated.

Updating the GPS assist data

1 Start up the “GPS Assist Tool” on the computer

■ Windows

- Double-click [GPSASIST.EXE] stored in the connected camera or memory card
The “GPS Assist Tool” will start up.
 - When the “GPS Assist Tool” is copied to the memory card, [GPSASIST.EXE] is stored in the [AD_LUMIX] folder.

■ Mac

- Double-click [GPSASIST.DMG] stored in the connected camera or memory card
 - When the “GPS Assist Tool” is copied to the memory card, [GPSASIST.DMG] is stored in the [AD_LUMIX] folder.
- Double-click [GPSASIST]
The “GPS Assist Tool” will start up.

2 Operate the “GPS Assist Tool”

- Click [Update]
 - Click [Yes]
 - Click [OK]
 - Click [Exit]
- Do not terminate the connection between the camera/card and computer until the data is updated.

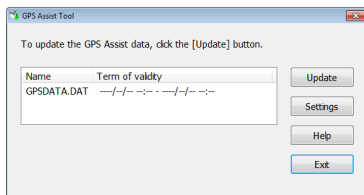

3 Terminate the connection between camera/card and computer

- Windows: Execute “Safely Remove Hardware” on the taskbar
- Mac: Open the Finder and click the eject icon that appears on the sidebar

■ Changing the proxy settings

Perform the proxy settings only if the GPS assist data cannot be updated successfully when the computer is connected to the Internet via proxy.

- Click [Settings]
- Perform the proxy settings

Windows: Enable [Use proxy server.] and change the settings.

Mac: Change the settings using the network settings screen of the displayed system environment settings screen.

Checking the expiration date of the GPS assist data

The GPS assist data expires in 30 days. We recommend using new GPS assist data.

- 1** Press [MENU/SET]
- 2** Use cursor button to select [GPS] menu and press [MENU/SET]
- 3** Use cursor button to select [Assist Data] and press [MENU/SET]
- 4** Use cursor button to select [Expiry Date] and press [MENU/SET]

- You can also check the expiration date on the screen when the “GPS Assist Tool” is started up on the computer.
- The starting date of the expiration period may be moved to an earlier time than the renewal date due to the update timing of GPS assist data or other factors.

Using the map function

You can display a map showing the location where a picture was taken or your current location.

- If you copy the map data stored on the supplied DVD to a memory card, you can display more detailed maps. (→150)
- The place name information recorded on a picture and the place name displayed on a map may not be exactly the same.

Confirming the place where you took a picture using a map

When the location information or place name information is recorded on a picture, you can display a map showing the location where that picture was taken.

1 Display the pictures in playback mode

- The GPS is displayed during playback for pictures that are recorded with location and place name information.

2 Press [MAP] button

A map of the place where you took the picture will appear. (If the picture was not recorded with location information or place name information, a wide area map will appear)



- 📷 : Location where a picture was taken
- 👤 : Your current location
- : My Landmark (→153)

Touch the +/- button to enlarge or reduce the map size. (You can also enlarge or reduce the map size using the zoom lever.)

Map scale level (The levels that can be displayed vary depending on the region)

- You can drag the screen or press the cursor button to operate the display location of a map.
- You cannot change the display direction of the map. The map is oriented so that North is always at the top of the map.
- When you press the [🏠 / 🔄] button, it will return to the previous display.
- The actual place where you took the picture and the location displayed on the map may not be exactly the same.
- When you enlarge or reduce the map size, it may take some time before it is displayed.
- You can display the place where you took the pictures on a map only for pictures with location information or place name information recorded using Panasonic digital cameras (LUMIX) equipped with a GPS function.

Displaying your current location on a map

When positioning is executed successfully using GPS, you can display your current location on a map.

- Make sure to set [GPS Setting] to [ON]. (→129)

1 Press [MAP] button in playback mode

2 Touch [My Location]

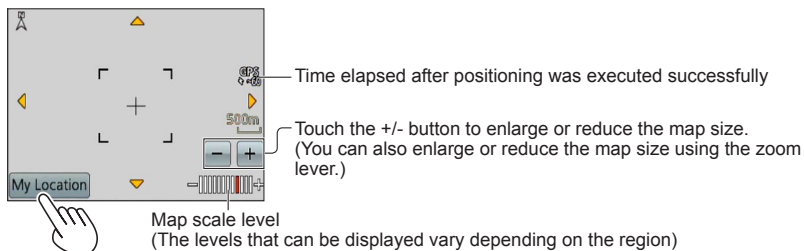

- You can drag the screen or press the cursor button to operate the display location of a map.
- When you press the [⏪ / ⏩] button, it will return to the previous display.
- You can also use [My Location] in the [Map] menu to display the current location on a map.

When a map is being displayed, the camera executes positioning at regular intervals. When positioning is executed successfully, your current location (📍) displayed in the map is updated.

- This camera is not equipped with a navigation function.
- The actual place where you took the pictures and the location displayed on the map may be quite different under the following conditions.
 - When some time has elapsed after positioning was executed successfully.
 - When the camera is moving at high speed

Displaying only pictures taken in the same area

You can select the area of a picture on a map to narrow down the pictures to be displayed.

1 Press [MAP] button in playback mode

2 Display the map so that the place where you took the pictures is moved within the display range of the frame

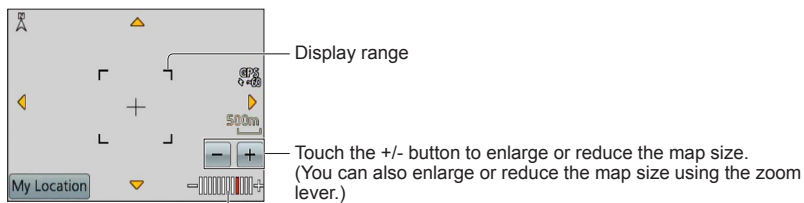

Map scale level (The levels that can be displayed vary depending on the region)

- You can drag the screen or press the cursor button to operate the display location of a map.

3 Press [DISP.] button

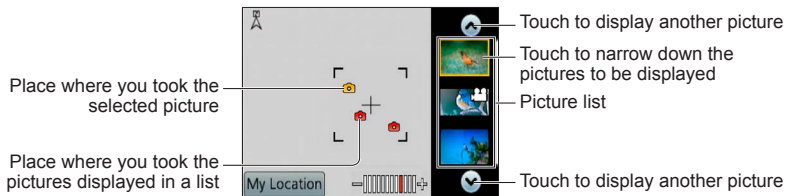

4 Touch a picture in the picture list to display it

Only pictures taken at a location within the display range of the frame are displayed ([Filtering Play]).

- You can also display a picture by selecting it using the cursor button and pressing [MENU/SET].
- Select [Normal Play] from the [Playback Mode] menu to cancel [Filtering Play].

- When the map is at its maximum size the location where the picture was taken and the picture list will not be displayed.

Displaying a map by selecting a country or region

You can select a place name that you want to display and show it on a map.

- 1** Press [MENU/SET] in playback mode
- 2** Use cursor button to select [Map] menu and press [MENU/SET]
- 3** Use cursor button to select [Select Area] and press [MENU/SET]
- 4** Use cursor button to select [From Place Name] and press [MENU/SET]
- 5** Use cursor button to select a country/region and press [MENU/SET]

Using the map data on the DVD (supplied)

You can use “LUMIX Map Tool” to copy the map data on the DVD (supplied) to a memory card. When the map data is copied to the memory card, detailed maps can be displayed on the camera.

- Install “LUMIX Map Tool” on your computer before starting the detailed map display procedure.

Installing “LUMIX Map Tool”

Close all other open application programs before inserting a DVD in the computer drive.

■ Operating environment

Supported OS	Windows® XP (32-bit) SP3 Windows Vista® (32-bit) SP2 Windows® 7 (32-bit, 64-bit) and SP1 Mac® OS X v10.4, v10.5, v10.6, and v10.7
---------------------	--

■ Windows

- 1 Insert the DVD**
- 2 Click [Applications]**
- 3 Click [Recommended Installation] or [LUMIX Map Tool]**
Continue the installation procedure following the instructions displayed on the screen.

■ Mac

- 1 Insert the DVD**
- 2 Double-click the recognised disc to open**
- 3 Double-click the [Application] folder to open**
- 4 Double-click the [MAPTOOL] folder to open**
- 5 Double-click [LUMIX Map Tool.pkg]**
Continue the installation procedure following the instructions displayed on the screen.

Copying the map data to a memory card

- Preparation:**
- Install “LUMIX Map Tool” on your computer before starting the copying procedure. (→150)
 - Turn on the computer and close all other open application programs.
 - Insert the supplied DVD in your computer drive before starting the copying procedure.
(Windows: Close the installation menu that starts automatically.)

1 Insert the memory card into a card reader/writer (commercially available) connected to the computer

2 Start “LUMIX Map Tool” installed in your computer

- Windows: Click [Start] → [All Programs] → [Panasonic] → [LUMIX Map Tool] → [LUMIX Map Tool]
• Double click on the shortcut icon on the desktop if you chose to create one at the time of installation.
- Mac: Double-click [LUMIX_Map_Tool] in [Applications] (Applications)

3 Select a card from the pull-down menu (A)

4 Click the checkbox to select a region to be copied (B)

5 Click [Execute] (C)

- Perform the rest of the steps in accordance with the instructions displayed on the computer screen.

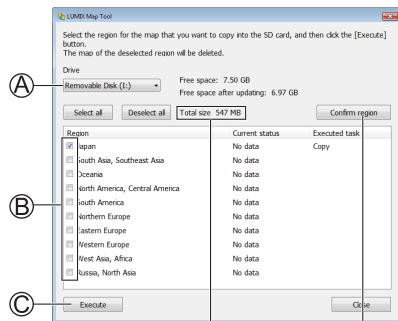

Size of data to be copied

The region confirmation window will appear.

6 After copying is finished, click [Close] and remove the memory card from the computer

- Windows: Execute “Safely Remove Hardware” on the taskbar
- Mac: Open the Finder and click the eject icon that appears on the sidebar

■ Copying map data directly to a memory card in the camera from the computer instead of a card reader/writer (commercially available)

You can copy the map data to a memory card inserted in the camera by connecting the camera to a computer using the supplied USB connection cable.

- Select the connected camera in step 3 (→151).
- For details on making the connection with a computer (→165).
- Do not use any other USB connection cables except the supplied one.

■ Deleting the map data

You can free up space on the memory card by deleting map data that is no longer required.

- ① Click the already copied region in step 4 (→151)
 - The [Executed task] field will change to [Delete].
 - ② Click [Execute]
 - Perform the rest of the steps in accordance with the instructions displayed on the computer screen.
- Since the map data size is large, be sure to check the free space on the memory card before copying the data. (A memory card of at least 8 GB is needed to copy the map data for all the regions.)
 - Since the map data size is large, it will take time to copy the map data.
 - When map data is copied to a memory card, the number of recordable pictures and recording time will decrease.
 - The maps are copied to the memory card. If a different card is inserted in the camera, no maps are displayed.
 - When a memory card is formatted (initialised), all data, including the map data, is deleted.
 - Use “LUMIX Map Tool” for copying and deleting the map data. When the map data is deleted or moved to another location using the file operation of your computer, the maps may not be displayed correctly.

Registering my landmark

You can register a user-defined location that is not registered in this camera as my landmark in order to display it when positioning is executed or to record it on a picture. (Up to 50 landmarks)

- You can only register the landmark name as My landmark. (You cannot register place names such as city, town, or village names.)
- Unless the map data is copied to a memory card, My landmark cannot be registered. Before registering My landmark, copy the map data on the DVD (supplied) to the memory card. (→150)

Registering my landmark from a map

You can register a location specified on a map as My landmark.

- 1** Press [MENU/SET] in playback mode
- 2** Use cursor button to select [Map] menu or [GPS] menu and press [MENU/SET]
- 3** Use cursor button to select [My Landmark] and press [MENU/SET]
- 4** Use cursor button to select [None] and press [MENU/SET]
- 5** Use cursor button to select [Point on map] and press [MENU/SET]
- 6** Display the location that you want to register at the centre of the map and press [MENU/SET]
 - Operations available when a map is displayed (→146)
- 7** Press [MENU/SET]
- 8** Enter my landmark name (Entering text: →94)

- You can use the GPS to register your current location as My landmark. If you have moved to a location where positioning is enabled and when positioning is executed successfully before starting the My landmark registration procedure, the current location will be displayed at the centre of the map.

Registering the recording location as my landmark

You can use the location information of a picture to register it as My landmark.

- 1 Press [MENU/SET] in playback mode
- 2 Use cursor button to select [Map] menu or [GPS] menu and press [MENU/SET]
- 3 Use cursor button to select [My Landmark] and press [MENU/SET]
- 4 Use cursor button to select [None] and press [MENU/SET]
- 5 Use cursor button to select [Picture location data] and press [MENU/SET]
- 6 Display a picture that was taken at a location you want to register as a landmark
- 7 Press [MENU/SET]
- 8 Display the location that you want to register at the centre of the map and press [MENU/SET]
 - Operations available when a map is displayed (→146)
- 9 Press [MENU/SET]
- 10 Enter my landmark name (Entering text: →94)

Selecting My landmark and displaying it on a map

You can display a map by moving the registered My landmark to the centre.

- 1** Press [MENU/SET] in playback mode
- 2** Use cursor button to select [Map] menu and press [MENU/SET]
- 3** Use cursor button to select [Select Area] and press [MENU/SET]
- 4** Use cursor button to select [From My Landmark] and press [MENU/SET]
- 5** Use cursor button to select My landmark and press [MENU/SET]

Editing or deleting my registered landmark

- 1** Press [MENU/SET] in playback mode
- 2** Use cursor button to select [Map] menu or [GPS] menu and press [MENU/SET]
- 3** Use cursor button to select [My Landmark] and press [MENU/SET]
- 4** Use cursor button to select an already registered landmark and press [MENU/SET]
- 5** Use cursor button to select an item and press [MENU/SET]

[Edit]	Edits my landmark name.
[Delete]	Deletes my registered landmark.

Viewing on TV screen

You can view pictures on a TV screen by connecting your camera to your TV with the HDMI mini cable (optional) or AV cable (optional).

- Also consult TV operating manual.

Preparation:

- Set [Output] to connect your camera to a TV using the AV cable (optional) (→59)
- Turn off both camera and TV.

1 Connect camera to TV

■ To connect with an HDMI mini cable (optional)

An HDMI mini cable (optional) can be used to enable viewing of still and motion pictures in high resolution.

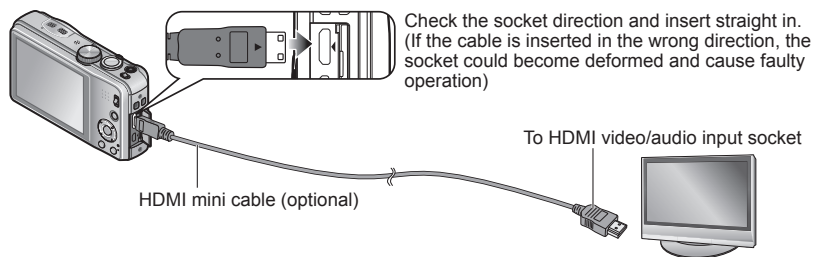

■ To connect with an AV cable (optional)

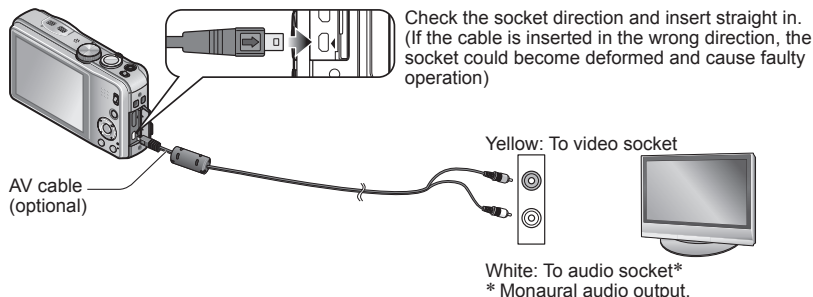

2 Turn on TV

- Set to auxiliary input.

3 Turn on camera

4 Set REC/PLAY switch to

■ To connect with an HDMI mini cable (optional)

- Always use a genuine Panasonic HDMI mini cable (optional).
- Some of the playback functions cannot be performed.
- [Playback], [GPS] **DMC-TZ30** **DMC-TZ31**, [Map] **DMC-TZ30** **DMC-TZ31**, and [Setup] menus cannot be used.
- Bars may appear at the sides or at the top and bottom of the screen, depending on the aspect ratio setting.
- When an HDMI mini cable is connected, pictures are not displayed on the LCD monitor.
- HDMI output will be cancelled if a USB connection cable is connected simultaneously.
- When the AV cable (optional) and HDMI mini cable (optional) are connected at the same time, no picture is output from the AV cable.
- Pictures may be momentarily distorted immediately after commencing playback or pausing on certain televisions.
- Audio output is stereo.

■ To connect with an AV cable (optional)

- Always use a genuine Panasonic AV cable (optional).
- You can play back pictures on TVs in other countries (regions) which use the NTSC or PAL system when you set [Video Out] in [Setup] menu.
- Pictures rotated to portrait may be blurred slightly.
- Change picture mode settings on TV if aspect ratios are not displayed correctly on widescreen or high-definition televisions.

■ When TVs or DVD recorders have an SD card slot

Insert the SD Memory Card into the SD card slot

- Still pictures can be played back.
- AVCHD motion pictures can be played back on Panasonic televisions (VIERA) displaying the AVCHD logo.
- When using both SDHC and SDXC Memory Cards, be sure to play each type of card in equipment compatible with the particular format.
- You may not be able to play back panorama pictures. Also you cannot perform automatic scrolling playback of panorama pictures.

VIERA Link (HDMI) (HDAVI Control™)**What is VIERA Link (HDMI)?**

- VIERA Link is a function that automatically links this camera to VIERA Link-compatible devices by connecting HDMI mini cables (optional) for enabling easy operation with the VIERA remote control. (Some operations are not available.)
 - VIERA Link (HDMI) is an exclusive Panasonic function added to the industry-standard HDMI control functions known as HDMI CEC (Consumer Electronics Control). Operation is not guaranteed when connecting with non-Panasonic HDMI CEC-compatible devices. Refer to your product manual to verify compatibility with VIERA Link (HDMI).
 - This camera supports VIERA Link (HDMI) Version 5. This is the latest Panasonic standard that also supports previous Panasonic VIERA Link devices. (As of November 2011)
-
- Always use a genuine Panasonic HDMI mini cable (optional).
 - Cables that do not comply with HDMI standards will not work.
 - If you are unsure whether or not the TV you are using is compatible with VIERA Link, read the operating instructions for the TV.
 - If the [VIERA Link] setting on the camera is [ON], operations via the camera buttons will be limited.
 - Ensure that the television you are connecting to has been set up to enable VIERA Link (HDMI) (consult your television operating instructions for details).

Preparation: Set [VIERA Link] to [ON] (→59).

- 1 Connect the camera to a VIERA Link (HDMI)-compatible Panasonic television (VIERA) with an HDMI mini cable (optional)** (→156)
- 2 Turn on camera**
- 3 Set REC/PLAY switch to **
- 4 Proceed with the operation while referring to what is displayed on the TV screen**

• When operating, refer to the VIERA Link operating panel.

■ Other related operations

- Power OFF
The camera's power can also be switched off when switching the television's power off with the remote control.
- Automatic input select
 - This function automatically switches the television input to the camera screen whenever the camera's power is switched on while it is connected via the HDMI mini cable. The television can also be switched on via the camera from Standby Mode (if "Power on link" on the television is set to "on").
 - If VIERA Link (HDMI) does not function correctly (→183)
- To display a map on the TV screen choose [Display map] from the menu by remote control. (Option available only with VIERA Link (HDMI)) **DMC-TZ30** **DMC-TZ31**

Viewing 3D still pictures

If you connect this camera to a 3D-capable TV, and play back still pictures that you recorded in 3D, you can enjoy impressive 3D still pictures on the TV. If a 3D-capable TV has an SD card slot, you can play back 3D still pictures that you recorded by inserting the card into the slot.

For the latest information about devices that can play back 3D still pictures recorded with this camera, please refer to the following support website.

<http://panasonic.jp/support/global/cs/dsc/> (This Site is English only.)

Preparation: Set [3D Playback] to [3D] (→59).

1 Connect the camera to a 3D-capable TV by use of an HDMI mini cable (optional) to display the playback screen (→156)

2 Display still pictures recorded in 3D

- When the [VIERA Link] setting on the camera is set to [ON] and the camera is connected to a VIERA Link (HDMI)-compatible Panasonic television (VIERA), the television automatically switches its input and the playback screen is displayed.
- [3D] appears on the thumbnail of the 3D still pictures.

■ To select and play back only still pictures recorded in 3D

Select [3D Play] in [Filtering Play] of the [Playback Mode] menu (→114)

■ To perform Slide Show playback of only still pictures recorded in 3D

Select [3D Play] in [Slide Show] of the [Playback Mode] menu (→112)

■ The functions that are not operational or available for 3D still pictures:

- [Setup] menu
- [Playback] menu
- [GPS] menu **DMC-TZ30 DMC-TZ31**
- [Map] menu **DMC-TZ30 DMC-TZ31**
- Playback Zoom
- Delete

■ To switch the playback method for the still pictures recorded in 3D

- ① Select the picture recorded in 3D
 - ② Select [2D/3D Settings] on the [Playback Mode] menu and then press [MENU/SET] (→111)
- Playback method will switch to 3D if it is playing back in 2D (conventional image), or it will switch to 2D if it is playing back in 3D.
 - If you feel tired, uncomfortable or otherwise strange when playing back pictures recorded in 3D, set to 2D.

- On the LCD monitor of this camera, 3D still pictures will be played back in 2D (conventional pictures).
- If you switch between 3D still pictures and normal still pictures while playing back pictures, a black screen will be displayed for a few seconds.
- If you select a thumbnail of 3D still pictures or display a thumbnail after playing back 3D still pictures, it may take a few seconds to start playing back or displaying the pictures.
- Viewing 3D still pictures too close to a TV may cause eyestrain.
- When a TV has not been converted for viewing 3D still pictures, do necessary preparation on the TV. (For details about the necessary preparation of the TV, read the manual for the TV.)
- When an image is not suitable for 3D viewing (due to excessive parallax, etc.)
 - During Slide Show playback: The image is displayed in 2D.
 - During [Filtering Play]: A message appears confirming whether to display the image in 3D or not.
- When a 3D image is played back on a TV that is not 3D-capable, 2 pictures may appear side-by-side on the screen.
- You can store 3D still pictures on a computer or Panasonic recorder. (→162)

Keep the recorded still pictures and motion pictures

The methods for copying still and motion pictures recorded with this camera to other devices vary according to the file format (JPEG, MPO, AVCHD, MP4, Motion JPEG). Follow the correct method for your device.

Copy by inserting the SD card into the recorder

You can copy pictures using Panasonic equipment (such as Blu-ray disc recorders) with support for each file format.

Check the latest information about equipment that is compatible with this camera on the following website.

- Note that the equipment described may not be available in certain countries and regions.
<http://panasonic.jp/support/global/cs/dsc/> (This Site is English only.)

- See the instruction manual for the recorder for details for copying and playing back.

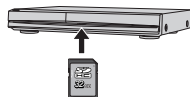

Dubbing playback pictures via AV cables (optional)

Videos that are played on this camera can be dubbed on media such as a disc, hard disk or videotape using a device such as a video recorder. This method is useful as it allows dubbing to be performed even with devices that are not compatible with high definition images. Picture quality will be reduced from high definition to standard definition. Audio will be monaural.

1 Connect camera to recorder

2 Start playback on camera

3 Start recording on recorder

- To stop recording (dubbing), stop the recording on your recorder first before stopping the playback on the camera.

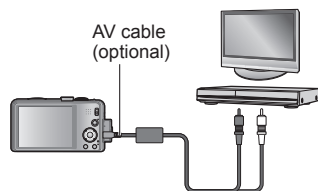

To recorder's input socket

- Always use a genuine Panasonic AV cable (optional).
- When using a TV with a 4:3 aspect ratio, always change the camera's [TV Aspect] setting (→59) to [4:3] before dubbing. Motion pictures copied in the [16:9] setting will appear vertically stretched when viewed on a 4:3 TV screen.
- For details on dubbing and playback methods, refer to your recorder's operating instructions.

Use “PHOTOfunSTUDIO” to copy to your computer

Using the “PHOTOfunSTUDIO” software on the supplied disc, you can save still pictures and motion pictures recorded with this camera in all file formats to a computer.

1 Install “PHOTOfunSTUDIO” to your computer

- For details about the software on the supplied disc, operation environment and installation, refer to Basic Operating Instructions.

2 Connect the camera to your computer

- For connection procedures (→165)

3 Use “PHOTOfunSTUDIO” to copy pictures to your computer

- For details on how to use “PHOTOfunSTUDIO”, see the “PHOTOfunSTUDIO” manual (PDF).

Files and folders containing copied AVCHD motion pictures cannot be played back or edited if they have been deleted, modified, or moved using Windows Explorer or similar methods. Always use “PHOTOfunSTUDIO” when handling AVCHD motion pictures.

Using with your PC

Still/motion pictures can be copied from the camera to your computer by connecting the two together.

- Some computers can read directly from the camera's memory card.
For details, see the manual for your computer.
- If your computer does not support SDXC Memory Cards a message will be displayed requesting you to format the card. (Do not format the card. This will erase recorded pictures.) If the card is not recognised, refer to the following support website.
<http://panasonic.net/avc/sdcard/information/SDXC.html>

■ Computer specifications

You can connect the camera to a computer that can detect a mass storage device (device that stores a large volume of data).

- Windows: Windows 7 / Windows Vista / Windows XP / Windows 2000 / Windows Me
- Mac: OS X v10.1 - v10.7

Some motion pictures recorded in [AVCHD] may not be scanned correctly by copying a file or folder.

- When using Windows, be sure to use the "PHOTOfunSTUDIO" software on the supplied disc to copy motion pictures recorded in [AVCHD].
- When using Mac, you can copy motion pictures recorded in [AVCHD] using "iMovie '11". Note, however, that you cannot copy motion pictures (AVCHD Progressive) recorded when [Rec Quality] is set to [GPH] **DMC-TZ30** **DMC-TZ31** and [PSH]. (For details about iMovie '11, please contact Apple Inc.)

Copying still pictures and motion pictures recorded in [MP4] and [High Speed Video] Scene Mode (except AVCHD motion pictures)

Preparation:

- Charge the battery sufficiently.
- When importing pictures from the built-in memory, remove any memory cards.
- Turn on the camera and computer.

Check socket direction and insert straight in.
(If the cable is inserted in the wrong direction, the socket could become deformed and cause faulty operation)

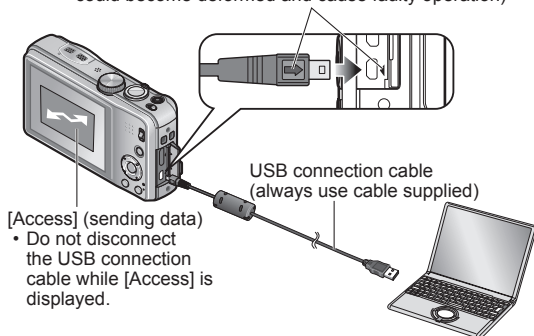

1 Connect camera to computer

- Please make sure you use the supplied USB connection cable. Use of cables other than the supplied USB connection cable may cause malfunction.

2 Use cursor button on the camera to select [PC], and press [MENU/SET]

- A message may be displayed on screen if [USB Mode] (→58) is set to [PictBridge(PTP)]. Select [CANCEL] to close the screen, and set [USB Mode] to [PC].
- When [USB Mode] (→58) is set to [GPS assist data], the folder storing the pictures will not be displayed. Set [USB Mode] to [PC]. **DMC-TZ30** **DMC-TZ31**

3 Operate with your computer

You can save pictures to use on your computer by dragging and dropping folders and files into separate folders on your computer.

■ To cancel connection

Windows: Execute "Safely Remove Hardware" on the taskbar

Mac: Open the Finder and click the eject icon that appears on the sidebar

■ When using Windows XP, Windows Vista, Windows 7, or Mac OS X

The camera can be connected to your computer even if [USB Mode] (→58) is set to [PictBridge(PTP)].

- Only picture output can be performed.
- It may not be possible to import if there are 1000 or more pictures on the card.
- Motion pictures cannot be read. (Excluding [High Speed Video])

■ Folder and file names on computer

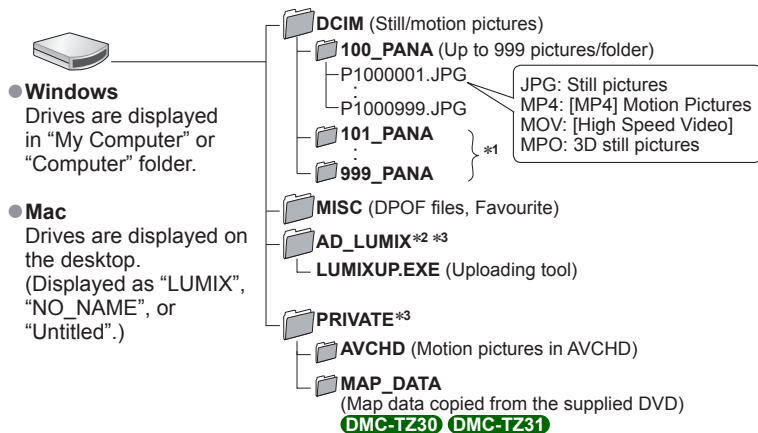

*1 New folders are created in the following cases:

- When pictures are taken to folders containing files numbered 999.
- When using cards already containing the same folder number (for example, pictures taken with other cameras, etc.).
- When recording after performing [No.Reset].

*2 Note that pictures cannot be uploaded to image-sharing websites if the files in the AD_LUMIX folder are deleted.

When "GPS Assist Tool" is copied to a memory card, it is stored in this folder.

DMC-TZ30 DMC-TZ31

*3 This folder is not created in the built-in memory.

- **Do not delete or modify folders or data in the AVCHD folder using Windows Explorer or other tools. The camera may be unable to play back the motion pictures correctly if any of these files are deleted or modified. For data management and editing of AVCHD motion pictures, use the "PHOTOfunSTUDIO" software on the supplied disc.**

- Do not use any other USB connection cables except the supplied one.
- Turn off power before inserting or removing memory cards.
- When the battery begins to run out during communication, a warning beep sounds. Cancel communication via your computer immediately. Use a sufficiently charged battery.
- Setting the [USB Mode] to [PC] removes the need to make the setting each time the camera is connected to the computer.
- For more details, consult your computer operating manual.

Uploading pictures to image-sharing websites

Using the uploading tool ([LUMIX Image Uploader]), you can upload still pictures and motion pictures to image-sharing websites (Facebook or YouTube).

There is no need to copy pictures to your computer or install specialised software.

Uploading pictures from the camera is easy with a computer connected to a network, even when you are away from your regular computing environment.

- This tool supports only computers that run on Windows XP, Windows Vista, and Windows 7.
- For more information, read the operating instructions (PDF) for the [LUMIX Image Uploader].

Preparation:

- Use [Upload Set] to select the pictures for uploading (→117)
- Connect your computer to the Internet
- Create an account for the applicable image-sharing website and prepare your login information

1 Double-click “LUMIXUP.EXE” to start it (→166)

- If you have installed “PHOTOfunSTUDIO” from the disc (supplied), “Uploading tool ([LUMIX Image Uploader])” may start automatically.

2 Select the upload destination

- Do the further steps in accordance with the instructions displayed on the computer screen.
- Because YouTube and Facebook services and specifications are subject to change, operation of online services cannot be guaranteed in the future. Available services and screens are subject to change without notice.
(This service is available as of 1st December, 2011)
- Do not upload pictures protected by copyright except when you are the copyright holder or permission has been obtained from the corresponding copyright holder.
- The pictures may contain information that identifies an individual, such as the title of a picture, recording date and time, information of the location where a picture was taken using a camera with GPS function, and so on. Before uploading the pictures to image-sharing websites, check the pictures carefully for information that should not be disclosed.

Printing

You can connect directly to a PictBridge-compatible printer for printing.

- Some printers can print directly from the camera's memory card.

For details, see the manual for your printer.

Preparation:

- Charge the battery sufficiently.
- When printing pictures from the built-in memory, remove any memory cards.
- Adjust the print quality or other settings on your printer, as needed.
- Turn on the camera and printer.

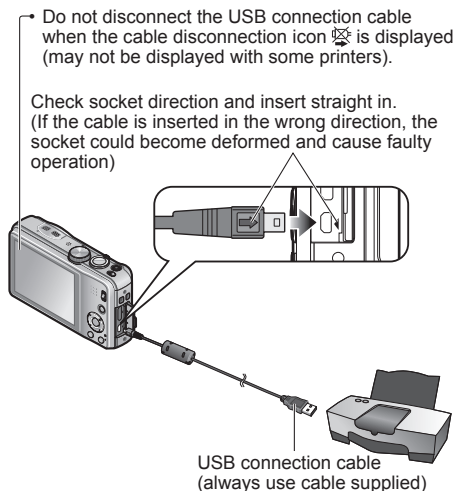

1 Connect camera to printer

- Please make sure you use the supplied USB connection cable. Use of cables other than the supplied USB connection cable may cause malfunction.

2 Use cursor button on the camera to select [PictBridge(PTP)], and press [MENU/SET]

3 Use cursor button to select a picture to print and press [MENU/SET]

4 Use cursor button to select [Print start] and press [MENU/SET] (Print settings (→171))

■ **To cancel print** Press [MENU/SET].

- Do not use any other USB connection cables except the supplied one.
- Disconnect USB connection cable after printing.
- Turn off power before inserting or removing memory cards.
- When the battery begins to run out during communication, a warning beep sounds. Cancel printing and disconnect USB connection cable. Use a sufficiently charged battery.
- Motion pictures cannot be printed.

Printing multiple pictures

1 Use cursor button to select **[Multi Print]** in step **3** (→168)

2 Use cursor button to select item and press **[MENU/SET]**

- **[Multi Select]:**
 - ① Scroll between pictures with cursor button, select pictures to print with the [DISP.] button. (Press [DISP.] button again to release selection.)
 - ② Press [MENU/SET] when selection is complete.
- **[Select All]:** Print all pictures.
- **[Print Set (DPOF)]:** Print pictures selected in [Print Set]. (→124)
- **[Favorite]:** Print pictures selected as [Favorite]. (→123)

3 Use cursor button to select **[Print start]** and press **[MENU/SET]**

(Print settings (→171))

- Select [Yes] if print confirmation screen is displayed.

- An orange “●” displayed during printing indicates an error message.
- Print may be divided into several pictures if printing a large amount of pictures. (Remaining sheets display may differ from the number of pictures set for printing.)

Print with date and text







■ Printing date without [Text Stamp]

- Printing in store: Only recording date can be printed. Request date printing in store.
 - Making [Print Set] (→124) settings on the camera in advance allows settings for numbers of copies and date printing to be designated before giving the card to the store.
 - When printing still pictures of 16:9 Aspect Ratio, check in advance that the store can accept this size.
- Using computer: Print settings for recording date and text information can be made using “PHOTOfunSTUDIO” on the supplied disc.
- Using printer: Recording date can be printed by setting [Print Set] on the camera, or by setting [Print with Date] (→171) to [ON] when connecting to a printer compatible with date printing.
- Time and date can be set to be printed on the picture when taking the picture by activating the [Date Stamp] function in the [Rec] menu. (→105)



Making print settings on the camera

Setting options include the number of printed pictures and their size. Make settings before selecting [Print start].

1 Use cursor button to select the item and press [MENU/SET]

Item	Settings
[Print with Date]	[ON]/[OFF]
[Num.of prints]	Set number of pictures (up to 999 pictures)
[Paper Size]	When  is selected, the printer settings take priority.
[Page Layout]	 (printer takes priority) /  (1 picture, no border) /  (1 picture, with border) /  (2 pictures) /  (4 pictures)

2 Use cursor button to select setting and press [MENU/SET]

- Items may not be displayed if incompatible with printer.
- To arrange  “2 pictures” or  “4 pictures” in the same still picture, set the number of prints for the still picture to 2 or 4.
- To print to paper sizes/layouts not supported by this camera, set to  and make settings on the printer. (Consult your printer’s operating manual.)
- Even with completed [Print Set] settings, dates may not be printed, depending on the shop or printer used.
- When setting [Print with Date] to [ON], check the date printing settings on the printer (printer settings may be prioritised).

List of LCD monitor displays

Screens shown here are only examples. The actual display may vary.

- Press the [DISP.] button to change display.

■ In recording

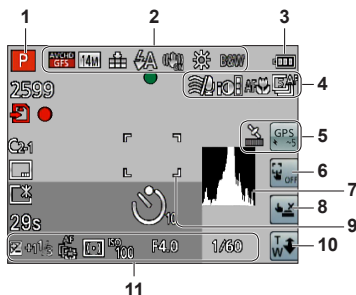

- 1 Recording Mode (→25)
- 2 Backlight Compensation (→32, 34)
Recording quality (→107)
Picture Size (→95)
Quality (→96)
Flash (→66)
Optical Image Stabiliser (→104)
Jitter alert (→27)
[Motion Deblur] (→33)
White Balance (→97)
Colour Mode (→103)
- 3 Battery capacity (→16)
- 4 Wind cut (→108)
Intelligent exposure (→101)
Macro recording (→68)
Burst Mode (→87)
Auto Bracket (→72)
- 5 GPS reception icon (→130)
DMC-TZ30 DMC-TZ31
Positioning result icons (→130)
DMC-TZ30 DMC-TZ31
- 6 Release the touch AF/AE function (→30)
- 7 Histogram (→62)
- 8 Touch shutter (→29)
- 9 AF area (→28)
- 10 Touch zoom (→64)
- 11 Exposure Compensation (→71)
AF Tracking (→35, 99)
AF Assist Lamp (→103)
Metering Mode (→101)
ISO Sensitivity (→96)
Aperture value/Shutter speed (→27, 73, 74)
Minimum shutter speed (→102)

(Continued on the next page)

Screens shown here are only examples. The actual display may vary.

- Press the [DISP.] button to change display.

■ In recording

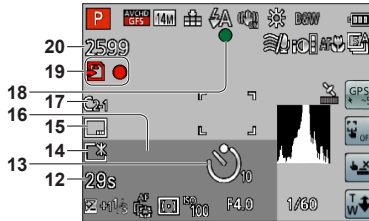

- | | |
|--|--|
| <p>12 Elapsed recording time*1 (→37)
[GPS Area Select] (→136)
DMC-TZ30 DMC-TZ31</p> <p>13 Self-timer Mode (→70)</p> <p>14 LCD Mode (→55)
LCD power save (→57)</p> <p>15 Date Stamp (→105)</p> <p>16 Current date/time
World time (→93)
Name*2 (→81)
Age in years/months*2 (→81)
Place name information*2 (→136)
DMC-TZ30 DMC-TZ31
Destination settings*2 (→92)
Travel elapsed days*2 (→92)</p> <div style="border: 1px solid gray; padding: 2px; margin: 5px 0;"> <p style="text-align: center;">2m ∞</p> <p style="text-align: center;">EZW ■■■■■■■■ T 15X</p> </div> <p>Focus range (→68)
Zoom (→63)</p> | <p>17 Custom Set (→85)</p> <p>18 Focus (→28)</p> <p>19 Save destination (→20)
Recording state</p> <p>20 Number of recordable pictures (→22)
Available recording time*1 (→37)</p> |
|--|--|

*1 XXmXXs, RXXmXXs
[m] and [s] indicate "minute" and "second".

*2 The displaying is performed in the following priority order: location name information, travel destination, name ([Baby]/[Pet]), and name ([Face Recog.]). When the place name information or the number of days elapsed from day of departure are displayed, age in years/months is not displayed. **DMC-TZ30 DMC-TZ31**

• The displaying is performed in the following priority order: travel destination, name ([Baby]/[Pet]), and name ([Face Recog.]). When the number of days elapsed from day of departure is displayed, age in years/months is not displayed. **DMC-TZ27**

Screens shown here are only examples. The actual display may vary.

- Press the [DISP.] button to change display.

■ In playback

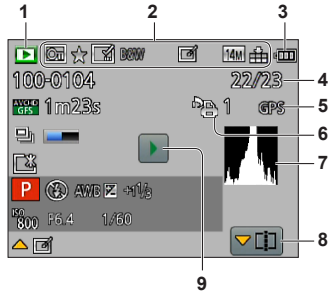

- | | |
|--|---------------------------------|
| 1 Playback Mode (→111) | 6 Print settings (→124) |
| 2 Protected picture (→125) | 7 Histogram (→62) |
| Favourites (→123) | 8 Video Divide (→48) |
| Date/text stamped display (→105, 119) | Burst group display (→109) |
| Colour Mode (→103) | 9 Motion picture playback (→45) |
| Retouched picture (→115, 116) | Panorama playback (→79) |
| Picture Size (→95) | Burst playback (→109) |
| Quality (→96) | |
| 3 Battery capacity (→16) | |
| 4 Picture number/Total pictures (→42) | |
| 5 GPS (→128) DMC-TZ30 DMC-TZ31 | |

(Continued on the next page)

Screens shown here are only examples. The actual display may vary.

- Press the [DISP.] button to change display.

■ In playback

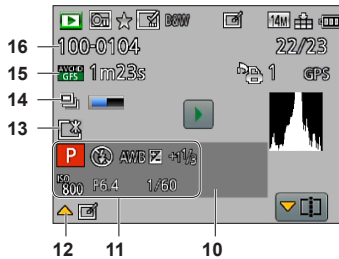

- | | |
|--|--|
| <p>10 Recording date/time
 World time (→93)
 Name*1 (→81)
 Age in years/months*1 (→81)
 Place name information*1 (→136)
 DMC-TZ30 DMC-TZ31
 Destination settings*1 (→92)
 Travel elapsed days*1 (→92)
 Title*1 (→118)</p> <p>11 Recording Mode (→25)
 Flash (→66)
 White Balance (→97)
 Exposure Compensation (→71)
 ISO Sensitivity (→96)
 Aperture value/Shutter speed (→27, 73, 74)
 Elapsed playback time*2 (→45)</p> <p>12 [Auto Retouch] (→115)
 [Creative Retouch] (→116)</p> <p>13 LCD Mode (→55)
 LCD power save (→57)</p> | <p>14 Burst information is being retrieved (→109)</p> <p>15 Recording quality (→107)
 Motion picture recording time*2 (→45)
 Number of burst pictures (→109)</p> <p>16 Folder/File number (→42, 166)
 Cable disconnection warning icon (→168)</p> |
|--|--|

*1 • The displaying is performed in the following priority order: location name information, title, travel destination, name ([Baby]/[Pet]), and name ([Face Recog.]). When the place name information or the number of days elapsed from day of departure are displayed, age in years/months is not displayed. **DMC-TZ30 DMC-TZ31**

• The displaying is performed in the following priority order: title, travel destination, name ([Baby]/[Pet]), and name ([Face Recog.]). When the number of days elapsed from day of departure is displayed, age in years/months is not displayed. **DMC-TZ27**

*2 XXmXXs

[m] and [s] indicate "minute" and "second".

Message displays

Meanings of and required responses to major messages displayed on LCD monitor.

[This memory card cannot be used]

- A MultiMediaCard was inserted.
→ Not compatible with the camera. Use a compatible card.

[Some pictures cannot be deleted] [This picture cannot be deleted]

- Non-DCF pictures (→42) cannot be deleted.
→ Save needed data on a computer or other device, and then use [Format] on the camera. (→60)

[No additional selections can be made]

- The number of pictures that can be deleted at once has been exceeded.
- More than 999 pictures have been set as [Favorite].
- The number of pictures allowing [Title Edit], [Text Stamp] or [Resize] (multiple settings) at once has been exceeded.

[Cannot be set on this picture]

- [Print Set], [Title Edit], or [Text Stamp] cannot be made for non-DCF pictures (→42).

[Please turn camera off and then on again] [System Error]

- The lens is not working correctly.
→ Turn on power again.
(Consult the dealer or your nearest Service Centre if display still remains)

[Some pictures cannot be copied] [Copy could not be completed]

- Pictures cannot be copied in following cases.
→ Picture of same name already exists in built-in memory when copying from card.
→ File is not of DCF standard (→42).
→ Picture taken or edited on a different device.

[Not enough space on built-in memory] [Not enough memory on the card]

- There is no space left on the built-in memory or the card. When you copy pictures from the built-in memory to the card (batch copy), the pictures are copied until the capacity of the card becomes full.

[Built-In Memory Error] [Format built-in memory?]

- Displayed when formatting built-in memory via computer, etc.
→ Reformat directly using camera. Data will be deleted.

[Memory card error. This card cannot be used in this camera. Format this card?]

- The card format cannot be used with this camera.
→ Save needed data on a computer or other device, and then use [Format] on the camera. (→60)

[Insert SD card again] [Try another card]

- Access to card has failed.
→ Insert card again.
- Try with a different card.

[Memory card parameter error]

- Card is not of SD standard.
- When cards in capacities of 4 GB or more are used, only SDHC or SDXC Memory Cards are supported.

[Read Error] / [Write Error] [Please check the card]

- Data read has failed.
→ Check whether card has been inserted correctly (→19).
- Data write has failed.
→ Turn off power and remove card, before re-inserting and turning on power again.
- Card may possibly be damaged.
- Try with a different card.

[Cannot record due to incompatible format(NTSC/PAL) data on this card.]

- Format the card after saving necessary data on a PC etc. (→60)
- Insert a different card.

[Motion recording was cancelled due to the limitation of the writing speed of the card]

- If recording stops even when using a card of the recommended speed class (→20), the data writing speed has dropped. If this happens, we recommend backing up the data on the memory card and formatting it (→60).
- Motion picture recording may be automatically terminated with certain cards.

[A folder cannot be created]

- Folder numbers in use have reached 999.
→ Save needed data on a computer or other device, and then use [Format] on the camera. (→60)
Folder number is reset to 100 when performing [No.Reset] (→58).

[Picture is displayed for 16:9 TV] [Picture is displayed for 4:3 TV]

- AV cable (optional) is connected to camera.
→ To remove message immediately → Press [MENU/SET].
→ To change aspect ratio → Change [TV Aspect] (→59).
- USB connection cable (supplied) is only connected to camera.
→ Message disappears when cable is also connected to another device.

[This battery cannot be used]

- Use a genuine Panasonic battery.
- Battery cannot be recognised as terminal is dirty.
→ Wipe any dirt away from the battery terminal.

[GPS feature is not available in this region.] **DMC-TZ30 **DMC-TZ31****

- GPS may not work in China or in the border regions of countries neighbouring China. (Current as of December 2011)

[Recording failed.]

- Recording may be impossible if the recording location for a 3D image is too dark/too bright, or if the subject lacks contrast.

Q&A Troubleshooting

Try checking these items (→178 - 185) first.

If the problem persists, performing [Reset] in the [Setup] menu may resolve the issue (→58). (Note that except for some items such as [Clock Set], all settings are returned to their values from the time of purchase.)

Battery, power

The charging lamp turns off before the battery is fully charged.

- Charging is being performed in a place with extremely high or low temperature.
→ Reconnect the USB connection cable (supplied) and retry charging in a place where ambient temperature is 10 °C to 30 °C (50 °F to 86 °F) (temperature conditions also apply to the battery itself).
(When the USB connection cable is reconnected after the battery is fully charged, the charging lamp will light for approximately 15 seconds.)

The charging lamp turns on again after it had turned off.

- The battery is being recharged.
→ If the battery charge level is low when the camera is turned off and [GPS Setting] is set to [ON], battery recharging may be started automatically.

Camera does not work even if power is turned on.

- Battery is not inserted correctly (→14), or needs recharging.

LCD monitor shuts off even if power is turned on.

Camera switches off as soon as power is turned on.

- [Sleep Mode] is activated. (→57)
→ Press shutter button halfway to release.
- Battery needs recharging.

This unit is turned off automatically.

- If you connect to a TV compatible with VIERA Link (HDMI) with an HDMI mini cable (optional) and turn off the power on the TV with the remote control for the TV, the power on this unit also turns off.
→ If you are not using VIERA Link (HDMI), set [VIERA Link] to [OFF]. (→59)

GPS DMC-TZ30 DMC-TZ31

Cannot perform positioning.

- When [GPS Setting] is set to [OFF]. (→129)
- Depending on the recording environment, such as when indoors or near buildings, it may not be possible to correctly receive the signals from the GPS satellites. (→128)
→ When using the GPS, we recommend holding the camera still for a while with the Built-in GPS antenna facing upward in an outdoor location where you can see the entire sky.



The GPS status indicator lights up while the camera's power is off.

- [GPS Setting] is [ON].
→ Electromagnetic waves from the camera can affect instruments and meters. In airplane cabins (during takeoff and landing) or in other restricted areas, set [GPS Setting] to [OFF] or set [Airplane Mode] to [ON], and then turn off the camera.

GPS (continued) DMC-TZ30 DMC-TZ31**Positioning takes time.**

- When using the camera for the first time or after not using it for a while, positioning may take several minutes.
- Positioning usually takes less than two minutes, but because the positions of the GPS satellites change, it may take longer depending on the recording location and environment.
→ Positioning can be executed faster when you download GPS assist data to the camera using the "GPS Assist Tool". (→141)
- Positioning will take time in environments where it is difficult to receive the signals from the GPS satellites. (→128)

The location name information is different from the recording location.

- Immediately after the camera's power is turned on or when the GPS icon is something other than , the location name information that is recorded in the camera may vary significantly from the current position.
- When  is displayed for the location name information, the information can be changed to a different candidate before starting to record. (→136)
- You can edit a place name or landmark name recorded in a picture.

The location name information is not displayed.

- "- -" is displayed if there is no nearby landmark or other points, or no information registered in the camera's database. (→131)
→ During playback, a location name or other information can be entered with [Edit Place Name]. (→138)

Map DMC-TZ30 DMC-TZ31**Cannot display detailed maps.**

- Use the "LUMIX Map Tool" software on the DVD (supplied) to copy map data from the DVD. (→150)

Some place names are not displayed.

- Detailed maps are displayed when you copy map data from the DVD (supplied). (→150)
(Note, however, that not all place names are stored in the DVD.)
- Place names may not be displayed for some map scale settings.
→ Enlarge the map scale.

It takes time to copy the map data.

- Since the map data size is large, it may take time to copy the map data. We recommend copying the map data of a required area only.
- When you copy map data by connecting the camera to the computer, it may take longer than the time required for copying the data using the commercially available card reader/writer.

Recording**Cannot record pictures.**

- REC/PLAY switch is not set to  (record).
- Built-in memory/card is full. → Free space by deleting unwanted pictures (→49).

Recorded pictures look white.

- Lens is dirty (fingerprints, etc.).
→ Turn on power to extract lens barrel, and clean lens surface with a soft, dry cloth.
- Lens is foggy (→6).

Recorded pictures are too bright/too dark.

- Adjust the exposure (→71).
- [Min. Shtr Speed] is set to fast speed. Check the setting (→102).

Recording (continued)

Some pictures are taken when I press the shutter button just once.

- Camera is set to use [Auto Bracket] or [Burst].

Focus not aligned correctly.

- Not set to mode appropriate for distance to subject. (Focus range varies according to recording mode.)
- Subject outside of focus range. (→68)
- Caused by jitter or subject movement. (→27)

Recorded pictures are blurred. Optical Image Stabiliser ineffective.

- Shutter speed is slower in dark locations and Optical Image Stabiliser is less effective.
→ Hold camera firmly with both hands, keeping arms close to body.
- Use a tripod and the self-timer (→70) when using slower shutter speed with [Min. Shtr Speed].

Cannot use [Auto Bracket].

- Only enough memory for 2 pictures or fewer.

Recorded pictures appear coarse, or there is interference.

- ISO Sensitivity is high, or shutter speed is low.
(Default [Sensitivity] setting is [AUTO] – interference may appear with indoor pictures.)
→ Lower [Sensitivity] (→96).
→ Take pictures in brighter locations.
- Camera set to [High Sens.] Scene mode.
(Picture becomes slightly coarser in response to high sensitivity)

Striping or flicker may appear under lighting such as fluorescent lighting and LED lighting fixture.

- This is characteristic of MOS sensors which serve as the camera's pickup sensors.
This is not a malfunction.

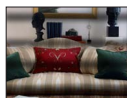

Brightness or colouring of recorded picture different from real life.

- When recording under fluorescent or LED lighting fixture etc., increasing the shutter speed may introduce slight changes to brightness and colour. These are a result of the characteristics of the light source and do not indicate a malfunction.
- When recording subjects in extremely bright locations or recording under fluorescent lighting, LED lighting fixture, mercury lamp, sodium lighting etc., the colours and screen brightness may change or horizontal striping may appear on the screen.

Reddish horizontal streaks appear on the LCD monitor during recording.

- This is characteristic of MOS sensors which serve as the camera's pickup sensors. It appears when the subject has a bright part. Some unevenness may occur in the surrounding areas, but this is not a malfunction. It is recorded in motion pictures but is not recorded on still pictures.
- It is recommended that you take pictures while taking care not to expose the screen to sunlight or any other source of strong light.

Motion picture recording stops midway.

- Motion pictures can be recorded continuously for up to 29 minutes 59 seconds. Also, motion picture recorded continuously in [MP4] is up to 4 GB. (In this case, you can continuously record a motion picture in [FHD] for up to approx. 27 minutes 12 seconds.)
- If the surrounding temperature is high, or a motion picture is recorded continuously,  is displayed and recording may be stopped halfway through to protect the camera. (Only when [Rec Quality] is set to [GPH] **DMC-TZ30** **DMC-TZ31**, [PSH], [GFS] **DMC-TZ30** **DMC-TZ31** or [FSH])
- With some cards, access display may appear briefly after recording, and recording may end midway.
- If recording stops even when using a card of the recommended speed class (→20), the data writing speed has dropped. If this happens, we recommend backing up the data on the memory card and formatting it (→60).

Recording (continued)

Panorama picture recording stops before finishing.

- If the pan motion of the camera is too slow, the camera assumes that the operation has been aborted and stops recording.
- If the pan motion of the camera is too shaky when it is moved toward the recording direction, the camera stops recording.
→ To record panorama pictures, pan the camera in a small circular motion parallel to the recording direction at a speed of approx. 8 seconds per revolution (guideline).

The subject cannot be locked. (AF track fails)

- If the colour of the subject is similar to that of its background, AF Tracking may not function. Set the AF area to those colours specific to the subject by aligning that area with the AF area.

LCD monitor

Brightness is unstable.

- Aperture value is set while shutter button is pressed halfway. (Does not affect recorded picture.) This symptom may also occur when the brightness changes because the zoom is operated or the camera is moved. This is the automatic aperture operation of the camera and is not a malfunction.

Monitor flickers indoors.

- The LCD monitor may flicker for a few seconds after turning on. This is an operation to correct flicker caused by lighting such as fluorescent lights, LED lights etc. and is not a malfunction.

Monitor is too bright/too dark.



- [LCD Mode] is activated (→55)
- Use [LCD Display] to adjust the brightness of the LCD monitor. (→55)

Black/blue/red/green dots or interference appears. Monitor looks distorted when touched.

- This is not a fault, and will not be recorded on the actual pictures.

Flash

No flash emitted.

- Flash set to  [Forced Flash Off] (→66).
- The flash becomes unavailable in the following cases :
 - [Auto Bracket]
 - [Burst] (However, when  [Flash Burst] is selected, the flash is fixed to  [Forced Flash On].)
 - Scene Modes ([Scenery] [Panorama Shot] [Night Scenery] [Handheld Night Shot] [HDR] [Sunset] [Glass Through] [High Speed Video])
 - [3D Photo Mode]
 - [Creative Control] Mode

Multiple flashes are emitted.

- Red-eye reduction is active (→66). (Flashes twice to prevent eyes appearing red.)
- [Burst] is set to [Flash Burst] (→87).

Playback

Pictures have been rotated.

- [Rotate Disp.] is activated (→60)

Cannot view pictures. There are no recorded pictures.

- REC/PLAY switch is not set to  (play).
- No pictures in built-in memory or card (pictures played from card if inserted, from built-in memory if not).
- Has the file name of the picture been changed on a computer? If so, it cannot be played back on the camera.
- The [Playback Mode] has been changed.
→ Set [Playback Mode] to [Normal Play] (→111).

Folder/file number displayed as [-]. Picture is black.

- Picture edited on computer or taken on different device.
- Battery removed immediately after picture taken, or picture taken with low battery.
→ Use [Format] to delete (→60).

Incorrect date displayed in Calendar Playback.

- Picture edited on computer or taken on different device.
- [Clock Set] is incorrect (→24).
(Incorrect date may be displayed in Calendar Playback on pictures copied to computer and then back to camera, if computer and camera dates differ.)

White round spots like soap bubbles appear on the recorded picture.





- If you take a picture with the flash in a dark place or indoors, white round spots may appear on the picture caused by the flash reflecting particles of dust in the air. This is not a fault. A characteristic of this is that the number of round spots and their position differ in every picture.



[Thumbnail is displayed] is shown on the screen.

- The pictures may have been recorded on another device. If so, they may be displayed with poor picture quality.

Blacken red areas of recorded pictures.

- When digital red-eye correction (, ) is operating, if a subject is recorded that has skin-coloured areas with red areas inside, the digital red-eye correction function may blacken the red areas.
→ We recommend setting the flash to ,  or , or [Red-Eye Removal] to [OFF] before recording.

Sounds of camera operations such as zoom will be recorded in motion pictures.

- Camera operation sounds may be recorded as camera automatically adjusts lens aperture during motion picture recording; this is not a fault.

Motion pictures taken by this camera cannot be played in other cameras.

- When motion pictures recorded in [AVCHD], [MP4] or [High Speed Video] (Motion JPEG) are played back, they may be displayed with poor picture quality or sound quality or may not be played back at all even if an AVCHD, MP4 or Motion JPEG compatible device is used. Also, there might be a case that a recording information does not display correctly.

TV, computer, printer

No image appears on TV. Image blurred or not coloured.

- Not connected correctly (→156).
- The television has not been switched to auxiliary input.
- Check the [Video Out] setting (NTSC/PAL) on the camera. (→59)

TV screen display different to LCD monitor.

- Aspect ratio may be incorrect or edges may be cut off with certain televisions.

Cannot play motion pictures on TV.

- Card is inserted into TV.
→ Connect with AV cable (optional) or HDMI mini cable (optional) and play on camera (→156).

Picture is not displayed on full TV screen.

- Check [TV Aspect] settings (→59).

VIERA Link (HDMI) is not working.

- Is the HDMI mini cable (optional) connected correctly? (→156)
→ Check that the HDMI mini cable (optional) is fully inserted.
- Is the camera's [VIERA Link] setting set to [ON]? (→59)
→ The input setting may not be able to be changed automatically with certain television HDMI sockets. In this case, please change the input setting with your television's remote control (consult your television's operating instructions for details).
→ Check the VIERA Link (HDMI) settings on the device you are connecting to.
→ Turn the camera's power off and on again.
→ Turn the "VIERA Link control (HDMI device control)" setting on your television (VIERA) to off and then to on again. (Consult your VIERA's operating instructions for details.)

Cannot communicate with the computer.

- Not connected correctly (→165).
- Check whether computer has recognised camera.
→ Set [USB Mode] to [PC] (→58).
→ Turn the unit off and then back on again.

Computer does not recognise card (only reads built-in memory).

- Disconnect USB connection cable (supplied) and reconnect with card in place.

Computer does not recognise card. (When using an SDXC Memory Cards)

- Check whether your computer is compatible with SDXC Memory Cards.
<http://panasonic.net/avc/sdcard/information/SDXC.html>
- A message prompting you to format the card may appear when you connect it. Do not format the card.
- If the [Access] indicator on the LCD monitor does not go off, turn off the camera's power before disconnecting the USB connection cable.

Uploading to YouTube or Facebook cannot be performed properly.

- Confirm that the login information (login ID, user name, e-mail address and password) is correct.
- Confirm that the computer is connected to the Internet.
- Confirm that the resident software (such as anti-virus software and the firewall, etc.) is not blocking access to YouTube or Facebook.
- Check the YouTube or Facebook site.

TV, computer, printer (continued)**Cannot print when connecting to printer.**

- Printer not compatible with PictBridge.
- Set [USB Mode] to [PictBridge(PTP)] (→58).

The edges of pictures are cut off when printing.

- Release any trimming or edgeless printing settings on printer before printing.
(Consult printer operating manual.)
- The pictures were recorded in **16:9** aspect ratio.
→ If printing in shop, check if 16:9 sizes can be printed.

Cannot print panorama pictures properly.

- The aspect ratio of panorama pictures is different from that of regular still pictures, and some panorama pictures may not be printed correctly.
→ Use a printer with support for panorama pictures. (Refer to the instruction manual for the printer.)
→ We recommend adjusting the size of a picture in accordance with print paper using the "PHOTOfunSTUDIO" software on the disc (supplied).

Others**Menu not displayed in desired language.**

- Change [Language] setting (→61).

Camera rattles if shaken.

- This sound is made by the lens movement and is not a fault.

Red lamp illuminated when pressing shutter button halfway in dark locations.

- [AF Assist Lamp] is set to [ON] (→103).

AF Assist Lamp is not illuminated.

- [AF Assist Lamp] is set to [OFF] (→103).
- Not illuminated in bright locations.

Camera is hot.

- Camera may become a little warm during use, but this does not affect performance or quality.

Lens makes a clicking noise.

- When brightness changes, the lens may make a clicking noise and the monitor brightness may also change, but this is due to aperture settings being made.
(Does not affect recording.)

Clock is incorrect.

- Camera has been left for a long period.
→ Reset the clock (→24).
- A long time was taken to set the clock (clock will be behind by the same lapse of time).

When using zoom, picture becomes slightly warped and the edges of the subject become coloured.

- Pictures may be slightly warped or coloured around the edges, depending on the zoom ratio, but this is not a fault.

Zoom movement stops momentarily.

- The zoom movement stops momentarily during Extra Optical Zoom operation, but this is not a malfunction.

Zoom does not reach the maximum ratio.

- If the zoom ratio stops at 3 x, [Macro Zoom] has been set. (→69)

File numbers are not recorded in sequence.

- File numbers are reset when new folders are created (→166).

File numbers have jumped backwards.

- Battery was removed/inserted with power on.
(Numbers may jump backwards if folder/file numbers are not correctly recorded.)

When no operation is performed for a while, the demo is suddenly displayed.

- This is the Automatic Demo Mode that introduces the features of this camera.
Press [MENU/SET] to return to the previous screen.

Usage cautions and notes

When in use

- Camera may become warm if used for long periods of time, but this is not a fault.
- **Keep this unit as far away as possible from electromagnetic equipment (such as microwave ovens, TVs, video games etc.).**
 - If you use this unit on top of or near a TV, the pictures and/or sound on this unit may be disrupted by electromagnetic wave radiation.
 - Do not use this unit near cell phones because doing so may result in noise adversely affecting the pictures and/or sound.
 - Recorded data may be damaged, or pictures may be distorted, by strong magnetic fields created by speakers or large motors.
 - Electromagnetic wave radiation generated by microprocessors may adversely affect this unit, disturbing the pictures and/or sound.
 - If this unit is adversely affected by electromagnetic equipment and stops functioning properly, turn this unit off and remove the battery or disconnect AC adaptor (supplied). Then reinsert the battery or reconnect AC adaptor and turn this unit on.

Do not use this unit near radio transmitters or high-voltage lines.

- If you record near radio transmitters or high-voltage lines, the recorded pictures and/or sound may be adversely affected.
- Do not extend the supplied cord or cable.
- Do not allow camera to come into contact with pesticides or volatile substances (can cause surface damage or coating to peel).
- Never leave the camera and the battery in a car or on a car hood in the summer. It may cause leakage of the battery electrolyte, a generation of heat, and may cause a fire and the battery to burst due to the high temperature.

Caring for your camera

To clean your camera, remove the battery or disconnect the power plug from the outlet, and wipe with a soft, dry cloth.

- Use a damp cloth to remove stubborn stains, before wiping with a dry cloth.
- Do not use benzine, thinners, alcohol, or kitchen detergent, as these may damage the outer casing and finish of the camera.
- If using a chemically-treated cloth, read the supplied instructions carefully.
- Do not touch the lens barrier.

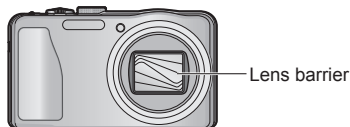

When not using for a while

- Turn off camera power before removing battery and card (ensure that battery is removed to prevent damage through over-discharge).
- Do not leave in contact with rubber or plastic bags.
- Store together with a drying agent (silica gel) if leaving in drawer, etc. Store batteries in cool (15 °C to 25 °C (59 °F to 77 °F)) places with low humidity (40%RH to 60%RH) and no major temperature changes.
- Charge battery once per year and use completely before storing again.

Memory cards

- To prevent damage to cards and data
 - Avoid high temperatures, direct sunlight, electromagnetic waves, and static electricity.
 - Do not bend, drop, or expose to strong impacts.
 - Do not touch terminals on reverse of card or allow them to become dirty or wet.
- When disposing of/transferring memory cards
 - If using the "format" or "delete" functions on your camera or computer, this only changes the file management information, and does not completely delete the data from within the memory card. When disposing of or transferring your memory cards, we recommend physically destroying the memory card itself, or using commercially available computer data erasing software to completely delete the data from the card. Data within memory cards should be managed responsibly.

LCD Monitor

- Do not press hard on the LCD monitor. This may cause uneven display and damage the monitor.
- In cold climates or other situations when the camera becomes cold, the LCD monitor may appear slightly darker than normal immediately after the camera is turned on. Normal brightness will return once the internal components have warmed up.

Extremely high precision technology is employed to produce the LCD monitor screen. However there may be some dark or bright spots (red, blue or green) on the screen. This is not a malfunction. The LCD monitor screen has more than 99.99% effective pixels with a mere 0.01% of the pixels inactive or always lit. The spots will not be recorded on pictures on the built-in memory or a card.

About charging the battery

- The time required for charging varies depending on conditions of battery usage. Charging takes longer at high or low temperatures and when the battery has not been used in some time.
- Battery will be warm during charging and for some time thereafter.
- Battery will run out if not used for long periods of time, even after being charged.
- Do not leave any metal items (such as clips) near the contact areas of the power plug. Otherwise, a fire and/or electric shocks may be caused by short-circuiting or the resulting heat generated.
- Frequently charging up battery is not recommended.
(Frequently charging battery reduces maximum usage time and can cause battery to expand.)
- If available battery power is significantly reduced, battery is reaching end of lifespan. Please purchase a new battery.
- When charging:
 - Wipe dirt from the battery terminal with a dry cloth.
 - Keep at least 1 m (3.3 feet) away from AM radio (may cause radio interference).
- Do not use a damaged or dented battery (especially connectors), e.g. by dropping (can cause faults).

About AC adaptor (supplied)

- Keep at least 1 m (3.3 feet) away from AM radio (may cause radio interference).
- The AC adaptor (supplied) may generate whirring sounds when it is being used. This is not a malfunction.
- After use, be sure to disconnect the power supply device from the electrical outlet. (A very small amount of current is consumed if it is left connected.)

Lens

- Images may appear slightly white if lens is dirty (fingerprints, etc.). Turn the power on, hold the extracted lens barrel with your fingers, and gently wipe the lens surface with a soft, dry cloth.
- Do not leave the lens exposed to direct sunlight.
- Do not touch the lens barrier, as this may damage lens. Be careful when removing camera from bag, etc.

When using a tripod or unipod

- Do not apply excessive force or tighten screws when they are crooked. (This may damage the camera, screw hole, or label.)
- Ensure that the tripod is stable. (Refer to the tripod instructions.)
- You may not be able to remove the card or the battery when using a tripod or unipod.

About 3D viewing

- Anyone who is hypersensitive to light, suffers from heart disease or is otherwise unwell should avoid viewing 3D contents.
 - Viewing 3D contents may have an adverse effect to the individual.
- If you feel tired, uncomfortable or otherwise strange when viewing 3D contents, stop viewing at once.
 - Continuing to view may cause illness.
 - After stopping viewing, please rest appropriately.
- When viewing 3D contents, we recommend taking a break every 30 to 60 minutes.
 - Viewing for extended periods may cause eye-fatigue.
- Short-sighted or long-sighted persons, those with differences in the sight of their right and left eyes, and those with astigmatism are advised to correct their vision by wearing glasses etc. Stop viewing if you can clearly see a double image while viewing 3D contents.
 - There are differences in the way that different people experience 3D contents. Please correct your sight appropriately before viewing 3D contents.
 - You can change the 3D setting of your television or 3D output setting of the unit to 2D.

Personal Information

If names or birthdays are set in [Baby] Mode or in the [Face Recog.] function, keep in mind that the camera and recorded pictures will contain personal information.

- Disclaimer
 - Data containing personal information can be altered or lost due to malfunction, static electricity, accidents, breakdowns, repairs, or other operations. Panasonic will not be liable for any damage that occurs, direct or indirect, as a result of the alteration or loss of data containing personal information.
- When ordering repairs or transferring/disposing of the camera
 - To protect your personal information, please reset the settings. (→58)
 - If any pictures are contained in the built-in memory, copy (→127) them to a memory card if necessary, and then format (→60) the built-in memory.
 - Remove the memory card from the camera.
 - When ordering repairs, the built-in memory and other settings may be returned to the initial purchase state.
 - If the above operations cannot be performed because of a camera malfunction, consult with the dealer or nearest Service Centre.

When transferring or disposing of your memory card, see “When disposing of/transferring memory cards” in the previous section (→187).

Important! Be sure to read the following before using the location names that are stored in this product.

Licence Agreement for Place Name and Map Data

Personal Use Only.

You agree to use this Data together with this digital camera for the solely personal, non-commercial purposes for which you were licensed, and not for service bureau, time-sharing or other similar purposes. Accordingly, but subject to the restrictions set forth in the following paragraphs, you agree not to otherwise reproduce, copy, modify, decompile, disassemble or reverse engineer any portion of this Data, and may not transfer or distribute it in any form, for any purpose, except to the extent permitted by mandatory laws. Multi-disc sets may only be transferred or sold as a complete set as provided by Panasonic Corporation and not as a subset thereof.

Restrictions.

Except where you have been specifically licensed to do so by Panasonic Corporation, and without limiting the preceding paragraph, you may not (a) use this Data with any products, systems, or applications installed or otherwise connected to or in communication with vehicles, capable of vehicle navigation, positioning, dispatch, real time route guidance, fleet management or similar applications; or (b) with or in communication with any positioning devices or any mobile or wireless-connected electronic or computer devices, including without limitation cellular phones, palmtop and handheld computers, pagers, and personal digital assistants or PDAs.

Warning.

The Data may contain inaccurate or incomplete information due to the passage of time, changing circumstances, sources used and the nature of collecting comprehensive geographic data, any of which may lead to incorrect results.

No Warranty.

This Data is provided to you “as is,” and you agree to use it at your own risk. Panasonic Corporation and its licensors (and their licensors and suppliers) make no guarantees, representations or warranties of any kind, express or implied, arising by law or otherwise, including but not limited to, content, quality, accuracy, completeness, effectiveness, reliability, fitness for a particular purpose, usefulness, use or results to be obtained from this Data, or that the Data or server will be uninterrupted or error-free.

Disclaimer of Warranty:

PANASONIC CORPORATION AND ITS LICENSORS (INCLUDING THEIR LICENSORS AND SUPPLIERS) DISCLAIM ANY WARRANTIES, EXPRESS OR IMPLIED, OF QUALITY, PERFORMANCE, MERCHANTABILITY, FITNESS FOR A PARTICULAR PURPOSE OR NON-INFRINGEMENT. Some States, Territories and Countries do not allow certain warranty exclusions, so to that extent the above exclusion may not apply to you.

Disclaimer of Liability:

PANASONIC CORPORATION AND ITS LICENSORS (INCLUDING THEIR LICENSORS AND SUPPLIERS) SHALL NOT BE LIABLE TO YOU: IN RESPECT OF ANY CLAIM, DEMAND OR ACTION, IRRESPECTIVE OF THE NATURE OF THE CAUSE OF THE CLAIM, DEMAND OR ACTION ALLEGING ANY LOSS, INJURY OR DAMAGES, DIRECT OR INDIRECT, WHICH MAY RESULT FROM THE USE OR POSSESSION OF THE INFORMATION; OR FOR ANY LOSS OF PROFIT, REVENUE, CONTRACTS OR SAVINGS, OR ANY OTHER DIRECT, INDIRECT, INCIDENTAL, SPECIAL OR CONSEQUENTIAL DAMAGES ARISING OUT OF YOUR USE OF OR INABILITY TO USE THIS INFORMATION, ANY DEFECT IN THE INFORMATION, OR THE BREACH OF THESE TERMS OR CONDITIONS, WHETHER IN AN ACTION IN CONTRACT OR TORT OR BASED ON A WARRANTY, EVEN IF PANASONIC CORPORATION OR ITS LICENSORS HAVE BEEN ADVISED OF THE POSSIBILITY OF SUCH DAMAGES. Some States, Territories and Countries do not allow certain liability exclusions or damages limitations, so to that extent the above may not apply to you.

Export Control.

Panasonic Corporation shall not export from anywhere any part of the Data or any direct product thereof except in compliance with, and with all licenses and approvals required under, applicable export laws, rules and regulations, including but not limited to the laws, rules and regulations administered by the Office of Foreign Assets Control of the U.S. Department of Commerce and the Bureau of Industry and Security of the U.S. Department of Commerce. To the extent that any such export laws, rules or regulations prohibit NT from complying with any of its obligations hereunder to deliver or distribute Data, such failure shall be excused and shall not constitute a breach of this Agreement.

Entire Agreement.

These terms and conditions constitute the entire agreement between Panasonic Corporation (and its licensors, including their licensors and suppliers) and you pertaining to the subject matter hereof, and supersedes in their entirety any and all written or oral agreements previously existing between us with respect to such subject matter.

About Location Information, Place Name Information, and Maps

About the geographical coordinate system

The latitude and longitude standard (geographical coordinate system) recorded with this camera is WGS84.

Mapple Digital Map Data

These maps were prepared using the following maps of the Geospatial Information Authority of Japan (GSI), with the approval of the Director General of GSI: 1:25,000 scale topographic maps, 1:200,000 scale regional maps, 1:1,000,000 scale maps of Japan, and 1:500,000 scale district maps. (Approval nos. for use of 2011 information: nos. 15-, 13-, and 12-M055541)

About copyright

According to copyright law, the map data stored in this camera may not be used for purposes other than personal use without the permission of the copyright holder.

About navigation functions

This camera is not equipped with a navigation function.

Notices related to licensed software copyright holders



© 2011 NAVTEQ. All rights reserved.



MAPPLE

"MAPPLE" is a trademark of Shobunsha Publications, Inc.

This data includes information taken with permission from Canadian authorities, including © Her Majesty the Queen in Right of Canada, © Queen's Printer for Ontario, © Canada Post Corporation, GeoBase®, © Department of Natural Resources Canada. All rights reserved.

© United States Postal Service® 2011, USPS®, ZIP+4®

Fuente: INEGI (Instituto Nacional de Estadística y Geografía)

Traffic Codes for Belgium are provided by the Ministerie van de Vlaamse Gemeenschap and the Ministère de l'Équipement et des Transports.

Territory	Notice
Australia	© Hema Maps Pty. Ltd, 2011. Copyright. Based on data provided under license from PSMA Australia Limited (www.pasma.com.au). Product incorporates data which is © 2011 Telstra Corporation Limited, GM Holden Limited, Intelematics Australia Pty Ltd, NAVTEQ International LLC, Sentinel Content Pty Limited and Continental Pty Ltd.
Austria	"© Bundesamt für Eich- und Vermessungswesen"
Croatia, Cyprus, Estonia, Latvia, Lithuania, Moldova, Poland, Slovenia and/or Ukraine	"© EuroGeographics"
Ecuador	INSTITUTO GEOGRAFICO MILITAR DEL ECUADOR AUTORIZACION N° IGM-2011-01- PCO-01 DEL 25 DE ENERO DE 2011
France	The following notice must appear on all copies of the Data, and may also appear on packaging: "source: © IGN France – BD TOPO ®"
Germany	"Die Grundlagendaten wurden mit Genehmigung der zuständigen Behörden entnommen" or "Die Grundlagendaten wurden mit Genehmigung der zustaendigen Behoerden entnommen."
Great Britain	"Contains Ordnance Survey data © Crown copyright and database right 2010 Contains Royal Mail data © Royal Mail copyright and database right 2010"
Greece	"Copyright Geomatics Ltd."
Guadeloupe, French Guiana Martinique	"source: © IGN 2009 - BD TOPO ®"
Guatemala	"Aprobado por el INSTITUTO GEOGRAFICO NACIONAL – Resolución del IGN N° 186-2011"
Hungary	"Copyright © 2003; Top-Map Ltd."
Israel	"© Survey of Israel data source"
Italy	"La Banca Dati Italiana è stata prodotta usando quale riferimento anche cartografia numerica ed al tratto prodotta e fornita dalla Regione Toscana."
Jordan	"© Royal Jordanian Geographic Centre". The foregoing notice requirement for Jordan Data is a material term of the Agreement. If Client or any of its permitted sublicensees (if any) fail to meet such requirement, NT shall have the right to terminate Client's license with respect to the Jordan Data.
Mozambique	"Certain Data for Mozambique provided by Cenacarta © 2011 by Cenacarta"
Norway	"Copyright © 2000; Norwegian Mapping Authority"
Portugal	"Source: IgeoE – Portugal"
Réunion	"source: © IGN 2009 - BD TOPO ®"
Spain	"Información geográfica propiedad del CNIG"
Nepal	Copyright © Survey Department, Government of Nepal.

Territory	Notice
Sri Lanka	This product incorporates original source digital data obtained from the Survey Department of Sri Lanka © 2009 Survey Department of Sri Lanka The data has been used with the permission of the Survey Department of Sri Lanka
Sweden	"Based upon electronic data © National Land Survey Sweden."
Switzerland	"Topografische Grundlage: © Bundesamt für Landestopographie."

■ Landmark types

Although approx. 1,000,000 landmarks are registered in the built-in memory, there are also some unregistered landmarks. (The registered information is current as of December 2011 and will not be updated.)

- It differs from that registered on our GPS-equipped models before 2011.

Zoo	Botanical garden	Aquarium
Amusement park	Golf course	Camp sites
Ski resorts	Skating rinks	Outdoor activity sites
Famous site, tourist attraction, beauty spot	Castle, ruins	Shrine
Temple	Church	Tomb, monument, mound, historic site
Airport	Port	Ferry terminal
Baseball park	Athletics ground	Gymnasium
Park	Station	Prefectural or state office
Lifts, cable cars	Art museum	History museum
Theatre	Cinemas, performing theatres	Wineries, breweries
Mountains, meadows, passes	Canyons, mountain streams, waterfalls, valleys, seashores	Tower, high-rise building

HDMI

AVCHD™
Progressive

DOLBY
DIGITAL
STEREO CREATOR



- HDMI, the HDMI Logo, and High-Definition Multimedia Interface are trademarks or registered trademarks of HDMI Licensing LLC in the United States and other countries.
- HDAVI Control™ is a trademark of Panasonic Corporation.
- “AVCHD Progressive”, “AVCHD”, the “AVCHD Progressive” Logo and the “AVCHD” Logo are trademarks of Panasonic Corporation and Sony Corporation.
- Manufactured under license from Dolby Laboratories. Dolby and the double-D symbol are trademarks of Dolby Laboratories.
- SDXC Logo is a trademark of SD-3C, LLC.
- QuickTime and the QuickTime logo are trademarks or registered trademarks of Apple Inc., used under license therefrom.
- Windows and Windows Vista are either registered trademarks or trademarks of Microsoft Corporation in the United States and/or other countries.
- iMovie, Mac and Mac OS are trademarks of Apple Inc., registered in the U.S. and other countries.
- YouTube is a trademark of Google Inc.
- This product uses “DynaFont” from DynaComware Corporation. DynaFont is a registered trademark of DynaComware Taiwan Inc.
- Other names, company names, and product names printed in these instructions are trademarks or registered trademarks of the companies concerned.

This product is licensed under the AVC patent portfolio license for the personal and non-commercial use of a consumer to (i) encode video in compliance with the AVC Standard (“AVC Video”) and/or (ii) decode AVC Video that was encoded by a consumer engaged in a personal and non-commercial activity and/or was obtained from a video provider licensed to provide AVC Video. No license is granted or shall be implied for any other use. Additional information may be obtained from MPEG LA, LLC.
See <http://www.mpegla.com>.