

Panasonic®

Operating Instructions Blu-ray Disc™ Home Theater Sound System

Model No. **SC-BTT362**
SC-BTT262



The illustration shows the image of SC-BTT362.

Dear customer

Thank you for purchasing this product.

For optimum performance and safety, please read these instructions carefully.

Before connecting, operating or adjusting this product, please read the instructions completely.

Please keep this manual for future reference.



Model number suffix "EB" denotes UK model.

Safety precautions

WARNING

Unit

- To reduce the risk of fire, electric shock or product damage,
 - Do not expose this unit to rain, moisture, dripping or splashing.
 - Do not place objects filled with liquids, such as vases, on this unit.
 - Use only the recommended accessories.
 - Do not remove covers.
 - Do not repair this unit by yourself. Refer servicing to qualified service personnel.
 - Do not let metal objects fall inside this unit.
 - Do not place heavy items on this unit.
 - Do not touch the speaker terminals while the unit is operating. Malfunction may occur due to static electricity.

AC mains lead

- To reduce the risk of fire, electric shock or product damage,
 - Ensure that the power supply voltage corresponds to the voltage printed on this unit.
 - Insert the mains plug fully into the socket outlet.
 - Do not pull, bend, or place heavy items on the lead.
 - Do not handle the plug with wet hands.
 - Hold onto the mains plug body when disconnecting the plug.
 - Do not use a damaged mains plug or socket outlet.
- Install this unit so that the AC mains lead can be unplugged from the socket outlet immediately if any problem occurs.

Small object

- Keep the Memory Card out of reach of children to prevent swallowing.
- Keep the screws out of reach of children to prevent swallowing.
- Keep the antenna plug adaptor out of reach of children to prevent swallowing.

CAUTION

Unit

- This unit utilizes a laser. Use of controls or adjustments or performance of procedures other than those specified herein may result in hazardous radiation exposure.
- Do not place sources of naked flames, such as lighted candles, on this unit.
- This unit may receive radio interference caused by mobile telephones during use. If such interference occurs, please increase separation between this unit and the mobile telephone.
- This unit is intended for use in moderate climates.
- **BTT362**
Product Identification Marking is located on the bottom of the unit.

Placement

- Place this unit on an even surface.
- To reduce the risk of fire, electric shock or product damage,
 - Do not install or place this unit in a bookcase, built-in cabinet or in another confined space. Ensure this unit is well ventilated.
 - Do not obstruct this unit's ventilation openings with newspapers, tablecloths, curtains, and similar items.
 - Do not expose this unit to direct sunlight, high temperatures, high humidity, and excessive vibration.

Batteries

- Danger of explosion if battery is incorrectly replaced. Replace only with the type recommended by the manufacturer.
- Mishandling of batteries can cause electrolyte leakage and may cause a fire.
 - Do not mix old and new batteries or different types at the same time.
 - Do not heat or expose to flame.
 - Do not leave the battery(ies) in a car exposed to direct sunlight for a long period of time with doors and windows closed.
 - Do not take apart or short circuit.
 - Do not recharge alkaline or manganese batteries.
 - Do not use batteries if the covering has been peeled off.
 - Remove batteries if you do not intend to use the remote control for a long period of time. Store in a cool, dark place.
- When disposing the batteries, please contact your local authorities or dealer and ask for the correct method of disposal.

CE 1731

Declaration of Conformity (DoC)

Hereby, "Panasonic Corporation" declares that this product is in compliance with the essential requirements and other relevant provisions of Directive 1999/5/EC.

Customers can download a copy of the original DoC to our R&TTE products from our DoC server:

<http://www.doc.panasonic.de>

Contact in the EU: Panasonic Services Europe, a Division of Panasonic Marketing Europe GmbH, Panasonic Testing Centre, Winsbergring 15, 22525 Hamburg, Germany

This product is intended to be used in the following countries.

Austria, Belgium, Bulgaria, Cyprus, Czech Republic, Denmark, Finland, France, Germany, Greece, Hungary, Ireland, Italy, Iceland, Liechtenstein, Luxembourg, Malta, Netherlands, Norway, Poland, Portugal, Romania, Slovakia, Slovenia, Spain, Sweden, United Kingdom, Switzerland

This product is intended for general consumer. (Category 3) The WLAN feature of this product shall exclusively be used inside buildings.

This product on purpose to connect to access point of 2.4 GHz or 5 GHz WLAN.

Caution for AC Mains Lead

For your safety, please read the following text carefully.

This appliance is supplied with a moulded three pin mains plug for your safety and convenience.

A 5-ampere fuse is fitted in this plug.

Should the fuse need to be replaced please ensure that the replacement fuse has a rating of 5-ampere and that it is approved by ASTA or BSI to BS1362.

Check for the ASTA mark  or the BSI mark  on the body of the fuse.

If the plug contains a removable fuse cover you must ensure that it is refitted when the fuse is replaced.

If you lose the fuse cover the plug must not be used until a replacement cover is obtained.

A replacement fuse cover can be purchased from your local dealer.

CAUTION!

IF THE FITTED MOULDED PLUG IS UNSUITABLE FOR THE SOCKET OUTLET IN YOUR HOME THEN THE FUSE SHOULD BE REMOVED AND THE PLUG CUT OFF AND DISPOSED OF SAFELY.

THERE IS A DANGER OF SEVERE ELECTRICAL SHOCK IF THE CUT OFF PLUG IS INSERTED INTO ANY 13-AMPERE SOCKET.

If a new plug is to be fitted please observe the wiring code as stated below. If in any doubt please consult a qualified electrician.

IMPORTANT

The wires in this mains lead are coloured in accordance with the following code: Blue: Neutral, Brown: Live.

As these colours may not correspond with the coloured markings identifying the terminals in your plug, proceed as follows:

The wire which is coloured Blue must be connected to the terminal which is marked with the letter N or coloured Black or Blue.

The wire which is coloured Brown must be connected to the terminal which is marked with the letter L or coloured Brown or Red.

WARNING: DO NOT CONNECT EITHER WIRE TO THE EARTH TERMINAL WHICH IS MARKED WITH THE LETTER E, BY THE EARTH SYMBOL  OR COLOURED GREEN OR GREEN/YELLOW. THIS PLUG IS NOT WATERPROOF—KEEP DRY.

Before use

Remove the connector cover.

How to replace the fuse

The location of the fuse differ according to the type of AC mains plug (figures A and B). Confirm the AC mains plug fitted and follow the instructions below. Illustrations may differ from actual AC mains plug.

1 Open the fuse cover with a screwdriver.

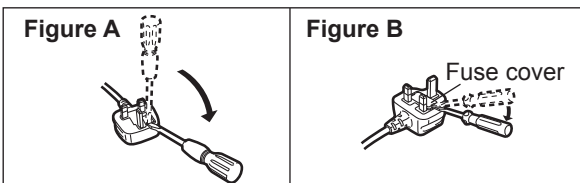

2 Replace the fuse and close or attach the fuse cover.

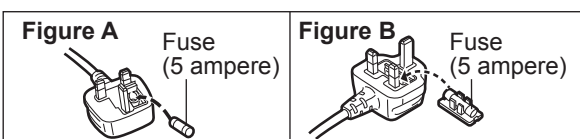

Information for Users on Collection and Disposal of Old Equipment and used Batteries

These symbols on the products, packaging, and/or accompanying documents mean that used electrical and electronic products and batteries should not be mixed with general household waste.

For proper treatment, recovery and recycling of old products and used batteries, please take them to applicable collection points, in accordance with your national legislation and the Directives 2002/96/EC and 2006/66/EC.

By disposing of these products and batteries correctly, you will help to save valuable resources and prevent any potential negative effects on human health and the environment which could otherwise arise from inappropriate waste handling. For more information about collection and recycling of old products and batteries, please contact your local municipality, your waste disposal service or the point of sale where you purchased the items.

Penalties may be applicable for incorrect disposal of this waste, in accordance with national legislation.



For business users in the European Union

If you wish to discard electrical and electronic equipment, please contact your dealer or supplier for further information.

[Information on Disposal in other Countries outside the European Union]

These symbols are only valid in the European Union. If you wish to discard these items, please contact your local authorities or dealer and ask for the correct method of disposal.



Cd

Note for the battery symbol (bottom two symbol examples):

This symbol might be used in combination with a chemical symbol. In this case it complies with the requirement set by the Directive for the chemical involved.

Java and all Java-based trademarks and logos are trademarks or registered trademarks of Sun Microsystems, Inc. in the United States and other countries.

Manufactured under license from Dolby Laboratories. Dolby and the double-D symbol are trademarks of Dolby Laboratories.

Manufactured under license under U.S. Patent #'s: 5,451,942; 5,956,674; 5,974,380; 5,978,762; 6,226,616; 6,487,535; 7,392,195; 7,272,567; 7,333,929; 7,212,872 & other U.S. and worldwide patents issued & pending.
DTS and the Symbol are registered trademarks, & DTS-HD, DTS-HD Master Audio | Essential and the DTS logos are trademarks of DTS, Inc. Product includes software.
© DTS, Inc. All Rights Reserved.

This item incorporates copy protection technology that is protected by U.S. patents and other intellectual property rights of Rovi Corporation. Reverse engineering and disassembly are prohibited.

HDMI, the HDMI Logo, and High-Definition Multimedia Interface are trademarks or registered trademarks of HDMI Licensing LLC in the United States and other countries.

This product is licensed under the AVC patent portfolio license and VC-1 patent portfolio license for the personal and non-commercial use of a consumer to (i) encode video in compliance with the AVC Standard and VC-1 Standard ("AVC/VC-1 Video") and/or (ii) decode AVC/VC-1 Video that was encoded by a consumer engaged in a personal and non-commercial activity and/or was obtained from a video provider licensed to provide AVC/VC-1 Video. No license is granted or shall be implied for any other use. Additional information may be obtained from MPEG LA, LLC.
See <http://www.mpegla.com>.

HDAVI Control™ is a trademark of Panasonic Corporation.

VIERA CAST is a trademark of Panasonic Corporation.

MPEG Layer-3 audio coding technology licensed from Fraunhofer IIS and Thomson.

"AVCHD" and the "AVCHD" logo are trademarks of Panasonic Corporation and Sony Corporation.

SDXC Logo is a trademark of SD-3C, LLC.

"DVD Logo" is a trademark of DVD Format/Logo Licensing Corporation.

DivX®, DivX Certified® and associated logos are trademarks of DivX, Inc. and are used under license.

YouTube and Picasa are trademarks of Google, Inc.

Skype, associated trade marks and logos and the "S" logo are trademarks of Skype Limited.

The Wi-Fi CERTIFIED Logo is a certification mark of the Wi-Fi Alliance.



"Made for iPod" and "Made for iPhone" mean that an electronic accessory has been designed to connect specifically to iPod, or iPhone, respectively, and has been certified by the developer to meet Apple performance standards.
Apple is not responsible for the operation of this device or its compliance with safety and regulatory standards.
Please note that the use of this accessory with iPod, or iPhone may affect wireless performance.
iPhone, iPod, iPod classic, iPod nano, and iPod touch are trademarks of Apple Inc., registered in the U.S. and other countries.

DLNA, the DLNA Logo and DLNA CERTIFIED are trademarks, service marks, or certification marks of the Digital Living Network Alliance.

Windows is a trademark or a registered trademark of Microsoft Corporation in the United States and other countries.

This product incorporates the following software:

- (1) the software developed independently by or for Panasonic Corporation,
- (2) the software owned by third party and licensed to Panasonic Corporation,
- (3) the software licensed under the GNU General Public License, Version 2 (GPL v2),
- (4) the software licensed under the GNU LESSER General Public License, Version 2.1 (LGPL v2.1) and/or,
- (5) open sourced software other than the software licensed under the GPL v2 and/or LGPL v2.1

For the software categorized as (3) and (4), please refer to the terms and conditions of GPL v2 and LGPL v2.1, as the case may be at <http://www.gnu.org/licenses/old-licenses/gpl-2.0.html> and <http://www.gnu.org/licenses/old-licenses/lgpl-2.1.html>. In addition, the software categorized as (3) and (4) are copyrighted by several individuals. Please refer to the copyright notice of those individuals at <http://www.am-linux.jp/dl/AWBPP11>

The GPL/LGPL software is distributed in the hope that it will be useful, but WITHOUT ANY WARRANTY, without even the implied warranty of MERCHANTABILITY or FITNESS FOR A PARTICULAR PURPOSE.

At least three (3) years from delivery of products, Panasonic will give to any third party who contacts us at the contact information provided below, for a charge no more than our cost of physically performing source code distribution, a complete machine-readable copy of the corresponding source code covered under GPL v2/LGPL v2.1.

Contact Information
cdrequest@am-linux.jp

Source code is also freely available to you and any other member of the public via our website below.
<http://www.am-linux.jp/dl/AWBPP11>

For the software categorized as (5) includes as follows.

1. This product includes software developed by the OpenSSL Project for use in the OpenSSL Toolkit.
(<http://www.openssl.org/>)
2. This product includes software developed by the University of California, Berkeley and its contributors.
3. FreeType code.
4. The Independent JPEG Group's JPEG software.

Table of contents

Safety precautions.....	2
Caution for AC Mains Lead	3

Getting started

Accessory.....	6
Unit and media care	7
Using the remote control	7
Control reference guide	8
•Remote control	8
•Main unit (Front)	9
•Main unit (Rear).....	9
Playable discs/Cards/USB devices	10
STEP 1: Preparing the speakers	12
•Assembling the speakers BTT362	12
STEP 2: Positioning	13
STEP 3: Connections	13
•Speaker cable connection	13
•Connection to a TV	14
•Connection with Set Top Box, etc.	16
•Connection to a broadband network.....	17
•Radio antenna connection.....	18
STEP 4: AC mains lead connection	18
STEP 5: Easy setup	19
•Network Easy Setting	20
•Firmware updates.....	22
•Reprogramming the remote control.....	22
Inserting or removing media.....	22
HOME menu.....	23
Enjoying sound effects from all speakers	24
•Enjoying surround sound effects	24

Playback

Playing video contents	25
•Other operations during play	25
•Useful functions	26
•Enjoying BD-Live or picture-in-picture in BD-Video.....	27
•Regarding DivX	28
Playing music	28
•Playing a track in another folder.....	28
Enjoying 3D video	29
•3D settings	29
•Useful functions	29
Playing still pictures.....	30
•Useful functions.....	30

Radio

Listening to the Radio.....	31
•Presetting stations automatically	31
•Presetting stations manually.....	31
•Listening/confirming the preset channels	31
•RDS broadcasting	31

TV

Enjoying TV with unit's speakers	32
•Surround sound effects.....	32
•Sound modes.....	32
Linked operations with the TV (VIERA Link "HDAVI Control™").....	32
•Setting the audio link.....	32
•Easy control only with VIERA remote control	33

Other devices

Using the iPod/iPhone	34
•iPod/iPhone Connection	34
•iPod/iPhone Playback.....	35

Advanced operations

Enjoying VIERA CAST	36
Playing back contents on the DLNA server (DLNA).....	37
Playback menu	38
Setup menu	39

Optional speaker settings

Speaker installation option	44
-----------------------------------	----

Reference

Troubleshooting guide	45
Messages	48
Specifications	49
Supplemental information	50
Index.....	51

Glossary

Refer to following site for technical terms.

http://www.panasonic.co.uk/html/en_GB/Technology/0-9/217724/index.html

- These operating instructions are applicable to models SC-BTT362 and SC-BTT262. Unless otherwise indicated, illustrations in these operating instructions are of SC-BTT362.
- Operations in these instructions are described mainly with the remote control, but you can perform the operations on the main unit if the controls are the same.

Indicates features applicable to:

- BTT362**: SC-BTT362 only
- BTT262**: SC-BTT262 only

System	SC-BTT362	SC-BTT262
Main unit	SA-BTT362	SA-BTT262
Front speakers	SB-HF370	SB-HF262
Subwoofer	SB-HW370	SB-HW270

• Please note that the actual controls and components, menu items, etc. of your Blu-ray Disc Home Theater Sound System may look somewhat different from those shown in the illustrations in these Operating Instructions.

Accessory

Check the supplied accessories before using this unit.
For accessories of speakers, refer to page 12.

BTT362

- 1 Remote control**
(N2QAYB000635)
- 2 Batteries for remote control**
- 1 FM indoor antenna**
(RSAX0002)



- 1 AC mains lead**
(K2CZ3YY00005)

- 1 Antenna plug adaptor**
(K1YZ02000013)



BTT262

- 1 Remote control**
(N2QAYB000630)
- 2 Batteries for remote control**
- 1 FM indoor antenna**
(RSAX0002)



- 1 AC mains lead**
(K2CZ3YY00005)

- 1 Antenna plug adaptor**
(K1YZ02000013)



- 8 Cushion foot**
(RFA3313)



- Product numbers provided in these operating instructions correct as of January 2011. These may be subject to change.
- Do not use AC mains lead with other equipment.

Unit and media care

■ Clean this unit with a soft, dry cloth

- Never use alcohol, paint thinner or benzene to clean this unit.
- Before using chemically treated cloth, carefully read the instructions that came with the cloth.

■ Clean the lens with the lens cleaner

Lens cleaner: RP-CL720AE

- This lens cleaner may not be available for sale in all countries, e.g. not available in Germany, please consult your Panasonic dealer for advice.
- This lens cleaner is sold as specific for DIGA, but can be used on this unit as well.

■ Clean discs



Wipe with a damp cloth and then wipe dry.

■ Disc and card handling precautions

- Handle discs by the edges to avoid inadvertent scratches or fingerprints on the disc.
- Do not attach labels or stickers to discs.
- Do not use record cleaning sprays, benzene, thinner, static electricity prevention liquids or any other solvent.
- Clean any dust, water, or foreign matter from the terminals on the rear side of the card.
- Do not use the following discs:
 - Discs with exposed adhesive from removed stickers or labels (rented discs etc).
 - Discs that are badly warped or cracked.
 - Irregularly shaped discs, such as heart shapes.

■ To dispose or transfer this unit

The unit may keep the user settings information in the unit. If you discard this unit either by disposal or transfer, then follow the procedure to return all the settings to the factory presets to delete the user settings. (⇒ 45, "To return all settings to the factory preset.")

- The operation history may be recorded in the memory of this unit.

Using the remote control

Insert so the poles (+ and -) match those in the remote control.

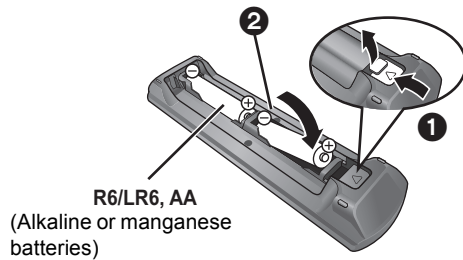

Point it at remote control signal sensor on this unit. (⇒ 9)

Control reference guide

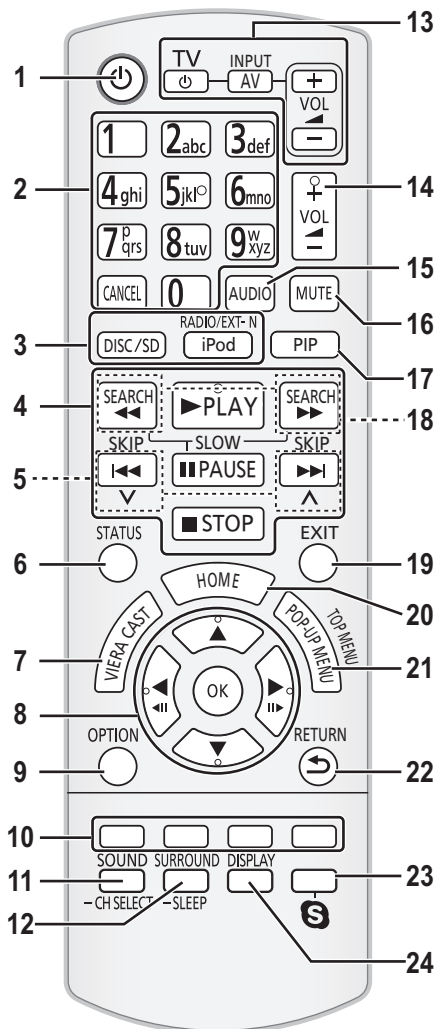

Remote control

- 1 Turn the unit on and off
- 2 Select title numbers, etc./Enter numbers or characters (⇒ 36)
[CANCEL]: Cancel
- 3 Select the source (⇒ 22)
- 4 Basic playback control buttons (⇒ 25)
- 5 Select preset radio stations (⇒ 31)
- 6 Show status messages (⇒ 25)
- 7 Display the Home screen of VIERA CAST (⇒ 36)
- 8 Selection/OK, Frame-by-frame (⇒ 25)
- 9 Show OPTION menu (⇒ 26)
- 10 Coloured buttons (red, green yellow, blue)
These buttons are used when;
 - Operating a BD-Video disc that includes Java™ applications (BD-J).
 - Operating contents of VIERA CAST (⇒ 36)
- 11 Set the sound mode (⇒ 24)/Select speaker channel (⇒ 24)
- 12 Select surround sound effects (⇒ 24)/Set the sleep timer
 - ① Press and hold [-SLEEP].
 - ② While "SLEEP * *" is displayed, press [-SLEEP] several times to select the time (in minutes).
 - Timer selection is up to 120 minutes.
 - Select "OFF" when cancelling the setting.
 - To confirm the remaining time
Press and hold the button again.
- 13 **TV operation buttons**
You can operate the TV through the unit's remote control.
[⏻]: Turn the television on and off
[AV, INPUT]: Switch the input select
[+ - VOL] : Adjust the volume
- 14 Adjust the volume of the main unit
- 15 Select audio (⇒ 26)
- 16 Mute the sound
 - "MUTE" flashes on the unit's display, while the function is on.
 - To cancel, press the button again or adjust the volume.
 - Muting is cancelled if the unit is turned off.
- 17 Switch on/off Secondary Video (Picture-in-picture) (⇒ 27)
- 18 Select radio stations manually (⇒ 31)
- 19 Exit the menu screen
- 20 Show HOME menu (⇒ 23)
- 21 Show Pop-up Menu/Top Menu/Direct Navigator (⇒ 25)
- 22 Return to previous screen
- 23 **BTT362**
Start up a video communication (⇒ 36)
- 24 Show Playback menu (⇒ 38)

Main unit (Front)

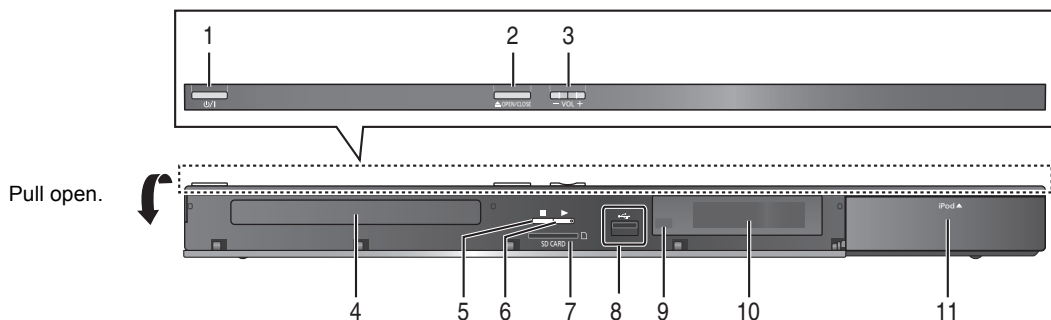





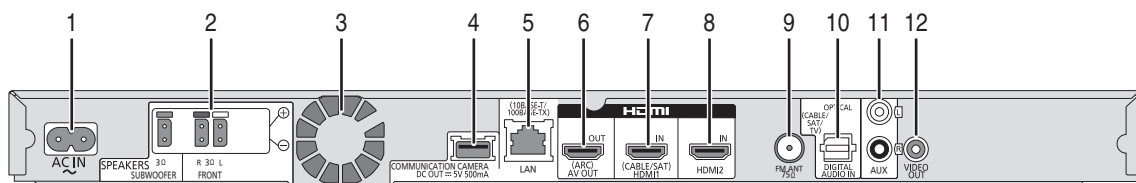

- | | |
|---|---|
| <ol style="list-style-type: none"> 1 Standby/on switch (⏻/⏻) (⇒ 19)
Press to switch the unit from on to standby mode or vice versa. In standby mode, the unit is still consuming a small amount of power. 2 Open or close the disc tray (⇒ 22) 3 Adjust the volume of the main unit 4 Disc tray 5 Stop (⇒ 25) | <ol style="list-style-type: none"> 6 Start play (⇒ 25) 7 SD card slot (⇒ 22) 8 USB port (⇒ 22) 9 Remote control signal sensor
Distance: within approx. 7 m.
Angle: Approx. 20° up and down, 30° left and right 10 Display 11 Connect iPod/iPhone (⇒ 34) |
|---|---|

Main unit (Rear)



- | | |
|--|---|
| <ol style="list-style-type: none"> 1 AC IN terminal (⇒ 18) 2 Speaker terminals (⇒ 13) 3 Cooling fan 4 BTT362
USB port for the Communication Camera TY-CC10W (optional) (⇒ 36) 5 LAN port (⇒ 17) 6 HDMI AV OUT (ARC) terminal (⇒ 15) 7 BTT362
HDMI 1 IN (CABLE/SAT) terminal (⇒ 16) 8 BTT362
HDMI 2 IN terminal (⇒ 16) | <ol style="list-style-type: none"> 9 FM radio antenna terminal (⇒ 18) 10 DIGITAL AUDIO IN terminal (⇒ 14, 15) 11 AUX terminal (⇒ 14) 12 VIDEO OUT terminal (⇒ 14) |
|--|---|

Playable discs/Cards/USB devices

Device	Disc markings	Device types	Contents format*
BD		BD-Video	Video
		BD-RE	Video JPEG/ MPO (3D still picture)
		BD-R	Video DivX® MKV
DVD		DVD-Video	Video
		DVD-R	Video AVCHD DivX® MKV
		DVD-R DL	MP3 JPEG/ MPO (3D still picture)
		DVD-RW	Video AVCHD
	—	+R/+RW/+R DL	
CD		Music CD	Music [CD-DA]
	—	CD-R CD-RW	DivX® MKV Music [CD-DA] MP3 JPEG/ MPO (3D still picture)
SD		SD Memory Card (from 8 MB to 2 GB) SDHC Memory Card (from 4 GB to 32 GB) SDXC Memory Card (48 GB, 64 GB) (Compatible with both mini and micro types) (as of January 2011)	MPEG2 AVCHD JPEG/MPO (3D still picture)
USB	—	USB devices (up to 2 TB)	DivX® MKV MP3 JPEG/ MPO (3D still picture)

* See page 11 and 50 for more information on the types of content that can be played.

■ Discs that cannot be played by this unit

- DVD-RAM
- Super Audio CD
- Photo CD
- DVD-Audio
- Video CD and Super Video CD
- WMA discs
- DivX Plus HD discs
- HD DVD

■ Region management information

BD-Video

This unit plays BD-Video marked with labels containing the region code "B".

Example:



DVD-Video

This unit plays DVD-Video marked with labels containing the region number "2" or "ALL".

Example:



■ Finalize

DVD-R/RW/R DL, +R/+RW/+R DL and CD-R/RW recorded by a recorder, etc. needs to be finalized by the recorder to play on this unit. Please refer to the recorder's instructions.

■ BD-Video

- This unit supports high bit rate audio (Dolby Digital Plus, Dolby TrueHD, DTS-HD High Resolution Audio and DTS-HD Master Audio) adopted in BD-Video.

■ 3D

- 3D videos and 3D still pictures can be played back when this unit is connected to a 3D compatible TV using a High Speed HDMI Cable.
- 2D video can be enjoyed as 3D virtually. (⇒ 29)

■ Music CD

Operation and sound quality of CDs that do not conform to CD-DA specifications (copy control CDs, etc.) cannot be guaranteed.

■ SD card

- miniSD Cards, microSD Cards, microSDHC Cards and microSDXC Cards can be used, but must be used with an adaptor card. These are usually supplied with such cards, or otherwise customer provided.
- To protect the card's contents, move the record prevention tab (on the SD card) to "LOCK".
- This unit is compatible with SD Memory Cards that meet SD Card Specifications FAT12 and FAT16 formats, as well as SDHC Memory Cards in FAT32 format (Does not support long file name.) and SDXC Memory Cards in exFAT.
- If the SD card is used with incompatible computers or devices, recorded contents may be erased due to the card being formatted etc.
- Useable memory may be slightly less than the card capacity.



■ USB device

- This unit does not guarantee connection with all USB devices.
- This unit does not support USB device charging.
- **BTT362**
When using Communication Camera TY-CC10W, connect it to the rear terminal of this unit. (⇒ 36)
- FAT12, FAT16 and FAT32 file systems are supported.
- This unit supports USB 2.0 High Speed.
- This unit can support an HDD formatted to FAT32. Some types of HDD may require the use of its external power supply unit.





- It may not be possible to play the above media in some cases due to the type of media, the condition of the recording, the recording method and how the files were created.
- The producers of the disc can control how discs are played, so you may not always be able to control play as described in these operating instructions. Read the disc's instructions carefully.

STEP 1: Preparing the speakers

BTT362

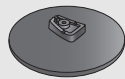
2 Front speakers 

2 Bases (RYK1637-K) 

2 Screws A (XTB4+12GFJK) 

2 Speaker cables (REEX1266A: RED) (REEX1267A: WHITE) 

Assembling the speakers **BTT362**

Caution

- Do not stand on the base. Be cautious when children are near.
- When carrying speakers, hold the stand and base parts.

Preparation

- To prevent damage or scratches, lay down a soft cloth and perform assembly on it.
- For wall mount, refer to page 44.

Thread the speaker cable through the base.

- Use cables with a white connector and red connector.

1 Tighten securely.

2 Insert the wire fully.
+ : White
- : Blue line

3 Press into the groove.

4 Pull the cable straight along the line and slide into the groove.

Leave about 110 mm

Push!

Back of the base

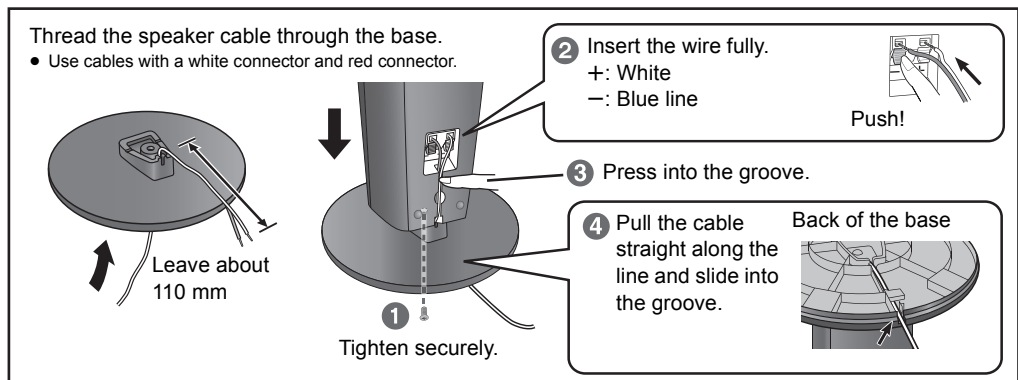



- Be careful not to cross (short-circuit) or reverse the polarity of the speaker wires as doing so may damage the speakers.
- Do not hold the speaker in one hand to avoid injury by dropping the speaker when carrying.

Preventing the speakers from falling **BTT362 BTT262**

- Consult a qualified housing contractor concerning the appropriate procedure when attaching to a concrete wall or a surface that may not have strong enough support. Improper attachment may result in damage to the wall or speakers.
- Use a string of less than \varnothing 2.0 mm, which is capable of supporting over 10 kg.

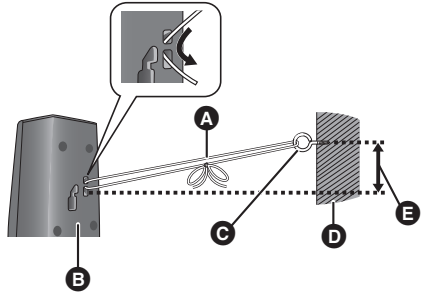
e.g. **BTT362**



- A** String (not supplied)
Thread from the wall to the speaker and tie tightly.
- B** Rear of the speaker
- C** Screw eye (not supplied)
- D** Wall
- E** Approx. 150 mm

STEP 2: Positioning

Caution

- The main unit and supplied speakers are to be used only as indicated in this setup. Failure to do so may lead to damage to the amplifier and/or the speakers, and may result in the risk of fire. Consult a qualified service person if damage has occurred or if you experience a sudden change in performance.
- Do not attempt to attach these speakers to walls using methods other than those described in this manual.
- Do not touch the front netted area of the speakers. Hold by the sides.

How you set up your speakers can affect the bass and the sound field.

Setup example

Place the front speakers at approximately the same distance from the seating position.

The angles in the diagram are approximate.



- Keep your speakers at least 10 mm away from the system for proper ventilation.

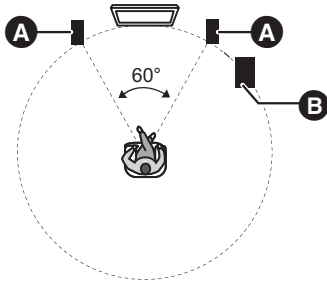

- A Front speakers
- B Subwoofer



- **Use only supplied speakers**
Using other speakers can damage the unit, and sound quality will be negatively affected.
- You can damage your speakers and shorten their useful life if you play sound at high levels over extended periods.
- Place speakers on flat secure bases.
- Placing speakers too close to floors, walls, and corners can result in excessive bass. Cover walls and windows with thick curtains.

- If irregular colouring occurs on your TV, turn the TV off for about 30 minutes.

If it persists, move the speakers further away from the TV.

STEP 3: Connections

Turn off all equipment before connection and read the appropriate operating instructions.

Do not connect the AC mains lead until all other connections are complete.

Speaker cable connection

Connect to the terminals of the same colour.

- ③ **PURPLE** Subwoofer
- ② **RED** Front speaker (Rch)
- ① **WHITE** Front speaker (Lch)

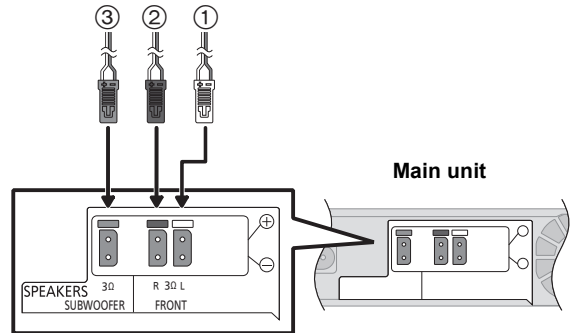

Connection to a TV



- **Do not make the video connections through the VCR.**
Due to copy guard protection, the picture may not be displayed properly.
- Turn off all equipment before connection.

■ OPTICAL IN

- After making the digital audio connection, make settings to suit the type of audio from your digital equipment (⇒ 26).

■ HDMI

The HDMI connection supports VIERA Link "HDAVI Control" (⇒ 32) when used with a compatible Panasonic TV.

- Please use High Speed HDMI Cables that have the HDMI logo (as shown on the cover). It is recommended that you use Panasonic's HDMI cable. When outputting 1080p signal, please use HDMI cables 5.0 meters or less.
Recommended part number (High Speed HDMI Cable):
RP-CDHS15 (1.5 m), RP-CDHS30 (3.0 m), RP-CDHS50 (5.0 m), etc.
- Audio will be output through the system's speakers when "Off" is selected in "HDMI Audio Output". (⇒ 42)

Connection for the standard picture and audio

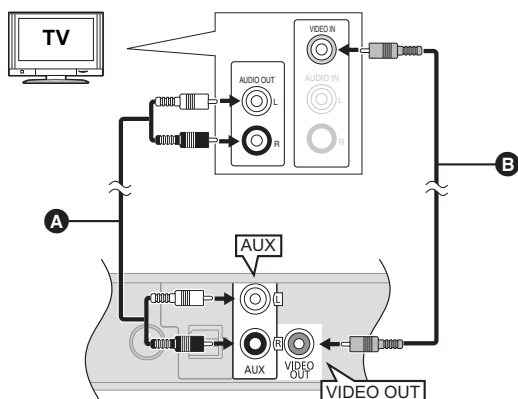

To enjoy TV audio from this home theatre system's speakers:

- 1 Connect the TV and the main unit with the Audio cable (not supplied).
- 2 Select "AUX" as a source (⇒ 23).

- A** Audio cable (not supplied)
- B** Video cable (not supplied)

Connection for the better audio

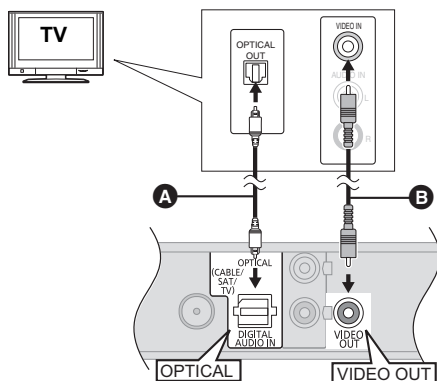

To enjoy TV audio from this home theatre system's speakers:

- 1 Connect the TV and the main unit with the Optical digital audio cable (not supplied).
- 2 Select "DIGITAL IN" or "D-IN" as a source (⇒ 23).

- A** Optical digital audio cable (not supplied)
- B** Video cable (not supplied)

e.g.,

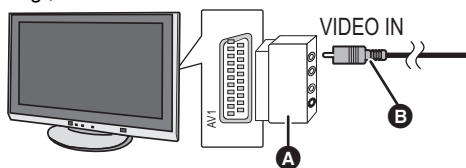

If the TV does not have a VIDEO IN terminal, connect using a Scart adaptor (Scart—VIDEO IN).

- A** Scart adaptor (not supplied)
- B** Video cable (not supplied)

Connection for the best picture and audio

- When connecting to a TV using an HDMI cable, check the HDMI terminal on the TV. If the HDMI terminal is labeled “HDMI (ARC)”, you can connect the unit simply with a single HDMI cable.
- It is possible to play back 3D videos and 3D still pictures by connecting this unit with a 3D compatible TV.
- For details, refer to the operating instructions of your TV.

■ When the HDMI terminal on the TV is labeled “HDMI (ARC)”

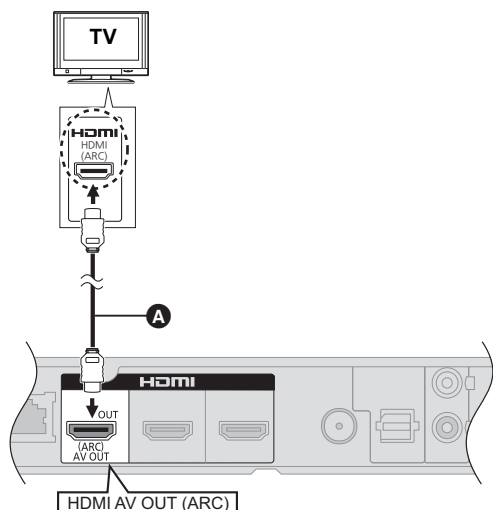

What is ARC?

ARC is an abbreviation of Audio Return Channel, also known as HDMI ARC. It refers to one of the HDMI functions. When you connect the unit to the terminal labeled “HDMI (ARC)”, the optical digital audio cable that is usually required in order to listen to sound from TV is no longer required, and TV pictures and sound can be enjoyed with a single HDMI cable.

To enjoy TV audio from this home theatre system's speakers:

Select “ARC” as a source (⇒ 23).

- A** HDMI cable (not supplied)

■ When the HDMI terminal on the TV is not labeled “HDMI (ARC)”

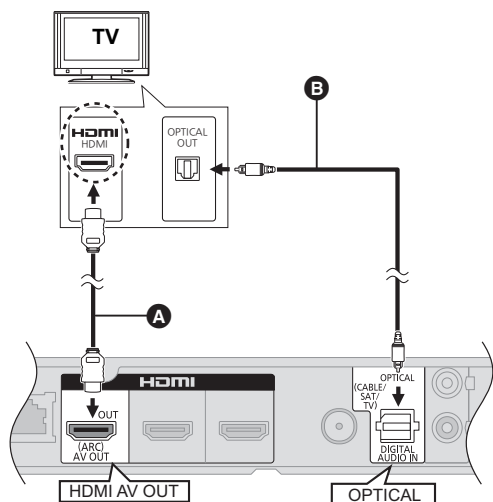

To enjoy TV audio from this home theatre system's speakers:

- 1 Connect the TV and the main unit with the Optical digital audio cable (not supplied).
- 2 Select “DIGITAL IN” or “D-IN” as a source (⇒ 23).

- A** HDMI cable (not supplied)
B Optical digital audio cable (not supplied)

Connection with Set Top Box, etc.

■ When the connecting devices have an HDMI terminal

BTT362

e.g.,

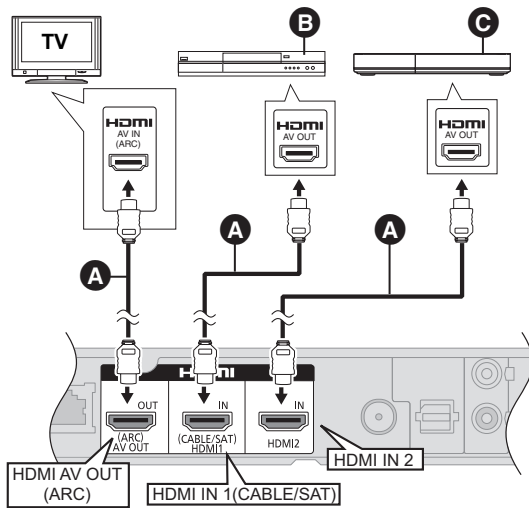

- A** HDMI cable (not supplied)
- B** Set Top Box (Cable/Satellite), etc.
- C** Other devices (Video game, etc.)

- Make sure that the HDMI cable connection is made to enjoy the videos from the Set Top Box, etc. Furthermore, select "HDMI Input1" or "HDMI Input2" as a source.

HDMI Standby Pass-Through (⇒ 42)

Even if this unit is in standby mode, a device connected with this unit can output videos and sound to the TV. Moreover, you can switch the HDMI input terminal by pressing [EXT-IN] on the remote control.

- Sound will not be output from this unit's speakers.

■ When the connecting devices do not have an HDMI terminal

e.g.,

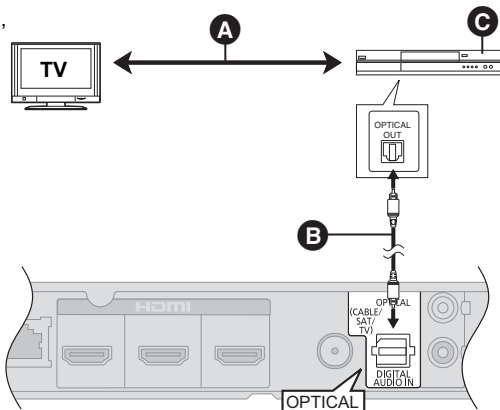

To enjoy TV audio from this home theatre system's speakers:

- 1 Connect the STB and the main unit with the Optical digital audio cable (not supplied).
- 2 Select "DIGITAL IN" or "D-IN" as a source (⇒ 23).

- A** Refer to the operating instructions of the respective devices for the optimal connections.
- B** Optical digital audio cable (not supplied)
- C** Set Top Box (Cable/Satellite), etc.

Connection to a broadband network

The following services can be used when this unit is connected to broadband.

- Firmware can be updated (⇒ 22)
- You can enjoy BD-Live (⇒ 27)
- You can enjoy VIERA CAST (⇒ 36)
- You can access other devices (Home Network) (⇒ 37)

■ LAN cable connection

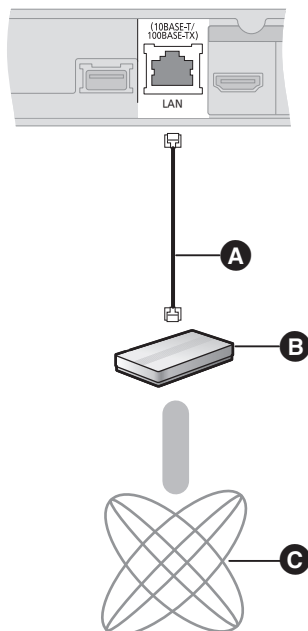

- A** LAN Cable (not supplied)
- B** Broadband router, etc.
- C** Internet

- Use category 5 or above straight LAN cables (STP) when connecting to peripheral devices.
- Inserting any cable other than a LAN cable in the LAN terminal can damage the unit.

For details about connection method, refer to the instructions supplied with the connected equipment.

■ **BTT362** Wireless LAN connection

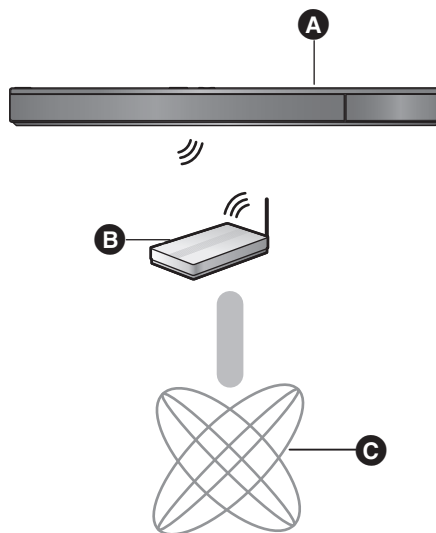

- A** Main unit (Wireless LAN is built in.)
- B** Wireless router, etc.
- C** Internet

- For up to date compatibility information on your Wireless router refer to <http://panasonic.jp/support/global/cs/> (This site is in English only.)
- The unit is not compatible with public wireless LAN services (Hotspot etc.) provided in airports, stations, cafes etc.

BTT362

Precautions of Wireless LAN connection

The following limits are in place regarding the usage of this unit. You must be aware of these limits before using these devices.

Panasonic will in no way be responsible for any incidental damage which may arise due to a failure to obey these limits, or to any condition of use or disuse of these devices.

- **Data transmitted and received over radio waves may be intercepted and monitored.**
- **This unit contains delicate electronic components.**

Please use these devices in the manner in which it was intended and follow the following points:

- Do not expose these devices to high temperatures or direct sunlight.
- Do not bend, or subject these devices to strong impacts.
- Keep these devices away from moisture.
- Do not disassemble or alter the device in any way.

Radio antenna connection

■ Using an indoor antenna

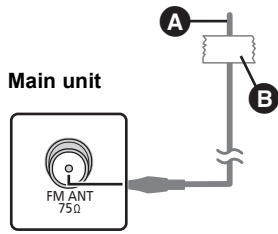

- A** FM indoor antenna (supplied)
- B** Adhesive tape
Affix this end of the antenna where reception is best.

■ Using an outdoor antenna

Use outdoor antenna if FM radio reception is poor.

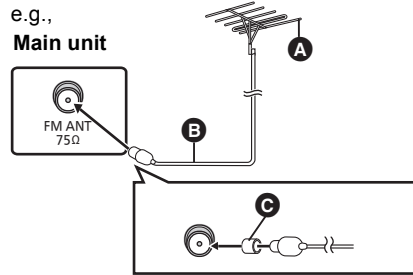

- e.g.,
- Main unit**
- A** FM outdoor antenna [Using a TV antenna (not supplied)]
The antenna should be installed by a competent technician.
- B** 75 Ω coaxial cable (not supplied)
- C** Antenna plug adaptor

STEP 4: AC mains lead connection

BE SURE TO READ THE CAUTION FOR THE AC MAINS LEAD ON PAGE 3 BEFORE CONNECTION.

- Connect only after all other connections are complete.

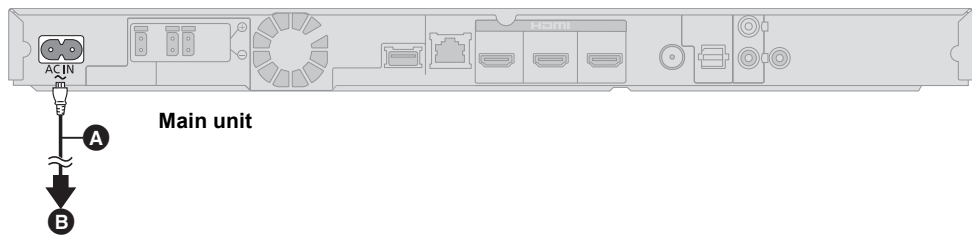

- A** AC mains lead (supplied)
- B** To a household mains socket

- The main unit consumes a small amount of AC power, even when it is turned off.

BTT362 : approx. 0.1 W*, **BTT262** : approx. 0.4 W*

*When the "Quick Start" setting is "Off"

In the interest of power conservation, if you will not be using this unit for a long time, unplug it from the household mains socket.

STEP 5: Easy setup

The Easy setup assists you to make necessary settings.

Follow the on-screen prompts to make basic settings for the system.

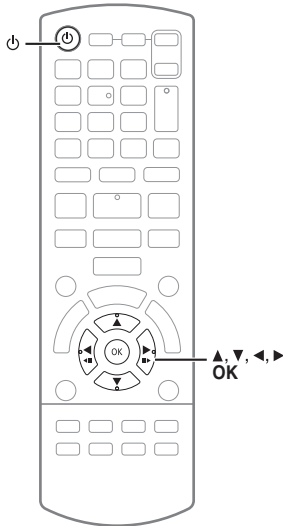

Preparation

- Turn on your TV and select the appropriate video input mode (e.g., VIDEO 1, AV 1, HDMI, etc.) to suit the connections to this unit.

1 Press [Power].

Setup screen appears.

If this unit is connected to a Panasonic TV (VIERA) supporting HDAVI Control 2 or later via an HDMI cable, then setting information on the TV such as "On-Screen Language" is acquired by this unit.

2 Follow the on-screen instructions and make the settings with [▲, ▼, ◀, ▶] and press [OK].

Language

Select the language used on menu screen.

TV Aspect

Select the aspect to suit your TV and preference.

Speaker check

Check if the connection to each speaker is valid.

TV Audio

Select the audio input connection from your TV, [item with "(TV)"].

Quick Start

Speed of startup from standby mode is increased.

BT362

HDMI Standby Pass-Through

Even if this unit is in standby mode, a device connected with this unit can output videos and sound to the TV. (⇒ 16, "When the connecting devices have an HDMI terminal")

3 Press [OK] several times to finish the "Easy setup".

After completing "Easy setup", you can perform "Network Easy Setting".



- You can perform this setup anytime by selecting "Easy setup" in the Setup menu. (⇒ 43)

Network Easy Setting

After completing "Easy setup", you can perform "Network Easy Setting".

BTT262

Follow the on-screen instructions and make the settings with [◀, ▶] and press [OK].

BTT362

Select "Wired" or "Wireless" and press [OK].

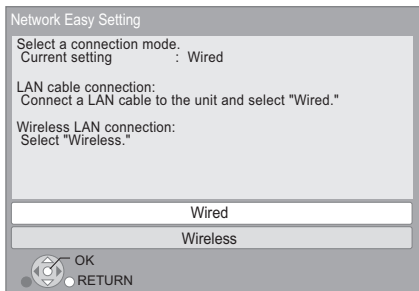

■ "Wired" connection

Follow the on-screen instructions to make your connection settings.

- When you experience problems (⇒ right)

■ "Wireless" connection

Before beginning wireless connection setup

- Obtain your network name (SSID)¹⁾.
- If your wireless connection is encrypted please be sure that you know your encryption key.

Select "WPS (PUSH button)" or "Search for wireless network" and then follow the on-screen instructions and make the settings.

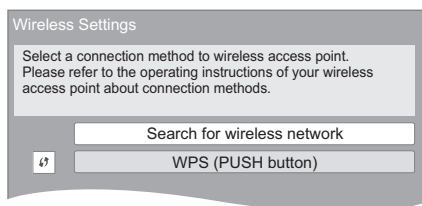

WPS (PUSH button):

If your Wireless router supports WPS (PUSH button), you can easily perform the settings by pressing WPS button on it. WPS (Wi-Fi Protected Setup) is a standard that facilitates settings relating to the connection and security of wireless LAN devices.

e.g.,

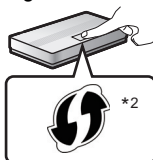

- ① Press WPS button or corresponding button of Wireless router until the lamp starts flashing.
 - For details, refer to the operating instruction of Wireless router.
- ② Press [OK].

Search for wireless network:

- When you select "Search for wireless network", the available wireless networks will be displayed. Select your network name and press [OK].
 - If your network name is not displayed search again by pressing the red button on the remote control.
 - Stealth SSID will not be displayed when you select "Search for wireless network". Enter manually by using "Manual setting".
 - (Press [HOME] ⇒ select "Others" ⇒ select "Setup" ⇒ select "Network" ⇒ [OK] ⇒ select "Network Settings" ⇒ [OK] ⇒ select "Wireless Settings" ⇒ [OK] ⇒ select "Connection Setting" ⇒ [OK] ⇒ select "Manual setting" ⇒ [OK])

- If your wireless network is encrypted, Encryption Key input screen will be displayed. Input the encryption key of your network.

¹⁾ An SSID (Service Set Identification) is a name used by wireless LAN to identify a particular network. Transmission is possible if the SSID matches for both devices.

²⁾ Wi-Fi Protected Setup-compatible Wireless router may have the mark.

When you experience problems with settings

BTT362

Wireless Settings

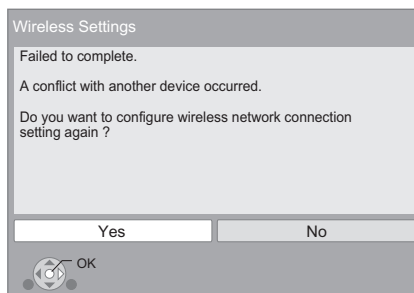

Display	Check the following
A conflict with other devices occurred.	<ul style="list-style-type: none"> • Please wait a few moments, and then try again.
A time out error occurred.	<ul style="list-style-type: none"> • Setting of the Wireless router for MAC Address etc. • The signal may be weak.
An authentication error or a time out error occurred.	<ul style="list-style-type: none"> • The SSID and the encryption key of the Wireless router. • Please wait a few moments, and then try again.
A device error occurred.	<ul style="list-style-type: none"> • If there is no improvement in symptom, consult your dealer.

Network Easy Setting (Home Network Connection Check)

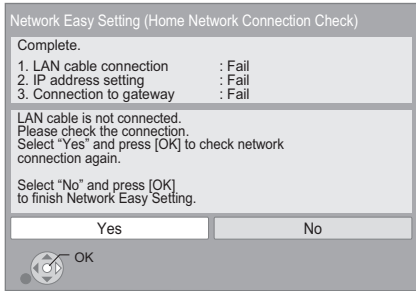

Network Easy Setting (Internet Connection Test)

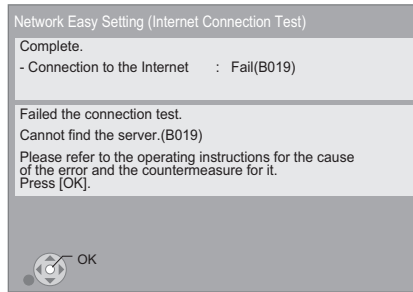

Display	Check the following
1. LAN cable connection or Wireless Settings :Fail 2. IP address setting :Fail 3. Connection to gateway :Fail	<ul style="list-style-type: none"> ● Connection of the LAN cables (⇒ 17)
1. LAN cable connection or Wireless Settings :Pass 2. IP address setting :Fail 3. Connection to gateway :Fail	<ul style="list-style-type: none"> ● Connection and settings of the hub and router ● Settings of "IP Address / DNS Settings" (⇒ 42)
1. LAN cable connection or Wireless Settings :Pass 2. IP address setting :Pass or Home network available 3. Connection to gateway :Fail	<ul style="list-style-type: none"> ● Settings of "IP Address / DNS Settings" (⇒ 42)

Display	Check the following
Cannot find the server. (B019)	<ul style="list-style-type: none"> ● "Primary DNS" and "Secondary DNS" settings of "IP Address / DNS Settings" (⇒ 42)
Failed to connect to the server. (B020)	<ul style="list-style-type: none"> ● The server may be busy or the service may have been suspended. Please wait a few moments, and then try again. ● Settings of "Proxy Server Settings" (⇒ 43) and the router.



- Refer to the operating instructions of the hub or router.
- You can perform this setup anytime by selecting "Network Easy Setting" in the Setup menu. (⇒ 42)
- You can redo these settings individually using "Network Settings". (⇒ 42)

BTT362

- Do not use this unit to connect to any wireless network for which you do not have usage rights.
During automatic searches in a wireless network environment, wireless networks (SSID) for which you do not have usage rights may be displayed; however, using these networks may be regarded as illegal access.
- After performing network settings on this unit, the settings (encryption level, etc.) of the Wireless router might change.
When you have trouble getting online on your PC, perform the network settings on your PC in accordance with the settings of Wireless router.
- Please be aware that connecting to a network without encryption may result in the content of the communication being illegitimately viewed by a third party, or the leaking of data such as personal or secret information.

Firmware updates

Occasionally, Panasonic may release updated firmware for this unit that may add or improve the way a feature operates. These updates are available free of charge.

This unit is capable of checking the firmware automatically when connected to the Internet via a broadband connection. When a new firmware version is available, the following message is displayed.

New firmware is available.
Please update firmware in Setup.

To update the firmware

Press **[HOME]** ⇒ select **"Others"** ⇒ select **"Setup"** ⇒ select **"Others"** ⇒ **[OK]** ⇒ select **"Firmware Update"** ⇒ **[OK]** ⇒ select **"Update Now"**

DO NOT DISCONNECT the unit from the AC power or perform any operation while the update takes place.

After the firmware is installed, "FINISH" will be displayed on the unit's display. Unit will restart and the following screen will be displayed.

The firmware has been updated.
Current Version:x.xx

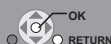

- If downloading on this unit fails or this unit is not connected to the Internet, then you can download the latest firmware from the following website and burn it to a CD-R to update the firmware. <http://panasonic.jp/support/global/cs/> (This site is in English only.)
To show the firmware version on this unit. (⇒ 43, "System Information")
- Downloading will require several minutes. It may take longer or may not work properly depending on the connection environment.
- If you do not want to check for the latest firmware version, set "Automatic Update Check" to "Off". (⇒ 43)

Reprogramming the remote control

If you have more than one Panasonic player/recorder and the remote control operates both products at once, you will need to change the remote control code on one product to prevent this occurrence. (⇒ 43, "Remote Control")

Inserting or removing media

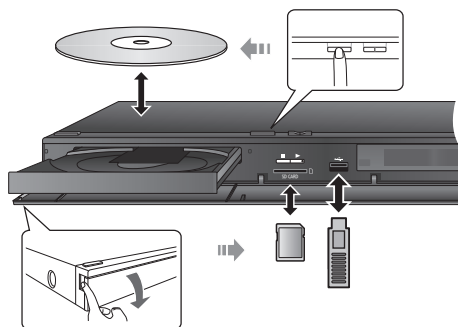

- When inserting a media item, ensure that it is facing the right way up.
- While the reading indicator is displayed, do not turn off the unit or remove the media. Such action may result in loss of the media's contents.
- When removing the SD card, press on the centre of the card and pull it straight out.
- If the USB device is not recognized by the main unit, disconnect the USB device from the main unit and reconnect it.
- It may take some time to be recognized by the main unit.
- Insert the USB device directly into the USB port. Do not use any USB extension cable.

Selecting the source by the remote control

Button	Source
DISC/SD	Select disc drive or SD card drive BD/DVD or SD card (SD) (⇒ 25)
RADIO/EXT-IN iPod	Select iPod/iPhone, FM tuner or external audio as the source iPod (IPOD) (⇒ 34) FM Radio (FM) (⇒ 31) To enjoy sound from the TV (⇒ 32) AUX^{*1} ARC^{*1} DIGITAL IN^{*1} (D-IN) To enjoy sound from other devices (⇒ 32) DIGITAL IN^{*2} (D-IN) BTT³⁶² HDMI IN1/HDMI IN2 (⇒ 16)



- Items to be displayed may vary with the media.
- When the selector is switched, it may take time to playback the selected video and/or audio.

*1 "(TV)" is displayed next to items set for TV AUDIO input.

*2 "(CABLE/SATELLITE)" is displayed next to DIGITAL IN when set for CABLE/SATELLITE AUDIO input.

HOME menu

Major functions of this unit can be operated from the HOME menu.

Preparation

Turn on the television and select the appropriate video input on the television.

- 1 Press [POWER] to turn on the unit.
- 2 Press [▲, ▼, ◀, ▶] to select the item and press [OK].



- When a media is inserted, contents selection screen for that media is displayed.
- If there are any other items, repeat this step.
- To return to HOME menu, select "HOME" or press [RETURN] several times.

Videos/ Photos/ Music	Disc	Play back the contents. (⇒ 25, 28, 30)
	SD card	• When multiple contents are recorded, select the types of contents or the title.
	USB	
Network	Internet Content	Displays the Home screen of VIERA CAST (⇒ 36)
	Home Network	(⇒ 37)
iPod	All	(⇒ 34)
	Music	
	Videos	
FM Radio	To enjoy the FM radio (⇒ 31)	
EXT IN	AUX ^{*1}	When using an Audio cable
	ARC ^{*1}	When using an HDMI cable (Available when using an ARC compatible TV)
	DIGITAL IN ^{*1, 2}	When using an Optical digital audio cable
	BTT362 HDMI IN1 HDMI IN2	When connecting to HDMI IN1 and/or HDMI IN2 terminal (⇒ 16)
Sound	Select sound quality (equalizer). (⇒ 24)	
Others	Setup	(⇒ 39)
	SD Card Management	(⇒ 27)
	Wallpaper	Changes the screen background of HOME menu.

To show the HOME menu

Press [HOME].



- Items to be displayed may vary with the media.
- When the selector is switched, it may take time to playback the selected video and/or audio.

*1 "(TV)" is displayed next to items set for TV AUDIO input.

*2 "(CABLE/SATELLITE)" is displayed next to DIGITAL IN when set for CABLE/SATELLITE AUDIO input.

Enjoying sound effects from all speakers

Enjoying surround sound effects

Press [SURROUND] several times to select the effect.

7.1CH VIRTUAL SURROUND

You can enjoy 5.1/6.1/7.1-channel surround-like effect using 2.1-channel speakers.

2CH STEREO

You can play any source in stereo. Sound will be output to the front speakers and the subwoofer only.

■ Adjusting speaker level during play

- ① Press and hold [–CH SELECT] to activate the speaker setting mode.
- ② Press [–CH SELECT] several times to select the speaker. Each time you press the button:

L R → SW
↑

L R: Front speaker

(left and right: only the balance is adjustable.)

- Press [◀, ▶] to adjust the balance of the front speakers.

SW: Subwoofer

- The channels not included in the playing audio will not be displayed (subwoofer is displayed even if it is not included).
- ③ Press [▲] (increase) or [▼] (decrease) to adjust the speaker level of the subwoofer.
–6 dB to +6 dB

■ Changing the sound modes

- ① Press [SOUND] several times to select the mode.
 - The selected mode will only be displayed on the main unit.
- ② While the selected mode is displayed Press [◀, ▶] and select the desired setting.

EQUALIZER

You can select sound quality settings.

FLAT

Cancel (no effect is added).

HEAVY

Adds punch to rock.

CLEAR

Clarifies higher sounds.

SOFT

For background music.

SUBWOOFER LEVEL

You can adjust the amount of bass.

1 (Weakest effect) to 4 (Strongest effect)

- The setting you make is retained, and recalled every time you play the same type of source.

H.BASS

You can enhance low-frequency sound so that heavy bass sound can be heard clearly, even if the acoustics of your room are not optimal.

- The setting you make is retained, and recalled every time you play from the same type of source.

WHISPER-MODE SURROUND

You can enhance the surround effect for low volume sound. (Convenient for late night viewing.)



- The sound effects/modes may not be available or have no effect with some sources.
- You may experience a reduction in sound quality when these sound effects/modes are used with some sources. If this occurs, turn the sound effects/modes off.

Playing video contents

BD DVD CD SD USB

1 Insert the media.

When the contents menu is displayed, press [▲, ▼, ◀, ▶] to select the item. (⇒ 23)

2 Press [▲, ▼] to select the title and press [OK].

When a message screen is displayed while playing back 3D compatible video software, play back in accordance with the instructions.

■ To show menus

You can display Top Menu, DIRECT NAVIGATOR or Pop-up Menu. Press [POP-UP MENU, TOP MENU].

- Press [▲, ▼, ◀, ▶] to select the item and press [OK].

■ To show the status messages

While playing, press [STATUS].

The status messages give you information about what is currently being played. Each time you press [STATUS], the display information may change or will disappear from the screen.

e.g. BD-Video



- Signal from PAL discs is output as PAL. Signal from NTSC discs is output as "NTSC" or "PAL60". You can select "NTSC" or "PAL60" in "NTSC Contents Output" for NTSC discs. (⇒ 40)
- DISCS CONTINUE TO ROTATE WHILE MENUS ARE DISPLAYED. Press [■STOP] when you have finished playback to protect the unit's motor, your television screen and so on.
- Depending on media and contents, the display may change or may not appear.
- DivX and MKV: Successive play is not possible.
- It is not possible to playback AVCHD and MPEG2 video which have been dragged and dropped, copied and pasted to the media.

Other operations during play

These functions may not work depending on the media and contents.

Stop

Press [■STOP].

The stopped position is memorised.

Resume play function

Press [▶PLAY] to restart from this position.

- The position is cleared if the tray is opened or you press [■STOP] several times to display "STOP" on the unit's display.
- On BD-Video discs including BD-J, the resume play function does not work.

Pause

Press [⏸PAUSE].

- Press [⏸PAUSE] again or [▶PLAY] to restart play.

Search/Slow-motion

Search

While playing, press [SEARCH◀◀] or [SEARCH▶▶].

- Music and MP3: The speed is fixed to a single step.

Slow-motion

While paused, press [SEARCH◀◀] or [SEARCH▶▶].

- BD-Video and AVCHD: Forward direction [SEARCH▶▶] only.

The speed increases up to 5 steps.

- Press [▶PLAY] to revert to normal playback speed.

Skip

While playing or paused, press [◀◀] or [▶▶].

Skip to the title, chapter or track you want to play.

- Each press increases the number of skips.

Frame-by-frame

While paused, press [◀] (◀||) or [▶] (||▶).

- Press and hold to change in succession forward or backward.
- Press [▶PLAY] to revert to normal playback speed.
- BD-Video and AVCHD: Forward direction [▶] (||▶) only.

Press [AUDIO].

You can change the audio channel number or soundtrack language, etc.

■ Selecting the type of audio from the DIGITAL AUDIO IN terminal

Select to suit the type of audio from the DIGITAL IN terminal on the main unit.

- ① Press [EXT-IN] several times to select "DIGITAL IN" (D-IN).
- ② Press [AUDIO].

M1

M2

M1+M2 (stereo audio)

(Only works with Dolby Dual Mono)

- "M1" or "M2" is not available if "On" is selected in "PCM-Fix" of "DIGITAL IN". (⇒ 41)



- Audio that is input through the DIGITAL AUDIO IN or AUX terminals are not output from the HDMI AV OUT terminal.

1 Press [OPTION].

2 Select an item and press [OK].

While DIRECT NAVIGATOR screen is displayed

Properties	To display the title properties (recording date, etc.).
Chapter View	To select the chapter.
View Playlists	To play playlists.
View Titles	To select the title.
Folder	To switch to another folder.

While playing

Screen Aspect	When black bars are shown at the top, bottom, left and right sides of the screen, you can enlarge the image to fill the screen.
Top Menu	To display Top Menu.
Pop-up Menu	To display Pop-up Menu.
Menu	To display Menu.
3D Settings	2D video can be virtually output as 3D, or output effect of the 3D video can be setup. (⇒ 29)

- Depending on the played contents if you perform "Screen Aspect", there may be no effect.
- When "TV Aspect" (⇒ 41) is set to "4:3" or "4:3 Letterbox", the "Zoom" effect in "Screen Aspect" is disabled.



- Depending on the media and contents, displayed items are different.

■ Displaying subtitle text

You can display subtitle text on the DivX and MKV video disc with this unit.

The operation might be different or it may not operate properly depending on the way the file was made or the state of this unit (playing, stopped, etc.).

Set "Subtitle" in "Disc" (⇒ 38)



- DivX and MKV video files that do not display "Text" do not contain subtitle text.
- If the subtitle text is not displayed correctly, try changing the language settings. (⇒ 40)
- This function has no relation to the subtitles specified in DivX standard specifications and has no clear standard.

Enjoying BD-Live or picture-in-picture in BD-Video

Enjoying BD-Live discs with Internet

BD-Live allows you to enjoy more functions such as subtitles, exclusive images and online games by connecting this unit to the Internet. Since most of the BD-Live compatible discs are played back using the BD-Live function, additional contents are required to be downloaded into the external memory (local storage).

- This unit uses an SD card as a local storage device. BD-Live function cannot be used when there is no SD card inserted.

- 1 Perform network connection and settings.**
(⇒ 17, 20)
- 2 Insert an SD card with 1 GB or more free space.**
- 3 Insert the disc.**

■ Deleting data/Formatting SD cards

If you no longer need data recorded on the SD card, you can delete data with the following operation.

- ① Insert an SD card.
- ② Press [HOME].
- ③ Press [▲, ▼, ◀, ▶] to select “Others” and press [OK].
- ④ Press [▶] to select “SD Card Management” and press [OK].
- ⑤ Press [▲, ▼] to select “BD-Video Data Erase” or “Format SD Card” and press [OK].

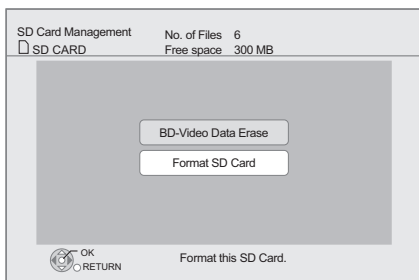

- ⑥ Press [◀, ▶] to select “Yes” and press [OK].
- ⑦ Press [◀, ▶] to select “Start” and press [OK].

Playing picture-in-picture

To turn on/off secondary video
Press [PIP].

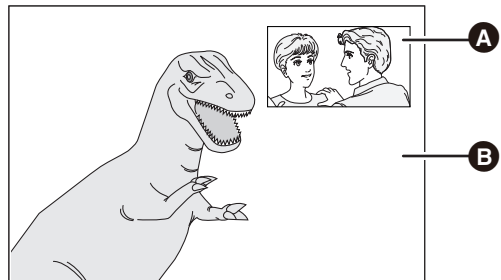

A Secondary video

B Primary video

To turn on/off secondary audio

[DISPLAY] ⇒ select “Disc” ⇒ [▶] ⇒ select “Signal Type” ⇒ [OK] ⇒ set “Soundtrack” in “Secondary Video” to “On” or “Off”



- The usable functions and the operating method may vary with each disc, please refer to the instructions on the disc and/or visit their website.
- Some BD-Live content available on the Blu-ray discs may require an Internet account to be created in order to access the BD-Live content. Follow the screen display or instruction manual of the disc for information on acquiring an account.
- To use BD-Live function, it is recommended that you format the card on this unit. If the SD card you use is formatted, all data on the card will be erased. It cannot be recovered.
- “BD-Live Internet Access” may need to be changed for certain discs (⇒ 40).
- When discs supporting BD-Live are played back, the player or disc IDs may be sent to the content provider via the Internet.
- During search/slow-motion or frame-by-frame, only the primary video is displayed.
- When “BD-Video Secondary Audio” in “Digital Audio Output” is set to “Off”, secondary audio will not be played (⇒ 40).

Regarding DivX

ABOUT DIVX VIDEO:

DivX® is a digital video format created by DivX, Inc. This is an official DivX Certified® device that plays DivX video. Visit divx.com for more information and software tools to convert your files into DivX video.

ABOUT DIVX VIDEO-ON-DEMAND:

This DivX Certified® device must be registered in order to play purchased DivX Video-on-Demand (VOD) movies. To obtain your registration code, locate the DivX VOD section in your device setup menu. Go to vod.divx.com for more information on how to complete your registration.

- Video images of the copyright-protected DivX contents stored on USB device can be output only through the HDMI output terminal.

Display the unit's registration code.

(⇒ 43, "DivX Registration" in "Others")

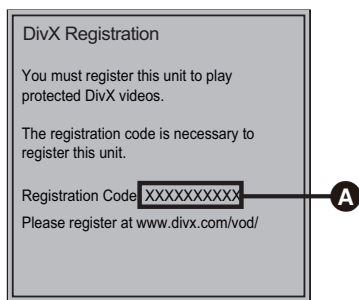

A 10 alphanumeric characters

- After playing DivX VOD content for the first time, the registration code is not displayed.
- If you purchase DivX VOD content using a registration code different from this unit's code, you will not be able to play this content.

Cancel the unit's registration.

(⇒ 43, "DivX Registration" in "Others")

Press [◀, ▶] to select "Yes" in "DivX Registration".

Use the deregistration code to cancel the registration in www.divx.com.

Regarding DivX VOD content that can only be played a set number of times

Some DivX VOD contents can only be played a set number of times. When you play this content, the number of times already played and initially playable number of times is displayed.

- The remaining number of plays decreases each time a programme is played. However, when playing from the point where play was previously stopped, the remaining number of plays does not decrease due to the resume play function.

Playing music

DVD CD USB

(DVD-R/-R DL, music CD, CD-R/RW, USB device)

1 Insert the media.

When the contents menu is displayed, press [▲, ▼, ◀, ▶] to select the item.(⇒ 23)

2 Press [▲, ▼] to select the track and press [OK].

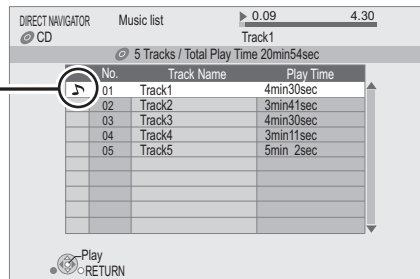

"🎵" indicates the track currently playing.

To exit the screen

Press [RETURN].

Playing a track in another folder

1 While DIRECT NAVIGATOR screen is displayed Press [OPTION].

2 Press [▲, ▼] to select "Select Folder" and press [OK].



- You cannot select folders that contain no compatible tracks.

Enjoying 3D video

You can enjoy powerful 3D videos with realistic sensations by connecting this unit with a High Speed HDMI Cable to a 3D compatible TV.



The image is an illustration.

When playing back a disc that has recorded titles with a 2 screen structure (Side by side) etc. which can be enjoyed in 3D, it will playback in accordance with the 3D settings on the TV, regardless of the settings mentioned to the table below.

- Screen displays, such as Playback menu, will not display correctly.

Preparation

Connect 3D compatible TV to an HDMI AV OUT terminal of this unit using a High Speed HDMI Cable, and select HDMI video input mode on the TV. (⇒ 14, 15)

- Perform the necessary preparations for the TV.

Method of playback is the same as normal disc playback. (⇒ 25)

- Playback following the instructions displayed on the screen.

3D settings

Perform the following settings as necessary.

3D BD-Video Playback	It is also possible to play back 3D discs in 2D (conventional video). (⇒ 40)
3D Type	If 3D video cannot be played back in 3D, change the settings as required by the connected TV format. (⇒ 41) <ul style="list-style-type: none"> • Change the settings for 3D on the TV also when “Side by side” is selected.
3D Playback Message	Hide the 3D viewing warning screen. (⇒ 41)
Graphic Display Level	Adjust the pop-up position for the playback menu or message screen etc. (⇒ 38)

Useful functions

- 1 While playing, Press [OPTION].
- 2 Press [▲, ▼] to select “3D Settings” and press [OK].
- 3 Select an item, then press [OK].

Signal Format	Original	Keep original picture format.
	Side by side	3D picture format comprising of left and right screens.
	2D to 3D	Converts 2D pictures to 3D effect.
3D Picture Mode	Normal	Playback pictures with normal 3D effects.
	Soft	You can enjoy 3D pictures with a feeling of broadness, holding back the depth perception.
	Manual Settings	Set 3D effect manually. <p>Distance Set the amount of depth perception.</p> <p>Screen Type Selects how the screen appears during 3D playback (flat or round).</p> <p>Frame Width Set the amount of feathering at the edge of screen.</p> <p>Frame Colour Set the colour of feathering at the edge of screen.</p>



- Depending on the contents, displayed items are different.
- Please refrain from viewing 3D images if you do not feel well or are experiencing visual fatigue.
In the event that you experience dizziness, nausea, or other discomfort while viewing 3D images, discontinue use and rest your eyes.
- Depending on the connected TV, the video being played back might switch to 2D video due to changes in resolution etc. Check the 3D setting on the TV.
- 3D video might not output the way it is set in “HDMI Video Format” or “24p Output” (⇒ 41).

Playing still pictures

BD DVD CD SD USB

(BD-RE, DVD-R/-R DL, CD-R/RW, SD Card, USB device)

In order to play back 3D still pictures (MPO), this unit should be connected to a Full HD 3D compatible TV via an HDMI terminal.

1 Insert the media.

When the contents menu is displayed, press [▲, ▼, ◀, ▶] to select the item. (⇒ 23)

2 Press [▲, ▼] to select the folder and press [OK].

“3D”: 3D still pictures (MPO) are sorted here. To play back in 3D, select from “3D”. (Still pictures in “2D” are played back in 2D)

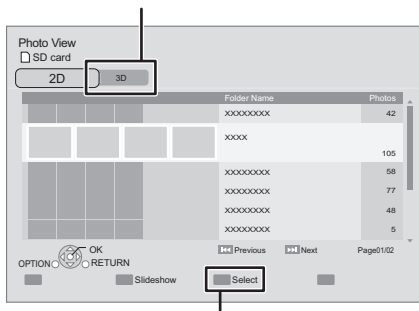

To select folders or still pictures that are played on slideshow.

3 Press [▲, ▼, ◀, ▶] to select the still picture and press [OK].

Press [◀, ▶] to display the previous or next still picture.

To exit the screen

Press [RETURN].

■ To show the still picture properties

While playing, press [STATUS] once or twice.



To exit the screen

Press [STATUS].

Useful functions

1 Press [OPTION].

2 Select an item, then press [OK].

While Photo View screen is displayed

Slideshow	Start Slideshow You can display still pictures one by one at a constant interval.
	Interval Change the display interval.
	Transition Effect Set display method.
	Repeat Play Repeat slideshow.
	Random Soundtrack Background music is played in random order.
	Soundtrack An MP3 on the USB device and the iPod/iPhone can be played back during the slideshow of JPEG on the USB device or the SD card. (A music CD also can be played back during the slideshow of JPEG on the SD card.)

While playing

Start Slideshow	Start the slideshow.
Screen Aspect	Switch the screen mode.
Status	Show the still picture properties.
Rotate RIGHT	Rotate the still picture.
Rotate LEFT	
Wallpaper	Set the still picture to the wallpaper of HOME screen. (⇒ 23)
Graphic Display Level	Pop-up position for the playback menu or message screen etc. can be adjusted during 3D playback.



- Depending on the condition of the unit and media contents, displayed items are different.
- When viewing a 3D still picture, some functions may not work.
- When a still picture with large number of pixels is played, the display interval may become longer. Even if the setting is changed, the display interval may not become shorter.
- When a music CD, a USB device with MP3 recorded and an iPod/iPhone are inserted/connected to this unit, iPod/iPhone has a priority to be played back as background music.
- Still pictures displayed as “☒” cannot be played back with this unit.

Listening to the Radio

Presetting stations automatically

Up to 30 stations can be set.

- 1 Press [RADIO] to select “FM”.
- 2 Press [STATUS] to select the position to start the auto preset search.

LOWEST:

To begin auto preset with the lowest frequency (FM87.50).

CURRENT:

To begin auto preset with the current frequency.*

*To change the frequency, refer to “Presetting stations manually”.

- 3 Press and hold [OK].

Release the button when “AUTO” is displayed.

The tuner starts to preset all the stations it can receive into the channels in ascending order.



- “SET OK” is displayed when the stations are set, and the radio tunes to the last preset station.
- “ERROR” is displayed when automatic presetting is unsuccessful. Preset the stations manually.

Presetting stations manually

Preparation

Select a radio broadcast.

- ① Press [RADIO] to select “FM”.
 - ② Press [SEARCH◀◀] or [SEARCH▶▶] to select the frequency.
- To start automatic tuning, press and hold [SEARCH◀◀], [SEARCH▶▶] until the frequency starts scrolling. Tuning stops when a station is found.

- 1 While listening to the radio broadcast Press [OK].
- 2 While “P” is flashing on the display Press the number buttons to select a channel.

To select a 1-digit number

e.g., 1: [1] ⇒ [OK].

To select a 2-digit number

e.g., 12: [1] ⇒ [2]



- A station previously stored is overwritten when another station is stored in the same channel preset.

Listening/confirming the preset channels

- 1 Press [RADIO] to select “FM”.
- 2 Press the number buttons to select the channel.

To select a 1-digit number

e.g., 1: [1] ⇒ [OK].

To select a 2-digit number

e.g., 12: [1] ⇒ [2].

Alternatively, press [∧, ∨] or [▲, ▼].

RDS broadcasting

If the station you are listening to is transmitting RDS signals, programme service or programme type can be shown on the display.

While listening to the radio broadcast

Press [DISPLAY] to display the text data.

PS: Programme service

PTY: Programme type

OFF: Frequency display

PTY displays			
NEWS	VARIED	FINANCE	COUNTRY
AFFAIRS	POP M	CHILDREN	NATIONAL
INFO	ROCK M	SOCIAL A	OLDIES
SPORT	M.O.R. M*	RELIGION	FOLK M
EDUCATE	LIGHT M	PHONE IN	DOCUMENT
DRAMA	CLASSICS	TRAVEL	TEST
CULTURE	OTHER M	LEISURE	ALARM
SCIENCE	WEATHER	JAZZ	

* M.O.R. M=Middle of the road music

■ Display on the main unit

TUNED/STEREO:

Displayed when receiving stereo broadcasting

TUNED:

Displayed when receiving monaural broadcasting or monaural sound is selected.

■ If noise is excessive

Press [AUDIO] to display “MONO”.

The sound becomes monaural.

Press the button again to cancel the mode. “AUTO STEREO” will be displayed on the main unit. Depending on the broadcast system, stereo or monaural will be selected.

“MONO” is also cancelled when you change the frequency.

- This setting can be preset for each broadcasting station.

Enjoying TV with unit's speakers

Preparation

Turn on your TV and select the appropriate audio input mode [AUX, ARC, D-IN] to suit the connections to this unit. (⇒ 23)

Surround sound effects

You can enhance stereo sources with surround sound effect.

Press [SURROUND] several times to select the effect.

For more detailed information on this operation, please refer to the "Enjoying surround sound effects" section on page 24.

Sound modes

You can adjust the mode depending on the source or situation.

- 1 Press [SOUND] several times to select the mode.
- 2 While the selected mode is displayed on the unit's display
Press [◀, ▶] and select the desired setting.

For more detailed information on this operation, please refer to the "Changing the sound modes" section on page 24.

Linked operations with the TV (VIERA Link "HDAVI Control™")

What is VIERA Link "HDAVI Control"?

VIERA Link "HDAVI Control" is a convenient function that offers linked operations of this unit, and a Panasonic TV (VIERA) under "HDAVI Control".

You can use this function by connecting the equipment with an HDMI cable. See the operating instructions for connected equipment for operational details.

Preparation

- ① Set "VIERA Link" to "On" (⇒ 42).
(The default setting is "On".)
- ② Set the "HDAVI Control" operations on the connected equipment (e.g., TV).
- ③ Turn on all "HDAVI Control" compatible equipment and select this unit's input channel on the connected TV so that the "HDAVI Control" function works properly.

When the connection or settings are changed, repeat this procedure.

Setting the audio link

■ Setting the audio link with the TV

With the remote control;

- Select the actual TV audio connection on the main unit.

- ① Press [HOME].
- ② Press [▲, ▼, ◀, ▶] to select "Others" and press [OK].
- ③ Press [OK] to select "Setup".
- ④ Press [▲, ▼] to select "TV / Device Connection".
- ⑤ Press [▲, ▼] to select "TV Audio Input".
- ⑥ Press [◀, ▶] to switch "AUX", "ARC" or "DIGITAL IN".

- Select "AUX" or "ARC"*1 in "TV Audio Input" when the DIGITAL AUDIO IN terminal is used for the STB connection.

Whenever the connection or settings are changed, reconfirm the points above.

■ Setting the audio link with the STB

With the remote control;

- Select the STB input channel on the TV.

- ① Press [EXT-IN] to select "D-IN".
- ② Press [STATUS] to select "CABLE/SATELLITE AUDIO ON".

- If the input channel of the STB on the TV is changed or if you want to change the device allocated for the linked operations, select "CABLE/SATELLITE AUDIO OFF" in step ② above and then repeat steps ① to ②.

● BTT362

If using "HDMI IN1" or "HDMI IN2" as a source, set to "CABLE/SATELLITE AUDIO OFF" in step ②.



- VIERA Link "HDAVI Control", based on the control functions provided by HDMI which is an industry standard known as HDMI CEC (Consumer Electronics Control), is a unique function that we have developed and added. As such, its operation with other manufacturers' equipment that supports HDMI CEC cannot be guaranteed.
- This unit supports "HDAVI Control 5" function. "HDAVI Control 5" is the newest standard (current as of December, 2010) for Panasonic's HDAVI Control compatible equipment. This standard is compatible with Panasonic's conventional HDAVI equipment.
- Please refer to individual manuals for other manufacturers' equipment supporting VIERA Link function.

Speaker Selection

You can select whether audio is output from the unit's speakers or the TV speakers by using the TV menu settings.

Home Cinema

This unit's speakers are active.

- When this unit is in standby mode, changing the TV speakers to this unit's speakers in the TV menu will automatically turn the unit on and select, "AUX"*2, "ARC"*1, *2 or "D-IN" (DIGITAL IN)*2 as the source.
- You can control the volume setting using the volume or mute button on the TV's remote control.
- If you turn off this unit, TV speakers will be automatically activated.

TV

TV speakers are active.

- The volume of this unit is set to "0".
- Audio output is 2-channel audio.



- When switching between this unit's speakers and TV speakers, the TV screen may be blank for several seconds.
- The audio from "AUX", "DIGITAL IN", "FM Radio" or "iPod" will be output from this unit's speakers even though the TV speakers are selected.

Automatic input switching (Power on link)

When the following operations are performed, the television will automatically switch the input channel and display the corresponding action. When the television is off, the television will automatically turn on.

- When play starts on the unit
- When an action that uses the display screen is performed (e.g., DIRECT NAVIGATOR screen)
- When you switch the TV input to TV tuner mode, this unit will automatically switch to "AUX"*2, "ARC"*1, *2 or "D-IN" (DIGITAL IN)*2.
- This function does not work when the iPod/iPhone selector is chosen. (⇒ 35)

Automatic lip-sync function (for HDAVI Control 3 or later)

Delay between audio and video is automatically adjusted, enabling you to enjoy smooth audio for the picture.(⇒ 41, "Audio Delay")

- This function works only when "BD/DVD", "SD", "USB", "AUX"*2, "ARC"*1, *2 or "D-IN" (DIGITAL IN)*2 is selected as the source on this unit.

*1 The selection works only when using an ARC compatible TV.

*2 "AUX", "ARC" or "D-IN" works depending on the setting in "Setting the audio link".

Power Off Link

All connected equipment compatible with "HDAVI Control", including this unit, automatically turns off when you switch the television off.

Playing music continuously even after turning off the TV
(When the unit is connected to a Panasonic TV (VIERA) that supports HDAVI Control 2 or later.)
Select "Video" in "Power Off Link" (⇒ 42)

Easy control only with VIERA remote control

Only TV supports "HDAVI Control 2" or later

By using the TV remote control, you can play discs using the "Control Panel" and display the Top Menu or Pop-up Menu, etc.

- This works only during "BD/DVD", "SD" or "USB" playback and resume modes.

1 Press [OPTION].

e.g. BD-Video

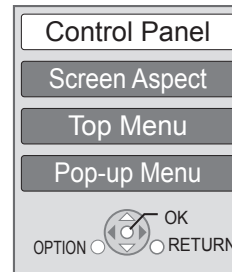

2 Select an item, then press [OK].

- The OPTION menu may not appear while the Top Menu for BD-Video or DVD-Video is displayed.



- The buttons that you can use for this unit vary depending on the TV. For details, refer to the operating instructions of the TV.
- The operation of this unit may be interrupted when you press incompatible buttons on the TV remote control.
- Depending on the menu, some button operations cannot be performed from the TV's remote control.

Using the iPod/iPhone

Compatible iPod/iPhone (as of January 2011)

- Update your iPod/iPhone with the latest software before using this unit.
- Compatibility depends on the software version of your iPod/iPhone.
- iPod/iPhone compatibility assures music, video playback and battery charge functions of this unit as a home theatre system.

Name	Memory size
iPod touch 4th generation	8 GB, 32 GB, 64 GB
iPod nano 6th generation*	8 GB, 16 GB
iPod touch 3rd generation	32 GB, 64 GB
iPod nano 5th generation (video camera)	8 GB, 16 GB
iPod touch 2nd generation	8 GB, 16 GB, 32 GB
iPod classic	120 GB, 160 GB (2009)
iPod nano 4th generation (video)	8 GB, 16 GB
iPod classic	160 GB (2007)
iPod touch 1st generation	8 GB, 16 GB, 32 GB
iPod nano 3rd generation (video)	4 GB, 8 GB
iPod classic	80 GB
iPod nano 2nd generation (aluminum)	2 GB, 4 GB, 8 GB
iPod 5th generation (video)	60 GB, 80 GB
iPod 5th generation (video)	30 GB
iPod nano 1st generation	1 GB, 2 GB, 4 GB
iPhone 4	16 GB, 32 GB
iPhone 3GS	8 GB, 16 GB, 32 GB
iPhone 3G	8 GB, 16 GB

* Playback functions on the main unit may be limited in the "All" mode.

In some locations, reception status of an iPhone may be poor when it is loaded on this unit.



- When the iPhone receives a call while connected to this unit, playback, etc. of the iPhone may stop.
To prioritize the operation with the iPhone connected to this unit, make the setting so that the iPhone does not receive calls.

iPod/iPhone Connection

Preparation

- Before connecting/disconnecting the iPod/iPhone, turn the main unit off or reduce the volume of the main unit to its minimum.
- Make sure that the video cable connection is made to view photos/videos from the iPod/iPhone.

- 1 Push the centre of drawer (A), and pull out fully until it clicks to open the Dock for iPod/iPhone (C).**
- 2 Install a Dock adapter (not supplied) (B) before inserting your iPod/iPhone into the dock.**
- 3 Connect the iPod/iPhone (not supplied) firmly.**

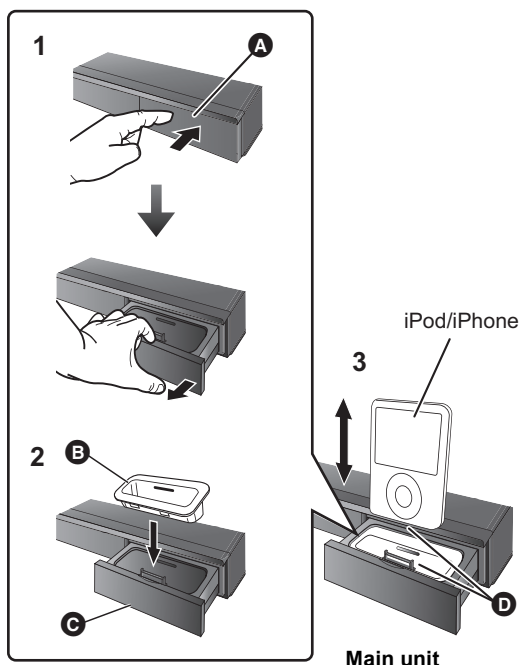

- The centre of drawer
- Dock adapter (not supplied)
 - Please be sure to use the adapter that is compatible with your model of iPod/iPhone.
 - Attach the dock adapter until it is firmly in place.
 - To purchase a dock adapter, consult your local iPod/iPhone dealer.
- Dock for iPod/iPhone
- Make sure to match when inserting.
 - Carefully insert and remove the iPod/iPhone to ensure long lasting product enjoyment.
 - Check that the connector has no dust or foreign materials before connecting.



- The 3D logo on the Dock for iPod/iPhone does not mean that the iPod/iPhone has 3D capabilities.

About recharging the battery

- iPod/iPhone will start recharging regardless of whether this unit is on or off.
- "IPOD *" will be shown on the main unit's display during iPod/iPhone charging in main unit standby mode.
- Once fully recharged, additional recharging will not occur.

iPod/iPhone Playback

Preparation

- Make sure that the “IPOD” source is selected. Press [iPod] to select the source.
- **To view photos/videos from the iPod/iPhone**
Operate the iPod/iPhone menu to make the appropriate photo/video output settings for your TV.
- To display the picture, turn on the TV and select the appropriate video input mode.

Enjoy music/video

- 1 Press [iPod] to select “IPOD”.**
- 2 Press [STATUS] several times to select the music menu or videos menu.**
 - You can also select “Videos” or “Music” by using HOME menu. (⇒ 23)
- 3 Press [▲, ▼] to select an item and press [OK].**
 - Repeat this step until the selected title starts playback.
 - Press [◀, ▶] to display the previous or next page.

e.g., music playback screen

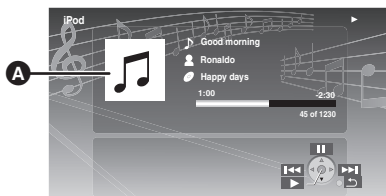

- A** Album artwork
 - If album artwork is contained in the data of a song, it will be appear on the TV. If there is no album artwork, “” will be appear on TV.
 - Depending on the software version of your iPod/iPhone, the album artwork may not appear properly.
 - It may take time to read the album artwork.
 - Some operations may not work while reading the album artwork.

To exit, press [RETURN].

Basic controls

(For music and video playback only)

Buttons	Functions
[▶PLAY]	Play
[■STOP]	Pause
[PAUSE]	
[◀◀, ▶▶]	Skip
(Press and hold) [SEARCH◀◀, SEARCH▶▶]	Search

Enjoy photos

- 1 Press [iPod] to select “IPOD”.**
- 2 Press [STATUS] several times to select “ALL” on the unit’s display.**
 - You can also select “All” by using HOME menu. (⇒ 23)
- 3 Switch the TV input to video in.**
- 4 Play a slideshow on your iPod/iPhone.**
The picture will be displayed on your TV.

To use the iPod touch/iPhone features

- ① Press the Home button on the iPod touch/iPhone.
- ② Select the iPod touch/iPhone features on the touch screen to operate.

You can use the remote control to operate the iPod/iPhone menu.

The operation may vary among iPod/iPhone models.

- [▲, ▼]: To navigate menu items.
- [OK]: To go to the next menu.
- [RETURN]: To return to the previous menu.

Other methods of playback

- 1 Press [OPTION].**
- 2 Press [▲, ▼] to select the item and press [OK].**

Play Mode

Shuffle (For music playback only.)

Songs:

Play all songs on iPod/iPhone in random order.

Albums:

Play all songs on an album in random order.

Repeat

One:

Play a single song/video repeatedly.

All:

Play all songs/videos from selected items (e.g., Playlists, Albums, etc.) repeatedly.

iPod Information

Display the firmware version of iPod/iPhone.

- 3 Press [▲, ▼] to select the setting and press [OK].**



- The setting of the playback mode will be kept until changes are made on the same iPod/iPhone.
- This function does not work when “All” is selected.
- Surround sound effect and sound mode are available (⇒ 24).

Enjoying VIERA CAST

You can access a selection of Internet services from the Home screen with VIERA CAST, for example YouTube, Picasa Web Albums. (Current as of January 2011)

Preparation

- Network connection (⇒ 17)
- Network setting (⇒ 20)

BTT362

To enjoy video communication (ex. Skype™):

- Connect this unit with optional Communication Camera (TY-CC10W or compatible equipment). Depending on the area, this optional camera may not be available. Please consult your local Panasonic dealer for advice.

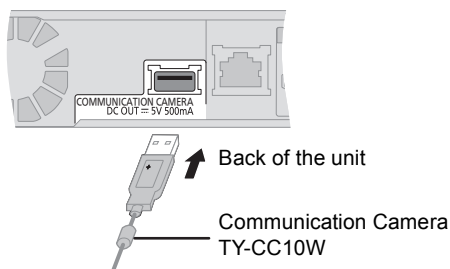

- For operating method refer to the following website.
<http://panasonic.jp/support/global/cs/>
(This site is in English only.)

1 Press [VIERA CAST].

BTT362

- The video communication service can be accessed directly by [S] button.
- Message is displayed. Please read these instructions carefully and then press [OK].

2 Press [▲, ▼, ◀, ▶] to select the item and press [OK].

Operable buttons:

[▲, ▼, ◀, ▶], [OK], [RETURN], coloured buttons, number buttons

VIERA CAST Home screen;



Images are for illustration purposes, contents may change without notice.

To exit from VIERA CAST

Press [EXIT] or [HOME].



- When playing content from a disc/SD card and/or USB device VIERA CAST cannot be accessed by pressing [VIERA CAST].
- In the following cases, settings are possible using "Internet Content Settings" (⇒ 43)
 - When restricting the use of VIERA CAST.
 - When the audio is distorted.
 - When wrong time is displayed
- If using slow Internet connection, the video may not be displayed correctly. A high-speed Internet service with a speed of at least 6 Mbps is recommended.
- Be sure to update the firmware when a firmware update notice is displayed on the screen. If the firmware is not updated, you will not be able to use the VIERA CAST function. (⇒ 22)
- VIERA CAST home screen is subject to change without notice.
- The services through VIERA CAST are operated by their respective service providers, and service may be discontinued either temporarily or permanently without notice. Therefore, Panasonic will make no warranty for the content or the continuity of the services.
- All features of websites or content of the service may not be available.
- Some content may be inappropriate for some viewers.
- Some content may only be available for specific countries and may be presented in specific languages.

Playing back contents on the DLNA server (DLNA)

You can enjoy viewing video, still pictures and music saved on a DLNA Certified media server connected to the home network with this unit.

You can also enjoy viewing the video and still pictures recorded in Panasonic DLNA compatible recorders (DIGA).

- The countries where DIGA is available are limited. Refer to following site for availability.

<http://panasonic.jp/support/global/cs/>

Preparation

- ① Perform network connection (⇒ 17) and network setting (⇒ 20) of this unit.
- ② Perform Home Network settings of the connected equipment.

When connected to a PC with Windows 7 installed

- Add the contents and folder to the Windows Media® Player library.
- Playlist of Windows Media® Player can play back only the contents that are stored in the libraries.

Regarding setting method of Windows 7 refer to its instructions or help.

When connected to a Panasonic DLNA compatible recorder (DIGA)

When a message requesting operation of the equipment to be registered is displayed, perform step 1 and 3. (⇒ right)

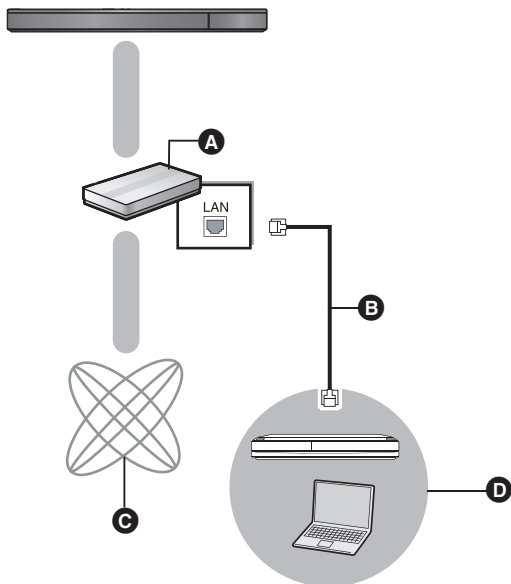

- A** Broadband router, Wireless router, etc.
- B** LAN Cable
- C** Internet
- D** DLNA Certified media server

For details about the setting and operation method of connected equipment, and compatible equipment, refer to the following Website and the operating instructions for each item of equipment.
<http://panasonic.jp/support/global/cs/>
 (This site is in English only.)

- 1** Press [HOME].
- 2** Press [▲, ▼] to select “Network” and press [OK].
- 3** Press [◀, ▶] to select “Home Network” and press [OK].
 - A list of equipment connected via the network is displayed.
 - This list can be updated by pressing the red button on the remote control.

e.g.

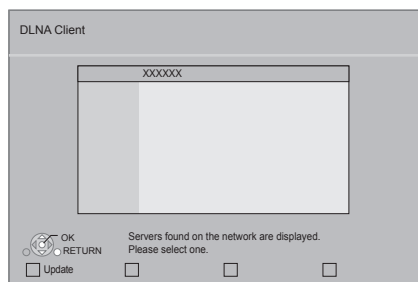

- 4** Press [▲, ▼] to select the equipment to playback the contents, and press [OK].
- 5** Press [▲, ▼, ▶, ◀] to select the item to playback (folder), and press [OK].
 - You may be able to use convenient functions depending on the content by pressing [OPTION] or [DISPLAY].
 - Control Panel is displayed once the playback starts. Operation can be performed with [▲, ▼, ▶, ◀], [OK] and [EXIT].

Control Panel

e.g.

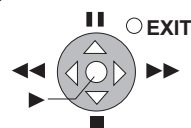

- Press [OK] if the Control Panel is not displayed.
- Press [RETURN] to hide the Control Panel.

To exit from Home Network

Press [EXIT] or [HOME].



- Ensure that the router for your home network has adequate security system to prevent unauthorized access.
- Menu structure will be different depending on the equipment connected to this unit. Select the contents by repeating the operation.
- Depending on the contents and the connected equipment, playback may not be possible.
- Items displayed in grey on the display cannot be played back by this unit.
- This unit cannot be played back via connected equipment.
- Depending on the performance of the connected PC, video frames may be dropped during playback, or video may not playback at all.

Playback menu

1 Press [DISPLAY].

e.g., BD-Video

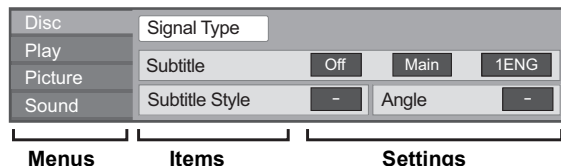

2 Press [▲, ▼] to select the menu and press [▶].

3 Press [▲, ▼, ◀, ▶] to select the item and press [▶].

4 Press [▲, ▼] to select the setting.

Some items can be changed by pressing [OK].

To exit the screen

Press [DISPLAY].

Depending on the condition of the unit (playing, stopped, etc.) and media contents, there may be some items that you cannot select or change.

Regarding Language: (⇒ 50)

Disc

Signal Type

Primary Video	Video	The recording method of original video appears.
	Soundtrack	Select the type of audio or language.
Secondary Video	Video	Select on/off of images. The recording method of original video appears.
	Soundtrack	Select on/off of audio and the language.

Video

The recording method of original video appears.

Soundtrack

Show or change the soundtrack.

Subtitle

Turn the subtitle on/off, and change the language depending on the media.

Subtitle Style

Select the subtitle style.

Audio channel

Select the audio channel number.

(⇒ 26, "Changing audio")

Angle

Select the number of the angle.

Play

Repeat Play

(Only when the elapsed time is being displayed on the unit's display.)

Select the item which you want to repeat. The items displayed differ depending on the type of media.

Select "Off" to cancel.

Random

Select whether or not to play random.

Graphic Display Level

(Only when "Full HD" is selected in "3D Type" (⇒ 41).)

Pop-up position for the playback menu or message screen etc. can be adjusted during 3D playback.

Picture

Mode

Select the picture quality mode during play.

Advanced Settings

Chroma Process

The high-resolution processing of HDMI chroma signals produces a high-resolution picture with rich picture quality.

Detail Clarity

The picture is sharp and detailed.

Super Resolution

Pictures of normal image quality are corrected to sharp and detailed images when output as 1080i/1080p from HDMI AV OUT.

Progressive

Select the method of conversion for progressive output to suit the type of material being played.

- If the video is disrupted when "Auto" is selected, select either "Video" or "Film" depending on the material to be played back.

24p

Movies and other material recorded on DVD-Video at 24p are output at 24p.

- Only when you have selected "On" in "24p Output" (⇒ 41) and play discs recorded at a rate of 60 fields per second.



Music Sound Effects*1, *2

Select the sound effect.

- **Digital Tube Sound:**
This feature gives you warm sound, like that produced by a vacuum tube amplifier.
- **Re-master:**
This feature gives you brighter sound by increasing the high frequency portion of the audio. (Discs recorded at 48 kHz or less)
Recommended setting

Re-master 1	Pop and rock
Re-master 2	Jazz
Re-master 3	Classical

High Clarity Sound

When connected to TV via the HDMI AV OUT terminal for outputting image, it produces clearer sound.

- Only when you have selected "Enable" in "High Clarity Sound" (⇒ 41)

*1 When audio is output from the HDMI AV OUT terminal this function is effective only when "Dolby D/Dolby D +/Dolby TrueHD" or "DTS/DTS-HD" is set to "PCM". (⇒ 40)

*2 This function has no effect when the type of audio is Dolby Pro Logic II.

Setup menu

Change the unit's settings if necessary. The settings remain intact even if you switch the unit to standby.

- 1 Press [HOME].
- 2 Press [▲, ▼, ◀, ▶] to select "Others" and press [OK].
- 3 Press [OK] to select "Setup".

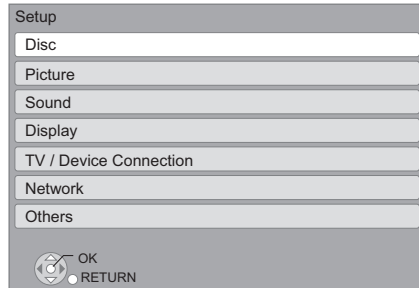

- 4 Press [▲, ▼] to select the menu and press [OK].
- 5 Press [▲, ▼] to select the item and press [OK].
If there are any other items, repeat these steps.
- 6 Press [▲, ▼, ◀, ▶] to select the option and press [OK].



- There may be differences in operation methods. If this happens, follow the on-screen instructions for the operation.

About the password

The following items use the same password.
Don't forget your password.

- "DVD-Video Ratings"
- "BD-Video Ratings"
- "Lock" (⇒ 43)

Disc

DVD-Video Ratings

Set a ratings level to limit DVD-Video play.

- Follow the on-screen instructions. Enter a 4-digit password with the number buttons when the password screen is shown.

BD-Video Ratings

Set an age limit of BD-Video play.

- Follow the on-screen instructions. Enter a 4-digit password with the number buttons when the password screen is shown.

3D BD-Video Playback

Select the playback method of 3D compatible video software.

Soundtrack Preference

Choose the language for audio.

- If "Original" is selected, the original language of each disc will be selected.
- Enter a code (⇒ 50) with the number buttons when you select "Other ****".

Subtitle Preference

Choose the language for the subtitle.

- If "Automatic" is selected and the language selected for "Soundtrack Preference" is not available, subtitles of that language will automatically appear if available on that disc.
- Enter a code (⇒ 50) with the number buttons when you select "Other ****".

Menu Preference

Choose the language for the disc menus.

- Enter a code (⇒ 50) with the number buttons when you select "Other ****".

BD-Live Internet Access (⇒ 27)

You can restrict Internet access when BD-Live functions are used.

- If "Limit" is selected, Internet access is permitted only for BD-Live contents which have content owner certificates.

Subtitle Text

Select a suitable item according to the language used for DivX or MKV subtitles text (⇒ 26).

- This item is displayed only after playing back a file.

Picture

Still Mode

Select the type of picture shown when you pause playback.

Automatic	Automatically selects the type of picture shown.
Field	Select if jittering occurs when "Automatic" is selected.
Frame	Select if small text or fine patterns cannot be seen clearly when "Automatic" is selected.

Seamless Play

The chapter segments in playlists are played seamlessly.

- Select "On", when the picture freezes for a moment at the chapters segment in playlists.

NTSC Contents Output

Select PAL60 or NTSC output when playing NTSC discs.

Sound

Dynamic Range Compression

You can listen at low volumes but still hear dialogue clearly. (Dolby Digital, Dolby Digital Plus and Dolby TrueHD only)

- "Auto" is effective only when playing Dolby TrueHD.

Digital Audio Output

Press [OK] to show the following settings:

Dolby D/Dolby D +/Dolby TrueHD

DTS/DTS-HD

MPEG Audio

Select the audio signal to output.

- Select "PCM", when the connected equipment cannot decode the respective audio format. This unit decodes the audio format and transmits to the connected equipment.
- Not making the proper settings may result in noise.

BD-Video Secondary Audio

Select whether to mix or not mix the primary audio and secondary audio (including the button click sound). (⇒ 27)

- If "Off" is selected, the unit outputs the primary audio only.

Digital Audio Input

Press [OK] to show the following settings:

PCM-Fix

Select the following audio signal to input.

- ARC
- DIGITAL IN
- **BTT362** HDMI Input1
- **BTT362** HDMI Input2
- “On”: PCM is available.
- “Off”: DTS, PCM and Dolby Digital are available.
Select “On” if the sound is cut off intermittently.

Downmix

Select the downmix system to enjoy multi-channel or 2-channel sound.

- Select “Surround encoded” to enjoy the surround sound.
- There is no downmix effect on the bitstream audio signal.
- The audio will be output in “Stereo” in the following cases:
 - AVCHD playback
 - Dolby TrueHD playback
 - Playback of secondary audio (including the button click sound).

High Clarity Sound

When connected to TV via the HDMI AV OUT terminal for outputting image, it produces clearer sound.

- Set to “Enable” and then set “High Clarity Sound” on the Playback menu to “On”. (⇒ 39)

Audio Delay

Synchronization between picture and sound is corrected by adjusting the delay time of the audio output.

Speaker

Refer to page 43.

Display

On-Screen Messages

Choose whether to show status messages automatically.

On-Screen Language

Choose the language for menus and on-screen messages.

Screen Saver Function

This is to prevent burn-in on the screen.

- When this is set to “On”:
 - If there is no operation for 5 minutes or more, DIRECT NAVIGATOR screen switches to HOME menu automatically.
- While playing and pausing, etc., this function is not available.
- While playing music (CD-DA or MP3), after about 5 minutes DIRECT NAVIGATOR screen switches to a blank screen with “Screen Saver” message.

Front Panel Display

Changes the brightness of the unit’s display.

- If “Automatic” is selected, the display is dimmed but brightens when you perform some operations.

Software Licence

Information about the software used by this unit is displayed.

TV / Device Connection

3D Settings

Press [OK] to show the following settings:

3D Type

Select the format of the connected TV.

- Change the settings for 3D on the TV also when “Side by side” is selected.



3D Playback Message

Set to display or hide the 3D viewing warning screen when playing back the 3D compatible video software.

TV Aspect

Set to match the type of television connected.

When connected to a 4:3 aspect television and playing 16:9 ratio image:

4:3	The sides are cut off so the picture fills the screen. When playing BD-Video, video is output as “4:3 Letterbox”.	
4:3 Letterbox	Black bands appear at the top and bottom of the picture.	

When connected to a 16:9 widescreen television and playing 4:3 ratio image:

16:9	Video is displayed as a 4:3 ratio image in the centre of the screen.
-------------	--

HDMI Connection

Press [OK] to show the following settings:

HDMI Video Format

The items supported by the connected devices are indicated on the screen as “*”. When any item without “*” is selected, the images may be distorted.

- If “Automatic” is selected, automatically selects the output resolution best suited to the connected television.
- To enjoy high-definition video up-converted to 1080p, you need to connect the unit directly to 1080p compatible HDTV (High Definition Television). If this unit is connected to an HDTV through other equipment, it must also be 1080p compatible.

24p Output

When this unit is connected to a TV supporting 1080/24p output using an HDMI cable, movies and other material recorded at 24p are output at 24p.

- When playing DVD-Video, set to “On” and then set “24p” in “Picture” (⇒ 38) to “On”
- When BD-Video images other than 24p are played, images are output at 60p.
- 24p:
A progressive image recorded at a rate of 24 frames per second (motion-picture film). Many BD-Video movie contents are recorded in 24 frames/second in accordance with the film materials.

HDMI Colour Mode

This setting is for selecting colour-space conversion of the image signal when the unit is connected using an HDMI cable.

HDMI Audio Output

This setting selects whether or not to output audio from HDMI.

- Audio will be output through the system's speakers when "Off" is selected.

BTT362

HDMI Standby Pass-Through

Even if this unit is in standby mode, a device connected with this unit can output videos and sound to the TV. Moreover, you can switch the HDMI input terminal by pressing [EXT-IN] on the remote control.

- Sound will not be output from this unit's speakers.

VIERA Link

Set to use "HDAVI Control" function when connected with an HDMI cable to a device that supports "HDAVI Control".

- Select "Off" when you do not want to use "HDAVI Control".

Deep Colour Output

This setting is for selecting whether to use Deep Colour Output when a television that supports Deep Colour is connected.

Contents Type Flag

Depending on the playback content, the TV will output adjusting to the optimal method when a TV that supports this function is connected.

Power Off Link

Select the desired power off link setting of this unit for VIERA Link operation (⇒ 33). (This works depending on the settings of the connected VIERA Link "HDAVI Control" compatible equipment.)

Video/Audio:

When the TV is turned off, this unit will turn off automatically.

Video:

When the TV is turned off, this unit will turn off except during the following conditions:

- CD or MP3 audio playback
- iPod/iPhone mode
- Radio mode
- "AUX", "ARC" or "D-IN" (DIGITAL IN) mode (non-selected TV AUDIO setting for VIERA Link)
- "D-IN" (DIGITAL IN) mode (non-selected CABLE/ SATELLITE AUDIO setting for VIERA Link)

TV Audio Input

Select the TV audio input to work with the VIERA Link operations.

TV System

Change the setting to match the equipment you are connecting with.

- When NTSC contents are played, they are outputted in the signal format specified in the "NTSC Contents Output", irrespective of the settings here.

Network

Network Easy Setting (⇒ 20)

Network Settings

Perform network-related settings individually. Press [OK] to show the following settings:

BTT362

LAN Connection Mode

Select connection method.

BTT362

Wireless Settings

This allows the Wireless router and connection settings to be set and the current connection settings and connection state to be checked when a wireless connection is used.

Connection Setting

The Wireless router connection wizard will be displayed.

Double Speed Mode Setting (2.4GHz)

When a 2.4 GHz wireless format is used, this setting sets the connection speed.

- If you connect using the "Double Speed Mode (40MHz)", two channels use the same frequency band, and there is consequently a greater risk of reception interference. This can cause the connection speed to drop or the connection to become unstable.

IP Address / DNS Settings

This is for checking the state of the network connection and setting the IP address and DNS-related.

Press [OK] to show the respective setting.

- "Connection Speed Setting" is enabled only when "Connection Speed Auto-Config" is turned "Off".

Proxy Server Settings

This is for checking the state of connection with the Proxy server and performing settings.

Press [OK] to show the respective setting.

Internet Content Settings (⇒ 36) (VIERA CAST)

Press [OK] to show the following settings:

Lock

You can restrict using VIERA CAST.

- Follow the on-screen instructions. Enter the 4-digit password with the number buttons when the password screen is shown.

Audio Auto Gain Control

Volume that is different depending on the contents is adjusted automatically to the standard volume while using the VIERA CAST.

- Depending on contents, this function effect will not work.
- Select "Off" when the audio is warped.

Time Zone

By selecting the time zone, it is possible to set the unit's time to match your location.

- Some VIERA CAST contents require the time zone to be set. Set the time zone if necessary.

Summer Time

- Select "On" when using Daylight Saving time.

MAC Address

Displays the MAC address of this unit.

Others

Remote Control

Change the remote control code if other Panasonic products react to this remote control.

Quick Start*

Speed of startup from standby mode is increased.

- Internal control unit will be powered when it is set to "On" so compared to when the setting is "Off" the following will occur.
 - Idle power consumption will increase. (More about the power consumption ⇒ 49)

*Depending on the power conserving setting activated on the TV, this function may have less effect when the unit is started by the power on link function. (⇒ 33)

Easy setup (⇒ 19)

You can execute basic settings to optimize your home theatre system.

Default Settings

This returns all values in the Setup menu and the playback menu, except for "Remote Control", "LAN Connection Mode", "Wireless Settings", "IP Address / DNS Settings", "Proxy Server Settings", "Lock", "DVD-Video Ratings" and "BD-Video Ratings" etc. to the default settings.

DivX Registration (⇒ 28)

You need this registration code to purchase and play DivX Video-on-Demand (VOD) content.

System Information

Display firmware version of this unit.

BTT362 Also display wireless LAN module.

Firmware Update (⇒ 22)

Press [OK] to show the following settings:

Automatic Update Check

When this equipment remains connected to the Internet, it will check for the latest firmware version when it is turned on and you can update it if necessary.

Update Now

You can update the firmware manually if a firmware update is available.

Speaker check

- ① Select "Test" and press [OK].
A test signal is output.
Front (L) ↔ Front (R)
- ② Press [OK].
The test signal stops.
 - No signal is output for the subwoofer. To adjust its volume, see page 24, "Adjusting speaker level during play".

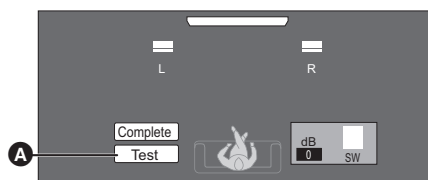

- A** Test

To finish the speaker setting

Press [▲, ▼, ◀, ▶] to select "Complete" and press [OK].

Speaker installation option

Attaching to a wall

- You can attach all of the speakers (except subwoofer) to a wall.
- The wall or pillar on which the speakers are to be attached should be capable of supporting 10 kg per screw. Consult a qualified building contractor when attaching the speakers to a wall. Improper attachment may result in damage to the wall and speakers.
 - Do not attempt to attach these speakers to walls using methods other than those described in this manual.

BTT262

Preparation

- Remove the speaker stands.
- 1 Remove the screws and the bracket (A) from the speaker.**

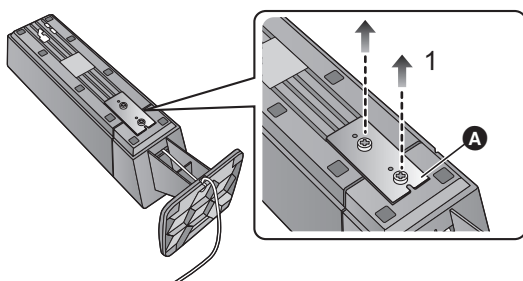

2 Detach the speaker stand.

- Remove the speaker cable from the groove (B).
- Pull out the speaker cable from the stand, making sure to match the direction of the speaker connector and the hole on the stand.

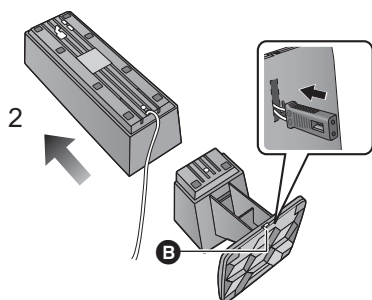

- Keep the removed stands, screws and brackets for future use.

1 Drive a screw (not supplied) into the wall.

- A** At least 30 mm
- B** \varnothing 4.0 mm
- C** \varnothing 7.0 mm to \varnothing 9.4 mm
- D** Wall or pillar
- E** 5.5 mm to 7.5 mm

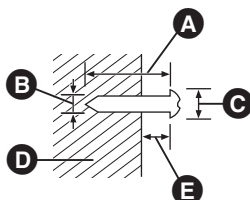

2 Fit the speaker securely onto the screw(s) with the hole(s).

e.g., BTT362 Front speaker	
DO NOT	DO
<ul style="list-style-type: none"> • In this position, the speaker will likely fall if moved to the left or right. 	<ul style="list-style-type: none"> • Move the speaker so that the screw is in this position.

Use the measurements indicated below to identify the screwing positions on the wall.

- Leave at least 20 mm of space above the speaker and 10 mm on each side to allow enough space for fitting the speaker.

Front speaker

- **BTT362** Attach to a wall without the base.

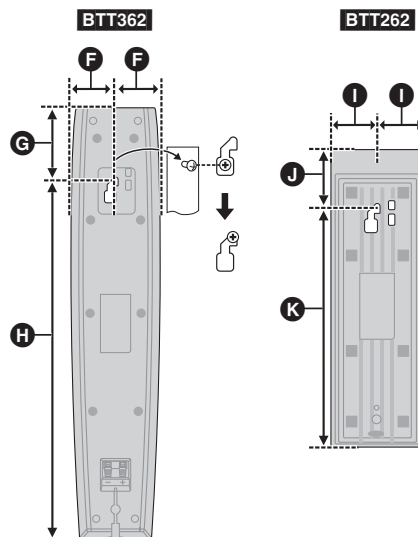

- F** 40 mm
- G** 63 mm
- H** 322 mm
- I** 37 mm
- J** 45 mm
- K** 190 mm

■ To avoid speaker dropping

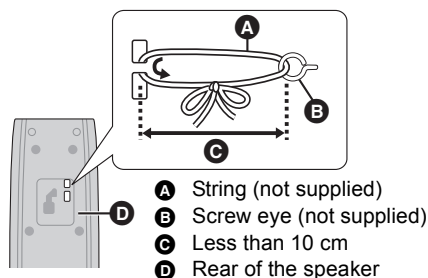

- Consult a qualified building contractor to avoid damage to the wall or speakers.
- Use a string of less than \varnothing 2.0 mm, which is capable of supporting over 10 kg.

Positioning speakers horizontally **BTT262**

1 Attach the cushion foot (supplied) (A) on the bottom of the speaker.

- If you repeat attaching and removing the cushion foot, degree of tackiness weakens.

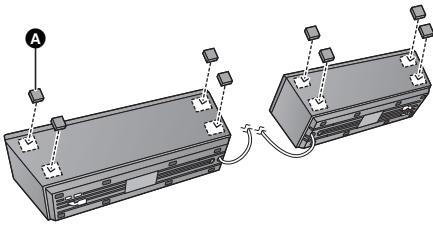

2 Place the speakers facing the inclined surface (B) toward outside.

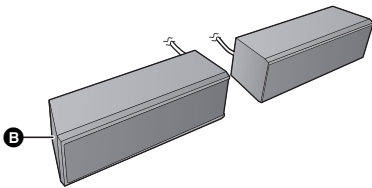

■ To attach speaker stand again

- Put the speaker cable through the speaker stand.
 - A** : top of the stand
 - Make sure to match the direction of the speaker connector and the hole (**B**) on the stand.
- Secure the cable with the speaker (**C**), and put the speaker and the stand together pulling the cable as illustrated (**D**).

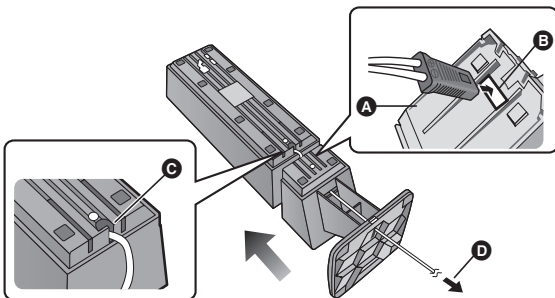

- Attach the stand referring to the detaching operation 1 and 2 (⇒ 44).

- Fix the speaker and the stand with the screws and the bracket, and then secure the speaker cable into the groove.

Troubleshooting guide

Before requesting service, please perform the following checks.

If the problem remains unresolved, consult your dealer for instructions.

Do you have the latest firmware installed?

Firmware updates may be released to correct operating irregularities that are discovered with certain movies. (⇒ 22)

The following do not indicate a problem with this unit:

- Regular disc rotating sounds.
- Image disturbance during search.
- Image disturbance when replacing 3D discs.

■ Unit doesn't respond to remote control or front panel buttons.

Press and hold [⏻/I] on the main unit for 5 seconds.

- If still unable to turn the unit off, disconnect the AC mains lead, wait 1 minute, then reconnect the AC mains lead.

■ Cannot eject disc.

The unit may have a problem.

While the unit is off, press and hold [▶▶] on the remote control and [▲ OPEN/CLOSE] on the unit at the same time for more than 5 seconds.

General operation

To return to the factory preset.

- Select "Yes" in "Default Settings" in the Setup menu. (⇒ 43)

To return all settings to the factory preset.

- Reset the unit as follows:
While the unit is off, press and hold [+ VOLUME], [▲ OPEN/CLOSE] and [⏻/I] on the main unit at the same time for more than 5 seconds.

The remote control doesn't work properly.

- Change the batteries in the remote control. (⇒ 7)
- The remote control and main unit are using different codes. If "SET □" is displayed on the unit's display when a button is pressed on the remote control, change the code on the remote control. (⇒ 43)

Disc cannot be played.

- The disc is dirty. (⇒ 7)
- Check the region code.

Still pictures (JPEG) do not playback normally.

- The images that were edited on the PC, such as Progressive JPEG, etc., may not playback.

The TV tuner mode is not displayed when the TV is switched on.

- This phenomenon may occur, depending on the TV setting, when "Quick Start" is set to "On".
- Depending on the TV, this phenomenon may be prevented by reconnecting the HDMI cable to a different HDMI input terminal or by changing the HDMI auto connection setting.

You have forgotten your ratings password.

You want to cancel the ratings level.

- The ratings level returns to the factory preset.
- ① While the unit is on, press and hold [OK], the yellow button and the blue button on the remote control at the same time for more than 5 seconds.
 - “00 RET” is displayed on the unit’s display.
- ② Repeatedly press [▶] (right) on the remote control or [⏪/I] on the unit until “03 VL” is displayed on the unit’s display.
- ③ Press [OK] on the remote control or [▲ OPEN/CLOSE] on the unit.

This unit does not recognize the USB connection correctly.

- If USB device is connected to this unit while playing a disc or in a video communication (**BTT362**) the connection will not be recognized. Press [HOME] and reconnect USB device.
- **BTT362** USB memory and USB HDD are not recognized via the rear USB port of this unit.
- Disconnect and reconnect the USB cable. If it still does not recognize the connection, turn this unit off and on again.
- USB devices connected using a USB hub may not be recognized by this unit.

BTT362

This unit does not recognize the communication camera correctly.

- Disconnect and reconnect the communication camera. If it still does not recognize the connection, turn the unit off and on again.

Power

No power.

- Insert the AC mains lead securely into a household mains socket. (⇒ 18)

The unit switches to standby mode.

- When the time set for the sleep timer has passed, the main unit will be turned off. (⇒ 8)
- One of the unit’s safety devices is activated. Press [⏪/I] on the main unit to turn the unit on.

This unit is turned off when the input for the TV is switched.

- This is a normal phenomenon when using VIERA Link (HDAVI Control 4 or later). For details please read the operating instructions for the TV.

The unit does not turn off.

- ① Press and hold [⏪/I] on the main unit for 5 seconds. (If still unable to turn the unit off, disconnect the AC mains lead, wait 1 minute, then reconnect the AC mains lead.)
- ② Reset the unit as follows:
While the unit is off, press and hold [+ VOLUME], [▲ OPEN/CLOSE] and [⏪/I] on the main unit at the same time for more than 5 seconds.

Displays

The display is dim.

- Change “Front Panel Display” in the Setup menu. (⇒ 41)

TV screen and video

The images from this unit do not appear on the TV.

Picture is distorted.

Jittering occurs.

- An incorrect resolution is selected in “HDMI Video Format”.
Reset the setting as follows:
 - ① While the unit is on, press and hold [OK], the yellow button and the blue button on the remote control at the same time for more than 5 seconds.
 - “00 RET” is displayed on the unit’s display.
 - ② Repeatedly press [▶] (right) on the remote control or [⏪/I] on the unit until “04 PRG” is displayed on the unit’s display.
 - ③ Press and hold [OK] on the remote control or [▲ OPEN/CLOSE] on the unit for at least 3 seconds.
Set the item again. (⇒ 41)
- When Dolby Digital Plus, Dolby TrueHD, and DTS-HD audio are not output in bitstream, select “Yes” in “Default Settings” and make proper settings. (⇒ 43)
- The unit and television are using different video systems.
While stopped, keep pressing [■] (Stop) and [▲ OPEN/CLOSE] on the main unit for 5 or more seconds. The system switches from PAL to NTSC or vice versa.
- The system used on the disc doesn’t match your television.
 - PAL discs cannot be correctly viewed on an NTSC television.
 - This unit can convert NTSC signals to PAL60 for viewing on a PAL television (“NTSC Contents Output” in the “Picture”).
- When “3D BD-Video Playback” in the Setup menu is set to “Automatic”, images may not be output depending on the connection method. After removing the disc from this unit, select “Set before play” in the Setup menu, and select “2D Playback” in the setup screen displayed when playing 3D discs. (⇒ 40)

When playing back a 3D disc, audio can be heard but no video image on the TV.

- Change the video input mode to the suitable HDMI video input mode on the TV.

Video is not output.

- Set “High Clarity Sound” in the playback menu to “Off” to use the VIDEO OUT terminal. (⇒ 39)

Video is not output in high-definition.

- Confirm that “HDMI Video Format” in the Setup menu is set properly. (⇒ 41)

3D video is not output.

- Are the settings on this unit and the TV correct? (⇒ 29)

3D video is not output correctly as 2D.

- Select “Set before play” in the Setup menu, and select “2D Playback” in the setup screen displayed when playing 3D discs.
- Discs that have recorded titles with Side by side (2 screen structure) and that can be enjoyed in 3D are played back in accordance with the settings of the TV.

A black band is displayed around the edge of the screen. The aspect ratio of the screen is abnormal.

- Confirm the “TV Aspect” is set properly. (⇒ 41)
- Adjust the aspect setting on the television.

After choosing “Home Cinema” in “Speaker Selection” with the TV’s remote control, the TV’s input selection also changes.

- Disconnect the HDMI cable from the TV and reconnect it to a different HDMI IN terminal.

Sound

No sound.

Low volume.

Distorted sound.

Cannot hear the desired audio type.

- Check connections to speakers and other equipment. (⇒ 12–18)
- Ensure the speaker settings for your speakers are correct. (⇒ 43)
- To output audio from a device connected with an HDMI cable, set “HDMI Audio Output” to “On” in the Setup menu. (⇒ 42)
- When “BD-Video Secondary Audio” is set to “On”, Dolby TrueHD, Dolby Digital Plus, DTS-HD Master Audio and DTS-HD High Resolution Audio are output as Dolby Digital or DTS Digital Surround.
- Re-master will not work when the bitstream signal is output from the HDMI AV OUT terminal. (⇒ 39)
- Depending on the connected equipment, the sound may be distorted if this unit is connected with an HDMI cable.

No surround sound effect.

- Press [SURROUND] to select a surround effect. (⇒ 24)

Cannot switch audio.

- When audio is output from the HDMI AV OUT terminal, set “Dolby D/Dolby D +/Dolby TrueHD”, “DTS/DTS-HD” or “MPEG Audio” to “PCM”. (⇒ 40)

No sound from the TV.

- Press [EXT-IN] to select the corresponding source. (⇒ 22)
- When connecting the unit to a TV using an HDMI cable, check whether the HDMI terminal on the TV is labeled “HDMI (ARC)”. If not labeled in this way, connect using the HDMI cable in combination with an optical digital audio cable. (⇒ 14, 15)
- If there is no sound from the equipment connected to this unit’s DIGITAL AUDIO IN terminal, please make sure that the optical audio output of the equipment is set to PCM.

iPod/iPhone operation

Cannot charge or operate.

- Check that the iPod/iPhone is connected firmly. (⇒ 34)
- The battery of the iPod/iPhone is depleted. Charge the iPod/iPhone, and then operate again.
- When unexpected operation occurs while using the iPod/iPhone, connect the iPod/iPhone again or try to restart the iPod/iPhone.

Cannot display iPod/iPhone videos/photos on the TV.

- Make sure that TV is connected to the VIDEO OUT terminal on this unit. (⇒ 14)
- Operate the iPod/iPhone menu to make the appropriate video/photo output settings for your TV. (Refer to operating instructions for your iPod/iPhone.)

The TV input channel unintentionally changes to HDMI input.

- When the main unit is connected with an “HDMI Control” compatible TV and VIDEO IN is selected for iPod/iPhone video or photo playback, the TV input channel will automatically change to the HDMI input channel when [HOME] is pressed.
 - Re-select the TV’s VIDEO IN input channel.

Radio

Distorted sound or noise is heard.

- Adjust the position of the antenna.
- Use an outdoor antenna. (⇒ 18)

A beat sound is heard.

- Try to keep a certain amount of distance between the antenna and the TV.

Network

I can’t connect to the network.

- Confirm the network connection and settings. (⇒ 17, 20, 42)
- Check the operating instructions for each device and connect accordingly.

ETT362

When using Wireless LAN connection, video or audio from the DLNA Certified media server is played back intermittently, not played back or video frames are dropped during playback.

- Higher transfer rate router such as 802.11n (2.4 GHz or 5 GHz) Wireless router may solve the problem. If you use 802.11n (2.4 GHz or 5 GHz) Wireless router, it is necessary to set the encryption type to “AES”. Simultaneous use with a microwave, cordless telephone etc. at 2.4 GHz may result in connection interruptions or other problems.
- On the “Wireless Settings” screen (⇒ 42), the continuous lighting of at least 4 “Reception” indicators is the target for a stable connection. If 3 or fewer indicators are lit or the connection is being interrupted, change the position or angle of your Wireless router and see if the connection state improves. If there is no improvement, connect to a wired network and perform the “Network Easy Setting” (⇒ 20) again.

Other difficulties with playback

BD-Video or DVD-Video is not played.

- Ensure the disc is for the correct BD-Video region code or DVD-Video region number, and is not defective. (⇒ 11)
- You have set a ratings level to limit BD-Video or DVD-Video play. Change this setting. (⇒ 40)
- Some BD-Video can only be output with HDMI.

I can’t play back BD-Live.

- The SD card is write-protected. (⇒ 11)
- Confirm that this unit is connected to the broadband Internet. (⇒ 17)
- Confirm the “BD-Live Internet Access” settings. (⇒ 40)
- Confirm an SD Card is inserted into the SD Card slot. (⇒ 22)

Alternative soundtrack and subtitles cannot be selected.

- The languages are not recorded on the disc.
- You may not be able to use the playback menu to change the soundtrack and subtitles on some discs. Use the disc’s menus to make changes. (⇒ 25)

Angle cannot be changed.

- Angles can only be changed during scenes where different angles are recorded.

Messages

The following messages or service numbers appear on the television or unit's display when something unusual is detected during startup and use.

On the television

Cannot play.

- You inserted an incompatible disc.

Cannot play on this unit.

- You tried to play a non-compatible image.

No disc inserted.

- The disc may be upside down.

⊘ This operation is not available.

- Some operations are unsupported by the unit. For example;
 - BD-Video: During playback, reverse slow-motion or reverse frame-by-frame is not possible.

IP address is not set.

- The "IP Address" in "IP Address / DNS Settings" is "----. ---. ---. ---". Set the "IP Address", "Subnet Mask", and "Gateway Address". (Select the automatic address acquisition if necessary.)

E11362

The wireless access point currently has a low network security setting. It is recommended to change to a higher setting.

- Authentication type for the Wireless LAN is set to "Open system", or the encryption type is set to "No encryption". It is recommended to encrypt for safety reasons. For details, refer to the instructions of the Wireless router being used. Encryption is required when playing back video, etc., from DLNA compatible devices.

No Video

- Depending on the connected iPod/iPhone, video menu may not be available on the TV. Select "ALL" on the unit's display and operate video playback from your iPod/iPhone menu. (⇒ 35)

On the unit's display

F99

- The unit fails to operate properly. Press [⏻] on the main unit to switch the unit to standby for 3 seconds. Now press [⏻] on the main unit again to turn the unit on.

U59

- The unit is hot.
The unit switches to standby for safety reasons. Wait for about 30 minutes until the message disappears. Select a position with good ventilation when installing the unit. Do not block the ventilation hole on the rear and side of the unit.

HDMI ONLY

- Some BD-Video discs can only be output with HDMI.

NET

- While connecting to a network.

No PLAY

- There is a viewing restriction on a BD-Video or DVD-Video. (⇒ 40)

No READ

- The media is dirty or badly scratched. The unit cannot play.

PLEASE WAIT

- The unit is carrying out internal process. This is not a malfunction. You cannot operate the unit while "PLEASE WAIT" is displayed.

REMOVE

- The USB device is drawing too much power. Remove the USB device.

SET □

("□" stands for a number.)

- The remote control and main unit are using different codes. Change the code on the remote control.

Press and hold [OK] and the indicated number button at the same time for more than 5 seconds.



H□□ or F□□

("□" stands for a number.)

- Check and correct the speaker cable connections.
- There is something unusual.
- Check the unit using the troubleshooting guide. If the service number does not disappear, do the following.
 - ① Disconnect the plug from the household mains socket, wait a few seconds, then reconnect it.
 - ② Press [⏻] to turn the unit on.
If the service number does not disappear despite doing the above, request service from the dealer. Inform the dealer of the service number when requesting service.

UPD□/□

("□" stands for a number.)

- The firmware is being updated.
Please do not turn off the unit.

IPOD OVER CURRENT ERROR

- The iPod/iPhone is drawing too much power. Remove the iPod/iPhone, and turn the unit off and on again.

START

- The system is being restarted during the firmware update.
Please do not turn off the unit

FINISH

- The firmware update is completed.

NOT CONDITIONAL

- The requested operation cannot be conducted.

Specifications

GENERAL

Power consumption:	85 W
Power consumption in standby mode:	BTT362 Approx. 0.1 W BTT262 Approx. 0.4 W
Power supply:	AC 220 V to 240 V, 50 Hz
iPod/iPhone Connector:	DC OUT 5 V 1.0 A MAX
Dimensions (W×H×D):	430 mm×38 mm×279 mm
Mass:	Approx. 2.7 kg (Dimensions and Weight do not include speakers)
Operating temperature range:	0 °C to 40 °C
Operating humidity range:	35 % to 80 % RH (no condensation)

AMPLIFIER SECTION

RMS TTL POWER OUTPUT:	520 W
1 kHz, 10 % total harmonic distortion	
FRONT:	160 W per ch (3 Ω)
100 Hz, 10 % total harmonic distortion	
SUBWOOFER:	200 W per ch (3 Ω)

FM TUNER SECTION

Frequency range:	87.50 MHz to 108.00 MHz (50 kHz step)
Antenna terminal:	75 Ω (unbalanced)

SPEAKER SECTION

Front speakers

BTT362 SB-HF370

Type:	2 WAY 2 SPEAKER Bass-ref.
Woofers:	6.5 cm CONE TYPE
Tweeter:	2.5 cm SEMI-DOME TYPE
Impedance:	3 Ω
Output sound pressure:	78 dB/W (1 m)
Frequency range:	85 Hz to 25 kHz (−16 dB), 105 Hz to 24 kHz (−10 dB)
Dimensions (W×H×D):	135 mm×404 mm×135 mm
Mass:	Approx. 0.82 kg

BTT262 SB-HF262

Type:	1 WAY 1 SPEAKER Bass-ref.
Full range:	6.5 cm CONE TYPE
Impedance:	3 Ω
Output sound pressure:	78 dB/W (1 m)
Frequency range:	95 Hz to 25 kHz (−16 dB), 115 Hz to 22 kHz (−10 dB)
Dimensions (W×H×D):	109 mm×341 mm×110 mm
Mass:	Approx. 0.735 kg

Subwoofer

BTT362 SB-HW370

Type:	1 WAY 1 SPEAKER Bass-ref.
Woofers:	16 cm CONE TYPE
Impedance:	3 Ω
Output sound pressure:	78 dB/W (1 m)
Frequency range:	30 Hz to 220 Hz (−16 dB), 35 Hz to 180 Hz (−10 dB)
Dimensions (W×H×D):	180 mm×408 mm×300 mm
Mass:	Approx. 4.3 kg

BTT262 SB-HW270

Type:	1 WAY 1 SPEAKER Bass-ref.
Woofers:	16 cm CONE TYPE
Impedance:	3 Ω
Output sound pressure:	78 dB/W (1 m)
Frequency range:	40 Hz to 220 Hz (−16 dB), 45 Hz to 180 Hz (−10 dB)
Dimensions (W×H×D):	145 mm×289.5 mm×258 mm
Mass:	Approx. 3.0 kg

TERMINAL SECTION

USB:

(Front)

USB standard:	USB 2.0 1 system
USB slot:	DC OUT 5 V 500 mA MAX

(Rear)

BTT362

USB slot for Communication	USB 2.0 1 system
Camera:	DC OUT 5 V 500 mA

SD card slot:

Ethernet:

Connector:	1 system
10BASE-T/100BASE-TX	1 system

BTT362 WLAN

Antenna:

Tx 1, Rx 2

Standard Compliance: IEEE802.11n / IEEE802.11a / IEEE802.11g / IEEE802.11b

Transmission system: MISO-OFDM system, OFDM system, DSSS system

Transfer rate (Standard)*:

IEEE802.11n:	Tx Max. 150 Mbps, Rx Max. 300 Mbps
---------------------	------------------------------------

IEEE802.11g /

IEEE802.11a: Max. 54 Mbps

IEEE802.11b: Max. 11 Mbps

Access Mode:

Infrastructure mode

Security:

WPA2-PSK (TKIP/AES)

WPA-PSK (TKIP/AES)

WEP (64 bit / 128 bit)

(This unit supports WPA and WPA2 encryption.)

Audio Input

AUX:

× 1

Digital Audio Input

Optical:

× 1

BTT362

HDMI AV input:

× 2

Sampling frequency:

32 kHz, 44.1 kHz, 48 kHz

Audio Format:

PCM, Dolby Digital, DTS

* Transfer rates are theoretical values; however, actual communication rate will vary according to communication environment or connected equipment.

VIDEO SECTION

Signal system:	PAL/NTSC
Video output	
Output level:	1.0 Vp-p (75 Ω)
Output connector:	Pin jack (1 system)
HDMI AV output*	
Output connector:	Type A (19 pin)
BTT362	
HDMI AV input*	
Input connector:	Type A (19 pin) 2 system
LASER Specification	
Class 1 LASER Product	
Wave length:	790 nm (CDs)/655 nm (DVDs)/ 405 nm (BDs)
Laser power:	No hazardous radiation is emitted with the safety protection

* This unit supports "HDAVI Control 5" function.

Specifications are subject to change without notice.

File format

File format	Extension	Reference
MP3	“.MP3”, “.mp3”	ID3 tags (Only titles and the names of artists)
JPEG	“.JPG”, “.jpg”	<ul style="list-style-type: none"> MOTION JPEG and Progressive JPEG is not supported. You may not be able to play back the file if you have edited the folder structure or the file name on a PC or other device.
DivX	“.DIVX”, “.divx”, “.AVI”, “.avi”	<ul style="list-style-type: none"> The video file and subtitles text file are inside the same folder, and the file names are the same except for the file extensions. Some DivX and MKV file may not be played back, depending on the video resolution and frame rate condition.
	Subtitles text file “.SRT”, “.srt”, “.SUB”, “.sub”, “.TXT”, “.txt”	
MKV	“.MKV”, “.mkv”	
	Subtitles text file “.SRT”, “.srt”, “.SSA”, “.ssa”, “.ASS”, “.ass”	

• With certain recording states and folder structures, the play order may differ or playback may not be possible.

Supplemental information

■ Display languages list

Display	Language	Display	Language	Display	Language
ENG	English	JPN	Japanese	ARA	Arabic
FRA	French	CHI	Chinese	HIN	Hindi
DEU	German	KOR	Korean	PER	Persian
ITA	Italian	MAL	Malay	IND	Indonesian
ESP	Spanish	VIE	Vietnamese	MRI	Maori
NLD	Dutch	THA	Thai	BUL	Bulgarian
SVE	Swedish	POL	Polish	RUM	Romanian
NOR	Norwegian	CES	Czech	GRE	Greek
DAN	Danish	SLK	Slovak	TUR	Turkish
POR	Portuguese	HUN	Hungarian	*	Others
RUS	Russian	FIN	Finnish		

■ Language code list

Language	Code	Language	Code	Language	Code
Abkhazian	6566	Gujarati:	7185	Rhaeto-Romance:	
Afar:	6565	Hausa:	7265	Romanian:	8279
Afrikaans:	6570	Hebrew:	7387	Russian:	8285
Albanian:	8381	Hindi:	7273	Samoan:	8377
Amharic:	6577	Hungarian:	7285	Sanskrit:	8365
Arabic:	6582	Icelandic:	7383	Scots Gaelic:	7168
Armenian:	7289	Indonesian:	7378	Serbian:	8382
Assamese:	6583	Interlingua:	7365	Serbo-Croatian:	8372
Aymara:	6589	Irish:	7165	Shona:	8378
Azerbaijani:	6590	Italian:	7384	Sindhi:	8368
Bashkir:	6665	Japanese:	7465	Singhalese:	8373
Basque:	6985	Javanese:	7487	Slovak:	8375
Bengali:	Bangla:	Kannada:	7578	Slovenian:	8376
	6678	Kashmiri:	7583	Somali:	8379
Bhutani:	6890	Kazakh:	7575	Spanish:	6983
Bihari:	6672	Kirghiz:	7589	Sundanese:	8385
Breton:	6682	Korean:	7579	Swahili:	8387
Bulgarian:	6671	Kurdish:	7585	Swedish:	8386
Burmese:	7789	Laotian:	7679	Tagalog:	8476
Byelorussian:	6669	Latin:	7665	Tajik:	8471
Cambodian:	7577	Latvian, Lettish:	7686	Tamil:	8465
Catalan:	6765	Lingala:	7678	Tatar:	8484
Chinese:	9072	Lithuanian:	7684	Telugu:	8469
Corsican:	6779	Macedonian:	7775	Thai:	8472
Croatian:	7282	Malagasy:	7771	Tibetan:	6679
Czech:	6783	Malay:	7783	Tigrinya:	8473
Danish:	6865	Malayalam:	7776	Tonga:	8479
Dutch:	7876	Maltese:	7784	Turkish:	8482
English:	6978	Maori:	7773	Turkmen:	8475
Esperanto:	6979	Marathi:	7782	Tw:	8487
Estonian:	6984	Moldavian:	7779	Ukrainian:	8575
Faroese:	7079	Mongolian:	7778	Urdu:	8582
Fiji:	7074	Nauru:	7865	Uzbek:	8590
Finnish:	7073	Nepali:	7869	Vietnamese:	8673
French:	7082	Norwegian:	7879	Volapük:	8679
Frisian:	7089	Oriya:	7982	Welsh:	6789
Galician:	7176	Pashto, Pushto:	8083	Wolof:	8779
Georgian:	7565	Persian:	7065	Xhosa:	8872
German:	6869	Polish:	8076	Yiddish:	7473
Greek:	6976	Portuguese:	8084	Yoruba:	8979
Greenlandic:	7576	Punjabi:	8065	Zulu:	9085
Guarani:	7178	Quechua:	8185		

Index

A	Audio		R	Radio	31
	Changing audio during play	26		Re-master	39
	Language	38, 40		Resume play function	25
B	BD-Live	27	S	Subtitle	38
C	Chapter	26	V	VIERA CAST	36
D	Default Settings	43		VIERA Link "HDMI Control™"	32
DivX	28		W	Wireless LAN	17
DLNA	37				
F	File format	50			
Firmware update	22				
				24p	38, 41
				3D	29
I	iPod/iPhone	34			
L	LAN	17			
	Language				
	Audio	38, 40			
	Menu	40			
	On-Screen	41			
	Soundtrack	38			
	Subtitle	38, 40			
N	Network				
	Connection	17			
	Setting	20, 42			
P	Playlists	26			
	Pop-up menu	25			
Q	Quick Start	43			

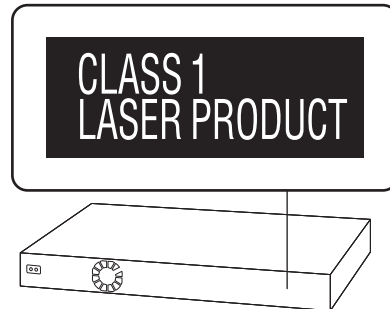

(Back of product)

CAUTION	— VISIBLE AND INVISIBLE LASER RADIATION WHEN OPEN. DO NOT STARE INTO BEAM. FDA 21 CFR Class II (IIa)
CAUTION	— CLASS 1M VISIBLE AND INVISIBLE LASER RADIATION WHEN OPEN. DO NOT VIEW DIRECTLY WITH OPTICAL INSTRUMENTS. IEC60825-1:02 CLASS 1M
ATTENTION	— RAYONNEMENT LASER VISIBLE ET INVISIBLE, CLASSE 1M. EN CAS D'OUVERTURE, NE PAS REGARDER DIRECTEMENT À L'AIDE D'INSTRUMENTS D'OPTIQUE.
FORSIGTIG	— SYNLIG OG USYNLIG LASERSTRÅLING KLASSE 1M, NÅR LÅGET ER ÅBENT, UNDGÅ AT SE LIGE PÅ MED OPTISKE INSTRUMENTER.
VARO	— AVAATTAESSA OLET ALTTIINA LUOKAN 1M NÄKYVÄÄ JA NÄKYMÄTÖNTÄ LASERSÄTELYÄ. ÄLÄ KATSO OPTISELLÄ LAITTEELLA SUORAAN SÄTEESEEN.
WARNING	— CLASS 1M SYNLIIG OCH OSYNLIIG LASERSTRÅLING NÅR DENNA DEL ÄR ÖPPNAD. BETRÄKTA EJ STRÅLEN DIREKT GENOM OPTISKT INSTRUMENT.
VORSICHT	— SICHTBARE UND UNSICHTBARE LASERSTRALUNG KLASSE 1M, WENN ABBECKUNG GEÖFFNET. NICHT DIREKT MIT OPTISCHEN INSTRUMENTEN BETRACHTEN.
注意	— 打开时有可见及不可见激光辐射。避免光束照射。
注意	— ここを開くと可能及び不可視レーザー光が出ます。ビームを見たり、触れたりしないでください。 VQL1V70

(Inside of product)

Sales and Support Information

Customer Care Centre

- For customers within the UK: 0844 844 3852
- For customers within Ireland: 01 289 8333
- Visit our website for product information
www.panasonic.co.uk
- E-mail: customer.care@panasonic.co.uk

Direct Sales at Panasonic UK

- For customers: 0844 844 3856
- Order accessory and consumable items for your product with ease and confidence by phoning our Customer Care Centre Monday–Thursday 9:00 a.m.–5:30 p.m., Friday 9:30 a.m.–5:30 p.m. (Excluding public holidays).
- Or go on line through our Internet Accessory ordering application at www.pas-europe.com
- Most major credit and debit cards accepted.
- All enquiries transactions and distribution facilities are provided directly by Panasonic UK Ltd.
- It couldn't be simpler!
- Also available through our Internet is direct shopping for a wide range of finished products, take a browse on our website for further details.

Pursuant to at the directive 2004/108/EC, article 9(2)
Panasonic Testing Centre
Panasonic Marketing Europe GmbH
Winsbergring 15, 22525 Hamburg, Germany



Panasonic Corporation
Web Site: <http://panasonic.net>

