

Panasonic®

Operating Instructions Digital Camera



Model No. **DMC-TZ5/DMC-TZ15**
DMC-TZ4/DMC-TZ11



Before use, please read these instructions completely.
This manual is based on the DMC-TZ5 model.
Product illustrations and screens may vary.



QuickTime and the QuickTime logo are trademarks or registered trademarks of Apple Inc., used under license therefrom.

Dear Customer,

We would like to take this opportunity to thank you for purchasing this Panasonic Digital Camera. Please read these Operating Instructions carefully and keep them handy for future reference.

Information for Your Safety

WARNING:

TO REDUCE THE RISK OF FIRE, ELECTRIC SHOCK OR PRODUCT DAMAGE,

- DO NOT EXPOSE THIS APPARATUS TO RAIN, MOISTURE, DRIPPING OR SPLASHING AND THAT NO OBJECTS FILLED WITH LIQUIDS, SUCH AS VASES, SHALL BE PLACED ON THE APPARATUS.
- USE ONLY THE RECOMMENDED ACCESSORIES.
- DO NOT REMOVE THE COVER (OR BACK); THERE ARE NO USER SERVICEABLE PARTS INSIDE. REFER SERVICING TO QUALIFIED SERVICE PERSONNEL.

Carefully observe copyright laws.

Recording of pre-recorded tapes or discs or other published or broadcast material for purposes other than your own private use may infringe copyright laws. Even for the purpose of private use, recording of certain material may be restricted.

THE SOCKET OUTLET SHALL BE INSTALLED NEAR THE EQUIPMENT AND SHALL BE EASILY ACCESSIBLE.

CAUTION

Danger of explosion if battery is incorrectly replaced. Replace only with the same or equivalent type recommended by the manufacturer. Dispose of used batteries according to the manufacturer's instructions.

- Do not heat or expose to flame.
- Do not leave the battery in an automobile exposed to direct sunlight for a long period of time with doors and windows closed.

Warning

Risk of fire, explosion and burns. Do not disassemble, heat above 60 °C or incinerate.

Product Identification Marking is located on the bottom of units.

About the battery charger

CAUTION!

- DO NOT INSTALL OR PLACE THIS UNIT IN A BOOKCASE, BUILT-IN CABINET OR IN ANOTHER CONFINED SPACE. ENSURE THE UNIT IS WELL VENTILATED. TO PREVENT RISK OF ELECTRIC SHOCK OR FIRE HAZARD DUE TO OVERHEATING, ENSURE THAT CURTAINS AND ANY OTHER MATERIALS DO NOT OBSTRUCT THE VENTILATION VENTS.
- DO NOT OBSTRUCT THE UNIT'S VENTILATION OPENINGS WITH NEWSPAPERS, TABLECLOTHS, CURTAINS, AND SIMILAR ITEMS.
- DO NOT PLACE SOURCES OF NAKED FLAMES, SUCH AS LIGHTED CANDLES, ON THE UNIT.
- DISPOSE OF BATTERIES IN AN ENVIRONMENTALLY FRIENDLY MANNER.

How to replace the fuse

The location of the fuse differ according to the type of AC cable (figures A and B). Confirm the AC cable fitted and follow the instructions below. Illustrations may differ from actual AC cable.

1. Open the fuse cover with a screwdriver.

Figure A

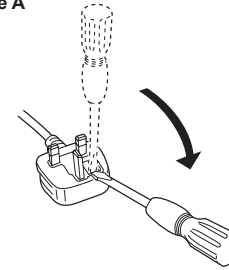
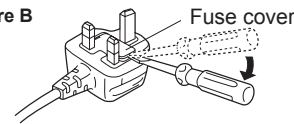

Figure B



2. Replace the fuse and close or attach the fuse cover.

Figure A

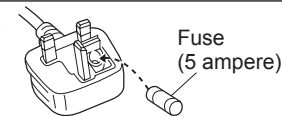
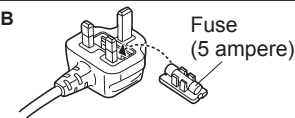

Figure B



● SDHC Logo is a trademark.

● Other names, company names, and product names printed in these instructions are trademarks or registered trademarks of the companies concerned.

Information on Disposal for Users of Waste Electrical & Electronic Equipment (private households)



This symbol on the products and/or accompanying documents means that used electrical and electronic products should not be mixed with general household waste. For proper treatment, recovery and recycling, please take these products to designated collection points, where they will be accepted on a free of charge basis. Alternatively, in some countries you may be able to return your products to your local retailer upon the purchase of an equivalent new product. Disposing of this product correctly will help to save valuable resources and prevent any potential negative effects on human health and the environment which could otherwise arise from inappropriate waste handling. Please contact your local authority for further details of your nearest

designated collection point. Penalties may be applicable for incorrect disposal of this waste, in accordance with national legislation.

For business users in the European Union

If you wish to discard electrical and electronic equipment, please contact your dealer or supplier for further information.

Information on Disposal in other Countries outside the European Union

This symbol is only valid in the European Union. If you wish to discard this product, please contact your local authorities or dealer and ask for the correct method of disposal.

Note

Example screens displayed in this manual are for DMC-TZ5 model.

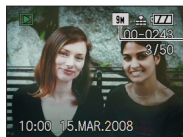

DMC-TZ4/DMC-TZ11: **8M**

Quick start guide

The battery is not charged when the camera is shipped. Charge the battery and set the clock before use.

When you do not use the card (optional), you can record or play back pictures on the built-in memory (P.18).

1

Charge the battery

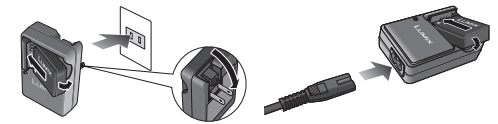

2

Insert the battery and the card

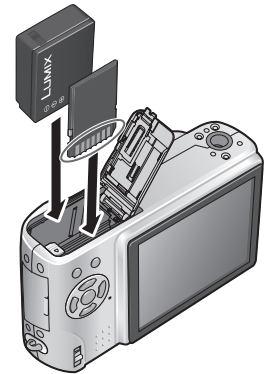

3

Turn on the power

4

Set REC/PLAY switch to 



5

Set the mode dial to 





6

Press the shutter button and take pictures

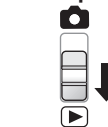

To play back the pictures



1. Set REC/PLAY switch to .
2. Select the picture you want to view.



Previous Next

Record, view, save those precious moments.

Record (P.28)

Automatically reads the scene to take crisper pictures!

INTELLIGENT AUTO **iA**

- Make ideal settings for the subject and distance just by pointing the camera!

Zoomed-in pictures

- Close-up pictures of people at a distance
'10x optical zoom'
Rapid zoom 'EASY ZOOM' (P.33)

Motion pictures

- Capture moving scenes
'MOTION PICTURE Mode'*1 (P.52)



Cards may be inserted directly into devices with SD memory card slots.

- SD memory card/
SDHC memory card *2
(optional)

View

(Playback) on large screen (P.86)



Enjoy crisp pictures on large screens!

- AV cable (supplied)
 - Component cable (optional)
- Enjoy videos in HD*3 on TV with component terminals (1080i) by using a component cable.

Print

at home, or at a digital photo centre (P.78, 83)



With your printer*4

Connect directly to easily print pictures at home. Use a PictBridge-compatible printer.

- USB connection cable (supplied)

At digital photo centre

Give card to shop assistant to print pictures.

Save and enjoy your pictures!



Using your PC*4

Send by e-mail, save to hard disk. Print out pictures.

- USB connection cable (supplied)



With DVD recorder*4

Save to DVD or hard disk

- AV cable (supplied)

*1 Sounds of zoom and other operations may be recorded.
*2 Can be used on SDHC memory card-compatible devices.
*3 DMC-TZ5/DMC-TZ15 only
*4 See respective products' instruction manuals for details.

INDEX

Before use

- Before use** 12
 - Read first/
To prevent damage and faults
- Standard Accessories** 13
- Names of parts** 14
 - Mode dial 15
 - Cursor button 15

Preparations

- 1** **Charging battery** 16
- 2** **Inserting battery and card**... 17
 - Picture save destination
(cards and built-in memory)... 18
 - Remaining battery and
memory capacity 18
- 3** **Setting the clock** 19
- 4** **Using menus** 20
 - Menu type 21
- 5** **Using SETUP menu** 22
 - CLOCK SET 22
 - WORLD TIME
 - MONITOR
 - LCD MODE
 - BEEP 23
 - VOLUME
 - GUIDE LINE
 - HISTOGRAM
 - TRAVEL DATE
 - ECOECONOMY 24
 - AUTO REVIEW
 - ZOOM RESUME 25
 - NO.RESET
 - RESET
 - USB MODE
 - VIDEO OUT 26
 - TV ASPECT
 - m/ft
 - SCENE MENU
 - DIAL DISPLAY
 - FORMAT 27
 - LANGUAGE
 - DEMO/DEMO MODE

Basics (Record • View)

- 1** **Taking picture with automatic settings** 28
- 2** **Taking pictures with your own settings** 30
 - Align focus for desired
composition 31
- 3** **Taking pictures with zoom**... 32
 - Enlarging further
'DIGITAL ZOOM' 34
- 4** **Viewing your pictures (Play)** 35
- 5** **Deleting pictures** 36
 - To delete multiple (up to 50)
or all pictures 36

Applications (Record)

- 1** **Changing recording information display** 37
- 2** **Taking pictures with flash**... 38
- 3** **Taking close-up pictures** ... 40
 - Taking close-up pictures
without standing close to
subject 'TELE MACRO
function' 40
- 4** **Positioning camera and subject within accessible range for focus alignment**... 41
- 5** **Taking pictures with self-timer** 42
- 6** **Taking pictures with exposure compensation** ... 43
 - EXPOSURE 43
 - AUTO BRACKET 43
- 7** **Taking pictures according to the scene 'SCENE MODE'** 44
 - Scene types 45
 - PORTRAIT/SOFT SKIN/
SELF PORTRAIT/SCENERY/
SPORTS..... 46
 - NIGHT PORTRAIT/
NIGHT SCENERY/FOOD/
PARTY/CANDLE LIGHT ... 47
 - BABY/ PET/SUNSET 48
 - HIGH SENS./
HI-SPEED BURST 49
 - STARRY SKY/FIREWORKS/
BEACH/SNOW 50
 - AERIAL PHOTO/
UNDERWATER/MULTI ASPECT
(DMC-TZ5/DMC-TZ15 Only)... 51

INDEX (Continued)

Applications (Record) (Continued)

- 8** Taking motion pictures 'MOTION PICTURE' 52
- 9** **Useful features for travel** 53
 - TRAVEL DATE (Record travel date and destination) 53
 - WORLD TIME
(Registering local time at your overseas destination) 54
- 10** **Using REC menu** 55
 - PICTURE SIZE 55
 - QUALITY 55
 - ASPECT RATIO 56
 - INTELLIGENT ISO 56
 - SENSITIVITY 57
 - WHITE BALANCE 58
 - METERING MODE 59
 - AF MODE 59
 - CONTINUOUS AF 60
 - BURST 61
 - I.EXPOSURE 61
 - DIGITAL ZOOM 62
 - COLOR MODE 62
 - STABILIZER 62
 - MIN. SHTR SPEED 63
 - AUDIO REC. 63
 - AF* AF ASSIST LAMP 63
 - CLOCK SET 63
- 11** Taking/viewing clipboard pictures (CLIPBOARD) 64
 - Viewing clipboard pictures 64
 - Zoom mark 65
 - CLIPBOARD menu 65
- 12** **Quick setting** 66

Applications (View)

- 1** **Viewing as list**
(Multi playback/Calendar playback) 67
- 2** **Viewing motion pictures · pictures with audio / Creating still pictures from motion pictures**
(DMC-TZ5/DMC-TZ15 only) 68
- 3** **Different playback methods**... 69
 - NORMAL PLAY 69
 - DUAL PLAY
(DMC-TZ5/DMC-TZ15 Only) ... 69
 - SLIDE SHOW 70
 - CATEGORY PLAY 71
 - FAVORITE PLAY 71
- 4** **Using PLAYBACK menu** ... 72
 - CALENDAR 72
 - TITLE EDIT 72
 - Text input method 72
 - TEXT STAMP 73
 - RESIZE 74
 - TRIMMING 75
 - ASPECT CONV. 76
 - ROTATE 76
 - ROTATE DISP. 76
 - FAVORITE 77
 - DPOF PRINT 78
 - PROTECT 79
 - AUDIO DUB. 79
 - COPY 80

Connecting with other devices

- 1** **Using with your PC**..... 81
- 2** **Printing** 83
 - Printing multiple pictures ... 84
 - Print with date and text 84
 - Making print settings on camera ... 85
- 3** **Viewing on TV screen** 86
 - View on TV with component terminal 87

Others

- 1** **List of LCD monitor displays** ... 88
- 2** **Message displays** 90
- 3** **Q&A Troubleshooting** 92
- 4** **Usage cautions and notes**... 98
- 5** **Recording picture/time capacity** 100
- 6** **Specifications** 102

Before use

Read first

■ Do a test shot first!

Check first to see if you can take pictures and record sounds (motion pictures/pictures with audio) successfully.

■ We will not compensate for failed/lost recording or for direct/indirect damage.

Panasonic will not provide compensation even if damage is caused by faults with camera or card.

■ Certain pictures cannot be played back

- Pictures edited on a computer
- Pictures taken or edited on a different camera
(Pictures taken or edited on this camera may also not be able to be played back on other cameras)

■ Software on the CD-ROM supplied

- The following actions are prohibited:
- Making duplicates (copying) for sale or rent
 - Copying onto networks

To prevent damage and faults

■ Avoid shocks, vibration, and pressure

- Avoid exposing the camera to strong vibration or shock; e.g. dropping or hitting the camera, or sitting down with the camera in your pocket.
(Attach strap to avoid dropping camera)
- Do not press the lens or the LCD monitor.

■ Do not get the camera wet or insert foreign objects

- Do not expose the camera to water, rain, or seawater.
(If camera gets wet, wipe with a soft, dry cloth. Wring cloth thoroughly first if wet with seawater, etc.)
- Avoid exposing lens and socket to dust or sand, and do not allow liquids to leak into gaps around buttons.

■ Avoid condensation caused by sudden changes in temperature and humidity

- When moving between places of different temperature or humidity, place camera into a plastic bag and allow to adjust to conditions before use.
- If the lens clouds up, switch off the power and leave for about two hours to allow camera to adjust to conditions.
- If the LCD monitor clouds up, wipe with a soft, dry cloth.

LCD monitor characteristics

Extremely high precision technology is employed to produce the LCD monitor screen. However there may be some dark or bright spots (red, blue or green) on the screen. This is not a malfunction. The LCD monitor screen has more than 99.99% effective pixels with a mere 0.01% of the pixels inactive or always lit. The spots will not be recorded on pictures on the built-in memory or a card.

Unit temperature

The camera may become warm during use. (Especially grip area, etc.)

This does not cause a problem with the performance or quality of the camera.



Grip area

■ Lens

- If lens is dirty:
Images may appear slightly white if lens is dirty (fingerprints, etc.).
Turn the power on, hold the extracted lens barrel with your fingers, and gently wipe the lens surface with a soft, dry cloth.
- Do not leave in direct sunlight.

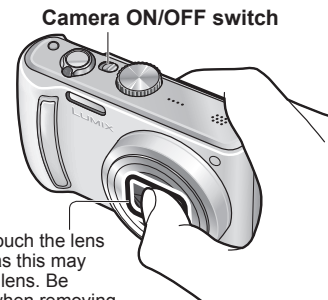

■ When using tripod

- Do not apply excessive force or tighten screws at an angle (may damage camera, screw hole, or label.)
- Ensure that the tripod is stable.
(Read the tripod's instruction manual.)

■ When transporting

Switch off power.
We recommend using a genuine leather case (DMW-CT3, optional).

Standard Accessories

- Battery Pack**
(referred to in this manual as 'battery')
- Battery Charger**
(referred to in this manual as 'charger')
- Battery Carrying Case**
- AC Cable**
- Strap**
- USB Connection Cable**
- AV Cable**
- CD-ROM**
 - Operating Instructions
- CD-ROM**
 - Software
- The accessories and their shape will differ depending on the country or area where the camera was purchased.
- Please dispose of all packaging appropriately.
- Cards are optional. You can record or play back pictures on the built-in memory when you are not using a card. (P.18)
- Consult the dealer or your nearest servicentre if you lose the supplied accessories. (You can purchase the accessories separately.)

Please also refer to 'Usage cautions and notes' (P.98).

Names of parts

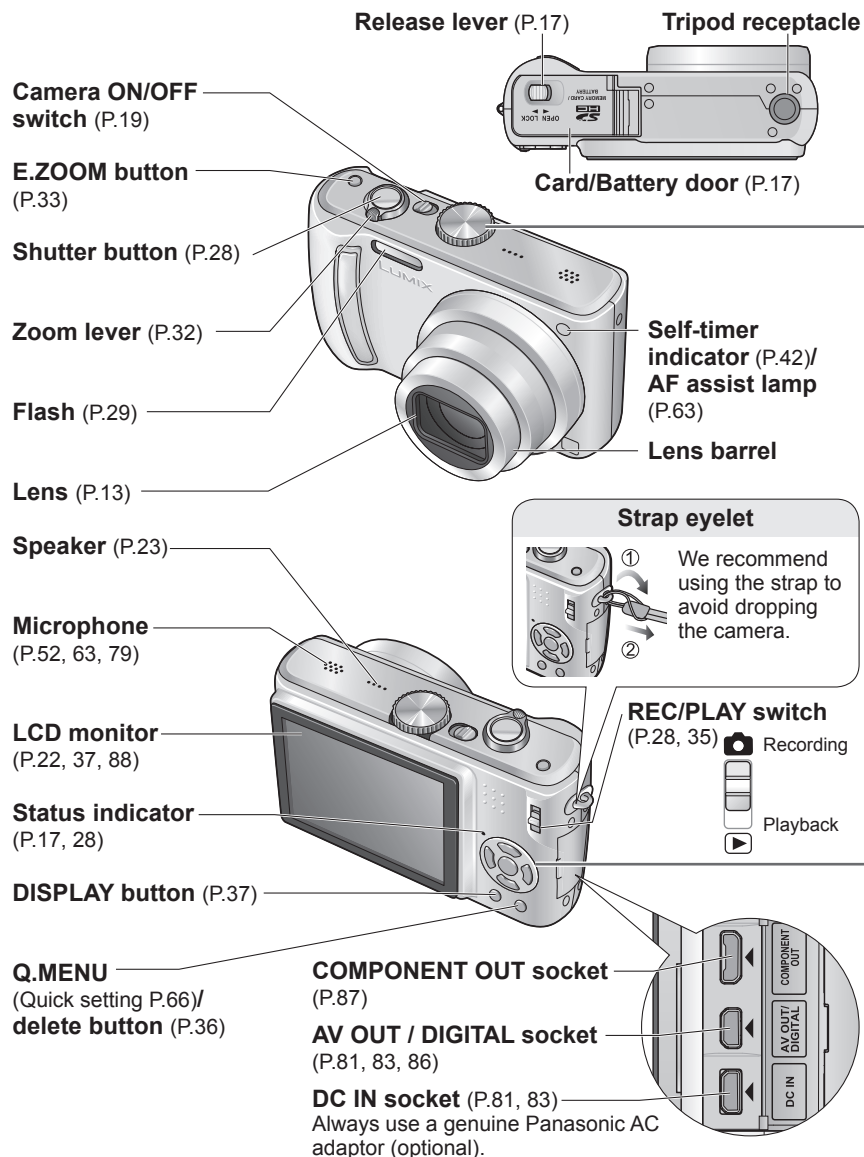

Mode dial



iA INTELLIGENT AUTO mode	Take pictures with automatic settings (P.28).
📷 NORMAL PICTURE mode	Take pictures with customized settings (P.30).
SCN1 SCN2 SCENE mode	Take pictures according to scene (P.44).
🎞️ MOTION PICTURE mode	Take motion pictures (P.52).
📄 CLIPBOARD mode	Take pictures as memos (P.64).

Cursor button

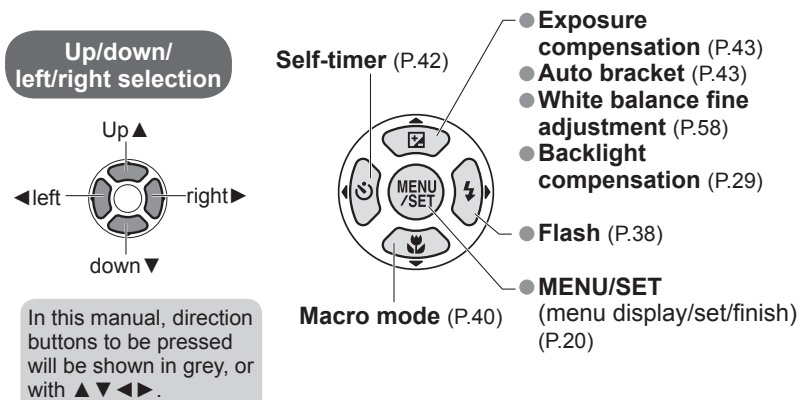

1 Charging battery

Always charge before first use! (not sold pre-charged)

- 1 Insert the battery terminals and attach the battery to the charger.**
Ensure 'LUMIX' faces outwards.

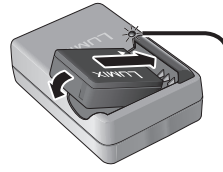

- 2 Connect the charger to the electrical outlet**

- Plug-in type
- Inlet type

Battery (model-specific)

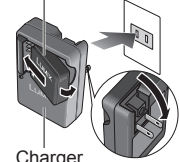

Charger (model-specific)

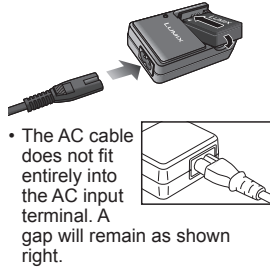

- The AC cable does not fit entirely into the AC input terminal. A gap will remain as shown right.

- 3 Detach the battery after charging is complete**

- Disconnect charger and battery when charging is complete.

Charging light (CHARGE)

On: Charging in progress, approx. 120 min. (Max.)
Off: Charging complete

If light is flashing:

- Charging may take longer than normal if battery temperature is too high or too low (charging may not be completed).
- Battery/charger connector is dirty. Clean with dry a cloth.

■ Approximate battery life

- **Number of pictures** *1 : 300 [330 *2] (at 30-sec intervals)
(equivalent to approx. 150 [165 *2] mins)
*1 Values based on CIPA standards. (P.99)
Number reduced if intervals longer – 75 [82 *2] pictures if 2-minute intervals

- **Playback time: Approx. 360 [380 *2] mins**

Above figures may be reduced if intervals between recordings are longer; if flash, zoom, or LCD MODE are used frequently; or in colder climates (depends on actual usage).

*2 DMC-TZ4/DMC-TZ11

- Battery will be warm during charging and for some time thereafter.
- Battery will run out if not used for long periods of time, even after being charged.
- Charge the battery with the charger indoors (10 °C-35 °C).
- Do not disassemble or modify the charger.
- If available battery power is significantly reduced, battery is reaching end of lifespan. Please purchase a new battery.
- The battery charger is in the standby condition when the AC power is supplied. The primary circuit is always "live" as long as the battery charger is connected to an electrical outlet.
- Frequently charging up battery is not recommended.
(Frequently charging battery reduces maximum usage time and can cause battery to expand.)

2 Inserting battery and card

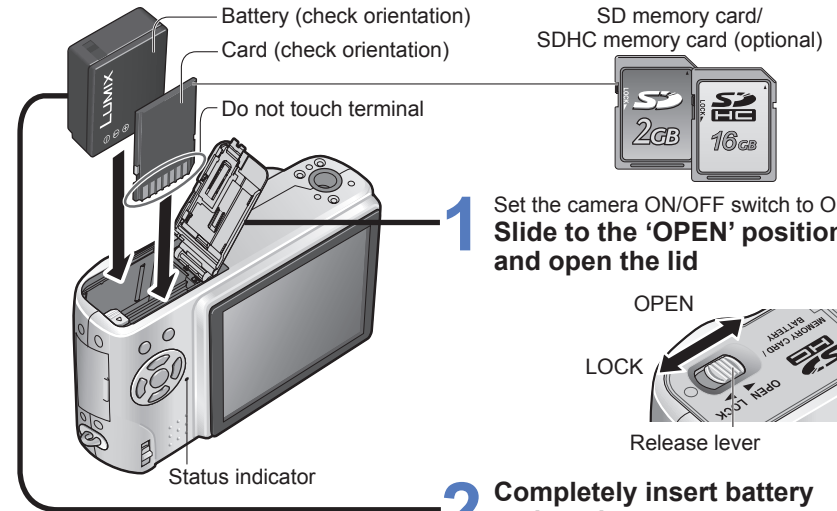

- 1 Set the camera ON/OFF switch to OFF. Slide to the 'OPEN' position and open the lid.**

- 2 Completely insert battery and card**
(both click into place)

- 3 Close lid**
Slide to the 'LOCK' position.

■ To remove

- **To remove battery:**
move lever in direction of arrow.

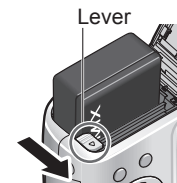

- **To remove card:**
press down in centre.

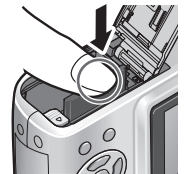

- Always use genuine Panasonic batteries.
- If you use other batteries, we cannot guarantee the quality of this product.
- Do not remove card or battery while power is 'ON' or while status indicator is on (Camera may cease operating correctly, or card/recorded contents may be damaged).
- The reading/writing speed of a MultiMediaCard is slower than an SD memory card. When a MultiMediaCard is used, the performance of certain features may be slightly slower than advertised.
- Keep the Memory Card out of reach of children to prevent swallowing.

2 Inserting battery and card (Continued)

Picture save destination (cards and built-in memory)

Pictures will be saved to a card if one is inserted, or to the built-in memory  if not.

Compatible memory cards (optional)

The following SD standard-based cards (Panasonic brand recommended)

- SD memory cards (8 MB - 2 GB)
- SDHC memory cards (4 GB - 16 GB)

Can only be used with devices compatible with SDHC memory cards.

- Cards of over 4 GB may only be used if they have the SDHC logo.

- Always format cards with this camera. (P.27)

- If the switch on the card is set to 'LOCK', operations such as formatting, recording, and deleting cannot be performed.

- MultiMediaCards may also be used (for still pictures only)

Built-in memory (approx. 50 MB)

- Internal memory is slower than SD memory card.
- Clipboard pictures (P.64) are saved to built-in memory.
- Pictures may be copied between cards and the built-in memory (P.80).

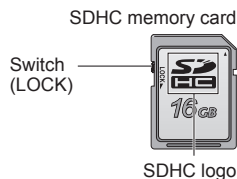

Remaining battery and memory capacity

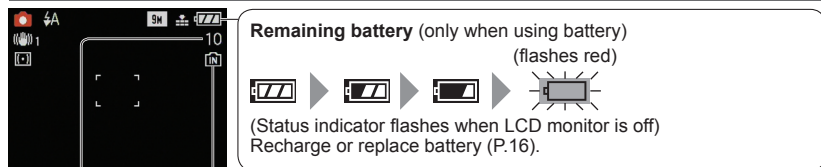

Pictures remaining (P.100)

Displayed when no card inserted (pictures will be saved to built-in memory)

When in operation

 (Card) or  (Built-in memory) are illuminated red.

This means that an operation is in progress, such as the recording, reading, or deleting of pictures. Do not turn off the power or remove the battery, card, or AC adaptor (optional) (this may cause damage to or loss of data).

- It is recommended that you copy important pictures to your computer (as electromagnetic waves, static electricity, or faults may cause data to be damaged).
- For model numbers and types, see <http://panasonic.co.jp/pavc/global/cs> (This Site is English only.)

3 Setting the clock

Set REC/PLAY switch to  before turning on power.

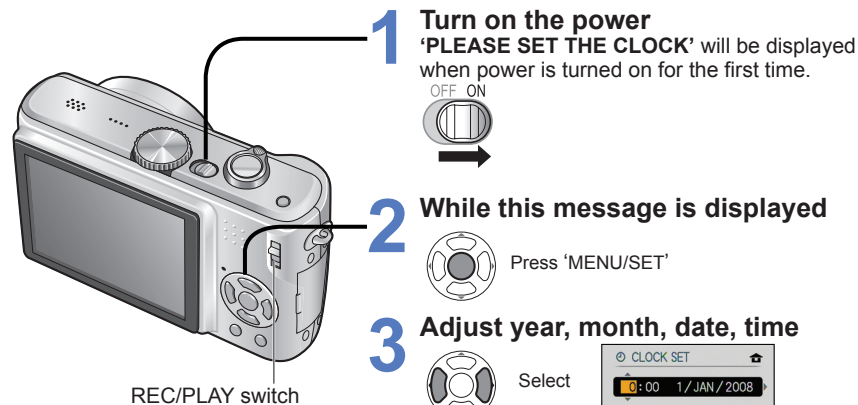

1 Turn on the power
'PLEASE SET THE CLOCK' will be displayed when power is turned on for the first time.



2 While this message is displayed



Press 'MENU/SET'

3 Adjust year, month, date, time



Select

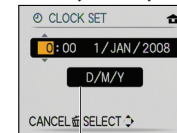

Adjust

Select to change date format

To change time setting

- ➔ Select 'CLOCK SET' from SETUP menu (P.22), perform **3** and **4**.

To set local time at overseas destination

- ➔ 'WORLD TIME' (P.54)

- To cancel → Press .
- [D/M/Y]
12:34 1.JAN.2008
- [M/D/Y]
12:34 JAN. 1. 2008
- [Y/M/D]
2008. 1. 1 12:34

4 Set



Press 'MENU/SET'

- Turn on power again and check time display. (Time and date can be displayed by pressing 'DISPLAY' several times.)

- Failure to set the date and time will cause the date/time to be improperly printed when printing pictures in digital photo centre or when using 'TEXT STAMP' (P.73).
- Time is displayed in 24-hour format. Year can be set between 2000 and 2099.
- Clock settings will be saved for approx. 3 months even after battery is removed, provided a fully-charged battery was installed in camera for the 24 hours beforehand.

Preparations 4 Using menus

To get more out of your camera, you can use a variety of functions and select settings from 4 different menus.

(Example) Change 'LCD MODE' in SETUP menu when in NORMAL PICTURE mode.

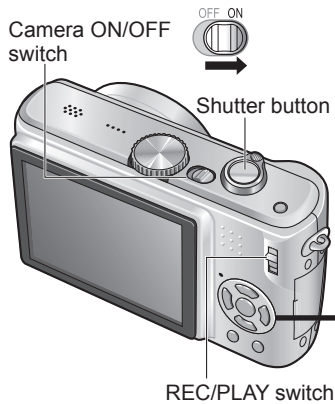

- 1 Bring up the menu**

(Screen example: DMC-TZ5)
- 2 Select the item**

Settings

Item
- 3 Select the setting**

Page
(Zoom lever can be used to switch to next screen.)
- 4 Finish**
 - When the REC/PLAY switch is set to , menu can be closed with a half-press of the shutter button.

■ To restore default settings
➔ 'RESET' (P.25)

Menu type

REC menu (REC/PLAY switch

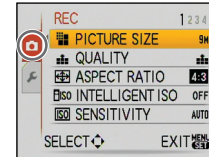

Changing photography preferences (P.55-63)

- Make settings such as white balance, sensitivity, aspect ratio, and picture size.

(Screen example: DMC-TZ5)

MODE PLAYBACK MODE menu (REC/PLAY switch



Viewing recorded pictures (P.69-71)

- Choose a playback type to see your pictures on dual screens*, slideshows, or just your favourite pictures.
- * DMC-TZ5/DMC-TZ15 only

(Screen example: DMC-TZ5)

PLAYBACK menu (REC/PLAY switch

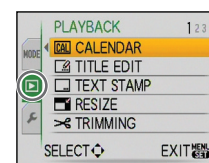

Using your pictures (P.72-80)

- Make settings for using the pictures you have taken, including rotating, protecting, trimming, and handy settings for printing your pictures (DPOF).

SETUP menu (REC/PLAY switch



Making the camera more convenient to use (P.22-27)

- Make settings for ease of use such as adjusting the clock and changing the beep sounds.









● Settings display may vary according to items.





















● Menu items displayed vary according to mode dial setting.

Preparations **5** Using SETUP menu







Make general camera settings such as adjusting the clock, extending the battery life, and changing the beep sounds.







'CLOCK SET', 'AUTO REVIEW' and 'ECONOMY' are important for clock setting and battery life. Be sure to check these before use. (Setting method : P.20)



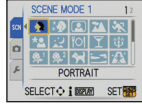

Item	Settings, notes
 CLOCK SET Set the date and time. (P.19)	Set time, date, and display format.
 WORLD TIME Set the local time at an overseas destination. (P.54)	 DESTINATION: Set the local time at overseas destination (P.54).  HOME: Set date and time at home area.
 MONITOR Adjust the brightness of the LCD monitor (7 levels).	+1 - +3: Brighter ±0: Standard -1 - -3: Darker
 LCD MODE Make LCD monitor easier to see.	OFF : Normal (cancel setting)  AUTO POWER LCD: The Power LCD is automatically activated in bright places such as outdoors etc.  POWER LCD : Makes screen brighter than normal (for outdoor use).  HIGH ANGLE : Makes screen easier to see when taking pictures from high positions. (becomes harder to see from the front) <ul style="list-style-type: none"> • 'HIGH ANGLE' will be cancelled when power is turned off (including POWER SAVE). • Block out sunlight (with hand, etc.) if reflection makes screen difficult to see. • 'AUTO POWER LCD' or 'HIGH ANGLE' cannot be used in the following cases. During playback mode or menu screen display, or when connected to computer/printer. • 'POWER LCD' will be deactivated if no operations are performed for 30 seconds while recording. (Brightness can be restored by pressing any button) • Brightness/colour of screen in 'LCD MODE' has no effect on pictures recorded.

Item	Settings, notes
 BEEP Change or mute the beep/shutter sounds.	BEEP LEVEL  /  /  : Mute/Low/High BEEP TONE  /  /  : Change beep tone. SHUTTER VOL.  /  /  : Mute/Low/High SHUTTER TONE  /  /  : Change shutter tone.
 VOLUME Adjust volume of sound from speakers (7 levels).	0 · · LEVEL3 · · LEVEL6 • Cannot be used to adjust TV speaker volume when connected to TV. (We recommend setting camera volume to 0)
 GUIDE LINE Select recording information display and types of guidelines. (P.37)	REC. INFO. OFF/ON (Display recording information with guide lines.) PATTERN  /  : Change the patterns of guide lines. • Only  may be used in INTELLIGENT AUTO mode and CLIPBOARD mode.
 HISTOGRAM Check subject brightness on graph. (P.37)	OFF/ON
 TRAVEL DATE Record the number of days elapsed in your travels. (P.53)	TRAVEL SETUP OFF/SET (Register departure and return dates) LOCATION OFF/SET (Input name of destination.) (P. 72)

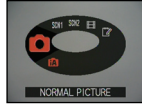
Item	Settings, notes
ECO ECONOMY Turn off LCD monitor and power while not in use to save battery consumption.	POWER SAVE OFF/2MIN./5 MIN./10MIN. : Automatically shut off power while not in use. <ul style="list-style-type: none"> To restore → Press the shutter button halfway, or turn on the power again. Cannot be used in the following cases: When using AC adaptor (optional), when connected to computer/printer, during motion picture recording/playback, during slideshows Settings fixed to '2 MIN.' in 'AUTO LCD OFF' (below), '5 MIN.' in INTELLIGENT AUTO mode or CLIPBOARD mode, or '10 MIN.' while slideshow is paused.
	AUTO LCD OFF OFF/15SEC./30SEC. : LCD monitor is shut off if no operations are performed for a set period while recording. (Status indicator is illuminated while monitor is off.) <ul style="list-style-type: none"> Cannot be used in the following cases: When using INTELLIGENT AUTO mode, CLIPBOARD mode, or AC adaptor (optional), when menu screen is displayed, when using self-timer setting or during motion picture recording. Monitor also shuts off during flash battery charging. To restore → Press any button.
 AUTO REVIEW Automatically display pictures immediately after taking them.	OFF 1 SEC./2 SEC.: Automatically display for 1 or 2 seconds. HOLD: Auto review screen remains until a button (other than the display button) is pressed ZOOM: Displays for 1 second, then at 4x zoom for 1 second <ul style="list-style-type: none"> Fixed to '2 SEC.' in INTELLIGENT AUTO mode. In 'SELF PORTRAIT', 'HI-SPEED BURST', and 'MULTI ASPECT*' scene modes, 'AUTO BRACKET', 'BURST' mode, or pictures with audio, auto review performed regardless of setting. (* DMC-TZ5/DMC-TZ15 only) Motion pictures cannot be automatically reviewed.

Item	Settings, notes
 ZOOM RESUME Remember the zoom ratio when turning power off.	OFF / ON <ul style="list-style-type: none"> Cannot be set when using 'SELF PORTRAIT' scene mode.
 NO.RESET Reset image file numbers.	YES / NO <ul style="list-style-type: none"> The folder number is updated and the file number starts from 0001. A folder number between 100 and 999 can be assigned. Numbers cannot be reset once folder number reaches 999. In this case, save all necessary pictures to your computer, and format the built-in memory/card (P.27). To reset folder number to 100: First, format the built-in memory or card, and reset the file numbers using NO. RESET. Then, select 'YES' on the folder number reset screen. File numbers and folder numbers. (P.82, 97)
 RESET Reset to the default settings.	RESET REC. SETTINGS? YES/NO RESET SETUP PARAMETERS? YES/NO <ul style="list-style-type: none"> Resetting SETUP parameters causes the following to be reset: Birthdays and names in 'BABY' and 'PET' scene modes, 'TRAVEL DATE', 'WORLD TIME', 'ZOOM RESUME', 'FAVORITE' in PLAYBACK menu (set to 'OFF'), 'ROTATE DISP.' (set to 'ON'). Folder numbers and clock settings will not be reset. Camera movement may be audible as the lens function is reset. This is not a fault.
 USB MODE Select communication method for when connecting camera to a computer or printer with USB connection cable.	 SELECT ON CONNECTION : Select 'PC' or 'PictBridge(PTP)' each time you connect to a computer or PictBridge-compatible printer. <ul style="list-style-type: none">  PictBridge (PTP) : Select when connecting to a PictBridge-compatible printer  PC: Select when connecting to a computer

Item	Settings, notes
 VIDEO OUT Change the video output format when connected to a TV, etc. (PLAYBACK mode only).	NTSC/PAL <ul style="list-style-type: none"> Operates when AV cable is connected.
 TV ASPECT Change the aspect ratio when connected to a TV, etc. (PLAYBACK mode only).	16:9 / 4:3 <ul style="list-style-type: none"> When set to 16:9, pictures will be displayed vertically long on LCD monitor. (Operates when AV cable is connected.)
 m/ft Change display unit for distance in focus alignment (P.41).	m: Display in meters ft: Display in feet
 SCENE MENU Display scene menu when mode dial is set to SCN1 or SCN2. (P.44)	OFF/AUTO (displays scene menu) <ul style="list-style-type: none"> To display scene menu when set to 'OFF': Press 'MENU/SET'. 
 DIAL DISPLAY Display mode dial operation on screen.	OFF/ON (display) 

Item	Settings, notes
 FORMAT Use when 'BUILT-IN MEMORY ERROR' or 'MEMORY CARD ERROR' appears.	YES/NO <ul style="list-style-type: none"> This requires a sufficiently charged battery (P.16) or AC adaptor (optional). (Only inserted card will be formatted if present; internal memory will be formatted if no card is inserted.) Always format cards with this camera. All picture data including protected pictures will be deleted. (P.79) Do not turn off power or perform other operations during formatting. Consult retailer if format cannot be successfully completed. Formatting the built-in memory may take several minutes.
 LANGUAGE Change display language.	Set the language displayed on the screen.
DEMO DEMO MODE View demonstration of functions.	JITTER, SUBJ. MOVE DEMO.: (Only during recording) Extent of jitter and of subject movement are shown on graph. (Estimate) Large ← Small → Large  Jitter  Movement detection <ul style="list-style-type: none"> To stop → Press display button (P.14). Recording and zoom cannot be performed during demo. Use the movement detection demo with objects with contrasting colouring. AUTO DEMO. : View introductory slideshow <ul style="list-style-type: none"> To close → Press 'MENU/SET' Demo cannot be outputted to TV.

1 Taking picture with automatic settings

Please set the clock before taking pictures (P.19).

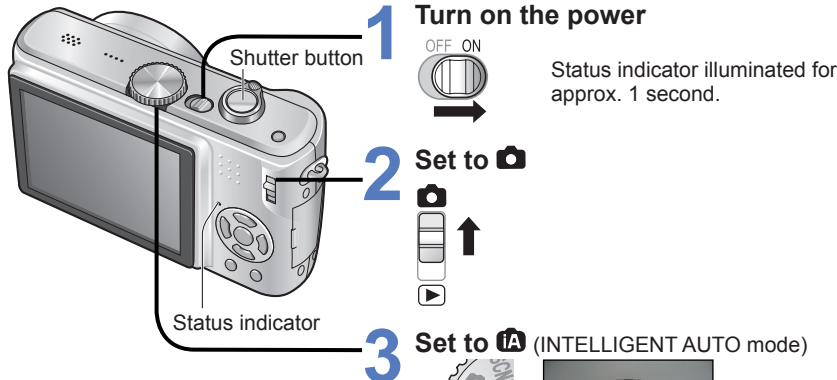

Automatic scene distinction

- Recognises 'i PORTRAIT'**
Follows face to take clear, bright pictures.
- Recognises 'i SCENERY'**
Takes sharp pictures of near and far landscapes.
- Recognises 'i MACRO'**
Reads distance to take sharp pictures of close subjects
- Recognises 'i NIGHT PORTRAIT'**
Takes bright, natural pictures of people and night scenery. (Only with)
- Recognises 'i NIGHT SCENERY'**
Uses slow shutter speed to achieve natural colouring. (Only with)
- Recognises movement**
Reads subject movement to avoid blurring when scene does not correspond to any of the above.

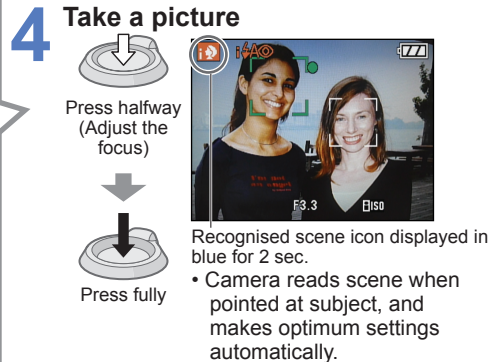

- Focus range → (P.41).
 - In addition to automatic scene distinction, 'INTELLIGENT ISO ', 'i.EXPOSURE', 'STABILIZER', and 'CONTINUOUS AF' will operate automatically.
 - The following menu items may be set in INTELLIGENT AUTO mode.
 - REC menu: 'PICTURE SIZE*', 'ASPECT RATIO', 'BURST', 'COLOR MODE*', 'STABILIZER*'
 - SETUP menu: 'CLOCK SET', 'WORLD TIME', 'TRAVEL DATE', 'BEEP*', 'LANGUAGE'
- * Items that may be set differ from other recording modes.

Optimum settings are made automatically from information such as 'face', 'movement', 'brightness', and 'distance' just by pointing the camera at the subject, meaning that clear pictures can be taken without the need to make settings manually.

■ Backlight compensation (brighten subject against backlight)

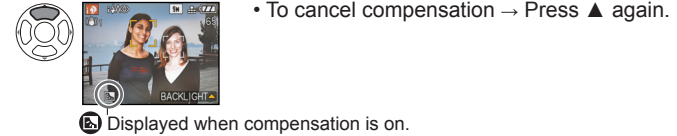

■ To use flash

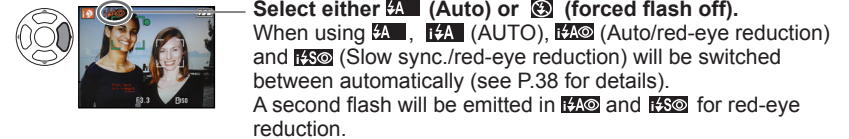

- According to the following conditions, different scene types may be determined for the same subject.
 - Face contrast, conditions of subject (size, distance, colouring, movement), zoom ratio, sunset, sunrise, low brightness, jitter
- If desired scene type is not selected, we recommend manually selecting the appropriate recording mode. (scene mode: P.44)
- We recommend using a tripod and the self-timer with 'i NIGHT SCENERY' and 'i NIGHT PORTRAIT'.
- When jitter is small (e.g. using tripod) with 'i NIGHT SCENERY', shutter speed can reach a maximum of 8 seconds. Do not move the camera.
- The settings for the following functions are fixed.
 - AUTO REVIEW: 2 SEC. • POWER SAVE: 5 MIN. • GUIDE LINE: • WHITE BALANCE: AWB
 - QUALITY: (Fine) *1 • AF MODE: (Face detection) *2 • AF ASSIST LAMP: ON
 - METERING MODE: (Multiple)
- *1 0.3 M only (standard) *2 (9 points) when face cannot be recognised
- The following functions cannot be used. 'HISTOGRAM', 'EXPOSURE', 'AUTO BRACKET', 'WB ADJUST.', 'DIGITAL ZOOM', 'MIN. SHTR SPEED', 'AUDIO REC.'

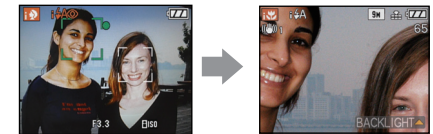



e.g. Face too large – 'i PORTRAIT' becomes 'i MACRO'

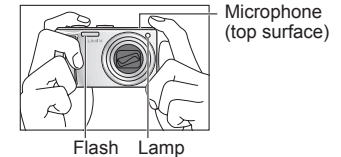



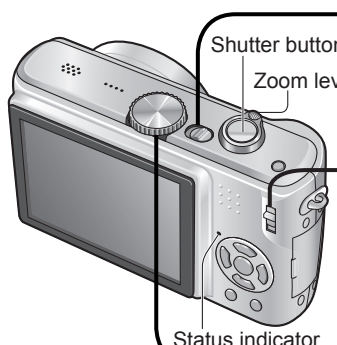

- Holding the camera
 - Do not block the flash or the lamp. Do not look at them from close range.
 - Do not touch the lens.
 - Stand with your arms close to your body and with your legs apart.
 - Do not block the microphone when recording audio.
 - Holding camera vertically (→ P.31)



Taking pictures with your own settings



- 1 Turn on the power**

Status indicator illuminated for approx. 1 second.
- 2 Set to **

- 3 Set to  (NORMAL PICTURE mode)**

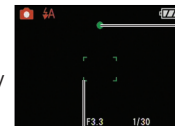
- 4 Take a picture**

Press halfway (Adjust the focus)



Focus display (when focus aligned: flashing → illuminated)



Press fully

AF area (Aligns focus with subject; when complete: red/white → green)

 - Beep sounds when focus is not aligned.

■ To use zoom

➔ (P.32)

■ To use flash

➔ (P.38)

■ To adjust image brightness

➔ (P.43)

■ To take close-up pictures

➔ (P.40)

■ To adjust colouring

➔ (P.58)

- When (jitter alert) is displayed, use the optical image stabilizer (P.62), a tripod, or the self-timer (P.42).
- If aperture value or shutter speed is displayed in red, correct exposure has not been achieved. Use flash or change 'SENSITIVITY' (P.57) settings.



Jitter alert display

Aperture value

Shutter speed

Using REC menu (P.55) to change settings and set up your own recording environment.

Align focus for desired composition

Useful when subject is not in centre of picture.

1 First adjust focus according to subject



Hold down halfway



AF area

- Subjects/environments which may make focusing difficult:
 - Fast-moving or extremely bright objects, or objects with no colour contrast.
 - Taking pictures through glass or near objects emitting light. In dark, or with significant jitter.
 - When too close to object or when taking pictures of both distant and close objects together in the same picture.
- We recommend using the 'face detection' function when taking pictures of people (P.59).

2 Return to desired composition



Press fully



AF area

- Focus range → (P.41).
Outside of range, focus may not be aligned even if display is lit as normal.
- AF area is displayed larger in dark conditions or when using digital zoom.
- Most displays are temporarily cleared from screen when the shutter button is pressed halfway.
- Holding camera vertically
Pictures taken with camera held vertically can automatically be displayed vertically in playback.
(Only when 'ROTATE DISP.' (P.76) set to 'ON')
Pictures may not be able to be displayed vertically if taken with camera facing upwards or downwards. Motion pictures cannot be displayed vertically during playback.

3 Taking pictures with zoom

You can zoom in up to 10 times with 'optical zoom', and up to 16.9 (DMC-TZ4/DMC-TZ11: 15.9) times with 'Extra optical zoom' with lower picture quality. You can also use 'digital zoom' to zoom in even further.

Do not block the lens barrel movement while zooming.

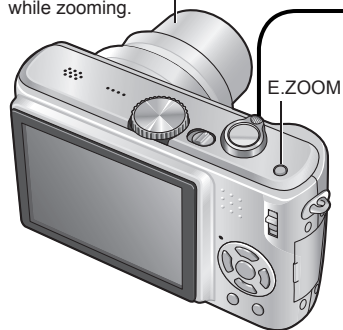

1 Zoom In/Out

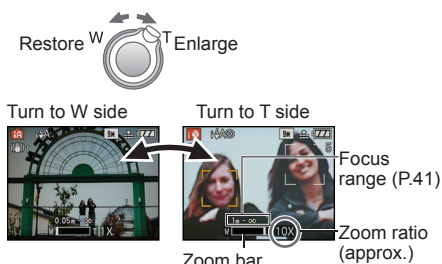

- Zoom speed can be adjusted.
Zoom slowly → turn slightly
Zoom quickly → turn completely
- Adjust the focus after adjusting the zoom.

Optical zoom and extra optical zoom (EZ)

Automatically switches to 'optical zoom' when using maximum picture size (P.55), and to 'extra optical zoom' (for further zooming) otherwise. (EZ is short for 'extra optical zoom'.)

• Optical zoom



Max. enlargement: 10x

• Extra optical zoom



Max. enlargement: 11.3x - 16.9x
(DMC-TZ4/DMC-TZ11: 12.8x - 15.9x)
Varies according to picture size.

● Maximum zoom ratios by picture size

ASPECT RATIO		Optical zoom		Extra optical zoom			
		Picture Size	Max. enlargement	Picture Size	Max. enlargement	Picture Size	Max. enlargement
4:3	PICTURE SIZE	9 M (8 M)	7 M EZ *1	5 M EZ	3 M EZ	2 M EZ	0.3 M EZ
	Max. enlargement	10 x	11.3 x *1	13.5 (12.8) x	16.9 (15.9) x		
3:2	PICTURE SIZE	8.5 M (7 M)	6 M EZ *1	4.5 M EZ	2.5 M EZ		
	Max. enlargement	10 x	11.6 x *1	13.9 (12.8) x	16.9 (15.9) x		
16:9	PICTURE SIZE	7.5 M (6 M)	5.5 M EZ *1	3.5 M EZ	2 M EZ		
	Max. enlargement	10 x	12.1 x *1	14.5 (12.8) x	16.9 (15.9) x		

*1 DMC-TZ5/DMC-TZ15 only, ():DMC-TZ4/DMC-TZ11

● What is Extra optical zoom (EZ)?

If, for example, set to '3M **EZ**' (equivalent to 3 million pixels), a picture will only be taken of a 3M-sized central part of a 9 M (equivalent to 9.1 million pixels) *2 area, meaning that the picture can be enlarged further.

*2 DMC-TZ4/DMC-TZ11 : 8M

■ To enlarge quickly to max. ratio 'EASY ZOOM'



E.ZOOM (zoom ratio changes with each press)

e.g. Picture size is 7M or less (5M or less for DMC-TZ4/DMC-TZ11)

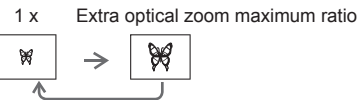

e.g. Picture size is 7.5M or more (6M or more for DMC-TZ4/DMC-TZ11)



Picture quality is temporarily reduced.

4:3	9 M (8 M)	→	3 M	
3:2	8.5 M (7 M)	→	2.5 M	
16:9	7.5 M (6 M)	→	2 M	(): DMC-TZ4/DMC-TZ11

- You can zoom further to the maximum digital zoom ratio if 'DIGITAL ZOOM' (P.34) is set to 'ON'.
- Easy zoom cannot be used while recording motion pictures.

- The enlargement ratio displayed in the bar on screen is an estimate.
- In certain recording modes, TELE MACRO function (P.40) is activated when maximum zoom ratio is reached.
- A greater degree of distortion may be generated by taking wider-angled pictures of close objects, while using more telescopic zoom may result in more colouring appearing around the outlines of objects.
- The camera may make a rattling noise and vibrate when the zoom lever is operated – this is not a fault.
- Extra optical zoom cannot be used in the following cases:
 ■ (MOTION PICTURE mode), 'HIGH SENS.', 'HI-SPEED BURST', and 'MULTI ASPECT' (DMC-TZ5/DMC-TZ15 only) scene modes
- When using extra optical zoom, zoom movement may stop momentarily near maximum W (1x), but this is not a fault.
- 'ZOOM RESUME' (P.25) allows zoom ratio to be memorised even if power is turned off.

3 Taking pictures with zoom (Continued)

Enlarging further 'DIGITAL ZOOM'

Zoom 4 times further than optical/extra optical zoom (maximum 40x – 67.5x*).

(Note that, with digital zoom, enlarging will lessen picture quality.)

* DMC-TZ4/DMC-TZ11: 63.8 x

1 Display REC menu

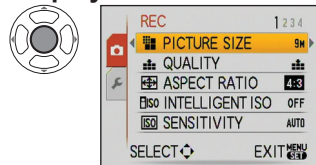

(Screen example: DMC-TZ5)

3 Select 'ON'

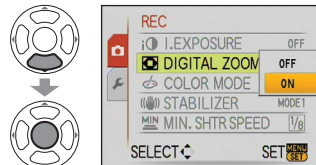

2 Select 'DIGITAL ZOOM'

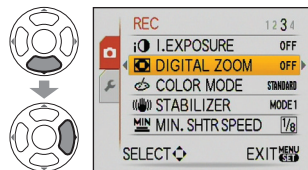

4 Finish



- Digital zoom area is displayed within zoom bar on screen.

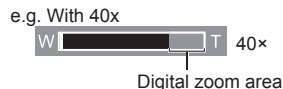

- Zoom motion stops momentarily when entering digital zoom range.
- Within digital zoom range, AF area is displayed larger when the shutter button is pressed halfway.
- We recommend using a tripod and the self-timer (P.42).

- Digital zoom cannot be used in the following modes:

IA (INTELLIGENT AUTO mode), CLIPBOARD mode, scene modes ('SPORTS', 'BABY', 'PET', 'HIGH SENS.', 'HI-SPEED BURST', and 'MULTI ASPECT*'), when 'INTELLIGENT ISO' is not set to 'OFF'

* DMC-TZ5/DMC-TZ15 only

4 Viewing your pictures (Play)

When there is no card inserted, the pictures played back from the built-in memory. (Clipboard pictures can only be played back in CLIPBOARD mode (P.64).)

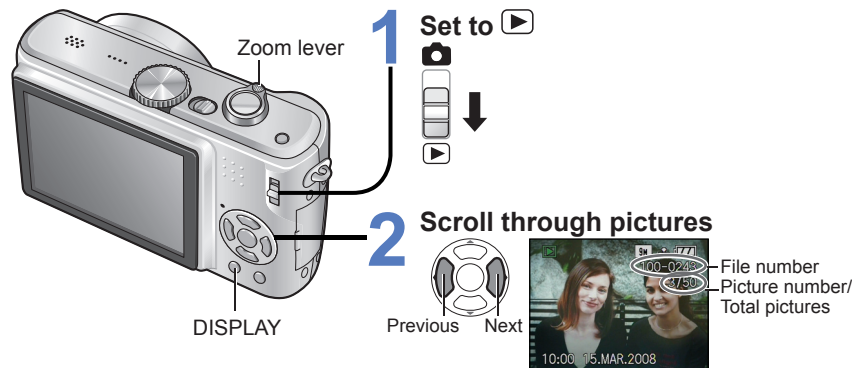

To enlarge (playback zoom)

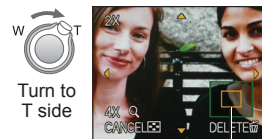

Current zoom position (displayed for 1 sec.)

- Zoom ratio: 1x/2x/4x/8x/16x
- To reduce zoom → Turn lever towards W side
- Move zoom position → ▲ ▼ ◀ ▶

To playback as list

➔ (P.67)

To view with different playback modes

(slideshow, etc.) ➔ (P.69)

To rotate pictures

➔ (P.76)

- Hold down to quickly scroll forwards/backwards. (Only file numbers change while held down; picture is displayed when released) Scroll speed increases the longer you press.
- If file number is not displayed, press display button.
- After the final picture, display returns to the first picture.
- Some pictures edited on computer may not be able to be viewed on this camera.
- If the REC/PLAY switch is moved from to while the power is on, the lens barrel will be retracted after 15 seconds.
- This camera is compliant with the unified DCF (Design rule for Camera File system) standard formulated by the Japan Electronics and Information Technology Industries Association (JEITA), and with Exif (Exchangeable image file format). Files that are not DCF-compliant cannot be played back.

5 Deleting pictures

Pictures deleted will be from card if card is inserted, or from built-in memory if the card is not inserted. Deleted pictures cannot be recovered.

- 1 Set to**
- 2 Press to delete displayed picture**
Q.MENU
- 3 Select 'YES'**

• Do not turn off the power during deletion.

• Use a sufficiently charged battery or an AC adaptor (optional).

To delete multiple (up to 50) or all pictures

(after step 2)

3 Select type of deletion

• To use 'DELETE ALL' → go to step 6

4 Select the pictures to delete (Repeat)

• To release → Press DISPLAY again

Picture selected

5 Delete

6 Select 'YES'

• To cancel → press 'MENU/SET'.
• May take time depending on number of pictures deleted.
• 'ALL DELETE EXCEPT ★ (FAVORITE)' may be selected in 'DELETE ALL' when 'FAVORITE' is set to 'ON' (P.77) and pictures have been registered.

- Pictures cannot be deleted in the following cases:
 - Protected pictures (P.79)
 - Card switch is in 'LOCK' position.
 - Pictures not of DCF standard (P.35)
- Motion pictures can also be deleted.
- To delete clipboard pictures, set mode dial to

1 Changing recording information display

Change between different LCD monitor displays, such as histograms.

1 **Press to change display**

- In recording mode

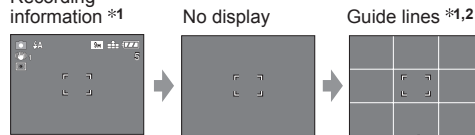

- *1 Set 'HISTOGRAM' to 'ON' to display histogram (P.23).
- *2 Select guide line pattern and recording information display on/off with 'GUIDE LINE' setting (P.23).

- In playback mode

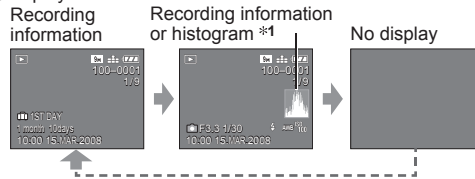

- When is in use, recording information and guide lines cannot be displayed simultaneously.

■ Histogram

Displays distribution of brightness in picture – e.g. if the graph peaks at the right, this means there are several bright areas in the picture. (Guide) A peak in the centre represents correct brightness (correct exposure) (P.43).

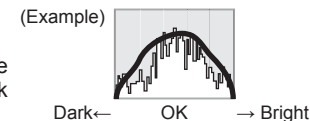

- Histogram from time of recording is different to histogram in playback and displayed in orange, when recording with flash or in dark locations. Also, histogram may differ from histograms made with image editing software.
- Histograms cannot be displayed in (INTELLIGENT AUTO mode), (MOTION PICTURE mode), (CLIPBOARD mode), or during playback zoom.

■ Guide lines

Reference for composition (e.g. balance) when recording.

- Judge balance
- Judge centre of subject

- During playback zoom, motion picture playback, slideshow : Display on/off
- During menu display, multi playback or calendar playback, 'DUAL PLAY' (DMC-TZ5/DMC-TZ15 only): Display cannot be changed.

3 Taking close-up pictures

To enlarge the subject, you can take pictures from even closer up than the normal focus range allows (up to 5 cm for max. W) by using 'MACRO (AF \downarrow)'.

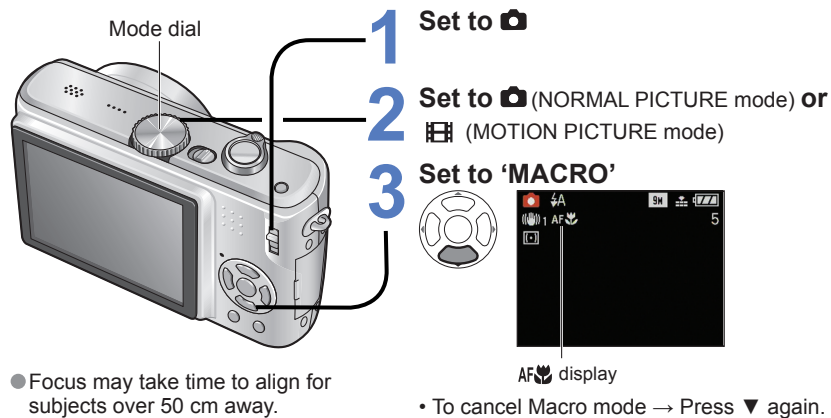

Taking close-up pictures without standing close to subject 'TELE MACRO function'

Useful for taking close-up pictures of, for example, birds that may fly away if approached, or to blur background and emphasize subject. 'TELE MACRO' operates automatically when optical or extra optical zoom ratios are set to maximum; focus can be aligned for distances as close as 1 m.

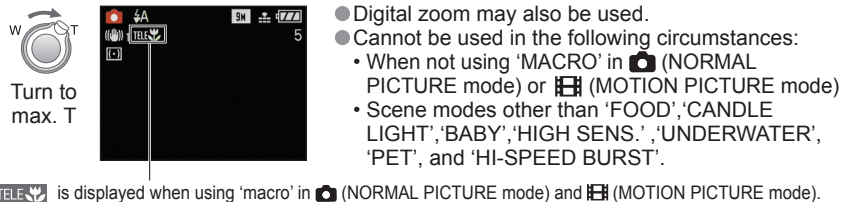

- We recommend using a tripod, the self-timer (P.42), and flash 'FORCED FLASH OFF' (P.38).
- Moving the camera after aligning the focus is likely to result in poorly focused pictures if subject is close to camera, due to margin for focus alignment being severely reduced.
- Resolution may be reduced around the edges of the picture.
- When using (INTELLIGENT AUTO mode), macro recording can be activated by just pointing the camera at subject. display)

4 Positioning camera and subject within accessible range for focus alignment

Accessible distance from subject depends on zoom ratio. Ranges for each mode dial setting are listed below.

\longleftrightarrow Focus range
 $\cdots\cdots\cdots$ Outside focus range

■ Mode dial set to: *1 *1

*1 When using MACRO AF \downarrow

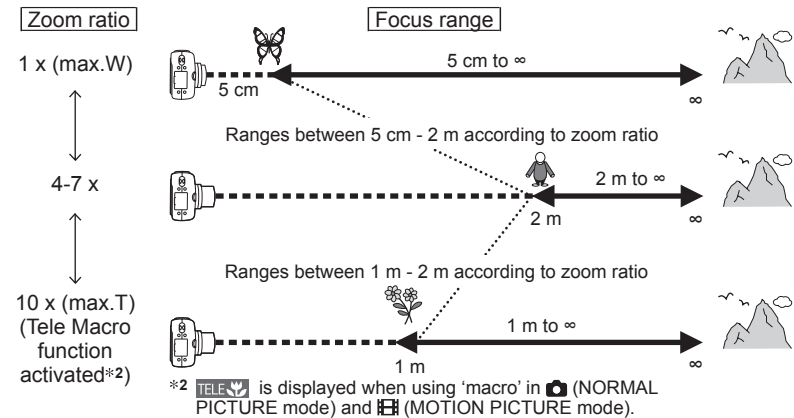

■ When not using MACRO: *3 *3

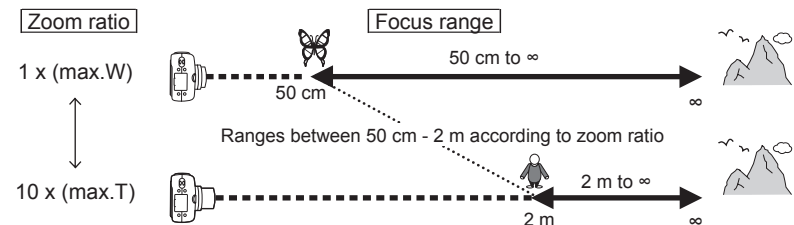

*3 When not using MACRO AF \downarrow



- Zoom ratios are approximate.
- Ranges for focus alignment differ for scene modes. → P.46
- Zoom ratios shown above vary when extra optical zoom is used.
- Max. W: Zoom lever turned as far as possible to W side (no zoom)
- Max. T: Zoom lever turned as far as possible to T side (maximum zoom ratio)

5 Taking pictures with self-timer

We recommend using a tripod. This is also effective for correcting jitter when pressing the shutter button, by setting the self timer to 2 seconds.

- 1 Display 'SELFTIMER'**

- 2 Select time duration**

Displayed for approx. 5 sec.

 - Can also be selected with ◀.
- 3 Take a picture**
 - Focus will be automatically adjusted immediately before recording if shutter button is pressed fully here.

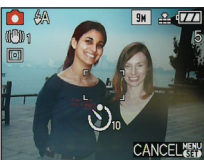
Press halfway (align focus)



Press fully (Picture taken after selected time elapsed)

 - To cancel while in operation → Press 'MENU/SET'



Self-timer indicator
(Flashes for set duration)

- After self-timer lamp stops flashing, it may then be lit for AF assist lamp.
- This function cannot be used in the 'UNDERWATER' and 'HI-SPEED BURST' scene modes or in MOTION PICTURE mode .
- In some modes, only '2SEC.' or only '10SEC.' may be selected.
 INTELLIGENT AUTO mode: '10SEC.'
 CLIPBOARD mode, 'SELF PORTRAIT' scene mode: '2SEC.'

6 Taking pictures with exposure compensation

Corrects exposure when adequate exposure cannot be obtained (if difference between brightness of object and background, etc.). Depending on the brightness, this may not be possible in some cases.

EXPOSURE

- 1 Display 'EXPOSURE'**

 - Example of exposure compensation
- 2 Select a value**

'0' (no compensation)

Minus direction

Optimum exposure

Plus direction

Under-exposed

 - The compensation value is displayed on the bottom-left of the screen. ($\frac{1}{3}$, etc.)

AUTO BRACKET

Takes 3 pictures in succession, changing the exposure. After exposure compensation, the compensation value is as standard.

- e.g. AUTO BRACKET with $\pm 1EV$

- 1 Display 'AUTO BRACKET'**

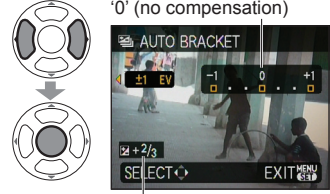
Press several times
- 2 Select a value**



'0' (no compensation)

First picture 0EV (Standard)

Second picture -1EV (Darker)

Third picture +1EV (Brighter)

Value displayed after exposure compensation set

- Cannot be used with flash or when there is remaining capacity for only 2 more pictures.
- When 'AUTO BRACKET' is set,  is displayed on the left of the screen.
- Cancelled when the power is turned off.
- Burst setting is cancelled when auto bracket is set.

Taking pictures according to the scene 'SCENE MODE'

Using SCENE MODE enables you to take pictures with optimum settings (exposure, colouring, etc.) for given scenes.

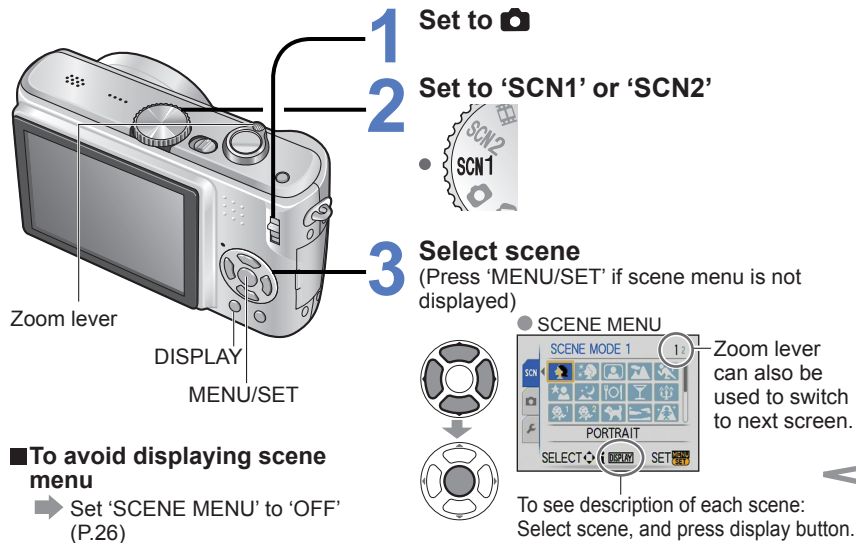







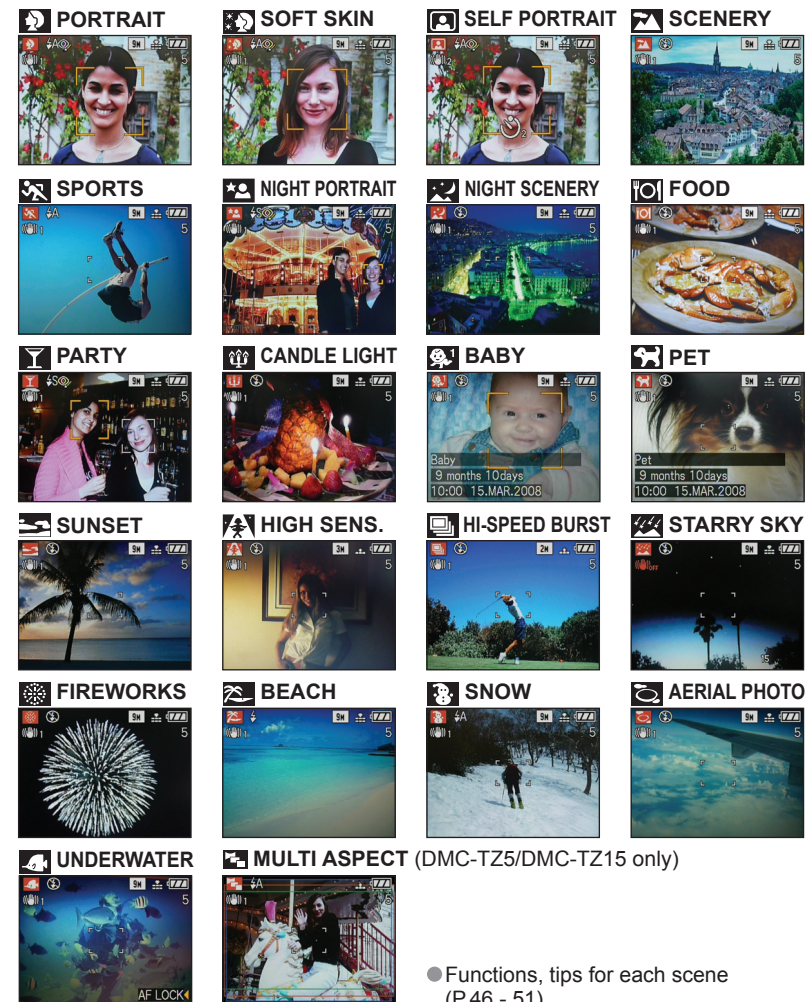











● SCN1 and SCN2







- Both represent the same function. Scene settings selected for 'SCN1' and 'SCN2' will be stored in the memory. This function is useful for immediate selection of scene settings you use most often (e.g. 'NIGHT SCENERY' for SCN1, 'NIGHT PORTRAIT' for SCN2).
- Selecting a scene mode inappropriate for the actual scene may affect the colouring of your picture.
- Following REC menu settings will be automatically adjusted and cannot be selected manually (available settings vary according to scene setting). 'INTELLIGENT ISO', 'SENSITIVITY', 'METERING MODE', 'I.EXPOSURE', 'COLOR MODE', 'MIN. SHTR SPEED'
- 'I.EXPOSURE' is operated automatically in the following scene modes, according to picture conditions. 'PORTRAIT', 'SOFT SKIN', 'SELF PORTRAIT', 'SCENERY', 'SPORTS', 'NIGHT PORTRAIT', 'PARTY', 'CANDLE LIGHT', 'BABY', 'SUNSET', 'HIGH SENS.'
- 'WHITE BALANCE' can be set to the following. 'PORTRAIT', 'SOFT SKIN', 'SELF PORTRAIT', 'SPORTS', 'BABY', 'PET', 'HIGH SENS.', 'HI-SPEED BURST', 'MULTI ASPECT (DMC-TZ5/DMC-TZ15 only)' (Setting is restored to 'AWB' when scene is changed.)
- The types of flash available (P.39) vary according to the scene. The scene mode flash setting is reset to the default setting when the scene mode is changed.
- Guidelines displayed in gray in 'NIGHT PORTRAIT', 'NIGHT SCENERY', 'STARRY SKY', and 'FIREWORKS' scene modes.



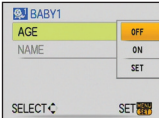

Scene types





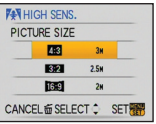

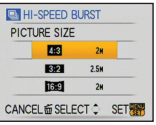

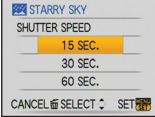
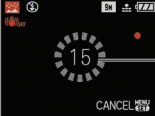

Scene	Uses, Tips	Notes
 PORTRAIT	Improves the skin tone of subjects for a healthier appearance in bright daylight conditions. Tips • Stand as close as possible to subject. • Zoom: As telescopic as possible (T side)	• 'AF MODE' default setting is  (face detection).
 SOFT SKIN	Smooths skin colours in bright, outdoor daylight conditions (portraits from chest upwards). Tips • Stand as close as possible to subject. • Zoom: As telescopic as possible (T side)	• Clarity of effect may vary depending on brightness. • 'AF MODE' default setting is  (face detection).
 SELF PORTRAIT	Take pictures of yourself. Tips • Press shutter button halfway → self-timer indicator illuminates → press shutter button fully → review (if self-timer indicator flashes, focus is not correctly aligned) • Focus: 30 - 70 cm (Max. W) • Do not use zoom (harder to focus). (Zoom moved to max. W automatically) • 2-second self-timer (P.42) recommended. 	• To take pictures with audio (P.63) (self-timer indicator illuminated during recording) • Main fixed settings STABILIZER: MODE2 AF ASSIST LAMP: OFF SELFTIMER: OFF/2SEC. ZOOM RESUME: OFF • 'AF MODE' default setting is  (face detection).
 SCENERY	Take clear pictures of wide, distant subjects. Tips • Stand at least 5 m away.	• Main fixed settings FLASH:  FORCED FLASH OFF AF ASSIST LAMP: OFF
 SPORTS	Take pictures of scenes with fast movement, e.g. sports. Tips • Stand at least 5 m away.	• Main fixed setting INTELLIGENT ISO: ISOMAX800 • Digital zoom: Cannot be set

Scene	Uses, Tips	Notes
 NIGHT PORTRAIT	Take pictures of people and nightscapes with close to actual brightness. Tips • Subject should not move for at least 1 second. (Shutter speed: max. 1 sec.) • Use flash. • Tripod, self-timer recommended. • Stand 1.2 - 5 m (Max. W (wide-angle), 1.5 m recommended) away.	• Interference may be noticeable with dark scenes. • Shutter may remain closed for 1 second after taking picture. • Main fixed setting CONTINUOUS AF: OFF • 'AF MODE' default setting is  (face detection).
 NIGHT SCENERY	Take clear pictures of night scenes. Tips • Stand at least 5 m away. • Do not move for 8 seconds. (Shutter speed: max. 8 sec. if little jitter, or using tripod, or optical image stabilizer is 'OFF') • Tripod, self-timer recommended	• Interference may be noticeable with dark scenes. • Shutter may remain closed for up to 8 seconds after taking picture. • Main fixed settings FLASH:  FORCED FLASH OFF CONTINUOUS AF: OFF AF ASSIST LAMP: OFF SENSITIVITY: ISO100-800
 FOOD	Take natural-looking pictures of food. Tips • Focus: Max. W: 5 cm and above Max. T: 1 m and above (2 m and above unless max.T)	-
 PARTY	Brighten subjects and background in pictures of indoor events, such as weddings. Tips • Stand approx. 1.5 m away. • Zoom: Wide (W side) • Use flash. • Tripod, self-timer recommended.	• 'AF MODE' default setting is  (face detection).
 CANDLE LIGHT	Bring out the atmosphere of a candlelit room. Tips • Focus: Max. W: 5 cm and above Max. T: 1 m and above (2 m and above unless max.T) • Do not use flash. • Tripod, self-timer recommended. (Shutter speed: max. 1 sec.)	• 'AF MODE' default setting is  (face detection).

Scene	Uses, Tips	Notes
 <p>BABY</p>	<p>Uses weak flash to bring out skin colours.</p> <p>Tips</p> <ul style="list-style-type: none"> To record age and name ('BABY1' and 'BABY2' can be set separately.)  <ol style="list-style-type: none"> Select 'AGE' or 'NAME' with ▲▼, press ►, and select 'SET'. Press 'MENU/SET'. Set the birthday and name. Birthday: Set birthday with ▲▼◀▶. Name: (See 'Text input method': P.72) Press 'MENU/SET'. <ul style="list-style-type: none"> Make sure 'AGE' and 'NAME' are 'ON' before taking a picture. To reset: Select 'RESET' from SETUP menu. Focus: Max. W: 5 cm and above Max. T: 1 m and above (2 m and above unless max.T) 	<ul style="list-style-type: none"> Age and name will be displayed for approx. 5 seconds after setting this mode. Age display format depends on LANGUAGE setting. 'AGE' and 'NAME' print setting can be made on your computer using the supplied CD-ROM (PHOTOfunSTUDIO -viewer-). Text may also be stamped onto the picture using 'TEXT STAMP' (P.73). Date of birth will be displayed as '0 month 0 day'. Main fixed setting INTELLIGENT ISO: ISOMAX400 'AF MODE' default setting is  (face detection). Digital zoom: Cannot be set Name cannot be recorded when 'LOCATION' is set in 'TRAVEL DATE'.
 <p>PET</p>	<p>Record pet's age when taking pictures.</p> <p>Tips</p> <ul style="list-style-type: none"> Same as for 'BABY' 	<ul style="list-style-type: none"> Main fixed setting INTELLIGENT ISO: ISOMAX800 Default settings are as follows. AF MODE:  (one-area-focusing) AF ASSIST LAMP: OFF Refer to 'BABY' (above) for other notes and fixed functions.
 <p>SUNSET</p>	<p>Take clear pictures of scenes such as sunsets.</p>	<ul style="list-style-type: none"> Main fixed settings FLASH:  FORCED FLASH OFF AF ASSIST LAMP: OFF

Scene	Uses, Tips	Notes							
 <p>HIGH SENS.</p>	<p>Prevents blurring of subject in dark, indoor conditions.</p> <p>Tips</p> <p>Select the aspect ratio and the picture size with ▲▼ and press 'MENU/SET'.</p>  <ul style="list-style-type: none"> Focus: Max. W: 5 cm and above Max. T: 1 m and above (2 m and above unless max.T) 	<ul style="list-style-type: none"> Pictures may appear slightly grainy due to high sensitivity. Main fixed settings QUALITY:  (Standard) SENSITIVITY: ISO1600 - 6400 Extra optical zoom and digital zoom cannot be used. 							
 <p>HI-SPEED BURST</p>	<p>Take pictures of rapid movement or a decisive moment.</p> <p>Tips</p> <ol style="list-style-type: none"> Select the aspect ratio and the picture size with ▲▼ and press 'MENU/SET'.  <ol style="list-style-type: none"> Take pictures. (Hold shutter button) Still pictures are taken continuously while the shutter button is pressed fully. <table border="1"> <tr> <td>Maximum Burst speed*</td> <td>DMC-TZ5/DMC-TZ15: Approx. 6 pictures/sec. DMC-TZ4/DMC-TZ11: Approx. 7 pictures/sec.</td> </tr> <tr> <td rowspan="2">Number of recordable pictures*</td> <td>Built-in memory</td> <td>Approx. 20</td> </tr> <tr> <td>Card</td> <td>Approx. 20 to 100 (The maximum is 100).</td> </tr> </table> <p>* The burst speed and number of recordable pictures change according to the recording conditions or types of cards.</p> <ul style="list-style-type: none"> Focus: Max. W: 5 cm and above Max. T: 1 m and above (2 m and above unless max.T) 	Maximum Burst speed*	DMC-TZ5/DMC-TZ15: Approx. 6 pictures/sec. DMC-TZ4/DMC-TZ11: Approx. 7 pictures/sec.	Number of recordable pictures*	Built-in memory	Approx. 20	Card	Approx. 20 to 100 (The maximum is 100).	<ul style="list-style-type: none"> The number of burst recording pictures increases immediately after formatting. The recorded pictures become slightly grainy. Main fixed settings FLASH:  FORCED FLASH OFF QUALITY:  (Standard) SENSITIVITY: ISO500 - 800 The focus, zoom, exposure, white balance, shutter speed and ISO sensitivity are fixed to the settings for the first picture. The following functions cannot be used. Extra optical zoom/ Digital zoom/ AUTO BRACKET/ SELF TIMER/ ASPECT RATIO/ PICTURE SIZE / AUDIO REC./ BURST
Maximum Burst speed*	DMC-TZ5/DMC-TZ15: Approx. 6 pictures/sec. DMC-TZ4/DMC-TZ11: Approx. 7 pictures/sec.								
Number of recordable pictures*	Built-in memory	Approx. 20							
	Card	Approx. 20 to 100 (The maximum is 100).							

Scene	Uses, Tips	Notes
 STARRY SKY	<p>Take clear pictures of starry skies or dark subjects.</p> <ul style="list-style-type: none"> Shutter speed settings <ol style="list-style-type: none"> Select with ▲▼, and press 'MENU/SET'.  Press shutter button.  <p>Countdown begins</p> <p>Tips</p> <ul style="list-style-type: none"> Set longer shutter speeds for darker conditions. Always use a tripod. Self-timer recommended. Do not move the camera until the countdown (above) has ended. (Countdown for processing is redisplayed afterwards) 	<ul style="list-style-type: none"> Main fixed settings FLASH: FORCED FLASH OFF AUDIO REC.: OFF CONTINUOUS AF: OFF STABILIZER: OFF SENSITIVITY: ISO100 'EXPOSURE', 'AUTO BRACKET', and 'BURST' cannot be used.
 FIREWORKS	<p>Take clear pictures of fireworks in the night sky.</p> <p>Tips</p> <ul style="list-style-type: none"> Stand at least 10 m away. Tripod recommended. 	<ul style="list-style-type: none"> Shutter speed can be set to 1/4 second or 2 seconds (if little jitter or if optical image stabilizer is 'OFF'). (when not using exposure compensation) Main fixed settings FLASH: FORCED FLASH OFF SENSITIVITY: ISO100 CONTINUOUS AF: OFF AF ASSIST LAMP: OFF
 BEACH	<p>Bring out the clear blues of the sky and the sea without darkening subject.</p>	<ul style="list-style-type: none"> 'AF MODE' default setting is (face detection). Beware of sand and sea water.
 SNOW	<p>Bring out the natural colour of snow in ski slope and mountain scenes.</p>	<ul style="list-style-type: none"> Battery life is reduced in lower air temperatures.

Scene	Uses, Tips	Notes
 AERIAL PHOTO	<p>Take pictures of the view from aircraft windows.</p> <p>Tips</p> <ul style="list-style-type: none"> Angle the camera towards areas of contrasting colours when aligning the focus. Check that the interior of the aircraft is not reflected in the window. 	<ul style="list-style-type: none"> Main fixed settings FLASH: FORCED FLASH OFF AF ASSIST LAMP: OFF Turn the camera off when taking off or landing. When using the camera, follow all instructions from the cabin crew.
 UNDERWATER	<p>Achieve natural colours under water.</p> <p>Tips</p> <ul style="list-style-type: none"> For fast moving subjects, align with the AF area and press (AF lock). Press again to release. Adjust red and blue levels with 'white balance fine adjustment' (P.58). Focus: Max. W: 5 cm and above Max. T: 1 m and above (2 m and above unless max.T) 	<ul style="list-style-type: none"> Always use marine case (DMW-MCTZ5, optional). Self-timer: Cannot be used  <p>AF LOCK (focus fixed)</p> <p>AF area</p>
 MULTI ASPECT (DMC-TZ5/DMC-TZ15 Only)	<p>Take pictures in each of the three aspect ratios (4:3, 3:2, 16:9) in one go.</p> <p>Tips</p> <ul style="list-style-type: none"> Ensure that subject is in centre of picture.  <p>3:2 (Red) 16:9 (Green) 4:3 (Blue)</p>	<ul style="list-style-type: none"> Main fixed settings QUALITY: (Standard) PICTURE SIZE: Max. size of each aspect ratio Cannot be used when memory is only available for 2 pictures or fewer (number flashes). Focus, exposure, white balance, and ISO sensitivity settings will be the same for all three pictures. The following functions cannot be used. Extra optical zoom/ Digital zoom/ AUTO BRACKET/ GUIDE LINE/ HISTOGRAM/ BURST/ AUDIO REC. Edges may be cut off when printing – be sure to check in advance.

Record motion pictures and sound (motion pictures cannot be recorded without sound). You can take a motion picture while zooming.

1 Set REC/PLAY switch to

2 Set mode dial to (MOTION PICTURE mode)

3 Start recording

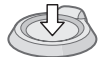

Press halfway (align focus)

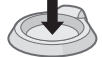

Press fully (start recording)

Available recording time (approx.)



Elapsed time (approx.)

4 Finish



Press fully

● Ends automatically if memory is full.

- Motion pictures can be recorded continuously up to 15 minutes. (DMC-TZ5 (EG/PR/E), DMC-TZ4 (EG/E))
- Motion pictures can be recorded continuously up to 2 GB. (*3 Motion pictures can be recorded continuously up to 15 minutes.) (DMC-TZ5 (PL/SG), DMC-TZ15 (GC), DMC-TZ4 (PL), DMC-TZ11 (GC))

■ Aspect and picture quality

Set 'ASPECT RATIO' (P.56) before 'PICTURE MODE'.

ASPECT RATIO	PICTURE MODE	Picture size	Dimension	
4:3	30fps VGA	640 x 480	Larger than QVGA	
	10fps VGA			
	30fps QVGA*1			
16:9	10fps QVGA*1	320 x 240	Small (For e-mail attachments or longer recording)	
	30fps 16:9H*2	1280 x 720		Large (Wide) '30fps 16:9H, 1280 x 720' is for high-definition recording
	15fps 16:9H*2			
	30fps 16:9(L)*3	848 x 480		
10fps 16:9(L)*3				

*1 Only QVGA-format motion pictures can be recorded to the built-in memory.

*2 **DMC-TZ5/DMC-TZ15 only**

You can view motion pictures in high definition by connecting with component cable (optional). (P.87)

- fps: frames per second
- '30fps': for smooth picture movement
- '10fps': for longer motion pictures
- Estimated recording time (P.100)

■ **To viewing motion pictures** → (P.68)

- Do not block microphone (P.14) with fingers.
- Release shutter button immediately after pressing. No audio will be recorded for a few seconds if the button is held down.
- Easy zoom cannot be used while recording motion pictures.
- Sounds of camera operations, such as zoom movement and beeps, may be recorded.
- Zoom speed is slower than normal.
- To fix focus setting, set 'CONTINUOUS AF' to 'OFF'.
- The following functions cannot be used. STABILIZER 'MODE2', AF MODE (Face detection), COLOR MODE (NATURAL/VIVID), Extra optical zoom, 'ROTATE DISP.' for pictures taken vertically
- Long videos may not be able to be sent via e-mail.
- Recording may be terminated midway, depending on card type.
- We recommend using a card of at least 10 MB/s (as marked on its packaging, etc.).
- Not compatible with MultiMediaCards.

TRAVEL DATE (Record travel date and destination)

Record information as to what day and where pictures were taken by setting departure dates and destinations.

Set-up: • Clock must be set in advance (P.19).

• Press 'MENU/SET' → 'SETUP MENU' → Select 'TRAVEL DATE' (P.20)

1 Select 'TRAVEL SETUP'

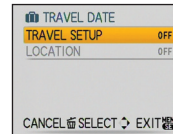

2 Select 'SET'

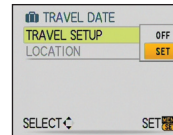

3 Set departure date

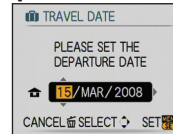

4 Set return date with

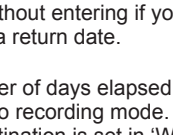

Exit without entering if you do not wish to set a return date.

5 Select 'LOCATION'

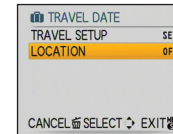

6 Select 'SET'

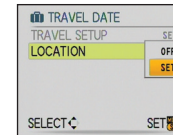

7 Enter destination

- Text input method (P.72)
- Press 'MENU/SET' twice after inputting text to complete.

■ To release

Setting is released automatically one return date has passed. To release before this date, select 'OFF' in step 2, and press 'MENU/SET' twice.

- The number of days elapsed is displayed for approx. 5 sec. when switching from playback to recording mode. (displayed at bottom-right of screen)
- When destination is set in 'WORLD TIME' (next page), days elapsed are calculated based on local destination time.
- If settings are made before holiday, number of days to departure are displayed in orange with a minus sign (but not recorded).
- When 'TRAVEL DATE' is displayed in white with a minus sign, the 'HOME' date is one day in advance of the 'DESTINATION' date (this is recorded).
- Text in 'LOCATION' can be edited after recording with 'TITLE EDIT' (P.72).
- To print travel date or destination → Use 'TEXT STAMP' (P.73), or print using supplied CD-ROM (PHOTOfunSTUDIO-viewer-).
- Names in 'BABY' and 'PET' scene modes cannot be recorded when 'LOCATION' is set.
- 'LOCATION' cannot be recorded in motion picture recording.

WORLD TIME

(Registering local time at your overseas destination)

- Set-up:** • Clock must be set in advance (P.19).
• Press 'MENU/SET' → 'SETUP MENU' → Select 'WORLD TIME' (P.20)

'PLEASE SET THE HOME AREA' will be displayed when setting for the first time. In this case, press 'MENU/SET' and skip to step 2.

■ Set home area

1 Select 'HOME'

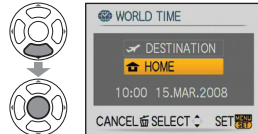

2 Set your home area



Difference with GMT (Greenwich Mean Time)
City/area name

Screen from step 1 will then be displayed only when camera is used for the first time (or has been reset).
To close menu, press 'MENU/SET' 3 times.

3 Finish



- Upon your return → Go through steps 1, 2 and 3 on the upper left, and return to the original time.

■ To set/release summer time ☼



Press ▲ in step 2. (Press again to release)

- Clock settings will not be changed even if home summer time is set. Advance the clock setting by one hour.
- Pictures recorded when set to destination will be displayed with ✈ in playback mode.

■ Set destination area

1 Select 'DESTINATION'



2 Set destination area



Difference with home time
City/area name

If actual destination is unavailable, select based on 'difference with home time'.

3 Finish



Default setting: .
'Quick setting' (P.66) is useful to easily call up frequently-used menus.

PICTURE SIZE

Set size of picture. Number of pictures which can be recorded depends on this setting and on 'QUALITY' (see below). (P.100)

- Set-up: Mode dial SCN1 SCN2 → Press 'MENU/SET' → Select 'PICTURE SIZE' (P.20)

■ Settings:

ASPECT RATIO (P.56)	Picture size			
4:3	9 M *1 (3456 ×2592)	7 M *2 (3072 ×2304)	5 M (2560 ×1920)	3 M (2048 ×1536)
	2 M (1600 ×1200)	0.3 M (640 ×480)	—	—
3:2	8.5 M *3 (3552 ×2368)	6 M *2 (3072 ×2048)	4.5 M (2560 ×1712)	2.5 M (2048 ×1360)
16:9	7.5 M *4 (3712 ×2088)	5.5 M *2 (3072 ×1728)	3.5 M (2560 ×1440)	2 M (1920 ×1080)

- Picture sizes for DMC-TZ4/DMC-TZ11 model are as follows.
*1 : 8 M (3264×2448), *2 : None, *3 : 7 M (3264×2176), *4 : 6 M (3264×1840)

- Extra optical zoom can be used for picture sizes indicated with .
- When using (INTELLIGENT AUTO mode), 7 M and 2 M may not be selected with 4:3 ratio, 6 M with 3:2 ratio, nor 5.5 M with 16:9 ratio.
- Extra optical zoom is not used in the 'HIGH SENS.', 'HI-SPEED BURST', and 'MULTI ASPECT' (DMC-TZ5/DMC-TZ15 only) scene modes.
- Mosaic effect may appear depending on subject and recording conditions.

Setting guide

Larger picture size	←→	Smaller picture size*
Crisper picture		Coarser picture
lower recording capacity		higher recording capacity

* For example, '0.3 M ' is suitable for e-mail attachments or longer recording.

QUALITY

Set quality of picture.

- Set-up: Mode dial → Press 'MENU/SET' → Select 'QUALITY' (P.20)

- Settings: Fine (High quality, priority to picture quality)
 Standard (Standard quality, priority to the number of pictures)

ASPECT RATIO

Aspect ratio of picture can be changed according to printing or playback format.

■ **Set-up:** Mode dial SCN1 SCN2 → Press 'MENU/SET' → Select 'ASPECT RATIO' (P.20)

■ **Settings:**



- Edges may be cut off when printing – be sure to check in advance.

ISO INTELLIGENT ISO

Camera automatically adjusts ISO sensitivity and shutter speed according to movement of subject to avoid blur. Higher ISO sensitivity reduces subject blur and jitter but can increase interference. Please select maximum ISO sensitivity according to table below.

■ **Set-up:** Mode dial → Press 'MENU/SET' → Select 'INTELLIGENT ISO' (P.20)

■ **Settings:** OFF / / /

Setting guide

Movement of subject	Slow	↔	Fast
ISO sensitivity	Low		High
Shutter speed	Slow		Fast
Interference	Low		High

● **Slow-moving subject**

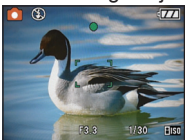

ISO sensitivity 200
(Shutter speed 1/30)

● **Fast-moving subject**

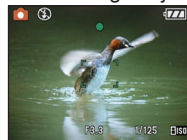

ISO sensitivity 800
(Shutter speed 1/125)

REC/PLAY switch:

- Shutter speed and ISO sensitivity are displayed in the screen for a few seconds after recording.
- If interference becomes noticeable, we recommend reducing the setting, or selecting 'NATURAL' in the 'COLOR MODE' (P.62).
- Blurring may occur depending on brightness, and size, position, and speed of movement of the subject (e.g. if subject is too small, is on edge of picture, or starts moving as soon as shutter button is pressed).
- Scope of flash recording (P.39)

ISO SENSITIVITY

Set ISO sensitivity (sensitivity to lighting) manually.
We recommend higher settings to take clear pictures in darker locations.

■ **Set-up:** Mode dial → Press 'MENU/SET' → Select 'SENSITIVITY' (P.20)

■ **Settings:** AUTO / 100 / 200 / 400 / 800 / 1600

Setting guide

SENSITIVITY	100	↔	1600
Location (recommended)	Bright (outdoors)		Dark
Shutter speed	Slow		Fast
Interference	Low		High

- AUTO: Automatically set with range up to 400 (1000 when using flash) according to brightness.
- 'I.EXPOSURE' will not operate when set to '100'.
- Scope of flash recording (P.39)
- Cannot be set when 'INTELLIGENT ISO' is used (is displayed)
- If interference becomes noticeable, we recommend reducing the setting, or selecting 'NATURAL' in the 'COLOR MODE' (P.62).

[WB] WHITE BALANCE

Adjust colouring to suit light source if colours otherwise appear unnatural.

■ **Set-up:** Mode dial SCN1 SCN2 → Press 'MENU/SET' → Select 'WHITE BALANCE' (P.20)

■ **Settings:** **AWB** (automatic) / (outdoor, clear sky) / (outdoor, cloudy sky) / (outdoor, shade) / (halogen lighting) / (uses value set in SET) / SET (set manually)

● 'AWB' operational range:

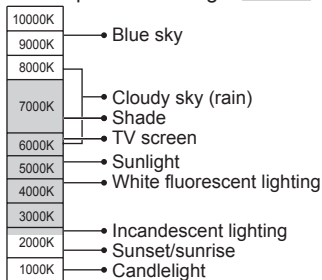

- Image may appear red or blue if out of range. This function may also not work correctly even within range if there are many light sources present.
- We recommend setting to 'AWB' or SET when under fluorescent lighting.

■ **White balance fine adjustment (excluding 'AWB')**

White balance settings can be individually fine tuned if colors still do not appear as anticipated.

- ① Press several times until 'WB ADJUST.' is displayed.
- ② Adjust with if reds are strong, adjust with if blues are strong.
- ③ Press 'MENU/SET'.
 - Settings are remembered even if power is turned off.
 - Settings remain applied when using flash.
 - Even though the 'AWB' setting is fixed in 'UNDERWATER' scene mode, fine adjustments may still be made.
 - Fine adjustments cannot be made when 'COLOR MODE' (P.62) is set to 'B/W', 'SEPIA', 'COOL', or 'WARM'.

Changes to red (blue) when making fine adjustment

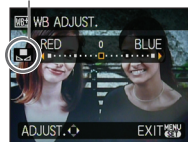

■ **Setting white balance manually** (SET)

- ① Select SET and press 'MENU/SET'.
- ② Point the camera towards a white object (e.g. paper) and press 'MENU/SET'.
- ③ Press 'MENU/SET' twice.
 - Making this setting will reset white balance fine adjustment.

Only takes image of white objects within frame (step ②)

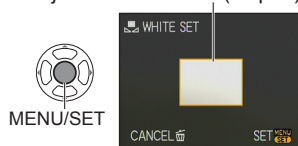

REC/PLAY switch:

[METERING] METERING MODE

You can change the position for measuring brightness when correcting exposure.

■ **Set-up:** Mode dial → Press 'MENU/SET' → Select 'METERING MODE' (P.20)

■ **Settings:**

	Brightness measurement position	Conditions
Multiple	Whole screen	Normal usage (produces balanced pictures)
Centre weighted	Centre and surrounding area	Subject in centre
Spot	Centre and close surrounding area 	Great difference between brightness of subject and background (e.g. person in spotlight on stage, backlighting)

[AF] AF MODE

Method of aligning focus can be changed according to position and number of subjects.

■ **Set-up:** Mode dial SCN1 SCN2 → Press 'MENU/SET' → Select 'AF MODE' (P.20)

■ **Settings:** / / / (H: High-speed focus)

<p>Taking front-on pictures of people</p> <p> Face detection</p>	<p>Recognises faces (up to 15 people) and adjusts exposure and focus accordingly. (When set to 'Multiple' above)</p> <p></p> <p>AF area Yellow: When the shutter button is pressed halfway, the frame turns green when the camera is focused. White: Displayed when more than one face is detected. Other faces that are the same distance away as faces within the yellow AF area are also focused.</p>
<p>Subject not in centre of picture (AF area displayed after focuses completely aligned)</p> <p> 9-area-focusing 3-area-focusing (High speed)</p>	<p>9-area-focusing: Automatically focuses on any of 9 points.</p> <p></p> <p>3-area-focusing (High speed): Automatically focuses on either side or centre.</p> <p></p> <p>AF area</p>

Determined position for focus <input type="checkbox"/> 1-area-focusing (High speed) <input type="checkbox"/> 1-area-focusing <input type="checkbox"/> Spot-focusing	1-area-focusing (High speed)/ 1-area-focusing: Focuses on AF area in centre of picture. (Recommended for when focus is difficult to align)	Spot-focusing: Focuses on smaller, limited area.

- When using or , picture may freeze momentarily before focus is aligned.
- AF area becomes larger in dark locations or when using digital zoom, etc.
- Use or if focus is difficult to align with .
- Cannot set to 'Face detection' in the following cases.
'NIGHT SCENERY', 'FOOD', 'STARRY SKY', 'FIREWORKS', 'AERIAL PHOTO', 'UNDERWATER' scene modes, (MOTION PICTURE mode)
- If the camera detects subjects other than a person as the face, switch the AF mode setting to any modes other than 'face detection'.
- The face detection function may fail to work under the following conditions. (AF mode setting is switched to)
 - When the face is not facing the camera or at an angle
 - When the facial features are hidden behind sunglasses, etc.
 - When the face is extremely bright or dark
 - When the face appears small on the screen
 - When there is rapid movement
 - When the camera is shaking
 - When the subject is other than a human being such as pets
 - When digital zoom is used

CONTINUOUS AF

Focus is continually aligned according to movement of subject even when shutter button is not pressed. (Increases battery consumption)

■ **Set-up:** Mode dial → Press 'MENU/SET' → Select 'CONTINUOUS AF' (P.20)

■ **Settings:** **OFF** / **ON** (displayed on screen)

- Focus alignment may take time if zoom is suddenly changed from max. W to max. T, or if suddenly moving closer to subject.
- Press shutter button halfway if focus is difficult to align.
- When using , , or 'AF MODE', focus will be aligned quickly when shutter button is pressed halfway.

BURST

Enables a rapid succession of photographs to be taken. Succession of photographs taken while shutter button is held down.

■ **Set-up:** Mode dial → Press 'MENU/SET' → Select 'BURST' (P.20)

■ Settings

BURST setting	Speed	No. of pictures *1
OFF		No burst
(Burst)	2.5 pictures/sec. (DMC-TZ5/ DMC-TZ15) 3 pictures/sec. (DMC-TZ4/ DMC-TZ11)	Fine: Max. 3 (Max.4: DMC-TZ4/DMC-TZ11) Standard: Max. 5 (Max.7: DMC-TZ4/DMC-TZ11)
(Free)	Approx. 2 pictures/sec *2	Until card/built-in memory is full

*1 : When using self-timer: Fixed at 3 pictures

*2 : **Becomes progressively slower.** (Delayed timing depends on card type, PICTURE SIZE, and QUALITY.)

- Focus is fixed from first picture.
- When (Burst) is selected, the exposure and white balance are fixed to the settings for the first picture.
- When is selected, exposure and white balance is adjusted for each picture.
- Burst speed may be reduced if 'SENSITIVITY' is set to high, or if shutter speed is reduced in darker locations.
- When burst setting is use, flash is prevented from operating, and auto bracket setting is cancelled.
- Settings will be stored even if power is turned off.
- When using BURST while following a moving subject in locations with major differences in brightness (e.g. indoor to outdoor), exposure stabilization may require a little time, and optimal exposure may not be achieved.
- Auto review performed regardless of 'AUTO REVIEW' setting.
- Using the 'HI-SPEED BURST' scene mode allows a faster succession of photographs to be taken (P.49).

I.EXPOSURE

Automatically adjusts contrast and exposure to give more lifelike colours when there is significant contrast between background and subject.

■ **Set-up:** Mode dial → Press 'MENU/SET' → Select 'I.EXPOSURE' (P.20)

■ **Settings:** **OFF** / **ON** (displayed on screen)

- When set to 'ON', 'SENSITIVITY' of '100' becomes 'AUTO'.

 DIGITAL ZOOM

Multiplies effect of optical zoom or extra optical zoom by up to 4 times. (See P.34 for details)

■ **Set-up:** Mode dial  → Press 'MENU/SET' → Select 'DIGITAL ZOOM' (P.20)



■ **Settings:** OFF / ON

 COLOR MODE

Set colour effects.

■ **Set-up:** Mode dial   → Press 'MENU/SET' → Select 'COLOR MODE' (P.20)

■ **Settings:** STANDARD / NATURAL (soft) / VIVID (sharp) / B/W / SEPIA / COOL (more blue) / WARM (more red)



- If interference is noticeable in dark locations: Set to 'NATURAL'.
- Cannot be set to 'COOL' and 'WARM' in  (INTELLIGENT AUTO mode), and 'NATURAL' and 'VIVID' in  (MOTION PICTURE mode).
- Individual settings can be made for each recording mode.



 STABILIZER

Automatically detects and prevents jitter.

■ **Set-up:** Mode dial   → Press 'MENU/SET' → Select 'STABILIZER' (P.20)

■ **Settings:**

Settings		Effect
OFF		Pictures deliberately taken with no jitter correction
MODE1		Constant correction (Monitor image stable, composition easy to determine)
MODE2		Correction at moment shutter button is pressed (More effective than MODE1)

- Setting fixed to 'MODE2' in 'SELF PORTRAIT' and 'OFF' in 'STARRY SKY' scene modes.
- Cannot be set to 'OFF' in  (INTELLIGENT AUTO mode), and 'MODE2' in  (MOTION PICTURE mode).
- Cases where optical image stabilizer may be ineffective:
Heavy jitter, high zoom ratio, fast-moving objects, indoors or in dark locations (due to low shutter speed)



REC/PLAY switch: 

 MIN. SHTR SPEED

Sets shutter speed to minimum. We recommend using slower shutter speeds to take brighter pictures in dark locations.

■ **Set-up:** Mode dial  → Press 'MENU/SET' → Select 'MIN. SHTR SPEED' (P.20)

■ **Settings:** 1/200 1/125 1/60 1/30 1/15 1/8 1/4 1/2 1



- Slower shutter speeds allow for brighter pictures but increase risk of jitter, so we recommend using a tripod and the self-timer.
- As pictures may become dark when using faster values such as '1/200', we recommend that pictures are taken in bright locations ( flashes red when shutter button is half-pressed if picture will be dark).
-  displayed on screen for settings other than '1/8'.
- Cannot be set when 'INTELLIGENT ISO' is used. (P.56)

 AUDIO REC.

Sounds can also be recorded with pictures. This is useful for conversation or memo recording.

■ **Set-up:** Mode dial  → Press 'MENU/SET' → Select 'AUDIO REC.' (P.20)

■ **Settings:** OFF / ON (Record approx. 5 seconds of sound ( displayed on screen))

- To cancel recording → Press 'MENU/SET'.
- To play audio → set REC/PLAY switch to  (play), play image, and press ▲.
(To adjust volume → 'VOLUME' (P.23))
- Cannot be used with  (INTELLIGENT AUTO mode), 'BURST', 'AUTO BRACKET', or the 'STARRY SKY', 'HI-SPEED BURST', and 'MULTI ASPECT (DMC-TZ5/DMC-TZ15 only)' scene modes.
- 'TEXT STAMP', 'RESIZE', 'TRIMMING', and 'ASPECT CONV.' cannot be used with pictures with audio.
- Separate setting to 'AUDIO REC' in CLIPBOARD menu (P.65).
- Do not block microphone (P.14) with fingers.

AF* AF ASSIST LAMP

Illuminates lamp when dark to facilitate focus alignment.

■ **Set-up:** Mode dial  → Press 'MENU/SET' → Select 'AF ASSIST LAMP' (P.20)

■ **Settings:** OFF: Lamp off (taking pictures of animals in dark, etc.)

ON : Lamp illuminated with halfway press of shutter button ( and larger AF area displayed)

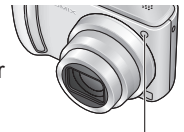

Lamp: Effective distance: 1.5 m (Do not cover or look at lamp from close range)

 CLOCK SET

Set the clock. Same function as that in SETUP menu (P.19).

11 Taking/viewing clipboard pictures (CLIPBOARD)

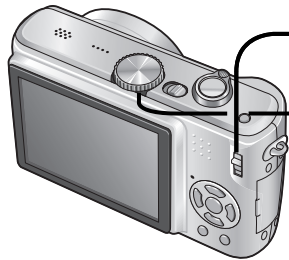

1 Set to

2 Set to (clipboard)



3 Take a clipboard picture



Press halfway (align focus)



Press fully (take picture)

● Represents built-in memory used entirely for clipboard pictures (approx.)

Picture size	2 M	1 M
Pictures	97	146

Viewing clipboard pictures

1 Set REC/PLAY switch to

2 Set mode dial to (CLIPBOARD mode)

- Can be viewed with same operations as with still pictures taken in other modes (P.35). (30-picture and calendar displays cannot be used.)
- Copy clipboard pictures onto memory cards in order to print (next page).

■ To delete clipboard pictures ➡ Press (delete) in step 2 above. (P.36)

■ If internal memory is full ➡

Non-clipboard pictures can be deleted from the internal memory by removing card from camera, setting mode dial to a setting other than (CLIPBOARD mode), and pressing (delete).

- Playback mode functions cannot be used.
- 'STABILIZER' setting made in REC menu will be reflected in clipboard mode.
- Functions unavailable: INTELLIGENT ISO, METERING MODE, I.EXPOSURE, MIN. SHTR SPEED BURST, DIGITAL ZOOM, AUTO BRACKET, WB ADJUST., CONTINUOUS AF, COLOR MODE, AUTO LCD OFF, HISTOGRAM
- The settings for the following functions are fixed.

QUALITY	(Standard)	SENSITIVITY	AUTO	AF ASSIST LAMP	ON
ASPECT RATIO		WHITE BALANCE	AWB	GUIDE LINE	
		AF MODE	(1-area-focusing)	POWER SAVE	5MIN.

Useful for taking pictures of timetables and maps instead of taking memos. Regardless of presence of card, pictures will always be saved to clipboard folder of built-in memory, so that they can be distinguished from normal pictures and viewed immediately. **Beware of copyrights, etc. (P.2)**

Zoom mark

Useful for enlarging and saving parts of maps, etc.

■ To register zoom enlarged size and position

- ① Enlarge with zoom lever and select position with

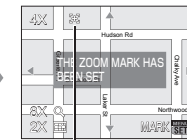

Zoom mark
Displayed on registered pictures

- To change zoom and position: Repeat the left
- To finish zoom mark setting: Restore zoom to original (1 x) ratio

■ To view registered ratio and position:

- ① Display picture with
- ② Turn to T side (No need to manually enlarge or move)



Immediately displayed at recorded size and position



- To cancel zoom mark → 'CANCEL MARK' (below)

- When a picture with a zoom mark is deleted, both original picture and picture with zoom mark will be deleted.
- Picture can be deleted even while zoomed in.

CLIPBOARD menu

A special menu is used in CLIPBOARD mode. (Default setting:)

REC ON CLIPBOARD menu (REC/PLAY switch: Mode dial:)

PICTURE SIZE	2 M (Priority to picture quality) / 1 M (Priority to the number of pictures)
AUDIO REC.	Record sound (5 seconds) simultaneously. / ON
LCD MODE	OFF / AUTO POWER LCD / POWER LCD / HIGH ANGLE (P.22)
CLOCK SET	(P.19)

PLAY ON CLIPBOARD menu (REC/PLAY switch: Mode dial:)

CANCEL MARK	① Select , marked clipboard picture with . ② Cancel with 'MENU/SET'.
AUDIO DUB.	Add sound to previously-taken clipboard picture. ① Select clipboard picture with . ② Record/stop with 'MENU/SET'. (P.79)
COPY	Copy single pictures from clipboard to card. (Zoom mark will not be copied.) ① Select clipboard picture with and press 'MENU/SET' ② Select 'YES' with and press 'MENU/SET'.
LCD MODE	OFF / POWER LCD (P.22)

12 Quick setting

REC menu items can be called up easily (settings items displayed vary depending on recording mode).

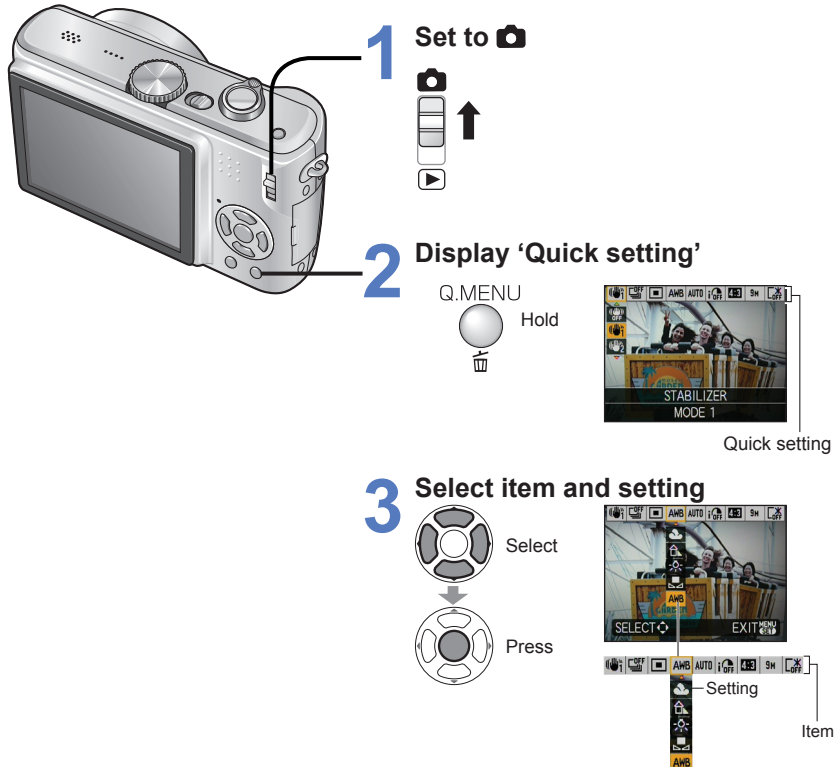

● Example) NORMAL PICTURE mode

- STABILIZER*1 (P.62)
- WHITE BALANCE (except SET) (P.58)
- I.EXPOSURE (P.61)
- ASPECT RATIO*4 (P.56)
- BURST (P.61)
- INTELLIGENT ISO*2 (P.56)
- PICTURE SIZE (P.55)
- AF MODE (P.59)
- SENSITIVITY*3 (P.57)
- LCD MODE (P.22)

*1 Press [DISPLAY] while 'STABILIZER' is displayed to view demo of jitter/movement detection.

*2 Only when 'INTELLIGENT ISO' is selected

*3 Only when 'INTELLIGENT ISO' is set to 'OFF'

*4 DMC-TZ5/DMC-TZ15 only

1 Viewing as list
(Multi playback/Calendar playback)

You can view 12 (or 30) pictures at once (multi playback), or view all pictures taken on a certain date (calendar playback).

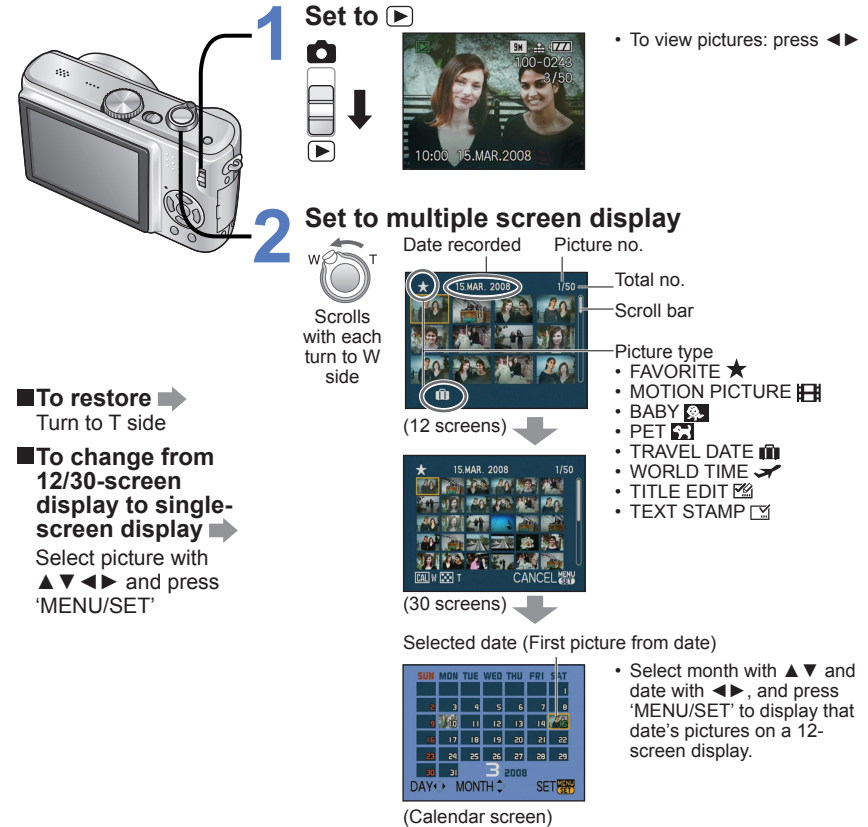

● Only one month of pictures is displayed on calendar screen. Pictures taken without clock settings are displayed with a date of 1 January, 2008.

● Cannot be displayed rotated.

● Pictures taken with destination settings made in 'WORLD TIME' are displayed in the calendar screen using the appropriate date for the destination's time zone.

2 Viewing motion pictures · pictures with audio / Creating still pictures from motion pictures

Set-up: REC/PLAY switch: (Set mode dial to any except)

1 Select and play picture

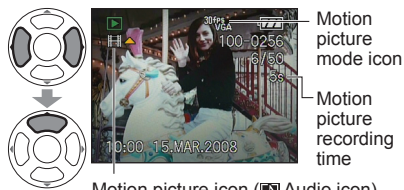

■ Operations during motion picture playback

- : Pause/play
- : Stop
- : Hold to fast rewind (single frame step while paused)
- : Hold to fast forward (single frame step while paused)
- Volume can be adjusted with zoom lever (motion picture only).

- Motion pictures and pictures with audio can be deleted in the same way as for still pictures (P.36).

Creating still pictures from motion pictures (DMC-TZ5/DMC-TZ15 only)

- ① During playback, pause at desired moment
- ② Create still picture
- ③ Select 'YES' and set



A still picture is created.

■ To make single picture from 9 surrounding frames

→ Press 'MENU/SET' between steps ① and ② above to set to 9-screen display (Press again to return to one-screen display)

Zoom lever



Turn to W side (No. of Frames/sec changes with each turn)

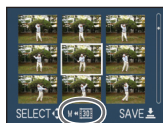

- To advance by 3 frames:
- To advance by 1 frame:

Frames/sec

Frame rate can be changed according to the speed of subject movement.
 Scenes with fast movement: Increase frame rate (e.g. 30fps)
 Scenes with slow movement: Reduce frame rate (e.g. 10fps, 5fps)

Frames/sec

PICTURE MODE			Frames/sec
30fps QVGA	30fps VGA	30fps 16:9L	30 → 15 → 10 → 5
30fps 16:9H			
15fps 16:9H			15 → 5
10fps QVGA	10fps VGA	10fps 16:9L	10 → 5

- The quality of still pictures created from motion pictures is fixed as (standard), with resolutions set according to the table.

- Pictures taken on other devices may not be played back correctly.
- When using a high capacity card, it is possible that fast rewinding may be slower than usual.
- Playback zoom cannot be used during motion picture playback/pausing or audio playback.
- The file format is QuickTime Motion JPEG. Pictures can be viewed using 'QuickTime' on the CD-ROM (supplied).

PICTURE MODE		1 screen	9 screens
30fps VGA	10fps VGA	0.3 M	2 M
30fps QVGA	10fps QVGA	0.3 M	1 M
30fps 16:9L	10fps 16:9L	2 M	2 M
30fps 16:9H	15fps 16:9H		

3 Different playback methods

REC/PLAY switch: (Set mode dial to any except)

- Various playback modes for your pictures.
- Pictures will be selected from built-in memory (not clipboard) if no card is inserted.
- Playback mode is automatically set to 'NORMAL PLAY' when power is turned on with REC/PLAY switch set to , or when switching from REC mode to playback mode.

NORMAL PLAY

Displays one picture. (Default setting)

Set-up: Press 'MENU/SET' → Select 'NORMAL PLAY' (P.20)

12 DUAL PLAY (DMC-TZ5/DMC-TZ15 only)

Displays different 2 pictures vertically. Useful for comparing pictures.

Set-up: Press 'MENU/SET' → Select 'DUAL PLAY' (P.20)

Selected pictures outlined in orange

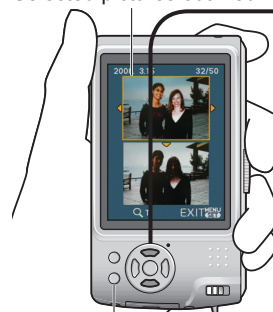

Hold camera vertically

Delete selected picture.

1 Select screen



2 Select picture



Previous picture Next picture

Reduce Expand

Display zoom position for 1 sec.

- Same picture cannot be displayed in DUAL PLAY.

3 Different playback methods (Continued)

SLIDE SHOW

Automatically play pictures in order and to music. Recommended for when viewing on TV screen.

Set-up: Press 'MENU/SET' → Select 'SLIDE SHOW' (P.20)

1 Select playback method

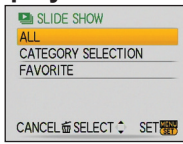
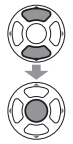

- **ALL** : Play all
- **CATEGORY SELECTION** : Select category, and playback slideshow. (Select category with ▲▼◀▶ and press 'MENU/SET'.) (P.71)
- **FAVORITE** : Play pictures set as FAVORITE (P.77) (displayed only when 'FAVORITE' pictures present and setting set to 'ON').

2 Set playback effects (see below)

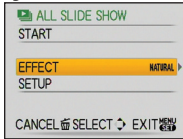
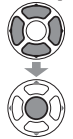

Operations during slide show

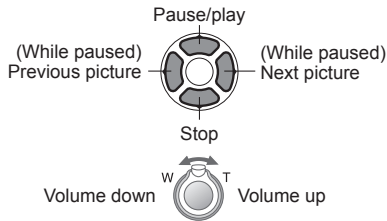

3 Select 'START'

- Press to return to menu screen during slide show

EFFECT (Select music and effects according to picture atmosphere)	
AUTO	Camera selects optimum effect from NATURAL, SLOW, SWING, and URBAN (only available with 'CATEGORY SELECTION' setting)
NATURAL	Play with relaxed music and screen transition effects
SLOW	Play with livelier music and screen transition effects
SWING	Play with livelier music and screen transition effects
URBAN	Play with livelier music and screen transition effects
OFF	No effects

SETUP	
DURATION	1 SEC. / 2 SEC. / 3 SEC. / 5 SEC. Only available when 'EFFECT' is 'OFF'
REPEAT	OFF/ON (Repeat)
MUSIC* (AUDIO)	OFF/ON (Play MUSIC (AUDIO)) Audio from still pictures with audio is played when 'EFFECT' is 'OFF'.

* Item name changes to 'AUDIO' when 'EFFECT' is 'OFF'

- When 'URBAN' has been selected, the picture may appear in black and white as a screen effect.
- Certain playback effects cannot be used when displaying images on television using component cables.
- Motion pictures cannot be played back in slide show.
- Music effects cannot be added.

REC/PLAY switch: (Set mode dial to any except)

CATEGORY PLAY

Pictures can be classified automatically and viewed by category. Automatic classification starts when 'CATEGORY PLAY' is selected from the playback mode selection menu.

Set-up: Press 'MENU/SET' → Select 'CATEGORY PLAY' (P.20)

1 Select the category

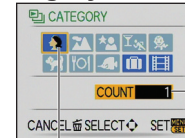

Icons of categories with pictures (dark blue)
No. of pictures (appears after a few seconds)

2 View pictures



Previous Next

- To delete pictures → Press (delete).

- 30-picture and calendar displays cannot be used.
- Still pictures created from motion pictures cannot be classified into MOTION PICTURE. (DMC-TZ5/DMC-TZ15 only)
- The following playback menus can be set only for categorized pictures. (P.76, 78, 79) 'ROTATE', 'ROTATE DISP.', 'DPOF PRINT', 'PROTECT', 'AUDIO DUB.'
- To close 'CATEGORY PLAY', select 'NORMAL PLAY'.

CATEGORY	Recording information such as scene modes
(Portrait etc.)	PORTRAIT/ i-PORTRAIT/ SOFT SKIN/ SELF PORTRAIT/ NIGHT PORTRAIT/ i-NIGHT PORTRAIT/ BABY
(Scenery etc.)	SCENERY/ i-SCENERY/ SUNSET/ AERIAL PHOTO
(Night scenery etc.)	NIGHT PORTRAIT/ i-NIGHT PORTRAIT/ NIGHT SCENERY/ i-NIGHT SCENERY/ STARRY SKY
(Event)	SPORTS/ PARTY/ CANDLE LIGHT/ FIREWORKS/ BEACH/ SNOW/ AERIAL PHOTO
	BABY
	PET
	FOOD
	UNDERWATER
	TRAVEL DATE (Clipboard pictures taken with travel date setting are not categorized.)
	MOTION PICTURE

★ FAVORITE PLAY

Manually play pictures set in 'FAVORITE' (P.77) (displayed only when 'FAVORITE' pictures present and setting set to 'ON').

Set-up: Press 'MENU/SET' → Select 'FAVORITE PLAY' (P.20)

1 View pictures



Previous Next

- 30-picture and calendar displays cannot be used.
- The following playback menus can be set only for favorite pictures (P.76, 78, 79) 'ROTATE', 'ROTATE DISP.', 'DPOF PRINT', 'PROTECT', 'AUDIO DUB.'
- To close 'FAVORITE PLAY', select 'NORMAL PLAY'.

4 Using PLAYBACK menu

CALENDAR

Select date from calendar screen to view only the pictures taken on that day (P.67).
Set-up: Press 'MENU/SET' → 'PLAYBACK menu' → Select 'CALENDAR' (P.20)
 ● Cannot be set in 'CATEGORY PLAY' or 'FAVORITE PLAY' playback modes (P.71).

TITLE EDIT

You can edit names from 'BABY' and 'PET' scene modes or destination in 'TRAVEL DATE', or give titles to your favourite pictures.

Set-up: Press 'MENU/SET' → 'PLAYBACK menu' → Select 'TITLE EDIT' (P.20)

1 Select 'SINGLE' or 'MULTI' and set

2 Select picture

● SINGLE

● MULTI (up to 50 pictures with the same text)

● TITLE EDIT setting

● TITLE EDIT already set

- To cancel → Press [DISPLAY] again
- To set → Press 'MENU/SET'.

3 Enter characters

Text input method

- 1 Press display button several times to select character type (Upper case, lower case, symbols/numbers)
- 2 Select characters with ▲▼◀▶, and press 'MENU/SET' (repeat)
- 3 Select 'EXIT' with ▲▼◀▶, and press 'MENU/SET'

- A maximum of 30 characters can be entered.
- Input cursor may be moved with the zoom lever.
- Text will be scrolled if title does not fit on screen.

(Press [MENU/SET] when finish setting to return to the menu screen in 'SINGLE' setting.)

REC/PLAY switch: [▶] (Set mode dial to any except [M])

■ **To edit** → select 'SINGLE' in step 1 → select picture with ◀▶, and press 'MENU/SET' → correct text and press 'EXIT'

- Cannot be set in 'CATEGORY PLAY' or 'FAVORITE PLAY' playback mode (P.71).
- Cannot be used with pictures taken on other devices, protected pictures, or motion pictures.
- To print text, use 'TEXT STAMP' (below) or the supplied CD-ROM (PHOTOfunSTUDIO-viewer-).

TEXT STAMP

Stamp recording date or text registered in the 'BABY' and 'PET' scene modes, 'TRAVEL DATE', or 'TITLE EDIT' into your pictures. Ideal for regular size printing.

Set-up: Press 'MENU/SET' → 'PLAYBACK menu' → Select 'TEXT STAMP' (P.20)

1 Select 'SINGLE' or 'MULTI' and set

2 Select picture

● SINGLE

● MULTI (up to 50 pictures)

● TEXT STAMP setting

- To cancel → Press display button again.
- To set → Press 'MENU/SET'.

3 Select items and make settings for each

Select 'ON' to stamp

- To stamp inputted texts such as names in 'BABY' and 'PET' scene modes, destination in 'TRAVEL DATE', or a title in 'TITLE EDIT', set 'TITLE' setting to 'ON'.

4 Select 'YES'

(Screen varies according to picture size, etc.)

- Stamped text cannot be deleted.
- Press [MENU/SET] when finish setting to return to the menu screen in 'SINGLE' setting.

4 Using PLAYBACK menu (Continued)

■ To check stamped text ➔ 'playback zoom' (P.35)

- Picture size will be reduced if greater than 3M. Picture will become slightly grainier.
- Cannot be used with pictures taken on other devices, pictures taken without setting clock, motion pictures, or pictures with audio.
- After TEXT STAMP is applied, pictures cannot be resized or trimmed, and 'ASPECT CONV.', 'TEXT STAMP' and DPOF date printing settings cannot be changed of pictures.
- Characters may be cut off on certain printers.
- Cannot be set in 'CATEGORY PLAY' or 'FAVORITE PLAY' playback mode (P.71).
- Do not make date printing settings in shop or on printer for pictures with date stamps. (Date printing may be overlapping.)

ASPECT RATIO	PICTURE SIZE	After TEXT STAMP
4 : 3	9 M*1, 8 M*2, 7 M*1, 5 M	3 M
3 : 2	8.5 M*1, 7 M*2, 6 M*1, 4.5 M	2.5 M
16 : 9	7.5 M*1, 6 M*2, 5.5 M*1, 3.5 M	2 M





*1 : DMC-TZ5/DMC-TZ15 only
*2 : DMC-TZ4/DMC-TZ11 only

🖼️ RESIZE

Picture size can be reduced to facilitate e-mail attachment and use in homepages, etc. (Picture of minimum picture size for each aspect setting cannot be resized.)

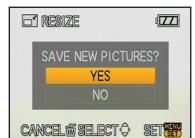

Set-up: Press 'MENU/SET' ➔ '▶️ PLAYBACK menu' ➔ Select 'RESIZE' (P.20)

■ SINGLE

- 1 Select 'SINGLE'**

 - 2 Select picture**

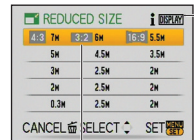
 - 3 Select size**

 - 4 Select 'YES'**

- Press  when finish setting to return to the menu screen

REC/PLAY switch:  (Set mode dial to any except )

■ MULTI



- 1 Select 'MULTI' in step 1 on the left page**
- 2 Select size**

To see description of resize: Press display button
Select number of pixels after resizing
- 3 Select picture (up to 50 pictures)**

Number of pixels before/after resizing
• To cancel ➔ Press display button again.
• To set ➔ Press 'MENU/SET'.
- 4 Select 'YES' and set**

- Picture quality is reduced after resizing.
- Cannot be set in 'CATEGORY PLAY' or 'FAVORITE PLAY' playback mode (P.71).
- Cannot be used with motion pictures, pictures with audio, or pictures with text stamp. May not be compatible with pictures taken on other devices.

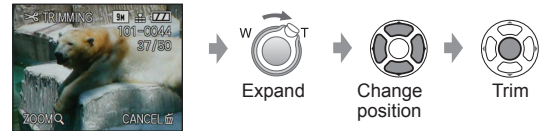
✂️ TRIMMING

Enlarge your pictures and trim unwanted areas.

Set-up: Press 'MENU/SET' ➔ '▶️ PLAYBACK menu' ➔ Select 'TRIMMING' (P.20)

- 1 Select picture with ◀️▶️ and set**
- 2 Select area to trim**

- 3 Select 'YES' and set**
• Press  when finish setting to return to the menu screen

- Picture quality is reduced after trimming.
- Cannot be set in 'CATEGORY PLAY' or 'FAVORITE PLAY' playback mode (P.71).
- Cannot be used with motion pictures, pictures with audio, or pictures with text stamp. May not be compatible with pictures taken on other devices.

4 Using PLAYBACK menu (Continued)

ASPECT CONV.

Convert pictures taken in **16:9** to **3:2** or **4:3** for printing.

Set-up: Press 'MENU/SET' → '▶ PLAYBACK menu' → Select 'ASPECT CONV.' (P.20)

1 Select 3:2 or 4:3



2 Select picture



3 Select horizontal position and convert

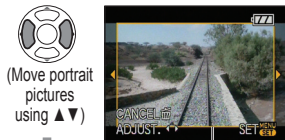

(Move portrait pictures using ▲▼)

Changes to outlined size

4 Select 'YES' and set

• Press when finish setting to return to the menu screen

- Picture size may be increased after aspect ratio is changed.
 - Cannot be set in 'CATEGORY PLAY' or 'FAVORITE PLAY' playback mode (P.71).
 - Cannot be used with motion pictures, pictures with audio, pictures with text stamp, or non-DCF files (P.35).
- May not be compatible with pictures taken on other devices.

ROTATE

Manually rotate pictures by 90°.

Set-up: Press 'MENU/SET' → '▶ PLAYBACK menu' → Select 'ROTATE DISP.: 'ON' → 'ROTATE' (P.20)

1 Select picture with ◀▶ and set

2 Select direction to rotate



• Press when finish setting to return to the menu screen

ROTATE DISP.

Automatically rotate portrait pictures.

Set-up: Press 'MENU/SET' → '▶ PLAYBACK menu' → Select 'ROTATE DISP.' (P.20)

1 Select 'ON'

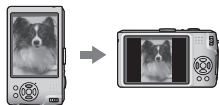
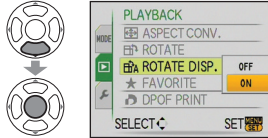

REC/PLAY switch: (Set mode dial to any except)

- 'ROTATE DISP.' and 'ROTATE' cannot be used with motion pictures.
- 'ROTATE' cannot be used with protected pictures (P.79).
- Some pictures taken facing up or facing down may not be rotated automatically. It may not be possible to rotate pictures taken with certain other devices.
- Pictures cannot be rotated during multi playback.
- Will only be displayed rotated on computer if in Exif-compatible (P.35) environment (OS, software).

★ FAVORITE

Mark your favourite pictures and enable the following functions.

- Favourites-only slide show (P.70)
- Delete all except favourites (useful for when printing in shop, etc.)

Set-up: Press 'MENU/SET' → '▶ PLAYBACK menu' → Select 'FAVORITE' (P.20)

1 Select 'ON'

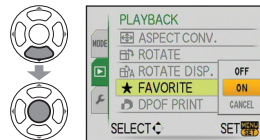

2 Close menu



3 Select picture (repeat)

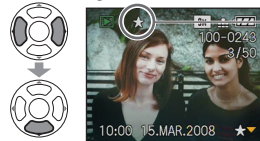

displayed when set (not displayed when 'OFF').

- Up to 999 pictures can be selected.
- To release → Press ▼ again.

■ To release all → Select 'CANCEL' in step 1 and select 'YES'.

- Cannot be set in 'FAVORITE PLAY' playback mode (P.71).
- It may not be possible to set pictures taken with certain other devices as favourites.
- Setting/release can also be made with supplied software (PHOTOfunSTUDIO-viewer-).

DPOF PRINT

Picture/picture no./date printing settings can be made for when printing with DPOF print-compatible shops or printers. (Ask at shop to check compatibility)

Set-up: Press 'MENU/SET' → '▶ PLAYBACK menu' → Select 'DPOF PRINT' (P.20)

1 Select 'SINGLE' or 'MULTI'

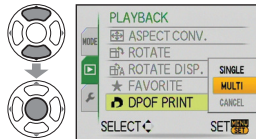

2 Select picture



MULTI

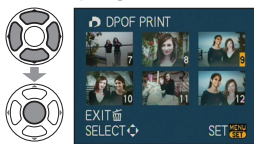

3 Set number of pictures

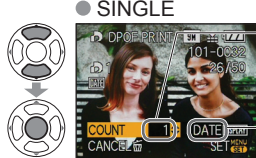

No. to print

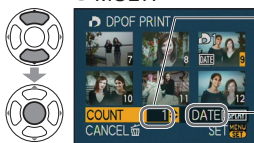

No. to print

- Date print setting/release → Press display button.
- Press when finish setting to return to the menu screen

■ **To release all** → Select 'CANCEL' in step 1 and select 'YES'.

- When using PictBridge-compatible printers, check settings on actual printer as these may take priority over camera settings.
- To print from built-in memory at a shop, first copy pictures to card (P.80) before making settings.
- DPOF print settings may not be made to non-DCF (P.35) files.
- Some DPOF information set by other equipment cannot be used. In such cases, delete all of the DPOF information and then set it again with this camera.
- Date printing settings cannot be made for pictures with a 'TEXT STAMP' applied. These settings will also be cancelled if a 'TEXT STAMP' is applied later.

REC/PLAY switch: (Set mode dial to any except)

PROTECT

Set protection to disable picture deletion. Prevents deletion of important pictures.

Set-up: Press 'MENU/SET' → '▶ PLAYBACK menu' → Select 'PROTECT' (P.20)

1 Select 'SINGLE' or 'MULTI'

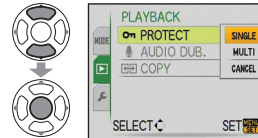

2 Select picture and make setting

● SINGLE

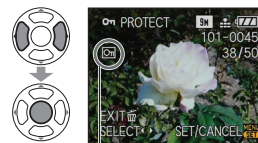

Picture protected

● MULTI

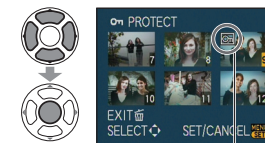

Picture protected

- To cancel → Press 'MENU/SET' again.
- Press when finish setting to return to the menu screen

■ **To release all** → Select 'CANCEL' in step 1 and select 'YES'.

■ **To cancel while releasing all** → Press 'MENU/SET'.

- May not be effective when using other devices.
- Formatting will cause even protected files to be deleted.

AUDIO DUB.

Add audio to previously taken pictures.

Set-up: Press 'MENU/SET' → '▶ PLAYBACK menu' → Select 'AUDIO DUB.' (P.20)

1 Select image and start recording

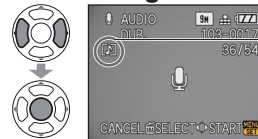

For files already containing audio, select whether or not to overwrite existing audio with , and press 'MENU/SET'.

- To cancel → Press

Do not block microphone with fingers.



2 Stop recording (Recording will automatically end after 10 seconds.)



- Press when finish setting to return to the menu screen

- Cannot be used with motion pictures or protected pictures.
May not be compatible with pictures taken on other devices.

4 Using PLAYBACK menu (Continued)

COPY

Copy between built-in memory and memory card, or from memory card to clipboard folder.

Set-up: Press 'MENU/SET' → '▶ PLAYBACK menu' → Select 'COPY' (P.20)

1 Select copy method (direction)

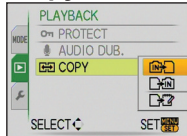
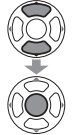

- : Copy all pictures from built-in memory to card (go to step 3)
(Clipboard pictures cannot be copied. Use 'COPY' in the clipboard menu (P.65).)
- : Copy 1 picture at a time from card to built-in memory.
- : Copy 1 picture at a time from card to clipboard folder (in built-in memory) (not motion pictures).

2 Select picture with ◀▶ and set (for and)

3 Select 'YES'

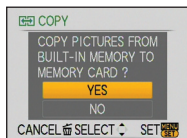
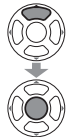

- To cancel → Press 'MENU/SET'
- Press when finish setting to return to the menu screen

(Screen shown is example)

- If there is not enough space on the built-in memory for copying to be performed, turn off the power, remove the card, and delete pictures from the built-in memory (to delete clipboard pictures, set the mode dial to clipboard mode).
- To copy to a card, use a card with a capacity of at least 50 MB.
- Copying pictures may take several minutes. Do not turn off power or perform other operations during copying.
- If identical names (folder/file numbers) are present in the copy destination, a new folder for copying will be created when copying from built-in memory to card (). Identically-named files will not be copied from card to built-in memory ().
- DPOF settings will not be copied.
- Only pictures from Panasonic digital cameras may be copied.
- Original pictures will not be deleted after copying (to delete pictures → P.36).
- Cannot be set in 'CATEGORY PLAY' or 'FAVORITE PLAY' playback mode (P.71).

1 Using with your PC

Connect the camera to your computer to save, play, print, and e-mail your pictures.

Set-up:

- **Connect the camera to the AC adaptor** (optional).
(Alternatively, use a sufficiently-charged battery.)
- Card : Insert card and set mode dial to any except
- Built-in memory : Remove card

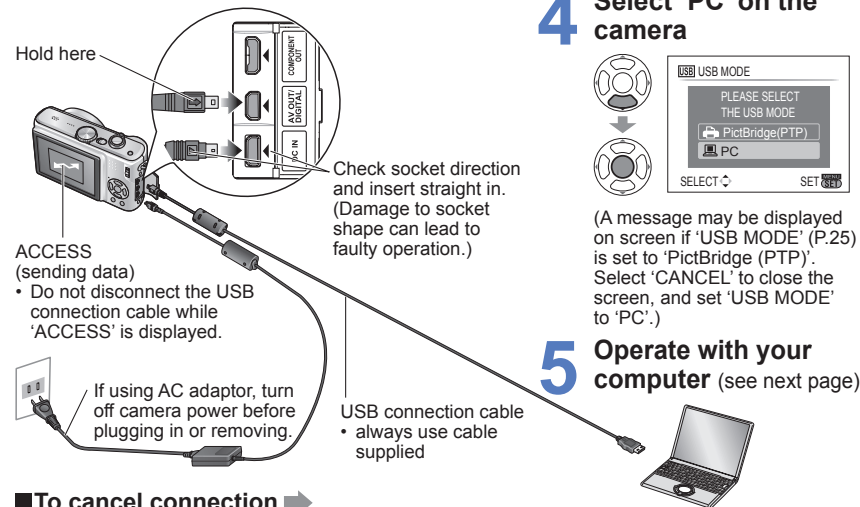

■ To cancel connection

Click 'Safely Remove Hardware' in the Windows System Tray → disconnect USB connection cable → turn off camera power → disconnect AC adaptor

- Do not use any other USB connection cables except the supplied one.
- Turn off power before inserting or removing memory cards.
- If using Windows 98/98SE, install USB driver software when connecting for first time.
- When the battery begins to run out during communication, the status indicator flashes and a warning beep sounds. Cancel communication via your computer immediately (recharge the battery before reconnecting).
- Setting the 'USB MODE' (P.25) to 'PC' remove the need to make the setting each time the camera is connected to the computer.
- Data cannot be written to, formatted from, or erased from the camera via a computer. However, data may be formatted and deleted when connected in PTP mode (Windows Vista only). (DMC-TZ5 (EG/PR/E), DMC-TZ4 (EG/E) only)
- For more details, consult your computer operating manual.

1 Turn on power of both camera and computer

2 Set REC/PLAY switch to

3 Connect camera to computer

4 Select 'PC' on the camera

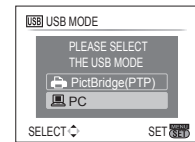
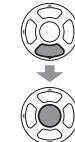

(A message may be displayed on screen if 'USB MODE' (P.25) is set to 'PictBridge (PTP)'. Select 'CANCEL' to close the screen, and set 'USB MODE' to 'PC'.)

5 Operate with your computer (see next page)

1 Using with your PC (Continued)

Folder and file names on computer

You can save images to use on your computer by dragging and dropping folders and files into separate folders on your computer.

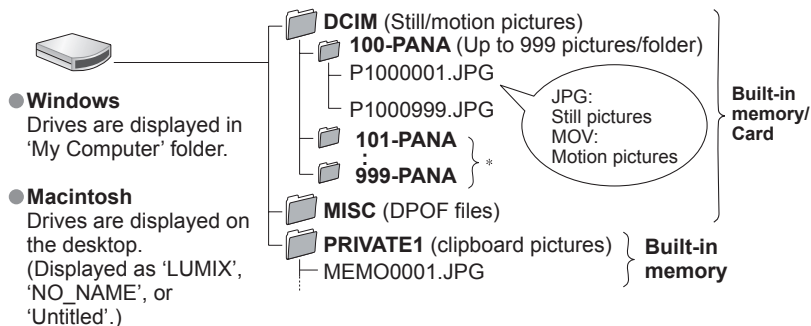

* New folders are created in the following cases:

- When pictures are taken to folders containing files numbered 999.
- When using cards already containing the same folder number (including pictures taken with other cameras, etc.)
- When recording after performing 'NO. RESET' (P.25)
- File may not be able to be played back on camera after changing file name.
- If mode dial is set to , built-in memory data (including clipboard pictures) are displayed even when card is inserted. Data in card is not displayed.
- When using Mac OS X ver.10.2 or earlier, set write-protect switch on card to 'LOCK' whenever handling pictures on SDHC memory cards.

If using Windows XP, Windows Vista, or Mac OS X

The camera can be connected to your computer even if 'USB MODE' (P.25) is set to 'PictBridge (PTP)'.

- Only picture reading operations can be performed via the camera (picture deletion also possible with Windows Vista).
- It may not be possible to read if there are 1000 or more pictures on the card.

To play motion pictures on your computer

- ① Use the 'QuickTime' software on the supplied CD-ROM.
 - Installed as standard on Macintosh
- ② Save motion pictures to your computer before viewing.

2 Printing

You can connect directly to a PictBridge-compatible printer for printing.

Set-up:

- **Connect the camera to the AC adaptor** (optional). (Alternatively, use a sufficiently-charged battery.)
- Card : Insert card
- Built-in memory : Remove card (Copy clipboard pictures to the card (P.65))
- Adjust settings on your printer (print quality, etc.) as required.
- Set mode dial to any setting other than CLIPBOARD.

- Do not disconnect the USB connection cable when the cable disconnection icon  is displayed (may not be displayed with some printers).

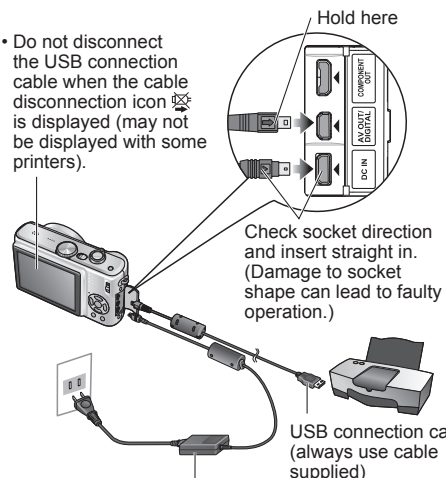

If using AC adaptor, turn off camera power before plugging in or removing.

To cancel print → Press 'MENU/SET'

- Do not use any other USB connection cables except the supplied one.
- Disconnect USB connection cable after printing.
- Turn off power before inserting or removing memory cards.
- When the battery begins to run out during communication, the status indicator flashes and a warning beep sounds. Cancel printing and disconnect USB connection cable (recharge the battery before reconnecting).
- Setting the 'USB MODE' (P.25) to 'PictBridge (PTP)' remove the need to make the setting each time the camera is connected to the printer.

- 1 Turn on power of both camera and printer
- 2 Set REC/PLAY switch to 
- 3 Connect camera to printer
- 4 Select 'PictBridge (PTP)' on the camera

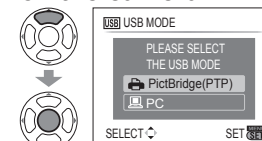

When 'CONNECTING TO PC...' is displayed, cancel the connection and set 'USB MODE' to either 'SELECT ON CONNECTION' or 'PictBridge(PTP)' (P.25).

- 5 Select picture to print with  and  and set
- 6 Select 'PRINT START'

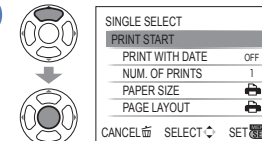

(Print settings → P.85)

Printing multiple pictures

- 1 Select 'MULTI PRINT' in step 5 on the previous page
- 2 Select item (See below for details)
- 3 Select 'PRINT START'

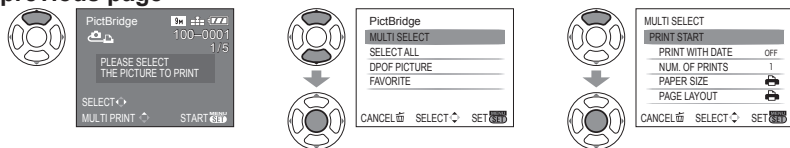

• To cancel → Press 'MENU/SET'

- **MULTI SELECT** : ① Scroll between pictures with ▲▼◀▶, select pictures with display button to print. (Press display button again to release selection.)
② Press 'MENU/SET' when selection is complete.
- **SELECT ALL** : Print all pictures.
- **DPOF PICTURE** : Print pictures selected in 'DPOF PRINT' (P.78).
- **FAVORITE** : Print pictures selected as 'FAVORITE' (P.77).
(displayed only when 'FAVORITE' pictures present and setting set to 'ON').

- Select 'YES' if print confirmation screen is displayed.
- An orange ● displayed during printing indicates an error message.
- Print may be divided into different stints if printing several pictures.
(Remaining sheets display may differ from set number.)

Print with date and text

■ With 'TEXT STAMP'

Recording date and following information can be embedded into photographs (P.73).

- Recording date ● NAME and AGE from 'BABY' and 'PET' scene modes
- 'TRAVEL DATE' elapsed days and destination ● Text registered in 'TITLE EDIT'
• Do not add date printing in stores or with printers to pictures 'TEXT STAMP' is applied (text may overlap).

■ Printing date without 'TEXT STAMP'

- Printing in store: Only recording date can be printed. Request date printing in store.
• Making 'DPOF PRINT' (P.78) settings on the camera in advance allows settings for numbers of copies and date printing to be designated before giving the card to the store.
- When printing pictures of 16:9 aspect ratio, check in advance that the store can accept this size.
- Using computer : Print settings for recording date and text information can be made using the supplied CD-ROM (PHOTOfunSTUDIO-viewer-).
- Using printer : Recording date can be printed by setting 'DPOF PRINT' on the camera, or by setting 'PRINT WITH DATE' (P.85) to 'ON' when connecting to a printer compatible with date printing.

Making print settings on camera

(Make settings before selecting 'PRINT START')

- 1 Select item
- 2 Select setting



Item	Settings
PRINT WITH DATE	OFF/ON
NUM. OF PRINTS	Set number of pictures (up to 999 pictures)
PAPER SIZE	<div style="display: flex; justify-content: space-between;"> <div style="width: 45%;"> <p> (printer takes priority)</p> <p>L/3.5"×5" (89×127 mm)</p> <p>2L/5"×7" (127×178 mm)</p> <p>POSTCARD (100×148 mm)</p> <p>16:9 (101.6×180.6 mm)</p> <p>A4 (210 ×297 mm)</p> </div> <div style="width: 45%;"> <p>A3 (297×420 mm)</p> <p>10×15 cm (100×150 mm)</p> <p>4"×6" (101.6×152.4 mm)</p> <p>8"×10" (203.2 ×254 mm)</p> <p>LETTER (216×279.4 mm)</p> <p>CARD SIZE (54×85.6 mm)</p> </div> </div>
PAGE LAYOUT	(printer takes priority) / (1 picture, no border) / (1 picture, with border) / (2 pictures) / (4 pictures)

- Items may not be displayed if incompatible with printer.
- To arrange '2 pictures' or '4 pictures' in the same picture, set the number of prints for the picture to 2 or 4.
- To print to paper sizes/layouts not supported by this camera, set to and make settings on the printer. (Consult your printer's operating manual.)
- 'PRINT WITH DATE' and 'NUM. OF PRINTS' items are not shown when DPOF settings have been made.
- Even if DPOF settings are made, dates may not be printed with some shops or printers.
- When setting 'PRINT WITH DATE' to 'ON', check the date printing settings on the printer (printer settings may be prioritised).

3 Viewing on TV screen

You can view pictures on a TV screen by connecting your camera to your TV with the AV cable (supplied) or component cable (optional: DMW-HDC2).

● Also consult TV operating manual.

- Set-up:**
- Set 'TV ASPECT'. (P.26)
 - Turn off both camera and TV.

- 1 Connect camera to TV**
- 2 Turn on TV**
● Set to auxiliary input.
- 3 Turn on camera**
- 4 Set REC/PLAY switch to**

Check socket direction and insert straight in. (Damage to socket shape can lead to faulty operation.)

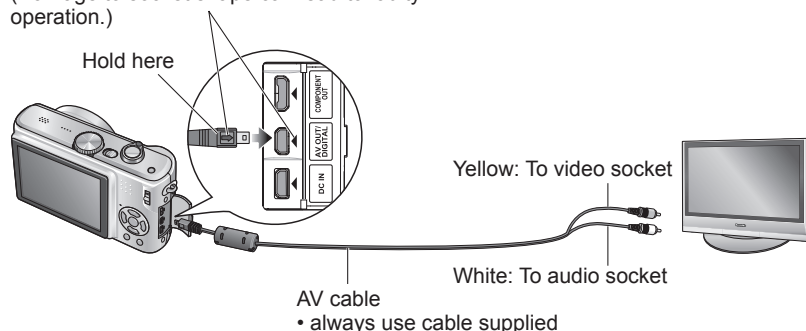

■ If your TV has an SD memory card slot, you can view still pictures by inserting a card directly.

- Use SDHC-compatible TVs to playback images on SDHC memory cards.

- Do not use any other AV cables except the supplied one.
- You can view pictures on TVs in other countries (regions) which use the NTSC or PAL system when you set 'VIDEO OUT' in SETUP menu.
- 'LCD MODE' setting is not reflected on TV.
- Pictures can only be displayed on TV by using mode.
- Some televisions may cut off the edges of pictures, or not display them full screen. Pictures rotated to portrait may be blurred slightly.
- Change picture mode settings on TV if aspect ratios are not displayed correctly on widescreen or high-definition televisions.

View on TV with component terminal

Use component cable (optional: DMW-HDC2) to enjoy still and motion pictures in high definition*. Please check that the TV you are connecting to has a 1080i input terminal. *DMC-TZ5/DMC-TZ15 only

Connect the camera (COMPONENT OUT terminal) to a TV with a component cable, and set the TV to receive component terminal input.

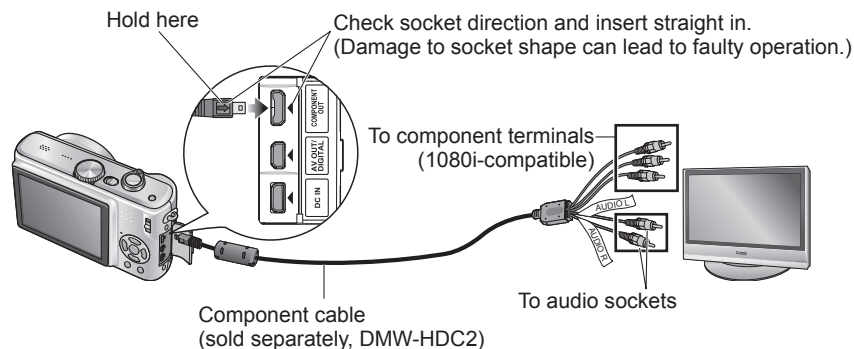

- Playback cannot be performed in clipboard mode.
- Blank stripes may appear at the sides or at the top and bottom of the screen, depending on aspect ratio setting.
- Images displayed vertically may be slightly blurred.
- Pictures cannot be simultaneously displayed on the LCD monitor.
- We recommend recording still pictures with 'PICTURE SIZE' of at least 2M, and motion pictures with 'PICTURE MODE' set to '16:9H' (DMC-TZ5/DMC-TZ15 only).
- Do not use cables other than that specified here (optional, DMW-HDC2).
- Output will be in 16:9 aspect ratio, regardless of 'TV ASPECT' setting.
- Component output will be canceled if a USB connection cable is connected.
- No picture output will occur through AV cables connected simultaneously.
- Audio output is monaural.
- Following functions cannot be set in playback mode. DUAL PLAY (DMC-TZ5/DMC-TZ15 only), TITLE EDIT, TEXT STAMP, RESIZE, TRIMMING, ASPECT CONV., AUDIO DUB., COPY, multiple selection (delete, etc) or creating still pictures from motion pictures (DMC-TZ5/DMC-TZ15 only), etc.
- Images may be momentarily distorted immediately after commencing playback or pausing on certain televisions.

1 List of LCD monitor displays

Press the display button to change display (P.14).

In recording

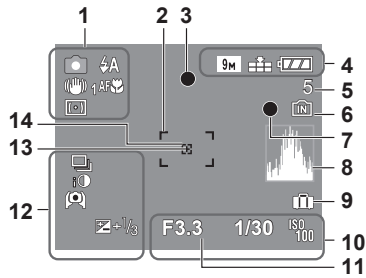

- 1 Recording mode* (P.15)
- Flash mode (P.38)
- Optical image stabilizer (P.62)
- Jitter alert (P.30)
- Metering mode (P.59)
- Macro recording (P.40)
- Tele macro (P.40)
- 2 AF area (P.30)
- 3 Focus (P.30)
- 4 Picture size (P.55)
- Quality (P.55)
- Battery capacity (P.18)
- 5 Number of recordable pictures (P.100)
- 6 Save destination (P.18)
- 7 Recording state
- 8 Histogram (P.37)
- 9 Travel date (P.53)
- 10 Aperture value (P.30)
- Shutter speed (P.30)
- ISO sensitivity (P.57)
- Intelligent ISO (P.56)
- 11 Current date/time
- Focus range (P.41)
- Zoom (P.32)
- 12 Burst mode (P.61)
- Auto bracket (P.43)
- Intelligent exposure (P.61)
- High angle mode (P.22)
- Auto power LCD (P.22)
- Power LCD (P.22)
- Exposure compensation (P.43)
- Backlight Compensation (P.29)
- 13 Spot metering target (P.59)
- 14 Spot AF area (P.60)

- CLIPBOARD mode (P.64)
- * Clipboard recording mode

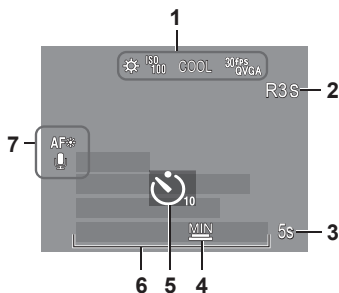

- 1 White balance (P.58)
- ISO sensitivity (P.57)
- ISO LIMIT (P.56)
- Colour mode (P.62)
- MOTION PICTURE mode (P.52)
- 2 Available recording time
- 3 Elapsed recording time (P.52)
- 4 Minimum shutter speed (P.63)
- 5 Self-timer mode (P.42)
- 6 Travel elapsed days (P.53)
- Name (P.48)/Travel Location (P.53)
- Age in years/months (P.48)
- Recorded date and time
- 7 AF assist lamp (P.63)
- Continuous AF (P.60)
- Audio recording (P.63)

In playback

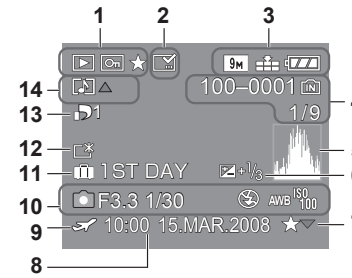

- 1 PLAYBACK mode*1 (P.35)
- Protected picture (P.79)
- Favourites*2 (P.77)
- 2 Text stamped display (P.73)
- 3 Picture size*3 (P.55)
- Quality (P.55)
- Battery capacity (P.18)
- 4 Folder/File number*4 (P.25, 35, 82)
- Save destination (P.18)
- Picture number/Total pictures
- 5 Histogram*5 (P.37)
- 6 Exposure compensation (P.43)
- 7 Favourites settings (P.77)
- 8 Recorded date and time
- Travel destination setting (P.53)/Name (P.48)/Title (P.72)
- 9 Destination settings (P.54)
- 10 Recording information
- Travel elapsed days (P.53)
- 1 month 10 days Age in years/months (P.48)
- 11 Travel elapsed days (P.53)
- 12 Power LCD (P.22)
- 13 Number of DPOF prints (P.78)
- 14 Motion pictures (P.68)
- Picture with audio (P.68)
- Cable disconnection warning icon (P.83)

- CLIPBOARD mode (P.64)
- *1 Clipboard playing mode
- *2 Zoom mark
- MOTION PICTURE mode (P.68)

- *3 30fps VGA 10fps VGA 30fps QVGA 10fps QVGA
- *4 Elapsed playback time XhXXmXXs
- *5 Motion picture recording time
- *6 DMC-TZ5/DMC-TZ15 only

THIS MEMORY CARD IS LOCKED

- Release using the write-protect switch on the SD memory card or SDHC memory card. (P.18)

NO VALID PICTURE TO PLAY

- Take pictures, or insert a different card already containing pictures.

THIS PICTURE IS PROTECTED

- Release the protection before deleting, etc. (P.79)

SOME PICTURES CANNOT BE DELETED/THIS PICTURE CANNOT BE DELETED

- Non-DCF images (P.35) cannot be deleted.
→ Save all necessary data to computer (or other device), and 'FORMAT' (P.27) card to delete.

NO ADDITIONAL SELECTIONS CAN BE MADE

- The number of pictures that can be deleted at once has been exceeded.
- More than 999 pictures have been set as 'FAVORITE'.
- The number of pictures that can be set at once in 'RESIZE (MULTI)', 'TEXT STAMP', or 'TITLE EDIT' has been exceeded.

CANNOT BE SET ON THIS PICTURE

- DPOF settings, 'TITLE EDIT', or 'TEXT STAMP' cannot be made for non-DCF images (P.35).

PLEASE TURN CAMERA OFF AND THEN ON AGAIN

- Force has been applied to lens (or other component) and camera could not operate correctly.
→ Turn on power again.
(Consult place of purchase if display still remains)

SOME PICTURES CANNOT BE COPIED/COPY COULD NOT BE COMPLETED

- Pictures cannot be copied in following cases.
 - Picture of same name already exists in built-in memory when copying from card.
 - File is not of DCF standard (P.35).
 - Picture taken or edited on a different device.

BUILT-IN MEMORY ERROR FORMAT BUILT-IN MEMORY?

- Displayed when formatting built-in memory via computer, etc.
→ Reformat directly using camera (P.27).

MEMORY CARD ERROR FORMAT THIS CARD?

- Card cannot be recognised on this camera.
→ Save all necessary data to computer (or other device), and 'FORMAT' (P.27).

MEMORY CARD ERROR PLEASE CHECK THE CARD

- Access to card has failed.
→ Insert card again.

MEMORY CARD ERROR MEMORY CARD PARAMETER ERROR

- Card is not of SD standard. Only SDHC memory cards can be used for capacities of 4 GB or greater.

READ ERROR PLEASE CHECK THE CARD

- Data read has failed.
→ Check whether card has been inserted correctly (P.17).

WRITE ERROR PLEASE CHECK THE CARD

- Data write has failed.
→ Turn off power and remove card, before re-inserting and turning on power again.
- Card may possibly be damaged.

MOTION RECORDING WAS CANCELLED DUE TO THE LIMITATION OF THE WRITING SPEED OF THE CARD

- We recommend using a card of at least 10 MB/s (as marked on its packaging, etc.).
- Motion picture recording may be automatically terminated with certain cards.

A FOLDER CANNOT BE CREATED

- Folder numbers in use have reached 999.
→ Save all necessary data to computer (or other device), and 'FORMAT' (P.27).
Folder number is reset to 100 when performing 'NO.RESET' (P.25).

PICTURE IS DISPLAYED FOR 4:3 TV/PICTURE IS DISPLAYED FOR 16:9 TV

- AV cable is connected to camera.
 - To remove message immediately → Press 'MENU/SET'.
 - To change aspect ratio → Change 'TV ASPECT' (P.26).
- USB connection cable is only connected to camera.
→ Message disappears when cable is also connected to another device.

FAQ

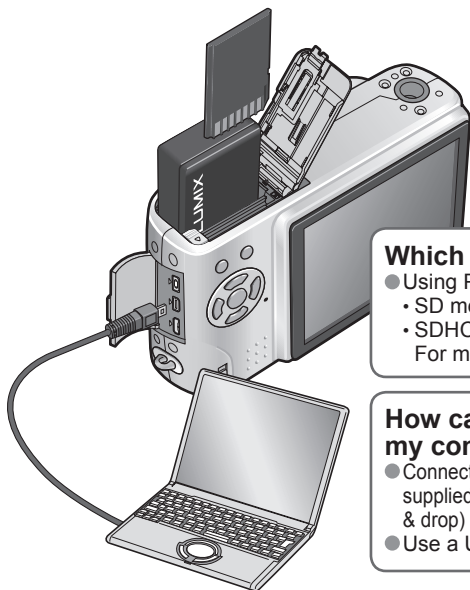

**Which cards can I use?**

- Using Panasonic cards is recommended.
 - SD memory card (8 MB – 2 GB)
 - SDHC memory card (4 GB – 16 GB)
- For more details (P.18)

How can I easily send pictures to my computer?

- Connect the camera to your computer using the supplied USB connection cable (P.81) to copy (drag & drop) picture files to your computer hard disk.
- Use a USB reader-writer.

Pictures appear dark or have poor colouring

- Adjust the exposure (P.43).
- Use WHITE BALANCE to adjust the colouring. (e.g. Use 'AWB' for fluorescent lighting and  for incandescent lighting.)
- If this is still insufficient, try 'Setting white balance manually'  'SET' (P.58).

**How do I get the date printed?**

- Make date printing settings before printing.
 - In shop: Make DPOF settings (P.78), and request printing 'with dates'.
 - With printer: Make DPOF settings, and use a printer compatible with date printing.
 - With supplied software: Select 'with dates' within print settings.
- Use 'TEXT STAMP' before printing (P.73).

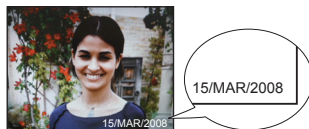

Try checking these items (P.93-97) first.
(Restoring menu settings to default values may solve certain problems.
Try using 'RESET' in SETUP menu in recording mode (P.25).)

Battery, power**Camera does not work even if power is turned on.**

- Battery is not inserted correctly (P.17), or needs recharging (P.16).

LCD monitor shuts off even if power is turned on.

- Camera is set to 'POWER SAVE' or 'AUTO LCD OFF' (P.24).
 - Press shutter button halfway to release.
- Battery needs recharging.

Camera switches off as soon as power is turned on.

- Battery needs recharging.
- Camera is set to 'POWER SAVE'. (P.24)
 - Press shutter button halfway to release.

Recording**Cannot record pictures.**

- REC/PLAY switch is not set to  (record).
- Built-in memory/card is full. → Free space by deleting unwanted pictures (P.36).

Recording capacity is low.

- Battery needs recharging.
 - Use a fully charged battery (not sold pre-charged). (P.16)
 - If you leave the camera on, the battery will be exhausted. Turn the camera off frequently by using 'POWER SAVE' or 'AUTO LCD OFF' (P.24) etc.
- Please check the recording picture capacity for cards and built-in memory. (P.100)

Recorded pictures look white.

- Lens is dirty (fingerprints, etc.).
 - Turn on power to extract lens barrel, and clean lens surface with a soft, dry cloth.
- Lens is foggy (P.12).

Recorded pictures are too bright/too dark.

- Pictures taken in dark locations, or bright subjects (snow, bright conditions, etc.) occupy most of the screen. (Brightness of LCD monitor may differ from that of actual picture) → Adjust the exposure (P.43).
- 'MIN. SHTR SPEED' is set to fast speeds, e.g. '1/200' (P.63).

2-3 pictures are taken when I press the shutter button just once.

- Camera set to use 'AUTO BRACKET', 'BURST', or the 'HI-SPEED BURST' or 'MULTI ASPECT' (DMC-TZ5/DMC-TZ15 only) scene modes. (P.43, 49, 51, 61)

Focus not aligned correctly.

- Not set to mode appropriate for distance to subject. (Focus range varies according to recording mode.)
- Subject outside of focus range.
- Caused by jitter or subject movement (P.56, 62).

Recorded pictures are blurred. Optical image stabilizer ineffective.

- Shutter speed is slower in dark locations and Optical image stabilizer is less effective.
 - Hold camera firmly with both hands, keeping arms close to body.
- Use a tripod and the self-timer (P.42) when using 'MIN. SHTR SPEED'.

Cannot use 'AUTO BRACKET' or 'MULTI ASPECT' (DMC-TZ5/DMC-TZ15 only).

- Only enough memory for 2 pictures or fewer.

Recording (continued)**Recorded pictures appear coarse, or there is interference.**

- ISO sensitivity is high, or shutter speed is low. (Default SENSITIVITY setting is 'AUTO' – interference may appear with indoor pictures.)
 - Lower 'SENSITIVITY' (P.57).
 - Set 'COLOR MODE' to 'NATURAL' (P.62)
 - Take pictures in brighter locations.
- Camera set to 'HIGH SENS.' or 'HI-SPEED BURST' scene modes. (Picture becomes slightly coarser in response to high sensitivity)

Brightness or colouring of recorded picture different from real life.

- Taking pictures under fluorescent lighting may require a faster shutter speed and result in slightly changed brightness or colouring, but this is not a fault.

Reddish vertical line (smear) appears during recording.

- This is a characteristic of CCD and may appear if subject contains brighter areas. Some blurring may occur around these areas, but this is not a fault. This will be recorded in motion pictures, but not in still pictures.
- We recommend keeping the screen away from strong light sources such as sunlight when taking pictures.

**Motion picture recording stops midway.**

- Using MultiMediaCard (not compatible with motion picture recording).
- We recommend using a card of at least 10 MB/s (as marked on its packaging, etc.).
- With some cards, access display may appear briefly after recording, and recording may end midway.

LCD monitor**LCD monitor dims during motion picture recording.**

- LCD monitor may dim if continuing motion picture recording for long periods.

Monitor sometimes shuts off even though power is on.

- Camera set to 'AUTO LCD OFF' (P.24). (LCD monitor shuts off during flash recharging)
- After recording, monitor shuts off until next picture can be recorded.

Brightness is unstable.

- Aperture value is set while shutter button is pressed halfway. (Does not affect recorded picture.)

Monitor flickers indoors.

- Monitor may flicker after turning on (prevents influence from fluorescent lighting).

Monitor is too bright/too dark.

- Adjust 'MONITOR' setting (P.22).
- Camera set to 'LCD MODE' (P.22).

Black/blue/red/green dots or interference appears. Monitor looks distorted when touched.

- This is not a fault, and will not be recorded on the actual pictures, so there is no need to worry.

Date/age is not displayed.

- Current date, 'TRAVEL DATE' (P.53), and ages in 'BABY' and 'PET' (P.48) scene modes are only displayed for approx. 5 sec. after start-up, setting changes, or mode changes. They cannot be always displayed.

Flash**No flash emitted.**

- Flash set to 'FORCED FLASH OFF' (P.38).
- When set to 'AUTO' (P.38), flash may not be emitted in certain conditions.
- Flash cannot be emitted in 'MOTION PICTURE mode', or the 'SCENERY', 'NIGHT SCENERY', 'SUNSET', 'HI-SPEED BURST', 'FIREWORKS', 'STARRY SKY', and 'AERIAL PHOTO' scene modes, or when using 'AUTO BRACKET' or 'BURST'.

Two flashes emitted

- Red-eye reduction is active (P.38). (Flashes twice to prevent eyes appearing red.)

Playback**Pictures have been rotated.**

- 'ROTATE DISP.' is set to 'ON'. (Automatically rotates pictures from portrait to landscape. Some pictures taken facing up or facing down may be interpreted as being portrait.)
 - Set 'ROTATE DISP.' to 'OFF'. You can also rotate display manually using 'ROTATE' (P.76).

Cannot view pictures.

- REC/PLAY switch is not set to (play).
- No pictures in built-in memory or card (pictures played from card if inserted, from built-in memory if not).
- Camera set to 'CATEGORY PLAY' or 'FAVORITE PLAY'.
 - Set playback mode to 'NORMAL PLAY' (P.69).

Folder/file number displayed as '-'. Picture is black.

- Picture edited on computer or taken on different device.
- Battery removed immediately after picture taken, or picture taken with low battery.
 - Use 'FORMAT' to delete (P.27).

Incorrect date displayed in calendar playback.

- Picture edited on computer or taken on different device.
- 'CLOCK SET' is incorrect (P.19). (Incorrect date may be displayed in calendar playback on pictures copied to computer and then back to camera, if computer and camera dates differ.)

Depending on the subject, an interference fringe may appear on the screen.

- This is called moire. This is not a malfunction.

Playback (continued)**White round spots like soap bubbles appear on the recorded picture.**

- If you take a picture with the flash in a dark place or indoors, white round spots may appear on the picture caused by the flash reflecting of particles of dust in the air. This is not a fault. A characteristic of this is that the number of round spots and their position differ in every picture.

Sounds of camera operations will be recorded in motion pictures.

- Camera operation sounds may be recorded as camera automatically adjusts lens aperture during motion picture recording; this is not a fault.

TV, computer, printer**No image appears on TV. Image blurred or not coloured.**

- Not connected correctly (P.86, 87).
- TV input setting not set to auxiliary input.
- TV is not compatible with SDHC memory card. (When using SDHC memory card)

TV screen display different to LCD monitor.

- Aspect ratio may be incorrect or edges may be cut off with certain televisions.

Cannot play motion pictures on TV.

- Card is inserted into TV.
→ Connect with AV cable (supplied) or component cable (optional: DMW-HDC2) and play on camera (P.86, 87).

Picture is not displayed on full TV screen.

- Check 'TV ASPECT' settings (P.26).

Cannot send pictures to computer.

- Not connected correctly (P.81).
- Check whether computer has recognised camera.
- Set 'USB MODE' to 'PC' (P.25).

Computer does not recognise card (only reads built-in memory).

- Disconnect USB connection and reconnect with card in place.
- Set mode dial to any except .

I want to play computer pictures on my camera.

- Use the supplied software PHOTOfunSTUDIO-viewer- to copy pictures from computer to camera. To save to clipboard, use software to copy from computer to card, then copy to clipboard folder with 'COPY' (P.80) in PLAYBACK menu.

Cannot print when connecting to printer.

- Printer not compatible with PictBridge.
- Set 'USB MODE' to 'PictBridge (PTP)' (P.25).

Edges cut off pictures when printing.

- Release any trimming or edgeless printing settings on printer before printing. (Consult printer operating manual.)
- Pictures taken on 16:9 'ASPECT RATIO'.
→ If printing in shop, check if 16:9 sizes can be printed.

Others**Menu not displayed in desired language.**

- Change 'LANGUAGE' setting (P.27).

Camera rattles if shaken.

- This sound is made by the lens movement and is not a fault.

Cannot set 'AUTO REVIEW'.

- Cannot be set when any of the following are in use: 'AUTO BRACKET', 'BURST', the 'SELF PORTRAIT', 'HI-SPEED BURST', and 'MULTI ASPECT' (DMC-TZ5/DMC-TZ15 only) scene modes, MOTION PICTURE mode, or 'AUDIO REC.'.

Red lamp illuminated when pressing shutter button halfway in dark locations.

- 'AF ASSIST LAMP' set to 'ON' (P.63).

AF ASSIST LAMP is not illuminated.

- 'AF ASSIST LAMP' is set to 'OFF'.
- Not illuminated in bright locations or when using 'SCENERY', 'NIGHT SCENERY', 'SELF PORTRAIT', 'FIREWORKS', 'AERIAL PHOTO', or 'SUNSET' scene modes.

Camera is hot.

- Camera may become a little warm during use, but this does not affect performance or quality.

Lens makes a clicking noise.

- When brightness changes, the lens may make a clicking noise and the monitor brightness may also change, but this is due to aperture settings being made. (Does not affect recording.)

Clock is incorrect.

- Camera has been left for a long period.
→ Reset the clock (P.19).
(Date will be set to '0:00 0. 0. 0' for pictures if clock is not set.)
- Long time was taken to set clock (clock behind by this amount).

When using zoom, picture becomes slightly warped and the edges of the subject become coloured.

- Pictures may be slightly warped or coloured around the edges, depending on the zoom ratio, but this is not a fault.

File numbers are not recorded in sequence.

- File numbers are reset when new folders are created (P.82).

File numbers have jumped backwards.

- Battery was removed/inserted with power on.
(Numbers may jump backwards if folder/file numbers are not correctly recorded.)

When in use

Camera may become warm if used for long periods of time, but this is not a fault.

- To avoid jitter, use a tripod and place in a stable location.
(Especially when using telescopic zoom, lower shutter speeds, or self-timer)
- **Keep the camera as far away as possible from electromagnetic equipment (such as microwave ovens, TVs, video games etc.).**
 - If you use the camera on top of or near a TV, the pictures and sound on the camera may be disrupted by electromagnetic wave radiation.
 - Do not use the camera near cell phones because doing so may result in noise adversely affecting the pictures and sound.
 - Recorded data may be damaged, or pictures may be distorted, by strong magnetic fields created by speakers or large motors.
 - Electromagnetic wave radiation generated by microprocessors may adversely affect the camera, disturbing the pictures and sound.
 - If the camera is adversely affected by electromagnetic equipment and stops functioning properly, turn the camera off and remove the battery or disconnect AC adaptor (optional). Then reinsert the battery or reconnect AC adaptor and turn the camera on.
- **Do not use the camera near radio transmitters or high-voltage lines.**
 - If you record near radio transmitters or high-voltage lines, the recorded pictures and sound may be adversely affected.
- Do not extend the supplied cord or cable.
- Do not allow camera to come into contact with pesticides or volatile substances (can cause surface damage or coating to peel).

Caring for your camera

To clean your camera, remove the battery or disconnect AC cable, and wipe with a soft, dry cloth.

- Use a well-wrung wet cloth to remove stubborn stains, before wiping again with a dry cloth.
- Do not use benzene, thinners, alcohol, or kitchen detergent, as these may damage the outer casing and finish of the camera.
- If using a chemically-treated cloth, read the supplied instructions carefully.
- Do not touch the lens barrier (P.13).

When not using for a while

- Turn off camera power before removing battery and card (ensure that battery is removed to prevent damage through over-discharge).
- Do not leave in contact with rubber or plastic bags.
- Store together with a drying agent (silica gel) if leaving in drawer, etc. Store batteries in cool (15 °C-25 °C) places with low humidity (40% - 60%) and no major temperature changes.
- Charge battery once per year and use completely before storing again.

Memory cards

- To prevent damage to cards and data
 - Avoid high temperatures, direct sunlight, electromagnetic waves, and static electricity.
 - Do not bend, drop, or expose to strong impacts.
 - Do not touch connectors on reverse of card or allow them to become dirty or wet.
- When disposing of/transferring memory cards
 - If using the 'format' or 'delete' functions on your camera or computer, this only changes the file management information, and does not completely delete the data from within the memory card. When disposing of or transferring your memory cards, we recommend physically destroying the memory card itself, or using commercially available computer data erasing software to completely delete the data from the card. Data within memory cards should be managed responsibly.

Battery and Charger

- Store battery in battery carrying case after use.
- Do not use if damaged or dented (especially connectors), e.g. by dropping (can cause faults).
- Estimated recording capacity of 300 [330 *1] pictures (P.16) is based on the following CIPA *2 standards.
*1 DMC-TZ4/DMC-TZ11

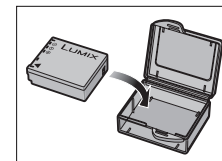

CIPA standards:

- Using Panasonic SD memory card (16 MB) • Using the supplied battery • Temperature 23 °C, humidity 50% • NORMAL PICTURE mode • LCD monitor ON (The number of recordable pictures decreases in AUTO POWER LCD, POWER LCD, and HIGH ANGLE mode) • STABILIZER (MODE1) • First picture taken 30 sec. after power turned on • 1 picture taken per 30 sec. • Full flash used for every other picture • Zoom operation for each picture (max. W → max. T, or max. T → max. W) • Power turned off after each 10 pictures, battery allowed to cool
- *2 CIPA = Camera & Imaging Products Association
- When charging
 - Remove any dirt on connectors of charger and battery with dry cloth.
 - Keep at least 1 m away from AM radio (may cause radio interference).
 - Noises may be emitted from inside of charger, but this is not a fault.
 - Always remove from mains socket after charging (up to 0.1 W consumed if left in place).

(DMC-TZ5/DMC-TZ4 (EG/E) only)

Notice about the rechargeable battery

The battery is designated recyclable.
Please follow your local recycling regulations.

5 Recording picture/time capacity

- Figures given are estimates. May vary according to conditions, card type, and subject.
- Recording capacities/times displayed on LCD monitor may not be reduced regularly.

Recording picture capacity (still pictures)

- Varies according to 'ASPECT RATIO' (P.56), 'PICTURE SIZE' (P.55), or 'QUALITY' (P.55) settings.

*1 DMC-TZ5/DMC-TZ15 *2 DMC-TZ4/DMC-TZ11

ASPECT RATIO	4:3												3:2										16:9																																																																																																																																																																																																																																																																																																																																																																																																																																																																																																																																																																																																																																																																																																																																																																																																																																					
	9 M *1 (3456×2592)		8 M *2 (3264×2448)		7 M EZ *1 (3072×2304)		5 M EZ (2560×1920)		3 M EZ (2048×1536)		2 M EZ (1600×1200)		0.3 M EZ (640×480)		8.5 M *1 (3552×2368)		7 M *2 (3264×2176)		6 M EZ *1 (3072×2048)		4.5 M EZ (2560×1712)		2.5 M EZ (2048×1360)		7.5 M *1 (3712×2088)		6 M *2 (3264×1840)		5.5 M EZ *1 (3072×1728)		3.5 M EZ (2560×1440)		2 M EZ (1920×1080)																																																																																																																																																																																																																																																																																																																																																																																																																																																																																																																																																																																																																																																																																																																																																																																																																											
QUALITY																																																																																																																																																																																																																																																																																																																																																																																																																																																																																																																																																																																																																																																																																																																																																																																																																																																												

Digital Camera: Information for your safety

Power Source	DC 5.1 V
Power Consumption	When recording: 1.3 W (DMC-TZ5/DMC-TZ15)/1.2 W (DMC-TZ4/DMC-TZ11) When playing back: 0.6 W
Camera effective pixels	● DMC-TZ5/DMC-TZ15: 9,100,000 pixels ● DMC-TZ4/DMC-TZ11: 8,100,000 pixels
Image sensor	● DMC-TZ5/DMC-TZ15: 1/2.33" CCD, total pixel number 10,700,000 pixels ● DMC-TZ4/DMC-TZ11: 1/2.5" CCD, total pixel number 8,320,000 pixels Primary colour filter
Lens	Optical 10 x zoom f=4.7 mm to 47 mm (35 mm film camera equivalent: 28 mm to 280 mm)/F3.3 to F4.9
Digital zoom	Max.4 x
Extra optical zoom	Max. 16.9 x (DMC-TZ5/DMC-TZ15)/Max. 15.9 x (DMC-TZ4/DMC-TZ11)
Focus	Normal/Macro Face detection/9-area-focusing/3-area-focusing (High speed)/ 1-area-focusing (High speed)/1-area-focusing/Spot-focusing
Focus range	
Normal/Motion picture	50 cm (Wide)/2 m (Tele) to ∞
Macro/Intelligent Auto/Clipboard	5 cm (Wide)/1 m (Tele) to ∞ (2 m unless max.T)
Scene mode	There may be difference in above settings.
Shutter system	Electronic shutter + Mechanical shutter
Motion picture recording	1280 × 720 pixels* (DMC-TZ5/DMC-TZ15 only)/ 848 × 480 pixels* /640 × 480 pixels* /320 × 240 pixels (* Only when using an SD Memory Card) 30,15 (DMC-TZ5/DMC-TZ15 only), or 10 frames/second with audio.
Burst recording	
Burst speed	● DMC-TZ5/DMC-TZ15: 2.5 pictures/second (Burst), Approx. 2 pictures/second (Unlimited) ● DMC-TZ4/DMC-TZ11: 3 pictures/second (Burst), Approx. 2 pictures/second (Unlimited)
Number of recordable pictures	● DMC-TZ5/DMC-TZ15: Max. 5 pictures (Standard), max. 3 pictures (Fine), Depends on the remaining capacity of the built-in memory or the card (Unlimited). ● DMC-TZ4/DMC-TZ11: Max. 7 pictures (Standard), max. 4 pictures (Fine), Depends on the remaining capacity of the built-in memory or the card (Unlimited).
Hi-speed burst	
Burst speed	● DMC-TZ5/DMC-TZ15: Approx. 6 pictures/second ● DMC-TZ4/DMC-TZ11: Approx. 7 pictures/second
Number of recordable pictures	Approx. 20 pictures (When using the built-in memory, immediately after formatting) Max. 100 pictures (When using a card, differs depending on the type of card and the recording conditions)
ISO sensitivity	AUTO/100/200/400/800/1600 [HIGH SENS.] mode: 1600 - 6400
Shutter speed	8 to 1/2000th [STARRY SKY] mode: 15 seconds, 30 seconds, 60 seconds
White balance	AUTO/Daylight/Cloudy/Shade/Halogen/White set
Exposure (AE)	AUTO (Programme AE) Exposure compensation (1/3 EV Step, -2 EV to +2 EV)
Metering mode	Multiple/Centre weighted/Spot
LCD monitor	● DMC-TZ5/DMC-TZ15: 3.0" low-temperature polycrystalline TFT LCD (Approx. 460,800 dots) (field of view ratio about 100%) ● DMC-TZ4/DMC-TZ11: 2.5" amorphous silicon TFT LCD (Approx. 230,400 dots) (field of view ratio about 100%)

Flash	Flash range: (ISO AUTO) Approx.60 cm to 5.3 m (Wide) AUTO, AUTO/Red-eye reduction, Forced flash ON (Forced flash ON/Red-eye reduction), Slow sync./Red-eye reduction, Forced flash OFF
Microphone	Monaural
Speaker	Monaural
Recording media	Built-in Memory (Approx. 50 MB)/SD Memory Card/SDHC Memory Card/ MultiMediaCard (Still pictures only)
Picture size	
Still picture	When the aspect ratio setting is [4:3] ● DMC-TZ5/DMC-TZ15: 3456 × 2592 pixels / 3072 × 2304 pixels / 2560 × 1920 pixels / 2048 × 1536 pixels / 1600 × 1200 pixels / 640 × 480 pixels ● DMC-TZ4/DMC-TZ11: 3264 × 2448 pixels / 2560 × 1920 pixels / 2048 × 1536 pixels / 1600 × 1200 pixels / 640 × 480 pixels
	When the aspect ratio setting is [3:2] ● DMC-TZ5/DMC-TZ15: 3552 × 2368 pixels / 3072 × 2048 pixels / 2560 × 1712 pixels / 2048 × 1360 pixels ● DMC-TZ4/DMC-TZ11: 3264 × 2176 pixels / 2560 × 1712 pixels / 2048 × 1360 pixels
	When the aspect ratio setting is [16:9] ● DMC-TZ5/DMC-TZ15: 3712 × 2088 pixels / 3072 × 1728 pixels / 2560 × 1440 pixels / 1920 × 1080 pixels ● DMC-TZ4/DMC-TZ11: 3264 × 1840 pixels / 2560 × 1440 pixels / 1920 × 1080 pixels
Motion pictures (* Only when using an SD Memory Card)	1280 × 720 pixels* (DMC-TZ5/DMC-TZ15 only) / 848 × 480 pixels* / 640 × 480 pixels* /320 × 240 pixels
Quality	Fine/Standard
Recording file format	
Still Picture	JPEG (based on Design rule for Camera File system, based on Exif 2.21 standard)/DPOF corresponding
Still pictures with audio	JPEG (based on Design rule for Camera File system, based on Exif 2.21 standard) + QuickTime
Motion pictures	QuickTime Motion JPEG
Interface	Digital: USB 2.0 (High Speed) Analog video/audio: NTSC/PAL Composite (Switched by menu), Component/Audio line output (monaural)
Terminal	COMPONENT OUT: Dedicated jack (10 pin) DIGITAL/AV OUT: Dedicated jack (8 pin) DC IN: Dedicated jack (2 pin)
Dimensions (excluding the projection part)	● DMC-TZ5/DMC-TZ15: Approx. 103.3 mm (W) × 59.3 mm (H) × 36.5 mm (D) ● DMC-TZ4/DMC-TZ11: Approx. 103.3 mm (W) × 59.3 mm (H) × 36.2 mm (D)
Mass	Excluding card and battery: DMC-TZ5/DMC-TZ15 Approx. 214 g DMC-TZ4/DMC-TZ11 Approx. 208 g With card and battery: DMC-TZ5/DMC-TZ15 Approx. 240 g DMC-TZ4/DMC-TZ11 Approx. 234 g
Operating temperature	0 °C to 40 °C
Operating humidity	10% to 80%

Battery charger: Information for your safety

Output	CHARGE 4.2 V --- 0.8 A
Input	110 V to 240 V 50/60Hz, 0.2 A

Battery Pack (lithium-ion): Information for your safety

Voltage/capacity	3.7 V 1000 mAh
-------------------------	----------------