

# Panasonic®

## Basic Operating Instructions

Digital Camera/  
Lens Kit/Double Lens Kit/Body

Model No. **DMC-GF3C/DMC-GF3K**  
**DMC-GF3X/DMC-GF3W**  
**DMC-GF3**

# LUMIX



Before use, please read these instructions completely.



More detailed instructions on the operation of this camera are contained in "Operating Instructions for advanced features (PDF format)" in the supplied CD-ROM. Install it on your PC to read it.



Web Site: <http://www.panasonic-europe.com>

Model number suffix "EB" denotes UK model.

EB

VQT3Q87-2

## Dear Customer,

We would like to take this opportunity to thank you for purchasing this Panasonic Digital Camera. Please read these Operating Instructions carefully and keep them handy for future reference. Please note that the actual controls and components, menu items, etc. of your Digital Camera may look somewhat different from those shown in the illustrations in these Operating Instructions.

### Carefully observe copyright laws.

- Recording of pre-recorded tapes or discs or other published or broadcast material for purposes other than your own private use may infringe copyright laws. Even for the purpose of private use, recording of certain material may be restricted.

## Information for Your Safety

### WARNING:

- TO REDUCE THE RISK OF FIRE, ELECTRIC SHOCK OR PRODUCT DAMAGE,**
- **DO NOT EXPOSE THIS APPARATUS TO RAIN, MOISTURE, DRIPPING OR SPLASHING AND THAT NO OBJECTS FILLED WITH LIQUIDS, SUCH AS VASES, SHALL BE PLACED ON THE APPARATUS.**
  - **USE ONLY THE RECOMMENDED ACCESSORIES.**
  - **DO NOT REMOVE THE COVER (OR BACK); THERE ARE NO USER SERVICEABLE PARTS INSIDE. REFER SERVICING TO QUALIFIED SERVICE PERSONNEL.**

THE SOCKET OUTLET SHALL BE INSTALLED NEAR THE EQUIPMENT AND SHALL BE EASILY ACCESSIBLE.

### ■ Product identification marking

| Product         | Location |
|-----------------|----------|
| Digital Camera  | Bottom   |
| Battery charger | Bottom   |

### ■ About the battery pack

#### CAUTION

Danger of explosion if battery is incorrectly replaced. Replace only with the same or equivalent type recommended by the manufacturer. Dispose of used batteries according to the manufacturer's instructions.

- Do not heat or expose to flame.
- Do not leave the battery(ies) in an automobile exposed to direct sunlight for a long period of time with doors and windows closed.



#### Warning

Risk of fire, explosion and burns. Do not disassemble, heat above 60 °C or incinerate.

## Caution for AC mains lead

For your safety, please read the following text carefully.

This appliance is supplied with a moulded three pin mains plug for your safety and convenience.

A 5-ampere fuse is fitted in this plug. Should the fuse need to be replaced please ensure that the replacement fuse has a rating of 5-ampere and that it is approved by ASTA or BSI to BS1362. Check for the ASTA mark  or the BSI mark  on the body of the fuse.

If the plug contains a removable fuse cover you must ensure that it is refitted when the fuse is replaced.

If you lose the fuse cover the plug must not be used until a replacement cover is obtained.

A replacement fuse cover can be purchased from your local dealer.

### CAUTION!

IF THE FITTED MOULDED PLUG IS UNSUITABLE FOR THE SOCKET OUTLET IN YOUR HOME THEN THE FUSE SHOULD BE REMOVED AND THE PLUG CUT OFF AND DISPOSED OF SAFELY.

THERE IS A DANGER OF SEVERE ELECTRICAL SHOCK IF THE CUT OFF PLUG IS INSERTED INTO ANY 13-AMPERE SOCKET.

If a new plug is to be fitted please observe the wiring code as stated below. If in any doubt please consult a qualified electrician.

## ■ IMPORTANT

The wires in this mains lead are coloured in accordance with the following code: Blue: Neutral, Brown: Live.

As these colours may not correspond with the coloured markings identifying the terminals in your plug, proceed as follows: The wire which is coloured Blue must be connected to the terminal which is marked with the letter N or coloured Black or Blue. The wire which is coloured Brown must be connected to the terminal which is marked with the letter L or coloured Brown or Red.

**WARNING: DO NOT CONNECT EITHER WIRE TO THE EARTH TERMINAL WHICH IS MARKED WITH THE LETTER E, BY THE EARTH SYMBOL  OR COLOURED GREEN OR GREEN/YELLOW.**

**THIS PLUG IS NOT WATERPROOF—KEEP DRY.**

## ■ Before use

Remove the connector cover.

## ■ How to replace the fuse

The location of the fuse differ according to the type of AC mains plug (figures A and B). Confirm the AC mains plug fitted and follow the instructions below.

Illustrations may differ from actual AC mains plug.

1. Open the fuse cover with a screwdriver.

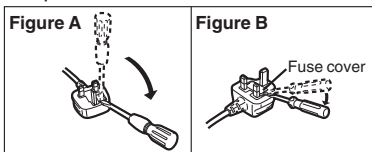

2. Replace the fuse and close or attach the fuse cover.

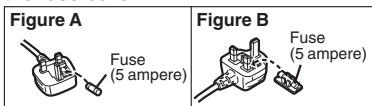

## ■ About the battery charger

### CAUTION!

- **DO NOT INSTALL OR PLACE THIS UNIT IN A BOOKCASE, BUILT-IN CABINET OR IN ANOTHER CONFINED SPACE. ENSURE THE UNIT IS WELL VENTILATED. TO PREVENT RISK OF ELECTRIC SHOCK OR FIRE HAZARD DUE TO OVERHEATING, ENSURE THAT CURTAINS AND ANY OTHER MATERIALS DO NOT OBSTRUCT THE VENTILATION VENTS.**
- **DO NOT OBSTRUCT THE UNIT'S VENTILATION OPENINGS WITH NEWSPAPERS, TABLECLOTHS, CURTAINS, AND SIMILAR ITEMS.**
- **DO NOT PLACE SOURCES OF NAKED FLAMES, SUCH AS LIGHTED CANDLES, ON THE UNIT.**
- **DISPOSE OF BATTERIES IN AN ENVIRONMENTALLY FRIENDLY MANNER.**

- The battery charger is in the standby condition when the AC power supply cord is connected. The primary circuit is always "live" as long as the power cord is connected to an electrical outlet.

## ■ Cautions for Use

- Do not use any other AV cables except the supplied one.
- Do not use any other USB connection cables except the supplied one.
- Always use a genuine Panasonic HDMI mini cable (RP-CDHM15, RP-CDHM30; optional).  
Part numbers: RP-CDHM15 (1.5 m) (5 feet), RP-CDHM30 (3.0 m) (10 feet)

### **Keep this unit as far away as possible from electromagnetic equipment (such as microwave ovens, TVs, video games etc.).**

- If you use this unit on top of or near a TV, the pictures and/or sound on this unit may be disrupted by electromagnetic wave radiation.
- Do not use this unit near cell phones because doing so may result in noise adversely affecting the pictures and/or sound.
- Recorded data may be damaged, or pictures may be distorted, by strong magnetic fields created by speakers or large motors.
- Electromagnetic wave radiation generated by microprocessors may adversely affect this unit, disturbing the pictures and/or sound.
- If this unit is adversely affected by electromagnetic equipment and stops functioning properly, turn this unit off and remove the battery or disconnect AC adaptor (DMW-AC8E; optional). Then reinsert the battery or reconnect AC adaptor and turn this unit on.

### **Do not use this unit near radio transmitters or high-voltage lines.**

- If you record near radio transmitters or high-voltage lines, the recorded pictures and/or sound may be adversely affected.

## Information for Users on Collection and Disposal of Old Equipment and used Batteries



These symbols on the products, packaging, and/or accompanying documents mean that used electrical and electronic products and batteries should not be mixed with general household waste. For proper treatment, recovery and recycling of old products and used batteries, please take them to applicable collection points, in accordance with your national legislation and the Directives 2002/96/EC and 2006/66/EC.

By disposing of these products and batteries correctly, you will help to save valuable resources and prevent any potential negative effects on human health and the environment which could otherwise arise from inappropriate waste handling.

For more information about collection and recycling of old products and batteries, please contact your local municipality, your waste disposal service or the point of sale where you purchased the items.

Penalties may be applicable for incorrect disposal of this waste, in accordance with national legislation.



### **For business users in the European Union**

If you wish to discard electrical and electronic equipment, please contact your dealer or supplier for further information.

### **[Information on Disposal in other Countries outside the European Union]**

These symbols are only valid in the European Union. If you wish to discard these items, please contact your local authorities or dealer and ask for the correct method of disposal.



### **Note for the battery symbol (bottom two symbol examples):**

This symbol might be used in combination with a chemical symbol. In this case it complies with the requirement set by the Directive for the chemical involved.

Cd

# Contents

|  |    |
|--|----|
| Information for Your Safety .....  | 2  |
| Accessories .....  | 7  |
| Names and Functions of Components .....                                    | 11 |
| About the Lens.....  | 15 |
| Changing the Lens.....   | 16 |
| Attaching the Shoulder Strap.....  | 19 |
| Charging the Battery.....  | 20 |
| • Charging .....   | 20 |
| • Approximate operating time and number of recordable pictures .....       | 21 |
| Inserting and Removing the Card (optional)/the Battery.....                | 23 |
| About the Card.....  | 24 |
| • About cards that can be used with this unit .....                        | 24 |
| Setting Date/Time (Clock Set) .....  | 25 |
| Selecting the Recording Mode.....  | 26 |
| Taking a Still picture .....   | 28 |
| Taking Pictures using the Automatic Function (Intelligent Auto Mode) ..... | 29 |
| Easily adjust and record (Intelligent Auto Plus Mode) .....                | 31 |
| Taking Pictures with Defocus Control Function .....                        | 32 |
| Taking Pictures with Your Favourite Settings (Programme AE Mode).....      | 33 |
| Recording Motion Picture .....   | 34 |
| Playing Back Pictures/Motion Pictures .....                                | 35 |
| • Playing Back Pictures.....   | 35 |
| • Playing Back Motion Pictures .....                                       | 36 |
| Deleting Pictures.....   | 38 |
| Setting the Menu.....  | 39 |
| • Setting menu items.....  | 40 |
| Compensating the Exposure .....  | 42 |
| Taking Pictures by Specifying the Aperture/Shutter Speed.....              | 43 |
| • Aperture-priority AE .....   | 43 |
| • Shutter-priority AE .....  | 43 |
| • Manual Exposure Mode.....  | 44 |
| Reading the Operating Instructions (PDF format) .....                      | 45 |
| Specifications.....  | 46 |

## Accessories

Check that all the accessories are supplied before using the camera.  
Product numbers correct as of September 2011. These may be subject to change.

- 1 Digital Camera Body  
(This is referred to as **camera body** in these operating instructions.)
- 2 Interchangeable Lens  
"LUMIX G 14 mm/F2.5 ASPH."  
(This is referred to as **lens** in these operating instructions. This is attached to the camera body at the time of purchase.)
- 3 Lens Cap  
(This is attached to the interchangeable lens at the time of purchase.)
- 4 Interchangeable Lens  
"LUMIX G VARIO 14–42 mm/F3.5–5.6 ASPH./MEGA O.I.S."  
(This is referred to as **lens** in these operating instructions.)
- 5 Lens Hood
- 6 Lens Cap  
(This is attached to the interchangeable lens at the time of purchase.)
- 7 Lens Rear Cap  
(This is attached to the interchangeable lens at the time of purchase.)
- 8 Body Cap  
(This is attached to the camera body at the time of purchase.)
- 9 Interchangeable Lens  
"LUMIX G X VARIO PZ 14–42 mm/F3.5–5.6 ASPH./POWER O.I.S."  
(This is referred to as **lens** in these operating instructions. This is attached to the camera body at the time of purchase.)
- 10 Lens Cap  
(This is attached to the interchangeable lens at the time of purchase.)
- 11 Battery Pack  
(Indicated as **battery pack** or **battery** in the text)  
Charge the battery before use.
- 12 Battery Charger  
(Indicated as **battery charger** or **charger** in the text)
- 13 AC Mains Lead
- 14 AV Cable
- 15 USB Connection Cable
- 16 CD-ROM
  - Software:  
Use it to install the software to your PC.
- 17 CD-ROM
  - Operating Instructions
- 18 Shoulder Strap
- 19 Stylus pen

- SD Memory Card, SDHC Memory Card and SDXC Memory Card are indicated as **card** in the text.
- **The card is optional.**
- Description in these operating instructions is based on the interchangeable lens (H-H014).  
About unavailable functions such as [STABILIZER], Direction Detection function, description in these operating instructions is based on the interchangeable lens (H-FS014042 or H-PS14042).
- Consult the dealer or your nearest Service Centre if you lose the supplied accessories. (You can purchase the accessories separately.)

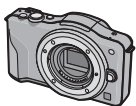
**1****DMC-GF3W \*4****DMC-GF3C \*1****2**

H-H014

**3**

VYF3371

**DMC-GF3K \*2****4**

H-FS014042

**5**

VYC1009

**6**

VYF3201

**7**

VFC4315

**DMC-GF3K \*2 / DMC-GF3 \*5****8**

VKF4385

**DMC-GF3X \*3****9**

H-PS14042

**10**

VYF3443

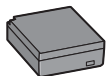
**11**

DMW-BLE9E

**12**

DE-A98A

**13**

K2CT39A00002

**14**

K1HY08YY0020

**15**

K1HY08YY0019

**16****17**

VFF0833

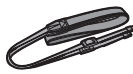
**18**

VFC4710

**19**

VGQ0C14

\*1 Supplied in DMC-GF3C only

\*3 Supplied in DMC-GF3X only

\*5 Supplied in DMC-GF3 only

\*2 Supplied in DMC-GF3K only

\*4 Supplied in DMC-GF3W only



## **Sales and Support Information**

### Customer Communications Centre

- For customers within the UK: 0844 844 3899
- For customers within Ireland: 01 289 8333
- For further support on your product, please visit our website:  
[www.panasonic.co.uk](http://www.panasonic.co.uk)

### Direct Sales at Panasonic UK

- Order accessory and consumable items for your product with ease and confidence by phoning our Customer Communications Centre Monday–Thursday 9:00 a.m.–5:30 p.m., Friday 9:30 a.m.–5:30 p.m. (Excluding public holidays)
- Or go on line through our Internet Accessory ordering application at [www.pas-europe.com](http://www.pas-europe.com).
- Most major credit and debit cards accepted.
- All enquiries transactions and distribution facilities are provided directly by Panasonic UK.
- It couldn't be simpler!
- Also available through our Internet is direct shopping for a wide range of finished products. Take a browse on our website for further details.

## ■ Optional Accessories

|                                 |   |
|---------------------------------|---|
| Lithium Ion Battery             | DMW-BLE9  |
| AC Adaptor*1                    | DMW-AC8   |
| DC Coupler*1                    | DMW-DCC11   |
| Zoom Lever                      | DMW-ZL1*2   |
| MC Protector                    | DMW-LMC46*3, DMW-LMC52*4, DMW-LMCH37*5  |
| ND Filter                       | DMW-LND46*3, DMW-LND52*4, DMW-LND37*5   |
| PL Filter (Circular Type)       | DMW-LPL46*3, DMW-LPL52*4, DMW-LPL37*5   |
| Lens Cap                        | DMW-LFC46*3, DMW-LFC52*4, DMW-LFC37*5   |
| Lens Rear Cap                   | DMW-LRC1*6  |
| Body Cap                        | DMW-BDC1  |
| Tripod Adaptor*7                | DMW-TA1   |
| HDMI mini Cable                 | RP-CDHM15, RP-CDHM30  |
| Interchangeable Lens            | H-VS014140, H-FS014042, H-FS014045, H-FS045200, H-F007014, H-ES045, H-H020, H-F008, H-H014, H-FS100300, H-X025, H-PS45175, H-PS14042<br>(Read P15 for information about other lenses that can be used.) |
| The 3D Interchangeable Lens     | H-FT012   |
| Mount Adaptor                   | DMW-MA1, DMW-MA2M, DMW-MA3R   |
| Class 10 64 GB SDXC Memory Card | RP-SDU64GE1K  |
| Class 10 32 GB SDHC Memory Card | RP-SDA32GE1K/RP-SDU32GE1K   |
| Class 10 16 GB SDHC Memory Card | RP-SDA16GE1K/RP-SDU16GE1K   |
| Class 10 8 GB SDHC Memory Card  | RP-SDA08GE1K/RP-SDU08GE1K   |
| Class 10 4 GB SDHC Memory Card  | RP-SDU04GE1K  |
| Class 6 32 GB SDHC Memory Card  | RP-SDQ32GE1K  |
| Class 6 16 GB SDHC Memory Card  | RP-SDQ16GE1K  |
| Class 6 8 GB SDHC Memory Card   | RP-SDQ08GE1K  |
| Class 6 4 GB SDHC Memory Card   | RP-SDQ04GE1K  |
| Class 4 16 GB SDHC Memory Card  | RP-SDN16GE1A  |
| Class 4 8 GB SDHC Memory Card   | RP-SDN08GE1A  |
| Class 4 4 GB SDHC Memory Card   | RP-SDN04GE1A  |
| Class 4 2 GB SD Memory Card     | RP-SDL02GE1K/RP-SDN02GE1A   |

Some optional accessories may not be available in some countries.

- \*1 The AC Adaptor (optional) can only be used with the designated Panasonic DC Coupler (optional). The AC adaptor (optional) cannot be used by itself.
- \*2 The interchangeable lens (H-H014 or H-PS14042) is not used.
- \*3 When the interchangeable lens (H-H014) is used
- \*4 When the interchangeable lens (H-FS014042) is used
- \*5 When the interchangeable lens (H-PS14042) is used
- \*6 If you are using other than the interchangeable lens (H-H014, H-FS014042 or H-PS14042), please use the optional accessories compatible with that lens.
- \*7 Use if the attached lens is in contact with the tripod pedestal.

# Names and Functions of Components

## ■ Camera body

- 1 Sensor
- 2 Flash
- 3 Self-timer indicator/  
AF Assist Lamp
- 4 Lens fitting mark
- 5 Mount
- 6 Lens lock pin
- 7 Lens release button

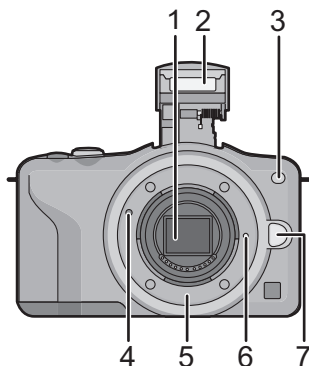

- 8 Flash open button
- 9 Touch panel/LCD monitor
- 10 Playback button
- 11 [Q.MENU/Fn] button/  
Delete/Return button
- 12 [MENU/SET] button
- 13 Control dial
- 14 Cursor buttons  
▲/Exposure Compensation button  
▶/WB (White Balance)  
◀/AF Mode button  
▼/[DRIVE MODE] button

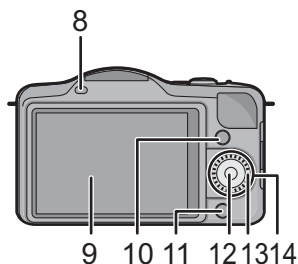

This button in picture record mode will allow the user to select between the following options.  
Single/Burst/Auto bracket/Self-timer

- 15 Shoulder strap eyelet
  - Be sure to attach the shoulder strap when using the camera to ensure that you will not drop it.
- 16 [HDMI] socket
- 17 [AV OUT/DIGITAL] socket

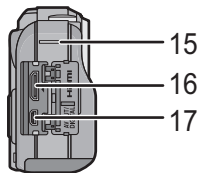

- 18 Microphone
  - Do not cover the microphone with your fingers.

- 19 Shutter button
- 20 Motion picture button
- 21 Speaker

- Do not cover the speaker with your fingers.

- 22 Focus distance reference mark
- 23 Intelligent Auto button

- 24 Camera ON/OFF switch
- 25 Status indicator

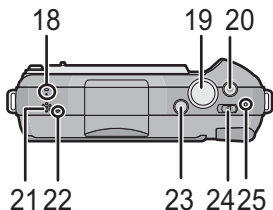

- 26 Tripod receptacle
- 27 Card/Battery door
- 28 DC coupler cover

- When using an AC adaptor, ensure that the Panasonic DC coupler (DMW-DCC11; optional) and AC adaptor (DMW-AC8E; optional) are used.

- Always use a genuine Panasonic AC adaptor (DMW-AC8E; optional).

- When using an AC adaptor, use the AC Mains Lead supplied with the AC adaptor.

- It is recommended to use a fully charged battery or AC adaptor when recording motion pictures.

- If while recording motion pictures using the AC adaptor and the power supply is cut off due to a power outage or if the AC adaptor is disconnected etc., the motion picture being recorded will not be recorded.

- 29 Release lever

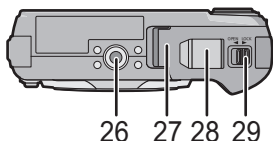

## ■ Lens

**H-H014**  
(LUMIX G 14 mm/F2.5 ASPH.)

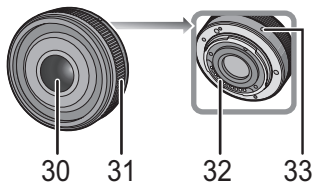

**H-FS014042**  
(LUMIX G VARIO 14–42 mm/F3.5–5.6  
ASPH./MEGA O.I.S.)

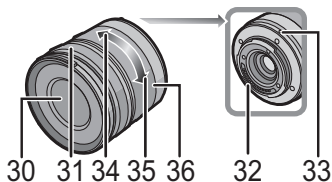

**H-PS14042**  
(LUMIX G X VARIO PZ 14–42 mm/F3.5–5.6 ASPH./POWER O.I.S.)

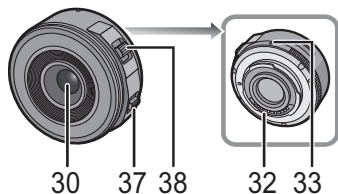

- 30 Lens surface
- 31 Focus ring
- 32 Contact point
- 33 Lens fitting mark
- 34 Tele
- 35 Wide
- 36 Zoom ring
- 37 Focus lever

Move the Focus lever to the **A** or **B**.

**A**: Focus on a subject that is close by

**B**: Focus on a subject that is far away

- Speed to focus will change depending on the amount moved.

- 38 Zoom lever

Move the zoom lever to the **[T]** (Tele side) or **[W]** (Wide side).

**[T]**: To make subjects appear closer use (Tele)

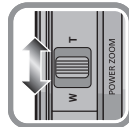
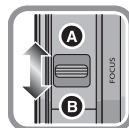

**[W]**: To make subjects appear further away use (Wide)

- The zoom speed varies depending on the range over which the zoom lever is moved. Zoom speed will be slower than normal when recording a motion picture.



## Touch Panel

This touch panel is a type that detects pressure.

| <b>Touch the screen</b><br>To touch and release the touch panel.   | <b>Drag</b><br>A movement without releasing the touch panel.   |
|--|--|
|  <p>Use this to perform tasks such as selecting icons or images displayed on the touch panel.</p> <ul style="list-style-type: none"><li>• When selecting features using the touch panel, be sure to touch the centre of the desired icon.</li></ul> |  <p>This is used to move the AF area, operate the slide bar, etc.<br/>This can also be used to move to the next image during playback, etc.</p> |

### Note

- If you use a commercially available liquid crystal protection sheet, please follow the instructions that accompany the sheet. (Some liquid crystal protection sheets may impair visibility or operability.)
- If a commercially available protection sheet is used, **a little extra pressure** may be required if you notice that the touch panel is not responsive.
- Avoid having the hand holding the camera accidentally apply pressure to the touch panel. Doing so may affect the touch panel operation.
- Do not press on the LCD monitor with hard pointed tips, such as ball point pens.
- Do not operate with your fingernails.
- Wipe the LCD monitor with dry soft cloth when it gets dirty with finger prints and others.
- Do not scratch or press the LCD monitor too hard.

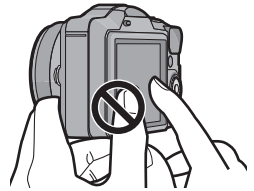

### ■ About the Stylus pen

It is easier to use the stylus pen (supplied) for detailed operation or if it is hard to operate with your fingers.

- Only use the supplied stylus pen.
- Do not place it where small children can reach.

## About the Lens

### ■ Micro Four Thirds™ mount specification lens

This unit can use the dedicated lenses compatible with the Micro Four Thirds System lens mount specification (Micro Four Thirds mount).



### ■ Four Thirds™ mount specification lens

Lens with the Four Thirds mount specification can be used by using the mount adaptor (DMW-MA1; optional).



### ■ Leica mount specification lens

- When you use the M mount adaptor or R mount adaptor (DMW-MA2M, DMW-MA3R; optional), you can use Leica M Mount or Leica R Mount interchangeable lenses.
  - For certain lenses, the actual distance at which the subject is in focus may differ slightly from the rated distance.
  - When using a Leica lens mount adaptor, set [SHOOT W/O LENS] to [ON].

## Enjoying 3D pictures

### ■ Taking 3D pictures

Attaching the 3D interchangeable lens (H-FT012; optional) to the camera allows you to take 3D pictures for extra impact.

### ■ Playing back 3D pictures

To view 3D pictures, a television that supports 3D is required.

Connecting the camera to a 3D compatible television and playing back pictures taken in 3D allows you to enjoy 3D pictures for extra impact.

It is also possible to playback the recorded 3D pictures by inserting an SD card into the 3D compatible television with an SD card slot.

**For current information regarding devices that can playback 3D pictures recorded with this unit, please refer to the below support site.**

**<http://panasonic.jp/support/global/cs/dsc/>** (This Site is English only.)

### Note

- Refer to the Operating Instructions (PDF format) for details.

## Changing the Lens

By changing the lens, you will increase your picture taking-options and further your enjoyment of the camera. Change the lens using the following procedure.

- Check that the camera is turned off.
- Change lenses where there is not a lot of dirt or dust.

### Detaching the lens

Preparations: Attach the lens cap.

- When using the interchangeable lens (H-PS14042), the lens barrel will not retract until the power switch is turned [OFF]. Change the lens only after turning the power switch [OFF] and checking that the lens barrel has retracted. (Do not push in the lens barrel with your fingers. Doing so may damage the lens.)

**While pressing on the lens release button (A), rotate the lens toward the arrow until it stops and then remove.**

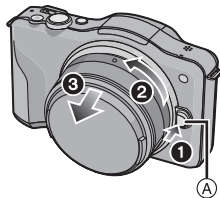



## Attaching the lens

- Preparations: Remove the rear lens cap from the lens.
- If the body cap is fitted to the camera, remove it.

**Align the lens fitting marks **Ⓑ** (red marks) and then rotate the lens in the direction of the arrow until it clicks.**

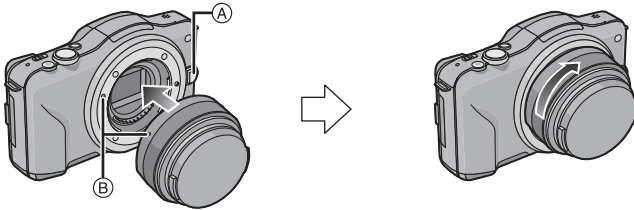

- Do not press the lens release button **Ⓐ** when you attach a lens.
- Do not try to attach the lens when holding it at an angle to the camera body as the lens mount may get scratched.
- Be sure to remove the lens cap when recording.

### Note

- Do not insert your fingers into the mount when the lens and body cap are removed from the camera body.
- To prevent dust or debris from adhering to internal parts of the camera body, fit the body cap or a lens to the mount on the camera body.
- To prevent scratching of the contact points, fit the lens rear cap to the lens when it is unattached or fit the lens to the camera body.
- It is recommended to attach the lens cap or attach the MC Protector (optional) to protect the lens surface when carrying.

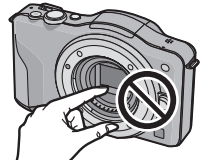

## Attaching the Lens Hood

In bright sunlight or backlight, the lens hood will minimise lens flare and ghosting. The lens hood cuts off excess lighting and improves the picture quality.

**To attach the lens hood (flower shape) that came with the interchangeable lens (H-FS014042)**

- The interchangeable lens (H-H014 or H-PS14042) does not have a lens hood.

**Insert the lens hood into the lens with the short sides at the top and bottom, and turn in the direction of the arrow until it stops.**

- Ⓐ Fitting to the mark.

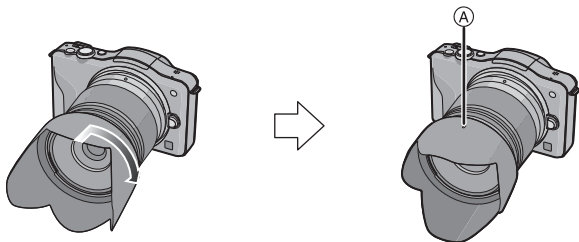

### Note

- When temporarily detaching and carrying the lens hood, attach the lens hood to the lens in the reverse direction.

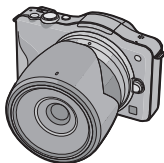

## Attaching the Shoulder Strap

- We recommend attaching the shoulder strap when using the camera to prevent it from dropping.

- 1** Pass the shoulder strap through the shoulder strap eyelet on the camera body.

(A): Shoulder strap eyelet

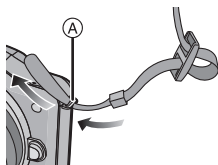

- 2** Pass the end of the shoulder strap through the ring in the direction of the arrow and then pass it through the stopper.

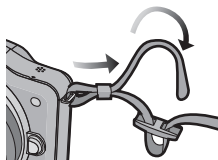

- 3** Pass the end of the shoulder strap through the hole on the other side of the stopper.

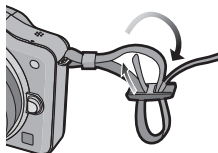

- 4** Pull the other side of the shoulder strap and then check that it will not come out.

- Perform steps **1** to **4** and then attach the other side of the shoulder strap.

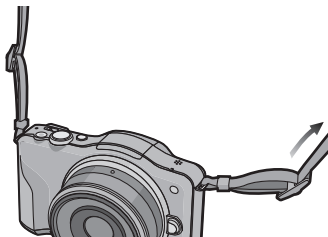

### Note

- Use the shoulder strap around your shoulder.
  - Do not wrap the strap around your neck.
  - It may result in injury or accident.
- Do not leave the shoulder strap where an infant can reach it.
  - It may result in an accident by mistakenly wrapping around the neck.

## Charging the Battery

### ■ About batteries that you can use with this unit

The battery that can be used with this unit is DMW-BLE9E.

It has been found that counterfeit battery packs which look very similar to the genuine product are made available to purchase in some markets. Some of these battery packs are not adequately protected with internal protection to meet the requirements of appropriate safety standards. There is a possibility that these battery packs may lead to fire or explosion. Please be advised that we are not liable for any accident or failure occurring as a result of use of a counterfeit battery pack. To ensure that safe products are used we would recommend that a genuine Panasonic battery pack is used.

- Use the dedicated charger and battery.

### Charging

- The battery is not charged when the camera is shipped. Charge the battery before use.
- Charge the battery with the charger indoors.

- 1** Attach the battery paying attention to the direction of the battery.

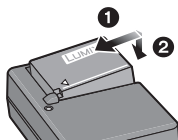

- 2** Connect the AC mains lead.

- Disconnect the charger from the electrical socket and detach the battery after charging is completed.

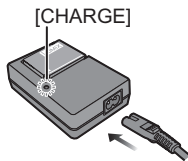

### ■ About the [CHARGE] indicator

**On:** It will light up while charging.

**Off:** It will turn off when it completes the charging normally.

#### • When the [CHARGE] indicator flashes

- The battery temperature is too high or too low. It is recommended to charge the battery again in an ambient temperature of between 10 °C and 30 °C (50 °F and 86 °F).
- The terminals of the charger or the battery are dirty. In this case, wipe them with a dry cloth.

## ■ Charging time

Charging time

Approx. 180 min

- The indicated charging time is for when the battery has been discharged completely. The charging time may vary depending on how the battery has been used. The charging time for the battery in hot/cold environments or a battery that has not been used for a long time may be longer than normal.

## Approximate operating time and number of recordable pictures

### ■ Battery indication

The battery indication is displayed on the screen.



- The indication turns red and blinks if the remaining battery power is exhausted. (The status indicator also blinks) Recharge the battery or replace it with a fully charged battery.

### ■ Recording still pictures (By CIPA standard in Programme AE Mode)

When the interchangeable lens (H-H014) is used

Number of recordable pictures

Approx. 340 pictures

Recording time

Approx. 170 min

When the interchangeable lens (H-FS014042) is used

Number of recordable pictures

Approx. 320 pictures

Recording time

Approx. 160 min

When the interchangeable lens (H-PS14042) is used

Number of recordable pictures

Approx. 330 pictures

Recording time

Approx. 165 min

### Recording conditions by CIPA standard

- CIPA is an abbreviation of [Camera & Imaging Products Association].
- Temperature: 23 °C (73.4 °F)/Humidity: 50%RH when LCD monitor is on.
- Using a Panasonic SD Memory Card (2 GB).
- Using the supplied battery.
- Starting recording 30 seconds after the camera is turned on.  
[When the interchangeable lens (H-H014) is used]
- **Recording once every 30 seconds** with full flash every second recording.
- Turning the camera off every 10 recordings and leaving it until the temperature of the battery decreases.
- Starting recording 30 seconds after the camera is turned on. (When the Optical Image Stabilizer function is set to [I(III)]).  
[When the interchangeable lens (H-FS014042 or H-PS14042) is used]
- Moving the zoom lever from Tele to Wide or vice versa in every recording.  
[When the interchangeable lens (H-PS14042) is used]

**The number of recordable pictures varies depending on the recording interval time. If the recording interval time becomes longer, the number of recordable pictures decreases. [For example, if you were to take one picture every two minutes, then the number of pictures would be reduced to approximately one-quarter of the number of pictures given above (based upon one picture taken every 30 seconds).]**

## ■ Recording motion pictures

– [AVCHD] (Recording with picture quality set to [FSH])

| When the interchangeable lens (H-H014) is used |                 |
|--|-----------------|
| Recordable time                                | Approx. 150 min |
| Actual recordable time                         | Approx. 75 min  |

| When the interchangeable lens (H-FS014042) is used |                 |
|--|-----------------|
| Recordable time                                    | Approx. 130 min |
| Actual recordable time                             | Approx. 65 min  |

| When the interchangeable lens (H-PS14042) is used |                 |
|---|-----------------|
| Recordable time                                   | Approx. 140 min |
| Actual recordable time                            | Approx. 70 min  |

– [MOTION JPEG] (Recording with picture quality set to [HD])

| When the interchangeable lens (H-H014) is used |                 |
|--|-----------------|
| Recordable time                                | Approx. 160 min |
| Actual recordable time                         | Approx. 80 min  |

| When the interchangeable lens (H-FS014042) is used |                 |
|--|-----------------|
| Recordable time                                    | Approx. 140 min |
| Actual recordable time                             | Approx. 70 min  |

| When the interchangeable lens (H-PS14042) is used |                 |
|---|-----------------|
| Recordable time                                   | Approx. 150 min |
| Actual recordable time                            | Approx. 75 min  |

- These times are for an ambient temperature of 23 °C (73.4 °F) and a humidity of 50%RH. Please be aware that these times are approximate.
- Actual recordable time is the time available for recording when repeating actions such as switching the power supply [ON]/[OFF], starting/stopping recording etc.
- Motion pictures can be recorded continuously for up to 29 minutes 59 seconds. Also, motion picture recorded continuously in [MOTION JPEG] is up to 2 GB. Remaining time for continuous recording is displayed on the screen.

## ■ Playback

| When the interchangeable lens (H-H014) is used |                 |
|--|-----------------|
| Playback time                                  | Approx. 270 min |

| When the interchangeable lens (H-FS014042) is used |                 |
|--|-----------------|
| Playback time                                      | Approx. 250 min |

| When the interchangeable lens (H-PS14042) is used |                 |
|---|-----------------|
| Playback time                                     | Approx. 270 min |

## Inserting and Removing the Card (optional)/the Battery

- Check that this unit is turned off.
- We recommend using a Panasonic card.

**1** Slide the release lever in the direction of the arrow and open the card/battery door.

- Always use genuine Panasonic batteries (DMW-BLE9E).
- If you use other batteries, we cannot guarantee the quality of this product.

**2** **Battery:** Being careful about the battery orientation, insert all the way until you hear a locking sound and then check that it is locked by lever (A). Pull the lever (A) in the direction of the arrow to remove the battery.

**Card:** Push it securely all the way until you hear a “click” while being careful about the direction in which you insert it. To remove the card, push the card until it clicks, then pull the card out upright.

(B): Do not touch the connection terminals of the card.

**3** **1:** Close the card/battery door.

**2:** Slide the release lever in the direction of the arrow.

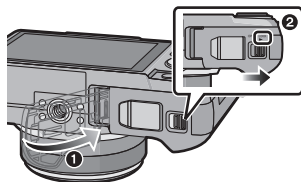
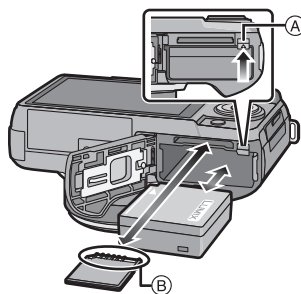
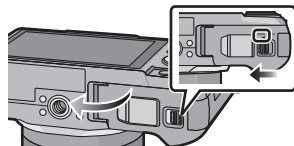

# About the Card

## About cards that can be used with this unit

The following cards which conform to the SD video standard can be used with this unit. (These cards are indicated as **card** in the text.)

|  | Remarks  |
|--|--|
| <b>SD Memory Card</b><br>(8 MB to 2 GB)    | <ul style="list-style-type: none"><li>• Use a card with SD Speed Class* with “Class 4” or higher when recording motion pictures in [AVCHD]. Also, use a card with SD Speed Class with “Class 6” or higher when recording motion pictures in [MOTION JPEG].</li><li>• SDHC Memory Card can be used with SDHC Memory Card or SDXC Memory Card compatible equipment.</li><li>• SDXC Memory Card can only be used with SDXC Memory Card compatible equipment.</li><li>• Check that the PC and other equipment are compatible when using the SDXC Memory Cards.<br/><a href="http://panasonic.net/avc/sdcard/information/SDXC.html">http://panasonic.net/avc/sdcard/information/SDXC.html</a></li><li>• Only the cards with capacity listed left can be used.</li></ul> |
| <b>SDHC Memory Card</b><br>(4 GB to 32 GB) |  |
| <b>SDXC Memory Card</b><br>(48 GB, 64 GB)  |  |

\* SD Speed Class is the speed standard regarding continuous writing. Check via the label on the card, etc.

e.g.:

CLASS 4

4

CLASS 6

6

### Access to the card

The access indication lights red when pictures are being recorded on the card.



• Do not turn this unit off, remove its battery or card, or disconnect the AC adaptor (DMW-AC8E; optional) when the access indication is lit (when pictures are being written, read or deleted, or the card is being formatted). Furthermore, do not subject the camera to vibration, impact or static electricity.

The card or the data on the card may be damaged, and this unit may no longer operate normally.

If operation fails due to vibration, impact or static electricity, perform the operation again.

• Please confirm the latest information on the following website.

<http://panasonic.jp/support/global/cs/dsc/>

(This Site is English only.)

### Note

• Keep the Memory Card out of reach of children to prevent swallowing.



## Setting Date/Time (Clock Set)

The clock can be setup with the following procedure at the time of purchase. Change the clock setting in [CLOCK SET] of the [SETUP] menu.  
For details, read the PDF.

- The clock is not set when the camera is shipped.

### 1 Turn the camera on.

- The status indicator ❶ lights when you turn this unit on.

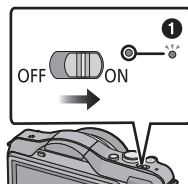

### 2 Touch [CLOCK SET].



### 3 Touch the items you wish to set (Year/Month/Day/Hours/Minutes), and set using [▲]/[▼].

- You can continue to switch the settings by continuously touching [▲]/[▼].
- Touch [CANCEL] to cancel the date and time settings without setting a date and time.



#### To set the display order and the time display format.

- Touch [STYLE] to display the settings screen for setting display order/time display format.

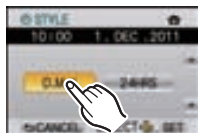

### 4 Touch [SET] to set.

### 5 Touch [SET] in the confirmation screen.

# Selecting the Recording Mode

**1** Press [MENU/SET].

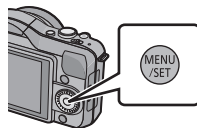

**2** Touch [REC MODE].

- A screen listing the Recording Mode is displayed.
- It is also possible to display the screen listing the Recording Mode by touching the Recording Mode icon in Recording Mode.



**3** Touch the Recording Mode to select.

- [i] is turned on when [i] is touched, and a description of the Recording Mode is displayed when Recording Mode is touched. It will return to the screen listing the Recording Mode when [CANCEL] is touched, and [i] will turn off.

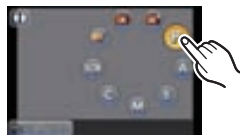

## ■ Basic

### **Intelligent Auto Mode**

The subjects are recorded using settings automatically selected by the camera.

### **Intelligent Auto Plus Mode**

Easily match settings selected by the camera to your preferences and record.

### **Programme AE Mode**

The subjects are recorded using your own settings.

## ■ Advanced

### **Aperture-Priority AE Mode**

The shutter speed is automatically determined by the aperture value you set.

### **Shutter-Priority AE Mode**

The aperture value is automatically determined by the shutter speed you set.

### **Manual Exposure Mode**

The exposure is adjusted by the aperture value and the shutter speed which are manually adjusted.

### **Custom Mode**

Use this mode to take pictures with previously registered settings.

### **Scene Mode**

This allows you to take pictures that match the scene being recorded.

### **Creative Control Mode**

Record while checking the image effect.

## Taking a Still picture

- Set the drive mode to [] by pressing  ( ).

### 1 Selecting the Recording Mode.

### 2 Press the shutter button halfway to focus.

- (A) Aperture value
- (B) Shutter speed

- Aperture value and shutter speed are displayed. (It will flash in red if the correct exposure is not achieved, except when set to flash.)
- **When the image is correctly focused, the picture will be taken, since the [FOCUS PRIORITY] is set initially to [ON].**



### 3 Press the shutter button fully (push it in further), and take the picture.



Recording Mode: **iA**

## Taking Pictures using the Automatic Function (Intelligent Auto Mode)

The camera will set the most appropriate settings to match the subject and the recording conditions so we recommend this mode for beginners or those who want to leave the settings to the camera and take pictures easily.

Set Recording Mode to **iA**.



- Defocus control can be set by touching  in the recording screen.
- When the subject is touched, AF Tracking function works. It is also possible by pressing the cursor button towards ◀, and then pressing the shutter button halfway.
- **[FOCUS PRIORITY] is fixed to [ON]. When the subject is correctly focused, the picture will be taken.**



### ■ About **iA** button

By pressing the **iA** button, you can switch between the Intelligent Auto (**iA** or **iA+**) Mode of the Recording Mode and other modes.

- When the Recording Mode is **iA** or **iA+**, the **iA** button lights up. (Light turns off during recording)



## ■ Scene Detection

When the camera identifies the optimum scene, the icon of the scene concerned is displayed in blue for 2 seconds, after which its colour changes to the usual red.



### When taking pictures

|   |                     |                              |
|---|---------------------|------------------------------|
| → | [i- PORTRAIT]       |                              |
|   | [i- SCENERY]        |                              |
|   | [i- MACRO]          |                              |
|   | [i- NIGHT PORTRAIT] | • Only when [iA] is selected |
|   | [i- NIGHT SCENERY]  |                              |
|   | [i- BABY]*          |                              |
|   | [i- SUNSET]         |                              |

\* When [FACE RECOG.] is set to [ON], will be displayed for birthdays of registered faces already set only when the face of a person 3 years old or younger is detected.

### When recording motion pictures

|   |                |
|---|----------------|
| → | [i- PORTRAIT]  |
|   | [i- SCENERY]   |
|   | [i- LOW LIGHT] |
|   | [i- MACRO]     |

- is set if none of the scenes are applicable, and the standard settings are set.
- When , , or is selected, the camera automatically detects a person's face, and it will adjust the focus and exposure. (**Face Detection**)
- If a tripod is used, for instance, and the camera has judged that camera shake is minimal when the Scene Mode has been identified as , the shutter speed will be slower than normal. Take care not to move the camera while taking pictures.
- An optimum scene for the specified subject will be chosen when set to AF tracking.
- When [FACE RECOG.] is set to [ON], and the face similar to the registered face is detected, [R] is displayed in the top right of , , and .
- Due to conditions such as the ones below, a different scene may be identified for the same subject.
  - Subject conditions: When the face is bright or dark, the size of the subject, the colour of the subject, the distance to the subject, the contrast of the subject, when the subject is moving
  - Recording conditions: Sunset, sunrise, under low brightness conditions, when the camera is shaken, when zoom is used
- To take pictures in an intended scene, it is recommended that you take pictures in the appropriate Recording Mode.

## Easily adjust and record (Intelligent Auto Plus Mode)

The brightness and colour optimally set by the camera can be easily matched to your preferences. This mode is useful if you do not like dealing with detailed settings but like the settings made automatically by the camera to match your preferences.

### Set Recording Mode to .

- Except for allowing setting of the brightness and colour, Intelligent Auto Plus Mode is identical to Intelligent Auto Mode.



### Setting brightness

- 1 Press  to display the setting screen.

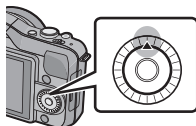

- 2 Touch the slide bar to set.

- This will adjust the brightness of the image.
- Setting can also be performed by rotating the control dial.
- Pressing the  cursor button again returns to the recording screen.



### Setting colour

- 1 Press  (WB) to display the setting screen.

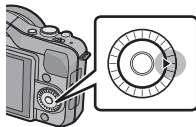

- 2 Touch the slide bar to set.

- This will adjust the colour of the image from a reddish colour to a bluish colour.
- Setting can also be performed by rotating the control dial.
- Pressing the  cursor button again returns to the recording screen.



## Taking Pictures with Defocus Control Function

You can easily set the blurriness of the background while checking the screen.

**1** Touch  to display the setting screen.

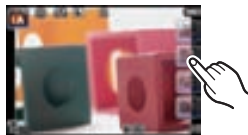



**2** Touch the slide bar to set.

- Setting can also be performed by rotating the control dial.



**3** Recording of pictures or motion pictures.

- It is also possible to record a picture by touching .
- Defocus Control operation can be ended by touching .



## Taking Pictures with Your Favourite Settings (Programme AE Mode)

The camera automatically sets the shutter speed and the aperture value according to the brightness of the subject.

You can take pictures with greater freedom by changing various settings in [REC] Mode menu.

### Set Recording Mode to **[P]**.

#### Note

- The shutter speed is automatically set between about 20 seconds and 1/4000th of a second in the following cases.
  - When the [SENSITIVITY] is set to [ISO160].
  - When the aperture value is set to F2.5 [when the interchangeable lens (H-H014) is attached].
  - When the aperture value is set to F3.5 [when the interchangeable lens (H-FS014042 or H-PS14042) is attached].

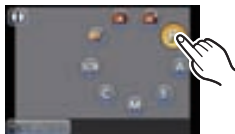

### Programme Shift

In Programme AE Mode, you can change the preset aperture value and shutter speed without changing the exposure. This is called Programme Shift.

You can make the background more blurred by decreasing the aperture value or record a moving subject more dynamically by slowing the shutter speed when taking a picture in Programme AE Mode.

- 1 Press the shutter button halfway and display the aperture value and shutter speed value on the screen.**
- 2 While the values are displayed (about 10 seconds), perform the Programme Shift by rotating the control dial.**

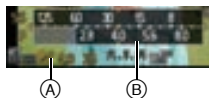

- During display of the numerical values, each press of the cursor button **▲** switches between Programme Shift and Exposure Compensation.
- Rotate the control dial to display the [EXPO.METER] **ⓑ**.
- The Programme Shift indication **Ⓐ** appears on the screen when Programme Shift is activated.
- To cancel Programme Shift, turn the camera off or rotate the control dial until the Programme Shift indication disappears.

## Recording Motion Picture

This can record full high definition motion pictures compatible with the AVCHD format or motion pictures recorded in Motion JPEG.

Audio will be recorded in monaural.

The functions available when recording motion pictures differ according to the lens you are using, and the operational sound of the lens may be recorded.

Recording of motion picture appropriate for each mode is possible.

- Screen here is an example of when the Recording Mode is set to **[P]** (Programme AE Mode).

### 1 Start recording by pressing the motion picture button.

- (A) Elapsed recording time
- (B) Available recording time

- The recording state indicator (red) (C) will flash while recording motion pictures.
- When recording a motion picture, do not cover the microphone with your fingers or other objects.

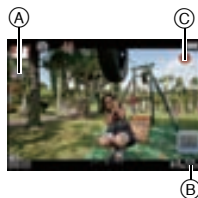
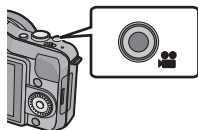

### 2 Stop the recording by pressing the motion picture button again.

#### Note

- Motion pictures can be recorded continuously for up to 29 minutes 59 seconds. Also, motion picture recorded continuously in [MOTION JPEG] is up to 2 GB. Remaining time for continuous recording is displayed on the screen.

# Playing Back Pictures/Motion Pictures

## Playing Back Pictures

**1** Press [▶].



**2** Forward or rewind the image by dragging the screen horizontally.

**Forward:** drag from right to left

**Rewind:** drag from left to right

- It is also possible to forward or rewind the image by pressing ◀/▶ of the cursor button.
- Speed of picture forwarding/rewinding changes depending on the playback status.
- You can forward or rewind pictures continuously by keeping your finger on the left or right sides of the screen after forwarding/rewinding a picture.  
(Pictures are displayed reduced in size)



### ■ To finish playback

Press [▶] again, press the motion picture button or press the shutter button halfway.

## Playing Back Motion Pictures

- This unit was designed to play motion pictures using the AVCHD and QuickTime Motion JPEG formats that were taken with this model (only).
- Motion pictures in AVCHD format that can be played back on this unit are [AVCHD] motion pictures that were recorded with this unit, AVCHD format (including [AVCHD Lite]) motion pictures recorded with Panasonic digital cameras (LUMIX) only.

### 1 Press [▶].



### 2 Select a picture with a Motion Picture icon ([▶]), [▶], and then touch [▶] to play back.

- (A) Motion picture icon
- (B) The motion picture recording time



- After playback starts, the elapsed playback time is displayed on the screen.  
For example, 8 minutes and 30 seconds is displayed as [8m30s].
- Some information (recording information, etc.) is not displayed for motion pictures recorded in [AVCHD].
- Pressing the cursor button ▲ to allows you to play back motion pictures.  
Display at the bottom right of the screen while playing back corresponds to ▲/▼/◀/▶ on the cursor button.

## ■ Operations performed during Motion Picture Playback

### 1 Display control panel by touching screen.







- If no operation is performed for 2 seconds, it will return to original status.

### 2 Operate control panel by touching.

|   |  |   |   |
|---|--|---|---|
|  | Play/Pause                               |  | Stop                                      |
|  | Fast rewind                              |  | Fast forward                              |
|  | Frame-by-frame rewind<br>(while pausing) |  | Frame-by-frame forward<br>(while pausing) |
|  | Increase volume level                    |  | Reduce volume level                       |

- \* Not displayed when playing back motion pictures recorded with [MINIATURE EFFECT] in Creative Control Mode.

#### • About fast forward/rewind playback

- Touch  during playback to fast forward (touch  to fast rewind). The fast forward/rewind speed increases if you touch / again. (The display on the screen changes from  to .)
- Touch  to resume normal playback speed.
- When using a high capacity card, it is possible that fast rewinding may be slower than usual.

## Deleting Pictures

Once deleted, pictures cannot be recovered.

Press [▶].



### To delete a single picture

- 1 Select the picture to be deleted, and then touch [🗑️].

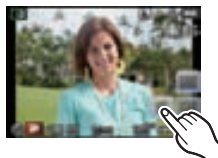

- 2 Touch [DELETE SINGLE].

- Confirmation screen is displayed.  
Picture is deleted by selecting [YES].

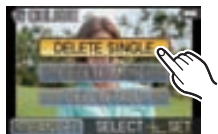





## Setting the Menu

When [MENU/SET] is pressed, [REC MODE] (A) and 5 menus (B) ([REC], [MOTION PICTURE], [CUSTOM], [SETUP], and [PLAYBACK]) are displayed.

In the 5 different menus, there are menus that allow you to setup the recording or playback to your preference, or make it more fun and easier to use the camera.

In particular, the [SETUP] menu contains some important settings relating to the camera's clock and power. Check the settings of this menu before proceeding to use the camera.



| Menu   | Description of settings   |
|--|---|
|  [REC]            | This menu lets you set the aspect ratio, number of pixels and other aspects of the pictures you are recording.  |
|  [MOTION PICTURE] | This menu lets you set the [REC MODE], [REC QUALITY], and other aspects for motion picture recording.   |
|  [CUSTOM]         | Operation of the unit, such as displaying of the screen and button operations, can be set up according to your preferences. Also, it is possible to register the modified settings. |
|  [SETUP]          | This menu lets you perform the clock settings, select the operating beep tone settings and set other settings which make it easier for you to operate the camera.                   |
|  [PLAYBACK]       | This menu lets you set the Protection, Cropping or Print Settings, etc. of recorded pictures.   |

## Setting menu items

- If you set [MENU RESUME] in the [CUSTOM] menu to [ON], the screen shows the last selected menu item when the camera was turned off. It is set to [ON] at the time of purchase.

### 1 Press [MENU/SET].

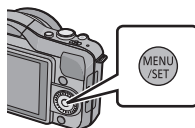

### 2 Select the menu by pressing ▲/▼/◀/▶ or by rotating the control dial.

- It can also be set by the touch operation.

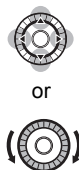

### 3 Press [MENU/SET] to display the menu.

### 4 Select the menu item by pressing ▲/▼ or by rotating the control dial.

- Select the item at the very bottom, and press ▼ or rotate the control dial to move to the next screen.

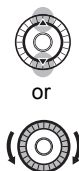

### 5 Press [MENU/SET].

- Depending on the menu item, its setting may not appear or it may be displayed in a different way.



**6** Select the settings by pressing ▲/▼ or by rotating the control dial.

- The figure on the right is an example of setting [I.DYNAMIC] from [OFF] to [HIGH].

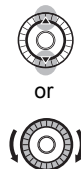

**7** Press [MENU/SET] to set.

■ Close the menu

Press [🗑️/↩️] several times or press the shutter button halfway.

■ Switching to other menus

e.g.: Switching to the [SETUP] menu from [REC] Mode menu

**1** Press ◀.

- Ⓐ Menu toggle icon



**2** Press ▼ or rotate the control dial to select the [SETUP] menu icon [🔧].

**3** Press ▶.

- Select a menu item next and set it.

## Compensating the Exposure

Use this function when you cannot achieve appropriate exposure due to the difference in brightness between the subject and the background. Look at the following examples.

**Underexposed**



**Properly exposed**





**Overexposed**



Compensate the exposure towards positive.

Compensate the exposure towards negative.

- 1** Press  () to switch to Exposure Compensation operation.

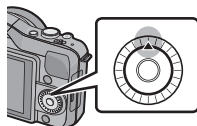

- 2** Rotate the control dial to compensate the exposure.

- (A) Exposure Compensation value
- (B) [EXPO.METER]

- Select [0] to return to the original exposure.
- Rotate the control dial to display the [EXPO.METER]. (However, it does not appear in **SCN**/ Mode.)



## Taking Pictures by Specifying the Aperture/ Shutter Speed

### Aperture-priority AE

Set the aperture value to a higher number when you want a sharp focus background. Set the aperture value to a lower number when you want a soft focus background.

**1** Set Recording Mode to **[A]**.

**2** Rotate the control dial to set the aperture value.

- Each press of the cursor button **▲** switches between Aperture Setting and Exposure Compensation.

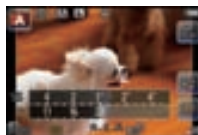

### Shutter-priority AE

When you want to take a sharp picture of a fast moving subject, set with a faster shutter speed. When you want to create a trail effect, set to a slower shutter speed.

**1** Set Recording Mode to **[S]**.

**2** Rotate the control dial to set the shutter speed.

- Each press of the cursor button **▲** switches between Shutter Speed Setting and Exposure Compensation.



## Manual Exposure Mode

Determine the exposure by manually setting the aperture value and the shutter speed. The Manual Exposure Assistance appears on the lower portion of the screen to indicate the exposure.

**1** Set Recording Mode to [M].



**2** Rotate the control dial to set the aperture and shutter speed.

- Each press of the cursor button ▲ switches between Aperture Setting and Shutter Speed Setting.

Ⓐ Manual Exposure Assistance



### Manual Exposure Assistance

|   |  |
|---|--|
|  | The exposure is adequate.                              |
|  | Set to faster shutter speed or larger aperture value.  |
|  | Set to slower shutter speed or smaller aperture value. |

- The Manual Exposure Assistance is an approximation. We recommend checking the pictures on the playback screen.

## Reading the Operating Instructions (PDF format)

More detailed instructions on the operation of this camera are contained in “Operating Instructions for advanced features (PDF format)” in the supplied CD-ROM. Install it on your PC to read it.

### ■ For Windows

- 1** Turn the PC on and insert the CD-ROM containing the Operating Instructions (supplied).
- 2** Select the desired language and then click [Operating Instructions] to install.
- 3** Double click the “Operating Instructions” shortcut icon on the desktop.

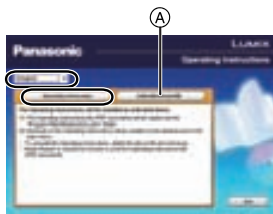

### ■ When the Operating Instructions (PDF format) will not open

You will need Adobe Acrobat Reader 5.0 or later or Adobe Reader 7.0 or later to browse or print the Operating Instructions (PDF format).

Insert the CD-ROM containing the Operating Instructions (supplied), click (A) and then follow the messages on the screen to install.

(Compatible OS: Windows XP SP3/Windows Vista SP2/Windows 7)

- You can download and install a version of Adobe Reader that you can use with your OS from the following Web Site.

<http://get.adobe.com/reader/otherversions>

### ■ To uninstall the Operating Instructions (PDF format)

Delete the PDF file from the “Program Files\Panasonic\Lumix\” folder.

### ■ For Mac

- 1** Turn the PC on and insert the CD-ROM containing the Operating Instructions (supplied).
- 2** Open the “Manual” folder in the CD-ROM and then copy the PDF file with the desired language inside the folder.
- 3** Double click the PDF file to open it.

## Specifications

### Digital Camera Body (DMC-GF3):

Information for your safety

|                           |   |
|---------------------------|---|
| <b>Power Source:</b>      | DC 8.4 V  |
| <b>Power Consumption:</b> | 2.3 W (When recording)<br>[When the Interchangeable lens (H-H014) is used]<br>2.4 W (When recording)<br>[When the Interchangeable lens (H-FS014042) is used]<br>2.3 W (When recording)<br>[When the Interchangeable lens (H-PS14042) is used]<br>1.5 W (When playing back)<br>[When the Interchangeable lens (H-H014) is used]<br>1.6 W (When playing back)<br>[When the Interchangeable lens (H-FS014042) is used]<br>1.5 W (When playing back)<br>[When the Interchangeable lens (H-PS14042) is used] |

|   |  |
|---|--|
| <b>Camera effective pixels</b>  | 12,100,000 pixels  |
| <b>Image sensor</b>   | 4/3" Live MOS sensor, total pixel number 13,060,000 pixels, Primary colour filter  |
| <b>Digital Zoom</b>   | Max. 4×  |
| <b>Extra Tele Conversion</b><br>(Except for the maximum picture size for each aspect ratio) | ON/OFF simple enlargement (compatible with lenses from other manufacturers)  |
| <b>Focus</b>  | Auto Focus/Manual Focus,<br>Face Detection/AF Tracking/23-area-focusing/<br>1-area-focusing/Pinpoint (Touch focus area selection possible) |
| <b>Shutter system</b>   | Focal-plane shutter  |
| <b>Burst recording</b>  |  |
| <b>Burst speed</b>  | 3.8 pictures/second (High speed),<br>2.8 pictures/second (Middle speed),<br>2 pictures/second (Low speed)                                  |
| <b>Number of recordable pictures</b>  | Max. 5 pictures (when there are RAW files)<br>Depends on the capacity of the card<br>(when there are no RAW files)                         |
| <b>ISO sensitivity (Standard Output Sensitivity)</b>  | AUTO/ $\frac{1}{2}$ ISO/160/200/400/800/1600/3200/6400<br>(1/3 EV step change possible)  |

|                             |   |
|-----------------------------|---|
| <b>Minimum Illumination</b> | Approx. 6 lx (when i-Low light is used, the shutter speed is 1/25th of a second)<br>[When the Interchangeable lens (H-H014) is used]<br>Approx. 11 lx (when i-Low light is used, the shutter speed is 1/25th of a second)<br>[When the interchangeable lens (H-FS014042 or H-PS14042) is used]  |
| <b>Shutter speed</b>        | 60 seconds to 1/4000th of a second  |
| <b>Metering range</b>       | EV 0 to EV 18   |
| <b>White Balance</b>        | Auto White Balance/Daylight/Cloudy/Shade/Incandescent lights/Flash/White set1/White set2/White Balance K set  |
| <b>Exposure (AE)</b>        | Programme AE (P)/Aperture-priority AE (A)/Shutter-priority AE (S)/Manual exposure (M)/AUTO<br>Exposure Compensation (1/3 EV Step, -3 EV to +3 EV)   |
| <b>Metering Mode</b>        | Multiple/Centre weighted/Spot   |
| <b>LCD monitor</b>          | 3.0" TFT LCD (3:2)<br>(Approx. 460,000 dots) (field of view ratio about 100%)<br>Touch panel  |
| <b>Flash</b>                | Built-in pop up flash<br>GN 6.3 equivalent (ISO160·m)<br>Flash range:<br>Approx. 50 cm (1.64 feet) to 5.6 m (18.4 feet)<br>[When the Interchangeable lens (H-H014) is mounted, [ISO AUTO] is set]<br>Flash range:<br>Approx. 1.0 m (3.28 feet) to 3.4 m (11.2 feet)<br>[When the Interchangeable lens (H-FS014042) is mounted, focal length is 18 mm, [ISO AUTO] is set, and the aspect ratio is set to <b>[4:3]</b> ]<br>Approx. 30 cm (0.99 feet) to 4.0 m (13.1 feet)<br>[When the Interchangeable lens (H-PS14042) is mounted, WIDE, [ISO AUTO] is set]<br>AUTO, AUTO/Red-Eye Reduction, Forced ON, Forced ON/Red-Eye Reduction, Slow Sync., Slow Sync./Red-Eye Reduction, Forced OFF |

|                                    |  |
|------------------------------------|--|
| <b>Flash synchronization speed</b> | Equal to or smaller than 1/160th of a second   |
| <b>Microphone</b>                  | Monaural   |
| <b>Speaker</b>                     | Monaural   |
| <b>Recording media</b>             | SD Memory Card/SDHC Memory Card/SDXC Memory Card   |
| <b>Picture size</b>                |  |
| <b>Still picture</b>               | When the aspect ratio setting is [4:3]<br>4000×3000 pixels, 2816×2112 pixels, 2048×1536 pixels<br>When the aspect ratio setting is [3:2]<br>4000×2672 pixels, 2816×1880 pixels, 2048×1360 pixels<br>When the aspect ratio setting is [16:9]<br>4000×2248 pixels, 2816×1584 pixels, 1920×1080 pixels<br>When the aspect ratio setting is [1:1]<br>2992×2992 pixels, 2112×2112 pixels, 1504×1504 pixels                |
| <b>Recording quality</b>           |  |
| <b>Motion pictures</b>             | [AVCHD] (With audio)<br>When set to [FSH]: 1920×1080 pixels (50i* recording/<br>Approx. 17 Mbps)/<br>When set to [SH]: 1280×720 pixels (50p* recording/<br>Approx. 17 Mbps)<br>(*Sensor output is 25 frames/sec.)<br>[MOTION JPEG] (With audio)<br>When set to [HD]: 1280×720 pixels (30 frames/sec.)/<br>When set to [VGA]: 640×480 pixels (30 frames/sec.)/<br>When set to [QVGA]: 320×240 pixels (30 frames/sec.) |
| <b>Quality</b>                     | RAW/RAW+ Fine/RAW+ Standard/Fine/Standard/MPO+ Fine/<br>MPO+ Standard  |
| <b>Recording file format</b>       |  |
| <b>Still Picture</b>               | RAW/JPEG (based on “Design rule for Camera File system”,<br>based on “Exif 2.3” standard, DPOF corresponding)/MPO  |
| <b>Motion pictures with audio</b>  | AVCHD/QuickTime Motion JPEG  |



|                              |   |
|------------------------------|---|
| <b>Interface</b>             |   |
| <b>Digital</b>               | "USB 2.0" (High Speed)<br>* Data from the PC can not be written to the camera using the USB connection cable.   |
| <b>Analogue video/ audio</b> | NTSC/PAL Composite (Switched by menu)<br>Audio line output (monaural)   |
| <b>Terminal</b>              |   |
| <b>[AV OUT/DIGITAL]</b>      | Dedicated jack (8 pin)  |
| <b>[HDMI]</b>                | MiniHDMI TypeC  |
| <b>Dimensions</b>            | Approx. 107.7 mm (W)×67.1 mm (H)×32.5 mm (D)<br>[4.24" (W)×2.64"(H)×1.28" (D)]<br>(excluding the projecting parts)  |
| <b>Mass</b>                  | Approx. 319 g/0.70 lb<br>[with the Interchangeable lens (H-H014), card and battery]<br>Approx. 429 g/0.95 lb<br>[with the Interchangeable lens (H-FS014042), card and battery]<br>Approx. 359 g/0.79 lb<br>[with the Interchangeable lens (H-PS14042), card and battery]<br>Approx. 222 g/0.49 lb (camera body) |
| <b>Operating temperature</b> | 0 °C to 40 °C (32 °F to 104 °F)   |
| <b>Operating humidity</b>    | 10%RH to 80%RH  |

#### Battery Charger (Panasonic DE-A98A):

Information for your safety

|                |                                       |
|----------------|---------------------------------------|
| <b>Input:</b>  | AC ~ 110 V to 240 V, 50/60 Hz, 0.15 A |
| <b>Output:</b> | DC --- 8.4 V, 0.43 A                  |

#### Battery Pack (lithium-ion) (Panasonic DMW-BLE9E):

Information for your safety

|                          |               |
|--------------------------|---------------|
| <b>Voltage/capacity:</b> | 7.2 V/940 mAh |
|--------------------------|---------------|

**Interchangeable Lens (H-H014)**  
**“LUMIX G 14 mm/F2.5 ASPH.”**

|                                    |  |
|------------------------------------|--|
| <b>Focal length</b>                | f=14 mm<br>(35 mm film camera equivalent: 28 mm)   |
| <b>Aperture type</b>               | 7 diaphragm blades/circular aperture diaphragm   |
| <b>Aperture range</b>              | F2.5   |
| <b>Minimum aperture value</b>      | F22  |
| <b>Lens construction</b>           | 6 elements in 5 groups (3 aspherical lenses)   |
| <b>In focus distance</b>           | 0.18 m (0.59 feet) to $\infty$ (from the focus distance reference line)                      |
| <b>Maximum image magnification</b> | 0.1 $\times$ (35 mm film camera equivalent: 0.2 $\times$ )                                   |
| <b>Optical Image Stabilizer</b>    | None   |
| <b>[O.I.S.] switch</b>             | None   |
| <b>Mount</b>                       | “Micro Four Thirds Mount”  |
| <b>Angle of view</b>               | 75°  |
| <b>Filter diameter</b>             | 46 mm (1.81 inch)  |
| <b>Max. diameter</b>               | Approx. 55.5 mm (2.19 inch)  |
| <b>Overall length</b>              | Approx. 20.5 mm (0.81 inch)<br>(from the tip of the lens to the base side of the lens mount) |
| <b>Mass</b>                        | Approx. 55 g/0.12 lb   |

**Interchangeable Lens (H-FS014042)****“LUMIX G VARIO 14–42 mm/F3.5–5.6 ASPH./MEGA O.I.S.”**

|                                    |  |
|------------------------------------|--|
| <b>Focal length</b>                | f=14 mm to 42 mm<br>(35 mm film camera equivalent: 28 mm to 84 mm)                           |
| <b>Aperture type</b>               | 7 diaphragm blades/circular aperture diaphragm   |
| <b>Aperture range</b>              | F3.5 (Wide) to F5.6 (Tele)   |
| <b>Minimum aperture value</b>      | F22  |
| <b>Lens construction</b>           | 12 elements in 9 groups (1 aspherical lens)  |
| <b>In focus distance</b>           | 0.3 m (0.99 feet) to ∞ (from the focus distance reference line)                              |
| <b>Maximum image magnification</b> | 0.16× (35 mm film camera equivalent: 0.32×)  |
| <b>Optical Image Stabilizer</b>    | Available  |
| <b>[O.I.S.] switch</b>             | None (Setting of the [STABILIZER] is done in [REC] Mode menu.)                               |
| <b>Mount</b>                       | “Micro Four Thirds Mount”  |
| <b>Angle of view</b>               | 75° (Wide) to 29° (Tele)   |
| <b>Filter diameter</b>             | 52 mm (2.05 inch)  |
| <b>Max. diameter</b>               | Approx. 60.6 mm (2.39 inch)  |
| <b>Overall length</b>              | Approx. 63.6 mm (2.50 inch)<br>(from the tip of the lens to the base side of the lens mount) |
| <b>Mass</b>                        | Approx. 165 g/0.36 lb  |

**Interchangeable Lens (H-PS14042)****“LUMIX G X VARIO PZ 14–42 mm/F3.5–5.6 ASPH./POWER O.I.S.”**

|                                    |   |
|------------------------------------|---|
| <b>Focal length</b>                | f=14 mm to 42 mm<br>(35 mm film camera equivalent: 28 mm to 84 mm)  |
| <b>Aperture type</b>               | 7 diaphragm blades/circular aperture diaphragm  |
| <b>Aperture range</b>              | F3.5 (Wide) to F5.6 (Tele)  |
| <b>Minimum aperture value</b>      | F22   |
| <b>Lens construction</b>           | 9 elements in 8 groups (4 aspherical lenses, 2 ED Lens)   |
| <b>Nano surface coating</b>        | Yes   |
| <b>In focus distance</b>           | 0.2 m (0.66 feet) (Wide to focal length 20 mm) to ∞ (from the focus distance reference line),<br>0.3 m (0.99 feet) (focal length 21 mm to Tele) to ∞ (from the focus distance reference line) |
| <b>Maximum image magnification</b> | 0.17× (35 mm film camera equivalent: 0.34×)   |
| <b>Optical Image Stabilizer</b>    | Available   |
| <b>[O.I.S.] switch</b>             | None (Setting of the [STABILIZER] is done in [REC] Mode menu.)  |
| <b>Mount</b>                       | “Micro Four Thirds Mount”   |
| <b>Angle of view</b>               | 75° (Wide) to 29° (Tele)  |
| <b>Filter diameter</b>             | 37 mm (1.46 inch)   |
| <b>Max. diameter</b>               | Approx. 61 mm (2.40 inch)   |
| <b>Overall length</b>              | Approx. 26.8 mm (1.06 inch) (from the tip of the lens to the base side of the lens mount when the lens barrel is recessed)  |
| <b>Mass</b>                        | Approx. 95 g/0.21 lb  |

- G MICRO SYSTEM is a lens exchange type digital camera system of LUMIX based on a Micro Four Thirds System standard.
- Micro Four Thirds™ and Micro Four Thirds Logo marks are trademarks or registered trademarks of Olympus Imaging Corporation, in Japan, the United States, the European Union and other countries.
- Four Thirds™ and Four Thirds Logo marks are trademarks or registered trademarks of Olympus Imaging Corporation, in Japan, the United States, the European Union and other countries.
- SDXC Logo is a trademark of SD-3C, LLC.
- The "AVCHD" and the "AVCHD" logo are trademarks of Panasonic Corporation and Sony Corporation.
- Manufactured under license from Dolby Laboratories. Dolby and the double-D symbol are trademarks of Dolby Laboratories.
- HDMI, the HDMI Logo, and High-Definition Multimedia Interface are trademarks or registered trademarks of HDMI Licensing LLC in the United States and other countries.
- HDAVI Control™ is a trademark of Panasonic Corporation.
- QuickTime and the QuickTime logo are trademarks or registered trademarks of Apple Inc., used under license therefrom.
- Adobe is a trademark or registered trademark of Adobe Systems Incorporated in the United States and/or other countries.
- Mac and Mac OS are trademarks of Apple Inc., registered in the U.S. and other countries.
- Windows and Windows Vista are either registered trademarks or trademarks of Microsoft Corporation in the United States and/or other countries.
- Other names of systems and products mentioned in these instructions are usually the registered trademarks or trademarks of the manufacturers who developed the system or product concerned.

This product is licensed under the AVC patent portfolio license for the personal and non-commercial use of a consumer to (i) encode video in compliance with the AVC Standard ("AVC Video") and/or (ii) decode AVC Video that was encoded by a consumer engaged in a personal and non-commercial activity and/or was obtained from a video provider licensed to provide AVC Video. No license is granted or shall be implied for any other use. Additional information may be obtained from MPEG LA, LLC. See <http://www.mpegla.com>.

AVCHD™

DOLBY  
DIGITAL  
CREATOR

HDMI



VIERA  
Link

Pursuant to the directive 2004/108/EC, article 9(2)  
Panasonic Testing Centre  
Panasonic Marketing Europe GmbH  
Winsbergring 15, 22525 Hamburg, Germany



Panasonic Corporation

Web Site: <http://panasonic.net>

© Panasonic Corporation 2011

VQT3Q87-2  
F0611KD2111