

Panasonic®

Operating Instructions LCD Television

Model No. **TX-26LXD69A**
TX-32LXD69A

VIERA



VIERA
Link



DVB®



HD
ready

HDMI™
HIGH-DEFINITION MULTIMEDIA INTERFACE

U.K. Standard

English

Please read these instructions before operating your set and retain them for future reference.
The images shown in this manual are for illustrative purposes only.



TQB0E0507-1

Turn your living room into a home theatre!

Experience an amazing level of multi-media excitement

- **Receive digital terrestrial broadcastings using an integrated (Digital Video Broadcasting) tuner**
(Display DVB programmes with TV Guide (p. 14) / Timer recording (p. 36) / Register and instantly call up favourite programmes with Profile Edit (p. 29))
- **Sharp pictures with HDMI terminal**
- **Control DVD recorder / VCR via TV with Q-Link connection (p. 38)**
- **Create home theatre and Panasonic equipment link-ups with “VIERA Link” without complicated settings! (p. 40)**
- **Support Audio Description signal (p. 13 and p. 22)**
Audio description (AD) is an ancillary component associated with a broadcasting which delivers a verbal description of the visual scene as an aid to understanding and enjoyment particularly, for visually-impaired viewers.

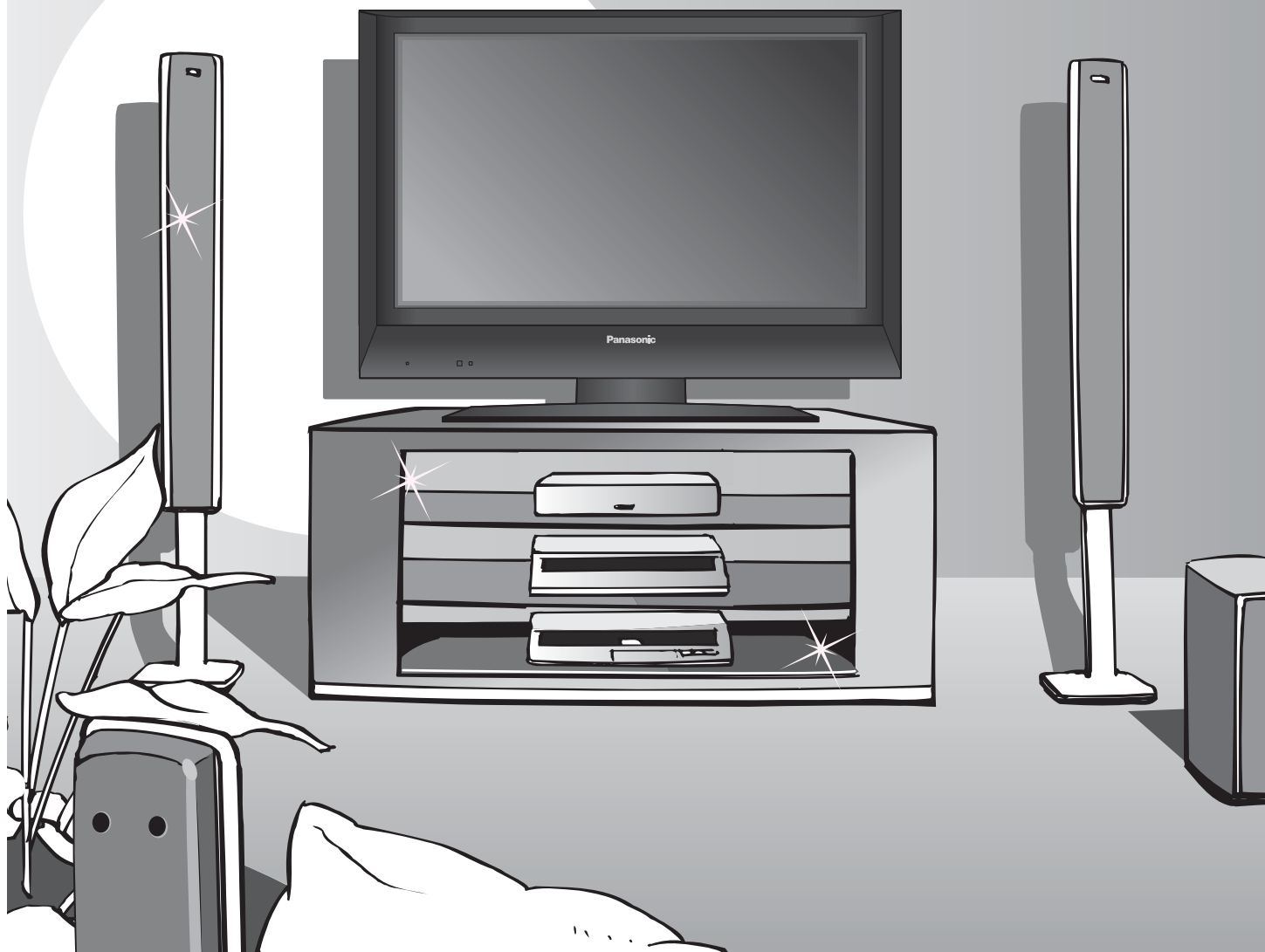

Trade Mark of the DVB Digital Video Broadcasting Project (1991 to 1996)
TX-26LXD69A Declaration of Conformity No 4929, 19 July 2007
TX-32LXD69A Declaration of Conformity No 4928, 19 July 2007



HD ready

HD ready means the ability to display high-definition pictures from HDMI and Component video inputs.



V-real 2

V-real 2 technology is the collective name for original technologies developed by Panasonic to enhance total image quality:

V-real 2 PROCESSOR: Enhance and output the incoming video signals as high-image-quality signals. The resulting video signals deliver the kind of high resolution that large screens require.

V-real 2 PANEL: Provide clear, vivid display of the video signal after processing by the V-real 2 Processor and Driver.



Intelligent Scene Controller

Intelligent Scene Controller consists of Backlight Control and Gamma Correction and achieves tighter black and more detailed expression.

7000:1

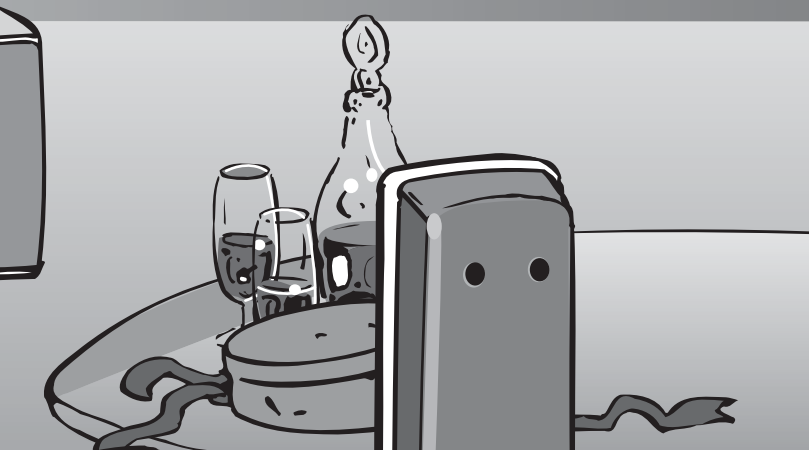

Contents

Be Sure to Read

- Safety Precautions 4
(Warning & Caution)
- Notes 5
- Maintenance 5

Quick Start Guide

- Accessories / Options 6
- Identifying Controls 7
- Basic Connection 8
- Auto Setup 10

Enjoy your TV!

Basic Features

- Watching TV 12
- Using TV Guide 14
- Watching VCR, DVD and Satellites 16
- Viewing Teletext 18

Advanced Features

- How to Use Menu Functions 21
(picture, sound quality, etc.)
- DVB Settings (DVB) 26
(pay-TV, software update)
- Editing Channels 28
- Tuning Channels 30
- Restore Settings 33
- Owner ID 34
- Input Labels 35
- Recording Controls (DVB) 36
- Q-Link Functions 38
- HDMI Functions 39
(HDMI terminal / VIERA Link)
- External Equipment 42

FAQs, etc.

- Technical Information 44
- FAQs 47
- On screen messages 49
- Specifications 51
- Index 51
- Licence 52

Safety Precautions

Warning & Caution

Handling the mains plug

- Ensure that the mains plug is easily accessible at all times. The On / Off switch on this model does not fully disconnect the TV from the mains supply. This TV will still consume some power even in the Standby mode, as long as the mains plug is still connected to a live socket outlet. Remove the mains plug from the wall socket when the TV is not used for a prolonged period of time.

Do not expose to direct sunlight and other sources of heat

- Avoid exposing the TV to direct sunlight and other sources of heat. To prevent fire never place any type of candle or naked flame on top or near the TV.

Transport only in upright position

- Transporting the TV with its display panel facing upright or downward may cause damage to the internal circuitry.

Power source

- This TV is designed to operate on 220-240V, 50 Hz AC.

Do not remove the cover

- Do not remove the rear cover as live parts are accessible when it is removed. There are no user serviceable parts inside.

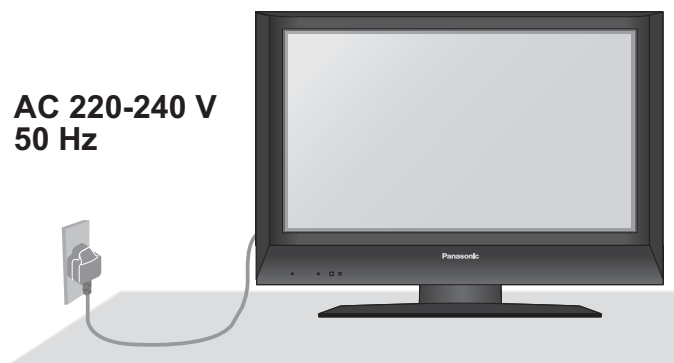

AC 220-240 V
50 Hz



IMPORTANT: THE MOULDED MAINS PLUG

FOR YOUR SAFETY, PLEASE READ THE FOLLOWING TEXT CAREFULLY.

This appliance is supplied with a moulded three pin mains plug for your safety and convenience. A 5 amp fuse is fitted in this mains plug. Shall the fuse need to be replaced, please ensure that the replacement fuse has a rating of 5 amps and that it is approved by ASTA or BSI to BS1362.

Check for the ASTA mark  or the BSI mark  on the body of the fuse.

If the mains plug contains a removable fuse cover, you must ensure that it is refitted when the fuse is replaced.

If you lose the fuse cover the mains plug must not be used until a replacement cover is obtained.

A replacement fuse cover may be purchased from your local Panasonic Dealer.

If the fitted moulded mains plug is unsuitable for the socket outlet in your home, then the fuse shall be removed and the mains plug cut off and disposed of safely. There is a danger of severe electrical shock if the cut off mains plug is inserted into any 13 amp socket.

If a new mains plug is to be fitted, please observe the wiring code as shown below.

If in any doubt, please consult a qualified electrician.

IMPORTANT: – The wires in this mains lead are coloured in accordance with the following code: –
Blue: Neutral Brown: Live

As the colours of the wire in the mains lead of this appliance may not correspond with the coloured markings identifying the terminals in your mains plug, proceed as follows.

The wire which is coloured BLUE must be connected to the terminal in the mains plug which is marked with the letter N or coloured BLACK.

The wire which is coloured BROWN must be connected to the terminal in the mains plug which is marked with the letter L or coloured RED.

Under no circumstances should either of these wires be connected to the Earth terminal of the three pin mains plug, marked with the letter E or the earth symbol .

How to replace the fuse.

For plug type shown in example 1:

Lift out the removable fuse compartment with a screwdriver and replace the fuse, then refit securely into the mains plug (see example 1).

For plug type shown in example 2:

Lift open the fuse compartment, in the mains plug, with a screwdriver, and replace the fuse, then press the fuse cover down securely (see example 2).

Example 1

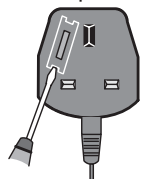

Example 2

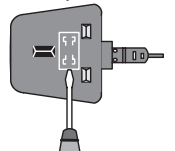

Notes

Do not expose to rain or excessive moisture

- To prevent damage which might result in electric shock or fire, do not expose this TV to rain or excessive moisture. This TV must not be exposed to dripping or splashing water and objects filled with liquid, such as vases, must not be placed on top of or above the TV.

Do not block the rear ventilation openings

- Ventilation should not be impeded by covering the ventilation openings with items such as newspapers, tablecloths and curtains.

Allow sufficient space around the TV for radiated heat

Minimum distance

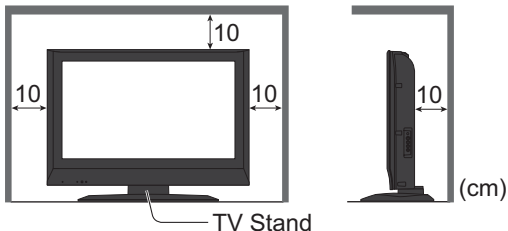

Do not place the TV on sloped or unstable surfaces

- The TV may fall off or tip over.

Use only the dedicated stands / mounting equipment

- Using an unauthorized stand or other fixtures may make the TV unstable, risking injury. Be sure to ask your local Panasonic dealer to perform setup.
- Use optional stands / mounts (p. 6).

Auto power standby function

- If no signal is received and no operation is performed in TV mode for 30 minutes, the TV will automatically go to standby mode.

Keep the TV away from these equipment

- Electronic equipment
In particular, do not place video equipment too close the TV (electromagnetic interference may distort images / sound).
- Equipment with an infrared sensor
Remote Controller of this TV also emits infrared rays (this may affect operation of other equipment).

Do not expose your ears to excessive sound pressure from headphones. Irreversible damage can be caused.

Maintenance

First, remove the mains plug from the socket outlet.

Display panel

Regular care: Gently wipe the surface clean of dirt by using a soft cloth.

Major contamination: Wipe the surface clean using a soft cloth dampened with clean water or diluted neutral detergent by 100 times of water. Then, using a soft dry cloth, evenly wipe the surface clean until it is dry.

Caution

- The surface of the display panel has been specially treated and may be easily damaged. Do not tap or scratch the surface with your fingernail or other hard object.
- Use care not to subject the surface to insect repellent, solvent, thinner, or other volatile substances (this may degrade surface quality).

Cabinet

Regular care: Wipe the surface clean using a soft dry cloth.

Major contamination: Dampen a soft cloth with clean water or water containing a small amount of neutral detergent. Then, wring the cloth and wipe the surface clean with it. Finally, wipe the surface clean with a dry cloth.

Caution

- Use care not to subject the TV's surfaces to detergent. (A liquid inside the TV could lead to product failure.)
- Use care not to subject surfaces to insect repellent, solvent, thinner, or other volatile substances (this may deteriorate the surface by peeling the paint).
- Do not allow the cabinet to make contact with a rubber or PVC substance for a long time.

Mains plug

Wipe the mains plug with a dry cloth at regular intervals. (Moisture and dust may lead to fire or electrical shock.)

Accessories / Options

Standard accessories

- Remote Control Transmitter
- EUR7651110



- Operating Instructions
- Pan European Guarantee Card

Check that you have the accessories and items shown

- Batteries for the Remote Control Transmitter (2)
- R6 (UM3)

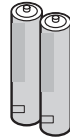

- 1 Year Guarantee Registration

- Clamper
- TMM8E18048

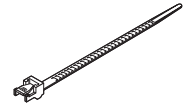

- CRM (Customer Relationship Management)

Installing remote's batteries

1

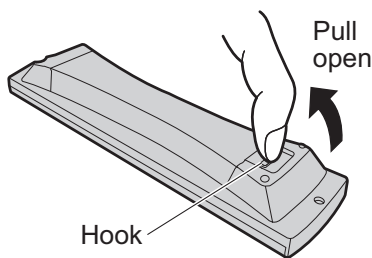

2

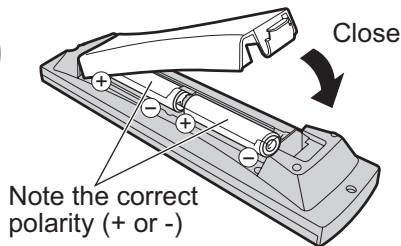

Caution

- Incorrect installation may cause battery leakage and corrosion, resulting in damage to the remote control.
- Do not mix old and new batteries.
- Do not mix different battery types (such as alkaline and manganese batteries).
- Do not use rechargeable (Ni-Cd) batteries.
- Do not burn or breakup batteries.

Using the clamper

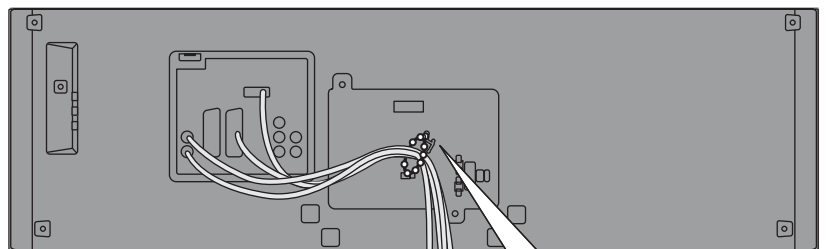

Rear of the TV

Clamper (Standard accessory)

To tighten:

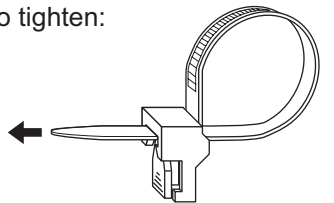

To loosen:

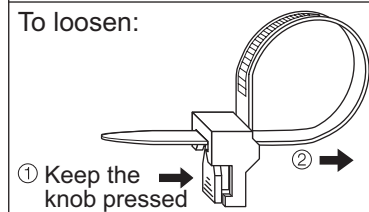

Bundle the cables:

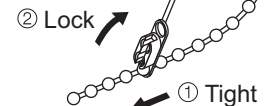

Hook the clamper:

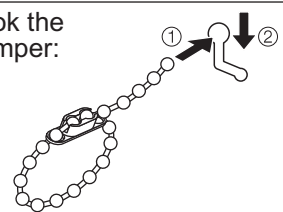

- Do not bundle the RF cable and mains lead together (could cause distorted image).
- Fix cables with clampers as necessary.
- When using the optional accessory, follow the option's assembly manual to fix cables.

Optional accessories

Wall-hanging bracket

- TY-WK32LR2W

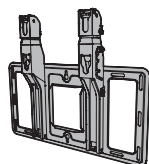

WARNING!

- Failure to use a Panasonic bracket or choosing to mount the unit yourself will be done at the risk of the consumer. Any damage resulting from not having a professional installer mount your unit will void your warranty.
- Always be sure to ask a qualified technician to carry out set-up. Incorrect fitting may cause equipment to fall, resulting in injury and product damage.
- Do not mount the unit directly below ceiling lights (such as spotlights, floodlights or halogen lights) which typically give off high heat. Doing so may warp or damage plastic cabinet parts.
- Take care when fixing wall brackets to the wall. Always ensure that there are no electrical cables or pipes in the wall before hanging bracket.

Please contact your nearest Panasonic dealer to purchase the recommended wall-hanging bracket. For additional details, please refer to the wall-hanging bracket installation manual.

How to remove the TV Stand

Remove four screws.

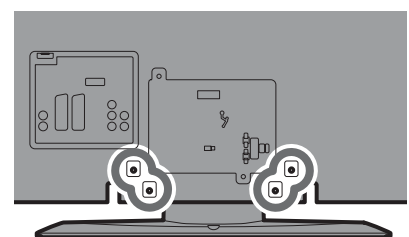

Rear of the TV

Identifying Controls

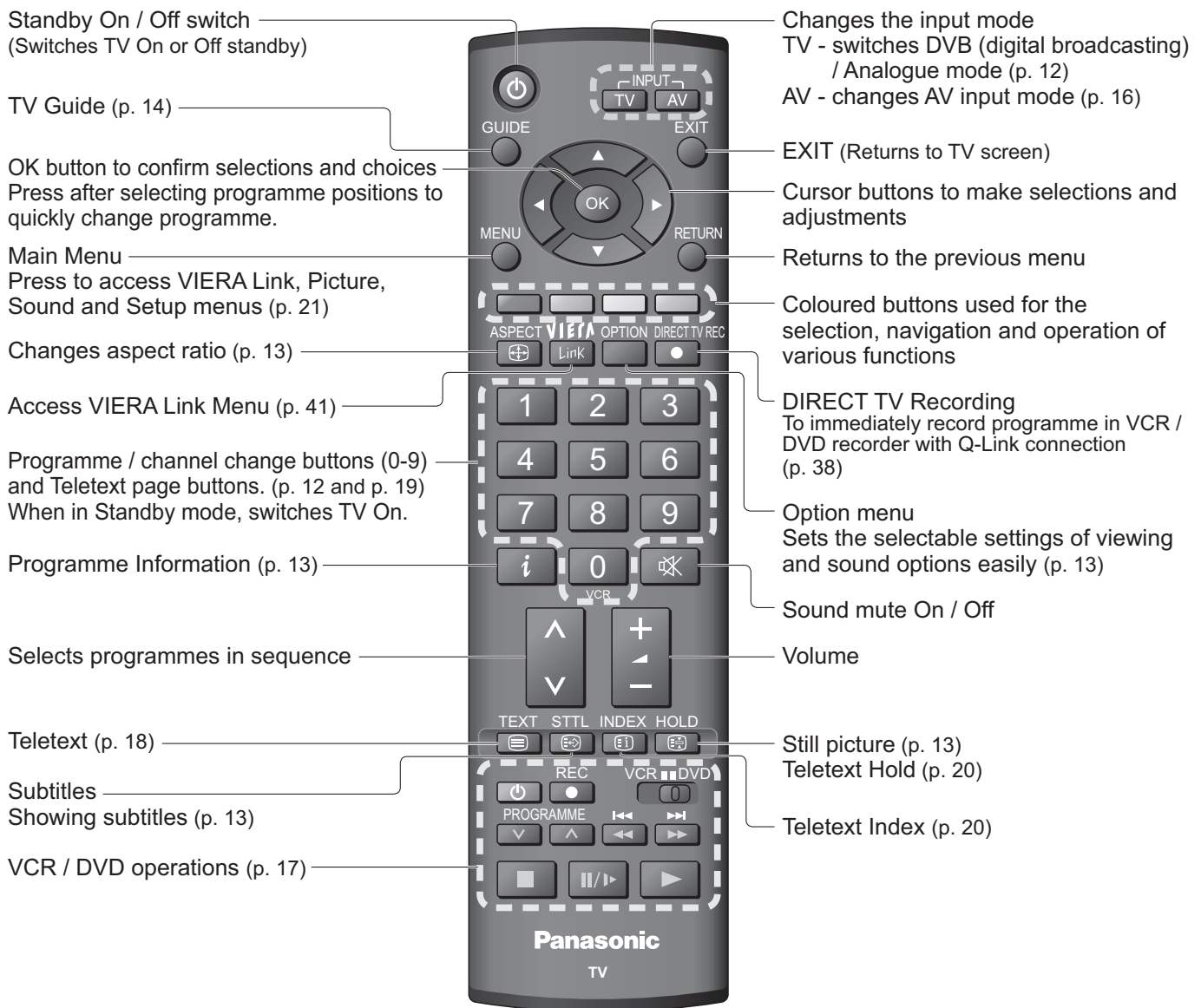
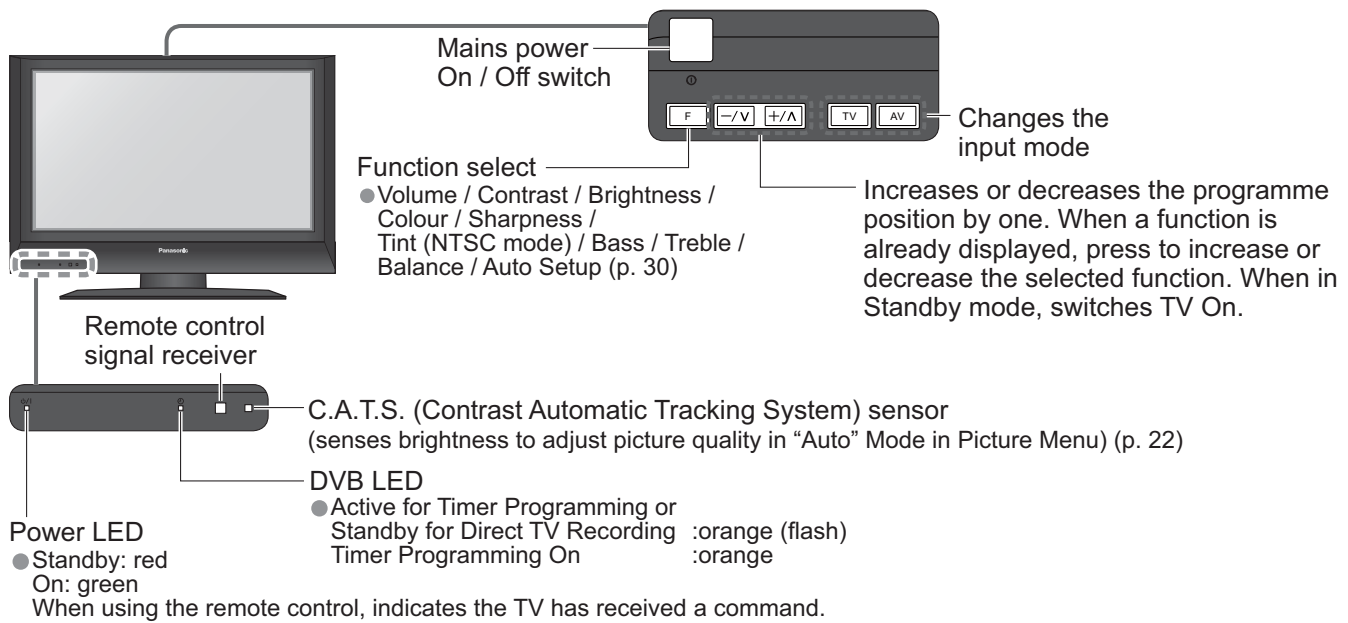

Basic Connection

External equipment and cables shown are not supplied with this TV.

Please ensure that the unit is disconnected from the mains socket before attaching or disconnecting any leads.

Example 1 Connecting aerial

TV only

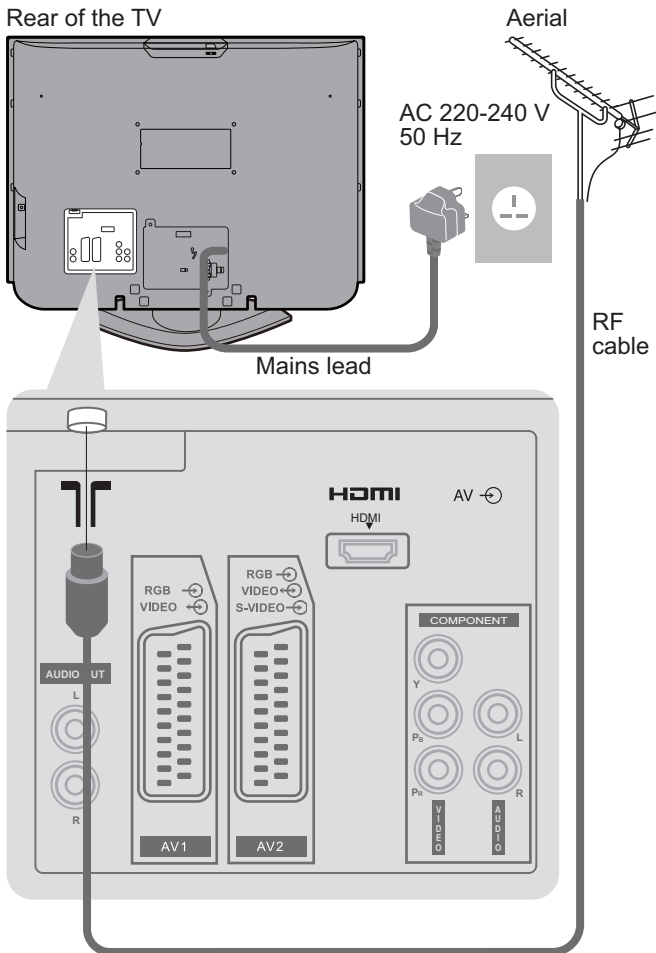

Example 2 Connecting DVD Recorder / VCR

TV, DVD Recorder or VCR

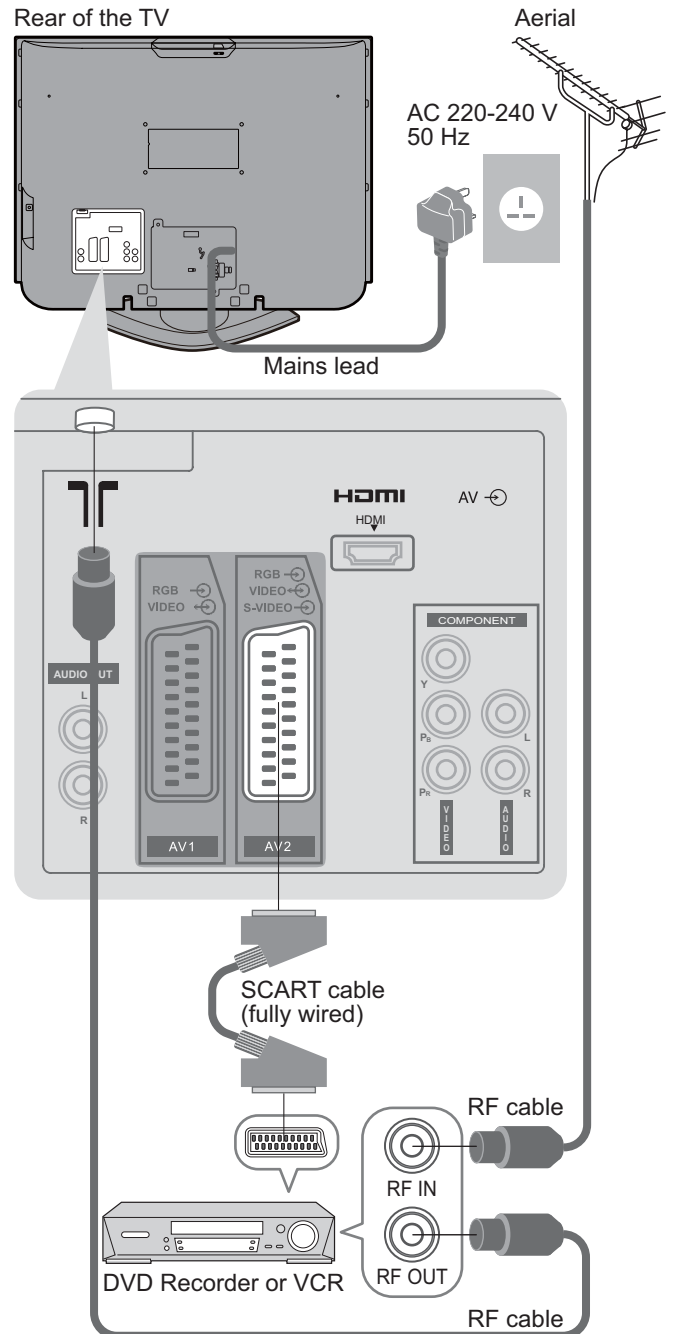

Note

- Connect to AV2 for a DVD Recorder / VCR supporting Q-Link (p. 38).
- Connect to AV1 for a Satellite receiver.
- If connecting the TV and Satellite receiver with SCART cable, you can watch satellite broadcast by RGB input signal.

- SCART: 21 pin connection used for video, audio and switching signals (Also known as Euro SCART and Peritel)
- RF: Radio Frequency - Signal received from terrestrial aerial.
- RGB / S-Video / Video: Choose between these three video formats depending on personal preference and equipment requirement. (RGB - Red, Green and Blue)
- VCR: Video Cassette Recorder
- DVD: Digital Versatile Disc

Example 3 Connecting DVD Recorder / VCR and Sattelite receiver

TV, DVD Recorder / VCR and Sattelite

Rear of the TV

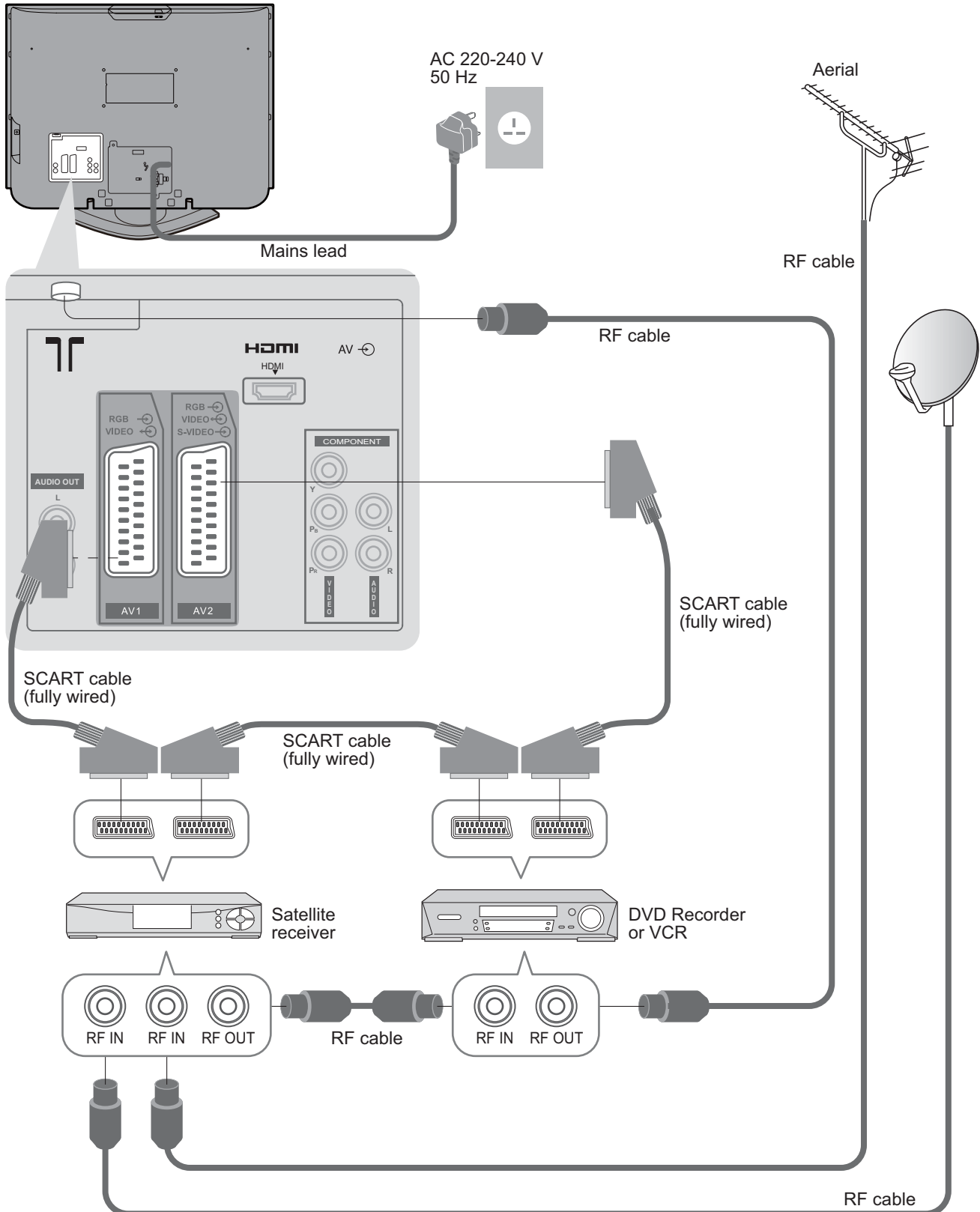

Auto Setup

Search and store TV channels automatically.

These steps are not necessary if the setup has been completed by your local dealer.

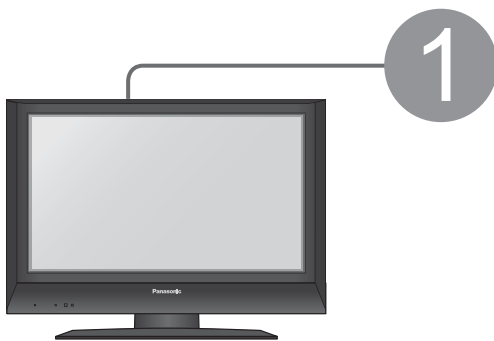

1 Plug the TV into mains socket and switch On (Takes a few seconds to be displayed)

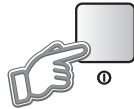

- You can now use the remote control to turn On the TV or turn the TV to standby mode. (Power LED: On)

Auto Setup - Digital and Analogue

Digital Scan	21	68
Analogue Scan	21	68

Channel	Service Name	Type	Quality
62	CBBC Channel	DVB	10
62	BBC Radio Wales	DVB	10
62	BBC Radio Cymru	DVB	10
62	E4	DVB	10
23	Cartoon Nwk	DVB	10
33	BBC1	Analogue	-

This will take about 3 mins.

EXIT
RETURN

- Auto Setup will start to search for TV channels and store them. The sorted programme order depends upon the TV signal, the broadcasting system and reception conditions.

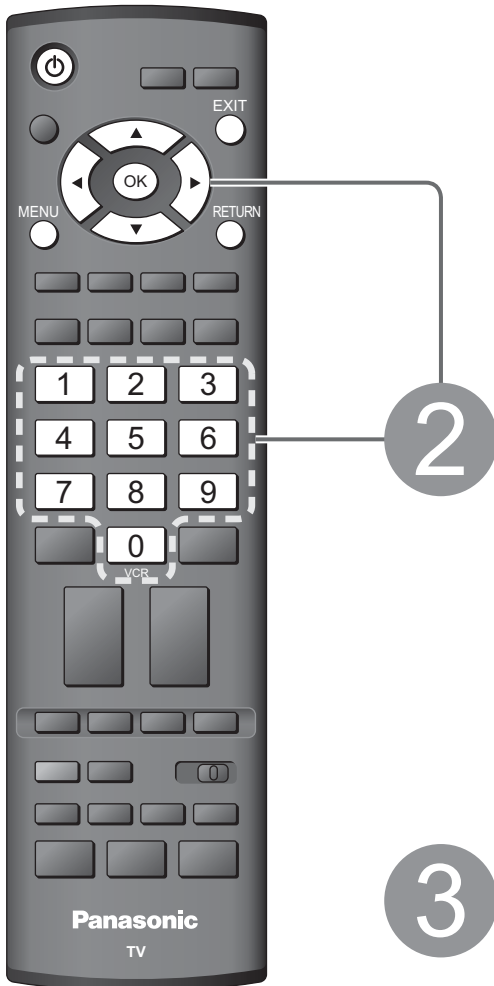

DOWNLOAD IN PROGRESS
PLEASE WAIT
Programme : 63
Remote control unavailable

- If a compatible recording equipment with Q-Link or similar technologies (p. 38) is connected, analogue channel information is automatically downloaded to the equipment.

When inputting owner ID

Owner ID

Please enter new PIN

PIN

EXIT
RETURN

PIN entry

Following the on-screen operation guide, enter your own choice of PIN number, name, etc.

- For detailed procedures → "Owner ID" (p. 34)
- Make a note of the PIN number in case you forget it.

When inputting owner ID later



- If you input the ID later → "Owner ID" (p. 34)

3

Select the picture setting

Viewing Mode

Please select your preferred viewing mode.

Dynamic Normal Cinema Auto

- Also possible to change the setting in Picture Menu (p. 22)

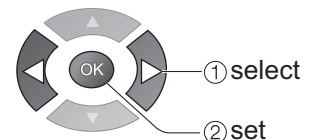

Auto Setup is now complete and your TV is ready for viewing.

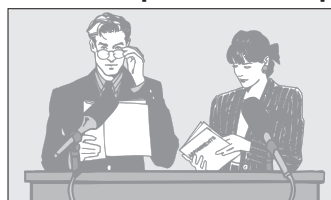

- To check programme list at-a-glance → TV Guide (p. 14)
- To edit channels → Editing Channels (p. 28) Analogue Programme Edit (p. 31)

Using the On Screen Displays

Many features available on this TV can be accessed via the On Screen Display menu.

■ How to use remote control

MENU



Open the main menu



Move the cursor / select the menu



Move the cursor / adjust levels / select from a range of options



Access the menu / store settings after adjustments have been made or options have been set

RETURN



Return to the previous menu

EXIT



Exit the menu system and return to the normal viewing screen

■ ON SCREEN HELP Instructions box

(example: Owner ID)

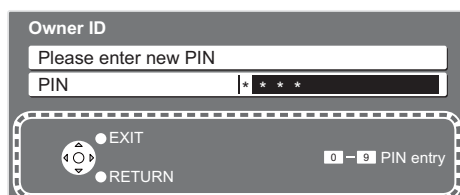

On-screen operation guide will help you.

Note

- If tuning have failed → “Auto Setup” (p. 31).
- If downloading have failed → “Download” (p. 23).
- If you turned the TV Off during Standby mode last time, the TV will be in Standby mode when you turn the TV On with Mains power On / Off switch.

Watching TV

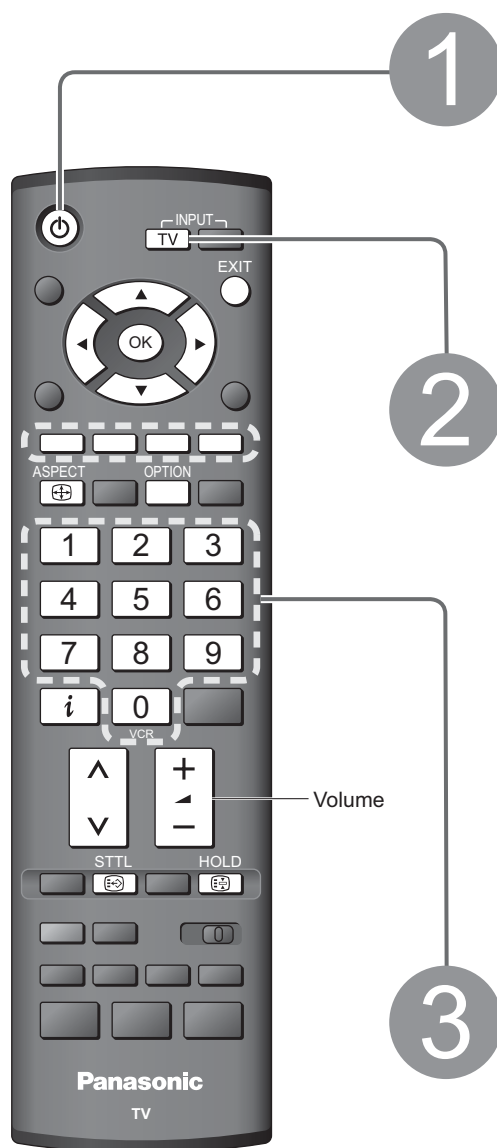

1 Turn power on



(Press for about 1 second)

- Mains power On / Off switch should be On.

2 Select DVB (Digital Video Broadcasting) or Analogue

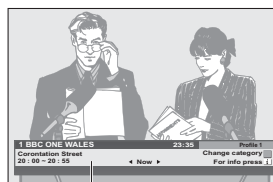

Information banner

- You can also select the mode using the TV button on the top panel of the TV.

3 Select a channel

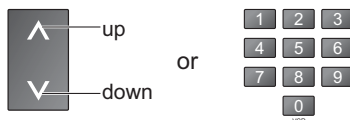













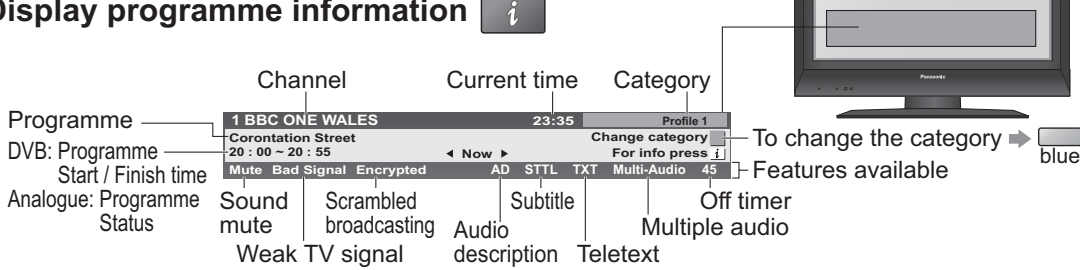



- To select the two or three-digit programme number, e.g. 39
→ **3** → **9** (in a short time)
- To select programmes using TV Guide (p. 14)

Note

- To watch pay-TV (p. 27)

■ Other useful functions (Operate after 3)

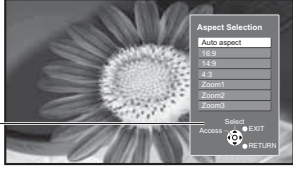
<p>Hold</p>	<p>Freeze / unfreeze picture</p>	<p>HOLD </p>
<p>Display subtitles</p>	<p>Display / hide subtitles (if available) ● To change the language for DVB ➔ "Preferred Subtitle" (p. 23) (If available)</p>	<p>STTL </p>
<p>Display the current programme status</p>	<p>Check or change the current programme status instantly</p> <p>● To change ➔  ② change ① select</p> <p>Subtitle Language (DVB mode) ➔ Possible if the programme has some languages of subtitles</p> <p>Multi Audio (DVB mode) ➔ Possible if the programme has some languages of sounds</p> <p>NICAM (Analogue mode) ➔ Sound Menu (p. 22)</p> <p>Volume Correction ➔ Adjusts volume of individual channel or input mode</p> <p>Audio Description (DVB mode) ➔ This function is useful for visually-impaired viewers Select "On" if the programme has this signal, it sounds the description sound ● If the programme has this signal, "AD" will appear in Information banner (depending on the broadcaster).</p> <p>Note</p> <p>● Also possible to change the settings in Menu list (p. 22 and p. 23).</p>	<p>OPTION </p>
<p>Display information banner</p>	<p>Display programme information </p>  <p>● Information of another channel ➔ </p> <p>● Information on next programme (DVB) ➔ </p> <p>● To watch the programme listed in the banner ➔ </p> <p>● Information banner operation ➔ </p> <p>1st press Display banner ➔ 2nd press Banner + programme synopsis (DVB) ➔ 3rd press Exit</p>	<p>To change the category ➔ </p> <p>● To set display timeout ➔ "Banner Display Timeout" (p. 23)</p> <p>● To hide ➔ </p> <p>● Appears also when changing channel.</p>
<p>Change aspect ratio</p>	<p>Change the aspect ratio (p. 44) </p> <p>Enjoy viewing the picture at its optimum size and aspect.</p> <p>● To change the mode ➔ Display Aspect Selection list  ➔ During the list is displayed,  ➔ Store </p> <p>● To change the mode using the ASPECT button only ➔  (Press repeatedly until you reach the desired mode)</p>	<p>Aspect Selection list </p>

Using TV Guide

TV Guide—Electronic Programme Guide (EPG) provides an on-screen listing of programmes currently broadcast and future broadcasts over the next seven days (depending on the broadcaster). Analogue broadcasts will be listed after DVB broadcasts. “D” means DVB channel and “A” means Analogue channel.

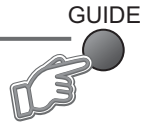

View TV Guide (landscape or portrait)

View “Portrait” to see one channel at a time
View “Landscape” to see many channels

Programme Current date and time (TV Guide start page)

TV Guide date: Fri 6th

TV Guide time: 20:00 - 20:30

Channel	20:00 - 20:30	20:00 - 20:30	20:30 - 21:00	21:00 - 21:30
D 1 BBC ONE*	Eastender	DIY SOS	The Bill	Red Cap
D 7 BBC THR	Hot Wars		Holiday Program	So
D 14 E4	Emmerdal.	Coronation Street		The Bill
D 70 CBBC Cha	10 O' clock News BBC		Pepsi Char.	Good bye Hello
D 72 Cartoon	Panorama	Sex And The City		Terminator
D 105 BBCi	I'm A Celebrity		Pop Idol	News The
D 719 BBC Radi	Rugby	15 To 1		The Bill

Landscape (Displays by broadcaster)

To change the layout



(Landscape / Portrait)

TV Guide Portrait

Wed 12th

19:30 - 20:00 Eastender

20:00 - 21:00 DIY SOS

21:00 - 22:00 The Bill

22:00 - 22:00 Red Cap

22:30 - 23:00 Live junction

23:00 - 23:30 POP 100

23:00 - 00:00 Rugby

23:40 - 23:55 Cinema info

23:55 - 00:30 News

Portrait (Displays by time)

To previous day (DVB mode)



To next day (DVB mode)



To return to TV



To view a programme list of the selected type (DVB mode)



Prog. type

All Types

Movies

News

Entertainment

Sport

Children's

Education

Lifestyle

Drama

(Type list)

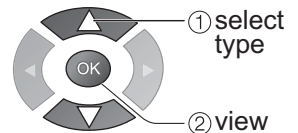

To view a programme list of the selected category



Category

All Services

All DVB Services

All Analogue Services

Free TV

Pay TV

Radio

Information

Profile 1

Profile 2

Profile 3

Profile 4







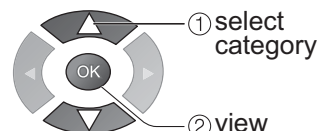

(Category list)

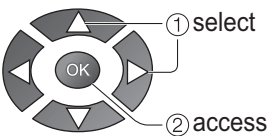
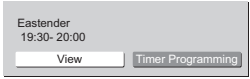
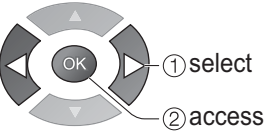
Only analogue TV channels are listed

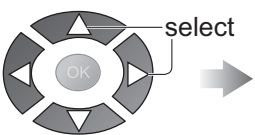
To list favourite channels (p. 29)

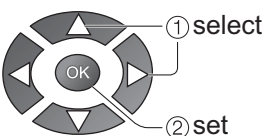
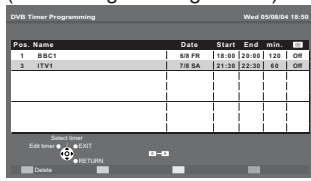

■ Other useful functions (Operate after viewing TV Guide)

<p>Watch the programme</p>	<p>Select the channel or programme now on the air</p>  <p>① select ② access</p> <p>➔</p> <p>Select "View" (DVB)</p>   <p>① select ② access</p> <p>➔</p>  <p>(TV screen)</p>																					
<p>View details of the programme (DVB mode)</p>	<p>Select the programme</p>  <p>select</p> <p>➔</p>  <p>View details</p>  <p>Details</p> <p>➔</p>  <p>■ To return to the start page</p>																					
<p>Timer programming to record (DVB mode)</p>	<p>Select the programme to be broadcast</p>  <p>① select ② set</p> <p>(Timer Programming screen)</p>  <table border="1" data-bbox="606 1086 917 1265"> <thead> <tr> <th>Pos.</th> <th>Name</th> <th>Date</th> <th>Start</th> <th>End</th> <th>min.</th> <th>Off</th> </tr> </thead> <tbody> <tr> <td>1</td> <td>BBC1</td> <td>6th FR</td> <td>19:00</td> <td>20:00</td> <td>120</td> <td>Off</td> </tr> <tr> <td>2</td> <td>ITV1</td> <td>7th SA</td> <td>22:30</td> <td>23:30</td> <td>180</td> <td>Off</td> </tr> </tbody> </table> <p>➔</p> <p>DVB LED will turn on if Timer Programming is set.</p>  <p>DVB LED</p> <ul style="list-style-type: none"> ● Orange DVB LED (Rapid blinking during recording) <p>■ To return to TV Guide</p> <p>➔ RETURN</p>  <p>Note</p> <ul style="list-style-type: none"> ● When recording programmes, you must make the proper settings on the external recording equipment connected to the TV. If a compatible recording equipment with Q-Link or similar technologies is connected to the TV (p. 8) and the "Q-Link Settings" (p. 23) are completed, no setting of the equipment is required. Also read the manual of the recording equipment. ● If you select the programme now on the air, the confirmation screen whether watching or recording will appear. Select "Timer Programming" to record from the time you finish the Timer Programming setting. 	Pos.	Name	Date	Start	End	min.	Off	1	BBC1	6th FR	19:00	20:00	120	Off	2	ITV1	7th SA	22:30	23:30	180	Off
Pos.	Name	Date	Start	End	min.	Off																
1	BBC1	6th FR	19:00	20:00	120	Off																
2	ITV1	7th SA	22:30	23:30	180	Off																

Note

- When this TV is turned on for the first time, or the TV is switched off for more than a week, it may take some time before the TV Guide is completely shown.

Watching VCR, DVD and Satellites

Connect the external equipment (VCRs, DVD equipment, etc.) and you can watch the input.

Connect the Satellite receiver and you can watch satellite broadcasts.

To connect the equipment (p. 8 and p. 9)

The Remote Control is capable of operating some functions of selected Panasonic external equipment.

1 Turn the TV on

- **When connecting with SCART as example 2 or 3** (p. 8 and p. 9)
 - ➔ Receives input signals automatically when playback starts or satellite receiver is switched on
 - Input signals are automatically identified by the SCART (pin 8) terminal.
 - This function is also available for HDMI connections (p. 41).
- **If input mode is not switched automatically**
 - ➔ Perform 2 and 3
 - Dependant on the setup of the equipment

2 Display the Input select menu

3 Select the input mode connected to the equipment

Input Selection	
AV1	
AV2/AV2S	--
AV3/AV3S	
COMPONENT	
HDMI	
TV	

4 View

Displays the selected mode

AV2

● You can also select the input using the AV button on the remote control or the top panel of the TV.
Press the button repeatedly until the desired input is selected.

● You can label or skip each input modes ➔ "Input Labels" (p. 35)

■ **To return to TV**

➔ TV

Note

- If the external equipment has an aspect adjustment function, set to "16:9".
- For details, see the manual of the equipment or ask your local dealer.

Screen display

Terminal	AV1	AV2	Component	HDMI
Manual input (default setting in "Input Labels")	AV1 AV1-RGB	AV2 AV2-S-Video AV2-RGB	Component	HDMI
Auto input (EC mode or VIERA Link)	EC/AV1 EC/AV1-RGB	EC/AV2 EC/AV2-RGB	—	EC/HDMI ● Applicable for EC mode and VIERA Link

Panasonic equipment connected to the TV can be directly operated with the remote control.

	VCR / DVD switch* Select VCR to operate Panasonic VCR or DVD equipment Select DVD to operate Panasonic DVD equipment or Player home theatre
	Standby Set to Standby mode / Turn on
	Play Playback videocassette / DVD
	Stop Stop the operations
	Rewind / Skip / Search VCR: Rewind, view the picture rapidly in reverse DVD: Skip to the previous track or title Press and hold to search backward
	Fast-forward / Skip / Search VCR: Fast-forward, view the picture rapidly forward DVD: Skip to the next track or title Press and hold to search forward
	Pause Pause / Restart DVD: Press and hold to play at slow speed
	Programme Up / Down Select programme
	Record Start recording

*Setting your remote control to operate Panasonic VCR, DVD, etc.

① Set the VCR / DVD switch to the appropriate position →

② Press and hold during the following operations

Enter the appropriate code for the equipment to be controlled, see table below



"VCR" position

Equipment	Code
VCR	10 (default)
DVD	11

"DVD" position

Equipment	Code
DVD	70 (default)
Player home theatre	71

Note

- Confirm correct operation after the code changed.
- The codes will be reset to default values if batteries are replaced.
- "DVD" means DVD player, DVD recorders and Recorder home theatre.
- Some operations may not be possible on some equipment models.

Viewing Teletext

You can enjoy news, weather forecasts and subtitles, etc. (depending on the broadcaster)

DVB (digital broadcasting) mode

DVB teletext services

DVB teletext services differ greatly from analogue teletext. When you switch to a DVB teletext service, the images you see can contain graphics and text, laid out and controlled in a manner decided by the broadcaster.

- You can check if the programme has teletext information.

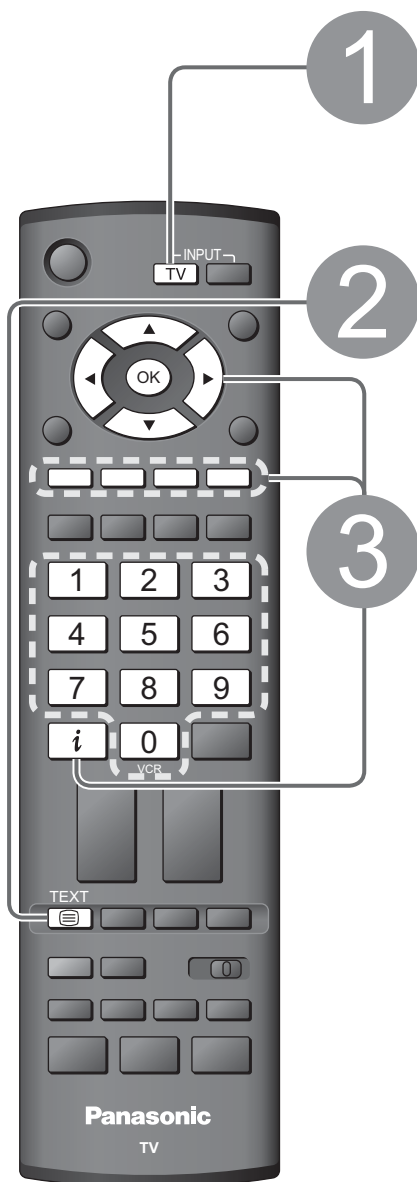
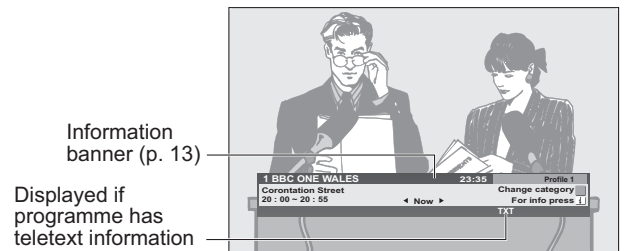

If in Analogue mode

Select DVB



Switch to Teletext

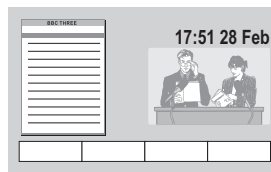

How to use

In all cases, it is possible to navigate the pages using buttons on the remote control, but because the commands available must apply to all manufacturers of DVB equipment, some on screen commands may not correspond exactly to the remote control buttons.

For example:

- When “select” or “go” is displayed →
- When “◀”, “▶”, “▲”, “▼” symbol is displayed →
- When the key words are displayed on colour bar →
- When options with numbers are displayed →
- When “i” is displayed → (information)
- To return to TV →

Note

- As soon as you switch to a DVB channel with links to a teletext service, software is downloaded in the background to enable the teletext function. This means that when switching to a DVB channel, you should wait for approximately 5 seconds before pressing the TEXT button - this will allow the software to download. If you press the TEXT button before download is complete, there will be a short delay before the text screen is displayed.
- While navigating DVB teletext, you will find there is a short delay when moving between pages while the page downloads. There is often a prompt shown somewhere on the page (for example “Loading”) to let you know that this is happening.

■ To change the channel

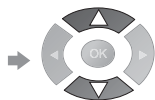

Analogue mode

What is FASTEXT mode (default)?

In FASTEXT mode, four differently coloured subjects are situated at the bottom of the screen. To access more information about one of these subjects, press the appropriately coloured button. This facility enables fast access to information on the subjects shown.

What is List mode?

In List mode, four differently coloured page numbers are situated at the bottom of the screen. Each of these numbers can be altered and stored in the TV's memory. ("Store frequently viewed pages", p. 20)

■ **To change mode** → "Teletext" in Setup Menu (p. 23)

1 If in DVB mode
Select Analogue

2 **Switch to Teletext**

● Displays the index page (content varies depending on the broadcasters)

3 **Select the page**

1 2 3
4 5 6
7 8 9
0

or

up
down

or

red green yellow blue
(Corresponds to the colour bar)

Sub page number
Current page number
Time / date
TELETEXT INFORMATION
Colour bar

As the blue bar is displayed

■ **To adjust contrast** → MENU (Press twice) →

■ **To return to TV** → TEXT (Press twice)

● Press once to have picture and text.
Press again to return to TV.

Viewing

Viewing Teletext

■ Using Analogue teletext

Reveal hidden data

MENU → red ● Re-hide → red

FULL / TOP / BOTTOM

MENU → green

(TOP) (BOTTOM) Normal (FULL)

















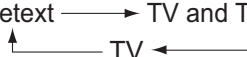

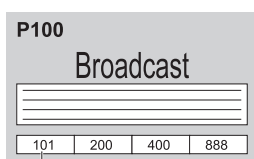
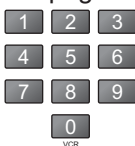
P100 Broadcast → P100 Broadcast → P100 Broadcast

(Expand the TOP half) (Expand the BOTTOM half)

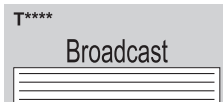
(Continued)

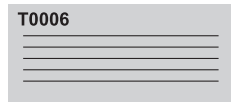
Viewing Teletext

■ Using Analogue teletext (Continued)

<p>HOLD</p>	<p>If you wish to hold the current page without updating Stop automatic updating</p> <p>HOLD  ■ To resume → HOLD </p>
<p>INDEX</p>	<p>Return to the main index page</p> <p>INDEX  ● FASTEXT / List mode</p>
<p>Subtitles</p>	<p>View subtitles by pressing STTL button</p> <p>STTL  ● Factory setting is "P888" (subtitle service) on blue button (List mode).</p>
<p>View in multi window</p>	<p>Watch TV and Teletext in two windows at once</p> <p>TEXT   ● Operations can be made only in Teletext screen. ● Each time pressed: Teletext → TV and Teletext </p>
<p>Store frequently viewed pages</p>	<p>Store frequently viewed pages in the colour bar (List mode only)</p> <p>As page is displayed  Corresponding colour button → OK  press and hold</p> <p> ● If you wish to use Subtitles, do not change number on blue button.</p> <p>101 200 400 888 The number changes to white.</p> <p>■ To change stored pages</p> <p>→ Colour button you want to change → Enter new page number</p> <p> → OK  press and hold</p>
<p>View sub page</p>	<p>View sub page (Only when teletext is more than one page)</p> <p> <<01 02 03 04 05— Appears at top of the screen</p> <p>■ To view specific sub page</p> <p>→ MENU  → blue  → Enter the 4-digit number</p> <p> → example: P6  → </p> <p>● Sub pages: The number of sub pages varies depending on the broadcasters (up to 79 pages). It may take some time for searching, during which time you can watch TV.</p>
<p>Watch TV while waiting for update</p>	<p>View the TV picture while searching for a teletext page</p> <p>Teletext automatically updates itself when new information becomes available. Changes to TV screen temporarily</p> <p>MENU  → yellow  →  Appears when updating is completed → yellow  → View the updated page</p> <p>(You cannot change the channel.)</p> <p>● The news page provides a function that indicates arrival of latest news ("News Flash").</p>

How to Use Menu Functions

Various menus allow you to make settings for the picture, sound, and other functions.

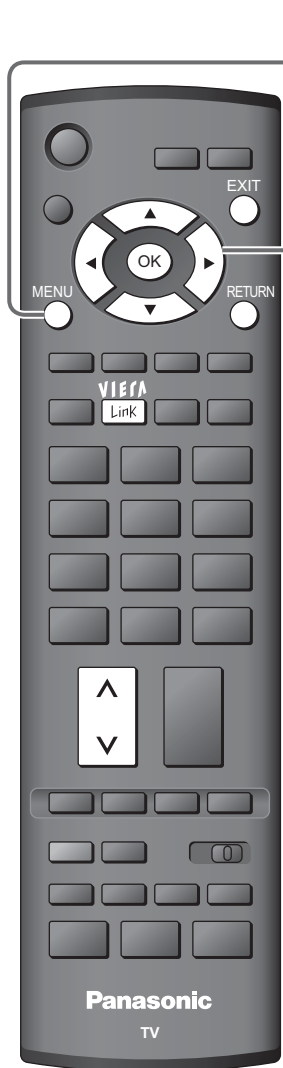

1

Display the menu

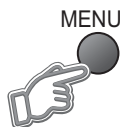

- Displays the functions that can be set (varies according to the input signal)

2

Select the menu

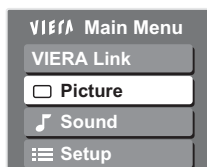

(example: Picture Menu)

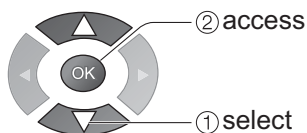

3

Select the item

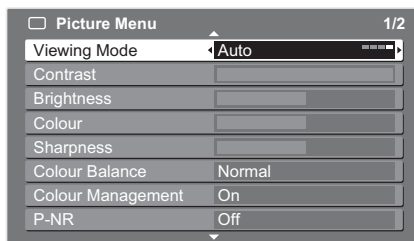

(example: Picture Menu)

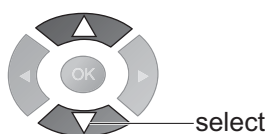

4

Adjust or select

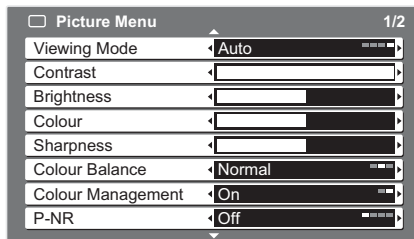

(example: Picture Menu)

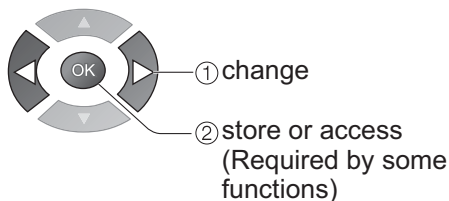

■ To return to TV at any time



■ To return to the previous screen



Note

- To initialize all settings → "Shipping Condition" (p. 33)

■ Choose from among alternatives

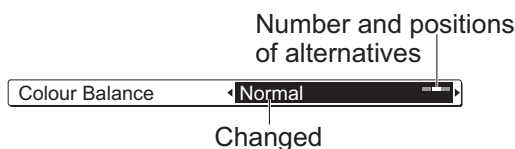

■ Adjust using the slide bar



■ Go to the next screen

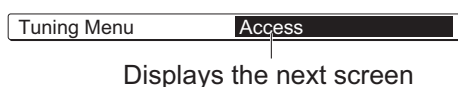

■ To change menu pages

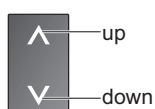

How to Use Menu Functions

■ Menu list

Menu	Item	Adjustments / Configurations (alternatives)
VIERA Link	VIERA Link Control	Controls the connected Panasonic equipment “Easy control only with VIERA remote control” (p. 41) “Speaker control” (p. 41)
	Speaker Selection	<ul style="list-style-type: none"> You can also access VIERA Link Menu directly using the VIERA Link button on the remote control.
Picture	Viewing Mode	Selects four different screen settings (Dynamic / Normal / Cinema / Auto) In each Viewing Mode setting, Contrast, Brightness, Colour, Sharpness, Tint (in NTSC only), Colour balance, Colour Management and 3D-COMB can be adjusted and stored to suit your particular viewing requirement (e.g., you may require different settings for viewing sports, films, news etc.) Set for each input signal Changes will be stored automatically. By analysing and processing the incoming picture, all four modes feature automatic enhancement
	Contrast, Brightness, Colour, Sharpness	Increases or decreases the levels of these options according to your personal preference
	Tint	With an NTSC signal source connected to the TV, the picture hue can be adjusted to suit your taste
	Colour Balance	Allows you to set the overall colour tone of the picture (Cool / Normal / Warm)
	Colour Management	Automatically adjusts colours to vivid ones (Off / On)
	P-NR	Picture Noise Reduction Automatically reduces unwanted picture noise (Off / Min / Mid / Max)
	3D-COMB	Occasionally, whilst viewing still or slow moving pictures, colour patterning may be seen Set to “On” to display sharper and more accurate colours (Off / On) <ul style="list-style-type: none"> For PAL or NTSC signal reception only Not valid on RGB, S-Video, components and HDMI Analogue mode only
	Reset to Default	Press the OK button to reset the present Picture Mode to the default settings <ul style="list-style-type: none"> P-NR is reset to Off
Sound	Mode	Select two different sound settings (Music / Speech) In each Sound Mode setting, Bass and Treble can be adjusted and stored to suit your particular sound requirement Changes to any settings in a mode will affect all signal sources Sound quality can be improved
	Bass	Increases or decreases level to enhance or minimise lower, deeper sound output
	Treble	Increases or decreases level to enhance or minimise sharper, higher sound output
	Balance	Adjusts volume level of right and left speakers
	Headphone Volume	Adjusts the volume of the headphones
	Surround	Surround sound settings (Off / On) Provides a dynamic enhancer to simulate improved spatial effects
	Volume Correction	Adjusts volume of individual channel or input mode
	Preferred Multi Audio	Selects the preferred language for DVB multi audio (depending on the broadcaster)
	NICAM	NICAM (Near Instantaneous Companded Audio Multiplex) A format for digital sound over television Reproduces stereo sound (Off / On) <ul style="list-style-type: none"> Off if reception is poor (FM monaural sound) Analogue mode only
	HDMI Input	Select to fit the input signal (Auto / Digital / Analogue) (p. 39) Auto : Automatic detection of digital or analogue sound source Digital : HDMI cable connection Analogue : HDMI-DVI adapter cable connection <ul style="list-style-type: none"> HDMI input mode only
	Audio Description Menu	Audio Description
Volume		Adjusts the volume for audio description
Speakers		Set to “On” to active the description sound track from TV speakers (Off / On)
Headphones		Set to “On” to active the description sound track from headphones (Off / On)
	Reset to Default	Press the OK button to reset the present Sound Mode to the default settings <ul style="list-style-type: none"> Effective to Bass, Treble, Balance and Headphone Volume

■ Menu list

Menu	Item	Adjustments / Configurations (alternatives)	
Setup	DVB Timer Programming	Records future programmes (p. 36)	
	DVB Profile Edit	Creates list of favourite programmes (p. 29)	
	DVB Service List	Skips the unwanted DVB channels (p. 29)	
	Q-Link Settings	Q-Link	Selects which AV terminal is to be used for data communication between this TV and a compatible recording equipment (AV1 / AV2) (p. 38)
		AV1 / AV2 out	Chooses the signal to be transmitted from the TV to Q-Link (Analogue / DVB / AV1 / AV2 / AV3 / Monitor) <ul style="list-style-type: none"> ● Monitor: Image displayed on screen ● Component and HDMI signals cannot be outputted
		Download	Downloads analogue channel information to a Q-Link compatible equipment connected to the TV
		Child Lock	Locks a programme channel to prevent access to it (p. 29)
	Tuning Menu	Auto Setup	Automatically sets the channels received in the area (p. 31)
		Analogue Programme Edit	Edits analogue channels (p. 31)
		DVB Manual Tuning	Sets the DVB channels manually (p. 32)
		Analogue Manual Tuning	Sets the analogue channels manually (p. 32)
		Add New DVB Services	Adds new DVB services (p. 32)
		New Service Message	Selects whether to give a notification message when a new DVB service is found (p. 32)
		DVB Signal Condition	Checks the DVB signal condition (p. 32)
		Off Timer	Sets the time the TV automatically turns Off (Off / 15 / 30 / 45 / 60 / 75 / 90 minutes)
		Power on Preference	Set to "TV" to view picture from TV tuner. Set to "AV" to view input from an external equipment connected to a SCART terminal, e.g. satellite receiver (TV / AV) <ul style="list-style-type: none"> ● The external equipment must be switched on and sending a control signal for automatic switching at power on to occur
		Teletext	Analogue teletext display mode (FASTTEXT / List) (p. 19)
		Preferred Subtitles	Selects the preferred language for DVB subtitles (depending on the broadcaster) <ul style="list-style-type: none"> ● To display subtitles → p. 13
		Shipping Condition	Resets all settings, for example, when moving house (p. 33)
		Owner ID	Inputs the owner ID (p. 34)
		Common Interface	Uses to watch pay-TV (p. 27)
		System Update	Downloads new software to TV (p. 27)
		Input Labels	Labels or skips each input terminals (p. 35)
		Banner Display Timeout	Sets how long the information banner (p. 13) stays on screen <ul style="list-style-type: none"> ● 0 (No display) to 10 sec. in 1-sec. increments
		VIERA Link	Sets to use VIERA Link functions (Off / On) (p. 40)
		Software Licence	Displays the software licence information
	System Information	Displays the system information of this TV	

● Only available items can be selected.

How to Use Menu Functions

Overview

● How to operate (p. 21)

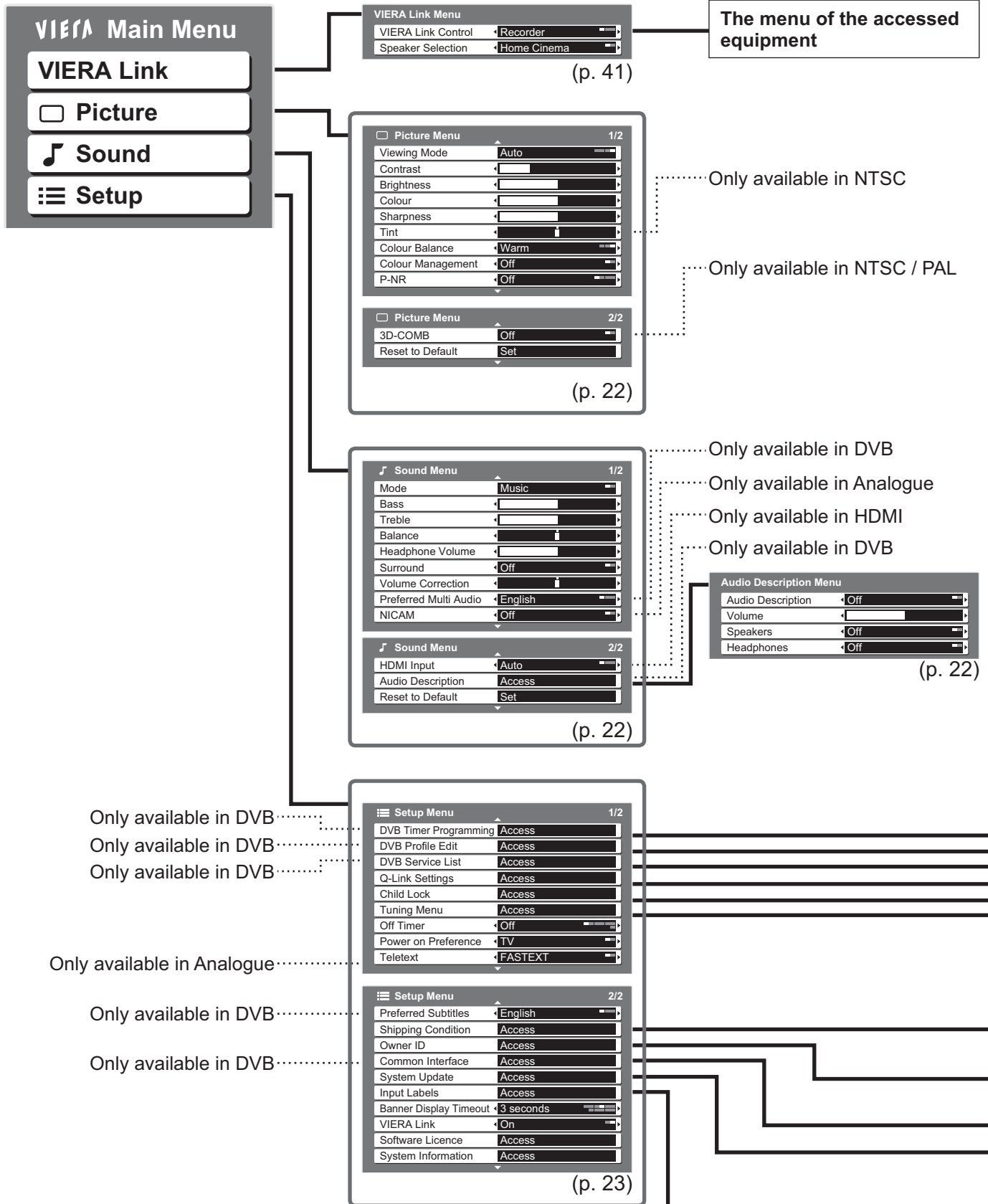

NTSC (National Television System Committee): One of television signal used in USA, etc.

DVB Timer Programming Wed 05/08/04 18:50

Pos.	Name	Date	Start	End	min.	Off
1	BBC1	6/8 FR	18:00	20:00	120	Off
3	ITV1	7/8 SA	21:30	22:30	60	Off

(p. 37)

Profile Editor

All DVB Services	Profile 1
1 BBC One Wales	
7 BBC THREE	
14 E4	
70 CBBC Channel	
72 Cartoon Nwk	
105 BBC1	
719 BBC Radio Wales	
720 BBC Radio Cymru	

(p. 29)

DVB Service List

70	CBBC Channel	<input checked="" type="checkbox"/>
72	Cartoon Nwk	<input checked="" type="checkbox"/>
105	BBC1	<input checked="" type="checkbox"/>
719	BBC Radio Wales	<input type="checkbox"/>
720	BBC Radio Cymru	<input type="checkbox"/>
1	BBC ONE Wales	<input checked="" type="checkbox"/>
7	BBC THREE	<input checked="" type="checkbox"/>

(p. 29)

Q-Link Settings

Q-Link: AV2

AV2 out: Analogue

Download: Access

(p. 23)

Child Lock

Change PIN: Access

Child Lock Service List

(p. 29)

Analogue Programme Edit

Prog.	Chan.	Name
1	CH33	1 2 3
2	CH21	X Y Z
3	CH21	F T P
4	CH60	
5	CH21	4 5 6

(p. 31)

DVB Manual Tuning

Frequency: [CH1] 474.00 MHz

Signal Quality: 0 10

Signal Strength: 0 10

Prog.	Channel	Service Name	Net ID	TS ID	Quality

Stopped

(p. 32)

Auto Setup - Digital and Analogue

Digital Scan: 21 68

Analogue Scan: 21 68

Channel	Service Name	Type	Quality
62	CBBC Channel	DVB	10
62	BBC Radio Wales	DVB	10
62	BBC Radio Cymru	DVB	10
62	E4	DVB	10
62	Cartoon Nwk	DVB	10
29	BBC1	Analogue	-
33	BBC1	Analogue	-

This will take about 3 mins.

(p. 31)

Analogue Manual Tuning

Programme: 1 BBC1 [CH33]

Manual Tuning: 21 68

(p. 32)

ADD New DVB Services

Please wait: 21 68

Prog.	Channel	Service Name	Net ID	TS ID	Quality

This will take about 3 mins.

(p. 32)

Tuning Menu

- Auto Setup: Access
- Analogue Programme Edit: Access
- DVB Manual Tuning: Access
- Analogue Manual Tuning: Access
- Add New DVB Services: Access
- New Service Message: On
- DVB Signal Condition: Access

(p. 30)

DVB Signal Condition

DVB Programme: [70] CBBC Channel

Signal Quality: 0 5 10

Signal Strength: 0 5 10

(p. 32)

Only available in Analogue
Only available in DVB
Only available in Analogue
Only available in DVB
Only available in DVB
Only available in DVB

Shipping Condition

All tuning data will be erased

Are you sure?

Are you sure?

(p. 33)

Owner ID

Please enter new PIN

PIN: * * * *

(p. 34)

System Update

Auto Update Search in Standby: On

System Update Search Now

(p. 27)

Common Interface

Slot 1: Module inserted

(p. 27)

Input Labels

AV1: DVD

AV2/AV2S: AV2/AV2S

AV3/AV3S: AV3/AV3S

COMPONENT: COMPONENT

HDMI: HDMI

(p. 35)

DVB Settings (DVB mode)

DVB Settings provide access to various advanced features.

1 If in Analogue mode
Select DVB

2 **Display the menu**

3 **Select “Setup”**

4 **Select “Common Interface” or “System Update”**

5 **Set**

■ To return to TV
EXIT

VIÉRA Main Menu

VIÉRA Link
<input type="checkbox"/> Picture
<input type="checkbox"/> Sound
<input checked="" type="checkbox"/> Setup

Setup Menu 2/2

Preferred Subtitles	English
Shipping Condition	
Owner ID	
Common Interface	Access
System Update	Access
Input Labels	
Banner Display Timeout	3 seconds
VIÉRA Link	On
Software Licence	

② access
① select

② access
① select

Editing Channels

You can make your favourite channel lists, skip unwanted channels and control channel audience.

1 **Select DVB or Analogue**

 TV

- “DVB Profile Edit” and “DVB Service List” are available in DVB mode only.

2 **Display the menu**

 MENU

3 **Select “Setup”**

VIERA Main Menu	
VIERA Link	
Picture	
Sound	
Setup	

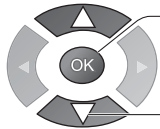

4 **Select “DVB Profile Edit”, “DVB Service List” or “Child Lock”**

Setup Menu 1/2	
DVB Timer Programming	
DVB Profile Edit	Access
DVB Service List	Access
Q-Link Settings	
Child Lock	Access
Tuning Menu	
Off Timer	Off
Power on Preference	TV
Teletext	FASTTEXT

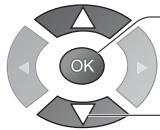

To return to TV

 EXIT

5

Set

List favourite channels

DVB Profile Edit (DVB mode)

Create your favourite channel list (Profile) from various broadcasters (up to 4: Profile 1 to 4). The list is added to "Category" in TV Guide (p. 14) and information banner (p. 13) and then easily accessed.

1 Select a channel and add it to the list

A channel is added

To change the category → red

To display another Profile → blue

To add all channels to the list → yellow

To edit Profile

Select the field of Profile to edit and:

- To name the Profile → red → Select the character → OK
- To move the channel → green → Select the new position → Confirm → OK
- To delete the channel → yellow
- To delete all channels → blue

2 Store

- Channel numbers (known as logical channel numbers) cannot be changed, due to broadcast restrictions.

Skip unwanted channels

DVB Service List (DVB mode)

You can hide unwanted services. The deleted services cannot be displayed except in this function. Use this function to skip unwanted services.

Select a service and add / delete

add / delete

select

:add

:delete (skip)

Control channel audience

Child Lock

You can lock specific channels and control who watches them. (When a channel is selected, a message appears; by entering the PIN number, you can watch the channel.)

1 Enter the PIN number (4 digits)

- Enter the PIN number twice at first setting.
- Make a note of the PIN number in case you forget it.

2 Select "Child Lock Service List"

access

select

3 Select the channel to be locked

set

select

- To cancel → Select the locked channel → OK
- To lock all channels → yellow
- To cancel all channel locks → blue

Appears when the channel is locked

To change the PIN number

Select "Change PIN" in 2 and enter a new PIN number twice.

Note

- Setting "Shipping Condition" (p. 33) erases the PIN number and all settings.

Tuning Channels

You can re-tune all TV channels when moving house or search for new services which may have recently started broadcasting.

1 Select DVB or Analogue

TV

- “DVB Manual Tuning”, “Add New DVB Services”, “New Service Message” and “DVB Signal Condition” are available in DVB mode only.
- “Analogue Programme Edit” and “Analogue Manual Tuning” are available in Analogue mode only.

2 Display the menu

MENU

3 Select “Setup”

VIERA Main Menu	
VIERA Link	
<input type="checkbox"/> Picture	
Sound	
Setup	

② access
① select

4 Select “Tuning Menu”

Setup Menu		1/2
DVB Timer Programming		
DVB Profile Edit		
DVB Service List		
Q-Link Settings		
Child Lock		
Tuning Menu	Access	
Off Timer	Off	
Power on Preference	TV	
Teletext	FASTEXT	

② access
① select

5 Select a function and set

Tuning Menu	
Auto Setup	Access
Analogue Programme Edit	Access
DVB Manual Tuning	Access
Analogue Manual Tuning	Access
Add New DVB Services	Access
New Service Message	On
DVB Signal Condition	Access

② access
① select

■ To return to TV

EXIT

Edit Analogue channels

Analogue Programme Edit

- Delete
- Add
- Move
- Change name

Edit the analogue programme position settings

- To change channel number
- ➔ "Analogue Manual Tuning"

① Select the channel to edit

Prog.	Chan.	Name
1	CH33	1 2 3
2	CH21	X Y Z
3	CH21	F T P
4	CH60	
5	CH21	4 5 6

Cursor



select

Name

Channel

3	FTP	23:35	Profile 1
Coronation Street		Change category	
For info press i			

② Edit

- To delete ➔
 - ➔ After confirming, press

- To add ➔
 - ➔ After confirming, press

- To move ➔
 - ➔ Select new position ➔

- To change the name of the broadcaster displayed when selecting channels

Prog.	Chan.	Name
1	CH33	1 2 3
2	CH21	X Y Z
3	CH21	F T P
4	CH60	
5	CH21	4 5 6

- Select the "Name" field

- Enter the "User Input" mode

- Select the character

- Set

(Maximum: five characters)

Automatically set the DVB and Analogue channels received in the area.
If a Child Lock PIN number (p. 29) has been set, it must be entered.

Start Auto Setup

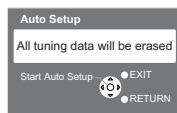

Settings are made automatically

Channel	Service Name	Type	Quality
33	BBC1 Channel	DVB	10
62	BBC Radio Wales	DVB	10
62	BBC Radio Cymru	DVB	10
62	E4	DVB	10
62	Cartoon Nwk	DVB	10
29	BBC1	Analogue	-
33	BBC1	Analogue	-

This will take about 5 mins.

- All previous settings are erased.
- The analogue settings are downloaded to a Q-Link compatible equipment connected to the TV.

- When the operation is completed, the digital broadcast of programme number "1" will appear.
If no DVB services are found, the analogue broadcast will appear.
- If tuning has not done completely ➔ "DVB Manual Tuning", "Analogue Manual Tuning"

Set DVB and Analogue channels automatically

Auto Setup

For Auto Setup, using the buttons on the top of the TV

- ① Press repeatedly until "Auto Setup" appears



- ② Access "Auto Setup"



- ③ Start "Auto Setup"



- To return to TV ➔

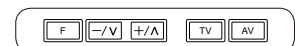

Tuning Channels

Set DVB channel manually

DVB Manual Tuning

Normally use "Auto Setup" or "Add New DVB Services" for the DVB channel setting. If tuning has not done completely, use this function.

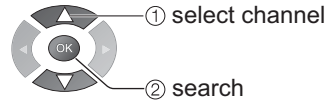
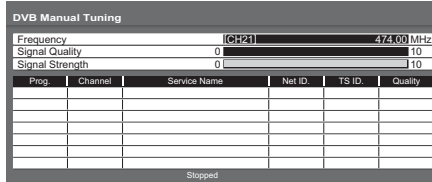

- All services found will be added to the DVB Service List (p. 29) automatically.

Set Analogue channel manually

Analogue Manual Tuning

Set Analogue channel manually after Auto Setup. If a VCR is connected with only the RF cable, select programme position "0".



Select the programme position



Select the channel



Search and store

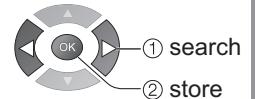

Add DVB channel automatically

Add New DVB Services

Any new services found will be added to the DVB Service List (p. 29) automatically.

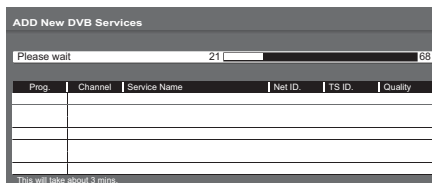

- The new service is added with the current settings saved as they are.

Display a notification message

New Service Message

Selects whether to give a notification message when a new DVB service is found. **(Off / On)**

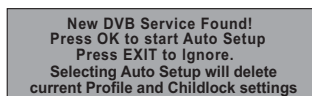

- Selecting OK (Auto Setup) will delete current Profile and Childlock settings.

Check DVB signal

DVB Signal Condition

Selects a channel and checks the DVB signal condition. Use for adjusting the direction of the aerial.

- To change the programme during the menu appears →

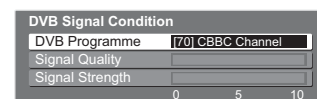

Signal Quality:

- Green bar → Good
- Yellow bar → Poor
- Red bar → Bad (Check the aerial)

Restore Settings

Resets the TV to its original condition, i.e. no channels tuned in. All settings other than "Owner ID" (channels, picture, sound quality, etc.) are reset.

1 Display the menu
 MENU

2 Select "Setup"
 VIERA Main Menu
 VIERA Link
 Picture
 Sound
Setup

3 Select "Shipping Condition"
 Setup Menu 2/2
 Preferred Subtitle English
Shipping Condition Access
 Owner ID
 Common Interface
 System Update
 Input Labels
 Banner Display Timeout 3 seconds
 VIERA Link On
 Software Licence

4 Set
 EXIT

Restore Settings

Shipping Condition

① Check the message and initialise

Shipping Condition

All tuning data will be erased
 Are you sure?
 Are you sure?

Confirm

● EXIT
● RETURN

● OK — set

② Follow the on-screen instructions

- "Auto Setup" will automatically start when Mains power On / Off switch is next turned On. (p. 10)

■ To re-tune TV channels only, e.g. after moving house

- ➔ "Auto Setup" (p. 31)

Owner ID

Entry of the security code (PIN number) and “personal information” (your name, address and post code). In the unfortunate event of theft it will help the Police to determine the owner.

If you have skipped the Owner ID input in “Auto Setup” (p. 10), and input it later, start from ①.

If you input the Owner ID in “Auto Setup” (p. 10), perform ④.



①

Display the menu

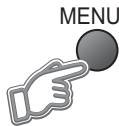

②

Select “Setup”

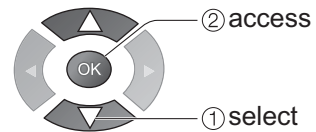

③

Select “Owner ID”

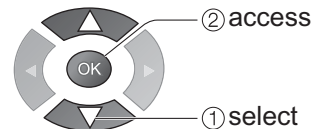
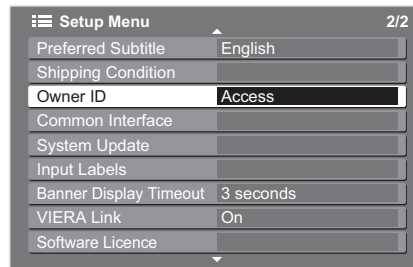

■ To return to TV



④

Set

① Enter the PIN number (4 digits)

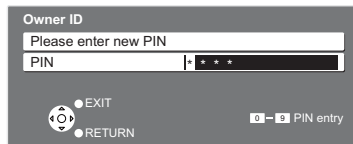

- Enter the PIN number twice at first setting.
- Make a note of the PIN number in case you forget it.

② Enter your name, address, and post code, in that order



Select the entry field



Enter the “User Input” mode



Select the character



Store

Input owner ID

Owner ID

To check the “personal information” stored

[F] Hold down for about 3 sec.



Displays the information on the screen (for several sec.)

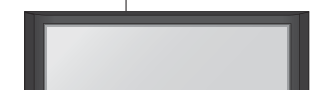
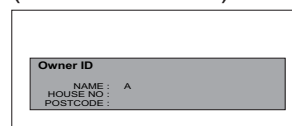

- The PIN number is not displayed.

■ To change the PIN number

Select the “PIN” field

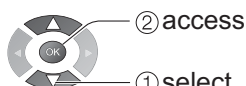

Enter a new PIN number twice

Input Labels

For easier identification and selection of the input mode, you can label each input terminals or skip terminal that is not connected to any equipment.
(To select the input mode → p. 16)

1 Display the menu
MENU

2 Select "Setup"

VIERA Main Menu
VIERA Link
Picture
Sound
Setup

 ② access
① select

3 Select "Input Labels"

Setup Menu	2/2
Preferred Subtitle	English
Shipping Condition	
Owner ID	
Common Interface	
System Update	
Input Labels	Access
Banner Display Timeout	3 seconds
VIERA Link	On
Software Licence	

 ② access
① select

4 Select a input terminal and set

Input Labels	
AV1	DVD
AV2/AV2S	AV2/AV2S
AV3/AV3S	AV3/AV3S
COMPONENT	COMPONENT
HDMI	HDMI

 ② set
① select

■ **To return to TV**
EXIT

The labels you set will be displayed in "Input Selection" menu (p. 16) or banner.
● If "Skip" is selected, you cannot select the mode.

■ User Input

You can name each input terminals freely.

Select "User Input"

Set characters

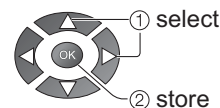
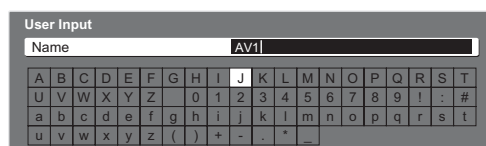
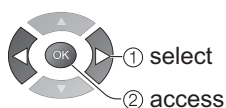

(maximum: ten characters)

Recording Controls (DVB mode)

Timer Programming from Menu

The Timer programming menu allows you to choose programmes that you wish to record. At the correct time, the DVB system will switch on and tune to the correct station (even if the TV is in Standby mode). If the recording equipment is compatible with Q-Link or similar technologies (p. 38) and connected to the TV's AV2 terminal using a SCART cable (p. 42), you do not need to programme the device – the DVB system will control the recording process. TV Guide may also be used to set timer programmes. (p. 14)

1 If in Analogue mode
Select DVB

2 **Display the menu**

3 **Select "Setup"**

4 **Select "DVB Timer Programming"**

5 **Set**

6 **Store**

■ **To return to TV**



■ **To stop recording**



Caution

- The TV must either be On or in standby.
- For preparations of a recording equipment, read the manual of equipment.
- No other DVB channel can be selected during recording. However you can watch analogue channels.
- It may not be possible to record an encrypted programme (which is copy-protected).

Set timer programming details

① Start making the settings

② Repeat the operations as below, and set items in the order of ① to ⑤

start → select the item → set

● ①, ③ and ④ can also be entered with numeric buttons.

Previous timer programming event

Current timer programming event

Pos.	Name	Date	Start	End	min.	
1	BBC1	6/8 FR	18:00	20:00	120	Off
3	ITV1	7/8 SA	21:30	22:30	60	Off

⑤ Subtitles (Off / Auto)

● Recording time (automatic display)

① Channel

② Date

③ Starting time

④ Ending time

● one day ahead

● daily or weekly (press repeatedly)

● Daily SU-SA: Sunday to Saturday

● Daily MO-SA: Monday to Saturday

● Daily MO-FR: Monday to Friday

● Weekly SA/FR/TH/WE/TU/MO/SU: Same time on the same day every week

■ To change a timer programming event

→ Select the programme to be changed using [OK] and press [OK]

→ Correct as necessary (as above)

■ To cancel a timer programming event

→ Select the programme to be deleted using [OK] and press [red] [OK]

Direct TV recording:

You can record the current programme to DVD Recorder or VCR immediately. (p. 38)

Note

- Confirm the DVB LED lights (Orange). If not, a timer programming is not available.
- A message will appear if you try to programme a timer event which overlaps an already programmed event.
- 2 min. before the starting time: a reminder message appears.
(To remove the message → [OK]; To cancel the programming → [EXIT])
- 10 sec. before the starting time: in DVB mode, the TV automatically selects the programmed channel.
- Cancelling the programming may not be valid immediately before the starting time. In this case, directly operate the recording equipment to cancel recording.

TV Guide—Electronic Programme Guide (EPG)—Timer Recording

① View TV Guide



● There are two styles of display for TV Guide (Landscape / Portrait)

② Select the programme to be broadcast

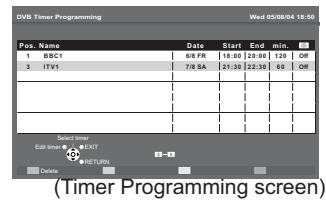
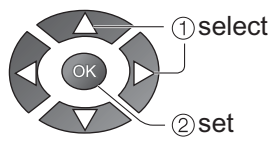

DVB LED will turn on if Timer Programming is set.

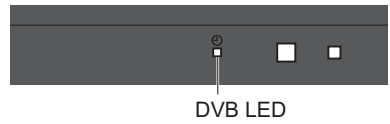

● Orange DVB LED (Rapid blinking during recording)

■ To check / change / cancel a timer programming event → "Timer Programming" (above)

Q-Link Functions

Q-Link connects the TV and VCR / DVD recorder, enables easy recording and playback.

■ Condition

- Use the VCR / DVD recorder with the following logos:
“Q-Link”, “NEXTVIEWLINK”, “DATA LOGIC”, “Easy Link”, “Megalogic”, or “SMARTLINK”
- Connect the equipment to this TV’s AV1 or AV2 terminal via a “fully-wired” SCART cable. (p. 42)
- Q-Link terminal setup in Setup menu (Q-Link, AV1 / AV2 out). (p. 23)

■ Download analogue channel settings

- Perform Auto Setup. (p. 31)
When first using this TV, see “Auto Setup”. (p. 10)
- Perform download to the equipment. (p. 23)

■ Features available

Some recording equipments are not applicable. Read the manuals of the equipment.

What you see is
What you record



Direct TV Recording:

Recording the current programme in VCR / DVD recorder immediately.

- When Direct TV Recording is performed, the recording equipment is automatically turned on if it is in Standby mode.
- The recording equipment is recording from its own tuner. You can turn the TV off during recording (Analogue only).
- If you turn the TV off during recording from an AV source, the recording will be stopped.
- When Direct TV Recording is performed while watching DVB channel, the DVB programme position is locked and no other DVB channel can be selected. However you can watch analogue channels.

■ To change DVB channel, stop recording



Information / Message

Recording information or if recording is not possible, a message is displayed. (Only when the programme number is “0” or “AV mode” for some equipment.)

Power on link and Easy playback

When VCR or DVD recorder starts playback or direct navigator / function menu for the equipment are activated, the TV is turned on and input mode is switched automatically so that you can view the content. (Only when TV is in Standby mode.)

Power off link

When TV is set to Standby mode, the recording equipment is also automatically set to Standby. (Only when the videocassette or DVD is not active.)

- “DATA LOGIC” (a trademark of Metz Corporation)
 - “Easy Link” (a trademark of Philips Corporation)
- Read the manuals of the equipment too.

- “Megalogic” (a trademark of Grundig Corporation)
- “SMARTLINK” (a trademark of Sony Corporation)

HDMI Functions

HDMI (high-definition multimedia interface) allows you to enjoy high-definition digital images and high-quality sound by connecting the TV and the equipment.

HDMI-compatible equipment (*1) with an HDMI or DVI output terminal, such as a set top box or a DVD player, can be connected to the HDMI terminal using an HDMI compliant (fully wired) cable.

About connections, see “External Equipment” (p. 42).

Note

- HDMI is the world’s first complete digital consumer AV interface complying with a non-compression standard.
- If the external equipment has only a DVI output, connect to the HDMI terminal via a DVI to HDMI adapter cable (*2).
- When the DVI to HDMI adapter cable is used, connect the audio cable to the audio input terminal (HDMI: use COMPONENT-AUDIO terminals).
- Audio settings can be made on the “HDMI Input” menu screen. (p. 22)
- Applicable audio signal sampling frequencies (2ch L.PCM): 48 kHz, 44.1 kHz, 32 kHz
- Use with a PC is not assumed.
- If the connected equipment has an aspect adjustment function, set the aspect ratio to “16:9”.
- These HDMI connector is “type A”.
- This HDMI connector is compatible with HDCP (High-Bandwidth Digital Content Protection) copyright protection.
- An equipment having no digital output terminal may be connected to the input terminal of either “Component”, “S-VIDEO”, or “Video” to receive analogue signals.
- The HDMI input terminal can be used with only the following image signals:
480i, 480p, 576i, 576p, 720p, 1080i and 1080p. Match the output setting of the digital equipment.
- For details of the applicable HDMI signals, see p. 46.

(*1): The HDMI logo is displayed on HDMI-compliant equipment.

(*2): Enquire at your local digital equipment retailer shop.

Summary of Control functions

Connecting with an HDMI cable to Panasonic equipment with VIERA Link function, you can control the equipment (p. 40). You can use VIERA Link and Q-Link functions together.

Function \ Connection	VIERA Link and Q-Link (HDMI)	VIERA Link and Q-Link (SCART)	VIERA Link only (HDMI)	Q-Link only (SCART)
Easy playback	○	○	○	○
Power on link	○	○	○	○
Power off link	○	○	○	○
Speaker control	○ (not via SCART)	○	○	—
Easy control only with VIERA remote control	○ (not via SCART)	○	○	—
Direct TV Recording	○ (not via HDMI)	○	—	○
Analogue channel download	○ (not via HDMI)	○	—	○

HDMI Functions

VIERA Link “HDAVI Control™”*

*Enjoy additional HDMI Inter-Operability with Panasonic products which have “HDAVI Control” function. This TV supports “HDAVI Control 2” function.

Connections to some Panasonic equipment (DVD Recorder DIGA, HD Video Camera, Player theatre, Amplifier, etc.) with HDMI cables allow you to interface them automatically.

The equipment with “HDAVI Control” function enables the following operations:

- Easy playback (p. 41)
- Power on link (p. 41)
- Power off link (p. 41)
- Speaker control (p. 41)

In addition, the equipment with “HDAVI Control 2” function enables the following operation:

- Access and control the connected equipment by VIERA remote control (p. 41)

These features are limited to models incorporating Panasonic’s “HDAVI Control” and “VIERA Link”.

The operations with other manufacturer’s equipment cannot be guaranteed.

Refer to individual manuals for compatibility information. About applicable equipment, consult your local Panasonic dealer or refer to the URL: www.panasonic.co.uk

■ HDMI cable

This function needs an HDMI compliant (fully wired) cable. Non-HDMI-compliant cables cannot be utilized. It is recommended that you use Panasonic’s HDMI cable. Recommended part number:

- RP-CDHG15 (1.5 m)
- RP-CDHG30 (3.0 m)
- RP-CDHG50 (5.0 m)

■ Preparations

Setup the equipment to enable this function. Read the manuals of the equipment.

About connections, see “External Equipment” (p. 43). Read the manuals of the equipment too.

■ For the first time / When adding new equipment, reconnecting equipment or changing setup

After connection turn the equipment on and then switch the TV on.

Select the input mode to HDMI (p. 16), and make sure that an image is displayed correctly.

1 Display the menu

2 Select “Setup”

3 Select “VIERA Link”

4 Set to “On” (default is On)

Access and control the connected equipment by VIERA remote control

You can control some functions of the connected Panasonic equipment with this TV remote control (point the remote control at the TV's signal receiver).
 ● If you cannot access the menu, check the settings and the equipment (p. 40).

Access and operate the menu of the equipment

① **Display "VIERA Link Menu"** →

② **Select "VIERA Link Control"**



③ **Select the equipment you want to access**

- "Home Cinema" means Player theatre, Recorder theatre and Amplifier.

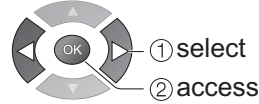

■ **When the equipment with "HDAVI Control 2" function is connected**



Recorder / Player / Home Cinema / Video Camera

Displayed the kind of the connected equipment. Select the kind of the equipment and access.

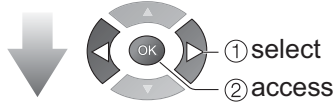

The menu of the accessed equipment
 (Input mode will be changed automatically)

■ **When the equipment with "HDAVI Control" function is connected**



Recorder / Player / Home Cinema / Video Camera

Displayed the kind of the connected equipment. But you cannot access it. Use its own remote control to operate the equipment.

■ **When other kind or other manufacturer of the equipment is connected**



Others

"Others" is displayed. You cannot access it. Use its own remote control to operate the equipment.

④ **Operate the menu of the equipment**

- Available VIERA remote control buttons (depending on the connected equipment):

	Move the cursor / select the menu		Exit the menu
	Move the cursor / access / adjust		Display the operation guide for the equipment The same functions with the OPTION button of the equipment
	Store / Set / Access		Access when the key words are displayed on colour bar
	Return to the previous menu		

- About the operations for the equipment, read the manual of the equipment.

Easy playback

Automatic Input switching-When the connected Panasonic equipment is operated, input mode is switched automatically. When it is stopped operating, input mode is returned.

Power on link

When the connected Panasonic equipment starts playback or direct navigator / function menu for the equipment are activated, the TV is automatically turned on. (Only when TV is in Standby mode.)

Power off link

When TV is set to Standby mode, the connected Panasonic equipment is also automatically set to Standby.
 ● This function will work even if the TV enters standby mode automatically by Off Timer function or auto power standby function.

Speaker control

You can control the theatre speaker with TV's remote control. This function is available when Panasonic Amplifier or Player theatre is connected.

- If you cannot access the menu, check the settings and the equipment (p. 40).

① **Display "VIERA Link Menu"** →

② **Select "Speaker Selection"**



③ **Set to "Home Cinema" or "TV"**



■ **Home Cinema**

Adjustment for equipment (automatically turned on if it is in Standby mode).

Volume up / down →

Mute →

- The sound of TV speakers is mute.
- When the equipment is turned off, TV speakers will be active.

■ **TV**

TV speakers are active.

External Equipment

These diagrams show our recommendations for how to connect the TV to your various equipment. For other connections, consult the instructions for each piece of equipment, the table below, and the specifications (p. 51).

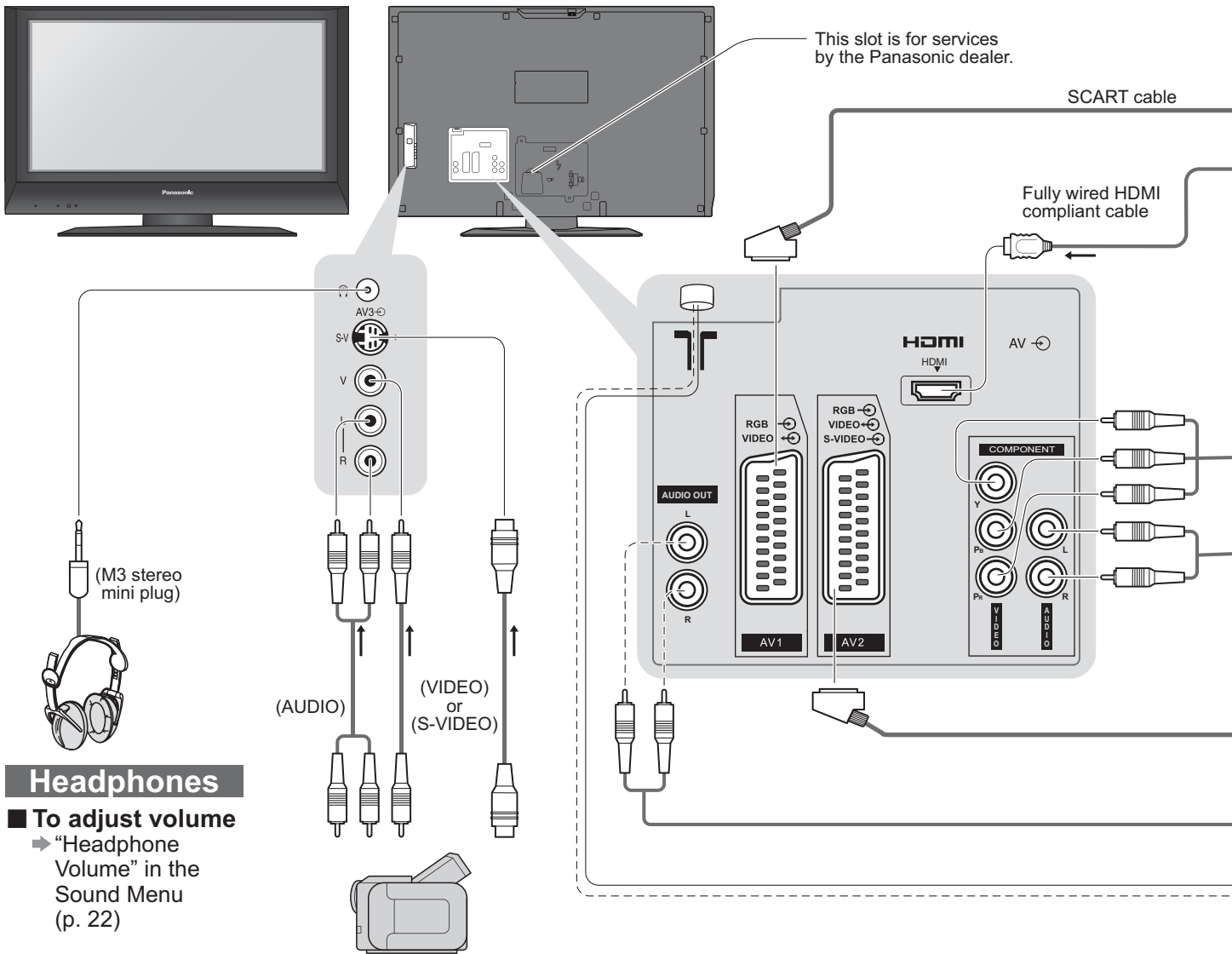

Headphones

- To adjust volume
 - "Headphone Volume" in the Sound Menu (p. 22)

Camcorder / Game equipment

Types of connectable equipment to each connector

Connector	AV1	AV2	AV3	COMPONENT	AUDIO OUT	HDMI
Recording / Playback (equipment)			(Side of TV)	 		
■ To record / playback videocassettes / DVDs (VCR / DVD recorder)	<input type="radio"/>	<input type="radio"/>				
■ To watch DVDs (DVD player)	<input type="radio"/>	<input type="radio"/>	<input type="radio"/>	<input type="radio"/>		<input type="radio"/>
■ To watch camcorder images (Video camera)	<input type="radio"/>	<input type="radio"/>	<input type="radio"/>			<input type="radio"/>
■ To watch satellite broadcasts (Set top box)	<input type="radio"/>	<input type="radio"/>	<input type="radio"/>			<input type="radio"/>
■ To play games (Game equipment)	<input type="radio"/>	<input type="radio"/>	<input type="radio"/>			<input type="radio"/>
■ To use amplifier with speaker system					<input type="radio"/>	
■ Q-Link	<input type="radio"/>	<input type="radio"/>				
■ Direct TV Recording	<input type="radio"/>	<input type="radio"/>				
■ VIERA Link						<input type="radio"/>

○: Recommended Connection

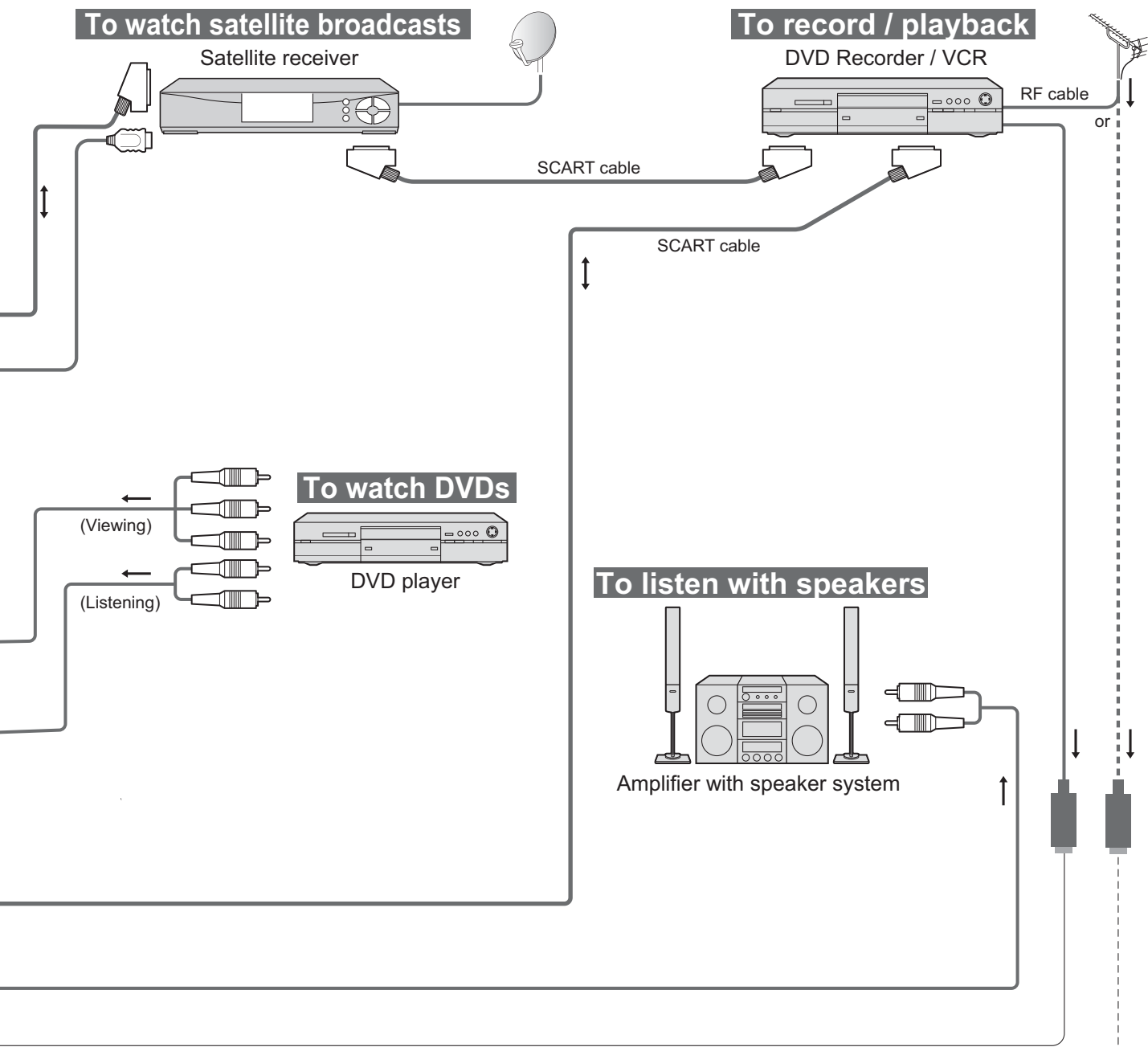

VIERA Link (p. 40)

- Use fully wired HDMI compliant cable.
- Read the manuals of the equipment too.

Easy playback, Easy control only with VIERA remote control

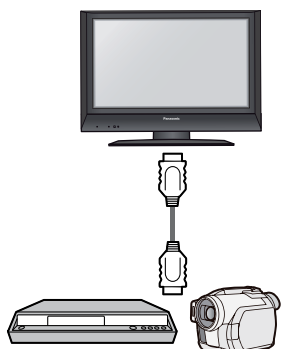

Panasonic DVD Recorder, HD Video Camera, etc.

Home Cinema

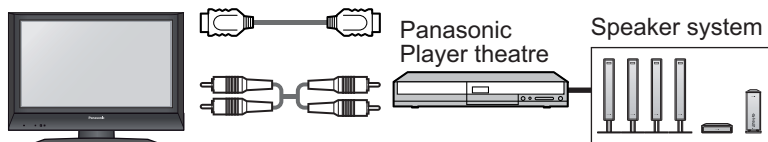
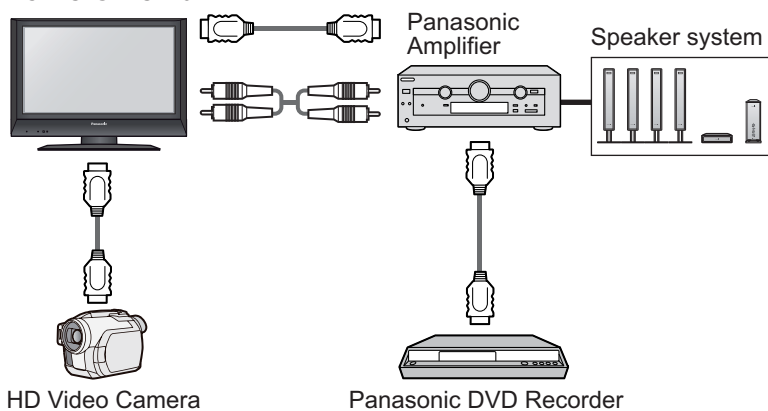

Technical Information

Aspect Ratio

The optimum size and aspect can be chosen, and you can enjoy finer images. (p. 13)

■ **Auto aspect:** Auto aspect determines the best aspect ratio to use to fill your screen. It does this using a four step process to determine if the picture being viewed is a widescreen picture.

If Auto aspect detects a widescreen signal it switches into the appropriate 16:9 or 14:9 widescreen mode. If Auto aspect does not detect a widescreen signal then this advanced TV enhances the picture for optimum viewing pleasure.

The text shown on the screen indicates how Auto aspect determined which ratio to use:

“WIDE” appears in the top left of the screen if a widescreen identification signal (WSS) is found or a signal found through a SCART terminal. Auto aspect switches to the appropriate 16:9 or 14:9 widescreen ratio. This function will also work in any aspect mode. “Auto aspect” appears in the top left of the screen if black stripes above and below the picture are detected. Auto aspect chooses the best ratio and expands the picture to fill the screen. This process can take several minutes, depending on the darkness of the picture.

Signal name		Aspect modes							Aspect Control Signal							
		Auto aspect	16:9	14:9	4:3	Zoom1	Zoom2	Zoom3	Widescreen signal (WSS)					Control signal through SCART (pin 8) or HDMI terminal		
								TV	AV1	AV2	AV3	Component	AV1	AV2	HDMI	
TV/AV1/AV2/AV3	PAL	○	○	○	○	○	○	○	○	○	○	○	○	○	○	○
	PAL 525/60	○	○	○	○	○	○	○	○	○	○	○	○	○	○	○
	DVB	○	○	○	○	○	○	○	○	○	○	○	○	○	○	○
	M.NTSC	○	○	○	○	○	○	○	○	○	○	○	○	○	○	○
Component/HDMI	NTSC(AV input only)	○	○	○	○	○	○	○	○	○	○	○	○	○	○	○
	SD	525(480)/60i	○	○	○	○	○	○	○	○	○	○	○	○	○	○
		525(480)/60p	○	○	○	○	○	○	○	○	○	○	○	○	○	○
	SD	625(576)/50i	○	○	○	○	○	○	○	○	○	○	○	○	○	○
		625(576)/50p	○	○	○	○	○	○	○	○	○	○	○	○	○	○
	SD	750(720)/50p	○	○	○	○	○	○	○	○	○	○	○	○	○	○
		750(720)/60p	○	○	○	○	○	○	○	○	○	○	○	○	○	○
	HD	1125(1080)/50i	○	○	○	○	○	○	○	○	○	○	○	○	○	○
		1125(1080)/60i	○	○	○	○	○	○	○	○	○	○	○	○	○	○
		1125(1080)/50p	○	○	○	○	○	○	○	○	○	○	○	○	○	○
1125(1080)/60p		○	○	○	○	○	○	○	○	○	○	○	○	○	○	

Note

- The ratio varies depending on the programme, etc. If the ratio is greater than the standard “16:9”, black bands may appear at the top and bottom of the screen.
- If the screen size looks unusual when a widescreen-recorded programme is played back on a VCR, adjust the tracking of the VCR. (See the VCR manual.)
- Aspect mode can be memorized for SD (Standard definition) and HD (High definition) signals separately.
- To select the ratio manually:

Auto aspect



The best ratio is chosen and the picture expanded to fill the screen.

16:9



Directly displays the image at “16:9” without distortion (anamorphic).

14:9



Displays the image at the standard “14:9” without enlargement.

4:3



Displays the image at the standard “4:3” without distortion.

Zoom1

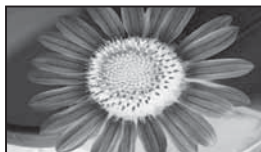

Displays a “16:9” letterbox or “4:3” image without distortion.

Zoom2

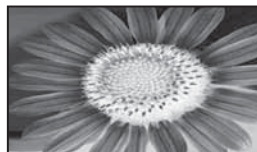

Displays a “16:9” letterbox (anamorphic) image full-screen without distortion.

Zoom3

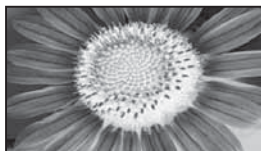

Displays a “2.35:1” letterbox (anamorphic) image full-screen without distortion. At “16:9”, displays the image at its maximum (with slight enlargement).

Updating the DVB software

From time to time, a new version of software for DVB mode may become available for download to enhance performance or operations of the TV.

A notification banner will appear when you tune to one of the BBC channels, or you can search for a new version software by using the “System Update Search Now” function (p. 27).

New version 1.00 found.
Do you really want to update the software and reboot the system?
Press OK to download the new version
Press EXIT to ignore

To start downloading press “OK”, this may take up to 20 minutes to complete.

To ignore the new software press “EXIT”, but this banner will keep appearing during the period of new software availability, usually 2 to 3 days.

To download any new software automatically, ensure that the “Auto Update Search in Standby” function in the System Update menu is set to “On” (p. 27).

The TV will then download new software automatically at night if it is left in standby without any timer programme in progress.

Note

- During software download and update, DO NOT switch off the TV.

VIERA Link “HDAVI Control™”

HDMI connections to some Panasonic equipment allow you to interface them automatically. (p. 40)

- This function may not work normally depending on the equipment condition.
- Image or sound may not be available for the first few seconds when the playback starts.
- Image or sound may not be available for the first few seconds when Input mode is switched.
- Volume function will be displayed when adjusting the volume of the equipment.
- Easy playback is also available by using the remote control for Amplifier or Player theatre. Read the manuals of the equipment.

Technical Information

SCART, S-VIDEO and HDMI terminal information

AV1 SCART terminal (RGB, VIDEO, Q-Link)

Suitable inputs for AV1 include RGB (Red / Green / Blue).

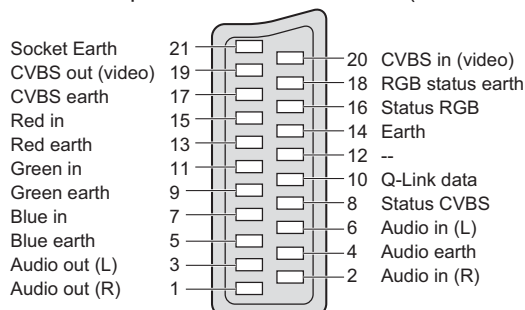

AV3 S-VIDEO 4 pin terminal

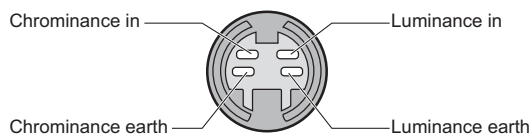

AV2 SCART terminal (RGB, VIDEO, S-VIDEO, Q-Link)

AV2 - Pins 15 and 20 are dependent on AV2 S-VHS / VIDEO switching
Suitable inputs for AV2 include RGB (Red / Green / Blue).

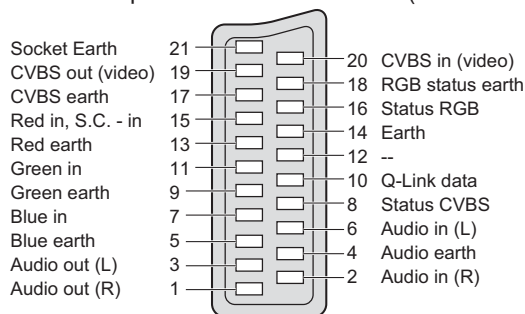

HDMI terminal

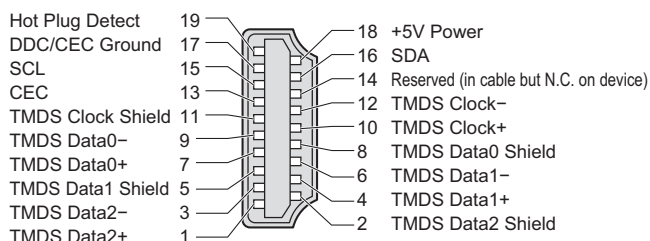

Input signal that can be displayed

COMPONENT (Y, P_B, P_R), HDMI

* Mark: Applicable input signal

Signal name	COMPONENT	HDMI
525 (480) / 60i	*	*
525 (480) / 60p	*	*
625 (576) / 50i	*	*
625 (576) / 50p	*	*
750 (720) / 60p	*	*
750 (720) / 50p	*	*
1,125 (1,080) / 60i	*	*
1,125 (1,080) / 50i	*	*
1,125 (1,080) / 60p		*
1,125 (1,080) / 50p		*

Note

- Signals other than above may not be displayed properly.
- The above signals are reformatted for optimal viewing on your display.

FAQs

Before requesting service or assistance, please follow these simple guides to resolve the problem. If problem still persists, please contact your local Panasonic dealer or Panasonic Customer Care Centre for assistance. For details (p. 52)

White spots or shadow images (noise)

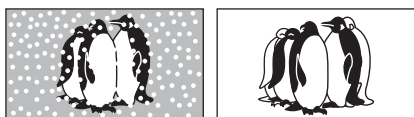

- Check the position, direction, and connection of the aerial.

Neither image nor sound is produced

- Is the TV in "AV mode"?
- Is the mains lead plugged into the socket outlet?
- Is the TV turned On?
- Check Picture Menu (p. 22) and volume.
- Check all required SCART cables and connections are firmly in place.

Auto aspect

- Auto aspect is designed to provide you with the best aspect ratio to use to fill your screen. For user control please see p. 44.

S-Video / black and white picture

- Using AV button please confirm your selection is S-Video i.e. AV2/AV2S (p. 16).

No programmes shown on TV Guide

TV Guide Portrait		Wed 12/05/04 10:46	
Wed 12th	Prog. Types	Category	
	All Types	All Services	
01 BBC 0	7 BBC 1	14 E4	D 70 CBBC
D 72 Cartoon	D 105 BBC3	D 718 BBC R4	

- Check the DVB transmitter.
- Adjust the direction of the aerial to another transmitter installed nearby.
- Check the analogue broadcast. If the image quality is poor, check the aerial and consult your nearest dealer.



On Screen messages - i.e. EC/AV1

- You can simply clear these by pressing the **i** button . Press again to redisplay.

Direct TV record / Q-Link functions not recording

- Please confirm SCART cable and connection. Also please set "AV1 / AV2 out" in the Setup Menu (p. 23).

There may be red spots, blue spots, green spots and black spots on the screen

- This is a characteristic of liquid crystal panels and is not a problem. The liquid crystal panel is built with very high precision technology giving you fine picture details. Occasionally, a few non-active pixels may appear on the screen as a fixed point of red, green, blue or black. Please note this does not affect the performance of your LCD.

The LCD panel moves slightly when it is pushed with a finger Clattered sound might be heard

- There are some looseness around the panel to prevent the damage to the panel. The panel might move slightly when it is pushed with a finger, and clattered sound might be heard. This is not a malfunction.

FAQs

	Problem	Actions
Screen	Chaotic image, noisy	<ul style="list-style-type: none"> ● Set "P-NR" in the Picture Menu (to remove noise). (p. 22) ● Check nearby electrical products (car, motorcycle, fluorescent lamp).
	No image can be displayed	<ul style="list-style-type: none"> ● Is "Colour" or "Contrast" in the Picture Menu set to the minimum? (p. 22)
	Blurry or distorted image (no sound or low volume)	<ul style="list-style-type: none"> ● Reset channels. (p. 30)
	Unusual image is displayed	<ul style="list-style-type: none"> ● Turn off the TV with Mains power On / Off switch, then turn it on again.
Sound	No sound is produced	<ul style="list-style-type: none"> ● Is "Sound mute" active? (p. 7) ● Is the volume set to the minimum?
	Sound level is low or sound is distorted	<ul style="list-style-type: none"> ● Sound signal reception may be deteriorated. ● Set "NICAM" (p. 22) in the Sound Menu to "Off". (Analogue only)
DVB	<ul style="list-style-type: none"> ● Due to the digital reception technologies involved, quality of the DTV signals may be relatively low in some cases, despite good reception of analogue programmes. 	
	Interference or frozen / disappearing image in DVB	<ul style="list-style-type: none"> ● Check "DVB Signal Condition". (p. 32) If "Signal Quality" or "Signal Strength" are displayed in red, check aerial. If problem persists, consult your local Panasonic dealer. ● Turn the TV off with the Mains power On / Off switch, then turn it On again.
HDMI	Sound is unusual	<ul style="list-style-type: none"> ● Set the sound setting of the connected equipment to "2ch L.PCM". ● Check the "HDMI Input" setting in the Sound Menu. (p. 22) ● If digital sound connection has a problem, select analogue sound connection. (p. 39)
	Pictures from external equipment are unusual when the equipment is connected via HDMI	<ul style="list-style-type: none"> ● Is the HDMI cable connected properly? (p. 42) ● Turn Off the TV and equipment, then turn them On again. ● Check an input signal from the equipment. (p. 46) ● Use an equipment compliant with EIA/CEA-861/861B.
Other	TV goes into "Standby mode"	<ul style="list-style-type: none"> ● Off Timer function is activated. ● The TV enters "Standby mode" about 30 min. after broadcasting ends.
	The remote control does not work	<ul style="list-style-type: none"> ● Are the batteries installed correctly? (p. 6) ● Has the TV been switched On?
	An error message appears	<ul style="list-style-type: none"> ● Follow the message's instructions. ● If the problem persists, contact the authorized Service Centre.

On screen messages

Message	Meaning / Action
All tuning data will be erased	<ul style="list-style-type: none"> ● "Shipping Condition" will erase all tuning data (p. 32). ● "Auto Setup" will be erased all present DVB and Analogue tuning datas (p. 30).
Are you sure ?	<ul style="list-style-type: none"> ● Make sure the operation is with your desire.
Are you sure you want to delete this timer ? Press OK to delete timer Press Exit to return	<ul style="list-style-type: none"> ● Make sure the deleting programme event is with your desire.
Bad Signal	<ul style="list-style-type: none"> ● The signal is weak. Check the aerial.
DOWNLOAD IN PROGRESS PLEASE WAIT	<ul style="list-style-type: none"> ● Q-Link channel download is in progress.
Feature not available	<ul style="list-style-type: none"> ● Check the Q-Link connection and setting (p. 38). ● The impossible source (Component / HDMI) to be record.
Invalid DVB Channel	<ul style="list-style-type: none"> ● Invalid DVB channel is selected.
Invalid system time. Please exit !	<ul style="list-style-type: none"> ● Cannot get the time information. Check the connection of the RF cable.
Max. number of Timers already set !	<ul style="list-style-type: none"> ● Maximum timer programming event is 8.
New DVB Service Found! Press OK start Auto Setup Press EXIT to ignore. Selecting Auto Setup will delete current Profile and Childlock settings	<ul style="list-style-type: none"> ● There is a new DVB station.
New version 1.90 found. Do you really want to update the software and reboot the system ? Press OK to download the new version Press EXIT to ignore	<ul style="list-style-type: none"> ● There is a new software available.
No DVB Service found	<ul style="list-style-type: none"> ● No DVB signal can be found in Auto Setup.
No module inserted	<ul style="list-style-type: none"> ● Check the CI module inserted completely (p. 27).
No recording - Check Tape or Disc	<ul style="list-style-type: none"> ● The tape or disc may be "write protected", missing or damaged. The equipment may already be recording.
No recording - UNKNOWN REASON	<ul style="list-style-type: none"> ● The recording cannot be done by any reason. Check the equipment. ● Disc or tape may be full.
No Service	<ul style="list-style-type: none"> ● The station stops the services.
No Signal	<ul style="list-style-type: none"> ● Check the connection of the RF cable.

On screen messages

Message	Meaning / Action
No stations found Please insert the aerial	▶ ● No analogue signal can be found in Auto Setup.
PIN incorrect !	▶ ● The PIN number you entered is wrong.
Please check aerial or local DVB service availability. Press OK to start Auto Setup	▶ ● Please follow the message. If it is still failed, consult your local Panasonic dealer.
Please check settings and connections on HDMI devices.	▶ ● Communication error in VIERA Link function (p. 40).
Please wait.	▶ ● A function is in progress.
Recording in progress	▶ ● The recording equipment is recording the programme signal from its own tuner. You can turn the TV off and leave the equipment recording in the normal way.
Shipping condition completed. TV can now be switched off.	▶ ● "Auto Setup" will automatically start when Mains power On / Off switch is next turned On. (p. 10)
Software successfully updated Press EXIT to continue	▶ ● The software updating is finished.
Software Update failed. Please try again later. Press EXIT to continue	▶ ● Perform "System Update Search Now" in System Update (p. 27). If it is still failed, there may not be the new software.
This service is locked! Press OK to enter PIN	▶ ● The selected channel is locked in Child Lock (p. 29).
Timer already expired !	▶ ● Starting time in Timer Programming is already past. Set correctly (p. 37).
Timer Event Due to Start 1: BBC1 has been Programmed for recording at 20:00	▶ ● This message will appear 2 minutes before timer programming event due to start.
Timer incorrect !	▶ ● Set Starting and Ending times in Timer Programming correctly (p. 37).
Timer overlap !	▶ ● The timer programme events are overlapped. Cannot record other channel at the same time. Check the Starting and Ending times in Timer Programming (p. 37).
Tuner Locked Please stop recording to operate	▶ ● If you want to unlock, cancel Direct TV Recording (p. 38) or Timer Programming (p. 36).
Unable to download, Check Equipment	▶ ● The tape or disc is active. Stop the equipment and try again.

Specifications

	TX-26LXD69A	TX-32LXD69A		
Power Source	AC 220-240 V, 50 Hz			
Power Consumption	Average use	103 W	131 W	
	Standby condition	1,0 W (Without DVB recording) / 13 W (With DVB recording)		
Display panel	Aspect Ratio	16:9		
	Visible screen size	66 cm (diagonal)	80 cm (diagonal)	
		577 mm (W) × 325 mm (H)	699 mm (W) × 394 mm (H)	
Number of pixels	1,049,088 (1,366 (W) × 768 (H))			
Sound	Speaker	120 mm × 60 mm × 2 pcs		
	Audio Output	16 W (8 W + 8 W)		
	Headphones	M3 (3.5 mm) stereo mini Jack × 1		
Receiving Systems / Band name	PAL I :UHF E21-68 PAL 525/60 :Playback of NTSC tape from some PAL Video recorders (VCR) or NTSC disc playback from DVD player and recorder. DVB :Digital terrestrial services via UHF aerial input. M.NTSC :Playback from M.NTSC Video recorders (VCR). NTSC (AV input only) :Playback from NTSC Video recorders (VCR).			
Aerial - Rear	UHF			
Operating Conditions	Temperature : 0 °C - 35 °C Humidity : 20 % - 80 % RH (non-condensing)			
Teletext pages	1000			
Connection Terminals	AV1 (Scart terminal)	21 Pin terminal (Audio/Video in, Audio/Video out, RGB in, Q-Link)		
	AV2 (Scart terminal)	21 Pin terminal (Audio/Video in, Audio/Video out, RGB in, S-Video in, Q-Link)		
	AV3	VIDEO	RCA PIN Type × 1	1.0 V[p-p] (75 Ω)
		S-VIDEO	Mini DIN 4-pin	Y:1.0 V[p-p] (75 Ω) C:0.286 V[p-p] (75 Ω)
		AUDIO L - R	RCA PIN Type × 2	0.5 V[rms]
	COMPONENT	VIDEO	Y	1.0 V[p-p] (including synchronization)
		AUDIO L - R	PB, PR	±0.35 V[p-p]
	Others	HDMI	TYPE A Connector	● This TV supports "HDMI Control 2" function.
Output	AUDIO L - R	RCA PIN Type × 2	0.5 V[rms] (high impedance)	
Dimensions (W × H × D)	657 mm × 525 mm × 239 mm (With TV Stand) 657 mm × 473 mm × 117 mm (TV only)	791 mm × 615 mm × 239 mm (With TV Stand) 791 mm × 563 mm × 117 mm (TV only)		
Weight	14.0 kg Net	17,5 kg Net		

Note

- Design and Specifications are subject to change without notice. Weight and Dimensions shown are approximate.
- This equipment complies with the EMC standards listed below.
EN55013:2001+A1:2003, EN55020:2002+A1:2003+A2:2005, EN61000-3-2:2000+A2:2006, EN61000-3-3:1995+A1:2001, EN55022/1998+A1:2000+A2:2003, EN55024/1998+A1:2001+A2:2004.

Index

A Accessories 6	DVB Signal Condition... 32	Mode..... 22	Satellite receiver... 9, 16, 42
Add New DVB Services... 32	DVB Timer Programming... 36	Multi Audio 12	SCART 8, 45
Analogue Manual Tuning... 32	DVI..... 39	N New Service Message ... 32	Shipping Condition 33
Analogue Programme Edit... 32	DVDs 8, 16	NICAM 22	Specifications 51
Aspect..... 13, 44	E EPG 14	NTSC 24, 51	Subtitles 13, 20
Audio Description... 13, 22	External equipment ... 8, 16, 42	O Off timer..... 23	Surround..... 22
Auto Setup..... 10, 31	External input..... 16, 35	Optional accessories ... 6	S-Video 8, 45
AV1 / AV2 out..... 23, 38	F FAQs..... 47, 48	Owner ID 10, 34	System Update 27, 45
B Banner Display Timeout ... 23	H HDMI 39-41, 45	P PAL 51	T Teletext 18-20
C Category list..... 14	Hold 13, 20	PC..... 35, 46	Tuning Menu 30
Child Lock..... 29	Home Cinema..... 41, 43	PIN number ... 10, 29, 34	TV Guide 14
CI module 27	I Information banner 13	P-NR 22	TV speaker 41
Clamper..... 6	Input Labels 35	Power LED 7, 10	Type list 14
COMPONENT 42, 46	Input signal 46	Q Q-Link 23, 40	U Update the software... 27, 45
Connection 8, 42	L Licence 52	Quick Start Guide ... 6-11	V Video 8, 16
D Direct TV Recording ... 38	M Mains Lead 8	R Remote control 6, 7	VIERA Link 40, 43, 45
Download to equipment ... 10, 23	Mains power On / Off switch	Reset to Default..... 22	Viewing Mode 10, 22
D-sub 15-pin 46 7, 12	RGB..... 8	Volume Correction 22
DVB LED 7, 15, 37	Maintenance 5	S Sales and Support Information	W WSS 44
DVB Manual Tuning... 32	Menu Functions 21-25 52	Z Zoom 44
DVB Profile Edit..... 29			
DVB Settings 26			

Information on Disposal for Users of Waste Electrical & Electronic Equipment (private households)



This symbol on the products and/or accompanying documents means that used electrical and electronic products should not be mixed with general household waste.

For proper treatment, recovery and recycling, please take these products to designated collection points, where they will be accepted on a free of charge basis. Alternatively, in some countries you may be able to return your products to your local retailer upon the purchase of an equivalent new product.

Disposing of this product correctly will help to save valuable resources and prevent any potential negative effects on human health and the environment which could otherwise arise from inappropriate waste handling. Please contact your local authority for further details of your nearest designated collection point. Penalties may be applicable for incorrect disposal of this waste, in accordance with national legislation.

For business users in the European Union

If you wish to discard electrical and electronic equipment, please contact your dealer or supplier for further information.

Information on Disposal in other Countries outside the European Union

This symbol is only valid in the European Union.

If you wish to discard this product, please contact your local authorities or dealer and ask for the correct method of disposal.

Sales and Support Information

Customer Care Centre

- For customers within the UK : **0844 844 3852**
- For customers within the Republic of Ireland: **01 289 8333**
- Visit our website for product information **www.panasonic.co.uk**
- E-mail: **customer.care@panasonic.co.uk**

Direct Sales at Panasonic UK

- Order accessory and consumable items for your product with ease and confidence by phoning our Customer Care Centre Monday – Thursday 9:00am – 5:30pm, Friday 9:30am – 5:30pm (Excluding public holidays).
- Or go on line through our Internet Accessory ordering application at **www.panasonic.co.uk**.
- Most major credit and debit cards accepted.
- All enquiries transactions and distribution facilities are provided directly by Panasonic UK Ltd.
- It couldn't be simpler!
- Also available through our Internet is direct shopping for a wide range of finished products, take a browse on our website for further details.

Interested in purchasing an extended guarantee?

Please call 0870 240 6284 or visit www.panasonic.co.uk/guarantee.

Licence

Trademark Credits

- DVB is a trademark of the DVB Digital Video Broadcasting Project (1991 to 1996).
 - VGA is a trademark of International Business Machines Corporation.
 - Macintosh is a registered trademark of Apple Computer, USA.
 - S-VGA is a registered trademark of the Video Electronics Standard Association.
- Even if no special notation has been made of company or product trademarks, these trademarks have been fully respected.
- HDMI, the HDMI Logo and High-Definition Multimedia Interface are trademarks or registered trademarks of HDMI Licensing LLC.
 - HDAVI Control™ is a trademark of Matsushita Electric Industrial Co., Ltd.

Customer's Record

The model number and serial number of this product may be found on its rear panel. You should note this serial number in the space provided below and retain this book, plus your purchase receipt, as a permanent record of your purchase to aid in identification in the event of theft or loss, and for Warranty Service purposes.

Model Number _____

Serial Number _____

Panasonic (U. K.) Ltd.

Willoughby Road, Bracknell, Berks RG12 8FP

Web Site : <http://www.panasonic.net>

© 2007 Matsushita Electric Industrial Co., Ltd. All Rights Reserved.