

Information on Disposal for Users of Waste Electrical & Electronic Equipment (private households)



This symbol on the products and/or accompanying documents means that used electrical and electronic products should not be mixed with general household waste.

For proper treatment, recovery and recycling, please take these products to designated collection points, where they will be accepted on a free of charge basis. Alternatively, in some countries you may be able to return your products to your local retailer upon the purchase of an equivalent new product.

Disposing of this product correctly will help to save valuable resources and prevent any potential negative effects on human health and the environment which could otherwise arise from inappropriate waste handling. Please contact your local authority for further details of your nearest designated collection point. Penalties may be applicable for incorrect disposal of this waste, in accordance with national legislation.

For business users in the European Union

If you wish to discard electrical and electronic equipment, please contact your dealer or supplier for further information.

Information on Disposal in other Countries outside the European Union

This symbol is only valid in the European Union.

If you wish to discard this product, please contact your local authorities or dealer and ask for the correct method of disposal.

Sales and Support Information

Customer Care Centre

- For customers within the UK : **0844 844 3852**
- For customers within the Republic of Ireland: **01 289 8333**
- Visit our website for product information **www.panasonic.co.uk**
- E-mail: **customer.care@panasonic.co.uk**

Direct Sales at Panasonic UK

- Order accessory and consumable items for your product with ease and confidence by phoning our Customer Care Centre Monday – Thursday 9:00am – 5:30pm, Friday 9:30am – 5:30pm (Excluding public holidays).
- Or go on line through our Internet Accessory ordering application at **www.panasonic.co.uk**.
- Most major credit and debit cards accepted.
- All enquiries transactions and distribution facilities are provided directly by Panasonic UK Ltd.
- It couldn't be simpler!
- Also available through our Internet is direct shopping for a wide range of finished products, take a browse on our website for further details.

Interested in purchasing an extended guarantee?

Please call 0870 240 6284 or visit www.panasonic.co.uk/guarantee.

Licence

Trademark Credits

- DVB is a trademark of the DVB Digital Video Broadcasting Project (1991 to 1996).
- VGA is a trademark of International Business Machines Corporation.
- Macintosh is a registered trademark of Apple Computer, USA.
- S-VGA is a registered trademark of the Video Electronics Standard Association.
Even if no special notation has been made of company or product trademarks, these trademarks have been fully respected.
- HDMI, the HDMI Logo and High-Definition Multimedia Interface are trademarks or registered trademarks of HDMI Licensing LLC.
- HDAVI Control™ is a trademark of Matsushita Electric Industrial Co., Ltd.

Customer's Record

The model number and serial number of this product may be found on its rear panel. You should note this serial number in the space provided below and retain this book, plus your purchase receipt, as a permanent record of your purchase to aid in identification in the event of theft or loss, and for Warranty Service purposes.

Model Number _____

Serial Number _____

Panasonic (U. K.) Ltd.

Willoughby Road, Bracknell, Berks RG12 8FP Web Site : <http://www.panasonic-europe.com>

© 2007 Matsushita Electric Industrial Co., Ltd. All Rights Reserved.

Printed in Czech Republic

Panasonic®

Operating Instructions Plasma Television

Model No. **TH-37PX70B**
TH-42PX70B
TH-50PX70B

VIERA



VIERA
Link

Link

DVB®

OWNER I.D.

HD
ready

HDMI™
HIGH-DEFINITION MULTIMEDIA INTERFACE

U.K. Standard

English

Please read these instructions before operating your set and retain them for future reference.
The images shown in this manual are for illustrative purposes only.



TQB0E0364-2

Turn your living room into a home theatre!

Experience an amazing level of multi-media excitement

■ **Receive digital terrestrial broadcastings using an integrated (Digital Video Broadcasting) tuner**
(Display DVB programmes with TV Guide (p. 14) / Timer recording (p. 36) / Register and instantly call up favourite programmes with Profile Edit (p. 29))

■ **Sharp pictures with HDMI terminal**

■ **Control DVD recorder / VCR via TV with Q-Link connection** (p. 38)

■ **Create home theatre and Panasonic equipment link-ups with "VIERA Link" without complicated settings!** (p. 40)

■ **Support Audio Description signal** (p. 13 and p. 22)

Audio description (AD) is an ancillary component associated with a broadcasting which delivers a verbal description of the visual scene as an aid to understanding and enjoyment particularly, for visually-impaired viewers.



HD ready

HD ready means the ability to display high-definition pictures from HDMI and Component video inputs.



V-real 2

V-real 2 technology is the collective name for original technologies developed by Panasonic to enhance total image quality:

V-real 2 PROCESSOR: Enhance and output the incoming video signals as high-image-quality signals. The resulting video signals deliver the kind of high resolution that large screens require.

V-real 2 DRIVER: Precisely controls panel drive to optimise its performance. Achieves high image quality with the equivalent of high steps of gradation.

V-real 2 PANEL: Provide clear, vivid display of the video signal after processing by the V-real 2 Processor and Driver.

MAX.

10000:1

High Contrast

High contrast

Contrast is the difference in light intensity between the brightest white and the darkest black that the VIERA can produce. The ability to express rich, deep blacks is extremely important for displaying beautiful pictures.

3072

Gradation Steps

High gradation

Gradation refers to the smoothness of colour expression.

Rich, fine gradation is extremely important for maximising the high resolution panel.



Lead-free display

All VIERA plasma display panels are lead-free. This reduces the impact on the environment when recycling or disposing of them in the future.

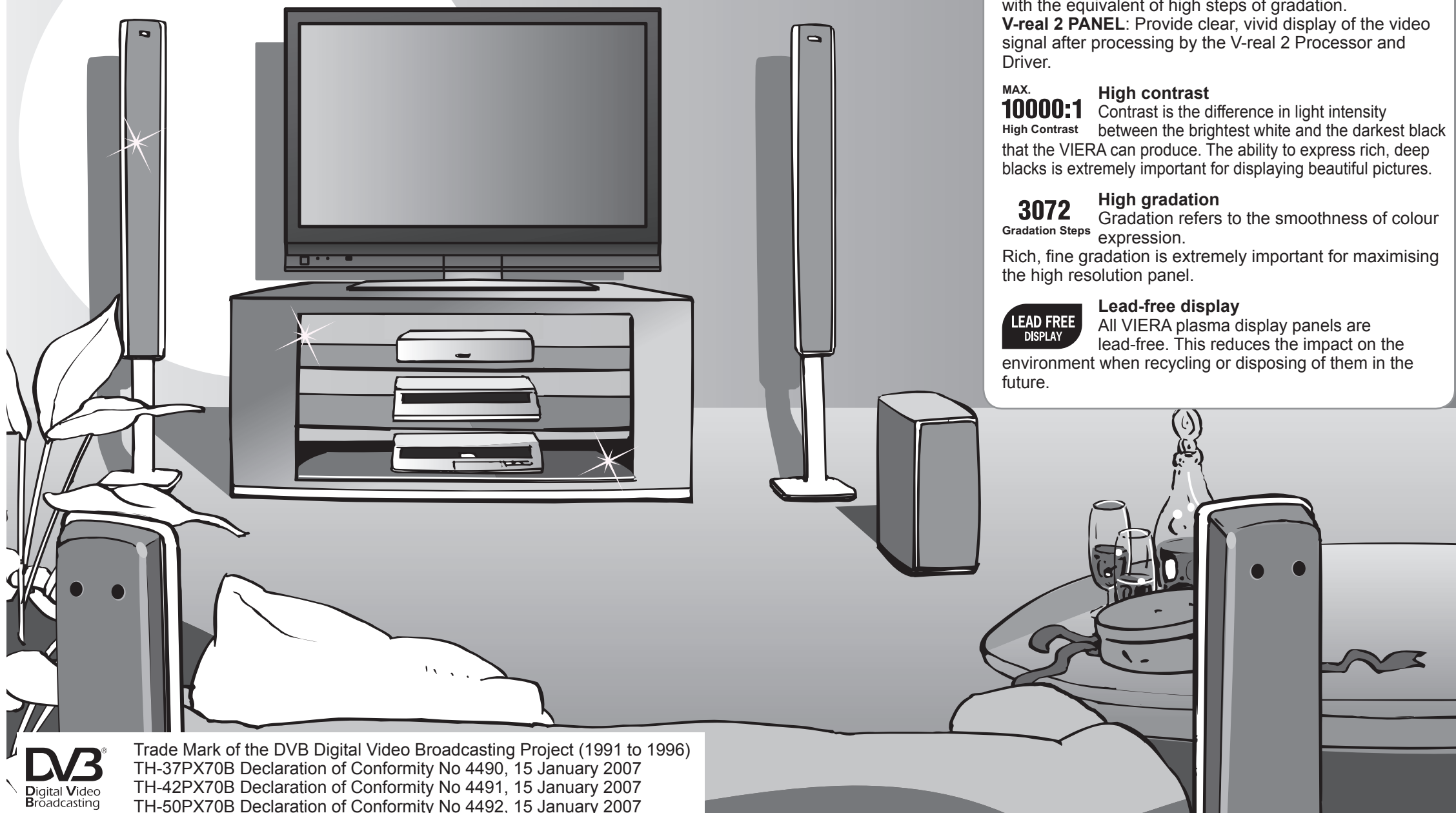

Trade Mark of the DVB Digital Video Broadcasting Project (1991 to 1996)
TH-37PX70B Declaration of Conformity No 4490, 15 January 2007
TH-42PX70B Declaration of Conformity No 4491, 15 January 2007
TH-50PX70B Declaration of Conformity No 4492, 15 January 2007

Contents

Be Sure to Read

- Safety Precautions 4
(Warning & Caution)
- Notes 5
- Maintenance 5

Quick Start Guide

- Accessories / Options 6
- Identifying Controls 7
- Basic Connection 8
- Auto Setup 10

Enjoy your TV!

Basic Features

- Watching TV 12
- Using TV Guide 14
- Watching VCR, DVD and Satellites 16
- Viewing Teletext 18

Advanced Features

- How to Use Menu Functions 21
(picture, sound quality, etc.)
- DVB Settings (DVB) 26
(pay-TV, software update)
- Editing Channels 28
- Tuning Channels 30
- Restore Settings 32
- Owner ID 33
- Input Labels 34
- Displaying PC Screen on TV 35
- Recording Controls (DVB) 36
- Q-Link Functions 38
- HDMI Functions 39
(HDMI terminal / VIERA Link)
- External Equipment 42

FAQs, etc.

- Technical Information 44
- FAQs 47
- On screen messages 49
- Specifications 51
- Index 51
- Licence 52

Quick Start Guide

Viewing

Advanced

FAQs, etc.

Safety Precautions

Warning & Caution

Handling the mains plug

- Ensure that the mains plug is easily accessible at all times. The On / Off switch on this model does not fully disconnect the TV from the mains supply. Remove the mains plug from the wall socket when the TV is not used for a prolonged period of time.
- Ensure the grounding pin on the mains plug is securely connected to prevent electrical shock.
 - An apparatus with CLASS I construction shall be connected to a mains socket outlet with a protective earthing connection.
- Do not use any mains lead other than that provided with this TV. (This may cause fire or electrical shock.)

Power source

- This TV is designed to operate on 220-240V, 50 / 60 Hz AC.

Do not remove the cover

- Do not remove the rear cover as live parts are accessible when it is removed. There are no user serviceable parts inside.

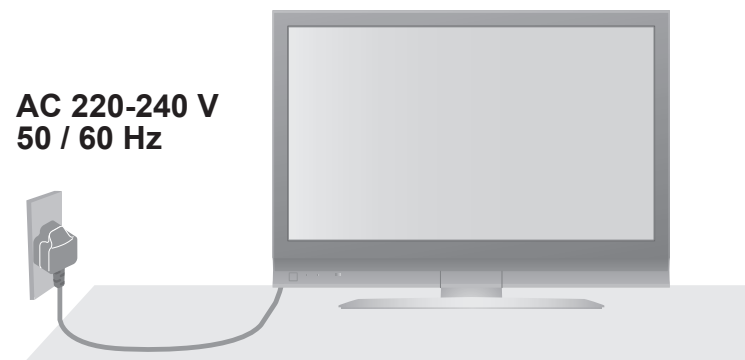

Do not expose to direct sunlight and other sources of heat

- Avoid exposing the TV to direct sunlight and other sources of heat. To prevent fire never place any type of candle or naked flame on top or near the TV.



Transport only in upright position

- Transporting the TV with its display panel facing upright or downward may cause damage to the internal circuitry.

IMPORTANT: THE MOULDED MAINS PLUG

FOR YOUR SAFETY, PLEASE READ THE FOLLOWING TEXT CAREFULLY.

This appliance is supplied with a moulded three pin mains plug for your safety and convenience. A 5 amp fuse is fitted in this mains plug. Shall the fuse need to be replaced, please ensure that the replacement fuse has a rating of 5 amps and that it is approved by ASTA or BSI to BS1362.

Check for the ASTA mark  or the BSI mark  on the body of the fuse.

If the mains plug contains a removable fuse cover, you must ensure that it is refitted when the fuse is replaced.

If you lose the fuse cover the mains plug must not be used until a replacement cover is obtained.

A replacement fuse cover may be purchased from your local Panasonic Dealer.

If the fitted moulded mains plug is unsuitable for the socket outlet in your home, then the fuse shall be removed and the mains plug cut off and disposed of safely. There is a danger of severe electrical shock if the cut off mains plug is inserted into any 13 amp socket.

If a new mains plug is to be fitted, please observe the wiring code as shown below.

If in any doubt, please consult a qualified electrician.

WARNING: – THIS APPARATUS MUST BE EARTHED.

IMPORTANT: – The wires in this mains lead are coloured in accordance with the following code: –

Green-and-Yellow: Earth Blue: Neutral Brown: Live

As the colours of the wire in the mains lead of this appliance may not correspond with the coloured markings identifying the terminals in your mains plug, proceed as follows.

The wire which is coloured GREEN-AND-YELLOW must be connected to the terminal in the mains plug which is marked with the letter E or by the Earth symbol  or coloured GREEN or GREEN-AND-YELLOW.

The wire which is coloured BLUE must be connected to the terminal in the mains plug which is marked with the letter N or coloured BLACK.

The wire which is coloured BROWN must be connected to the terminal in the mains plug which is marked with the letter L or coloured RED.

How to replace the fuse.

Open the fuse compartment with a screwdriver and replace the fuse.

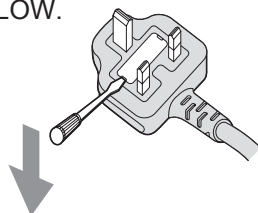

Do not expose to rain or excessive moisture

- To prevent damage which might result in electric shock or fire, do not expose this TV to rain or excessive moisture. This TV must not be exposed to dripping or splashing water and objects filled with liquid, such as vases, must not be placed on top of or above the TV.

Do not block the rear ventilation openings

- Ventilation should not be impeded by covering the ventilation openings with items such as newspapers, tablecloths and curtains.

Allow sufficient space around the TV for radiated heat

Minimum distance

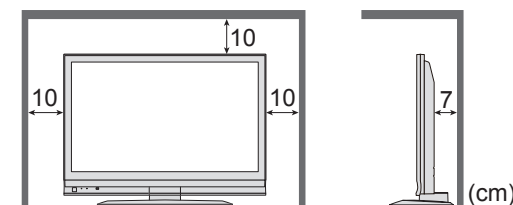

Do not place the TV on sloped or unstable surfaces

- The TV may fall off or tip over.

Use only the dedicated stands / mounting equipment

- Using an unauthorized stand or other fixtures may make the TV shaky, risking injury. Be sure to ask your local Panasonic dealer to perform setup.
- Use optional stands / mounts (p. 6).

Notes

Do not display a still picture for a long time

This causes the image to remain on the plasma screen (“image retention”). This is not considered a malfunction and is not covered by the warranty.

Typical still images

- Channel number and other logos
- Image displayed in 4:3 mode
- Video game
- Computer image



To prevent image retention, contrast is lowered automatically after a few minutes if no signals are sent or no operations are performed. (p. 47)

Auto power standby function

- If no signal is received and no operation is performed in TV mode for 30 minutes, the TV will automatically go to standby mode.

Keep the TV away from these equipment

- Electronic equipment
In particular, do not place video equipment near the TV (electromagnetic interference may distort images / sound).
- Equipment with an infrared sensor
This TV also emits infrared rays (this may affect operation of other equipment).

Maintenance

First, remove the mains plug from the socket outlet.

Display panel

Regular care: Gently wipe the surface clean of dirt by using a soft cloth. Major contamination: Wipe the surface clean using a soft cloth dampened with clean water or diluted neutral detergent by 100 times of water. Then, using a soft dry cloth, evenly wipe the surface clean until it is dry.

Caution

- The surface of the display panel has been specially treated and may be easily damaged. Do not tap or scratch the surface with your fingernail or other hard object.
- Use care not to subject the surface to insect repellent, solvent, thinner, or other volatile substances (this may degrade surface quality).

Cabinet

Regular care: Wipe the surface clean using a soft dry cloth. Major contamination: Dampen a soft cloth with clean water or water containing a small amount of neutral detergent. Then, wring the cloth and wipe the surface clean with it. Finally, wipe the surface clean with a dry cloth.

Caution

- Use care not to subject the TV's surfaces to detergent. (A liquid inside the TV could lead to product failure.)
- Use care not to subject surfaces to insect repellent, solvent, thinner, or other volatile substances (this may deteriorate the surface by peeling the paint).
- Do not allow the cabinet to make contact with a rubber or PVC substance for a long time.

Mains plug

Wipe the mains plug with a dry cloth at regular intervals. (Moisture and dust may lead to fire or electrical shock.)

Accessories / Options

Standard accessories

Check that you have the accessories and items shown

- Remote Control Transmitter
● EUR7737Z50
- Batteries for the Remote Control Transmitter (2)
● R6 (UM3)
- Clamper (2)
● TMME289
- Mains Lead
● K2CT3DH00018
- Operating Instructions
- Pan European Guarantee Card
- 1 Year Guarantee Registration
- CRM (Customer Relationship Management)

Installing remote's batteries

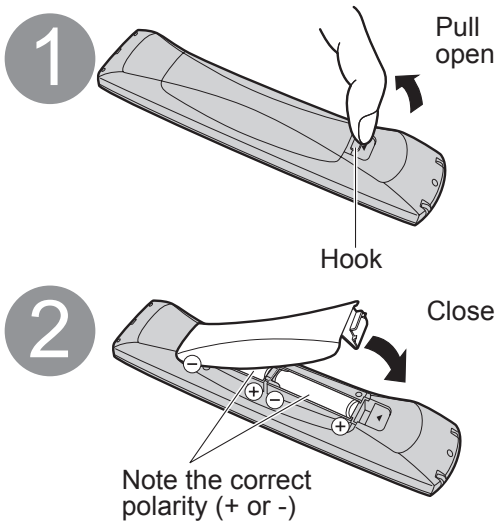

Caution

- Incorrect installation may cause battery leakage and corrosion, resulting in damage to the remote control.
- Do not mix old and new batteries.
- Do not mix different battery types (such as alkaline and manganese batteries).
- Do not use rechargeable (Ni-Cd) batteries.
- Do not burn or breakup batteries.

Using the clamper

Rear of the TV

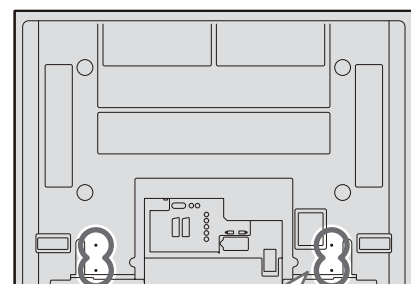

- Do not bundle the RF cable and mains lead together (could cause distorted image).
- Fix cables with clampers as necessary.
- When using the optional accessory, follow the option's assembly manual to fix cables.

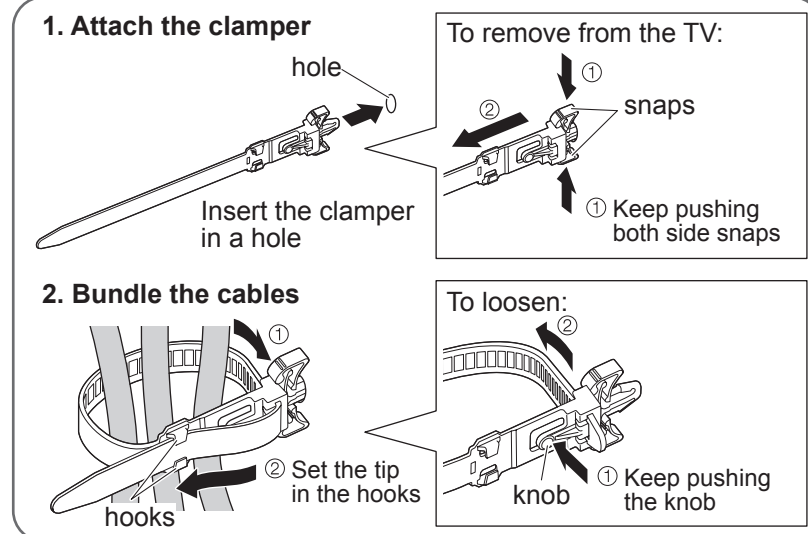

Optional accessories

Pedestal

- TY-ST42D1-WG
- TY-ST42D1-WK
- TY-ST42D2-WG
- TY-ST42D2-WK (TH-37PX70B, TH-42PX70B)
- TY-ST50D1-WG
- TY-ST50D1-WK
- TY-ST50D2-WG
- TY-ST50D2-WK (TH-50PX70B)



Plasma TV stand

- TY-S37PX70WK (TH-37PX70B)
- TY-S42PX70WK (TH-42PX70B)
- TY-S50PX70WK (TH-50PX70B)

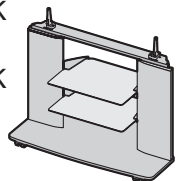

Wall-hanging bracket (vertical)

- TY-WK42PV3W

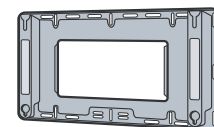

(angle)

- TY-WK42PR2W
- TY-WK42PR3W

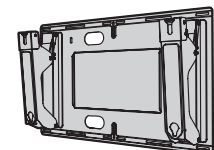

Caution

- In order to maintain the unit's performance and safety, be absolutely sure to ask your dealer or a licenced contractor to secure the wall-hanging brackets.
- Carefully read the instructions accompanying the plasma TV stand or pedestal, and be absolutely sure to take steps to prevent the TV from tipping over.
- Handle the TV carefully during installation since subjecting it to impact or other forces may cause product damage.

Identifying Controls

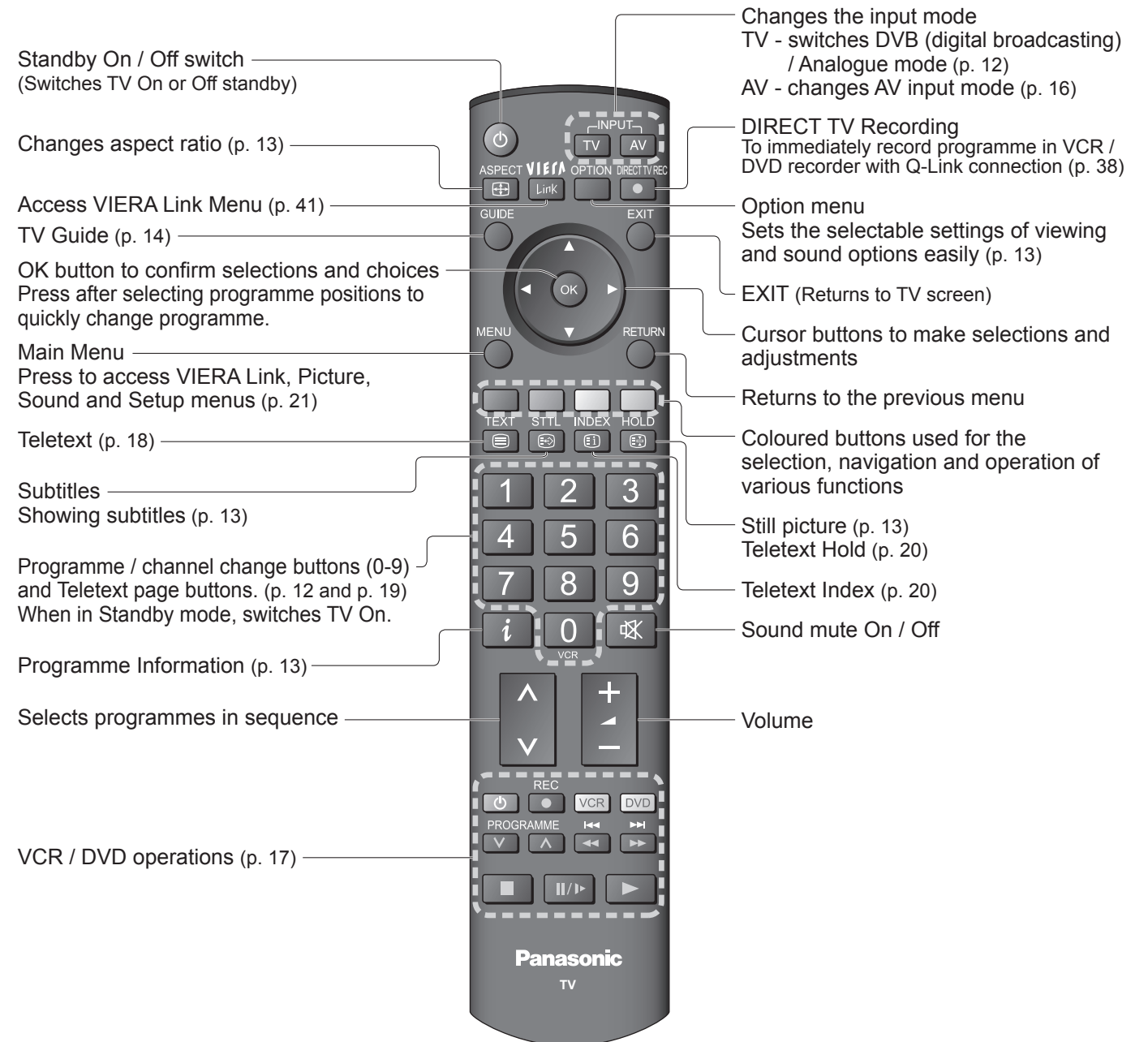
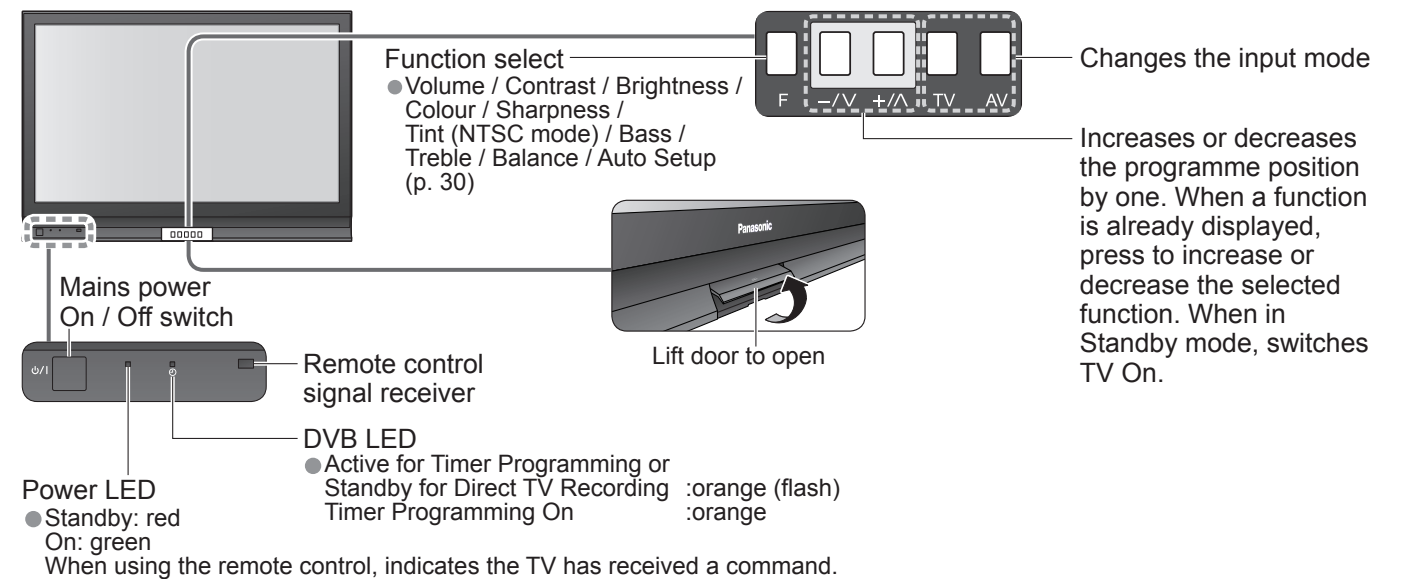

Auto Setup

Search and store TV channels automatically.
These steps are not necessary if the setup has been completed by your local dealer.

1 Plug the TV into mains socket and switch On
(Takes a few seconds to be displayed)



- You can now use the remote control to turn On the TV or turn the TV to standby mode. (Power LED: On)
- Auto Setup will start to search for TV channels and store them. The sorted programme order depends upon the TV signal, the broadcasting system and reception conditions.

2 When inputting owner ID

Following the on-screen operation guide, enter your own choice of PIN number, name, etc.

- For detailed procedures → "Owner ID" (p. 33)
- Make a note of the PIN number in case you forget it.

When inputting owner ID later

- If you input the ID later → "Owner ID" (p. 33)

3 Select the picture setting

Also possible to change the setting in Picture Menu (p. 22)

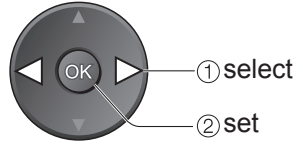

Auto Setup is now complete and your TV is ready for viewing.

- To check programme list at-a-glance → TV Guide (p. 14)
- To edit channels → Editing Channels (p. 28) / Analogue Programme Edit (p. 31)

Many features available on this TV can be accessed via the On Screen Display menu.

How to use remote control

- MENU**
 - Open the main menu
- Up/Down/Left/Right**
 - Move the cursor / select the menu
- Left/Right/Up/Down**
 - Move the cursor / adjust levels / select from a range of options
- OK**
 - Access the menu / store settings after adjustments have been made or options have been set
- RETURN**
 - Return to the previous menu
- EXIT**
 - Exit the menu system and return to the normal viewing screen

ON SCREEN HELP Instructions box
(example: Owner ID)

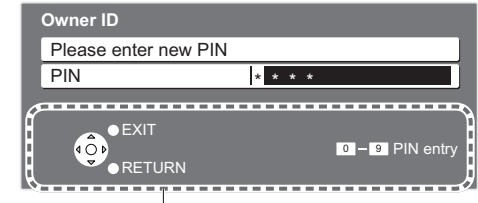

On-screen operation guide will help you.

Note

- If tuning have failed → "Auto Setup" (p. 30).
- If downloading have failed → "Download" (p. 23).
- If you turned the TV Off during Standby mode last time, the TV will be in Standby mode when you turn the TV On with Mains power On / Off switch.

Watching TV

1 Turn power on
 (Press for about 1 second)
 ● Mains power On / Off switch should be On.

2 Select DVB (Digital Video Broadcasting) or Analogue
 ● You can also select the mode using the TV button on the front panel of the TV.

3 Select a channel

Note

- To watch pay-TV (p. 27)
- To select the two or three-digit programme number, e.g. 39 → 3 → 9 (in a short time)
- To select programmes using TV Guide (p. 14)

Other useful functions (Operate after 3)

Hold	Freeze / unfreeze picture	HOLD
Display subtitles	Display / hide subtitles (if available) ● To change the language for DVB → "Preferred Subtitles" (p. 23) (If available)	STTL
Display the current programme status	Check or change the current programme status instantly ● To change → ② change ① select Subtitle Language (DVB mode) → Possible if the programme has some languages of subtitles Multi Audio (DVB mode) → Possible if the programme has some languages of sounds NICAM (Analogue mode) → Sound Menu (p. 22) Volume Correction → Adjusts volume of individual channel or input mode Audio Description (DVB mode) → This function can aid visually-impaired viewers by adding an additional audio track to describe events on-screen. Select "On" if the programme has this signal, then you will hear the description sound Note ● Also possible to change the settings in Menu list (p. 22 and p. 23).	OPTION
Display information banner	Display programme information Programme: 1 BBC ONE WALES 23:35 Profile 1 DVB: Programme: Coronation Street 20:00 - 20:55 Change category For info press i Analogue: Programme Status Start / Finish time Mute Bad Signal Encrypted AD Subtitles TXT Multi-Audio 45 Weak TV signal Audio description Teletext ● Information of another channel → ● Information on next programme (DVB) → ● To watch the programme listed in the banner → OK ● Information banner operation → i 1st press Display banner → 2nd press Banner + programme synopsis (DVB) → 3rd press Exit ● "AD", "Subtitles", "TXT", "Multi-Audio" indications are displayed as available on particular channels or services, but may not be available for all individual programmes being broadcast. Press the i button twice to confirm availability of these functions.	To change the category → blue
Change aspect ratio	Change the aspect ratio (p. 44) Enjoy viewing the picture at its optimum size and aspect. ● To change the mode → Display Aspect Selection list → During the list is displayed, select the mode → Store OK ● To change the mode using the ASPECT button only → ASPECT (Press repeatedly until you reach the desired mode)	ASPECT

Other useful functions (Operate after 3)

Off Timer

Turn the TV off automatically after a fixed period

Display the menu → **Select "Setup"** → **Select "Off Timer" and set the time**

- To cancel → Set to "Off" or turn the TV off
- To display the remaining time → Information banner (p. 13)
- When the remaining time is within 3 minutes, the remaining time will flash on screen.

Using TV Guide

TV Guide—Electronic Programme Guide (EPG) provides an on-screen listing of programmes currently broadcast and future broadcasts over the next seven days (depending on the broadcaster). Analogue broadcasts will be listed after DVB broadcasts. “D” means DVB channel and “A” means Analogue channel.

View TV Guide (landscape or portrait)
View “Portrait” to see one channel at a time
View “Landscape” to see many channels

Programme Current date and time (TV Guide start page)

TV Guide : Landscape Wed 05/08/04 18:50

Time	19:30	20:00	20:30	21:00	21:30
D 1 BBC ONE*	Eastender	DIY SOS	The Bill	Red Cap	
D 7 BBC THR	Hot Wars		Holiday Program	So	
D 14 E4	Emmerdal	Coronation Street	The Bill		
D 70 CBBC Cha	10 O'clock News BBC	Pepsi Char.	Good bye	Hello	
D 72 Cartoon	Panorama	Sex And The City	Terminator		
D 105 BBCI	I'm A Celebrity	Pop Idol	News	The	
D 719 BBC Rad	Rugby	15 To 1	The Bill		

TV Guide Portrait Wed 12/05/04 10:46

Time	19:30 - 20:00	20:00 - 21:00	21:00 - 22:00	22:00 - 23:00	23:00 - 23:30	23:30 - 00:00	23:40 - 23:55	23:55 - 00:30
D 1 BBC ONE	Eastender	DIY SOS	The Bill	Red Cap	Live junction	POP 100	Cinema info	News

Navigation Instructions:

- To change the layout (Landscape / Portrait):** Press the **GUIDE** button.
- To previous day (DVB mode):** Press the **red** button.
- To next day (DVB mode):** Press the **green** button.
- To view a programme list of the selected type (DVB mode):** Press the **yellow** button.
- To view a programme list of the selected category (DVB mode):** Press the **blue** button.
- To return to TV:** Press the **EXIT** button.
- To list favourite channels (p. 29):** Press the **blue** button, then use the directional pad to select a category (Profile 1-4) and press **OK**.

Other useful functions (Operate after viewing TV Guide)

Watch the programme

Select the channel or programme now on the air → Select “View” (DVB) → (TV screen)

View details of the programme (DVB mode)

Select the programme → View details → To return to the start page

Timer programming to record (DVB mode)

Select the programme to be broadcast (Timer Programming screen) → DVB LED will turn on if Timer Programming is set.

To check / change / cancel a timer programming event → “Timer Programming” (p. 36)

Note

- When recording programmes, you must make the proper settings on the external recording equipment connected to the TV. If a compatible recording equipment with Q-Link or similar technologies is connected to the TV (p. 8) and the “Q-Link Settings” (p. 23) are completed, no setting of the equipment is required. Also read the manual of the recording equipment.
- If you select the programme now on the air, the confirmation screen whether watching or recording will appear. Select “Timer Programming” to record from the time you finish the Timer Programming setting.

Note

- When this TV is turned on for the first time, or the TV is switched off for more than a week, it may take some time before the TV Guide is completely shown.

Watching VCR, DVD and Satellites

Connect the external equipment (VCRs, DVD equipment, etc.) and you can watch the input.
 Connect the Satellite receiver and you can watch satellite broadcasts.
 To connect the equipment (p. 8 and p. 9)
 The Remote Control is capable of operating some functions of selected Panasonic external equipment.



- Turn the TV on**
 - **When connecting with SCART as example 2 or 3** (p. 8 and p. 9)
 - ➔ Receives input signals automatically when playback starts or satellite receiver is switched on
 - Input signals are automatically identified by the SCART (pin 8) terminal.
 - This function is also available for HDMI connections (p. 41).
 - **If input mode is not switched automatically**
 - ➔ Perform ② and ③
 - Dependant on the setup of the equipment

- Display the Input select menu**



- Select the input mode connected to the equipment**

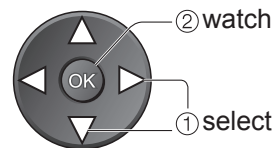
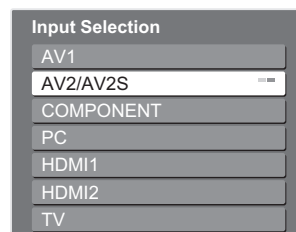

- You can also select the input using the AV button on the remote control or the front panel of the TV. Press the button repeatedly until the desired input is selected.
- You can label or skip each input modes ➔ "Input Labels" (p. 34)

- View**

Displays the selected mode

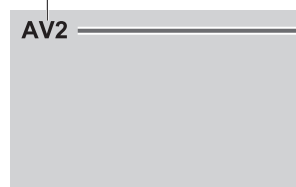

■ **To return to TV**



Note

- If the external equipment has an aspect adjustment function, set to "16:9".
- For details, see the manual of the equipment or ask your local dealer.

Screen display

Terminal	AV1	AV2	Component	PC	HDMI1	HDMI2
Manual input (default setting in "Input Labels")	AV1 AV1-RGB	AV2 AV2-S-Video AV2-RGB	Component	PC	HDMI1	HDMI2
Auto input (EC mode or VIERA Link)	EC/AV1 EC/AV1-RGB	EC/AV2 EC/AV2-S-Video EC/AV2-RGB	—	—	EC/HDMI1 ● Applicable for EC mode and VIERA Link	EC/HDMI2 ● Applicable for VIERA Link

Panasonic equipment connected to the TV can be directly operated with the remote control.

	VCR / DVD selection buttons* Select VCR to operate Panasonic VCR or DVD equipment Select DVD to operate Panasonic DVD equipment or Player home theatre
	Standby Set to Standby mode / Turn on
	Play Playback videocassette / DVD
	Stop Stop the operations
	Rewind / Skip / Search VCR: Rewind, view the picture rapidly in reverse DVD: Skip to the previous track or title Press and hold to search backward
	Fast-forward / Skip / Search VCR: Fast-forward, view the picture rapidly forward DVD: Skip to the next track or title Press and hold to search forward
	Pause Pause / Restart DVD: Press and hold to play at slow speed
	Programme Up / Down Select programme
	Record Start recording

*Setting your remote control to operate Panasonic VCR, DVD, etc.

① Select the VCR or DVD button you want to set ➔

② Press and hold during the following operations

Enter the appropriate code for the equipment to be controlled, see table below ➔ Press

"VCR" button

Equipment	Code
VCR	10 (default)
DVD	11

"DVD" button

Equipment	Code
DVD	70 (default)
Player home theatre	71

Note

- Confirm correct operation after the code changed.
- The codes will be reset to default values if batteries are replaced.
- "DVD" means DVD player, DVD recorders and Recorder home theatre.
- Some operations may not be possible on some equipment models.

Viewing Teletext

You can enjoy news, weather forecasts and subtitles, etc. (depending on the broadcaster)

DVB (digital broadcasting) mode

DVB teletext services

DVB teletext services differ greatly from analogue teletext. When you switch to a DVB teletext service, the images you see can contain graphics and text, laid out and controlled in a manner decided by the broadcaster.

- You can check if the programme has teletext information.

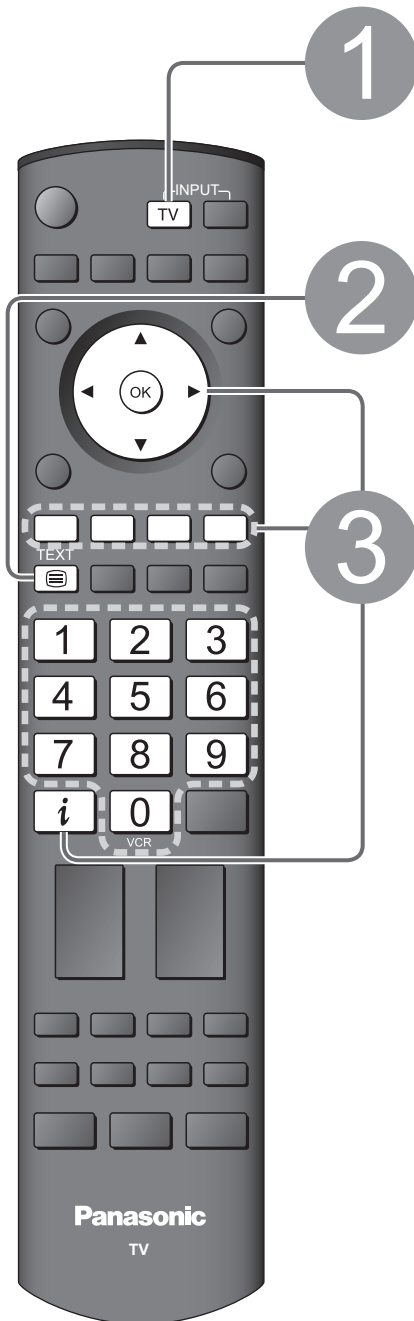
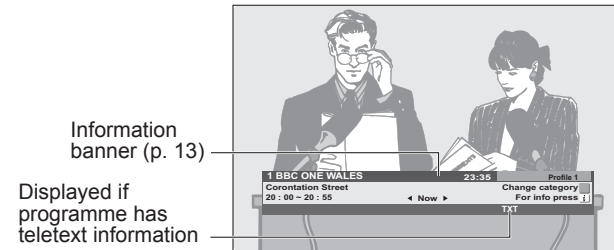

1 If in Analogue mode
Select DVB

2 **Switch to Teletext**

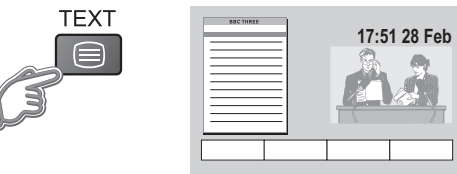

How to use

In all cases, it is possible to navigate the pages using buttons on the remote control, but because the commands available must apply to all manufacturers of DVB equipment, some on screen commands may not correspond exactly to the remote control buttons. For example:

- When "select" or "go" is displayed →
 - When "◀", "▶", "▲", "▼" symbol is displayed →
 - When the key words are displayed on colour bar →
 - When options with numbers are displayed →
 - When "i" is displayed → (information)
- **To return to TV** →

Note

- As soon as you switch to a DVB channel with links to a teletext service, software is downloaded in the background to enable the teletext function. This means that when switching to a DVB channel, you should wait for approximately 5 seconds before pressing the TEXT button - this will allow the software to download. If you press the TEXT button before download is complete, there will be a short delay before the text screen is displayed.
- While navigating DVB teletext, you will find there is a short delay when moving between pages while the page downloads. There is often a prompt shown somewhere on the page (for example "Loading") to let you know that this is happening.

■ **To change the channel**

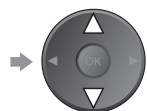

Analogue mode

What is FASTEXT mode (default)?

In FASTEXT mode, four differently coloured subjects are situated at the bottom of the screen. To access more information about one of these subjects, press the appropriately coloured button. This facility enables fast access to information on the subjects shown.

What is List mode?

In List mode, four differently coloured page numbers are situated at the bottom of the screen. Each of these numbers can be altered and stored in the TV's memory. ("Store frequently viewed pages", p. 20)

■ **To change mode** → "Teletext" in Setup Menu (p. 23)

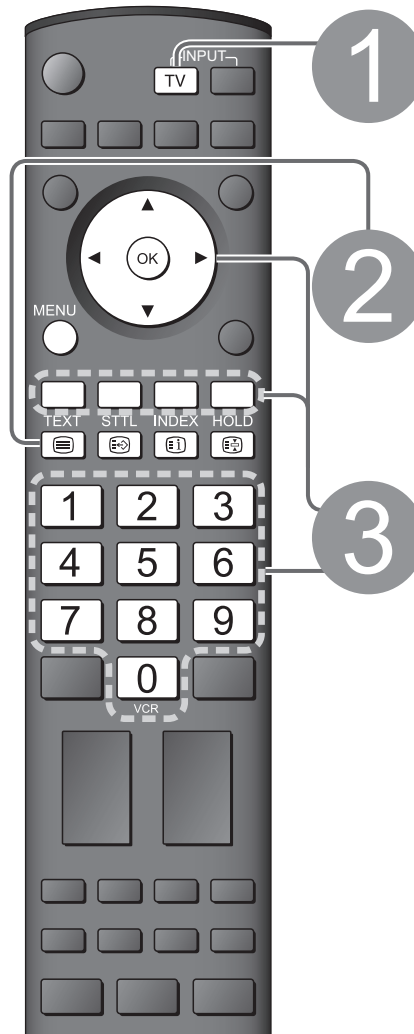

1 If in DVB mode
Select Analogue

2 **Switch to Teletext**

- Displays the index page (content varies depending on the broadcasters)

3 **Select the page**

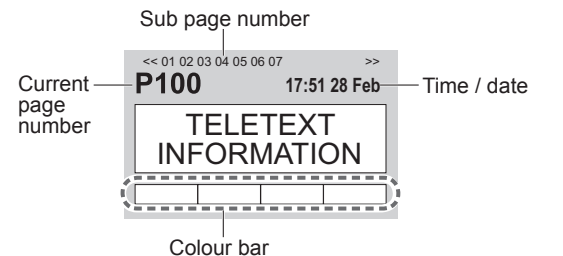
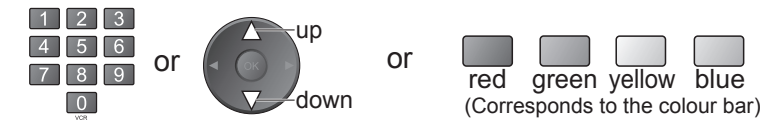

As the blue bar is displayed

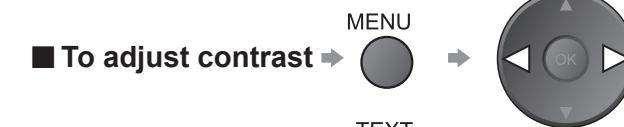

■ **To adjust contrast** → →

■ **To return to TV** → (Press twice)

- Press once to have picture and text. Press again to return to TV.

■ Using Analogue teletext

Reveal hidden data	Reveal hidden words e.g. quiz page answers MENU → ● Re-hide →
FULL / TOP / BOTTOM	MENU →

(Continued)

Viewing Teletext

Using Analogue teletext (Continued)

HOLD	If you wish to hold the current page without updating Stop automatic updating HOLD ■ To resume → HOLD
INDEX	Return to the main index page INDEX
Subtitles	View subtitles by pressing STTL button STTL ● Factory setting is "P888" (subtitle service) on blue button (List mode).
View in multi window	Watch TV and Teletext in two windows at once TEXT ● Operations can be made only in Teletext screen. ● Each time pressed: Teletext → TV and Teletext TV ←
Store frequently viewed pages	Store frequently viewed pages in the colour bar (List mode only) As page is displayed Corresponding colour button → OK press and hold P100 Broadcast 101 200 400 888 ● If you wish to use Subtitles, do not change number on blue button. To change stored pages Enter new page number Colour button you want to change → → OK press and hold The number changes to white.
View sub page	View sub page (Only when teletext is more than one page) <<01 02 03 04 05— Appears at top of the screen To view specific sub page MENU → → → Enter the 4-digit number example: P6 → → T0006 ● Sub pages: The number of sub pages varies depending on the broadcasters (up to 79 pages). It may take some time for searching, during which time you can watch TV.
Watch TV while waiting for update	View the TV picture while searching for a teletext page Teletext automatically updates itself when new information becomes available. Changes to TV screen temporarily MENU → → P108 Appears when updating is completed → → View the updated page (You cannot change the channel.) ● The news page provides a function that indicates arrival of latest news ("News Flash").

How to Use Menu Functions

Various menus allow you to make settings for the picture, sound, and other functions.

- 1 Display the menu**
MENU ● Displays the functions that can be set (varies according to the input signal)
- 2 Select the menu**
 VIERA Main Menu
VIERA Link
Picture
Sound
Setup
(example: Picture Menu)
● access
● select
- 3 Select the item**
 Picture Menu 1/2
Viewing Mode Dynamic
Contrast
Brightness
Colour
Sharpness
Tint
Colour Balance Warm
Colour Management Off
P-NR Off
(example: Picture Menu)
● select
- 4 Adjust or select**
 Picture Menu 1/2
Viewing Mode Dynamic
Contrast
Brightness
Colour
Sharpness
Tint
Colour Balance Warm
Colour Management Off
P-NR Off
(example: Picture Menu)
● change
● store or access (Required by some functions)

Choose from among alternatives
Number and positions of alternatives
Colour Balance Normal
Changed

Adjust using the slide bar
Sharpness
Moved

Go to the next screen
Tuning Menu Access
Displays the next screen

To change menu pages
up
down

Note
● To initialize all settings → "Shipping Condition" (p. 32)

How to Use Menu Functions

■ Menu list

Menu	Item	Adjustments / Configurations (alternatives)	
VIERA Link	VIERA Link Control	Controls the connected Panasonic equipment "Access and control the connected equipment by VIERA remote control" (p. 41) "Speaker control" (p. 41)	
	Speaker Selection	● You can also access VIERA Link Menu directly using the VIERA Link button on the remote control.	
Picture	Viewing Mode	Selects three different screen settings (Dynamic / Normal / Cinema) In each Viewing Mode setting, Contrast, Brightness, Colour, Sharpness, Tint (in NTSC only), Colour balance, Colour Management and 3D-COMB can be adjusted and stored to suit your particular viewing requirement (e.g., you may require different settings for viewing sports, films, news etc.) Set for each input signal Changes will be stored automatically. By analysing and processing the incoming picture, all three modes feature automatic enhancement	
	Contrast, Brightness, Colour, Sharpness	Increases or decreases the levels of these options according to your personal preference	
	Tint	With an NTSC signal source connected to the TV, the picture hue can be adjusted to suit your taste	
	Colour Balance	Allows you to set the overall colour tone of the picture (Cool / Normal / Warm)	
	Colour Management	Automatically adjusts colours to vivid ones (Off / On) ● Not valid on PC signal	
	P-NR	Picture Noise Reduction Automatically reduces unwanted picture noise (Off / Min / Mid / Max) ● Not valid on PC signal	
	3D-COMB	Occasionally, whilst viewing still or slow moving pictures, colour patterning may be seen Set to "On" to display sharper and more accurate colours (Off / On) ● For PAL or NTSC signal reception only ● Not valid on RGB, S-Video, components, PC and HDMI ● Analogue mode only	
	Reset to Default	Press the OK button to reset the present Picture Mode to the default settings ● P-NR is reset to Off (Analogue) or Min (DVB)	
Sound	Mode	Select two different sound settings (Music / Speech) In each Sound Mode setting, Bass and Treble can be adjusted and stored to suit your particular sound requirement Changes to any settings in a mode will affect all signal sources Sound quality can be improved	
	Bass	Increases or decreases level to enhance or minimise lower, deeper sound output	
	Treble	Increases or decreases level to enhance or minimise sharper, higher sound output	
	Balance	Adjusts volume level of right and left speakers	
	Surround	Surround sound settings (Off / On) Provides a dynamic enhancer to simulate improved spatial effects	
	Volume Correction	Adjusts volume of individual channel or input mode	
	Preferred Multi Audio	Selects the preferred language for DVB multi audio (depending on the broadcaster)	
	NICAM	NICAM (Near Instantaneous Companded Audio Multiplex) A format for digital sound over television Reproduces stereo sound (Off / On) ● Off if reception is poor (FM monaural sound) ● Analogue mode only	
	HDMI1 Input	Select to fit the input signal (Auto / Digital / Analogue) (p. 39) Auto : Automatic detection of digital or analogue sound source Digital : HDMI cable connection Analogue : HDMI-DVI adapter cable connection ● HDMI input mode only ● HDMI2 terminal is for digital signal only ● No setting for HDMI2 available	
	Audio Description Menu	Audio Description	Useful for visually-impaired viewers (Off / On) Select "On" to sound the description sound if the programme has the signal
		Volume	Adjusts the volume for audio description
	Reset to Default	Press the OK button to reset the present Sound Mode to the default settings ● Effective to Bass, Treble and Balance	

■ Menu list

Menu	Item	Adjustments / Configurations (alternatives)	
Setup	DVB Timer Programming	Records future programmes (p. 36)	
	DVB Profile Edit	Creates list of favourite programmes (p. 29)	
	DVB Service List	Skips the unwanted DVB channels (p. 29)	
	Q-Link Settings	Q-Link	Selects which AV terminal is to be used for data communication between this TV and a compatible recording equipment (AV1 / AV2) (p. 38) ● Select the connected terminal to the recording equipment even it is not compatible with Q-Link.
		AV1 / AV2 out	Chooses the signal to be transmitted from the TV to Q-Link (Analogue / DVB / AV1 / AV2 / Monitor) ● Monitor: Image displayed on screen ● Component, PC and HDMI signals cannot be outputted
		Download	Downloads analogue channel information to a Q-Link compatible equipment connected to the TV
	Child Lock	Locks a programme channel to prevent access to it (p. 29)	
	Tuning Menu	Auto Setup	Automatically sets the channels received in the area (p. 30)
		Analogue Programme Edit	Edits analogue channels (p. 31)
		DVB Manual Tuning	Sets the DVB channels manually (p. 31)
		Analogue Manual Tuning	Sets the analogue channels manually (p. 31)
Add New DVB Services		Adds new DVB services (p. 31)	
New Service Message		Selects whether to give a notification message when a new DVB service is found (p. 31)	
DVB Signal Condition		Checks the DVB signal condition (p. 31)	
Off Timer	Sets the time the TV automatically turns Off (Off / 15 / 30 / 45 / 60 / 75 / 90 minutes)		
Power on Preference	Set to "TV" to view picture from TV tuner. Set to "AV" to view input from an external equipment connected to a SCART terminal, e.g. satellite receiver (TV / AV) ● The external equipment must be switched on and sending a control signal for automatic switching at power on to occur		
Teletext	Analogue teletext display mode (FASTEXT / List) (p. 19)		
Preferred Subtitles	Selects the preferred language for DVB subtitles (depending on the broadcaster) ● To display subtitles ➔ p. 13		
Shipping Condition	Resets all settings, for example, when moving house (p. 32)		
Owner ID	Inputs the owner ID (p. 33)		
Common Interface	Uses to watch pay-TV (p. 27)		
System Update	Downloads new software to TV (p. 27)		
Power Save	Reduces brightness of picture to economise on power consumption (Off / On)		
Side Panel	Increases the brightness of the side panel (Off / Low / Mid / High) ● The recommended setting is "High" to prevent panel "image retention"		
Input Labels	Labels or skips each input terminals (p. 34)		
Banner Display Timeout	Sets how long the information banner (p. 13) stays on screen ● 0 (No display) to 10 sec. in 1-sec. increments		
VIERA Link	Sets to use VIERA Link functions (Off / On) (p. 40)		
Software Licence	Displays the software licence information		
System Information	Displays the system information of this TV		

- A different menu will be displayed while PC is used. (p. 35)
- Only available items can be selected.

Editing Channels

You can make your favourite channel lists, skip unwanted channels and control channel audience.

1 Select DVB or Analogue
 ● “DVB Profile Edit” and “DVB Service List” are available in DVB mode only.

2 Display the menu

3 Select “Setup”

4 Select “DVB Profile Edit”, “DVB Service List” or “Child Lock”

5 Set

■ To return to TV
 EXIT

Create your favourite channel list (Profile) from various broadcasters (up to 4: Profile 1 to 4). The list is added to “Category” in TV Guide (p. 14) and information banner (p. 13) and then easily accessed.

① Select a channel and add it to the list

A channel is added

List favourite channels

DVB Profile Edit (DVB mode)

To change the category → red
 To display another Profile → blue
 To add all channels to the list → yellow

■ To edit Profile

Select the field of Profile to edit and:

- To name the Profile → red → Select the character → OK → RETURN
- To move the channel → green → Select the new position → Confirm → OK
- To delete the channel → yellow
- To delete all channels → blue

② Store

- Channel numbers (known as logical channel numbers) cannot be changed, due to broadcast restrictions.

Skip unwanted channels

DVB Service List (DVB mode)

Select a service and add / delete

Child Lock

You can lock specific channels and control who watches them. (When a channel is selected, a message appears; by entering the PIN number, you can watch the channel.)

① Enter the PIN number (4 digits)

Child Lock-PIN Entry
 Please enter new PIN
 PIN

- Enter the PIN number twice at first setting.
- Make a note of the PIN number in case you forget it.

② Select “Service List”

Child Lock
 Change PIN
 Service List

③ Select the channel to be locked

Child Lock Service List

Service Name	Type	Lock
1 BBC One Wales	DVB	🔒
7 BBC THREE	DVB	🔒
14 E4	DVB	🔒
70 CBBC Channel	DVB	🔒
72 Cartoon Nwk	DVB	🔒
105 BBCI	DVB	🔒
719 BBC Radio Wales	DVB	🔒
720 BBC Radio Cymru	DVB	🔒

Appears when the channel is locked

- To cancel → Select the locked channel → OK
- To lock all channels → yellow
- To cancel all channel locks → blue

■ To change the PIN number
 Select “Change PIN” in ② and enter a new PIN number twice.

Note

- Setting “Shipping Condition” (p. 32) erases the PIN number and all settings.

Tuning Channels

You can re-tune all TV channels when moving house or search for new services which may have recently started broadcasting.

- Select DVB or Analogue**
 - "DVB Manual Tuning", "Add New DVB Services", "New Service Message" and "DVB Signal Condition" are available in DVB mode only.
 - "Analogue Programme Edit" and "Analogue Manual Tuning" are available in Analogue mode only.
- Display the menu**
- Select "Setup"**
 - VIERT Main Menu
 - VIERA Link
 - Picture
 - Sound
 - Setup
- Select "Tuning Menu"**
 - Setup Menu 1/3
 - DVB Timer Programming
 - DVB Profile Edit
 - DVB Service List
 - Q-Link Settings
 - Child Lock
 - Tuning Menu Access
 - Off Timer Off
 - Power on Preference TV
 - Teletext FASTEXT
- Select a function and set**
 - Tuning Menu
 - Auto Setup Access
 - Analogue Programme Edit Access
 - DVB Manual Tuning Access
 - Analogue Manual Tuning Access
 - Add New DVB Services Access
 - New Service Message On
 - DVB Signal Condition Access

■ **To return to TV**
EXIT

Automatically set the DVB and Analogue channels received in the area. If a Child Lock PIN number (p. 29) has been set, it must be entered.

Start Auto Setup

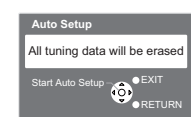

Settings are made automatically

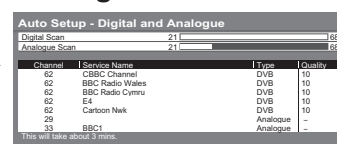

- All previous settings are erased.
- The analogue settings are downloaded to a Q-Link compatible equipment connected to the TV.

- When the operation is completed, the digital broadcast of programme number "1" will appear. If no DVB services are found, the analogue broadcast will appear.
- If tuning has not done completely → "DVB Manual Tuning", "Analogue Manual Tuning"

For Auto Setup, using the buttons on the front of the TV

- Press repeatedly until "Auto Setup" appears
- Access "Auto Setup"
- Start "Auto Setup"

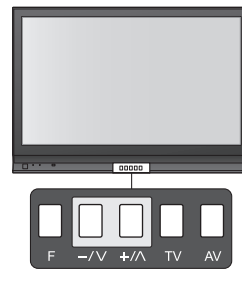

■ **To return to TV** → F

Set DVB and Analogue channels automatically

Auto Setup

Edit Analogue channels

Analogue Programme Edit

- Delete
- Add
- Move
- Change name

Edit the analogue programme position settings

1 Select the channel to edit

Prog.	Chan.	Name
1	CH33	1 2 3
2	CH21	X Y Z
3	CH21	F T P
4	CH60	
5	CH21	4 5 6

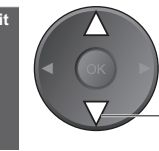

Cursor

select

Name

Channel



2 Edit

- **To delete** → red
→ After confirming, press red
- **To add** → green
→ After confirming, press green
- **To move** → yellow
→ Select new position → yellow

To change the name of the broadcaster displayed when selecting channels

Prog.	Chan.	Name
1	CH33	1 2 3
2	CH21	X Y Z
3	CH21	F T P
4	CH60	
5	CH21	4 5 6

- Select the "Name" field
- Enter the "User Input" mode
- Select the character
- Set (Maximum: five characters)
- Store

Set DVB channel manually

DVB Manual Tuning

Normally use "Auto Setup" or "Add New DVB Services" for the DVB channel setting. If tuning has not done completely, use this function.

Frequency	Channel	Service Name	Net ID	TS ID	Quality
0	CH21				10
0					10
0					10

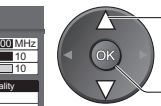

1 select channel

2 search

- All services found will be added to the DVB Service List (p. 29) automatically.

Set Analogue channel manually

Analogue Manual Tuning

Set Analogue channel manually after Auto Setup. If a VCR is connected with only the RF cable, select programme position "0".

Programme	Channel	Service Name	Net ID	TS ID	Quality
1	CH33				68
Manual Tuning	21				

Select the programme position

Select the channel

Search and store

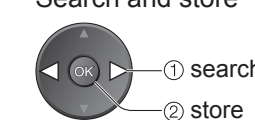

- 1 search
- 2 store

Add DVB channel automatically

Add New DVB Services

Any new services found will be added to the DVB Service List (p. 29) automatically.

Prog.	Channel	Service Name	Net ID	TS ID	Quality

OK start

- The new service is added with the current settings saved as they are.

Display a notification message

New Service Message

Selects whether to give a notification message when a new DVB service is found. (Off / On)

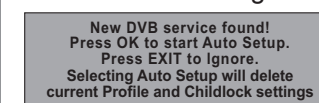

- Selecting OK (Auto Setup) will delete current Profile and Childlock settings.

Check DVB signal

DVB Signal Condition

Selects a channel and checks the DVB signal condition. Use for adjusting the direction of the aerial.

- To change the programme during the menu appears →

DVB Programme	Signal Quality	Signal Strength
[70] CBBC Channel		

- Signal Quality:**
- Green bar → Good
- Yellow bar → Poor
- Red bar → Bad (Check the aerial)

Restore Settings

Resets the TV to its original condition, i.e. no channels tuned in.
All settings other than "Owner ID" (channels, picture, sound quality, etc.) are reset.

- 1 Display the menu**
MENU
- 2 Select "Setup"**
VIERA Main Menu
VIERA Link
Picture
Sound
Setup
② access
① select
- 3 Select "Shipping Condition"**
Setup Menu 2/3
Preferred Subtitles English
Shipping Condition Access
Owner ID
Common Interface
System Update
Power Save Off
Side Panel Off
Input Labels
Banner Display Timeout 3 seconds
② access
① select
- 4 Set**
EXIT
To return to TV

Restore Settings

Shipping Condition

① Check the message and initialise

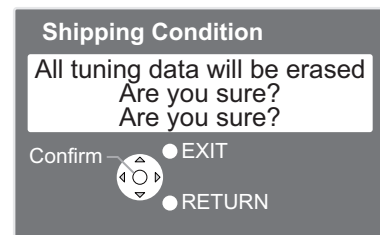

OK set

② Follow the on-screen instructions

- "Auto Setup" will automatically start when Mains power On / Off switch is next turned On. (p. 10)

■ To re-tune TV channels only, e.g. after moving house

- ➔ "Auto Setup" (p. 30)

Owner ID

Entry of the security code (PIN number) and "personal information" (your name, address and post code).
In the unfortunate event of theft it will help the Police to determine the owner.
If you have skipped the Owner ID input in "Auto Setup" (p. 10), and input it later, start from ①.
If you input the Owner ID in "Auto Setup" (p. 10), perform ④.

- 1 Display the menu**
MENU
- 2 Select "Setup"**
VIERA Main Menu
VIERA Link
Picture
Sound
Setup
② access
① select
- 3 Select "Owner ID"**
Setup Menu 2/3
Preferred Subtitles English
Shipping Condition
Owner ID Access
Common Interface
System Update
Power Save Off
Side Panel Off
Input Labels
Banner Display Timeout 3 seconds
② access
① select
- 4 Set**
EXIT
To return to TV

① Enter the PIN number (4 digits)

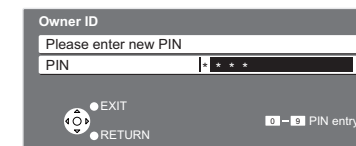

- Enter the PIN number twice at first setting.
- Make a note of the PIN number in case you forget it.

② Enter your name, address, and post code, in that order

- Select the entry field
- Enter the "User Input" mode
- Select the character
- Set
- Store

To check the "personal information" stored

Hold down for about 3 sec.

Displays the information on the screen (for several sec.)

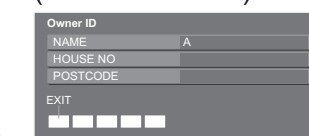

- The PIN number is not displayed.

■ To change the PIN number

- Select the "PIN" field
- Enter a new PIN number twice

Input Labels

For easier identification and selection of the input mode, you can label each input terminals or skip terminal that is not connected to any equipment.
(To select the input mode → p. 16)

1 Display the menu
MENU

2 Select "Setup"
Main Menu
VIERA Link
Picture
Sound
Setup

3 Select "Input Labels"
Setup Menu 2/3
Preferred Subtitles English
Shipping Condition
Owner ID
Common Interface
System Update
Power Save Off
Side Panel Off
Input Labels Access
Banner Display Timeout 3 seconds

4 Select a input terminal and set
Input Labels
AV1 DVD
AV2/AV2S AV2/AV2S
COMPONENT COMPONENT
PC PC
HDMI1 HDMI1
HDMI2 HDMI2

■ To return to TV
EXIT

The labels you set will be displayed in "Input Selection" menu (p. 16) or banner.
● If "Skip" is selected, you cannot select the mode.

User Input

You can name each input terminals freely.

Select "User input" → Set characters → Store RETURN

User Input Name

(maximum: ten characters)

Displaying PC Screen on TV

The screen of the PC connected to the TV can be displayed on the TV.
You can also listen to PC sound with the audio cable connected. To connect PC (p. 42)

1 Select the external input
AV

2 Select "PC"
Input Selection
AV1
AV2/AV2S
COMPONENT
PC
HDMI1
HDMI2
TV

● Corresponding signals (p. 46)
● If "H-freq." or "V-freq." is shown in red, the signals may not be supported.

■ To return to TV



PC menu setting (changed as desired)

● To make settings → "How to Use Menu Functions" ① to ④ (p. 21)

Menu	Item	Adjustments / Configurations (options)
Picture	Advanced PC Settings	W/B High R White balance of bright red area
		W/B High B White balance of bright blue area
		W/B Low R White balance of dark red area
		W/B Low B White balance of dark blue area
		Gamma (2.0 / 2.2 / 2.5 / S Curve)
Setup	Input Resolution	Switches to a wide view ● VGA (640 × 480 pixels), WVGA (852 × 480 pixels), XGA (1,024 × 768 pixels), WXGA (1,366 × 768 pixels) ● Options change depending on signals
	Clock	Set to the minimum level if noise occurs
	H-pos	Adjusts horizontal position
	V-pos	Adjusts vertical position
	Clock Phase	Eliminates flicker and distortion ● Adjust after Clock adjustment ● Set to the minimum level if noise occurs
	Sync	Chooses another synchronous signal if the image is distorted (H & V / On G) ● H & V : by the horizontal and vertical signals from your PC On G : by the green signal from your PC (if available)

● Other items → p. 22 and p. 23

Recording Controls (DVB mode)

Timer Programming from Menu

The Timer programming menu allows you to choose programmes that you wish to record. At the correct time, the DVB system will switch on and tune to the correct station (even if the TV is in Standby mode). TV Guide may also be used to set timer programmes. (p. 14)

- If the recording equipment is compatible with Q-Link or similar technologies (p. 38), and setup / connection are done completely (p. 38 and p. 42), you do not need to programme the equipment – the DVB system will control the recording progress.
- If the recording equipment is not compatible with Q-Link or similar technologies, set “Q-Link” in Setup Menu (p. 23) to the connected terminal (AV1 or AV2), and make timer programming of the recording equipment (Read the manuals of the equipment).

- 1 Select DVB**
If in Analogue mode
- 2 Display the menu**
- 3 Select “Setup”**
- 4 Select “DVB Timer Programming”**
- 5 Set**
- 6 Store**

■ To return to TV
 EXIT → OK

■ To stop recording
 GUIDE → EXIT → OK

Caution

- The TV must either be On or in standby.
- For preparations of a recording equipment, read the manual of equipment.
- No other DVB channel can be selected during recording. However you can watch analogue channels.
- It may not be possible to record an encrypted programme (which is copy-protected).

Set timer programming details

- 1 Start making the settings**
OK → start
- 2 Repeat the operations as below, and set items in the order of 1 to 5**
select the item → set

● 1, 3 and 4 can also be entered with numeric buttons.

Pos.	Name	Date	Start	End	min.	
1	BBC1	6/8 FR	18:00	20:00	120	Off
3	ITV1	7/8 SA	21:30	22:30	60	Off

1 Channel
2 Date
3 Starting time
4 Ending time
5 Subtitles (Off / Auto)

● Recording time (automatic display)

● one day ahead
 ● daily or weekly (press repeatedly)

● Daily SU-SA: Sunday to Saturday
 ● Daily MO-SA: Monday to Saturday
 ● Daily MO-FR: Monday to Friday
 ● Weekly SA/FR/TH/WE/TU/MO/SU: Same time on the same day every week

■ To change a timer programming event
 → Select the programme to be changed using [directional] and press OK
 → Correct as necessary (as above)

■ To cancel a timer programming event
 → Select the programme to be deleted using [directional] and press red → OK

Direct TV recording:

You can record the current programme to DVD Recorder or VCR immediately. (p. 38)

Note

- Confirm the DVB LED lights (Orange). If not, a timer programming is not available.
- A message will appear if you try to programme a timer event which overlaps an already programmed event.
- 2 min. before the starting time: a reminder message appears.
(To remove the message → OK; To cancel the programming → EXIT)
- 10 sec. before the starting time: in DVB mode, the TV automatically selects the programmed channel.
- Cancelling the programming may not be valid immediately before the starting time. In this case, directly operate the recording equipment to cancel recording.

TV Guide–Electronic Programme Guide (EPG)–Timer Recording

1 View TV Guide



- There are two styles of display for TV Guide (Landscape / Portrait)

2 Select the programme to be broadcast

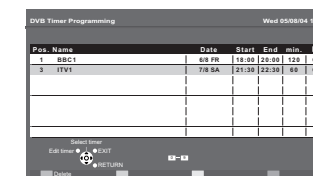
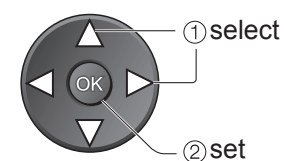

DVB LED will turn on if Timer Programming is set.

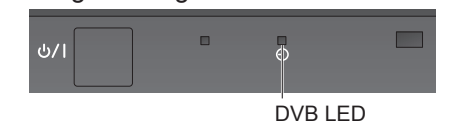

- Orange DVB LED (Rapid blinking during recording)

■ To check / change / cancel a timer programming event → “Timer Programming” (above)

Q-Link Functions

Q-Link connects the TV and VCR / DVD recorder, enables easy recording and playback.

Condition

- Use the VCR / DVD recorder with the following logos: "Q-Link", "NEXTVIEWLINK", "DATA LOGIC", "Easy Link", "Megalogic", or "SMARTLINK"
- Connect the equipment to this TV's AV1 or AV2 terminal via a "fully-wired" SCART cable. (p. 42)
- Q-Link terminal setup in Setup menu (Q-Link, AV1 / AV2 out). (p. 23)

Download analogue channel settings

- Perform Auto Setup. (p. 30)
When first using this TV, see "Auto Setup". (p. 10)
- Perform download to the equipment. (p. 23)

Features available

Some recording equipments are not applicable. Read the manuals of the equipment.

What you see is What you record



Direct TV Recording:

Recording the current programme in VCR / DVD recorder immediately.

- When Direct TV Recording is performed, the recording equipment is automatically turned on if it is in Standby mode.
- The recording equipment is recording from its own tuner. You can turn the TV off during recording (Analogue only).
- If you turn the TV off during recording from an AV source, the recording will be stopped.
- When Direct TV Recording is performed while watching DVB channel, the DVB programme position is locked and no other DVB channel can be selected. However you can watch analogue channels.

To change DVB channel, stop recording



Information / Message

Recording information or if recording is not possible, a message is displayed. (Only when the programme number is "0" or "AV mode" for some equipment.)

Power on link and Easy playback

When VCR or DVD recorder starts playback or direct navigator / function menu for the equipment are activated, the TV is turned on and input mode is switched automatically so that you can view the content. (Only when TV is in Standby mode.)

Power off link

When TV is set to Standby mode, the recording equipment is also automatically set to Standby. (Only when the videocassette or DVD is not active.)

- "DATA LOGIC" (a trademark of Metz Corporation)
 - "Easy Link" (a trademark of Philips Corporation)
 - "Megalogic" (a trademark of Grundig Corporation)
 - "SMARTLINK" (a trademark of Sony Corporation)
- Read the manuals of the equipment too.

HDMI Functions

HDMI (high-definition multimedia interface) allows you to enjoy high-definition digital images and high-quality sound by connecting the TV and the equipment. HDMI-compatible equipment (*1) with an HDMI or DVI output terminal, such as a set top box or a DVD player, can be connected to the HDMI terminal using an HDMI compliant (fully wired) cable. About connections, see "External Equipment" (p. 42).

Note

- HDMI is the world's first complete digital consumer AV interface complying with a non-compression standard.
- If the external equipment has only a DVI output, connect to the HDMI1 terminal via a DVI to HDMI adapter cable (*2).
- When the DVI to HDMI adapter cable is used, connect the audio cable to the audio input terminal (HDMI1: use COMPONENT-AUDIO terminals).
- Audio settings can be made on the "HDMI1 Input" menu screen. (p. 22)
- Applicable audio signal sampling frequencies (2ch L.PCM): 48 kHz, 44.1 kHz, 32 kHz
- HDMI2 terminal is for digital audio signal only.
- Use with a PC is not assumed.
- If the connected equipment has an aspect adjustment function, set the aspect ratio to "16:9".
- These HDMI connectors are "type A".
- These HDMI connectors are compatible with HDCP (High-Bandwidth Digital Content Protection) copyright protection.
- An equipment having no digital output terminal may be connected to the input terminal of either "Component", "S-VIDEO", or "Video" to receive analogue signals.
- The HDMI input terminal can be used with only the following image signals: 480i, 480p, 576i, 576p, 720p, 1080i and 1080p. Match the output setting of the digital equipment.
- For details of the applicable HDMI signals, see p. 46.

(*1): The HDMI logo is displayed on HDMI-compliant equipment.
(*2): Enquire at your local digital equipment retailer shop.

Summary of Control functions

Connecting with an HDMI cable to Panasonic equipment with VIERA Link function, you can control the equipment (p. 40). You can use VIERA Link and Q-Link functions together.

Function	Connection	VIERA Link and Q-Link (HDMI)	VIERA Link only (HDMI)	Q-Link only (SCART)
Easy playback		○	○	○
Power on link		○	○	○
Power off link		○	○	○
Speaker control		○ (not via SCART)	○	-
Easy control only with VIERA remote control		○ (not via SCART)	○	-
Direct TV Recording		○ (not via HDMI)	-	○
Analogue channel download		○ (not via HDMI)	-	○

HDMI Functions

VIERA Link "HDAVI Control"™*

*Enjoy additional HDMI Inter-Operability with Panasonic products which have "HDAVI Control" function. This TV supports "HDAVI Control 2" function.

Connections to some Panasonic equipment (DVD Recorder DIGA, HD Video Camera, Player theatre, Amplifier, etc.) with HDMI cables allow you to interface them automatically.

The equipment with "HDAVI Control" function enables the following operations:

- Easy playback (p. 41)
- Power on link (p. 41)
- Power off link (p. 41)
- Speaker control (p. 41)

In addition, the equipment with "HDAVI Control 2" function enables the following operation:

- Access and control the connected equipment by VIERA remote control (p. 41)

These features are limited to models incorporating Panasonic's "HDAVI Control" and "VIERA Link". VIERA Link "HDAVI Control", based on the control functions provided by HDMI which is an industry standard known as HDMI CEC (Consumer Electronics Control), is a unique function that we have developed and added. As such, its operation with other manufacturers' equipment that supports HDMI CEC cannot be guaranteed.

Refer to individual manuals for compatibility information. About applicable equipment, consult your local Panasonic dealer or refer to the URL: www.panasonic.co.uk

HDMI cable

This function needs an HDMI compliant (fully wired) cable. Non-HDMI-compliant cables cannot be utilized. It is recommended that you use Panasonic's HDMI cable. Recommended part number:

- RP-CDHG15 (1.5 m)
- RP-CDHG30 (3.0 m)
- RP-CDHG50 (5.0 m)

Preparations

Setup the equipment to enable this function. Read the manuals of the equipment.

About connections, see "External Equipment" (p. 43). Read the manuals of the equipment too.

For the first time / When adding new equipment, reconnecting equipment or changing setup After connection turn the equipment on and then switch the TV on.

Select the input mode to HDMI1 or HDMI2 (p. 16), and make sure that an image is displayed correctly.

1 Display the menu
Press the MENU button.

2 Select "Setup"
Use the directional pad to select Setup.

3 Select "VIERA Link"
Use the directional pad to select VIERA Link.

4 Set to "On" (default is On)
Use the directional pad to set the VIERA Link function to On.

Access and control the connected equipment by VIERA remote control

You can control some functions of the connected Panasonic equipment with this TV remote control (point the remote control at the TV's signal receiver).

- If you cannot access the menu, check the settings and the equipment (p. 40).

Access and operate the menu of the equipment

- Display "VIERA Link Menu"** → VIERA Link
- Select "VIERA Link Control"**
Use the directional pad to select VIERA Link Control.
- Select the equipment you want to access**
● "Home Cinema" means Player theatre, Recorder theatre and Amplifier.
Use the directional pad to select the equipment.

When the equipment with "HDAVI Control 2" function is connected

Recorder / Player / Home Cinema / Video Camera
Displayed the type of the connected equipment. Select the type of the equipment and access.

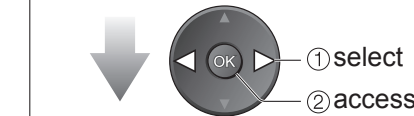

The menu of the accessed equipment
(Input mode will be changed automatically)

When the equipment with "HDAVI Control" function is connected

Recorder / Player / Home Cinema / Video Camera
Displayed the type of the connected equipment. But you cannot access it. Use its own remote control to operate the equipment.

When other type or other manufacturer of the equipment is connected

Others
"Others" is displayed. You cannot access it. Use its own remote control to operate the equipment.

Operate the menu of the equipment

- Available VIERA remote control buttons (depending on the connected equipment):

	Move the cursor / select the menu	EXIT	Exit the menu
	Move the cursor / access / adjust	OPTION	Display the operation guide for the equipment The same functions with the OPTION button of the equipment
	Store / Set / Access		Access when the key words are displayed on colour bar
	Return to the previous menu		

- About the operations for the equipment, read the manual of the equipment.

Easy playback	Automatic Input switching-When the connected Panasonic equipment is operated, input mode is switched automatically. When it is stopped operating, input mode is returned.
Power on link	When the connected Panasonic equipment starts playback or direct navigator / function menu for the equipment are activated, the TV is automatically turned on. (Only when TV is in Standby mode.)
Power off link	When TV is set to Standby mode, the connected Panasonic equipment is also automatically set to Standby. ● This function will work even if the TV enters standby mode automatically by Off Timer function or auto power standby function.

Speaker control

You can control the theatre speaker with TV's remote control. This function is available when Panasonic Amplifier or Player theatre is connected.

- If you cannot access the menu, check the settings and the equipment (p. 40).

- Display "VIERA Link Menu"** → VIERA Link
- Select "Speaker Selection"**
Use the directional pad to select Speaker Selection.
- Set to "Home Cinema" or "TV"**
Use the directional pad to set the speaker mode.

Home Cinema

Amplifier or Player theatre will be automatically turned on (if it is in Standby mode) and the sound is from theatre speakers connected to the equipment.

Volume up / down →

Mute →

- The sound of TV speakers is mute.
- When the equipment is turned off, TV speakers will be active.

TV
TV speakers are active.

External Equipment

These diagrams show our recommendations for how to connect the TV to your various equipment. For other connections, consult the instructions for each piece of equipment, the table below, and the specifications (p. 51).

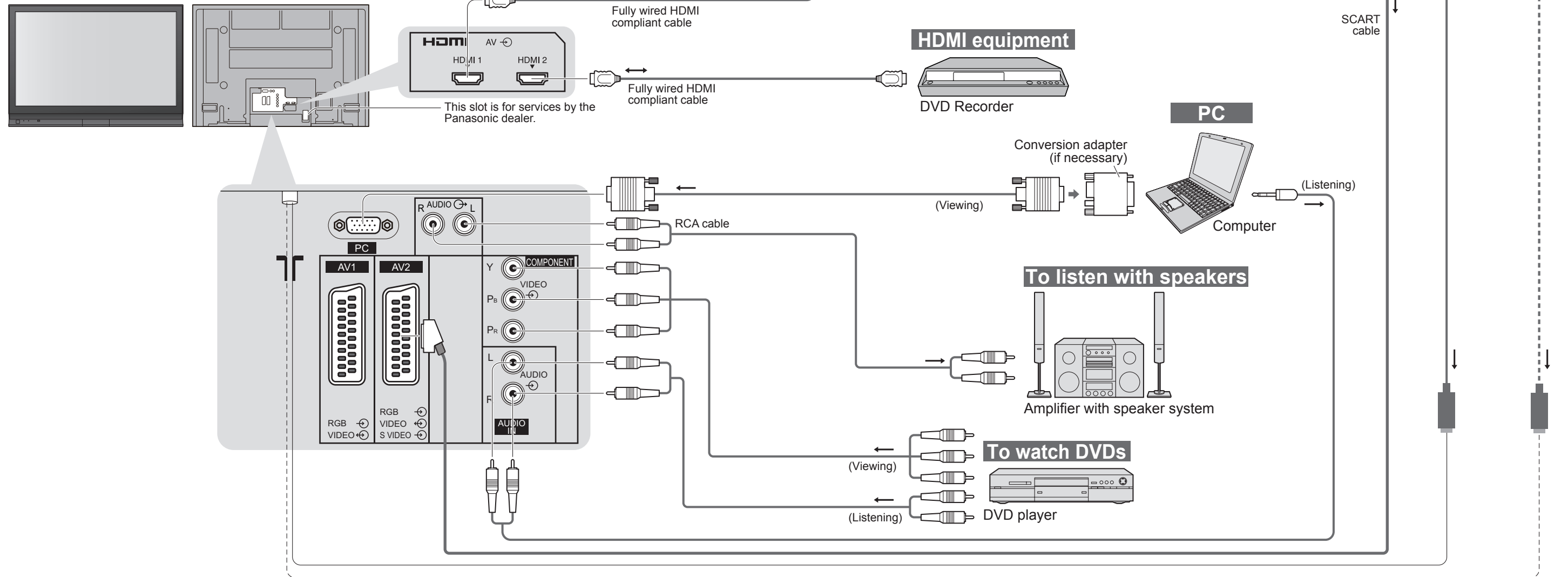

Types of connectable equipment to each connector

Connector	AV1	AV2	COMPONENT Y Pb Pr L R	AUDIO OUT	HDMI	
					1	2
Recording / Playback (equipment)						
■ To record / playback videocassettes / DVDs (VCR / DVD recorder)	○	○				
■ To watch DVDs (DVD player)	○	○	○		○	○
■ To watch camcorder images (Video camera)	○	○			○	○
■ To watch satellite broadcasts (Set top box)	○	○			○	
■ To play games (Game equipment)	○	○				
■ To use amplifier with speaker system				○		
■ Q-Link	○	○				
■ Direct TV Recording	○	○				
■ VIERA Link					○	○

○: Recommended Connection

VIERA Link (p. 40)

- Use fully wired HDMI compliant cable.
- Read the manuals of the equipment too.

Easy playback, Easy control only with VIERA remote control

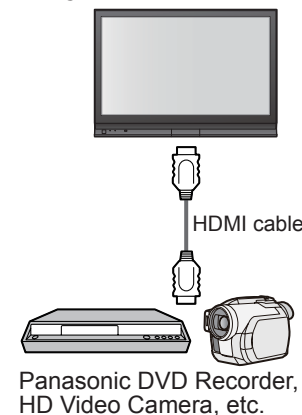

Home Cinema

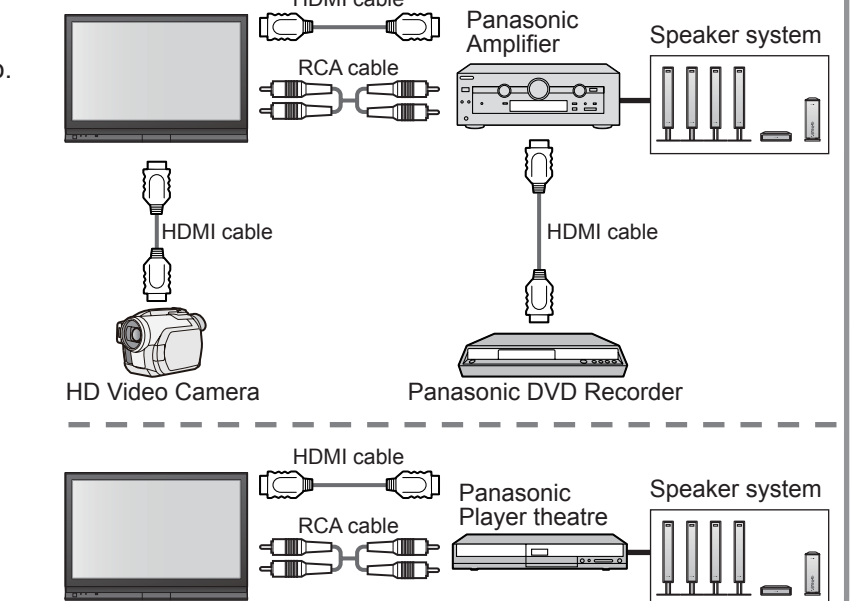

Technical Information

Aspect Ratio

The optimum size and aspect can be chosen, and you can enjoy finer images. (p. 13)

■ **Auto:** Auto aspect determines the best aspect ratio to use to fill your screen. It does this using a four step process to determine if the picture being viewed is a widescreen picture.

If Auto aspect detects a widescreen signal it switches into the appropriate 16:9 or 14:9 widescreen mode. If Auto aspect does not detect a widescreen signal then this advanced TV enhances the picture for optimum viewing pleasure.

The text shown on the screen indicates how Auto aspect determined which ratio to use:

“WIDE” appears in the top left of the screen if a widescreen identification signal (WSS) is found or a signal found through a SCART terminal. Auto aspect switches to the appropriate 16:9 or 14:9 widescreen ratio. This function will also work in any aspect mode. “Auto” appears in the top left of the screen if black stripes above and below the picture are detected. Auto aspect chooses the best ratio and expands the picture to fill the screen. This process can take several minutes, depending on the darkness of the picture.

Signal name	Aspect modes							Aspect Control Signal								
	Auto	16:9	14:9	4:3	Zoom1	Zoom2	Zoom3	Widescreen signal (WSS)			Control signal through SCART (pin 8) or HDMI terminal					
								TV	AV1	AV2	Component	AV1	AV2	HDMI 1	HDMI 2	
TV/AV1/AV2	PAL	○	○	○	○	○	○	○	○	○	○	○	○	○	○	
	PAL 525/60	○	○	○	○	○	○	○	○	○	○	○	○	○	○	
	DVB	○	○	○	○	○	○	○	○	○	○	○	○	○	○	
	M.NTSC	○	○	○	○	○	○	○	○	○	○	○	○	○	○	
Component/HDMI	NTSC(AV input only)	○	○	○	○	○	○	○	○	○	○	○	○	○	○	
	SD	525(480)/60i	○	○	○	○	○	○	○	○	○	○	○	○	○	○
		525(480)/60p	○	○	○	○	○	○	○	○	○	○	○	○	○	○
	625(576)/50i	625(576)/50i	○	○	○	○	○	○	○	○	○	○	○	○	○	○
		625(576)/50p	○	○	○	○	○	○	○	○	○	○	○	○	○	○
	750(720)/50p	750(720)/50p	○	○	○	○	○	○	○	○	○	○	○	○	○	○
		750(720)/60p	○	○	○	○	○	○	○	○	○	○	○	○	○	○
	HD	1125(1080)/50i	○	○	○	○	○	○	○	○	○	○	○	○	○	○
		1125(1080)/60i	○	○	○	○	○	○	○	○	○	○	○	○	○	○
		1125(1080)/50p	○	○	○	○	○	○	○	○	○	○	○	○	○	○
1125(1080)/60p		○	○	○	○	○	○	○	○	○	○	○	○	○	○	
PC input	○	○	○	○	○	○	○	○	○	○	○	○	○	○	○	

Note

- The ratio varies depending on the programme, etc. If the ratio is greater than the standard “16:9”, black bands may appear at the top and bottom of the screen.
- If the screen size looks unusual when a widescreen-recorded programme is played back on a VCR, adjust the tracking of the VCR. (See the VCR manual.)
- Aspect mode can be memorized for SD (Standard definition) and HD (High definition) signals separately.
- To select the ratio manually: (Only “16:9” or “4:3” in PC mode)

Auto		The best ratio is chosen and the picture expanded to fill the screen.
16:9		Directly displays the image at “16:9” without distortion (anamorphic).
14:9		Displays the image at the standard “14:9” without enlargement.
4:3		Displays the image at the standard “4:3” without distortion.
Zoom1		Displays a “16:9” letterbox or “4:3” image without distortion.
Zoom2		Displays a “16:9” letterbox (anamorphic) image full-screen without distortion.
Zoom3		Displays a “2.35:1” letterbox (anamorphic) image full-screen without distortion. At “16:9”, displays the image at its maximum (with slight enlargement).

Updating the DVB software

From time to time, a new version of software for DVB mode may become available for download to enhance performance or operations of the TV. A notification banner will appear when you tune to one of the BBC channels, or you can search for a new version software by using the “System Update Search Now” function (p. 27).

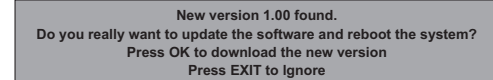

To start downloading press “OK”, this may take up to 20 minutes to complete.

To ignore the new software press “EXIT”, but this banner will keep appearing during the period of new software availability, usually 2 to 3 days.

To download any new software automatically, ensure that the “Auto Update Search in Standby” function in the System Update menu is set to “On” (p. 27). The TV will then download new software automatically at night if it is left in standby without any timer programme in progress.

Note

- During software download and update, DO NOT switch off the TV.

VIERA Link “HDAVI Control™”

HDMI connections to some Panasonic equipment allow you to interface them automatically. (p. 40)

- This function may not work normally depending on the equipment condition.
- Image or sound may not be available for the first few seconds when the playback starts.
- Image or sound may not be available for the first few seconds when Input mode is switched.
- Volume function will be displayed when adjusting the volume of the equipment.
- Easy playback is also available by using the remote control for Amplifier or Player theatre. Read the manuals of the equipment.
- If more than one equipments of the same type are connected to the TV by HDMI cables, for example two DIGA DVD recorders to HDMI1 and 2, VIERA Link will only be available for the lower terminal number, in this case HDMI1.
- “HDAVI Control 2” is the newest standard (current as of February, 2007) for Panasonic’s HDAVI Control compatible equipment. This standard is compatible with Panasonic’s conventional HDAVI equipment.

SCART and HDMI terminal information

AV1 SCART terminal (RGB, VIDEO, Q-Link)

Suitable inputs for AV1 include RGB (Red / Green / Blue).

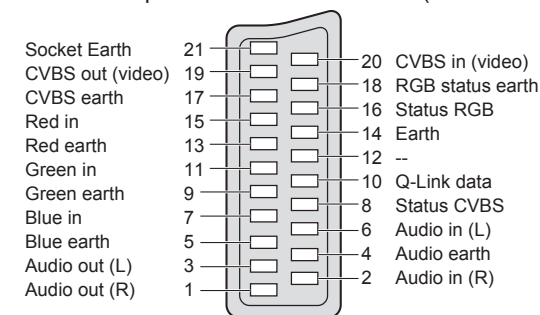

AV2 SCART terminal (RGB, VIDEO, S-VIDEO, Q-Link)

AV2 - Pins 15 and 20 are dependent on AV2 S-VHS / VIDEO switching.

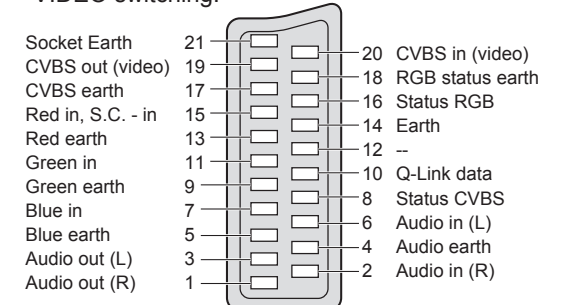

HDMI terminal

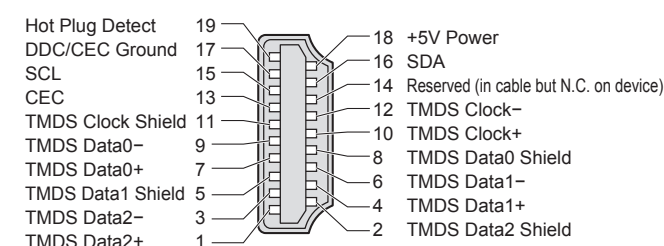

Technical Information

PC connection

A PC may be connected to this TV so that the PC screen is displayed and sound is heard from the TV.

- PC signals that can be inputted: Horizontal scanning frequency 31 to 69 kHz; vertical scanning frequency 59 to 86 Hz (more than 1,024 signal lines could result in incorrect display of the image).
- A PC adapter is not necessary for the DOS/V-compliant D-sub 15-pin connector.

Note

- Some PC models cannot be connected to this TV.
- When using PC, set the colour display quality of PC to the highest position.
- For details of the applicable PC signals, see below.
- Max. display resolution

Aspect	Model No.	TH-37PX70B	TH-42PX70B	TH-50PX70B
4:3		768 × 720 pixels	768 × 768 pixels	1,024 × 768 pixels
16:9		1,024 × 720 pixels	1,024 × 768 pixels	1,366 × 768 pixels

- D-sub 15-pin connector signal

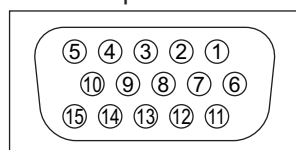

Pin No.	Signal Name	Pin No.	Signal Name	Pin No.	Signal Name
①	R	⑥	GND (Ground)	⑪	NC (not connected)
②	G	⑦	GND (Ground)	⑫	NC (not connected)
③	B	⑧	GND (Ground)	⑬	HD
④	NC (not connected)	⑨	NC (not connected)	⑭	VD
⑤	GND (Ground)	⑩	GND (Ground)	⑮	NC (not connected)

Input signal that can be displayed

COMPONENT (Y, P_B, P_R), HDMI

* Mark: Applicable input signal

Signal name	COMPONENT	HDMI
525 (480) / 60i	*	*
525 (480) / 60p	*	*
625 (576) / 50i	*	*
625 (576) / 50p	*	*
750 (720) / 60p	*	*
750 (720) / 50p	*	*
1,125 (1,080) / 60i	*	*
1,125 (1,080) / 50i	*	*
1,125 (1,080) / 60p	*	*
1,125 (1,080) / 50p	*	*

PC (D-sub 15P)

Signal name	Horizontal frequency (kHz)	Vertical frequency (Hz)
640 × 400 @70 Hz	31.47	70.07
640 × 480 @60 Hz	31.47	59.94
640 × 480 @75 Hz	37.50	75.00
800 × 600 @60 Hz	37.88	60.32
800 × 600 @75 Hz	46.88	75.00
800 × 600 @85 Hz	53.67	85.06
852 × 480 @60 Hz	31.44	59.89
1,024 × 768 @60 Hz	48.36	60.00
1,024 × 768 @70 Hz	56.48	70.07
1,024 × 768 @75 Hz	60.02	75.03
1,024 × 768 @85 Hz	68.68	85.00
1,280 × 1,024 @60 Hz	63.98	60.02
1,366 × 768 @60 Hz	48.39	60.04
Macintosh13" (640 × 480)	35.00	66.67
Macintosh16" (832 × 624)	49.73	74.55
Macintosh21" (1,152 × 870)	68.68	75.06

Note

- Signals other than above may not be displayed properly.
- The above signals are reformatted for optimal viewing on your display.
- Applicable input signal for PC is basically compatible to VESA standard timing.
- PC signal is magnified or compressed for display, so that it may not be possible to show fine detail with sufficient clarity.

FAQs

Before requesting service or assistance, please follow these simple guides to resolve the problem. If problem still persists, please contact your local Panasonic dealer or Panasonic Customer Care Centre for assistance. For details (p. 52)

White spots or shadow images (noise)

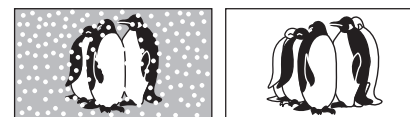

- Check the position, direction, and connection of the aerial.

Neither image nor sound is produced

- Is the TV in "AV mode"?
- Is the mains lead plugged into the socket outlet?
- Is the TV turned On?
- Check Picture Menu (p. 22) and volume.
- Check all required SCART cables and connections are firmly in place.

Auto aspect

- Auto aspect is designed to provide you with the best aspect ratio to use to fill your screen. For user control please see p. 44.

S-Video / black and white picture

- Using AV button please confirm your selection is S-Video i.e. AV2/AV2S (p. 16).

No programmes shown on TV Guide

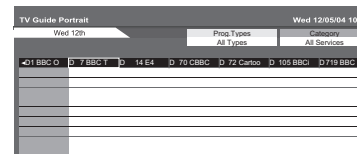

- Check the DVB transmitter.
- Adjust the direction of the aerial to another transmitter installed nearby.
- Check the analogue broadcast. If the image quality is poor, check the aerial and consult your nearest dealer.

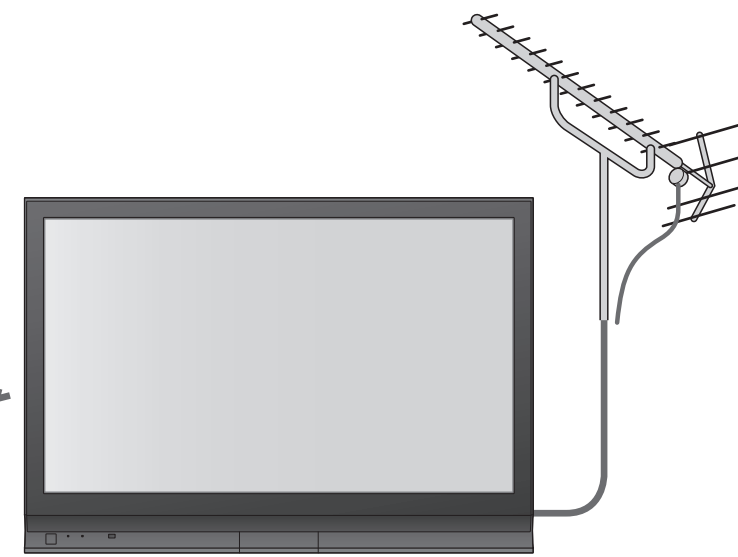

On Screen messages - I.e. EC/AV1

- You can simply clear these by pressing the **i** button. Press again to redisplay.

Direct TV record / Q-Link functions not recording

- Please confirm SCART cable and connection. Also please set "AV1 / AV2 out" in the Setup Menu (p. 23).

Permanently lit spots on screen

- Due to production process involved in this technology this may result in some pixels which are permanently lit or unlit. This is not a malfunction.

Contrast is reduced

- Contrast is lowered when the following conditions without any user operation for a few minutes:
 - no signal in DVB or AV mode
 - selected locked channel
 - selected invalid channel
 - selected radio channel
 - displayed menu

FAQs

	Problem	Actions
Screen	Chaotic image, noisy	<ul style="list-style-type: none"> ● Set "P-NR" in the Picture Menu (to remove noise). (p. 22) ● Check nearby electrical products (car, motorcycle, fluorescent lamp).
	No image can be displayed	<ul style="list-style-type: none"> ● Is "Colour" or "Contrast" in the Picture Menu set to the minimum? (p. 22)
	Blurry or distorted image (no sound or low volume)	<ul style="list-style-type: none"> ● Reset channels. (p. 30)
	Unusual image is displayed	<ul style="list-style-type: none"> ● Turn off the TV with Mains power On / Off switch, then turn it on again.
Sound	No sound is produced	<ul style="list-style-type: none"> ● Is "Sound mute" active? (p. 7) ● Is the volume set to the minimum?
	Sound level is low or sound is distorted	<ul style="list-style-type: none"> ● Sound signal reception may be deteriorated. ● Set "NICAM" (p. 22) in the Sound Menu to "Off". (Analogue only)
DVB		<ul style="list-style-type: none"> ● Due to the digital reception technologies involved, quality of the DTV signals may be relatively low in some cases, despite good reception of analogue programmes.
	Interference or frozen / disappearing image in DVB	<ul style="list-style-type: none"> ● Check "DVB Signal Condition". (p. 31) If "Signal Quality" or "Signal Strength" are displayed in red, check aerial. If problem persists, consult your local Panasonic dealer. ● Turn the TV off with the Mains power On / Off switch, then turn it On again.
HDMI	Sound is unusual	<ul style="list-style-type: none"> ● Set the sound setting of the connected equipment to "2ch L.PCM". ● Check the "HDMI1 Input" setting in the Sound Menu. (p. 22) ● If digital sound connection has a problem, select analogue sound connection. (p. 39)
	Pictures from external equipment are unusual when the equipment is connected via HDMI	<ul style="list-style-type: none"> ● Is the HDMI cable connected properly? (p. 42) ● Turn Off the TV and equipment, then turn them On again. ● Check an input signal from the equipment. (p. 46) ● Use an equipment compliant with EIA/CEA-861/861B.
	"VIERA Link" function does not work and an error message appears	<ul style="list-style-type: none"> ● Confirm the connection. ● Turn the connected equipment on and then switch the TV on. (p. 40)
	TV goes into "Standby mode"	<ul style="list-style-type: none"> ● Off Timer function is activated. ● The TV enters "Standby mode" about 30 min. after broadcasting ends.
Other	The remote control does not work	<ul style="list-style-type: none"> ● Are the batteries installed correctly? (p. 6) ● Has the TV been switched On?
	An error message appears	<ul style="list-style-type: none"> ● Follow the message's instructions. ● If the problem persists, contact the authorized Service Centre.

On screen messages

Message	Meaning / Action
All tuning data will be erased	<ul style="list-style-type: none"> ● "Shipping Condition" will erase all tuning data (p. 32). ● "Auto Setup" will be erased all present DVB and Analogue tuning datas (p. 30).
Are you sure ?	<ul style="list-style-type: none"> ● Make sure the operation is with your desire.
Are you sure you want to delete this timer ? Press OK to delete timer Press Exit to return	<ul style="list-style-type: none"> ● Make sure the deleting programme event is with your desire.
Bad Signal	<ul style="list-style-type: none"> ● The signal is weak. Check the aerial.
DOWNLOAD IN PROGRESS PLEASE WAIT	<ul style="list-style-type: none"> ● Q-Link channel download is in progress.
Feature not available	<ul style="list-style-type: none"> ● Check the Q-Link connection and setting (p. 38). ● The impossible source (Component / HDMI / PC) to be record.
Invalid DVB Channel	<ul style="list-style-type: none"> ● Invalid DVB channel is selected.
Invalid system time. Please exit !	<ul style="list-style-type: none"> ● Cannot get the time information. Check the connection of the RF cable.
Max. number of Timers already set !	<ul style="list-style-type: none"> ● Maximum timer programming event is 8.
New DVB Service Found! Press OK start Auto Setup Press EXIT to Ignore. Selecting Auto Setup will delete current Profile and Childlock settings	<ul style="list-style-type: none"> ● There is a new DVB station.
New version 1.90 found. Do you really want to update the software and reboot the system ? Press OK to download the new version Press EXIT to Ignore	<ul style="list-style-type: none"> ● There is a new software available.
No DVB Service found	<ul style="list-style-type: none"> ● No DVB signal can be found in Auto Setup.
No module inserted	<ul style="list-style-type: none"> ● Check the CI module inserted completely (p. 27).
No recording - Check Tape or Disc	<ul style="list-style-type: none"> ● The tape or disc may be "write protected", missing or damaged. The equipment may already be recording.
No recording - UNKNOWN REASON	<ul style="list-style-type: none"> ● The recording cannot be done by any reason. Check the equipment. ● Disc or tape may be full.
No Service	<ul style="list-style-type: none"> ● The station stops the services.
No Signal	<ul style="list-style-type: none"> ● Check the connection of the RF cable.

On screen messages

Message	Meaning / Action
No stations found Please insert the aerial	▶ ● No analogue signal can be found in Auto Setup.
PIN incorrect !	▶ ● The PIN number you entered is wrong.
Please check aerial or local DVB service availability. Press OK to start Auto Setup	▶ ● Please follow the message. If it is still failed, consult your local Panasonic dealer.
Please check settings and connections on HDMI devices.	▶ ● Communication error in VIERA Link function (p. 40).
Please wait.	▶ ● A function is in progress.
Recording in progress	▶ ● The recording equipment is recording the programme signal from its own tuner. You can turn the TV off and leave the equipment recording in the normal way.
Shipping condition completed. TV can now be switched off.	▶ ● "Auto Setup" will automatically start when Mains power On / Off switch is next turned On. (p. 10)
Software successfully updated Press EXIT to continue	▶ ● The software updating is finished.
Software Update failed. Please try again later. Press EXIT to continue	▶ ● Perform "System Update Search Now" in System Update (p. 27). If it is still failed, there may not be the new software.
This service is locked ! Press OK to enter PIN	▶ ● The selected channel is locked in Child Lock (p. 29).
Timer already expired !	▶ ● Starting time in Timer Programming is already past. Set correctly (p. 37).
Timer Event Due to Start DVB 1: BBC1 has been Programmed for recording at 20:00	▶ ● This message will appear 2 minutes before timer programming event due to start.
Timer incorrect !	▶ ● Set Starting and Ending times in Timer Programming correctly (p. 37).
Timer overlap!	▶ ● The timer programme events are overlapped. Cannot record other channel at the same time. Check the Starting and Ending times in Timer Programming (p. 37).
Tuner Locked Please stop recording to operate	▶ ● If you want to unlock, cancel Direct TV Recording (p. 38) or Timer Programming (p. 36).
Unable to download, Check Equipment	▶ ● The tape or disc is active. Stop the equipment and try again.

Specifications

	TH-37PX70B	TH-42PX70B	TH-50PX70B	
Power Source	AC 220-240 V, 50 / 60 Hz			
Power Consumption	Average use	250 W	270 W	
	Standby condition	0.7 W (Without DVB recording) 20 W (With DVB recording)	0.5 W (Without DVB recording) 20 W (With DVB recording)	
Display panel	Aspect Ratio	16:9		
	Visible screen size	94 cm (diagonal) 819 mm (W) × 457 mm (H)	106 cm (diagonal) 922 mm (W) × 518 mm (H)	127 cm (diagonal) 1,106 mm (W) × 622 mm (H)
	Number of pixels	737,280 (1,024 (W) × 720 (H)) [3,072 × 720 dots]	786,432 (1,024 (W) × 768 (H)) [3,072 × 768 dots]	1,049,088 (1,366 (W) × 768 (H)) [4,098 × 768 dots]
Sound	Speaker	160 mm × 42 mm × 2 pcs, 8 Ω		
	Audio Output	20 W (10 W + 10 W), 10% THD		
PC signals	VGA, SVGA, XGA SXGA (compressed) Horizontal scanning frequency 31 - 69 kHz Vertical scanning frequency 59 - 86 Hz			
Receiving Systems / Band name	PAL I	:UHF E21-68		
	PAL 525/60	:Playback of NTSC tape from some PAL Video recorders (VCR) or NTSC disc playback from DVD player and recorder.		
	DVB M.NTSC	:Digital terrestrial services via UHF aerial input.		
	NTSC (AV input only)	:Playback from M.NTSC Video recorders (VCR).		
Aerial - Rear	UHF			
Operating Conditions	Temperature : 0 °C - 35 °C Humidity : 20 % - 80 % RH (non-condensing)			
Connection Terminals	AV1 (Scart terminal)	21 Pin terminal (Audio/Video in, Audio/Video out, RGB in, Q-Link)		
	AV2 (Scart terminal)	21 Pin terminal (Audio/Video in, Audio/Video out, RGB in, S-Video in, Q-Link)		
	COMPONENT	VIDEO	Y : 1.0 V[p-p] (including synchronization) Pb, Pr : ±0.35 V[p-p]	
		AUDIO L - R	RCA PIN Type × 2 : 0.5 V[rms]	
	Others	HDMI1 / 2	TYPE A Connectors : ● This TV supports "HDAVI Control 2" function.	
		PC	HIGH-DENSITY D-SUB 15PIN : R,G,B/0.7 V[p-p] (75 Ω) HD, VD/TTL Level 2.0 - 5.0 V[p-p] (high impedance)	
	Output	AUDIO L - R	RCA PIN Type × 2 : 0.5 V[rms] (high impedance)	
Dimensions (W × H × D)	917 mm × 620 mm × 97 mm	1,020 mm × 680 mm × 97 mm	1,210 mm × 793 mm × 97 mm	
Mass	23.0 kg Net	27.0 kg Net	38.0 kg Net	

- Note**
- Design and Specifications are subject to change without notice. Weight and Dimensions shown are approximate.
 - This equipment complies with the EMC standards listed below.
EN55013, EN61000-3-2, EN61000-3-3, EN55020, EN55022, EN55024.

Index

A Accessories 6	DVB Signal Condition... 31	Mode 22	Satellite receiver... 9, 16, 42
Add New DVB Services... 31	DVB Timer Programming... 36	Multi Audio 13	SCART 8, 45
Analogue Manual Tuning... 31	DVI 39	N New Service Message... 31	Shipping Condition... 32
Analogue Programme Edit... 31	DVDs 8, 16	NICAM 22	Specifications 51
Aspect 13, 44	E EPG 14	NTSC 24, 51	Subtitles 13, 20
Audio Description... 13, 22	External equipment... 8, 16, 42	O Off timer 12, 23	Surround 22
Auto Setup 10, 30	External input 16, 35	Optional accessories... 6	S-Video 8
AV1 / AV2 out 23, 38	F FAQs 47, 48	Owner ID 10, 33	System Update 27, 45
B Banner Display Timeout... 23	H HDMI 39-41, 45	P PAL 51	T Teletext 18-20
C Category list 14	Hold 13, 20	PC 35, 46	Tuning Menu 30
Child Lock 29	Home Cinema 41, 43	PIN number 10, 29, 33	TV Guide 14
CI module 27	I Information banner 13	P-NR 22	TV speaker 41
Clamper 6	Input Labels 34	Power LED 7, 10	Type list 14
COMPONENT 42, 46	Input signal 46	Q Q-Link 23, 38	U Update the software... 27, 45
Connection 8, 42	L Licence 52	Quick Start Guide... 6-11	V Video 8, 16
D Direct TV Recording... 38	M Mains Lead 8	R Remote control 6, 7	VIERA Link 40, 43, 45
Download to equipment... 10, 23	Mains power On / Off switch 7, 12	Reset to Default 22	Viewing Mode 10, 22
D-sub 15-pin 46	Maintenance 5	RGB 8	Volume Correction... 22
DVB LED 7, 15, 37	Menu Functions 21-25	S Sales and Support Information 52	W WSS 44
DVB Manual Tuning... 31			Z Zoom 44
DVB Profile Edit 29			
DVB Settings 26			