

Panasonic®

Operating Instructions (Detailed Information)

Streaming Player

Model No. DMP-MST60
DMP-MS10



Unless otherwise indicated, illustrations in these operating instructions are of DMP-MST60.

Model number suffix "EB" denotes UK model.

EB

VQT4X77-1
F0213QK1043

Table of contents

Getting started

Accessories	3
Unit and media care	3
Control reference guide	4

Connections and Settings

Connecting to a TV	7
Connecting to the AC adaptor	7
Connecting to an amplifier/receiver	8
Connecting to the network	8
Settings	10

Playback

HOME menu	13
Enjoying Network Service	14
Using Miracast™	15
Home Network feature	16
Playing back USB devices	18
Operations during playback	19
Enjoying 3D	20
“HDMI CEC”	20
Multi User Mode	21

Settings

Option menu	22
Setup menu	24

Reference

LED indicators	28
Messages	28
Troubleshooting guide	29
Specifications	32

● **Firmware updates (⇒ 12)**

Accessories

Check the supplied accessories before using this unit.

- Product numbers provided in these operating instructions correct as of January 2013. These may be subject to change.

1 Remote control

MST60 (N2QAYB000891)

MS10 (N2QAYB000886)

2 Batteries for remote control

1 AC adaptor

(VSK0812)

- For use with this unit only. Do not use it with other equipment.
- Do not use any other AC adaptors except the supplied one.

1 HDMI cable

(K1HY19YY0012)

Unit and media care

■ Clean this unit with a soft, dry cloth

- Never use alcohol, paint thinner or benzine to clean this unit.
- Before using chemically treated cloth, carefully read the instructions that came with the cloth.

■ To dispose or transfer this unit

The unit may keep the user settings information in the unit. If you discard this unit either by disposal or transfer, then follow the procedure to return all the settings to the factory presets to delete the user settings. (⇒ 29, “To return all settings to the factory preset.”)

- The operation history may be recorded in the memory of this unit.

Control reference guide

Remote control

MST60



- 1 Turn the unit on and off
- 2 TV operation buttons
You can operate the Panasonic TV using the unit's remote control. Some buttons may not work depending on the TV.
[TV] : Turn the TV on and off
[AV] : Change input
[+ - VOL] : Adjust the volume
- 3 Enter numbers or characters
- 4 Cancel
- 5 Select audio (⇒ 19)
- 6 Basic playback control buttons (⇒ 19)
- 7 Show Top menu (⇒ 19)
- 8 Show Miracast™ screen (⇒ 15)
- 9 Show Option menu (⇒ 22)
- 10 Coloured buttons (red, green, yellow, blue)
Used for various purposes depending on the display.
- 11 Transmit the remote control signal
- 12 Show status messages (⇒ 19)
- 13 Show Setup menu (⇒ 24)
- 14 Show Home Network menu (⇒ 16)
- 15 Show the Home screen of the Network Service
- 16 Exit the menu screen
- 17 Show Netflix screen (⇒ 14)
- 18 Show HOME menu (⇒ 13)
- 19 [▲, ▼, ◀, ▶] : Move the highlight for selection
[OK] : Confirm the selection
- 20 Return to previous screen

MS10



- 1 Turn the unit on and off
- 2 TV operation buttons
You can operate the Panasonic TV using the unit's remote control. Some buttons may not work depending on the TV.
[TV] : Turn the TV on and off
[AV] : Change input
[+ - VOL] : Adjust the volume
- 3 Enter numbers
- 4 Cancel
- 5 Select audio (⇒ 19)
- 6 Basic playback control buttons (⇒ 19)
- 7 Show Top menu (⇒ 19)
- 8 Show Miracast screen (⇒ 15)
- 9 Show Option menu (⇒ 22)
- 10 Coloured buttons (red, green, yellow, blue)
Used for various purposes depending on the display.
- 11 Transmit the remote control signal
- 12 Show status messages (⇒ 19)
- 13 Show Setup menu (⇒ 24)
- 14 Show Home Network menu (⇒ 16)
- 15 Show the Home screen of the Network Service
- 16 Exit the menu screen
- 17 Show Netflix screen (⇒ 14)
- 18 Show HOME menu (⇒ 13)
- 19 [▲, ▼, ◀, ▶] : Move the highlight for selection
[OK] : Confirm the selection
- 20 Return to previous screen

The Unit

Front View

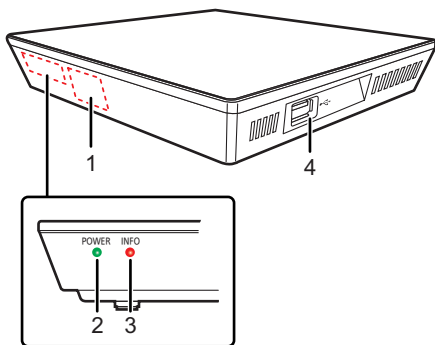

Rear View

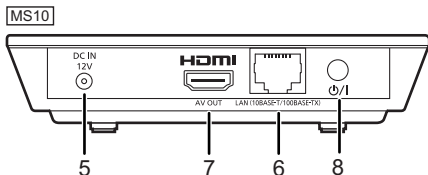
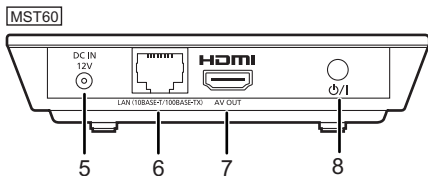

- 1 Remote control signal sensor
Distance: Within approx. 7 m
Angle: Approx. 20° up and down, 30° left and right
- 2 POWER LED
Blinks when the power is turned on.
Wait for the LED to turn solid green before using this unit.
- 3 INFO LED (⇒ 28, "LED indicators")
Displays the various states of this unit.
- 4 USB port (⇒ 18)
- 5 DC IN terminal (⇒ 7)
- 6 LAN port (⇒ 9)
- 7 HDMI AV OUT terminal (⇒ 7)
- 8 **Standby/on switch** (⏻/⏻) (⇒ 10)
Press to switch the unit from on to standby mode or vice versa. In standby mode, the unit still consumes a small amount of power.

Connecting to a TV

- Before making any connections, we recommend that you temporarily disconnect all the units from AC power.
- Use the High Speed HDMI cables.

Non-HDMI-compliant cables cannot be utilized. The HDMI-compliant cable is supplied with this unit.

It is recommended that you use Panasonic's HDMI cable. When outputting 1080p signal, please use HDMI cables 5.0 meters or less.

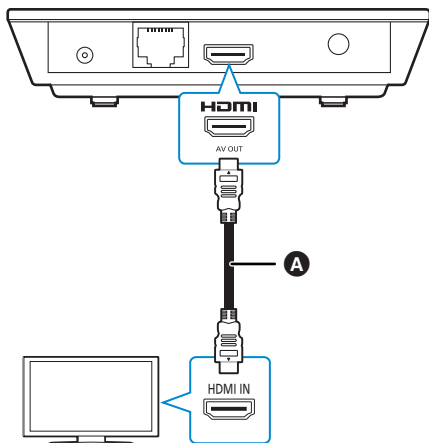

- **A** HDMI cable (supplied)

Connecting to the AC adaptor

Connect the AC adaptor after making all other connections.

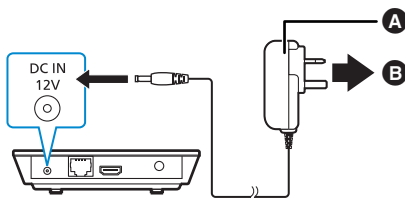

- **A** AC adaptor (supplied)
- **B** To a household mains socket

- This unit consumes a small amount of AC power (⇒ 32) even when turned off. For the purpose of power conservation, the unit can be disconnected if you will not be using it for extended period of time.

Connecting to an amplifier/receiver

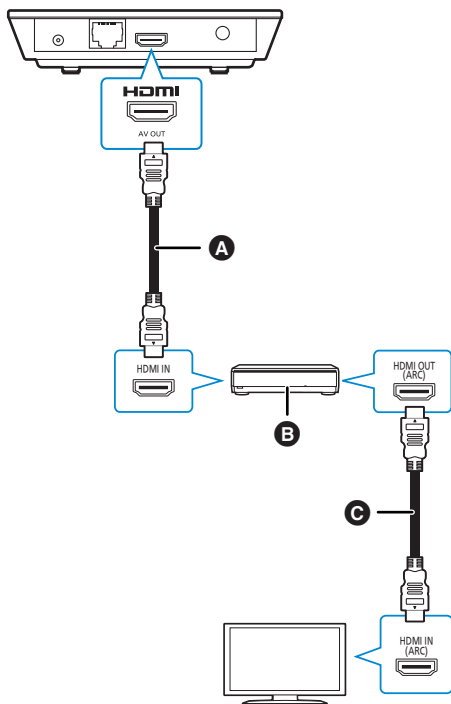

- A** HDMI cable (supplied)
- B** Amplifier/receiver
- C** HDMI cable

- Set "Digital Audio Output" (⇒ 25).
- When using the TV or amplifier/receiver that does not have the indication of "(ARC)" (non-ARC-compatible) on the HDMI terminal, the amplifier/receiver and TV must also be connected using an optical digital cable in order to enjoy the TV's sound through the amplifier/receiver.
- **MST60** When connecting to a non-3D compatible amplifier/receiver, connect this unit to a TV, then connect the TV and the amplifier/receiver.

Connecting to the network

The following services can be used when this unit is connected to broadband.

- Firmware can be updated (⇒ 12)
- You can enjoy Network Service (⇒ 14)
- You can access other devices (Home Network) (⇒ 16)
- This unit supports Wi-Fi Direct™ and can make a wireless connection to wireless devices without router. You can use this function when enjoying Home Network feature, etc. Internet access is not available while connected via Wi-Fi Direct™. (⇒ 16, 25)

For details about connection method, refer to the instructions supplied with the connected equipment.

Wireless LAN connection

This unit has built-in Wi-Fi® and can be connected to a wireless router.

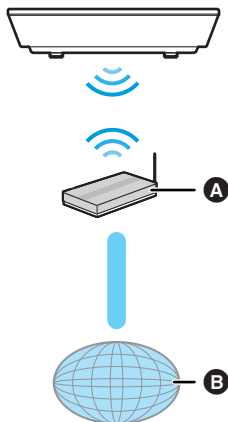

A Wireless router, etc.

B Internet

- For up-to-date compatibility information on your wireless router, refer to <http://panasonic.jp/support/global/cs/> (This site is in English only.)
- The unit is not compatible with public wireless LAN services (Hotspot etc.) provided in airports, stations, cafes, etc.
- See “Operating Instructions (Essential Information)” for the precautions for wireless LAN connection.

LAN cable connection

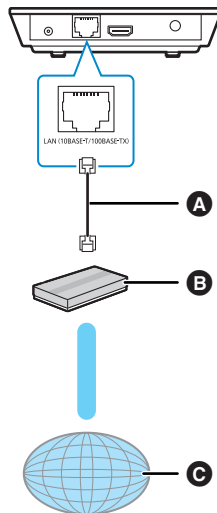

A LAN Cable

B Broadband router, etc.

C Internet

- Inserting any cable other than a LAN cable in the LAN port can damage the unit.

Settings

Easy Settings

After connecting your new unit for the first time and pressing [⏻], the basic settings screen will appear.

Preparation

Turn on the TV and select the appropriate video input.

- 1 Press [⏻].
Setup screen appears.
- 2 Follow the on-screen instructions to continue with the settings.



- You can perform this setup anytime by selecting "Easy Settings" in the Setup menu. (⇒ 27)

Easy Network Setting

After completing "Easy Settings", you can perform "Easy Network Setting".

Select "Wired" or "Wireless" and press [OK].

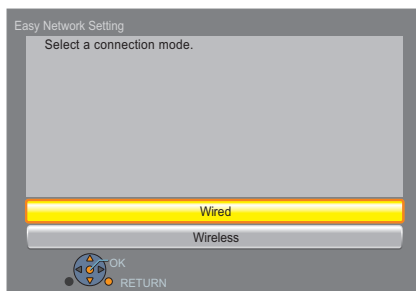

“Wired” connection

Follow the on-screen instructions to establish your connection settings.

“Wireless” connection

Before beginning wireless connection setup

- Obtain your network name (SSID*1).
- If your wireless connection is encrypted, please be sure that you know your encryption key.

Select "Search for wireless network" or "WPS (PUSH button)" and press [OK], then follow the on-screen instructions to continue with the settings.

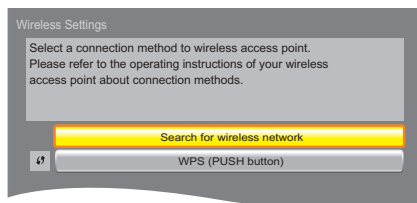

WPS (PUSH button):

If your wireless router supports WPS (PUSH button), you can easily perform the settings by pressing WPS button on it.

e.g.

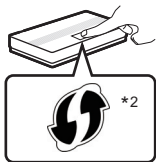

WPS (Wi-Fi Protected Setup™) is a standard that facilitates settings relating to the connection and security of wireless LAN devices.

- ① Press WPS button or corresponding button of the wireless router until the lamp starts flashing.
 - For details, refer to the operating instruction of the wireless router.
- ② Press [OK].

Search for wireless network:

- When you select “Search for wireless network”, the available wireless networks will be displayed. Select your network name and press [OK].
 - If your network name is not displayed, search again by pressing the red button on the remote control.
 - Stealth SSID will not be displayed when you select “Search for wireless network”. Enter manually by using “Manual setting”.
While displaying the HOME menu, press the [SETTINGS] button on the remote control
 - ⇒ select “Network” and press [OK]
 - ⇒ select “Network Settings” and press [OK]
 - ⇒ select “Wireless Settings” and press [OK]
 - ⇒ select “Connection Setting” and press [OK]
 - ⇒ select “Manual setting” and press [OK]
- If your wireless network is encrypted, Encryption Key input screen will be displayed. Input the encryption key of your network.



- Refer to the operating instructions of the hub or router.
- You can perform this setup anytime by selecting “Easy Network Setting” in the Setup menu. (⇒ 25)
- You can redo these settings individually using “Network Settings”. (⇒ 25)
- Do not use this unit to connect to any wireless network for which you do not have usage rights.
During automatic searches in a wireless network environment, wireless networks (SSID) for which you do not have usage rights may be displayed; however, using these networks may be regarded as illegal access.
- After performing network settings on this unit, the settings (encryption level, etc.) of the wireless router might change. When you have trouble getting online on your PC, perform the network settings on your PC in accordance with the settings of wireless router.
- Please be aware that connecting to a network without encryption may result in the content of the communication being illegitimately viewed by a third party, or the leaking of data such as personal or secret information.

^{*1} SSID

An SSID (Service Set Identification) is a name used by wireless LAN to identify a particular network. Transmission is possible if the SSID matches for both devices.

^{*2} The wireless router compatible with Wi-Fi Protected Setup™ may have the mark.

Reprogramming the remote control

If you have more than one Panasonic player/recorder and the remote control operates both products at once, you will need to change the remote control code to prevent this occurrence. (⇒ 27, “Remote Control”)

Firmware updates

Occasionally, Panasonic may release updated firmware for this unit that may add or improve the way a feature operates. These updates are available free of charge.

This unit is capable of checking the firmware automatically when connected to the Internet via a broadband connection.

When a new firmware version is available, the following message is displayed.

New firmware is available.
Please update firmware in Setup.

To update the firmware

Press [HOME]

⇒ **press the [SETTINGS] button on the remote control**

⇒ **select “System” and press [OK]**

⇒ **select “Firmware Update” and press [OK]**

⇒ **select “Update Now” and press [OK]**

DO NOT DISCONNECT the unit from the AC power or perform any operation while the update takes place.

After the firmware is installed, INFO LED and POWER LED flash for 3 times (⇒ 6), and “FIN” will be displayed on the screen. Unit will restart and the following screen will be displayed.

The firmware has been updated.
Current Version: x.xx



- **To show the firmware version on this unit.**
(⇒ 27, “Firmware Version Information”)
- **Downloading will require several minutes. It may take longer or may not work properly depending on the connection environment.**
- If you do not want to check for the latest firmware version, set “Automatic Update Check” to “Off”. (⇒ 27)

HOME menu

Major functions of this unit can be operated from the HOME menu.

Preparation

Turn on the TV and select the appropriate video input on the TV.

1 Press [⏻] to turn on the unit.

- After network service introduction banner is shown, the HOME menu is displayed.
 - When connected to the network, the banner content may be changed.
 - You can disable the “Start-up Banner” (⇒ 27).

2 Press [OK] or [▲, ▼, ◀, ▶] to select the item.

- If there are any other items, repeat this step.

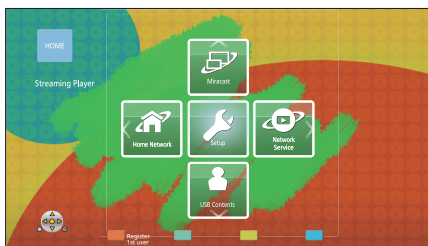

Miracast

Starting Miracast. (⇒ 15)

Home Network

DLNA Client	(⇒ 16)
Media Renderer	(⇒ 17)

USB Contents

Videos	Play back the contents. (⇒ 18) <ul style="list-style-type: none"> • When multiple contents are recorded, select the types of contents or the title.
Photos	
Music	

Network Service

Displays the Home screen of Network Service. (⇒ 14)

Setup

Player Settings	(⇒ 24)
MST60 Operating instructions	You can browse the Operating instructions for this unit on the Internet.
Wallpaper	Changes the background of HOME menu.

To show the HOME menu

Press [HOME].



- Items to be displayed may vary with the contents.

Enjoying Network Service

Network Service allows you to access some specific websites supported by Panasonic, and enjoy Internet contents such as photos, videos, etc. from Network Service Home screen.

MS10 The unit has selected network content and some features of websites may not be available.

Network Service provides a variety of selected Internet services such as the following.

- Online movie rental service
- Video browsing service

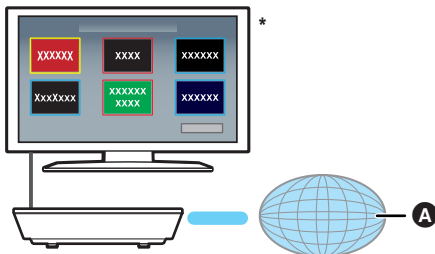

A Internet

* Images are for illustration purposes, contents may change without notice.

Preparation

- Network connection (⇒ 8)
- Network setting (⇒ 10)

1 Press [INTERNET].

- Netflix can be accessed directly by pressing [NETFLIX] button.

2 Select the item and press [OK].

To exit from Network Service

Press [HOME].



- When playing content in the media, Network Service cannot be accessed by pressing [INTERNET].
- In the following cases, settings are possible using the Setup menu items.
 - When restricting the use of Network Service (⇒ 26, "Network Service Lock")
 - When correcting the displayed time (⇒ 26, "Time Zone", "Summer Time")
- If using slow Internet connection, the video may not be displayed correctly. A high speed Internet service with a speed of at least 6 Mbps is recommended.
- Be sure to update the firmware when a firmware update notice is displayed on the screen. If the firmware is not updated, you may not be able to use Network Service function properly. (⇒ 12)
- Network Service Home screen is subject to change without notice.
- The services through Network Service are operated by their respective service providers, and service may be discontinued either temporarily or permanently without notice. Therefore, Panasonic will make no warranty for the content or the continuity of the services.
- Some features of websites or content of the service may not be available.
- Some content may be inappropriate for some viewers.
- Some content may only be available for specific countries and may be presented in specific languages.

Using Miracast™

You can enjoy the content you are viewing on a Miracast-compatible smartphone, etc. on the big screen of your TV.

- Compatible with Android™ devices, ver. 4.2 and above and Miracast certified.

For information on whether the smartphone, etc. supports Miracast, contact the manufacturer of the device.

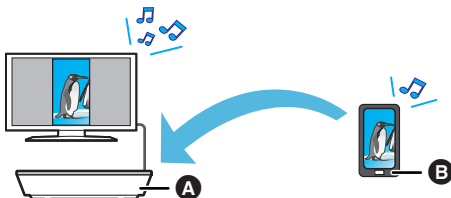

- A** Player
- B** Miracast compatible device

1 Press [MIRACAST].

2 Operate the Miracast compatible device.

- On the device, enable Miracast and select this unit (DMP-MST60 or DMP-MS10) as the device to be connected.
For details, refer to the instructions supplied with the device.

To exit from Miracast

Press [HOME].



- Depending on the device or connection environment, the data transfer rate may decrease.

Home Network feature

Playing back contents on the DLNA server

You can share photos, videos and music stored in the DLNA Certified media server (PC with Windows 7 installed, smartphone, etc.) connected to your home network, and enjoy the contents with this player.

You can also enjoy viewing the video and photos recorded in Panasonic DLNA compatible recorders (DIGA).

Refer to our website about the sales area, etc. (⇒ 17)

- **About support format of DLNA.** (⇒ 33)
- **Before using the DLNA feature, be sure to configure the DLNA server on your Home Network.**

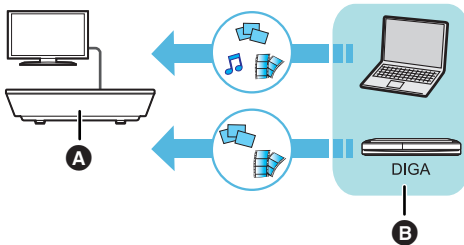

- **A** Player
- **B** Server

Preparation

- ① Perform network connection (⇒ 8) and network settings (⇒ 10) of this unit.
 - ② Perform Home Network settings of the connected equipment.
 - ③ Add the contents and folder to the libraries of the Windows Media® Player or the smartphone, etc.
 - Playlist of Windows Media® Player can play back only the contents that are stored in the libraries.
- When connected to DIGA, register this unit to your DIGA.

- 1 Press [DLNA].
- 2 Select "DLNA Client".
 - The list can be updated by pressing the red button on the remote control.
 - The connection method can be switched to Wi-Fi Direct by pressing the green button on the remote control.
- 3 Select the equipment and press [OK].
- 4 Select the item to play and press [OK].
 - You may be able to use convenient functions depending on the content by pressing [OPTION].
 - Control Panel is displayed once the playback starts. Press [OK] if the Control Panel is not displayed, and press [RETURN] to hide the Control Panel.

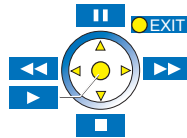

To exit from Home Network
Press [HOME].

Using the Digital Media Controller

You can use a smartphone or tablet as the Digital Media Controller (DMC) to play back contents from DLNA server on the Renderer (this unit).

Possible applications:

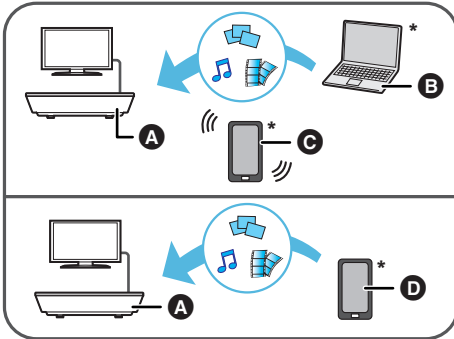

- A** Renderer
- B** Server
- C** Controller
- D** Server + Controller

* DMC compatible software should be installed.

Preparation

Perform steps ① to ③. (⇒ 16)

- ④ Perform the "Remote Device Settings". (⇒ 26)
 - You can register up to 16 devices.

- 1** Press [DLNA].
- 2** Select "Media Renderer".
- 3** Select "Home Network" or "Wi-Fi Direct", then follow the indications on the screen.
- 4** Operate the DMC compatible devices.

To exit from Media Renderer screen

Press [HOME].



For more details, refer to the following website and the operating instructions for each of the equipment.

<http://panasonic.jp/support/global/cs/>
(This site is in English only.)

- Wi-Fi Direct connection while using Home Network feature is only temporary, and the network connection method returns to the original setting when exiting.
- Depending on the contents and the connected equipment, playback may not be possible.
- Items displayed in grey on the display cannot be played back by this unit.
- This unit can be played back via connected equipment only when controlled using DMC.

Playing back USB devices

1 Insert the USB device.

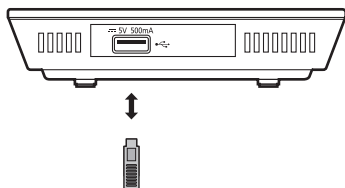

- When inserting a media item, ensure that it is facing the right way.
- If you connect a Panasonic product with a USB connection cable, the setup screen may be displayed on the connected equipment. For details, refer to the instructions for the connected equipment.

2 Select the item to play and press [OK].

Repeat this procedure if necessary.

USB device

Contents format	MKV, MP4, MPEG2, Xvid, JPEG, AAC, FLAC, MP3, WAV, WMA, MST60 MPO
------------------------	---

- USB devices of up to 2 TB can be used.
- This unit does not guarantee connection with all USB devices.
- This unit does not support USB device charging.
- FAT12, FAT16, FAT32, and NTFS file systems are supported.
- This unit supports USB2.0 High Speed.
- This unit can support an HDD formatted to FAT32 and NTFS.
Some types of HDD may require the use of its external power supply unit.

Slideshow

Play a slideshow of photos and adjust various settings during the playback.

Select an item and press the green button.

The following items can be set.

Start Slideshow	Start the slideshow. You can display still pictures in the selected folder one by one at a constant interval.
Interval	Change the display interval.
Transition Effect	Select the effect when sliding pictures.
Repeat Play	Set whether to repeat the slideshow.



- It may not be possible to play the contents in some cases due to the type of media, the condition of the recording, the recording method, and how the files were created.
- MKV/Xvid: Successive play is not possible.
- It is not possible to play back MPEG2 videos which have been dragged and dropped or copied and pasted to the USB device.
- To save on electricity, this unit is turned off automatically if there is no button operation for about 30 minutes when not playing back (such as when paused, displaying the menu, displaying still pictures, etc.).
- Still pictures displayed as "  " cannot be played back with this unit.

Operations during playback

The following functions may not work depending on the content.

Stop

Press [■STOP].

Pause

Press [⏸PAUSE].

- Press [⏸PAUSE] again or [▶PLAY] to restart play.

Search

While playing, press [SEARCH◀◀] or [SEARCH▶▶].

The speed increases up to 5 steps.

- MP3, etc.: The speed is fixed to a single step.
- Press [▶PLAY] to revert to normal playback speed.

Skip

While playing or paused, press [◀◀] or [▶▶]. Skip to the track, etc.

Changing audio

Press [AUDIO].

You can change the audio channel number, etc.

Displaying menus and playback information

Show top menu

Press [TOP MENU].

- Select the item and press [OK].

Show the status messages

While playing, press [STATUS].

The status messages give you information about what is currently being played. Each time you press [STATUS], the display information may change or will disappear from the screen.

- Depending on contents, the display may change or may not appear.

e.g., **MS10** MP4

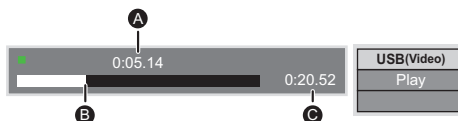

- A** Elapsed time in the title
- B** Current position
- C** Total time

e.g., JPEG

Date	11.12.2007	1 / 26
Size	500 x 375	
Manufacturer		
Equipment		

Enjoying 3D

MST60

By connecting a 3D compatible TV to this unit with a High Speed HDMI cable, you can enjoy Network Service 3D content and 3D photos in USB devices.

Preparation

- Connect this unit to a 3D compatible TV. (⇒ 7)
- Perform the necessary preparations for the TV.
 - Play back following the instructions displayed on the screen.
 - 3D Settings (⇒ 23, 25)



- Please refrain from viewing 3D images if you do not feel well or are experiencing visual fatigue.
In the event that you experience dizziness, nausea, or other discomfort while viewing 3D images, discontinue use and rest your eyes.
- 3D images might not output the way it is set in "HDMI Video Format". (⇒ 24)
- When playing back 3D photos from "Photos" screen, select from the "3D" list. (Still pictures in "2D" are played back in 2D.)
If "2D" and "3D" indications are not displayed, press the red button to switch the view of playback contents.

"HDMI CEC"

This unit supports "HDMI CEC" (Consumer Electronics Control) function.
See the operating instructions for connected equipment for operational details.

Preparation

- ① Set "HDMI CEC" to "On" (⇒ 27). (The default setting is "On".)
- ② Set the "HDMI CEC" operations on the connected equipment (e.g., TV).
- ③ Turn on all "HDMI CEC" compatible equipment and select this unit's input channel on the connected TV so that the "HDMI CEC" function works properly.

Repeat this procedure when the connections or settings are changed.

Automatic input switching Power on link

When you press [HOME], etc. on the remote control, the TV will automatically switch the input channel and the screen of this unit will be displayed.

When the TV is off, the TV will automatically turn on.

Power off link

All connected equipment compatible with "HDMI CEC", including this unit, automatically turns off when you switch the TV off.



- Operation cannot be guaranteed on all HDMI CEC devices.

Multi User Mode

Multi User Mode allows individuals to customize settings and switch to their saved settings easily. Up to 4 people can use the unit with their own settings.

The following settings can be personalized:

- The user icon
- The wallpaper of HOME menu
- The audio and picture settings (⇒ 22, 24)



- A** The user name and icon currently selected
- B** Personalize a new user and switch between users with coloured buttons.

Personalizing a new user

- 1 Press [HOME].
- 2 Press the coloured button that indicates new user personalization.
- 3 Select an item and change the settings according to the indications.

The following items can be set.

Input Nickname	Personalize a user name.
Select Icon	<p>Personalize a user icon.</p> <p>Select from Illustrations The image can be selected from prepared illustrations.</p> <p>Create from Photos You can select a photo in recording media as an icon. (⇒ 22, "Icon Registration")</p>
Select Wallpaper	<p>Personalize a background of the HOME menu.</p> <ul style="list-style-type: none"> • In addition to default wallpapers, you can select a photo in recording media as a wallpaper. (⇒ 22, "Wallpaper")

- 4 Select "Confirm" and press [OK].

To change the personalized user information
Select "Edit User Information" from Setup menu. (⇒ 27)

Switching the user

Press the coloured buttons in the HOME menu to switch to the user corresponding to the button.

Option menu

A variety of playback operations and settings can be performed from this menu.

Available options differ depending on the playing contents and the condition of the unit.

About Multi User Mode

 : Settings of the items with this indication are saved by the respective users registered in the HOME menu.

Please refer to "Multi User Mode" (⇒ 21) for details about user registration and switching.

1 Press [OPTION].

- When playing music, select "Playback Settings" and press [OK].

e.g.,

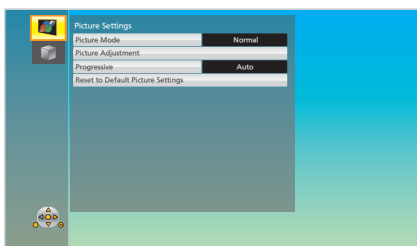

2 Select an item and change the settings.

To exit the screen

Press [OPTION].

Regarding Language : (⇒ 33)

Operation Menu

■ Soundtrack

Show or change the soundtrack.

■ Audio channel

Select the audio channel number.

■ Subtitle

Change the subtitle settings.

■ Repeat Play

Select the item that you want to repeat.

- Select "Off" to cancel.

■ Random

Select whether or not to play random.

■ Start Slideshow

Start the slideshow.

■ Status

Show the status messages.

■ Rotate RIGHT

■ Rotate LEFT

Rotate the still picture.

■ Wallpaper

Set the still picture to the wallpaper of HOME menu. (⇒ 13)

■ Icon Registration

Set the still picture as your user icon. (⇒ 21)

Picture Settings

■ Picture Mode

Select the picture quality mode during play.

- If you select “User”, you can change settings in “Picture Adjustment”.

■ Picture Adjustment

Specific picture quality settings can be changed.

■ Progressive

Select the method of conversion for progressive output to suit the type of material being played.

- If the video is disrupted when “Auto” is selected, select either “Video” or “Film” depending on the material to be played back.

■ Reset to Default Picture Settings

Return picture settings to the factory preset.

MST60

3D Settings

■ Signal Format

Original	Keep original picture format.
Side by side	3D picture format comprising of left and right screens.
2D to 3D	Converts 2D pictures to 3D effect.

■ Distance

Set the amount of depth perception.

■ Graphic Display Level

3D position for the Option menu, etc. can be adjusted during 3D playback.

Setup menu

Change the unit's settings if necessary. The settings remain intact even if you switch the unit to standby. Some items in the Setup menu are common to the Option menu. You can get the same effect with both menus.

About Multi User Mode

 : Settings of the items with this indication are saved by the respective users registered in the HOME menu.

Please refer to "Multi User Mode" (⇒ 21) for details about user registration and switching.

1 While displaying the HOME menu, press [SETTINGS].

e.g., **MST60**



2 Select an item and change the settings.

To exit the screen

Press [HOME].

Picture

■ Picture Mode (⇒ 23)

■ Picture Adjustment (⇒ 23)

■ HDMI Output

Press [OK] to show the following settings:

➤ HDMI Video Format

The items supported by the connected devices are indicated on the screen as "*". When any item without "*" is selected, the images may be distorted.

- If "Automatic" is selected, the best suited output resolution to the connected TV is automatically selected.
- To enjoy high-definition video up-converted to 1080p, you need to connect the unit directly to 1080p compatible HDTV (High Definition TV). If this unit is connected to an HDTV through other equipment, the other equipment must also be 1080p compatible.

MST60

➤ HDMI Colour Mode

This setting is for selecting colour-space conversion of the image signal.

➤ Deep Colour Output

This setting is for selecting whether to use Deep Colour output when a TV that supports Deep Colour is connected.

➤ Contents Type Flag

Depending on the playback content, the TV will output adjusting to the optimal method when a TV that supports this function is connected.

Sound

■ Dynamic Range Compression

You can listen at low volumes but still hear dialog clearly.

(Dolby® Digital and Dolby® Digital Plus only)

■ Digital Audio Output

Press [OK] to show the following settings:

➤ Dolby D/Dolby D +

➤ DTS

Select the audio signal to output.

- Select "PCM", when the connected equipment cannot decode the respective audio format. This unit decodes the audio format and transmits to the connected equipment.
- Not making the proper settings may result in noise.

■ Downmix

Select the downmix system of multi-channel to 2-channel sound.

- Select "Surround encoded", when the connected equipment supports the virtual surround function.
- The downmix effect is not available when "Digital Audio Output" is set to "Bitstream".

MST60

3D

■ 3D Playback Message

Set to display or hide the 3D viewing warning screen when playing back 3D images.

■ Graphic Display Level (⇒ 23)

Language

■ Subtitle Text

Select a suitable item according to the language used for MKV/Xvid subtitles text.

- This item is displayed only after playing back a file.

■ On-Screen Language

Choose the language for menus and on-screen messages.

Network

■ Easy Network Setting (⇒ 10)

■ Network Settings

Perform network-related settings individually. Press [OK] to show the following settings:

➤ LAN Connection Mode

Select the LAN connection method.

- Select "Wireless Master" when you make a direct wireless connection between this unit and a Home Network device. Internet connection is not available when this item is selected.

➤ Wireless Settings

This allows the wireless router and connection settings to be set. Current connection settings and connection state can be checked.

Press [OK] to show the following settings:

Connection Setting

The wireless router connection wizard will be displayed.

Double Speed Mode Setting (2.4GHz)

Set the connection speed for a 2.4 GHz wireless format.

- If you connect using the "Double Speed Mode (40MHz)", 2 channels use the same frequency band, and there is consequently a greater risk of reception interference. This can cause the connection speed to drop or become unstable.

➤ IP Address / DNS Settings

This is for checking the state of the network connection and setting the IP address and DNS-related.

Press [OK] to show the respective setting.

➤ Proxy Server Settings

This is for checking the state of connection with the Proxy server and performing settings.

Press [OK] to show the respective setting.

➤ Network Service Settings (⇒ 14)

Press [OK] to show the following settings:

Time Zone

Set the unit's time to match your location.

- Some Network Service contents require the time zone to be set. Set the time zone if necessary.

Summer Time

Select "On" when using summer time.

➤ Network Drive Connection

It is possible to access the shared folder of equipment not compatible with DLNA, such as the Windows XP operating system, and play back video, still pictures, and music on this unit. For the setting and operation method of connected equipment, refer to the following website.

<http://panasonic.jp/support/global/cs/>

(This site is in English only.)

➤ Remote Device Settings (⇒ 17)

Press [OK] to show the following settings:

Remote Device Operation

Enable to operate by DMC.

- If "On" is selected, "Quick Start" will be activated.

Device Name Entry

Set the name of this unit to be displayed on the connected equipment.

Registration Type

Automatic	Allow connection to all the equipment accessing this unit.
Manual	Set the permission for individual equipment connections accessing this unit.

Remote Device List

Registering/deregistering of the displayed equipment can be performed when "Manual" in "Registration Type" is selected.

Ratings

The following item uses the password.
Don't forget your password.

■ Network Service Lock

You can restrict the usage of Network Service.

System

■ Easy Settings

You can execute basic settings.



■ TV Settings

Press [OK] to show the following settings:

➤ TV Aspect

Set to match the type of TV connected.

When connected to a 4:3 aspect TV and playing 16:9 ratio image:

4:3 Pan & Scan	The sides are cut off so the picture fills the screen.	
4:3 Letterbox	Black bands appear at the top and bottom of the picture.	

When connected to a 16:9 widescreen TV and playing 4:3 ratio image:

16:9	Video is displayed as a 4:3 ratio image in the centre of the screen.
16:9 full	Video is displayed as a horizontally stretched 16:9 image.

➤ TV System

Perform the setup so it matches the TV System of the connected TV.

➤ Screen Saver Function

This is to prevent image retention on the screen.

- When this is set to “On”:
If a list of playback content is displayed and there is no operation for 10 minutes or more, the screen switches to HOME menu automatically.
- While playing and pausing, etc., this function is not available.

➤ On-Screen Messages

Choose whether to show status messages automatically.

➤ HDMI CEC

Set to use “HDMI CEC” function when connected to a device that supports “HDMI CEC”.

- Select “Off” when you do not want to use “HDMI CEC”.

■ Edit User Information

Change the user information registered in the HOME menu.

■ Start-up Banner

Select whether to display the banner after turning on this unit. (⇒ 13)

■ Quick Start

Speed of start-up from standby mode is increased.

- When set to “On”, the internal control unit will be powered and the idle power consumption will increase so compared to when set to “Off”.
(About the power consumption ⇒ 32)

■ Remote Control

Change the remote control code if other Panasonic products react to this remote control.

■ Firmware Update (⇒ 12)

Press [OK] to show the following settings:

➤ Automatic Update Check

When this equipment remains connected to the Internet, it will check for the latest firmware version when it is turned on and you can update it if necessary.

➤ Update Now

You can update the firmware manually if a firmware update is available.

■ System Information

Press [OK] to show the following settings:

➤ Software Licence

Information about the software used by this unit is displayed.

➤ Firmware Version Information

Display firmware version of this unit and wireless LAN module.

■ Default Settings

This returns all values in the Setup menu and the Option menu to the default settings, except for some settings of network, ratings, remote control code, language, etc.

LED indicators

Error states are indicated by the INFO LED. Confirm the following items in correspondence to the state of INFO LED of this unit.

- If the state of the INFO LED does not change after performing the operations in the table below, contact your local Panasonic dealer.

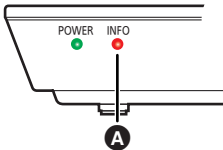

A INFO LED

INFO LED state	Description
Flashes 6 times	The remote control and this unit are using different codes. Turn on this unit by using the standby/on switch on this unit, and check "Remote control □", which is displayed on the screen when you press a button on the remote control. Press and hold [OK] and the displayed number ("□") for more than 5 seconds.
Lights up	The USB device is drawing too much power. Please disconnect or remove the USB device from the unit. The USB device may be incompatible.

Messages

Check the following when message are displayed on the screen.

Cannot play.

- An attempt was made to play back incompatible content.

Cannot play on this unit.

- You tried to play a non-compatible image.

⊘ This operation is not available.

- Some operations are unsupported by the unit.

IP address is not set.

- The "IP Address" in "IP Address / DNS Settings" is "----. ---. ---. ---". Set the "IP Address", "Subnet Mask", and "Gateway Address". (Select the automatic address acquisition if necessary.)

The wireless access point currently has a low network security setting. It is recommended to change to a higher setting.

- Set a stronger network security level referring to the wireless router operating instructions.

Troubleshooting guide

Before requesting service, please perform the following checks.

If the problem remains unresolved, consult your dealer for instructions.

Do you have the latest firmware installed?

Panasonic is constantly improving the unit's firmware to ensure that our customers are enjoying the latest technology. (⇒ 12)

The following do not indicate a problem with this unit:

- Image disturbance during search.

■ Unit does not respond to remote control or the unit's button.

Disconnect the AC adaptor, wait 1 minute, then reconnect the AC adaptor.

General operation

To return to the factory preset.

- Select "Yes" in "Default Settings" in the Setup menu. (⇒ 27)

To return all settings to the factory preset.

- Reset the unit as follows:
 - ① Turn the unit on.
 - ② Press and hold [OK], the yellow button and the blue button on the remote control at the same time for more than 5 seconds.
 - INFO LED and POWER LED start to flash, and "00RET" is displayed on the screen.
 - ③ Press [▶] (right) repeatedly on the remote control until "08FIN" is displayed on the screen.
 - ④ Press and hold [OK] for more than 5 seconds.

The remote control does not work properly.

- Change the batteries in the remote control. [Refer to "Accessories" in "Operating Instructions (Essential Information)"]
- The remote control and this unit are using different codes. Turn on this unit by using the standby/on switch on this unit, and check "Remote control □", which is displayed on the screen when you press a button on the remote control. Press and hold [OK] and the displayed number ("□") for more than 5 seconds.

The TV tuner mode is not displayed when the TV is switched on.

- This phenomenon may occur, depending on the TV setting, when "Quick Start" is set to "On".
- Depending on the TV, this phenomenon may be prevented by reconnecting the HDMI cable to a different HDMI input terminal or by changing the HDMI auto connection setting.

**You have forgotten your ratings password.
You want to cancel the ratings level.**

- The ratings level returns to the factory preset.
- ① Turn the unit on.
- ② Press and hold [OK], the yellow button and the blue button on the remote control at the same time for more than 5 seconds.
 - INFO LED and POWER LED start to flash, and "00RET" is displayed on the screen.
- ③ Press [▶] (right) repeatedly on the remote control until "03 VL" is displayed on the screen.
- ④ Press [OK].

This unit does not recognize the USB connection correctly.

- Disconnect and reconnect the USB cable. If it still does not recognize the connection, turn this unit off and on again.
- USB devices may not be recognized by this unit when connected using the following:
 - a USB hub
 - a USB extension cable
- If you connect USB HDD to this unit, use the USB cable that is supplied with the HDD.

The unit switches to standby mode.

- This unit will automatically turn to standby mode after 30 minutes if it is inactive.

Picture

The images from this unit do not appear on the TV.

Picture is distorted.

- An incorrect resolution is selected in "HDMI Video Format". Reset the setting as follows:
 - ① Turn the unit on.
 - ② Press and hold [OK], the yellow button and the blue button on the remote control at the same time for more than 5 seconds.
 - INFO LED and POWER LED start to flash.
 - ③ Press and hold [8] and the blue button on the remote control at the same time for more than 5 seconds.
 - Set the item again. (⇒ 24)
 - When Dolby Digital Plus audio is not output properly, select "Yes" in "Default Settings" and make proper settings. (⇒ 27)
- The unit and TV are using different video systems.
 - ① Turn the unit on.
 - ② Press and hold [OK], the yellow button and the blue button on the remote control at the same time for more than 5 seconds.
 - INFO LED and POWER LED start to flash, and "00RET" is displayed on the screen.
 - ③ Press [▶] (right) repeatedly on the remote control until "05P/N" is displayed on the screen.
 - ④ Press and hold [OK] for more than 5 seconds. The system switches from PAL to NTSC or vice versa.

Video is not output in high-definition.

- Confirm that "HDMI Video Format" in the Setup menu is set properly. (⇒ 24)

3D image is not output.

- Is there a non-3D compatible amplifier/receiver connected between this unit and a TV? (⇒ 8)
- Are the settings on this unit and the TV correct? (⇒ 20)
- Is the amplifier/receiver that is connected between this unit and TV on?

A black band is displayed around the edge of the screen.

The aspect ratio of the screen is abnormal.

- Confirm the "TV Aspect" is set properly. (⇒ 27)
- Adjust the aspect setting on the TV.

Audio

Cannot hear the desired audio type.

- Check the connections and the “Digital Audio Output” settings. (⇒ 8, 25)

Playback

Still pictures (JPEG) do not play back normally.

- The images that were edited on the PC, such as Progressive JPEG, etc., may not be played back.

Network

I can't connect to the network.

- Confirm the network connection and settings. (⇒ 8, 10, 25)
- There may be obstacles that prevent the unit from detecting your home network. Bring the unit and the wireless router closer to each other. This unit may be able to detect your network name (⇒ 11, “SSID”).
- Check the operating instructions for each device and connect accordingly.

Cannot play current title.

- Confirm the network connection and settings. (⇒ 8, 10, 25)

When using wireless LAN connection, video from the DLNA Certified media server is not played back or video frames are dropped during playback.

- Higher transfer rate router such as 802.11n (2.4 GHz or 5 GHz) wireless router may solve the problem. If you use 802.11n (2.4 GHz or 5 GHz) wireless router, it is necessary to set the encryption type to “AES”. Simultaneous use with a microwave, cordless telephone etc. at 2.4 GHz may result in connection interruptions or other problems.
- On the “Wireless Settings” screen (⇒ 25), the continuous lighting of at least 4 “Reception” indicators is the target for a stable connection. If 3 or fewer indicators are lit or the connection is being interrupted, change the position or angle of your wireless router and see if the connection state improves. If there is no improvement, connect to a wired network and perform the “Easy Network Setting” (⇒ 10) again.

Specifications

General

Signal system	PAL/NTSC
Operating temperature range	+5 °C to +35 °C
Operating humidity range	10 % to 80 % RH (no condensation)
HDMI AV output	Output connector: Type A (19 pin) 1 system
USB slot	USB2.0 1 system
Ethernet	10BASE-T/100BASE-TX 1 system
Wireless LAN	Standard Compliance: IEEE802.11 n/g/b/a
	Frequency range: 2.4 GHz/5 GHz band
	Security: WPA™/WPA2™ (Encryption Type: TKIP/AES, Authentication Type: PSK), WEP (64 bit/128 bit)
Power supply	DC 12 V (DC IN terminal)
Power consumption*	MST60 Approx. 9 W MS10 Approx. 7 W
Power consumption in standby mode*	MST60 Approx. 0.5 W MS10 Approx. 0.4 W
Power consumption in quick start standby mode*	MST60 Approx. 5 W MS10 Approx. 3 W
AC Adaptor	Power source: 100 V to 240 V, 50/60 Hz, 0.6 A DC output: DC 12 V 2 A
Dimensions (W×H×D)	126 mm×29 mm×126 mm
Mass	MST60 Approx. 200 g MS10 Approx. 190 g

* Using supplied AC adaptor

● Specifications are subject to change without notice.

File format

File format	Extension	Reference
MP3	“.MP3”, “.mp3”	This unit supports ID3 tags, but only titles, artist names and album names can be displayed.
JPEG	“.JPG”, “.jpg”	<ul style="list-style-type: none"> ● MOTION JPEG and Progressive JPEG are not supported. ● You may not be able to play back the file if you have edited the folder structure or the file name on a PC or other device.
MKV	“.MKV”, “.mkv”	<ul style="list-style-type: none"> ● The video file and subtitles text file are inside the same folder, and the file names are the same except for the file extensions. ● Some MKV/Xvid files may not play back, depending on the video resolution and frame rate condition.
	Subtitles text file “.SRT”, “.srt”, “.SSA”, “.ssa”, “.ASS”, “.ass”	
Xvid	“.AVI”, “.avi”	<ul style="list-style-type: none"> ● The video file and subtitles text file are inside the same folder, and the file names are the same except for the file extensions. ● Some MKV/Xvid files may not play back, depending on the video resolution and frame rate condition.
	Subtitles text file “.SRT”, “.srt”, “.SUB”, “.sub”, “.TXT”, “.txt”	
FLAC	“.FLAC”, “.flac”	Maximum sampling rate: 192 kHz/24 bit
WAV	“.WAV”, “.wav”	Maximum sampling rate: 192 kHz/24 bit
MPO	“.MPO”, “.mpo”	3D still picture
AAC	“.M4A”, “.m4a”, “.AAC”, “.aac”	This unit supports ID3 tags. Maximum sampling rate: 48 kHz/320 kbps
WMA	“.WMA”, “.wma”	This unit supports ID3 tags. Maximum sampling rate: 48 kHz/355 kbps

● With certain recording states and folder structures, the play order may differ or playback may not be possible.

Audio information

The audio output differs depending on the settings on the unit. (⇒ 25, “Digital Audio Output”)

- The number of channels listed is the maximum possible number of output channels when connected to amplifier/receiver compatible with the respective audio format.

	“Digital Audio Output”	
	“Bitstream”	“PCM”
Output channel	Outputs using original audio	2ch PCM*

* [MST60]: The maximum possible number of Dolby sound is 5.1ch PCM.

Display languages list

Display Language	Display Language	Display Language
ENG English	JPN Japanese	ARA Arabic
FRA French	CHI Chinese	HIN Hindi
DEU German	KOR Korean	PER Persian
ITA Italian	MAL Malay	IND Indonesian
ESP Spanish	VIE Vietnamese	MRI Maori
NLD Dutch	THA Thai	BUL Bulgarian
SVE Swedish	POL Polish	RUM Romanian
NOR Norwegian	CES Czech	GRE Greek
DAN Danish	SLK Slovak	TUR Turkish
POR Portuguese	HUN Hungarian	* Others
RUS Russian	FIN Finnish	

Supported format for DLNA

- File formats that are not supported by your DLNA server cannot be played.

Video

Container	Video codec	Audio codec	Example of file extension
AVCHD	H.264	Dolby Digital	.mts
MP4	H.264	AAC	.mp4
PS	MPEG2	Dolby Digital Linear PCM	.mpg .mpeg
TS	MPEG2 H.264	AAC Dolby Digital	.m2ts .ts

Photo

Format	Example of file extension
JPEG	.jpg

Audio

Audio codec	Example of file extension
MP3	.mp3
FLAC	.flac
AAC	.m4a
WMA	.wma
Linear PCM	—

Manufactured by: Panasonic Corporation Kadoma, Osaka, Japan
Importer: Panasonic Marketing Europe GmbH
Panasonic Testing Centre
Winsbergring 15, 22525 Hamburg, Germany

Panasonic Corporation
Web Site: <http://panasonic.net>

