

Panasonic[®]

Model No.
TX-P42G30B
TX-P50G30B

Operating Instructions Plasma Television

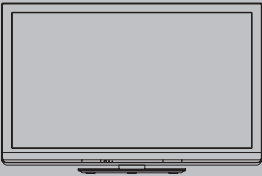

VIERA

Thank you for purchasing this Panasonic product.
Please read these instructions carefully before operating this
product and retain them for future reference.
The images shown in this manual are for illustrative purposes only.

English UK and Ireland model



TQB0E2122

Features

DVB-T tuner built-in

Receives DVB (Digital Video Broadcasting) digital terrestrial broadcasts.

DVB-T2 tuner built-in **UK only**

DVB-T2 is an advanced digital terrestrial system for more efficient transmission.

Available DVB-T2 broadcasts will be tuned automatically when you perform DVB Auto Setup.

GUIDE Plus+ (p. 21) **UK only**

This TV supports the TV Guide services sent from the GUIDE Plus+ system.

Sharp pictures and clear sound with HDMI connection (p. 97)

Enjoy high definition digital picture and high quality sound by using an HDMI cable.

• This TV supports HDMI (Version 1.4 with Content Type, Audio Return Channel), Deep Colour, x.v.Colour™.

Using USB devices

Enjoy recording and playback the digital TV programmes to the USB HDD. (p. 55, 67)

Enjoy the photo, video and music in the USB Flash Memory on Media Player. (p. 59)

Wireless LAN Adaptor for the network connection. (p. 6, 11, 13)

USB keyboard, gamepad, etc. are available. (p. 98)

Timer Programming (p. 22, 45)

Timer Programming enables you to use functions such as programme reminder and programme recording to the external recorder / formatted USB HDD.

VIERA IMAGE VIEWER - SD Card viewer in Media Player (p. 59)

Enjoy your photos or videos recorded on an SD Card on the TV screen.

SDXC Card

This TV supports SDXC Card. SDXC is the latest standard of SD Card and a higher storage capacity card.

DLNA

DLNA is a standard that makes digital electronics easier and more convenient to use on a home network. For example, you can enjoy watching photos and videos stored in the PC connected to your home network by accessing from the TV. (p. 78)

VIERA Connect - Enjoy great web entertainment (p. 16, 81)

Enjoy the internet contents on the TV such as photos, videos, weather, video communication (ex. Skype™), etc. through an easy-to-use web interface that is built into the TV.

Link up and control the connected equipment with “Q-Link” and “VIERA Link” (p. 82)

Q-Link and VIERA Link provide easy recording and playback, creation of a home theatre without complicated settings, etc.

VIERA TOOLS - Display special feature icons for easy accessibility (p. 29)

Special features (such as VIERA Link and Media Player) can be accessed easily by using the VIERA TOOLS button.

Dolby Digital Plus / Dolby Pulse decoders

It is possible to decode Dolby Digital Plus / Dolby Pulse multi-channel audio tracks and output as Dolby Digital Bitstream (multi-channel sound signal) from DIGITAL AUDIO OUT / HDMI2 (ARC function) terminals.

Owner ID (p. 50)

Owner ID is an anti-theft function. Entering the PIN number and owner's personal information will help the Police to determine the owner in the case of theft.

Supports Audio Description signal (p. 18, 33) **UK only**

Audio Description (when broadcast) adds an additional soundtrack to describe events on screen (narration) and aids understanding and enjoyment, particularly for visually-impaired viewers.

You can switch Audio Description service Auto or Off, and adjust the volume of the description soundtrack independently of the main volume.

Digital Switchover for Terrestrial broadcasts **UK only**

Starting in late 2007 and ending in 2012, TV services in the UK will go completely digital, TV region by TV region.

If you have any questions, please call Digital UK on **08456 50 50 50** or visit **www.digitaluk.co.uk**

Digital Switchover will cover a period of several weeks. When it starts you will lose all Analogue TV channels and some Digital TV channels will be missing.

You will need to retune your TV each time this happens to recover your digital channels. Analogue channels are permanently turned off, it will not be possible to recover them.

• To retune your TV ➔ [Auto Setup] in [DVB Tuning Menu]-DVB mode (p. 40)

Users of cable or satellite boxes should still retune the TV to continue to receive Freeview channels via their aerial. (Your Analogue channel for viewing Cable or Satellite services will change to a new position.)

• Due to the digital reception technologies involved, quality of the digital signals may be relatively low in some cases, despite good reception of analogue channels.

Contents

Do not display a still picture for a long time

This causes the image to remain on the plasma screen ("image retention"). This is not considered a malfunction and is not covered by the warranty.

Typical still images

- Channel number and other logos
- Image displayed in 4:3 mode



- Video game
- Computer image

To prevent image retention, contrast is lowered automatically after a few minutes if no signals are sent or no operations are performed. (p. 100)

The recording and playback of content on this or any other device may require permission from the owner of the copyright or other such rights in that content. Panasonic has no authority to and does not grant you that permission and explicitly disclaims any right, ability or intention to obtain such permission on your behalf. It is your responsibility to ensure that your use of this or any other device complies with applicable copyright legislation in your country. Please refer to that legislation for more information on the relevant laws and regulations involved or contact the owner of the rights in the content you wish to record or playback.

This product is licensed under the AVC patent portfolio license for the personal and non-commercial use of a consumer to (i) encode video in compliance with the AVC Standard ("AVC Video") and/or (ii) decode AVC Video that was encoded by a consumer engaged in a personal and non-commercial activity and/or was obtained from a video provider licensed to provide AVC Video. No license is granted or shall be implied for any other use. Additional information may be obtained from MPEG LA, LLC. See <http://www.mpegla.com>.

ROVI CORPORATION AND/OR ITS RELATED AFFILIATES ARE NOT IN ANY WAY LIABLE FOR THE ACCURACY OF THE PROGRAM SCHEDULE INFORMATION PROVIDED BY THE GUIDE PLUS+ SYSTEM. IN NO EVENT SHALL ROVI CORPORATION AND/OR ITS RELATED AFFILIATES BE LIABLE FOR ANY AMOUNTS REPRESENTING LOSS OF PROFITS, LOSS OF BUSINESS, OR INDIRECT, SPECIAL, OR CONSEQUENTIAL DAMAGES IN CONNECTION WITH THE PROVISION OR USE OF ANY INFORMATION, EQUIPMENT, OR SERVICES RELATING TO THE GUIDE PLUS+ SYSTEM.

<http://www.europe.guideplus.com/>

Notice for DVB / Data broadcasting / IPTV functions

This TV is designed to meet the standards (as of August, 2009) of digital services.

- The compatibility with future services is not guaranteed.
- Check the latest information on the available services at the following website.

<http://panasonic.jp/support/global/cs/tv/>

Be Sure to Read

Safety Precautions	4
--------------------------	---

Quick Start Guide

Accessories / Options	6
Identifying Controls	8
Basic Connection	10
Auto Setup	12

Enjoy your TV!

Basic Features

Using "VIERA Connect"	16
Watching TV	17
Using TV Guide	21
Viewing Teletext	24
Watching External Inputs	27
How to Use VIERA TOOLS	29
How to Use Menu Functions	30

Advanced Features

Retuning from Setup Menu	40
Tuning and Editing Channels	41
Timer Programming	45
Child Lock	47
Input Labels	48
Shipping Condition	49
Owner ID	50
Using Common Interface	51
Updating the TV Software	52
Advanced Picture Setting	53
USB HDD Recording	55
Using Media Player	59
Using Network Services (DLNA / VIERA Connect) ..	71
Link Functions (Q-Link / VIERA Link)	82
External Equipment	90

FAQs, etc.

Technical Information	93
FAQs	100
On screen messages	102
Glossary	104
Maintenance	104
Index	105
Specifications	106
Licence	107

Safety Precautions

Warning

■ Mains plug and lead

To help avoid risk of electrical shock, fire, damage or injury, please follow the warnings below:

- This TV is designed to operate on AC 220-240 V, 50 / 60 Hz.
- Insert the mains plug fully into the socket outlet.
- Ensure that the mains plug is easily accessible.
- Remove the mains plug when cleaning the TV.

- Do not touch the mains plug with a wet hand.



- Do not damage the mains lead.

- Do not place a heavy object on the lead.



- Do not place the lead near a high temperature object.



- Do not pull on the lead. Hold onto the mains plug body when disconnecting the plug.

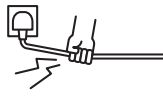

- Do not move the TV with the lead plugged into a socket outlet.
- Do not twist the lead, bend it excessively or stretch it.
- Do not use a damaged mains plug or socket outlet.
- Ensure the TV does not crush the mains lead.
- Ensure the earth pin on the mains plug is securely connected to prevent electrical shock.
- An apparatus with CLASS I construction shall be connected to a mains socket outlet with a protective earthing connection.

If you detect anything unusual, immediately switch off the mains supply switch and remove the mains plug.

AC 220-240 V
50 / 60 Hz

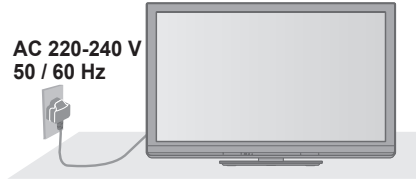

IMPORTANT: THE MOULDED MAINS PLUG

FOR YOUR SAFETY, PLEASE READ THE FOLLOWING TEXT CAREFULLY.

This TV is supplied with a moulded three pin mains plug for your safety and convenience. A 10 amp fuse is fitted in this mains plug. Shall the fuse need to be replaced, please ensure that the replacement fuse has a rating of 10 amps and that it is approved by ASTA or BSI to BS1362.

Check for the ASTA mark  or the BSI mark  on the body of the fuse.

If the mains plug contains a removable fuse cover, you must ensure that it is refitted when the fuse is replaced.

If you lose the fuse cover the mains plug must not be used until a replacement cover is obtained.

A replacement fuse cover may be purchased from your local dealer.

Do not cut off the mains plug.

Do not use any other type of mains lead except the one supplied with this TV.

The supplied mains lead and moulded plug are designed to be used with this TV to avoid interference and for your safety.

If the socket outlet in your home is not suitable, get it changed by a qualified electrician.

If the plug or mains lead becomes damaged, purchase a replacement from an authorized dealer.

WARNING: – THIS TV MUST BE EARTHED.

How to replace the fuse.

Open the fuse compartment with a screwdriver and replace the fuse.

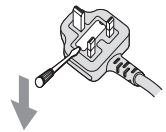

Warning

Take care

To help avoid risk of electrical shock, fire, damage or injury, please follow the warnings below:

- Do not remove covers and never modify the TV yourself as live parts are accessible when they are removed. There are no user serviceable parts inside.

- Do not expose the TV to rain or excessive moisture. This TV must not be exposed to dripping or splashing water and objects filled with liquid, such as vases, must not be placed on top of or above the TV.

- Do not expose the TV to direct sunlight and other sources of heat. To prevent fire never place any type of candle or naked flame on top or near the TV.

- Do not place the TV on sloped or unstable surfaces, and ensure that the TV does not hang over the edge of the base.

- Do not insert foreign objects into the TV through the air vents.
- Do not use an unapproved pedestal / mounting equipment. Be sure to ask your local Panasonic dealer to perform the setup or installation of approved wall-hanging brackets.
- Do not apply strong force or impact to the display panel.



To prevent the spread of fire, keep candles or other open flames away from this product at all times



Small object

This product contains possibly dangerous parts that can be breathed in or swallowed by young children accidentally.

- Keep the dangerous parts out of reach of young children.
- Do not allow children to handle SD Card. As with any small object, the SD Card could be swallowed by young children. Please remove SD Card immediately after use and store out of reach of young children.



Caution

Ventilation

Allow sufficient space around the TV in order to help prevent excessive heat, which could lead to early failure of some electronic components.

- Ventilation should not be impeded by covering the ventilation openings with items such as newspapers, tablecloths and curtains.
- Whether you are using the pedestal or not, always ensure the vents in the bottom of the TV are not blocked and there is sufficient space to enable adequate ventilation.



Minimum distance

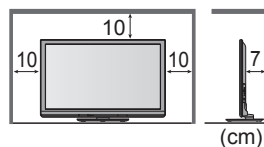

Moving the TV

Before moving the TV, disconnect all cables.

- The TV is heavy. Move the TV with at least two people. Support as shown to avoid injury by the TV tipping or falling.
- Transport only in upright position. Transporting the TV with its display panel facing upward or downward may cause damage to the internal circuitry.

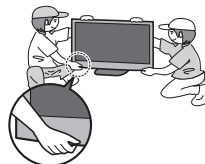

When not in use for a long time

This TV will still consume some power even in the Off mode, as long as the mains plug is still connected to a live socket outlet.

- Remove the mains plug from the wall socket when the TV is not in use for a prolonged period of time.

Excessive volume

Do not expose your ears to excessive volume from the headphones. Irreversible damage can be caused.



Accessories / Options

Standard accessories

Remote Control

- N2QAYB000490
or
• N2QAYB000672



Batteries for the Remote Control (2)

- R6



Pedestal → (p. 7)

- TX-P42G30B :
 - TBL5ZX0065
 - TXFBL5Z0007
 - TXFBL5Z0040
- TX-P50G30B :
 - TBL5ZX0069
 - TXFBL5Z0009
 - TXFBL5Z0041

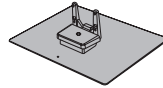

Operating Instructions

Product Registration Leaflet

Mains Lead → (p. 10)



Ferrite core (2) → (p. 11, 91)

- J0KG00000014



Use the Ferrite cores to comply with the EMC standard.

- Accessories may not be placed all together. Take care not to throw them away unintentionally.

Optional accessories

Please contact your nearest Panasonic dealer to purchase the recommended optional accessories. For additional details, please refer to the manual of the optional accessories.

Wireless LAN Adaptor

- DY-WL10E-K



Caution

- To use the Wireless LAN Adaptor, an access point needs to be obtained.
- It is recommended to use the Wireless LAN Adaptor with the extension cable.
- To avoid malfunctions caused by radio wave interference, keep the TV away from the devices such as other wireless LAN devices, microwaves and the devices that use 2.4 GHz and 5 GHz signals when using the Wireless LAN Adaptor.
- Depending on the area, this optional accessory may not be available.
- Additional information for Wireless LAN Adaptor and access point may be on the following website.
<http://panasonic.jp/support/global/cs/tv/>

Communication Camera

- TY-CC10W



Caution

- This camera can be used on VIERA Connect (p. 16, 81).
- Please also read the manual of the camera.
- Depending on the area, this optional accessory may not be available.
For details, consult your local Panasonic dealer.

Wall-hanging bracket

- TY-WK4P1RW

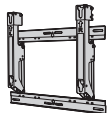

Rear of the TV

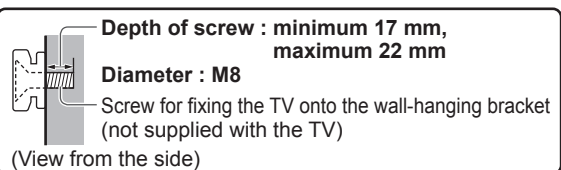
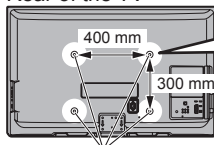

Holes for wall-hanging bracket installation

Warning

- Using other wall-hanging brackets, or installing a wall-hanging bracket by yourself has the risk of personal injury and product damage. In order to maintain the unit's performance and safety, be sure to ask your dealer or a licensed contractor to secure the wall-hanging brackets. Any damage caused by installing without a qualified installer will void your warranty.
- Carefully read the instructions accompanying optional accessories, and be sure to take steps to prevent the TV from falling off.
- Handle the TV carefully during installation since subjecting it to impact or other forces may cause product damage which will void your warranty.
- Do not mount the unit directly below ceiling lights (such as spotlights or halogen lights) which typically give off high heat. Doing so may warp or damage plastic cabinet parts.
- Take care when fixing wall brackets to the wall. Wall mounted equipment must not be grounded by metal within the wall. Always ensure that there are no electrical cables or pipes in the wall before hanging bracket.
- To prevent fall and injury, remove the TV from its fixed wall position when it is no longer in use for an extended period of time.

Attaching the pedestal







To help avoid risk of damage or injury by the TV tipping or falling, please follow the warnings and cautions below:

Warning

- Do not disassemble or modify the pedestal.

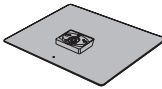
Caution

- Do not use any pedestal other than the one provided with this TV.
- Do not use the pedestal if it becomes warped or physically damaged. If this occurs, contact your nearest Panasonic dealer immediately.
- During setup, make sure that all screws are securely tightened.
- Ensure that the TV does not suffer any impact during installation of the pedestal.
- Ensure that children do not climb onto the pedestal.
- Install or remove the TV from the pedestal with at least two people.

<p>(A) Assembly screw (4) (silver) • XYN5+F20FN  M5 × 20</p>	<p>(C) Assembly screw (4) (black) • XSB4+8FNK  M4 × 8</p>	<p>(E) Base • TBL5ZX0065 (TX-P42G30B) • TBL5ZX0069 (TX-P50G30B) </p>
<p>(B) Assembly screw (4) (black) • THEL087N (TX-P42G30B) • THEL088N (TX-P50G30B)  M5 × 25</p>	<p>(D) Pole • TBL5ZA3055 (TX-P42G30B) • TBL5ZA3065 (TX-P50G30B) </p>	<p>(F) Cover • TBL5ZB3094-1 (TX-P42G30B) • TBL5ZB3095-1 (TX-P50G30B) </p>

1 Assembling the pedestal

- Use the assembly screws (A) to fasten the pole (D) to the base (E) securely.
- Make sure that the screws are securely tightened.
 - Forcing the assembly screws the wrong way will strip the threads.

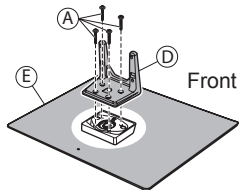

Attach the cover (F) with assembly screw (C)

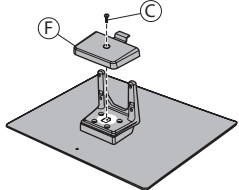

2 Securing the TV

- Use the assembly screws (B) to fasten securely.
- Tighten the four assembly screws loosely at first, then tighten them firmly to fix securely.
 - Carry out the work on a horizontal and level surface.

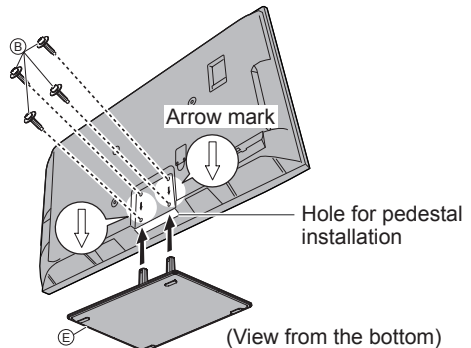

Removing the pedestal from the TV

Be sure to remove the pedestal in the following way when using the wall-hanging bracket or repacking the TV.

- Remove the assembly screws (B) from the TV.
- Pull out the pedestal from the TV.
- Remove the assembly screw (C) from the cover.
- Pull out the cover.
- Remove the assembly screws (A) from the pole.

Adjusting the panel to your desired angle

- Do not place any objects within the full rotation range.

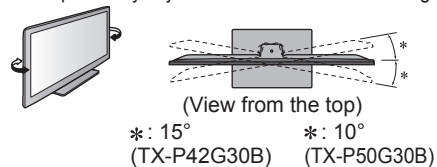

Identifying Controls

Remote Control

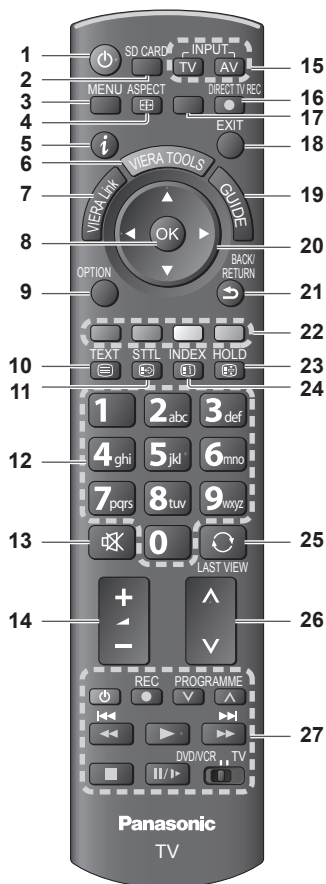

- 1 Standby On / Off switch**
 - Switches TV On or Off standby
- 2 [Media Player] ➔ (p. 59)**
 - Switches to SD Card and USB device viewing / listening mode
- 3 [Main Menu] ➔ (p. 30)**
 - Press to access Picture, Sound, Timer and Setup Menus
- 4 Aspect ➔ (p. 20)**
 - Changes aspect ratio
- 5 Information ➔ (p. 17)**
 - Displays channel and programme information
- 6 VIERA TOOLS ➔ (p. 29)**
 - Displays some special feature icons and accesses easily
- 7 [VIERA Link Menu] ➔ (p. 86)**
- 8 OK**
 - Confirms selections and choices
 - Press after selecting channel positions to quickly change channel
 - Displays the Channel List
- 9 [Option Menu] ➔ (p. 19)**
 - Easy optional setting for viewing, sound, etc.
- 10 Teletext ➔ (p. 24)**
 - Switches to teletext mode
- 11 Subtitles ➔ (p. 20)**
 - Displays subtitles
- 12 Numeric buttons**
 - Changes channel and teletext pages
 - Sets characters
 - When in Standby mode, switches TV On (Press for about 1 second)
- 13 Sound Mute**
 - Switches sound mute On or Off
- 14 Volume Up / Down**

- 15 Input mode selection**
 - TV - switches between DVB and Analogue modes ➔ (p. 17)
 - AV - switches to AV input mode from Input Selection list ➔ (p. 27)
- 16 Direct TV Recording ➔ (p. 84, 86)**
 - Records programme immediately in DVD Recorder / VCR with Q-Link or VIERA Link connection
- 17 [VIERA Connect] ➔ (p. 16, 81)**
 - Displays VIERA Connect home screen
- 18 Exit**
 - Returns to the normal viewing screen
- 19 TV Guide ➔ (p. 21)**
- 20 Cursor buttons**
 - Makes selections and adjustments
- 21 Return**
 - Returns to the previous menu / page
- 22 Coloured buttons (red-green-yellow-blue)**
 - Used for the selection, navigation and operation of various functions
- 23 Hold**
 - Freeze / unfreeze picture ➔ (p. 19)
 - Holds the current teletext page (teletext mode) ➔ (p. 25)
- 24 Index ➔ (p. 26)**
 - Returns to the teletext index page (teletext mode)
- 25 Last view ➔ (p. 18)**
 - Switches to previously viewed channel or input mode
- 26 Channel Up / Down**
- 27 Connected equipment operations ➔ (p. 28, 58, 66, 68, 88)**

Installing / removing remote's batteries

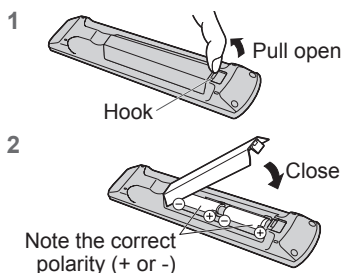

Caution

- Incorrect installation may cause battery leakage and corrosion, resulting in damage to the remote control.
- Do not mix old and new batteries.
- Do not mix different battery types (such as alkaline and manganese batteries).
- Do not use rechargeable (Ni-Cd) batteries.
- Do not burn or breakup batteries.
- Batteries must not be exposed to excessive heat such as sunshine, fire or the like.
- Do not disassemble or modify the remote control.

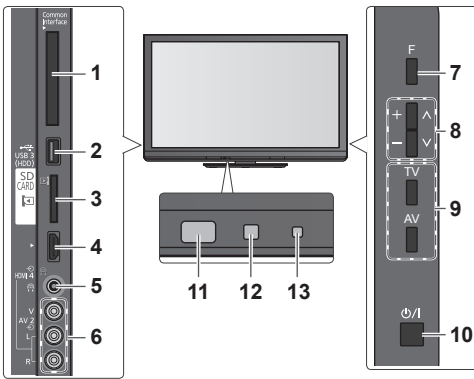

1 CI slot ➔ (p. 51)

2 USB 3 port ➔ (p. 55, 92)

3 SD Card slot ➔ (p. 59)

4 HDMI4 terminal ➔ (p. 92)

5 Headphones jack ➔ (p. 92)

6 AV2 terminals ➔ (p. 92)

7 Function select

- [Volume] / [Contrast] / [Brightness] / [Colour] / [Sharpness] / [Tint] (NTSC signal) / [Bass]* / [Treble]* / [Balance] / [Auto Setup] (p. 40)
- *[Music] or [Speech] mode in the Sound Menu

8 Channel Up / Down, Value change (when using the F button), Switching the TV On (press either button for about 1 second when in Standby mode)

9 Changes the input mode

10 Mains power On / Off switch

- Use to switch the mains power. If you turned the TV Off during Standby mode by the remote control last time, the TV will be in Standby mode when you turn the TV On with Mains power On / Off switch.

11 Remote control signal receiver

- Do not place any objects between the TV remote control signal receiver and remote control.

12 C.A.T.S. (Contrast Automatic Tracking System) sensor

- Senses brightness to adjust picture quality when [C.A.T.S.] in the Picture Menu is set to [On] ➔ (p. 31)

13 Power and Timer LED

- **Red** : Standby

Green : On

Orange : Timer Programming On

Orange (flash) :

Recording of Timer Programming,
Direct TV Recording or One Touch
Recording in progress

Red with orange flash :

Standby with Timer Programming On, Direct
TV Recording or One Touch Recording

- The LED blinks when the TV receives a command from the remote control.

Using the On Screen Displays - Operation guide

Many features available on this TV can be accessed via the On Screen Display menu.

Operation guide

Operation guide will help you to operate by using the remote control.

Example : [Owner ID]

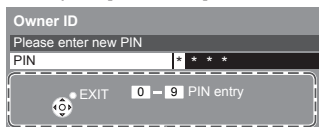

Operation guide

How to use remote control



Open the main menu



Move the cursor / select the menu item / select from a range of options



Move the cursor / adjust levels / select from a range of options



Access the menu / store settings after adjustments have been made or options have been set



Return to the previous menu



Exit the menu system and return to the normal viewing screen

Auto power standby function

The TV will automatically go to Standby mode in the following conditions:

- no signal is received and no operation is performed for 30 minutes in Analogue TV mode
- [Off Timer] is active in the Timer Menu (p. 19)
- no operation is performed for the period selected in [Auto Standby] (p. 34)
- This function does not affect the recording of Timer Programming, Direct TV Recording and One Touch Recording.

Basic Connection

External equipment and cables shown are not supplied with this TV.

Please ensure that the unit is disconnected from the mains socket before attaching or disconnecting any leads. When disconnecting the mains lead, be absolutely sure to disconnect the mains plug at the socket outlet first.

Example 1

Connecting aerial

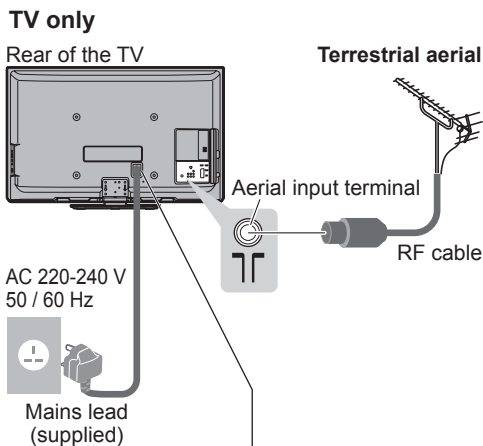

Mains Lead

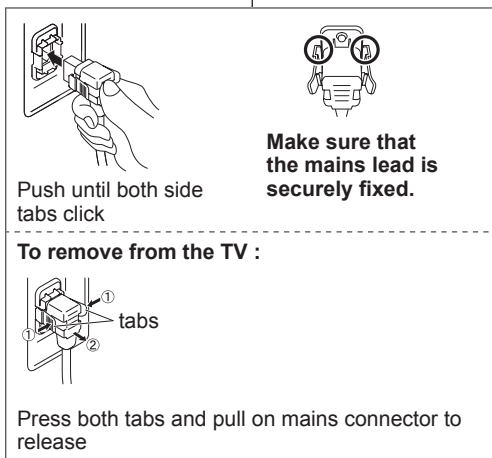

Example 2

Connecting DVD Recorder / VCR

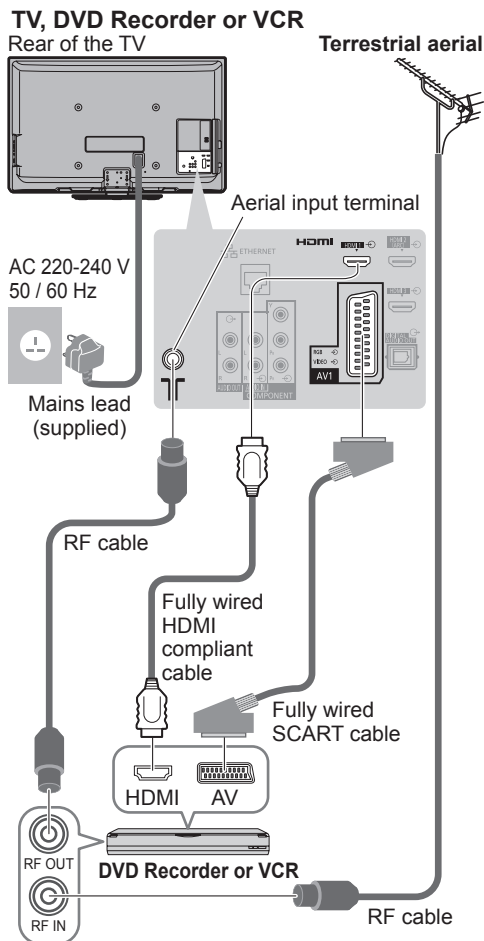

Note

- Connect to the TV's AV1 for a DVD Recorder / VCR supporting Q-Link (p. 84).
- For HDMI-compatible equipment, possible to connect to HDMI terminals (HDMI1 / HDMI2 / HDMI3 / HDMI4) by using HDMI cable (p. 90).
- Q-Link and VIERA Link connection ➔ (p. 82, 83)
- Please also read the manual of the equipment being connected.
- Keep the TV away from electronic equipment (video equipment, etc.) or equipment with an infrared sensor. Otherwise, distortion of image / sound may occur or operation of other equipment may be interfered.

Example 3

Connecting DVD Recorder / VCR and Satellite receiver

TV, DVD Recorder / VCR and Satellite

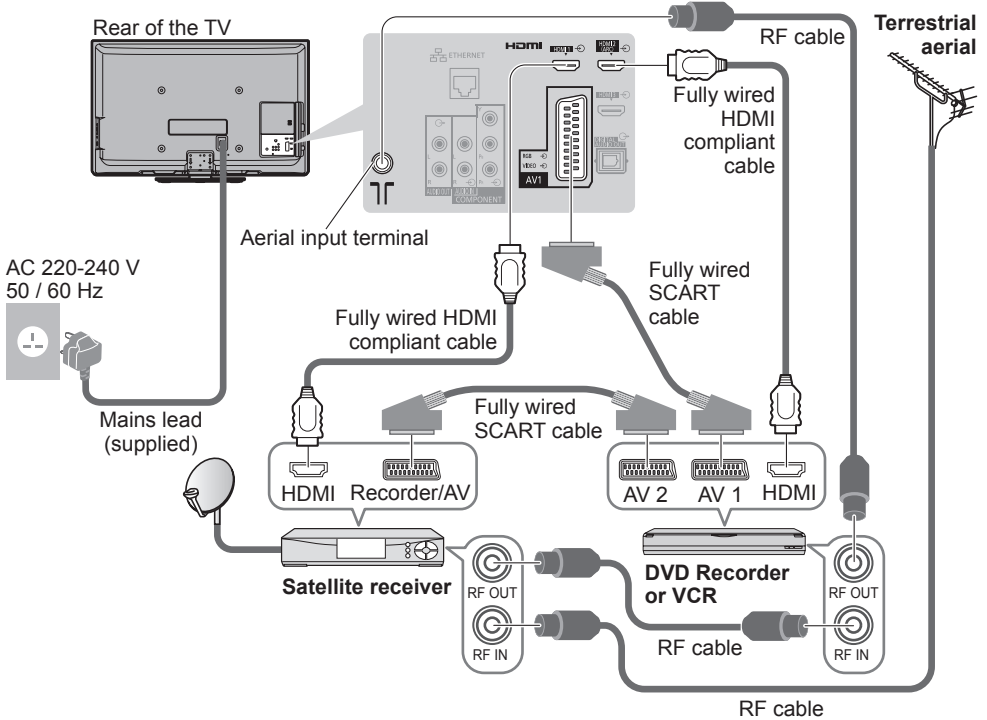

■ Connecting to the network environment (Network connections)

To enable the network service functions (VIERA Connect, etc.), you need to connect the TV to a broadband network environment.

- If you do not have any broadband network services, please consult your retailer for assistance.
- Connect with LAN cable (Wired connection) or Wireless LAN Adaptor (Wireless connection).
- Setup of the network connection will start after the tuning (when first using the TV) ➔ (p. 12 - 14)

Rear of the TV

Wireless connection

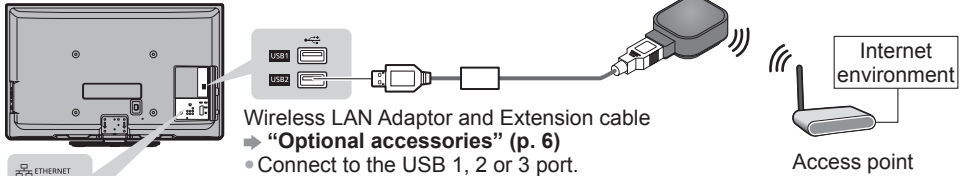

Wireless LAN Adaptor and Extension cable
➔ "Optional accessories" (p. 6)

- Connect to the USB 1, 2 or 3 port.

Wired connection

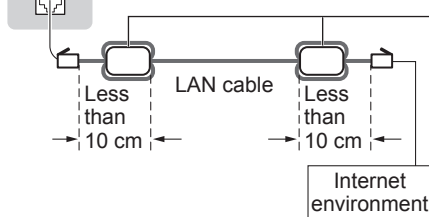

Ferrite core (supplied)

Installing the Ferrite core

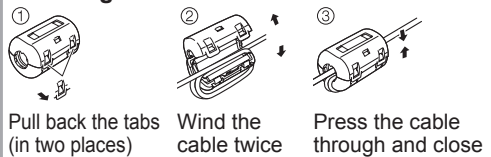

Note

- For more information of the network connections ➔ (p. 72)

Auto Setup

Search and store TV channels automatically.

- These steps are not necessary if the setup has been completed by your local dealer.
- Please complete connections (p. 10, 11) and settings (if necessary) of the connected equipment before starting Auto Setup. For details of settings for the connected equipment, read the appropriate manual.



1

Plug the TV into mains socket and switch On

On/



- Takes a few seconds to be displayed.
- If the red LED shows on the TV, press the Standby On / Off switch on the remote control for at least 1 second to turn the TV On.

2

Select your country



Example : **[UK]**

Auto Setup - DVB and Analogue

DVB Scan CH 21 68
Analogue Scan CH 21 68

This will take about 6 minutes.

CH	Channel Name	Type	Quality
62	CBBC Channel	Free TV	10
62	BBC Radio Wales	Free TV	10
62	E4	Free TV	10
62	Cartoon Nwk	Free TV	10
29		Analogue	-
33	BBC1	Analogue	-

Free TV: 8 Pay TV: 0 Radio: 0 Data: 0 Analogue: 2
Searching

Auto Setup will start to search for TV channels and store them in the numbered order as specified by the broadcasters.

- Actual number of channels may differ due to channel duplication.

Example : **[Ireland]**

Auto Setup - DVB and Analogue

DVB Scan CH 5 69
Analogue Scan CH 1 69 H: 21 41

This will take about 6 minutes.

CH	Channel Name	Type	Quality
62	CBBC Channel	Free TV	10
62	BBC Radio Wales	Free TV	10
62	E4	Free TV	10
62	Cartoon Nwk	Free TV	10
CH29		Analogue	-
CH33	BBC1	Analogue	-

Free TV: 6 Pay TV: 0 Radio: 0 Analogue: 2
Searching

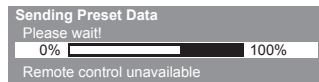

If Q-Link or similar technology (p. 84) compatible recorder with analogue tuner is connected, analogue channel setting is automatically downloaded to the recorder. (Digital channel setting is not downloaded.)

- If downloading has failed, you can download later through the Setup Menu.
 - ➔ **“Q-Link Download”** (p. 34)

3

Setup the network connection

Setup the network connection to enable the network service functions such as VIERA Connect, etc. (p. 16, 71).

- To setup the wireless connection, the Wireless LAN Adaptor (optional accessory) is required.

Please note that this TV does not support wireless public access points.

- Ensure the network connections (p. 11) and network environment are completed before starting setup.

Select the network type

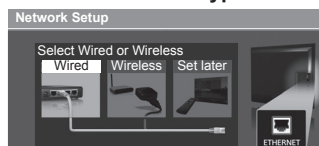

- [Wired] ➔ **“Wired connection”** (p. 11)
- [Wireless] ➔ **“Wireless connection”** (p. 11)



- To setup later on or skip this step
 - ➔ Select [Set later] or EXIT



■ [Wired]

1. Select [Auto]



2. Go to the next step **4**



Connection Test

- Check network cable connection.
- Check acquired IP address.
- Check for devices using same IP address.
- Check gateway connection.
- Check server connection for VIERA Connect.

: **succeeded**

The test is successful and the TV is connected to the network.

: **failed**

Check the settings and connections, and then select [Retry].

Automatically setup is done and the test of the network connection starts.

- To set manually, select [Manual] and set each item. For details ➔ (p. 74)

■ [Wireless]

Select the connection type

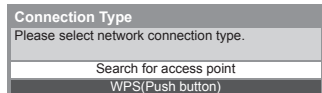

[Search for access point]

Access points found automatically are listed.

1. Select your desired access point

Available Access Points				
No.	SSID	Wireless type	Encrypt	Reception
1	Access Point A	11n(2.4GHz)	<input checked="" type="checkbox"/>	
2	Access Point B	11n(5GHz)	<input type="checkbox"/>	
3	Access Point C	11n(5GHz)	<input type="checkbox"/>	



: Encrypted access point

- To search access points again
 (yellow)

- For the information of the highlighted access point



- To set manually (p. 77)
 (red)

2. Access the encryption key input mode

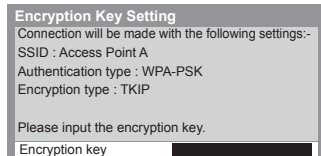

- If the selected access point is not encrypted, the confirmation screen will be displayed. It is recommended to select the encrypted access point.

3. Enter the encryption key of the access point



- You can set characters by using numeric buttons.
➔ **“Characters table for numeric buttons” (p. 97)**



4. Select [Yes]

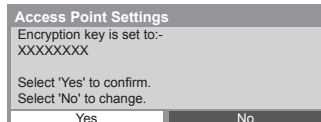

- To re-enter the encryption key, select [No].
- If the connection has failed, check the encryption key, settings and positions of your access point. And then, follow the on screen instructions.

5. After the access point setting is finished, perform the connection test



Connection Test

- Check access point connection.
- Check acquired IP address.
- Check for devices using same IP address.
- Check gateway connection.
- Check server connection for VIERA Connect.

: **succeeded**

The test is successful and the TV is connected to the network.

: **failed**

Check the settings and connections, and then select [Retry].

- To set manually, select [Manual] and set each item. For details ➔ (p. 74)

6. Go to the next step **4**



(Press twice)

[WPS(Push button)]

1. Press the WPS button on the access point until the light flashes

2. Connect the Wireless LAN Adaptor and the access point

WPS(Push button)

- 1) Please press the 'WPS' button on the access point until its light flashes.
- 2) When the light is flashing select 'Connect' on TV.

If you are unsure, please check the instruction manual of the access point.

Connect



- Ensure that your access point supports WPS for this setup.
- WPS : Wi-Fi Protected Setup™
- If the connection has failed, check the settings and positions of your access point. And then, follow the on screen instructions.

3. After the access point setting is finished, perform the connection test



Connection Test

- Check access point connection.
- Check acquired IP address.
- Check for devices using same IP address.
- Check gateway connection.
- Check server connection for VIERA Connect.

: **succeeded**

The test is successful and the TV is connected to the network.

: **failed**

Check the settings and connections, and then select [Retry].

- To set manually, select [Manual] and set each item. For details ➔ (p. 74)

4. Go to the next step **4**



(Press twice)

4 Input Owner ID

Owner ID

Please enter new PIN

PIN

Please enter your own choice of PIN number, name, etc. to help the police to crack crime.

- Make a note of the PIN number in case you forget it. The PIN number cannot be reset.
- You can input or change the Owner ID later. ➔ [Owner ID] (p. 50)
- To skip this step

EXIT



- This step will be skipped in the Auto Setup after [Shipping Condition] (p. 49) is performed.

■ How to input Owner ID

1 Enter the PIN number (4 digits)

Owner ID

Please enter new PIN

PIN



- Enter the PIN number twice at first setting.

2 Select the item (NAME / HOUSE NO / POSTCODE)

Owner ID-Data Entry

PIN

NAME

HOUSE NO

POSTCODE



① select

② access

4 3 Enter your name, house number and postcode

Set characters

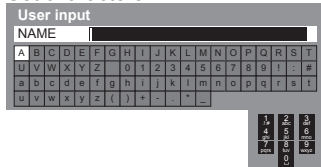

Return to select other items



- Select the next item and repeat the operations.

- You can set characters by using numeric buttons.
➔ **“Characters table for numeric buttons” (p. 97)**

4 Exit to go to next step



5 Select [Home]

Select [Home] viewing environment (highlight [Home] in yellow) to use in your home environment.

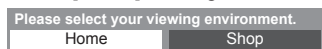

■ [Shop] viewing environment (for shop display only)

[Shop] viewing environment is the demonstration mode to explain main features of this TV.

Select [Home] viewing environment to use in your home environment.

- You can return to viewing environment selection screen at the stage of Shop confirmation screen and Automatic Demo Off / On selection screen.

1 Return to viewing environment selection screen

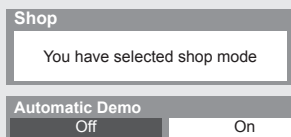

2 Select [Home]



To change viewing environment later on, you will need to initialise all settings by accessing Shipping Condition. ➔ **[Shipping Condition] (p. 49)**

Auto Setup is now complete and your TV is ready for viewing.

If tuning has failed, check the connection of the RF cable, and then, follow the on screen instructions.

- To check channel list at-a-glance ➔ **“Using TV Guide” (p. 21)**
- To edit or hide (skip) channels ➔ **“Tuning and Editing Channels” (p. 41 - 44)**
- To retune all channels ➔ **[Auto Setup] (p. 40)**
- To initialise all settings ➔ **[Shipping Condition] (p. 49)**

If you connect the Wireless LAN Adaptor later on, the confirmation screen will be displayed for the setup.

- To setup the wireless connection ➔ **(p. 75 - 77)**

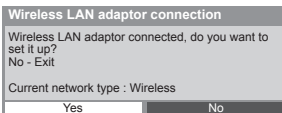

Using “VIERA Connect”

VIERA Connect is a gateway to the internet services unique to Panasonic and has expanded VIERA CAST features greatly. VIERA Connect allows you to access some specific websites supported by Panasonic, and enjoy internet contents such as photos, videos, games, etc. from VIERA Connect home screen.

- This TV has no full browser function and all features of websites may not be available.



1 Turn power on



- Press for about 1 second
- Mains power On / Off switch should be On. (p. 9)

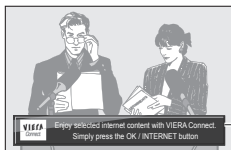

Every time you turn on the TV, VIERA Connect introduction banner appears. The banner is subject to change.

2 Access VIERA Connect

While the banner is displayed



or INTERNET (VIERA CAST)

- The button design varies depending on the remote control.

Example :



- Depending on the usage conditions, it may take a while to read all the data.
- Messages might be displayed before VIERA Connect home screen. Please read these instructions carefully and follow the on screen instructions.

Example : VIERA Connect home screen



- To go to the next level
➔ [MORE]
- To back to the previous level
➔ [BACK]

■ To exit from VIERA Connect

EXIT



- To set the VIERA Connect instruction banner display off
➔ [VIERA Connect Banner] (p. 35)

■ How to operate VIERA Connect (current as of January, 2011)

- To move the cursor / select the item



- When the key words are displayed on colour bar
 (red) (green) (yellow) (blue)

- To access



- When options with numbers are displayed



- To return to the previous screen



- To return to VIERA Connect home screen



- Video communication (ex. Skype™) requires an exclusive Communication Camera TY-CC10W.
➔ “Optional accessories” (p. 6)

For details, read the manual of the Communication Camera.

- You can connect a keyboard and a gamepad via USB port for character input and playing games in VIERA Connect. You can also operate the TV with a keyboard or a gamepad other than VIERA Connect features. For more information ➔ “USB connection” (p. 98)

Note

- If you cannot access VIERA Connect, check the network connections (p. 11) and settings (p. 12 - 14).
- For more information of VIERA Connect ➔ (p. 81)

Watching TV



1 Turn power on



- Press for about 1 second
- Mains power On / Off switch should be On. (p. 9)

■ VIERA Connect introduction banner appears

You can access to VIERA Connect and enjoy the various contents. ➔ (p. 16)



- To remove this banner, leave for about 5 seconds or press any buttons (except the buttons to access VIERA Connect).
- To set this banner display off ➔ **[VIERA Connect Banner]** (p. 35)

2 Select DVB or Analogue



- Also possible to select the mode pressing the TV button on the side panel of the TV (p. 9).

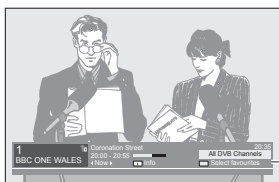

Information banner ➔ (p. 18)

3 Select a channel



or



DVB channel position numbers run from 1 onwards.

Analogue channel position numbers run in the ranges 0 - 99.

- To select a two or three-digit channel position number, e.g. 399



■ Select a channel using Information banner (p. 18)

It is possible to confirm the channel name and programme information by using the Information banner before changing channels.

1 Display Information banner if it is not displayed



2 While the banner is displayed, select the channel



■ Select a channel using TV Guide (p. 21)

It is possible to confirm the channel and programme information by using the TV Guide (EPG) before changing channels.

1 Display TV Guide



2 Select a current programme or channel



3 Select [View] (DVB mode)

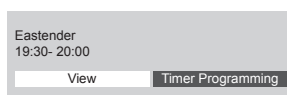

Note

- To watch pay-TV ➔ **“Using Common Interface”** (p. 51)

Other useful functions

Display Information banner

Display Information banner

- Also appears when changing a channel

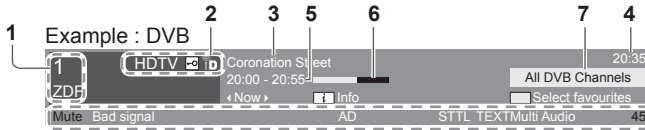

- 1 Channel position and name
- 2 Channel type ([Radio], [Data], [HDTV], etc.) / Encrypted channel (🔒) / TV mode (📺, 📺)
- 3 Programme
- 4 Current time
- 5 Programme Start / Finish time (DVB) Channel number, etc. (Analogue)
- 6 Progress time indicator of the selected programme (DVB)
- 7 [All DVB Channels] or [Favourites1-4] (p. 42) (DVB)
 - To switch
 - (blue)

Features available / Message meanings

[Mute]

Sound mute On

[Bad signal]

Poor TV signal quality

[Also in HD] [UK only]

Same programme available as HD broadcast

- To display the extra information for details



[AD] [UK only]

Audio Description service available

- This function can aid visually-impaired viewers by adding an additional audio track to describe events on screen.
- For settings ➔ (p. 33)

[STLL]

Subtitle service available

[TEXT]

Teletext service available

[Multi Audio]

Multiple audio available

[Stereo], [Mono], [NICAM]

Audio mode

1 - 90

- Off Timer remaining time
- For settings ➔ (p. 19)

- To confirm another tuned channel name



- To watch the channel listed in the banner



- Information on the next programme (DVB)



- To hide



- Extra information (DVB)
- (Press again to hide the banner)



- To set display timeout ➔ [Banner Display Timeout] (p. 35)

- [AD], [STLL], [TEXT], [Multi Audio] indications are displayed as available on particular programmes, but may not be available for all individual programmes being broadcast. Display the extra information to confirm availability of these functions.

Example :



Last view

Switch to previously viewed channel or input mode easily

- Press again to return to the present view.



LAST VIEW

Note

- Switching channel is not available while the recording of Timer Programming, Direct TV Recording or One Touch Recording is in progress.
- Watching less than 10 seconds is not regarded as the previously viewed channel or input mode.

Hold

Freeze / unfreeze picture

HOLD



Display the selectable settings for the current status

Check or change the current status instantly

OPTION

- To change

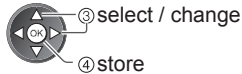

[Audio Description] **UK only**

(DVB mode)

Set to [Auto] if the programme has Audio Description service, then you will hear an additional audio track to describe events on screen

- To adjust the volume for Audio Description

➔ **[Audio Description Menu]** (p. 33)

[Multi Audio]

(DVB mode)

Allows you to select between alternative language for sound tracks (if available)

- This setting is not memorised and it will return to the default setting once you exit the current programme.

[Monaural Audio]

(DVB mode)

Allows you to select stereo / monaural (if available)

- This setting is not memorised and it will return to the default setting once you exit the current programme.

[Subtitle Language]

(DVB mode)

Allows you to select the language in which subtitles should appear (if available)

- This setting is not memorised and it will return to the default setting once you exit the current programme.

[Teletext Character Set]

Ireland only

Sets the teletext language font

➔ **[Setup Menu]** (p. 35)

[Teletext Language]

Ireland only

(DVB mode)

Allows you to select between alternative language for teletext (if available)

[NICAM]

(Analogue mode)

Switches NICAM sound (if available)

➔ **[Sound Menu]** (p. 33)

[Volume Correction]

Adjusts volume of individual channel or input mode

[Safely remove USB]

Takes this operation to remove the connected USB device safely from the TV

Off Timer

Turn the TV off automatically after a fixed period (Off / 15 / 30 / 45 / 60 / 75 / 90 minutes)

1 Display the menu

MENU



2 Select [Timer]

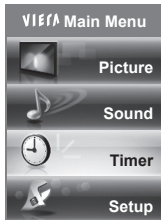

3 Select [Off Timer] and set the time

Timer Programming	Off
Off Timer	15 minutes
Auto Standby	30 minutes
	45 minutes
	60 minutes
	75 minutes
	90 minutes

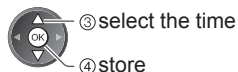

- To cancel ➔ Set to [Off] or turn the TV off.
- To display the remaining time ➔ **“Display Information banner”** (p. 18)
- When the remaining time is within 3 minutes, the remaining time will flash on the screen.

Aspect

Change the aspect ratio (image size)

ASPECT Enjoy viewing the image at its optimum size and aspect. Programmes usually contain an “Aspect Control Signal” (Widescreen signal, etc.), and the TV will choose the aspect ratio automatically according to the “Aspect Control Signal” (p. 93).

■ If you would like to change the aspect ratio manually

1 Display Aspect Selection list



Aspect Selection list

2 While the list is displayed, select the mode



- You can also change the mode only using the ASPECT button.

ASPECT (Press repeatedly until you reach the desired mode)

[Auto]



The best ratio is chosen and the image expanded to fill the screen. For details ➔ (p. 93)

[16:9]



Directly displays the image at 16:9 without distortion (anamorphic).

[Zoom1]



Displays a 16:9 letterbox or 4:3 image without distortion.

[14:9]



Displays the image at the standard 14:9 without distortion.

[Zoom2]

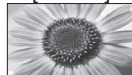

Displays a 16:9 letterbox (anamorphic) image full-screen without distortion.

[4:3]



Displays the image at the standard 4:3 without distortion.

[Zoom3]

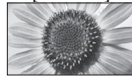

Displays a 2.35:1 letterbox (anamorphic) image full-screen without distortion. At 16:9, displays the image at its maximum (with slight enlargement).

Note

- Aspect is fixed to [16:9] when [Viewing Mode] is set to [Game] in the Picture Menu.
- Not available in teletext service.
- Aspect mode can be memorised separately for SD (Standard definition) and HD (High definition) signals.

Display subtitles

■ DVB mode

Display / hide subtitles (if available)

- STTL** • To change the language for DVB (if available)
➔ **[Preferred Subtitles]** (p. 35)

■ Analogue mode

Display subtitles



Hide subtitles



Note

- This is the same as switching to Analogue teletext service and selecting “P888” (subtitle service). (p. 26)
- You cannot change the channel when this function is active.

Using TV Guide

TV Guide—Electronic Programme Guide (EPG) provides an on screen listing of the programmes currently broadcast and the forthcoming broadcasts over the next seven days (depending on the broadcasters).

- This TV supports the GUIDE Plus+ system. **UK only**
- The Rovi branding partner will supply the rating information in the programme information and the recommended group in the Search list. **UK only**
- DVB and Analogue channels are displayed on the same TV Guide screen. [D] means DVB channel and [A] means Analogue channel. There will be no programme listings for Analogue channels.
- When this TV is turned on for the first time, or the TV is switched off for more than a week, it may take some time before TV Guide is completely shown.



1 Select DVB or Analogue



2 View TV Guide

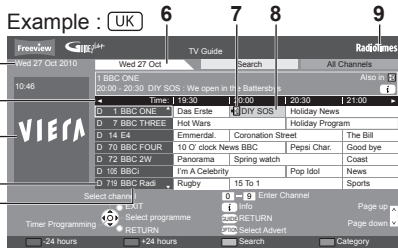

- 1 Current date and time
- 2 TV Guide time
- 3 Advertisement
- 4 [D] : DVB
[A] : Analogue
- 5 Channel position and name
- 6 TV Guide date

■ To return to TV

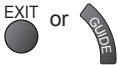

- 7 Some programmes may also be broadcast in HD **UK only**
 - You can select HD or SD broadcast before viewing or setting Timer Programming.
- 8 Programme
- 9 Logo of the Rovi branding partner **UK only**

■ To change the layout of TV Guide → [TV Guide View] (p. 34)

■ To watch the programme

1 Select a current programme or channel



2 Select [View] (DVB mode)

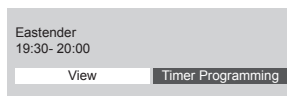

- To use Timer Programming → (p. 22)

- If a programme exists in both HD and SD broadcasts, the [View Options] screen will be displayed to select HD or SD broadcast. (DVB mode) **UK only**



■ To the previous day (DVB mode)



■ To the next day (DVB mode)

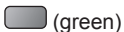

■ View details of the programme (DVB mode)

1 Select the programme



2 View details

- Press again to return to TV Guide.

■ To view a channel list of the selected category



Only Analogue channels are listed

• To list favourite channels → (p. 42)

■ To search programme types and view a channel list of the searched programmes (DVB mode)

(yellow)

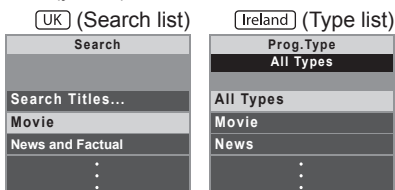

■ To search programme titles and view a list of the searched programmes (DVB mode) **UK only**

(yellow)

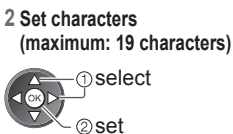

- All the programme titles including the word you set will be listed.
- Searching without any characters will list all programmes including current programmes.

• To use numeric buttons
 ➔ “Characters table for numeric buttons” (p. 97)

Timer Programming (DVB mode)

Timer Programming is a timer to remind watching or record the programme to the external recorder or the USB HDD.

1 Select the forthcoming programme 2 Select the function ([Ext Rec.], [USB HDD Rec.] or [Reminder])



(Timer Programming screen)

Function	No.	Channel Name	Date	Start	End
Ext Rec	119	BBC HD DIY SOS	Wed 27 Oct	19:30	20:00 (30 min.)
...



LED will turn to orange if Timer Programming is set. (Orange LED will flash if the recording of Timer Programming is in progress.)

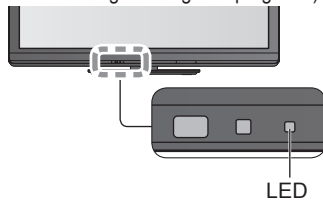

[Ext Rec.] / [USB HDD Rec.] :

to record the programme to the external recorder or the USB HDD. When the start time comes, the channel will be switched automatically and the video and audio signals will be output. 2 minutes before the starting time, a reminder message appears if you are watching TV.

[Reminder] :

to remind you to watch the programme. When you are watching TV, a reminder message appears 2 minutes before the start time. Press the OK button to switch to the programmed channel.

■ To check / change / cancel a timer programming event

➔ “Timer Programming” (p. 45)

■ If you select a current programme

A confirmation screen asking whether you wish to watch or record the programme will appear. Select [Timer Programming] and set [Ext Rec.] or [USB HDD Rec.] to record from the time you finish the timer programming event setting.



■ To return to TV Guide



■ If a programme exists in both HD and SD broadcasts **UK only**

The [Timer Options] screen will be displayed to select HD or SD broadcast.

Timer Options

101	BBC ONE	19:30-20:00	Wed 27 Oct 2010
119	BBC HD	19:30-20:00	Wed 27 Oct 2010



(Timer Programming screen)

Function	No.	Channel Name	Date	Start	End
Ext Rec	119	BBC HD DIY SOS	Wed 27 Oct	19:30	20:00 (30 min.)
...

HD will be displayed if HD broadcast is set.

Note

- This function is not available in Analogue mode.
- Timer Programming reminder messages will remain displayed until one of the following occurs:
 - You press the OK button to view the programme or the EXIT button to cancel the reminder.
 - The timer programming event that the reminder is set for ends.
- No other channel can be selected while the recording of Timer Programming is in progress.
- When recording programmes, be sure to make the proper settings on the recorder connected to the TV. ➔ (p. 45)
- When recording programmes to the USB HDD, be sure to format the USB HDD and enable it for recording in [Recording Setup] (p. 55).

Guide link programming (Timer Programming from the TV Guide signal)

Guide link programming is Timer Programming which is controlled by information from the TV Guide; if programme start and end times are changed by the broadcaster, the timer programming event will follow the change. A Split Programme programming is a Guide link programming which is interrupted by one or more other programmes. Note that Guide link programming (including Split Programme programming) only works reliably if correct information is received from broadcasters.

(Timer Programming screen)

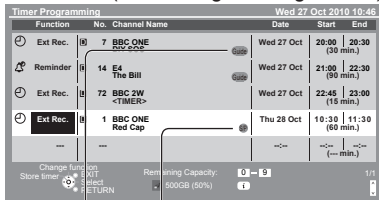

Example : [UK]



"S/P" or "A/P" will be displayed in the TV Guide if Timer Programming is set as the Guide link programming.

"S/P" is displayed if the timer is set from the TV Guide and the programme is a Split Programme

"Guide" is displayed if the timer is set from the TV Guide (Guide link programming)

Note

- If you edit the start time or end time of a Guide link programming event by more than 10 minutes, it will no longer follow the broadcaster's changes to the start or end time. The start and end times will become fixed.
- Whilst making the Split Programme programming event for [Ext Rec.] or [USB HDD Rec.], you cannot record any channels between the interrupted programmes.
- The Split Programme programming event for Reminder will be cleared by pressing the OK button once to view.
- The Split Programme programming event for Reminder will switch to the programmed channel by pressing the OK button even if it is between the interrupted programmes.
- The Split Programme programming does not work if the separated parts are broadcast on different channels.

View advertisement [UK only]

Enter your postcode when using this function for the first time

➔ [Guide Plus+ Postcode] in [TV Guide Settings] (p. 34)

If you have already entered your postcode in "Auto Setup" - when first using the TV (p. 12 - 15), you do not have to enter it again. If you enter an incorrect postcode for your area, or no postcode is entered, advertisements may not be displayed correctly.

Display advertisement information

OPTION



- To display the latest advertisement, you will need to update the information. To update the information continuously, the TV must be left in Standby mode.

■ To change advertisements



■ To return to TV Guide



Note

- Some advertisements are for future programmes. In this case it is possible to use the Guide link programming function.
- The advertisements displayed on the TV Guide are sent from the GUIDE Plus+ system so that they cannot be deleted manually or will not be lost even when the TV is turned Off with Mains power On / Off switch.

Viewing Teletext

You can enjoy news, weather forecasts and subtitles, etc. (depending on the broadcaster)

- The availability of teletext services for a programme is indicated by [TEXT] in the information banner.

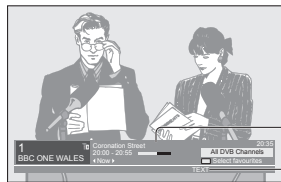

Information banner → (p. 18)

Displayed if programme has teletext service

Ireland

Depending on the broadcaster, the digital teletext (MHEG) services may not be available. In this case, the operation of the teletext services may be the same as the analogue teletext services (p. 24).

Digital teletext (MHEG)

Digital teletext services differ greatly from analogue teletext.

When you switch to a digital teletext service, the images you see can contain graphics and text, laid out and controlled in a manner decided by the broadcaster.



1 Select DVB



2 Switch to Teletext



- DVB programmes have digital teletext services (MHEG).

Example :

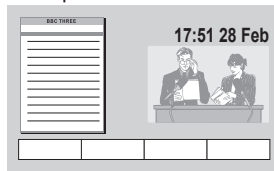

■ How to operate services

In all cases, it is possible to navigate the pages using buttons on the remote control, but because the commands available must apply to all manufacturers of digital equipment, some on screen commands may not correspond exactly to the remote control buttons.

- Select, go



- Back key



- Symbol : ◀▶▲▼



- Coloured characters



Coloured button

- When options with numbers are displayed



Note

- As soon as you switch to a digital channel with links to a teletext service, software is downloaded in the background to enable the teletext function. This means that when switching to a digital channel, you should wait for approximately 5 seconds before pressing the TEXT button - this will allow the software to download. If you press the TEXT button before download is complete, it will be ignored and you will have to press the TEXT button again when the download is complete.
- While navigating digital teletext, you will find there is a short delay when moving between pages while the page downloads. There is often a prompt shown somewhere on the page (for example "Loading") to let you know that this is happening.

■ To return to TV



Analogue teletext

Analogue teletext services are the text information provided by the broadcasters. The features may vary depending on the broadcasters.

What is FASTEXT (FLOF) mode?

In FASTEXT mode, four differently coloured subjects are situated at the bottom of the screen. To access more information about one of these subjects, press the appropriately coloured button. This facility enables fast access to information on the subjects shown.

What is List mode?

In List mode, four differently coloured page numbers are situated at the bottom of the screen. Each of these numbers can be altered and stored in the TV's memory. ➔ "Store frequently viewed pages" (p. 26)

■ To change mode ➔ [Teletext] (p. 35)



1 Select Analogue



2 Switch to Teletext



• Displays the index page (content varies depending on the broadcasters)

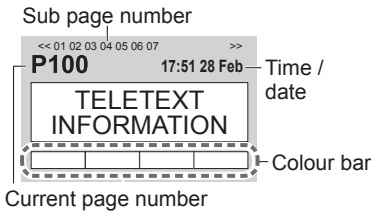

3 Select the page



or Coloured button (Corresponds to the colour bar)

■ To return to TV



■ To adjust contrast



As the blue bar is displayed



FULL / TOP / BOTTOM

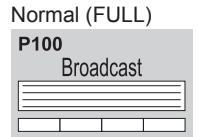
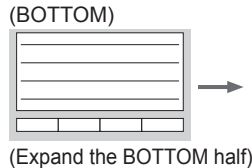
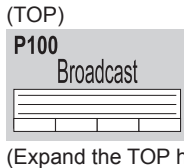

Reveal hidden data

Reveal hidden words e.g. quiz page answers



• Press again to reheide

HOLD

Stop automatic updating

(If you wish to hold the current page without updating)



• Press again to resume

INDEX

Return to the main index page



Subtitles

View a favourite page stored



- Factory setting is "P888" (subtitle service) on the blue button (List mode).

View in multi window

Watch TV and Teletext in two windows at once



- Operations can be made only in Teletext screen.
- Each time pressed: Teletext → TV and Teletext ← TV

Store frequently viewed pages

Store frequently viewed pages in the colour bar (List mode only)

As page is displayed



(Corresponding coloured button)



press and hold

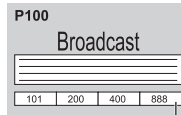

The number changes to white.

- If you wish to use Subtitles, do not change number on blue button.

■ To change stored pages



Coloured button you want to change



Enter new page number



press and hold

View sub page

View sub page (Only when teletext is more than one page)



<<01 02 03 04 05

Appears at top of the screen

- The number of sub pages varies depending on the broadcasters (up to 79 pages).
- It may take some time for searching, during which time you can watch TV.

■ To view specific sub page



(blue)



Enter the 4-digit number example : P6

0 0 0 6

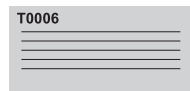

Watch TV while waiting for update

View the TV picture while searching for a teletext page

Teletext automatically updates itself when new information becomes available.



(yellow)



Changes to TV screen temporarily



Appears when updating is completed



View the updated page (yellow)

(You cannot change the channel.)

- The news page provides a function that indicates arrival of latest news ("News Flash").

Watching External Inputs

Connect the external equipment (VCRs, DVD equipment, etc.) and you can watch through the AV input.

- To connect the equipment → (p. 10, 11, 90 - 92)

The Remote Control is capable of operating some functions of selected external equipment.

- ➔ **“Operating the equipment with the TV remote control”** (p. 28)



1 Turn the TV on



When connecting with SCART as example 2 or 3 (p. 10, 11)

Receives input signals automatically when playback starts

- Input signals are automatically identified by the SCART (pin 8) terminal.
- This function is also available for HDMI connections (p. 90).

If input mode is not switched automatically

Perform **2** and **3**

- Check the setup of the equipment.

2 Display the input selection menu



3 Select the input mode connected to the equipment

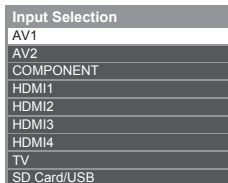

- You can also select the input using the AV button on the remote control or the side panel of the TV (except [SD Card/USB]). Press the button repeatedly until the desired input is selected.
- [SD Card/USB] : Switches to Media Player → **“Using Media Player”** (p. 59)
- You can label or skip each input mode (except [SD Card/USB]).
➔ **“Input Labels”** (p. 48)
- Skipped inputs will not be displayed when the AV button is pressed.

4 View

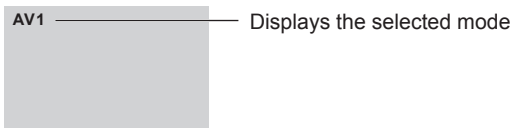

■ To return to TV



Terminal	AV1	AV2	COMPONENT	HDMI1	HDMI2	HDMI3	HDMI4
Manual input (default setting in "Input Labels")	AV1 AV1-RGB	AV2	COMPONENT	HDMI1	HDMI2	HDMI3	HDMI4
Auto input (EC mode or VIERA Link)	EC/AV1 EC/AV1-RGB	-	-	EC/HDMI1 Applicable for EC mode and VIERA Link	EC/HDMI2 Applicable for VIERA Link	EC/HDMI3 Applicable for VIERA Link	EC/HDMI4 Applicable for VIERA Link









- If the above information is permanently displayed on the top left of the screen, press the **i** button to clear.

Note

- If the external equipment has an aspect adjustment function, set it to [16:9].
- For details, see the manual of the equipment or ask your local dealer.

Operating the equipment with the TV remote control

The equipment connected to the TV can be directly operated with the below buttons of this TV remote control.

	<p>Selection Switch for operating the connected equipment Select “DVD/VCR” to operate Panasonic DVD Recorder, DVD Player, Player theatre, Blu-ray Disc theatre or VCR ➔ “How to change the code for the type of the equipment” (see below) Select “TV” to use USB HDD Recording, Media Player or VIERA Link ➔ “USB HDD Recording” (p. 58) ➔ “Media Player” (p. 66, 68) ➔ “VIERA Link Control” (p. 88)</p>
	<p>Standby Set to Standby mode / Turn on</p>
	<p>Play Playback videocassette / DVD / video content</p>
	<p>Stop Stop the operations</p>
	<p>Rewind / Skip / Search VCR : Rewind, view the picture rapidly in reverse DVD / video content : Skip to the previous track, title or chapter Press and hold to search backward</p>
	<p>Fast-forward / Skip / Search VCR : Fast-forward, view the picture rapidly forward DVD / video content : Skip to the next track, title or chapter Press and hold to search forward</p>
	<p>Pause Pause / Resume DVD : Press and hold to play at slow speed</p>
	<p>Channel Up / Down Select channel</p>
	<p>Record Start recording</p>

How to change the code for the type of the equipment

Each type of the Panasonic equipment has its own remote control code.
 Please change the code according to the equipment you want to operate.

1 Set the position to “DVD/VCR”



2 Press and hold during the following operations

Enter the appropriate code, see table below



Press 

Type of the equipment	Code
DVD Recorder, DVD Player, Blu-ray Disc Player	70 (default)
Player theatre, Blu-ray Disc theatre	71
VCR	72

Note

- Confirm if the remote control works correctly after changing the code.
- The codes may be reset to default values if batteries are replaced.
- Some operations may not be possible on some equipment models.

How to Use VIERA TOOLS

You can access some special features easily by using the VIERA TOOLS function.

- For [VIERA Link Control] and [Pause Live TV] functions to operate correctly, ensure the connections and settings are completed.
 - ➔ **“Summary of Q-Link and VIERA Link features”** (p. 82, 83), **“Preparations”** (p. 85)
After connection, turn the equipment on and then switch the TV on.
- For [Photo], [Video] and [Music] functions to operate correctly, ensure the device has photo or video data on it and insert it into the SD Card slot or USB port properly.
 - ➔ **“Using Media Player”** (p. 59)



1 Display icons of the feature



2 Select a feature



■ To return to TV



■ Follow the operations of each feature

[VIERA Link Control]

➔ **“VIERA Link Control”** (p. 87)



When two or more compatible equipment are connected, a selection screen will be displayed. Please select the correct description and access.

[Photo]*

➔ **“Photo mode”** (p. 61)



[Video]*

➔ **“Video mode”** (p. 65)



[Recorded TV]*

➔ **“Recorded TV mode”** (p. 67)



[Music]*

➔ **“Music mode”** (p. 69)



[Media Server]*

➔ **“Using DLNA® features”** (p. 78)



* When two or more available devices are connected, a selection screen will be displayed. Please select the correct description and access.

Note

- If the selected feature is not available, the demonstration to explain how to use it can be displayed. Press the OK button to view the demonstration after selecting the unavailable feature.

How to Use Menu Functions

Various menus allow you to make settings for the picture, sound, and other functions.



1 Display the menu
 MENU • Displays the functions that can be set (varies according to the input signal)

2 Select the menu

① select
 ② access

3 Select the item
 Example : [Picture Menu]

① select
 ② access

■ **Choose from among alternatives**



■ **Adjust using the slide bar**



■ **Go to the next screen**

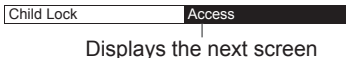

■ **Enter characters by free input menu**

You can enter names or numbers freely for some items.

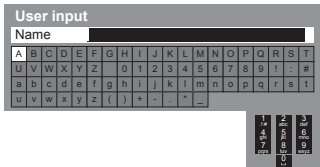

Set characters



Store



- You can set characters by using numeric buttons.
 ➔ “Characters table for numeric buttons” (p. 97)

■ **To reset the settings**

- To reset the picture settings only
 ➔ **[Reset to Defaults]** in the Picture Menu (p. 32)
- To reset the sound settings only
 ➔ **[Reset to Defaults]** in the Sound Menu (p. 33)
- To initialise all settings
 ➔ **[Shipping Condition]** in the Setup Menu (p. 36)

■ **To return to TV at any time**



■ **To return to the previous screen**



■ **To change menu pages**

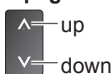

Note

- If “Demo Settings” item is displayed in the Setup Menu, the TV is in “Shop” viewing environment. To return to “Home” viewing environment initialise all settings by accessing Shipping Condition. ➔ (p. 49)

Menu	Item	Adjustments / Configurations (alternatives)
Picture	Viewing Mode	<p>Basic picture mode [Dynamic] / [Normal] / [Cinema] / [THX (True Cinema)] / [Game] / [Photo] / [Professional1] / [Professional2]</p> <p>In each Viewing Mode, [Contrast], [Brightness], [Colour], [Sharpness], [Tint], [Colour Balance], [Vivid Colour], [C.A.T.S.], [P-NR] and [3D-COMB] can be adjusted and stored to suit your particular viewing requirement.</p> <ul style="list-style-type: none"> • Set for each input signal. <p>[Dynamic] : Provides enhanced picture contrast and sharpness when viewing in a bright room.</p> <p>[Normal] : Recommended for viewing under normal ambient room lighting conditions.</p> <p>[Cinema] : For watching movies in a darkened room with the improved performance of contrast, black and colour reproduction</p> <p>[THX (True Cinema)] :</p> <p>Precisely reproduces the original quality of the image without any revision. Recommended for playback of THX disc (disc with [THX] logo)</p> <p>THX mode is used to mirror the picture settings used by professional filmmakers, faithfully reproducing the image quality of THX Certified movies.</p> <ul style="list-style-type: none"> • THX Certified movies have the [THX] logo on a disc. • [True Cinema] is displayed instead of [THX] in the mode of Media Player and Network service operations. <p>[Game] : Fast response signal specifically to provide suitable images for playing games</p> <ul style="list-style-type: none"> • Not valid on TV mode • A continuous record of time spent using Game mode can be displayed in the top right of the screen. ➔ [Playing Time Display] (p. 35) <p>[Photo] : Set [Reversal Film Effect] to [On] to provide the suitable image quality for photos</p> <ul style="list-style-type: none"> • For HDMI input, Media Player and network service operations <p>[Professional1 / 2] :</p> <p>Allows you to set the professional picture settings in [Advanced Settings], [Lock Settings] and [Copy Adjustment] ➔ (p. 53)</p> <ul style="list-style-type: none"> • This mode is available only when [Advance(isfcc)] in the Setup Menu is set to [On]. • Not valid on VIERA Connect • If the certified professional dealer sets these modes, [Professional1] and [Professional2] may be displayed as [isf Day] and [isf Night].
	Contrast, Brightness, Colour, Sharpness	Increases or decreases the levels of these options according to your personal preference
	Tint	<p>With an NTSC signal source connected to the TV, the picture hue can be adjusted to suit your taste</p> <ul style="list-style-type: none"> • For NTSC signal reception only
	Colour Balance	<p>Allows you to set the overall colour tone of the picture [Cool] / [Normal] / [Warm]</p> <ul style="list-style-type: none"> • Not valid when [Viewing Mode] is set to [THX] ([True Cinema]), [Professional1] or [Professional2].
	Vivid Colour	<p>Automatically adjusts colours to vivid ones [Off] / [On]</p> <ul style="list-style-type: none"> • Not valid when [Viewing Mode] is set to [Professional1] or [Professional2].
	Reversal Film Effect	<p>Provides the picture effect such as the reversal film [Off] / [On]</p> <ul style="list-style-type: none"> • This function is available when [Viewing Mode] is set to [Photo].
	C.A.T.S.	<p>Contrast Automatic Tracking System (Automatic Brightness Control function)</p> <p>Adjusts picture settings automatically dependent on ambient lighting conditions [Off] / [On]</p> <ul style="list-style-type: none"> • Set to [On] to make the suitable contrast setting automatically. • The default setting is [On] when [Viewing Mode] is set to [Normal].
	P-NR	<p>Picture Noise Reduction</p> <p>Automatically reduces unwanted picture noise and flicker noise in the contoured parts of a picture [Off] / [Min] / [Mid] / [Max]</p>
	3D-COMB	<p>Makes still or slow moving pictures look more vivid [Off] / [On]</p> <ul style="list-style-type: none"> • Occasionally, whilst viewing still or slow moving pictures, colour patterning may be seen. Set to [On] to display sharper and more accurate colours. • For PAL or NTSC signal reception only • Not valid on RGB, Component, HDMI and Media Player

Menu	Item	Adjustments / Configurations (alternatives)	
Picture	Advanced Settings	Screen Display	<p>Turns the screen off when you select [Off] [Off] / [On]</p> <ul style="list-style-type: none"> • The sound is active even if the screen turns off. • Press any buttons (except Standby) to turn the screen on. • This function is effective in reducing power consumption when listening to the sound without watching the TV screen.
		Intelligent Frame Creation	<p>Automatically compensates the picture frame rate and removes juddering movements to make the images smooth [Off] / [Mid] / [Max]</p> <ul style="list-style-type: none"> • Depending on the contents, images may be noisy. To prevent the noise, change the setting. • This function is not available for selection (default to [Off]) when [Viewing Mode] is set to [Game] in the mode of or network service operations.
		24p Smooth Film	<p>Automatically compensates the picture frame rate to make the 24p source movie images smooth [Off] / [Mid] / [Max]</p> <ul style="list-style-type: none"> • This is available only for 24p signal input and displayed instead of [Intelligent Frame Creation]. • This function is not available for selection (default to [Off]) when [Viewing Mode] is set to [Game] or in the mode of network service operations.
		Clear Cinema	<p>Improves vertical resolution for movie images [Off] / [On]</p> <ul style="list-style-type: none"> • This function is available for the interlaced signal (except when [Viewing Mode] is set to [Game]).
		Resolution Enhancer	<p>Enhances the picture resolution to make the image sharper [Off] / [Mid] / [Max]</p> <ul style="list-style-type: none"> • This function is available for SD (Standard definition) signal. • As for HD (High definition) signal, this function is available when aspect mode is set to [16:9] ([16:9 Overscan] is set to [On]) or [Zoom]. • Not valid on Media Player and network service operations
		Side Panel	<p>Increases the brightness of the side panel [Off] / [Low] / [Mid] / [High]</p> <ul style="list-style-type: none"> • The recommended setting is [High] to prevent panel "image retention".
		16:9 Overscan	<p>Selects the screen area displaying the image [Off] / [On]</p> <p>[On] : Enlarges the image to hide the edge of the image. [Off] : Displays the image in the original size.</p> <ul style="list-style-type: none"> • Set to [On] if noise is generated on the edge of the screen. • This function is available when aspect is set to [Auto] (16:9 signal only) or [16:9]. • This function can be memorised separately for SD (Standard definition) and HD (High definition) signals. • Not valid on VIERA Connect
		DVI Input Setting	<p>Changes the black level in the image for HDMI input mode with DVI input signal manually [Normal] / [Full]</p> <ul style="list-style-type: none"> • When the DVI input signal from the external equipment, especially from PC, is displayed, the black level may not be suitable. In this case, select [Full]. • The black level for HDMI input signal will be adjusted automatically. • For HDMI input mode with DVI input signal only
		Pixel Orbiter	<p>Selects the mode for wobbling of the image to prevent panel "image retention" [Auto] / [On]</p> <p>[Auto] : Automatically works only for the appropriate images and you rarely recognise the wobbling.</p>
		Scrolling Bar	<p>Scrolls the vertical bar to prevent panel "image retention"</p> <ul style="list-style-type: none"> • Press the OK button to start scrolling and press any buttons (except Standby) to exit this mode.
	Reset to Defaults	Press the OK button to reset the present Picture Viewing Mode to the default settings	
Sound	Mode	<p>Selects the basic sound mode [Music] / [Speech] / [User]</p> <ul style="list-style-type: none"> • The selected mode affects all input signals. [Music] : Improves sound quality for watching music videos, etc. [Speech] : Improves sound quality for watching news, drama, etc. • In Music and Speech modes, you can adjust [Bass] and [Treble] settings, and those settings will be stored for each mode. [User] : Adjusts the sounds manually by using the equaliser to suit your favourite sound quality. • For the User mode, [Equaliser] will appear on the Sound Menu instead of [Bass] and [Treble]. Select the [Equaliser] and adjust the frequency. ➔ [Equaliser] (p. 33) 	
		Bass	Increases or decreases level to enhance or minimise lower, deeper sound output
		Treble	Increases or decreases level to enhance or minimise sharper, higher sound output

Menu	Item	Adjustments / Configurations (alternatives)	
Sound	Equaliser	Adjusts the frequency level to suit your favourite sound quality <ul style="list-style-type: none"> • This function is available when [Mode] is set to [User]. • Select the frequency and change the frequency level by using the cursor button. • If you want to enhance the bass sound, raise the level of the lower frequency. If you want to enhance the treble sound, raise the level of the higher frequency. • To reset the levels of each frequency to the default settings, select the [Reset to Defaults] by using the cursor button, and then press the OK button. 	
	Balance	Adjusts volume level of right and left speakers	
	Headphone Volume	Adjusts the volume of the headphones	
	Surround	Surround sound settings [Off] / [V-Audio] / [V-Audio Surround] [V-Audio] : Provides a dynamic enhancer of width to simulate improved spatial effects [V-Audio Surround] : Provides a dynamic enhancer of width and depth to simulate improved spatial effects	
	Auto Gain Control	Automatically regulates large sound level differences between channels and inputs [Off] / [On]	
	Volume Correction	Adjusts the volume of individual channel or input mode	
	Speaker Distance to Wall	Compensates for the distance between the speakers and the wall [Over 30cm] / [Up to 30cm] <ul style="list-style-type: none"> • If the distance between the TV and wall is over 30 cm, [Over 30cm] is recommended. • If the distance between the TV and wall is within 30 cm, [Up to 30cm] is recommended. 	
	Preferred Multi Audio	• Selects the preferred language for digital channel multi audio (depending on the broadcaster) [English] / [Welsh] / [Gaelic] / [Irish]	
	NICAM	Near Instantaneous Companded Audio Multiplex Reproduces NICAM stereo sound [Off] / [On] <ul style="list-style-type: none"> • Off if reception is poor (FM monaural sound) • Analogue mode only 	
	SPDIF Selection	SPDIF : A standard audio transfer file format Selects the initial setting for digital audio output signal from DIGITAL AUDIO OUT and HDMI2 (ARC function) terminals [Auto] / [PCM] [Auto] : Dolby Digital Plus, Dolby Digital and HE-AAC (48 kHz) multi-channel are output as Dolby Digital Bitstream. MPEG is output as PCM. [PCM] : Digital output signal is fixed to PCM. <ul style="list-style-type: none"> • For DVB mode, network video contents (p. 79) or Video mode of Media Player (p. 65) • ARC (Audio Return Channel) : A function of digital audio output using HDMI cable 	
	HDMI1 / 2 / 3 / 4 Input	Select to fit the input signal [Digital] / [Analogue] (p. 97) [Digital] : When sound is carried via the HDMI cable connection [Analogue] : When sound is not carried via the HDMI cable connection <ul style="list-style-type: none"> • HDMI input mode only 	
	Audio Description Menu	Audio Description	[UK only] Narration settings for visually impaired users [Off] / [Auto] Set to [Auto] to activate the narration sound track when available on the broadcast <ul style="list-style-type: none"> • The availability of audio description sound track is indicated by [AD] in the information banner (p. 18). • DVB mode only
		Volume	[UK only] Adjusts the volume for Audio Description <ul style="list-style-type: none"> • DVB mode only
		Speakers	[UK only] Set to [On] to activate the description sound track from TV speakers [Off] / [On] <ul style="list-style-type: none"> • DVB mode only
Headphones		[UK only] Set to [On] to activate the description sound track from headphones [Off] / [On] <ul style="list-style-type: none"> • DVB mode only 	
Reset to Defaults	Press the OK button to reset the present Sound Mode, [Balance], [Headphone Volume] and [Surround] to the default settings		

Menu	Item	Adjustments / Configurations (alternatives)	
Timer	Timer Programming	Sets programme reminders and records forthcoming programmes (p. 45)	
	Off Timer	Sets the time until the TV automatically goes to Standby mode [Off] / [15] / [30] / [45] / [60] / [75] / [90] (minutes) (p. 19)	
	Auto Standby	Sets the duration of time that the TV will remain On when no operation is received from the user [Off] / [2] / [4] (hours) <ul style="list-style-type: none"> Starting Timer Programming automatically does not affect this function. Automatic input switching with the connected equipment affects this function and time-count will be reset. The notification message will appear 3 minutes before going to Standby mode. 	
TV Guide Settings	TV Guide View	Changes the layout of TV Guide [Normal] / [Full] / [Info] [Normal] : Default TV Guide screen [Full] : Displays channels and programmes full-screen without the operation guide [Info] : Displays details of the selected programme at the bottom without the operation guide	
	GUIDE Plus+ Postcode	UK only Sets your postcode to display advertisements in the GUIDE Plus+ system (p. 23)	
	GUIDE Plus+ Information	UK only Displays the system information of the GUIDE Plus+ system	
Setup	Eco Navigation	Automatically sets the TV to the most suitable energy-saving mode <ul style="list-style-type: none"> If you press the OK button, the following items are set as below : [C.A.T.S.], [VIERA Link], [Standby Power Save], [Power Save] ➔ [On] [Intelligent Auto Standby] ➔ [On (No reminder)] [Auto Standby] ➔ [2 hours] 	
	Recording Setup	Formats the connected USB HDD and sets the condition (p. 55)	
	Link Settings	VIERA Link	Setting for VIERA Link functions [Off] / [On] (p. 85)
		HDMI Content Detection	Automatically adjusts picture according to received HDMI content [Off] / [Auto] <ul style="list-style-type: none"> This function is available if the connected equipment supports HDMI Content Type. The content type information will be displayed for several seconds when this function works.
		AV1 out	Chooses the signal to be transmitted from the TV to Q-Link [TV] / [AV2] / [Monitor] [Monitor] : Image displayed on screen <ul style="list-style-type: none"> Component and HDMI signals cannot be output.
		Standby Power Save	Controls the connected equipment to reduce power consumption in Standby [Off] / [On] (p. 86) <ul style="list-style-type: none"> This function is available when [VIERA Link] is set to [On].
		Intelligent Auto Standby	Makes non-watched or non-used connected equipment go into Standby mode to reduce the power consumption [Off] / [On (With reminder)] / [On (No reminder)] (p. 86) <ul style="list-style-type: none"> This function is available when [VIERA Link] is set to [On].
		Q-Link Download	Downloads analogue channel information to a Q-Link compatible equipment connected to the TV
Child Lock	Applies access control for channels or AV inputs to prevent unwanted access (p. 47)		

Menu	Item	Adjustments / Configurations (alternatives)
DVB Tuning Menu	Favourites Edit	Creates a list of favourite DVB channels (p. 42)
	Channel List	Skips the unwanted DVB channels or edits DVB channels (p. 43)
	Auto Setup	Automatically searches for the DVB channels received in the area (p. 40)
	Channel Sorting by Region	UK only Automatically sorts tuned channels according to the available region (p. 41)
	Manual Tuning	Searches for the DVB channels manually (p. 41)
	Update Channel List	Updates DVB Channel List while keeping your settings (p. 43)
	New Channel Message	Selects whether to give a notification message when a new DVB channel is found [Off] / [On] (p. 42)
	Signal Condition	Checks the DVB signal condition (p. 42)
Analogue Tuning Menu	Channel List	Skips the unwanted Analogue channels or edits Analogue channels (p. 44)
	Auto Setup	Automatically searches for the Analogue channels received in the area (p. 40)
	Manual Tuning	Searches for the Analogue channels manually (p. 44)
Setup	Teletext	Analogue teletext display mode [FASTEXT] / [List] (p. 25)
	Teletext Character Set	Ireland only Selects teletext language font [West] / [East1] / [East2] [West] : English, French, German, Greek, Italian, Spanish, Swedish, Turkish, etc. [East1] : Czech, English, Estonian, Lettish, Rumanian, Russian, Ukrainian, etc. [East2] : Czech, Hungarian, Lettish, Polish, Rumanian, etc.
	Preferred Teletext	Ireland only Selects the preferred language for digital channel teletext service (depending on the broadcaster) [English] / [Welsh] / [Gaelic] / [Irish]
	Preferred Subtitles	Selects the preferred language for digital channel subtitles (depending on the broadcaster) [English] / [Welsh] / [Gaelic] / [Irish] To display subtitles → (p. 20) <input checked="" type="checkbox"/> provides aids in understanding and enjoyment with DVB subtitles (depending on the broadcaster).
	Input Labels	Labels or skips each input terminal (p. 48)
	Banner Display Timeout	Sets how long the Information banner (p. 18) stays on screen [0 (No display)] / [1] / [2] / [3] / [4] / [5] / [6] / [7] / [8] / [9] / [10] (seconds)
	VIERA Connect Banner	Sets the VIERA Connect introduction banner display [Off] / [On] (p. 16, 17)
	Playing Time Display	Set to [On] to display a continuous record of time spent using Game mode every 30 minutes [Off] / [On] • This function is available when [Game] is selected in [Viewing Mode] → (p. 31)
	Radio Mode	Sets the timer for turning off the screen automatically when a radio channel is selected [Off] / [5] / [10] / [15] / [20] (seconds) • The sound is active even if the screen turns off. • Press any buttons except Standby, Volume Up / Down and Sound Mute buttons to turn the screen on. • This function is effective in reducing power consumption when listening to a radio channel.

Menu	Item	Adjustments / Configurations (alternatives)	
Setup	Network Setup	Sets the network setting to use in your network environment (p. 73)	
	DivX® VOD	Displays DivX VOD registration code (p. 95)	
	Advance(isfcc)	Enables the advanced picture settings [Off] / [On] <ul style="list-style-type: none"> Set to [On] to enable the mode of [Professional1] and [Professional2] in [Viewing Mode]. Set to [On] to display the advanced items in the Picture Menu - [Advanced Settings], [Lock Settings] and [Copy Adjustment]. [Copy Adjustment] will be displayed when [Viewing Mode] is set to [Professional1] or [Professional2]. [isfcc] is the picture setting for the certified professional dealer. For details, consult your local dealer 	
	System Menu	USB Keyboard Layout	Selects the language that your USB Keyboard supports <ul style="list-style-type: none"> For the information of using USB Keyboard ➔ (p. 98)
		Shipping Condition	Resets all settings, for example, when moving house (p. 49)
		Owner ID	Inputs the owner ID (p. 50)
		Common Interface	Settings for watching encrypted channels (p. 51)
		System Update	Downloads new software to this TV (p. 52)
		Software Licence	Displays the software licence information
		System Information	Displays the system information of this TV
Other Settings	Power on Preference	Automatically selects the input when the TV is turned on [TV] / [AV] Set to [TV] to view picture from TV tuner. Set to [AV] to view input from an external equipment connected to a SCART terminal, e.g. satellite receiver. <ul style="list-style-type: none"> The external equipment must be switched on and sending a control signal for automatic switching at power on to occur. 	
	Power on Channel List	Automatically selects All Channels or Favourites list in the Information banner (p. 18) when the TV is turned on [All Channel List] / [Last] Set to [All Channel List] to display all the channels. Set to [Last] to display the one you selected last time. <ul style="list-style-type: none"> Not available in Analogue mode 	
	Power Save	Reduces brightness of picture to economise on power consumption [Off] / [On]	

- A different menu will be displayed when [Advance(isfcc)] in the Setup Menu is set to [On] or in the mode of Media Player / network service operations. (p. 53, 61 - 71, 79 - 82)
- Only available items can be selected.

Overview (Picture, Sound, Timer)

How to operate → (p. 30)

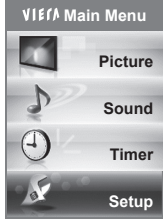

1/2

Viewing Mode	Dynamic
Contrast	[Slider]
Brightness	[Slider]
Colour	[Slider]
Sharpness	[Slider]
Tint	[Slider]
Colour Balance	Warm
Vivid Colour	Off
Reversal Film Effect	Off

2/2

C.A.T.S.	Off
P-NR	Off
3D-COMB	Off
Screen Display	On
Advanced Settings	Access
Reset to Defaults	Reset

(p. 31, 32)

- Available in NTSC
- Not available when [Viewing Mode] is set to [THX (True Cinema)] or [Professional1 / 2]
- Not available when [Viewing Mode] is set to [Professional1 / 2]
- Available when [Viewing Mode] is set to [Photo]

----- Available in NTSC / PAL

1/2

Advanced Settings	
White Balance	Access
Colour Management	Access
Gamma	Access
Intelligent Frame Creation	Off
24p Smooth Film	Off
Clear Cinema	Off
Resolution Enhancer	Off
Side Panel	Off
16:9 Overscan	Off

2/2

Advanced Settings	
DVI Input Setting	Normal
Pixel Orbiter	Auto
Scrolling Bar	Start

(p. 32, 54)

1/2

Mode	Music
Bass	[Slider]
Treble	[Slider]
Equaliser	Access
Balance	[Slider]
Headphone Volume	[Slider]
Surround	Off
Auto Gain Control	Off
Volume Correction	[Slider]
Speaker Distance to Wall	Over 30cm

2/2

Preferred Multi Audio	English
NICAM	Off
SPDIF Selection	Auto
HDMI1 Input	Digital
Audio Description	Access
Reset to Defaults	Reset

(p. 32, 33)

----- Available when [Mode] is set to [Music] or [Speech]

Equaliser

----- Available when [Mode] is set to [User]

Timer Programming	Access
Off Timer	Off
Auto Standby	Off

(p. 34)

- Available in DVB
- Available in Analogue
- Available in DVB, network video contents or Video mode
- Available in HDMI input

Timer Programming Wed 27.10.2010 10:46

Function	No.	Channel Name	Date	Start	End
Ext Rec.	72	BBC 2W <TIMER>	Wed 27 Oct	20:00	21:30 (90 min.)
Reminder	14	E4 The Bill	Wed 27 Oct	21:00	22:00 (60 min.)
Ext Rec.	1	BBC ONE DIY SOS	Wed 27 Oct	22:45	23:00 (15 min.)
Ext Rec.	1	BBC ONE <TIMER>	STTL Thu 28 Oct	10:30	11:30 (60 min.)

Change function: EXIT Select RETURN
 Store timer: 500GB (50%) 1/1

(p. 46)

Audio Description Menu

Audio Description	Off
Volume	[Slider]
Speakers	Off
Headphones	Off

Available in DVB (UK only) (p. 33)

Overview (Setup)

How to operate ➔ (p. 30)



1/2	
TV Guide Settings	Access
Eco Navigation	Access
Recording Setup	Access
Link Settings	Access
Child Lock	Access
DVB Tuning Menu	Access
Analogue Tuning Menu	Access
Display Settings	Access
Network Setup	Access
DivX® VOD	Access
2/2	
Advance (isfcc)	Off
System Menu	Access
Other Settings	Access

(p. 34 - 36)

Other Settings	
Power on Preference	TV
Power on Channel List	Last
Power Save	Off

- Available in DVB

(p. 36)

Recording Setup	
USB HDD Setup	Access
One Touch Recording	180 minutes
Rewind LIVE TV	Off

(p. 55)

Child Lock-PIN Entry	
Please enter new PIN	
PIN	* * * *

(p. 47)

DVB Tuning Menu	
Favourites Edit	Access
Channel List	Access
Auto Setup	Access
Channel Sorting by Region	Access
Manual Tuning	Access
Update Channel List	Access
New Channel Message	On
Signal Condition	Access

Available in DVB (p. 40 - 43)

DVB Update Channel List			
Progress	CH 21	68	
This will take about 3 minutes.			
CH	Channel Name	Type	Quality
Free TV: 0	Pay TV: 0	Radio: 0	Data: 0
Searching			

(p. 43)

Analogue Tuning Menu	
Channel List	Access
Auto Setup	Access
Manual Tuning	Access

Available in Analogue (p. 40, 43, 44)

Network Setup	
Connection Test	Access
Network Type	Wired
Access Point Settings	Access
IP/DNS Settings	Access
Network Link Settings	Access
Software Update	Access
MAC Address	ab-cd-ef-gh-ij-kl

(p. 73)

System Menu	
USB Keyboard Layout	English(UK)
Shipping Condition	Access
Owner ID	Access
Common Interface	Access
System Update	Access
Software Licence	Access
System Information	Access

(p. 36)

System Update	
Auto Update Search in Standby	Off
System Update Search Now	Access

(p. 52)

Common Interface	
Slot 1:	Module inserted

Available in DVB

(p. 51)

Owner ID	
Please enter new PIN	
PIN	* * * *

(p. 50)

Shipping Condition	
All tuning data will be erased	
Are you sure ?	
Are you sure ?	

(p. 49)

TV Guide Settings Menu

TV Guide View	Normal
GUIDE Plus+ Postcode	Access
GUIDE Plus+ Information	Access

--- (UK only) --- (p. 34)

Enter Postcode

Postcode

A	B	C	D	E	F	G	H	I	J	K	L	M	N	O	P	Q	R	S	T
U	V	W	X	Y	Z	0	1	2	3	4	5	6	7	8	9				

1 4 7 0
2 5 8 3
3 6 9

(p. 34)

Link Settings

VIERA Link	On
HDMI Content Detection	Off
AV1 out	TV
Standby Power Save	On
Intelligent Auto Standby	On (No reminder)
Q-Link Download	Access

(p. 34)

Sending Preset Data
Please wait!

0% 100%

Remote control unavailable

(p. 34)

Child Lock

Change PIN	Access
Child Lock List	Access
Parental Rating	No limit

--- Available in DVB (Ireland only) --- (p. 47)

Child Lock List - TV and AV

Name	Input	Type	Lock
101 BBC 1 Wales	DVB	Free TV	▲
7 BBC THREE	DVB	Free TV	▲
14 E4	DVB	Free TV	▲
VCR	Analogue	Analogue	
1 BBC1	Analogue	Analogue	
2 ****	Analogue	Analogue	▲
AV1	External	AV	
AV2	External	AV	

(p. 47)

DVB Manual Tuning

Frequency [CH21] 474.00 MHz

Signal Quality 0 10

Signal Strength 0 10

No.	Channel Name	Type	New
Free TV: 0	Pay TV: 0	Radio: 0	Data: 0
		Stopped	

(p. 41)

All DVB Channels

- 70 CBBC Channel
- 72 Cartoon Nwk
- 105 BBCi
- 719 BBC Radio Wales
- 720 BBC Radio Cymru
- 1 BBC ONE Wales
- 7 BBC THREE

(p. 43)

DVB Favourites Editor

All DVB Channels	Favourites1
1 BBC One Wales	
7 BBC THREE	
14 E4	
70 CBBC Channel	
72 Cartoon Nwk	
105 BBCi	
719 BBC Radio Wales	
720 BBC Radio Cymru	

(p. 42)

Channel Sorting by Region

GBR>

Best signal quality (All Regions)

England Regions>

Region choice available

(p. 41)

DVB Auto Setup

Progress CH 21 68

This will take about 3 minutes.

CH	Channel Name	Type	Quality
62	CBBC Channel	Free TV	10
62	BBC Radio Wales	Free TV	10
62	E4	Free TV	10
62	Cartoon Nwk	Free TV	10

Free TV: 4 Pay TV: 0 Radio: 0 Data: 0

Searching

(p. 40)

Analogue Manual Tuning

1 BBC1 CH33

Manual Tuning 21 Store ->33

(p. 44)

Analogue Auto Setup

Scan CH 21 68

This will take about 3 minutes.

CH	Channel Name
29	
30	

Analogue: 2 Searching

(p. 40)

Analogue Channel List

- 1 BBC1
- 2 ****
- 3 ****
- 4 ****
- 5 ****
- 6 ****
- 7 ****

(p. 44)

Display Settings

Teletext	FASTEXT
Teletext Character Set	West
Preferred Teletext	Irish
Preferred Subtitles	English
Input Labels	Access
Banner Display Timeout	3 seconds
VIERA Connect Banner	On
Playing Time Display	On
Radio Mode	Off

--- Available in Analogue ---
--- (Ireland only) ---
--- Available in DVB (Ireland only) ---
--- Available in DVB ---

(p. 35)

Input Labels

AV1	DVD
AV2	AV2
COMPONENT	COMPONENT
HDMI1	HDMI1
HDMI2	HDMI2
HDMI3	HDMI3
HDMI4	HDMI4
DVB	DVB
Analogue	Analogue

(p. 48)

Retuning from Setup Menu

Automatically retune the channels received in the area.

- This function is available if channel tuning is already performed.
- Only the selected mode is retuned. All the previous tuning settings are erased.
- If Child Lock PIN number (p. 47) has been set, the PIN number is required.
- If tuning has not been done completely → **[Manual Tuning]** (p. 41, 44)

DVB or Analogue channels



1 Select DVB or Analogue

TV

2 Display the menu

MENU

3 Select [Setup]

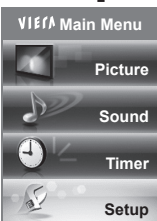

4 Select [DVB Tuning Menu] or [Analogue Tuning Menu]

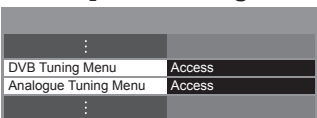

- The displayed item depends on the selected mode.

5 Select [Auto Setup]

Example :



6 Start Auto Setup (Settings are made automatically)

Example : DVB

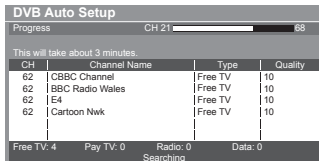
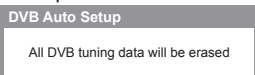

Example : Analogue

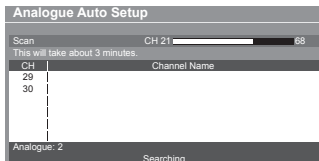
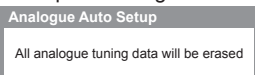

- The analogue settings are downloaded to a Q-Link compatible equipment connected to the TV in Analogue mode.
When the operation is completed, the channel at the lowest position will be displayed.

■ To return to TV

EXIT



For Auto Setup, using the buttons on the side panel of the TV (p. 9)

1 Press repeatedly until [Auto Setup] appears



2 Access [Auto Setup]



3 Start [Auto Setup]

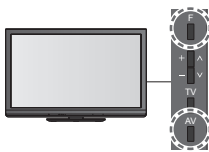

• To return to TV

F



Tuning and Editing Channels (DVB)

You can retune channels or make your favourite channel lists, skip unwanted channels, etc.



1 Select DVB

TV

2 Display the menu

MENU

3 Select [Setup]

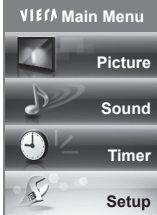

4 Select [DVB Tuning Menu]



5 Select one of the following functions

DVB Tuning Menu	
Favourites Edit	Access
Channel List	Access
Auto Setup	Access
Channel Sorting by Region	Access
Manual Tuning	Access
Update Channel List	Access
New Channel Message	On
Signal Condition	Access

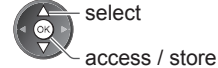

- [Auto Setup] → “Retuning from Setup Menu” (p. 40)

■ To return to TV

EXIT



Sort DVB channels according to the region [Channel Sorting by Region] UK only

You can sort DVB channels so that those with the best signal quality, or those for your preferred region, appear nearer the top of your Channel List.

Normally, you should select [Best signal quality (All Regions)].

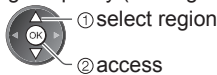
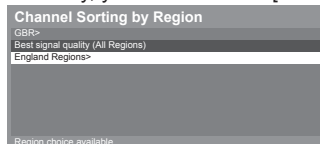

(select repeatedly until you reach the available region)

- If you choose to select your preferred region, you could find channels with a weaker signal appear nearer the top of your Channel List. If you have any image or sound problems, select [Best signal quality (All Regions)] instead.

Set DVB channel manually [Manual Tuning]

Normally use [Auto Setup] or [Update Channel List] to retune DVB channels.

If tuning has not been done completely or for adjusting the direction of the aerial, use this function.

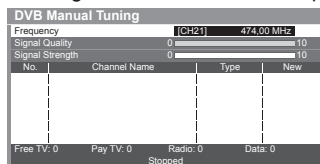

Ireland

1 Adjust frequency for each channel

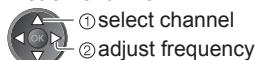

2 Search



- Set where the level of [Signal Quality] becomes the maximum.

- All channels found will be added to the Channel List.

List favourite DVB channels [Favourites Edit]

Create your favourite channel lists from various broadcasters (up to 4: [Favourites]1 to 4). The DVB Favourites lists are available for switching in the Information banner (p. 18) and from [Category] in the TV Guide screen (p. 21).

1 Select a channel to list ([-]): Encrypted channel)

select

- To display other Favourites (green)

2 Add it to the Favourites list

- To add all channels to the list (yellow)

To edit Favourites list

While the cursor is in the Favourites field to edit

- To delete a channel (green)
- To delete all channels (yellow)

① select

- To move the channel (green)

Select the new position or Select the turn Store (green)

- To name the Favourites (red)

Set characters (maximum: ten characters)

① select

② set

- To use numeric buttons
- “Characters table for numeric buttons” (p. 97)

3 Store

BACK/RETURN

OK

Note

- Channel position numbers (known as logical channel List) can be swapped in Channel List. To swap the channel position number → [Channel List] (p. 43)

Check DVB signal [Signal Condition]

Selects a channel and checks the DVB signal condition.

A good Signal Strength is not an indication of best signal for DVB reception.

Please use the Signal Quality indicator as follows :

[Signal Quality] :

- Green bar → Good
- Yellow bar → Poor
- Red bar → Bad (Check the Terrestrial aerial)

Example :

DVB Signal Condition

Channel Name: 170 CBBC Channel

Signal Quality: 0

Signal Strength: 0

Bit Error Rate: 0.00E+00

Network Name: Memovision

Frequency: 1802.00 MHz: 64 QAM, 6940 S/s

- To change the channel



Display a notification message [New Channel Message]

Selects whether to give a notification message when a new DVB channel is found. [Off] / [On]

New channels found!
Press OK to update channel list.
Press EXIT to ignore.

- Selecting OK will perform [Update Channel List].

Skip unwanted DVB channels, Edit DVB Channels [Channel List]

You can hide unwanted DVB channels. The hidden channels cannot be displayed except in this function. Use this function to skip unwanted channels.

Select a channel and [reveal] / [hide]

All DVB Channels	
<input checked="" type="checkbox"/>	70 CBBC Channel
<input checked="" type="checkbox"/>	72 Cartoon Nwk
<input checked="" type="checkbox"/>	105 BBCi
<input type="checkbox"/>	719 BBC Radio Wales
<input type="checkbox"/>	720 BBC Radio Cymru
<input type="checkbox"/>	1 BBC ONE Wales
<input checked="" type="checkbox"/>	7 BBC THREE

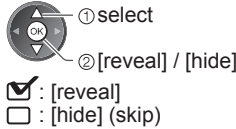

• To reveal all channels
 (yellow)

To edit channels

You can also edit each channel in Channel List.

- To retune each channel → **[Manual Tuning]** (p. 41)
 (red)
 (only for the revealed channels)

- To swap the channel position number (logical channel number)
 (green) → Enter the new position number

1	2	3
4	5	6
7	8	9
0		

 → Store (green)

Channel position number



Update DVB channel automatically [Update Channel List]

You can add new channels, delete removed channels, update channel name and position automatically to Channel List.

Example : [UK]

DVB Update Channel List			
Progress	CH 21	68	
This will take about 3 minutes.			
CH	Channel Name	Type	Quality
Free TV: 0	Play TV: 0	Radio: 0	Data: 0
Searching			

- Channel List is updated while keeping your settings in [Favourites Edit], [Channel List], [Child Lock], [Timer Programming], etc.
- Depending on the signal condition, the update may not work properly.

(Analogue)

You can retune channels or skip unwanted channels, edit channels etc.



1 Select Analogue

TV

2 Display the menu

MENU

3 Select [Setup]

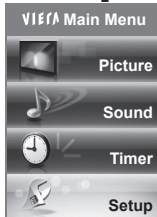

4 Select [Analogue Tuning Menu]



5 Select one of the following functions

Analogue Tuning Menu	
Channel List	Access
Auto Setup	Access
Manual Tuning	Access



- [Auto Setup] → **"Retuning from Setup Menu"** (p. 40)

■ To return to TV

EXIT



Skip unwanted Analogue channels, Edit Analogue channels [Channel List]

You can hide unwanted Analogue channels.

The hidden channels cannot be displayed except in this function. Use this function to skip unwanted channels.

Select a channel and [reveal] / [hide]

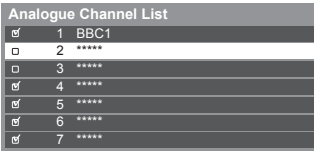

- To reveal all channels
 (yellow)

To edit channels

You can also edit each channel in Channel List.

- To retune each channel ([Manual Tuning]) (see below)



- To move the channel position



- To rename the channel name

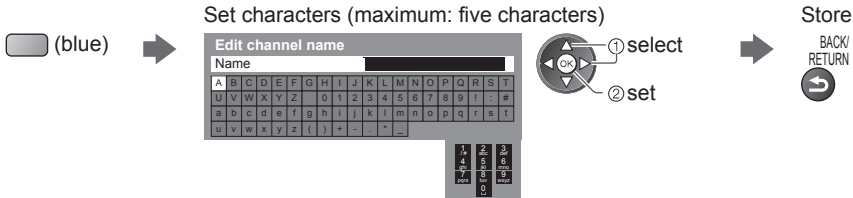

- To use numeric buttons

➔ **“Characters table for numeric buttons” (p. 97)**

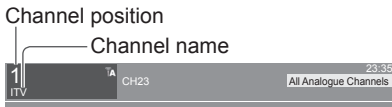

Note

- If a VCR is connected only with the RF cable, edit [VCR].

Set Analogue channel manually [Manual Tuning]

[Fine Tuning] (Ireland only)

Use to make small adjustments to the tuning of an individual programme (affected by weather conditions, etc.)

[Manual Tuning]

Set Analogue channel manually after Auto Setup.

- If a VCR is connected only with the RF cable, it is recommended to select channel position [0].

Example : (Ireland)



1 Select the channel position 2 Select the channel 3 Search



4 Select [Store]



Timer Programming

Timer Programming from Menu

The Timer Programming menu allows you to choose programmes that you wish to remind watching or record to the external recorder or the USB HDD. At the correct time, the TV will tune to the correct channel automatically to record even if the TV is in Standby mode.

TV Guide may also be used to set timer programming event (p. 22).

- Timer Programming can store up to 15 events.
- For recording using Timer Programming, the TV must be either On or in standby. For reminders to be displayed, the TV must be On.
- No other channel can be selected while the recording of Timer Programming is in progress.
- It may not be possible to record an encrypted programme (which is copy-protected).
- When recording programmes to the external recorder, be sure to make the proper settings on the recorder connected to the TV. If a compatible recorder with Q-Link or similar technologies is connected to the TV (p. 84) and the [Link Settings] (p. 34) are correct, no setting of the recorder is required. Also read the manual of the recorder.
- If the recorder is not compatible with Q-Link or similar technologies, set the timer of the recorder in addition to the Timer Programming on the TV. For preparations of a recorder, read the manual of the recorder.
- When recording programmes to the USB HDD, be sure to format the USB HDD and enable it for recording in [Recording Setup] (p. 55).
- Recordings to the external recorders are always in standard definition composite video via SCART, even if the original programme is in high definition.



1 Select the tuner you want to use (DVB or Analogue)



2 Display the menu



3 Select [Timer]

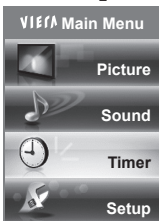

To return to TV

EXIT

To unlock the tuner and stop recording



4 Select [Timer Programming]

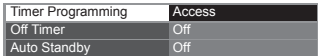

Note

- Check that the LED is orange. If not, timer programmes are not active or not stored.
- Timer Programming reminder messages will remain displayed until one of the following occurs:
 - You press the OK button to view the programme or the EXIT button to cancel the reminder.
 - The timer programming event that the reminder is set for ends.
- "!" identifies that any timer programming events have overlapped. [Ext Rec.] and [USB HDD Rec.] are given priority over [Reminder]. As for the overlapped two or more [Ext Rec.] / [USB HDD Rec.], the first timer programming event starts and finishes as programmed. The next timer programming event can then start.
- 2 minutes before the starting time, a reminder message appears if you are watching TV.
 - To remove the message and start the programme
 - To cancel the Timer Programming

- The recording of Timer Programming will automatically change to the programmed channel 10 seconds before the start time.
- To stop recording of the timer programming event, it may be necessary to stop the recorder manually.
- The recording of Timer Programming will be performed even if the TV is in Rewind LIVE TV recording (p. 58) or Pause Live TV recording (p. 87). In this case, these recordings will be cancelled.

Set timer programming event details [Timer Programming]

1 Start making the settings



2 Select the function ([Ext Rec.], [USB HDD Rec.] or [Reminder])



select

[Ext Rec.] / [USB HDD Rec.] :

to record the programme to the external recorder or the USB HDD
When the start time comes, the channel will be switched automatically and the video and audio signals will be output. 2 minutes before the starting time, a reminder message appears if you are watching TV.

[Reminder] : to remind you to watch the programme

When you are watching TV, a reminder message appears 2 minutes before the start time.
Press the OK button to switch to the programmed channel.

3 Set the channel, date and time (repeat the operations as below)

Set items in the order of 1 to 4.



select the item



set

• 1, 3 and 4 can also be entered with numeric buttons.



Store



! : Displayed if the timer programming events are overlapped

Timer programming - Programmes according to the time setting

Function	No.	Channel Name	Date	Start	End
Ext Rec.	72	BBC 2W <TIMER>	Wed 27 Oct	20:00 (90 min.)	21:30
Reminder	14	E4 The Bill	Wed 27 Oct	21:00 (60 min.)	22:00
Ext Rec.	1	BBC ONE DIY SOS	Wed 27 Oct	22:45 (15 min.)	23:00
Ext Rec.	1	BBC ONE <TIMER>	Thu 28 Oct	10:30 (60 min.)	11:30

Information of the USB HDD (if available)
Remaining Capacity: 500GB (50%)

Duration (automatic display)
Records with subtitles (if available)
• To indicate this
 (yellow)
(Press again to remove subtitles)

2 Date
 one day ahead
 daily or weekly (press repeatedly)

- [Daily Sun-Sat] : Sunday to Saturday
- [Daily Mon-Sat] : Monday to Saturday
- [Daily Mon-Fri] : Monday to Friday
- [Weekly Sat/Fri/Thu/Wed/Tue/Mon/Sun] : Same time on the same day every week

1 Channel number

: DVB / : Analogue

• You cannot change the mode within the menu.

4 Ending time

3 Starting time

UK only

Guide : Guide link programming - Programmes according to the TV Guide signal (p. 23)

\$P : Split Programme programming (p. 23)

• These functions are not available in Analogue mode.

Guide link programming is Timer Programming which is controlled by information from the TV Guide; if programme start and end times are changed by the broadcaster, the timer programming event will follow the change. A Split Programme programming is a Guide link programming which is interrupted by one or more other programmes. Note that Guide link programming (including Split Programme programming) only works reliably if correct information is received from broadcasters.

■ To change a timer programming event

Select the programme to be changed



① select

Correct as necessary (as above)

② access

■ To record with subtitles (if available)

Select the programme to record with subtitles



(yellow)

• Each time pressed:
auto ↔ off

■ To cancel a timer programming event

Select the programme to be deleted



(red)



■ To cancel a timer programming event temporarily

Select the programme to be cancelled



(blue)

• Each time pressed:
cancel ↔ stop cancelling

■ To view details of the programming (only for Guide link programming) **UK only**

Select the programme to be viewed



• Press again to return to Timer Programming menu.

Child Lock

You can lock specific channels / AV input terminals and control who watches them. When the locked channel / input is selected, a message appears; by entering the PIN number, you can watch it.



1 Display the menu



2 Select [Setup]



3 Select [Child Lock]



■ To return to TV
EXIT



Control channel audience [Child Lock]

1 Enter the PIN number (4 digits)



- Enter the PIN number twice at first setting.
- Make a note of the PIN number in case you forget it.

2 Select [Child Lock List]



3 Select the channel / input to be locked

Name	Input	Type	Lock
101 BBC 1 Wales	DVB	Free TV	🔒
7 BBC THREE	DVB	Free TV	🔒
14 E4C	DVB	Free TV	🔒
VCR	Analogue	Analogue	🔒
1 BBC1	Analogue	Analogue	🔒
2 ****	Analogue	Analogue	🔒
AV1	External	AV	🔒
AV2	External	AV	🔒



• To cancel
Select the locked channel / input



• To lock all
 (green)

🔒 : Appears when the channel / input is locked

• To cancel all locks
 (yellow)

• To jump to the top of the next input
 (blue)

■ To change the PIN number

1. Select [Change PIN]

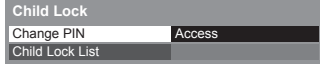

2. Enter a new PIN number twice



■ To set Parental Rating Ireland only

If the DVB programme has the rated information for over the selected age, you have to enter the PIN number to watch (depending on the broadcaster). Select [Parental Rating] and set an age for the restriction of programmes.

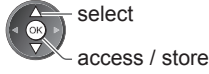

Note

- Setting [Shipping Condition] (p. 49) erases the PIN number and all settings.

Input Labels

For easier identification and selection of the input mode, you can label each input mode or skip terminals that are not connected to any equipment.

- To select the input mode → (p. 27)



1 Display the menu



2 Select [Setup]

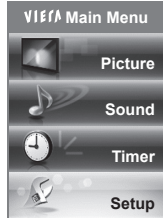

3 Select [Display Settings]



4 Select [Input Labels]



5 Select an input terminal

Input Labels	
AV1	DVD
AV2	AV2
COMPONENT	COMPONENT
HDMI1	HDMI1
HDMI2	HDMI2
HDMI3	HDMI3
HDMI4	HDMI4
DVB	DVB
Analogue	Analogue

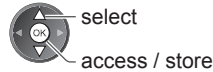

The labels you set will be displayed in the [Input Selection] menu (p. 27), [TV Selection] menu or banner.

- If [Skip] is selected, the input will not be displayed in the [Input Selection] menu and you cannot select the mode.

- To return to TV

EXIT



■ User input

You can name each input mode yourself.

1 Select [User input]



2 Set characters (maximum : ten characters)

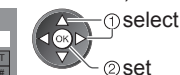
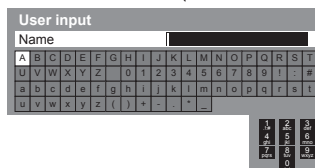

3 Store



- To use numeric buttons
→ “Characters table for numeric buttons” (p. 97)

Shipping Condition

Resets the TV to its original condition with no channels tuned in.

All settings other than [Owner ID] and [USB HDD Setup] are reset (channels, picture, sound settings, etc.).

• To retune TV channels only, e.g. after moving house ➔ **“Retuning from Setup Menu” (p. 40)**



1 Display the menu



2 Select [Setup]

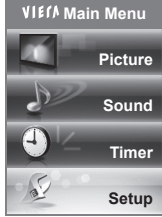

3 Select [System Menu]



4 Select [Shipping Condition]

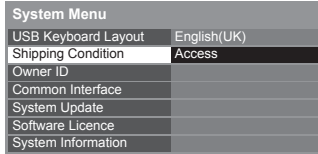

■ To return to TV

EXIT



Restore Settings [Shipping Condition]

1 Check the message and initialise

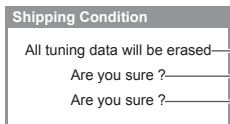

2 Follow the on screen instructions



• [Auto Setup] will automatically start when Mains power On / Off switch is next turned On. (p. 12)

Owner ID

Entry of the PIN number and personal information (your name, address and postcode). In the unfortunate event of theft, the Owner ID will help the Police to determine the owner.



1 Display the menu



2 Select [Setup]

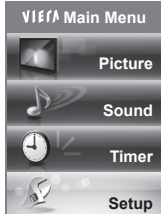

3 Select [System Menu]



4 Select [Owner ID]



■ To return to TV

EXIT



Input owner ID [Owner ID]

1 Enter the PIN number (4 digits)



- Enter the PIN number twice at first setting.
- Make a note of the PIN number in case you forget it. The PIN number cannot be reset.

2 Select the item (NAME / HOUSE NO / POSTCODE) and set characters

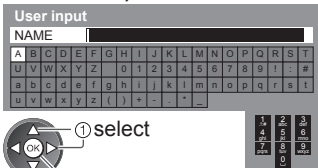
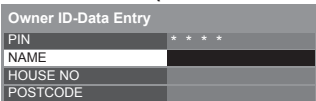

Return to select other items



- Select the next item and repeat the operations.



- To use numeric buttons
- ▶ “Characters table for numeric buttons” (p. 97)

3 Exit the menu

EXIT



■ To check the personal information stored

Hold down for about 5 seconds



- The PIN number is not displayed.

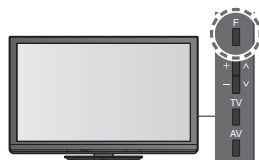

■ To change the PIN number

1. Select [PIN]

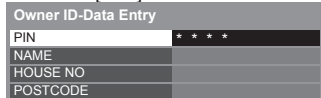

2. Enter a new PIN number twice



Using Common Interface

The Common Interface Module menu provides access to software contained on Common Interface (CI) Modules. This TV works only for Pay TV modules complying with CI standard.

- This function is not available for BskyB's Sky channels.
- Video and audio signals may not be output depending on broadcasts or services.

Caution

- Turn Off Mains power On / Off switch whenever inserting or removing the CI module.
- If a viewing card and a card reader come as a set, first insert the card reader, then insert the viewing card into the card reader.
- Insert the module in the correct direction.

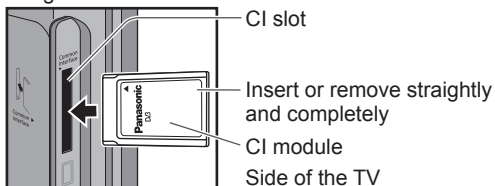

Insert the CI module (optional)

- The features that appear on screen are dependent on the contents of the selected CI module.
- Follow the instructions that came with the viewing card to tune in the encrypted channels. If encrypted channels do not appear, perform the below to verify the card is recognised by the TV.
- For more details, see the manual of the CI module, or check with the broadcaster.

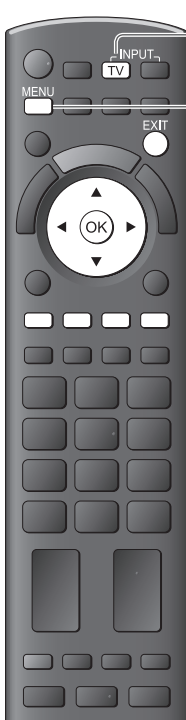

1 Select DVB



2 Display the menu



3 Select [Setup]



4 Select [System Menu]



5 Select [Common Interface]

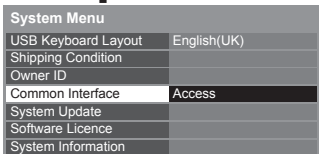

6 Access Common Interface



■ To return to TV

EXIT



■ How to operate services by following the on screen operation guide

(Check the instructions provided with the CI module.)

Example :

- Select, go



- Symbol : ◀▶▼▲



- Coloured characters



- On screen operation guide may not correspond to the remote control buttons.

Updating the TV Software

From time to time, a new version of software may become available for download to enhance the performance or operations of the TV.

In DVB mode, a notification banner will appear when one of the BBC channels is turned to if a new available software is found.

- To download
- If you choose not to download



You can update any new software automatically or manually.



1 Display the menu



2 Select [Setup]



3 Select [System Menu]



4 Select [System Update]

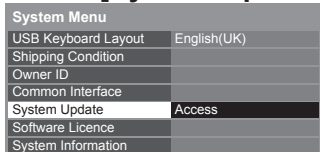

■ To return to TV



Update TV's software system [System Update]

■ To update automatically

Select [Auto Update Search in Standby] and set to [On]

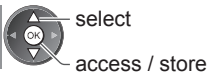

- Automatically performs a search in standby and downloads an update, if any software updates are available.

- The automatic updating is performed at night under the following conditions:

- Standby (TV turned Off with the remote control)
- Recording of Timer Programming, Direct TV Recording or One Touch Recording is not in progress.

If System Update is performed, the software will be updated (it may change TV functions).

If you do not wish to do so, set [Auto Update Search in Standby] to [Off]. The notification banner will keep appearing during the period of new software availability, usually 2 to 3 days.

■ To update immediately

1 Select [System Update Search Now]



2 Searches for an update (for several minutes) and displays a corresponding message if any

3 Download



Note

- Download may take up to 60 minutes.
- During software download and update, DO NOT perform any operations on the TV or switch Off the TV.

Advanced Picture Settings

You can adjust and setup the detailed picture settings for each input and Viewing Mode.

- To use this function completely, set [Advance(isfcc)] to [On] in the Setup Menu. ➔ (p. 36)



1 Select the input mode to adjust and setup
➔ (p. 17, 27)



2 Display the menu



3 Select [Picture]

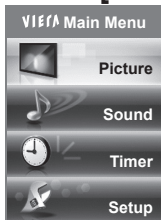

4 Select [Viewing Mode] and set the mode

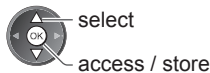
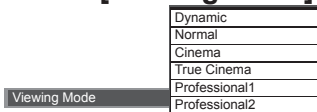

5 Select one of the following functions

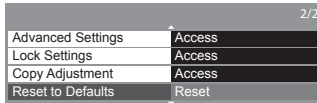

- [Copy Adjustment] is available when [Viewing Mode] in the Picture Menu is set to [Professional1] or [Professional2].

■ To return to TV

EXIT



Lock the picture setting [Lock Settings]

Advanced Settings can be locked for each Viewing Mode and input.

Additionally, [Contrast], [Brightness], [Colour], [Sharpness], [Tint] and [Reset to Defaults] in the Picture Menu can be locked for [Professional1] and [Professional2].

1 Enter the PIN number (4 digits)



2 Select [Adjustment Lock] and set to [On]

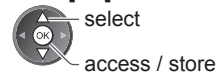
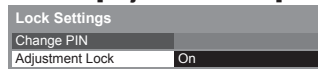

- Enter the PIN number twice at first setting.
- Make a note of the PIN number in case you forget it.

■ To change the PIN number

1. Select [Change PIN]

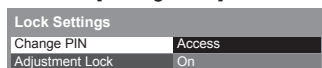

2. Enter a new PIN number twice



Adjust the detailed picture settings [Advanced Settings]

Advanced Settings	
White Balance	Access
Colour Management	Access
Gamma	Access
⋮	

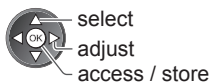

Menu	Item	Adjustments / Configurations (alternatives)		
Picture	White Balance	R-Gain	Adjusts the white balance of bright red area	
		G-Gain	Adjusts the white balance of bright green area	
		B-Gain	Adjusts the white balance of bright blue area	
		R-Cutoff	Adjusts the white balance of dark red area	
		G-Cutoff	Adjusts the white balance of dark green area	
		B-Cutoff	Adjusts the white balance of dark blue area	
		Reset to Defaults	Press the OK button to reset to the default White Balance	
	Advanced Settings	Colour Management	R-Hue	Adjusts the picture hue of red area
			G-Hue	Adjusts the picture hue of green area
			B-Hue	Adjusts the picture hue of blue area
			R-Saturation	Adjusts the saturation of red area
			G-Saturation	Adjusts the saturation of green area
			B-Saturation	Adjusts the saturation of blue area
			R-Luminance	Adjusts the luminance of red area
			G-Luminance	Adjusts the luminance of green area
			B-Luminance	Adjusts the luminance of blue area
			Reset to Defaults	Press the OK button to reset to the default Colour Management
	Gamma	Gamma	Gamma	Switches the gamma curve [S Curve] / [1.8] / [2.0] / [2.2] / [2.4] / [2.6] • Please note the numerical values are reference for the adjustment.
			Reset to Defaults	Press the OK button to reset to the default Gamma

- [Colour Management] is available when [Viewing Mode] in the Picture Menu is set to [Professional1] or [Professional2].

Copy the settings to the other input [Copy Adjustment]

You can copy the selected [Professional1] or [Professional2] settings to that of the other input. The settings of [Contrast], [Brightness], [Colour], [Sharpness], [Tint] and [Advanced Settings] will be copied.

Select the destination to copy to

Copy Adjustment	
Destination	All

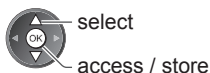

- You cannot copy to the locked mode.

USB HDD Recording

You can record the digital TV programmes to the connected USB HDD and enjoy playing back in various ways.

- Analogue TV programme cannot be recorded to the USB HDD.
- The data broadcasting (MHEG, etc.), radio broadcasting and the periods without any signal will not be recorded.
- Not all the programmes can be recorded depending on the broadcaster and service provider.
- For more information of the USB HDD → (p. 96)

Caution

- All data in the USB HDD will be erased in the following cases :
 - When formatting the USB HDD with the TV → **“Setting for USB HDD” (see below)**
 - When formatting the USB HDD to use on PC
- When the TV is repaired due to a malfunction, you may have to format the USB HDD again with the TV to use it. (All data will be erased when formatting.)
- In order to use the USB HDD with your PC after recording with this TV, format it again on your PC. (Special operations or tools may be necessary to format on your PC. For details, refer to the manual of the USB HDD.)
- The data recorded to the USB HDD with this TV can only be played back on this TV. You cannot play back its contents with another TV (including the TV of the same model number) or any PCs.

USB HDD connection

Connect the USB HDD to the USB 3 port.

socket outlet

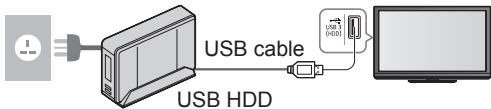

- Be sure to connect the USB HDD to the socket outlet.
- Do not turn off or disconnect the USB HDD during operation. It may cause malfunction of the drive or damage the recorded data.
- To remove the USB HDD safely from the TV → (p. 19, 56)

Setting for USB HDD

Format and setup the USB HDD with this TV in order to use it for recording.

- Before the settings, connect the USB HDD (see above) and be sure to turn on the USB HDD.
- You cannot change the settings for the USB HDD while recording is in progress.
- Please note that USB HDD will be formatted and all data in it will be erased when you format it.



1 Display the menu



2 Select [Setup]

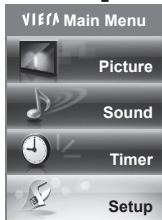

3 Select [Recording Setup]



4 Select [USB HDD Setup] and set

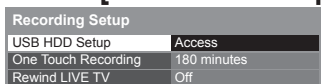

■ To return to TV

EXIT



Setup the USB HDD [USB HDD Setup]

All the USB devices recognised as a mass storage device will be listed.

- You can only choose one USB HDD for recording at a time.

1 Select the USB HDD for recording and start setup

USB HDD Setup	
Product	Name
USB Drive A	
USB Flash Disk	



- Some USB HDD may not be displayed.
- For the information of the highlighted device



2 Caution and confirmation of using USB HDD

Select [Yes] to proceed

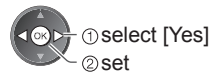
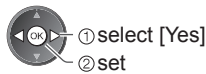
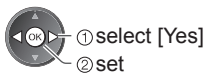
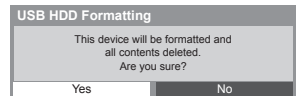
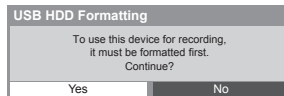
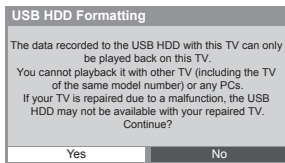

3 Confirmation of USB HDD name

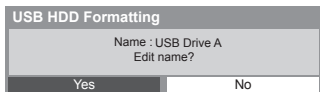

The name for the USB HDD is created automatically. If you want to edit the name, select [Yes].

Set characters



- To use numeric buttons
➔ “Characters table for numeric buttons” (p. 97)

4 Confirmation to enable USB HDD for recording

If the formatted USB HDD for recording already exists, this confirmation screen will be displayed to switch to enable this USB HDD for recording.

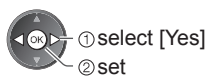
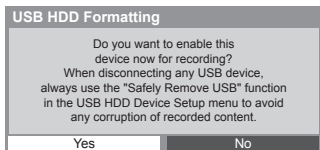

USB HDD Setup	
Product	Name
USB Drive A	USB HDD 1
USB Flash Disk	

Mode

- ▶ : The USB HDD is available for recording / playing back.
Only one USB HDD on the list can be available for recording.
- ▶ : The USB HDD is available for playing back.

USB HDD name is displayed

- To remove the USB HDD safely from the TV
 (yellow)
- To format
 (red)
- To edit USB HDD name
 (green)
- To set “Safely remove USB” in other conditions ➔ (p. 19)

Recording the TV programme to USB HDD

You can record the current programme immediately by using [One Touch Recording]. You can also record the current programme constantly for the selected period by using [Rewind LIVE TV] so that you can go back or pause the current programme.

- Ensure the connection and setup are completed before start recording → (p. 55, 56)
- Ensure not to connect or disconnect any USB devices during USB HDD recording. Otherwise the recording may not work properly.
- If the remaining capacity of the USB HDD is run out, the recording cannot be done.



1 Display the menu



2 Select [Setup]

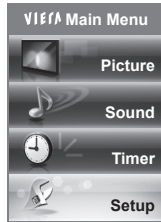

3 Select [Recording Setup]

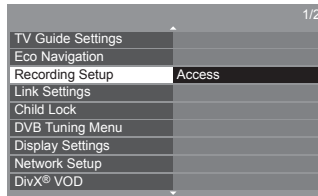

4 Select [One Touch Recording] or [Rewind LIVE TV]

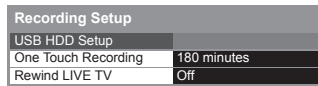

■ To return to TV

EXIT



One touch direct TV recording - What you see is What you record [One Touch Recording]

Recording the current programme in the USB HDD immediately.

Select the maximum recording time [30] / [60] / [90] / [120] / [180] (minutes)

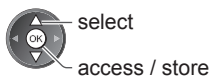
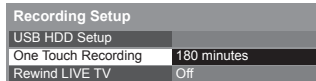

LED will turn to orange (flash) while One Touch Recording is in progress.

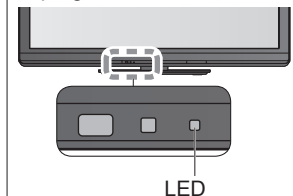

■ To start One Touch Recording

Set the position to “TV”



- No other channel can be selected while the recording is in progress.

■ To stop recording on the way



■ To playback or delete the recorded contents → “Recorded TV mode” (p. 67)

- Even if One Touch Recording is in progress, you can playback all the contents. However, the recording may not work properly while playback.

Record constantly [Rewind LIVE TV]

Recording the currently viewed channel constantly.

Select [Auto] to start Rewind LIVE TV

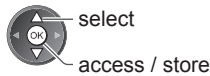
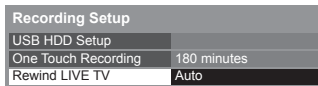

- When you select [Auto], the recording will start automatically.

■ To operate the Rewind LIVE TV

Set the position to “TV”



- To pause
- To search backward (up to 90 minutes)



- After pausing or searching backward, the following buttons are available to operate.

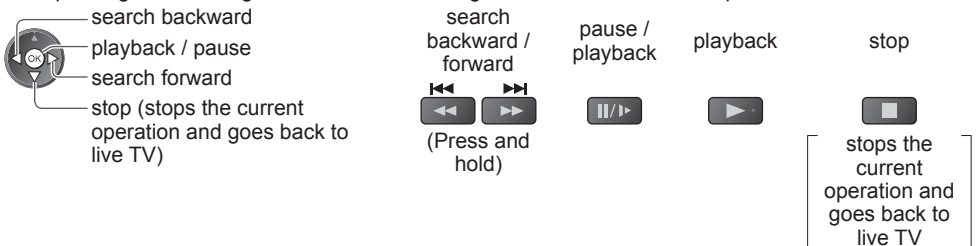

■ To stop the Rewind LIVE TV

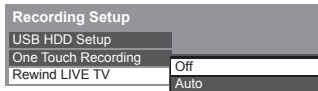

- If you stop the Rewind LIVE TV, the recorded content for the Rewind LIVE TV will be deleted.

- Rewind LIVE TV will be stopped and the recorded content deleted automatically in the following conditions :
(Even if Rewind LIVE TV stops for the following conditions, as long as the setting is [Auto], the new recording will start automatically in a condition that makes the recording available.)
 - selected other channels
 - selected locked channel
 - selected invalid channel
 - no TV signal
 - when the other recording starts
 - when the TV is turned off or standby

Using Media Player

Media Player allows you to enjoy photo, video or music recorded on an SD Card and a USB Flash Memory, and recorded contents on the formatted USB HDD.

VIERA IMAGE VIEWER is the function of the easy viewing for photos or videos recorded on an SD Card on the TV screen by simply inserting into the SD Card slot.

Photo mode : Still pictures recorded by digital cameras will be displayed.

Video mode : (For SD Card or USB Flash Memory) Moving pictures recorded by digital video cameras will be played back.

Recorded TV mode : (For USB HDD) TV programmes recorded in USB HDD with this TV will be played back.

Music mode : Digital music data will be played back.

- During the operation, audio signal is output from AV1, AUDIO OUT, DIGITAL AUDIO OUT and HDMI2 (ARC function) terminals. But no video signals are output. AV1 can output audio signal if [AV1 out] is set to [Monitor] in the Setup Menu (p. 34). To use HDMI2 with ARC function, connect an amplifier that has ARC function (p. 82) and set to use theatre speakers (p. 88).
- [Date] shows the date on which the recording was made by the recording equipment. The file without record of the date is shown "****/**/*****".
- The picture may not appear correctly on this TV depending on the recording equipment used.
- Display may take some time when there are many files and folders.
- Partly degraded files might be displayed at a reduced resolution.
- Picture setting may not work depending on the conditions.
- The folder and file names may be different depending on the digital camera or digital video camera used.

To insert or remove the SD Card / USB Flash Memory

- For the USB HDD Connection ➔ (p. 55)

■ USB Flash Memory

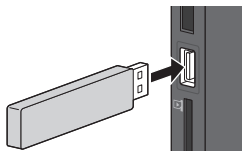

- Insert or remove straightly and completely.
- Before removing the USB Flash Memory, ensure to perform "Safely remove USB" (p. 19).
- Connect to the USB 1, 2 or 3 port.



■ SD Card

To insert the SD Card

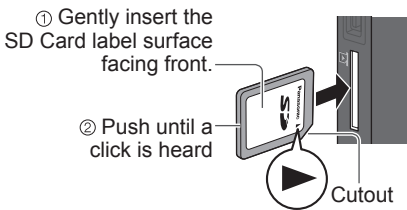

To remove the SD Card

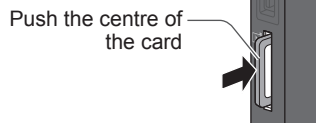

For the information of the devices ➔ "Devices for recording or playing back" (p. 96)

• For the supported file format ➔ "Supported file format in Media Player and media servers" (p. 94, 95)



■ **To return to TV**



■ **To return to the previous screen**



1 Insert the SD Card or USB Flash Memory to the TV

➔ (p. 59)

- To play back contents in USB HDD, check the connection and settings are completed. ➔ (p. 55, 56)

2 Start Media Player

Media Player

Signal output from all AV terminals will be disabled during Media Player view.
Press OK to proceed.
Press EXIT to return to TV viewing.



- Also possible by pressing following buttons.

SD CARD



AV ➔ **“Watching External Inputs”**
(p. 27)

3 Select the device you want to access to



- ① select
- ② access

- If two or more devices are not connected, this step will be skipped.

Selected device name

4 Select the content



- ① select
- ② access

[Photo] ➔ **“Photo mode”** (p. 61)

[Video] ➔ **“Video mode”** (p. 63)

[Music] ➔ **“Music mode”** (p. 69)

[Recorded TV] ➔ **“Recorded TV mode”** (p. 67)

Note

- You can also access each mode directly by using VIERA TOOLS.
➔ **“How to Use VIERA TOOLS”** (p. 29)
- [Recorded TV] is available for USB HDD.
- Select the appropriate device and content for playing back each file.

Photo mode

Photo mode will read all ".jpg" extension files in the SD Card or USB Flash Memory.



■ To return to TV

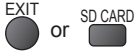

■ To return to the previous screen



The thumbnail of all the photos in the SD Card or USB Flash Memory will be displayed.

Example : Thumbnail - [All photos]

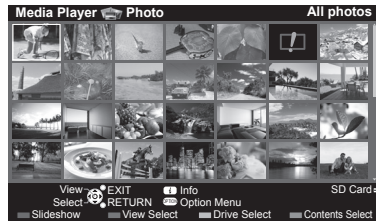

IT : Error display

- To change the back ground music ▶ **"Photo Settings"** (p. 62)
- To display the information of the highlighted photo

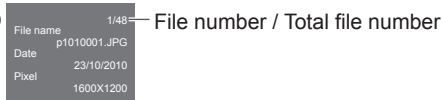

- To change the size of photos on a thumbnail screen display



① select [Change Size]

② change

■ To sort by folder, recorded date or recorded month

1 Display the view selection



2 Select the sort type

Folder view
Sort by Date
Sort by Month



① select

② access

[Folder view] :

Displays the thumbnail grouped by folder

- The files which are not into a folder will be collected to the folder named "I".

[Sort by Date] :

Displays the thumbnail grouped by the same date

- The group of the photos without recorded date is shown as [Unknown].

[Sort by Month] :

Displays the thumbnail grouped by the same month

- The group of the photos without recorded date is shown as [Unknown].

3 Select one of the sorted groups to display the thumbnail of the selected group



① select

② thumbnail of the selected group

- To return to the thumbnail of all photos



① select [All photos]

② access

- To display the information of the highlighted group

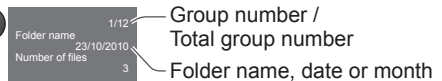

[Single view] - Photos are displayed one at a time.

Select the file from the thumbnail of photos to be viewed



Example :



Operation guide

- To display / hide the operation guide



- To return to thumbnail



- To operate Single view



- To the previous photo
- Slideshow
- To the next photo
- Stop (return to thumbnail)

- To rotate 90°



[Slideshow]

- Slideshow will complete when all photos have been viewed within the present thumbnail.

1 Select the file from the thumbnail of photos for the first view



- To display / hide the operation guide



2 Start Slideshow



- To pause (return to Single view)



- To return to thumbnail



Photo Settings

Setup the settings for Photo mode.

1 Display the option menu



2 Select [Slideshow Settings]



3 Select the items and set

Slideshow Settings	
Frame	Off
Colour Effect	Off
Transition Effect	Fade
Aspect	Original
Burst Playback	Off
Interval	5 seconds
Repeat	On
Back Ground Music	





access / store

Note

- Picture quality may become lower depending on the slideshow settings.
- Picture setting may not work depending on the slideshow settings.

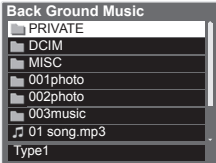
Menu	Item	Adjustments / Configurations (alternatives)
Slideshow Settings	Frame	<p>Selects the frame type of the slideshow [Off] / [Multi] / [Collage] / [Drift (+ calendar)] / [Drift] / [Gallery (+ calendar)] / [Gallery] / [Cinema] [Multi] : 9 photos are displayed orderly at once. [Collage] : Each photo is displayed at a random position and random scale. [Drift (+ calendar)] / [Drift] : Photos are displayed like flow images. <ul style="list-style-type: none"> You can select to display the calendar or not. The month of calendar is turned by pressing left or right cursor button. [Gallery (+ calendar)] / [Gallery] : The various sizes of photos in the frame are displayed. <ul style="list-style-type: none"> You can select to display the calendar or not. The month of calendar is turned by pressing left or right cursor button. [Cinema] : Photos are displayed like old films (sepia tone)</p>
	Colour Effect	<p>Selects the colour effect of photos on Single view and Slideshow [Off] / [Sepia] / [Gray scale] <ul style="list-style-type: none"> This function is not available when [Frame] is set to [Drift], [Gallery] or [Cinema]. </p>
	Transition Effect	<p>Selects the transition effect for switching the photo during the slideshow [Off] / [Fade] / [Slide] / [Dissolve] / [Motion] / [Random] [Fade] : The next photo fades in gradually. [Slide] : The next photo slides and appears from the left side. [Dissolve] : Each photo is dissolved when switching to the next photo. [Motion] : Each photo is displayed with an effect of enlarging, reducing, moving up or moving down. [Random] : Each transition is selected at random. <ul style="list-style-type: none"> This function is available when [Frame] is set to [Off]. </p>
	Aspect	<p>Selects whether enlarged or normal viewing on Single view and Slideshow [Original] / [Zoom] <ul style="list-style-type: none"> This function is not available when [Frame] is set to [Collage], [Drift], [Gallery] or [Cinema]. This function is not available when [Transition Effect] is set to [Motion]. Depending on the photo size, it may not be fully enlarged to fill the screen, e.g. portrait style picture. </p>
	Burst Playback	<p>Selects whether to display burst photos in a fast-paced slideshow mode [Off] / [On] <ul style="list-style-type: none"> This function is not available when [Frame] is set to [Drift], [Gallery] or [Cinema]. This function is not available when [Transition Effect] is set to [Motion]. </p>
	Interval	<p>Selects slideshow interval [5] / [10] / [15] / [30] / [60] / [90] / [120] (seconds) <ul style="list-style-type: none"> This function is not available when [Frame] is set to [Drift], [Gallery] or [Cinema]. This function is not available when [Transition Effect] is set to [Motion]. </p>
	Repeat	<p>Slideshow repeat [Off] / [On]</p>

Menu	Item	Adjustments / Configurations (alternatives)
Slideshow Settings	Back Ground Music	<p>Selects the back ground music during Photo mode [Off] / [Type1] / [Type2] / [Type3] / [User] / [Auto]</p> <ul style="list-style-type: none"> [Type1], [Type2] and [Type3] are the fixed music each installed in this TV. <p>[User] : Music data in the device registered by yourself will be played back. To register the music</p> <ol style="list-style-type: none"> 1. Select the music file Depending on the condition of the device, select folders until you reach the desired music file.  <ol style="list-style-type: none"> 2. Select [File] or [Folder]   <p>[File] : The selected music file will be registered as back ground music. [Folder] : All the music in the folder which contains the selected music file will be registered as back ground music.</p> <ul style="list-style-type: none"> • If no music has been registered or the device which has the registered music is removed, no sound will be produced. <p>[Auto] : Music data stored in the root folder of the current device will be played back randomly.</p> <ul style="list-style-type: none"> • If there is no available music data, no sound will be produced.

Change the device

You can change to the other device directly in the same mode if two or more devices are connected.

1 While the thumbnail is displayed, display the device selection

(yellow)

2 Select the device you want to access to

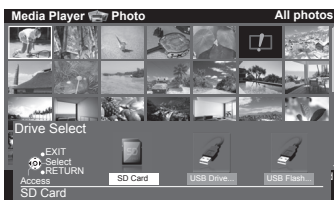

Selected device name



Change the contents

You can switch to the other mode of Media Player from the thumbnail view.

- The mode can be switched in the current device.

1 While the thumbnail is displayed, display the contents selection

(blue)

2 Select the contents



[Photo] ⇒ **“Photo mode”** (p. 61)
 [Video] ⇒ **“Video mode”** (p. 65)
 [Music] ⇒ **“Music mode”** (p. 69)
 [Recorded TV]
 ⇒ **“Recorded TV mode”** (p. 67)

- Supported file format → (p. 94)

Video mode

(For SD Card or USB Flash Memory)



■ To return to TV



■ To return to the previous screen



Note

- The structure of titles and scenes may vary depending on the digital video camera used.

The thumbnail of video titles in the SD Card or USB Flash Memory will be displayed.

Example : Thumbnail - [Title view]

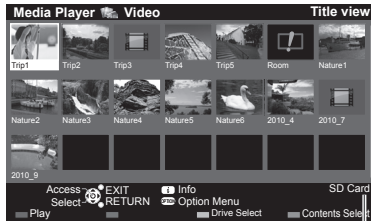

Selected device name

- : Error display
- : The file does not support thumbnail view.

- To view the scenes of the title

Select the title

Example : Thumbnail - [Scene view]

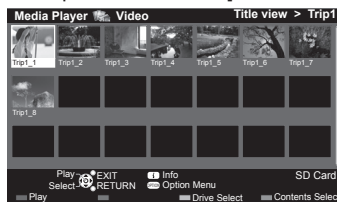

■ Playback from Title view

Playback of the selected title will start.

- To repeat playback → "Video Setup" (p. 66)

1 Select the title



2 Start playback



■ Playback from the selected scene in the title (SD-Video or AVCHD)

Playback will start from the selected scene to the end of the title.

- To repeat playback → "Video Setup" (p. 66)

1 Select the title



2 Select the scene



3 Start playback



The preview will start when the title is highlighted if it supports a preview.

- To turn off the preview → "Video Setup" (p. 66)
- To display the information of the highlighted title

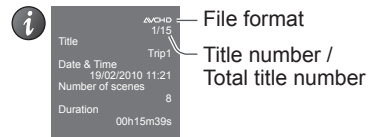

The preview will start when the scene is highlighted if it supports a preview.

- To turn off the preview → "Video Setup" (p. 66)
- To display the information of the highlighted scene

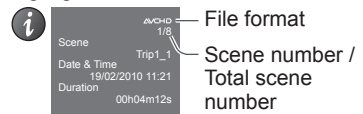

■ How to operate in the playback

Example : Playback

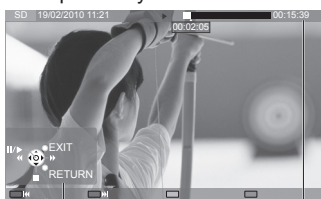

Operation guide Information banner

- To display / hide the operation guide and information banner



- To operate the playback
- ◀◀ Rewind
 ||/▶ Pause / Playback
 ▶▶ Fast forward
 ■ Stop

- To change aspect



- To the previous title / scene



- To the next title / scene



- To return to thumbnail



- You can also use the following buttons. (p. 27)
Set the position to "TV"



- To change the device → "Change the device" (p. 64)

- To change the content in the current device → "Change the contents" (p. 64)

■ Video Setup

Setup the settings for Video mode.

- 1 Display the option menu in the thumbnail view
- 2 Select [Video Setup]



- 3 Select the items and set

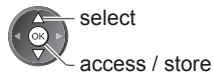
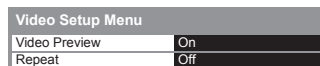

Menu	Item	Adjustments / Configurations (alternatives)
Video Setup	Video Preview	Sets to start the preview of the title or scene in the thumbnail view [Off] / [On] • Image may not be displayed for an instant in the thumbnail view. Set the preview [Off] to resolve this.
	Repeat	Playback repeat within the title or selected file (depending on the content) [Off] / [On]

■ Confirm or change the current status

You can confirm or change the current status of the content.

- Menu items and selectable options vary depending on the content.

- 1 Display the option menu during playback
- 2 Select [Video Setup]



- 3 Select the items and set

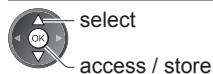
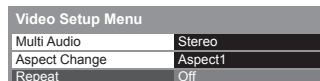

Menu	Item	Adjustments / Configurations (alternatives)
Video Setup	Multi Audio	Allows you to select between selectable sound tracks (if available) • It may take several seconds to change the sound.
	Aspect Change	[Aspect1] : Displays the content enlarged without distortion [Aspect2] : Displays the content full-screen [Original] : Displays the content original size • You can also change the aspect using the ASPECT button. • Aspect change may not work depending on the content.

Recorded TV mode

(For USB HDD)

Contents list of the USB HDD will be displayed.

Example : Contents list



Remaining capacity of the HDD

- This value may not be accurate depending on the condition.

- You can also access the contents list directly by using VIERA TOOLS.

➔ “How to Use VIERA TOOLS” (p. 29)

- To display the information of the highlighted content



- Channel
DVB-T, BBC 1
- Title
Das Erste
- Date & Time
Wed 27/10/2010 12:00
- Duration
00:20

[All] :

All the recorded contents are listed.

[Not Viewed] :

Contents not played back are listed.

Ⓢ : Appears when the recorded content has the guidance information (parental rating, etc.) or the channel of the content is restricted by Child Lock.

This content requires entering PIN number to playback.

⏮ : Content not played back (Once you playback the content, this icon will disappear.)

● : Content under recording (You can playback this content even if under recording.)

🔒 : Protected content cannot be deleted.

📁 : Two or more contents are grouped.

■ Playback the content from the list

1 Select the content



2 Start playback



■ To edit recording content

1 Select and tick the content to edit



2 Display the option menu



3 Select the item and edit

Option Menu
Create Group
Release Group
Exclude from Group
Change Protect Status



[Create Group] :

Two or more contents can be grouped. Select and tick all the desired contents, and then select [Create Group].

[Release Group] :

Select the created group you want to release, and then select [Release Group]. (To release several groups at once, tick all the desired groups.)

[Exclude from Group] :

Select the group and press the OK button to display the grouped contents. To exclude only the specific content from the group, select it and then select [Exclude from Group]. (To exclude several contents at once, tick all the desired contents.)

[Change Protect Status] :

Select the content you want to protect to delete, and then select [Change Protect Status]. Perform the same way to cancel the protection. (To change the status of several contents at once, tick all the desired contents.)

■ Delete the selected content

1 Select the content



2 Delete the content



3 Confirm

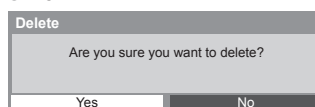

- To select two or more contents



■ How to operate in the playback

Example : Playback

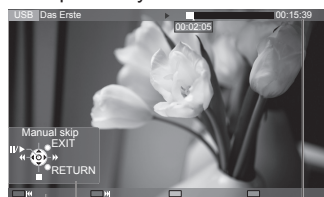

Operation guide

Information banner

- To display / hide the operation guide and information banner
- To operate the playback
 - ◀◀ Rewind
 - [Manual skip]
 - Press to skip forward about 30 seconds
 - Press and hold to skip backward about 15 seconds
 - ⏸ / ▶▶ Pause / Playback
 - ▶▶▶ Fast forward
 - Stop

- To repeat between the starting point "A" and finishing point "B"
 - Set "A" and "B" in order
 - (blue)
 - The points will be reset by pressing this button again or other operations.
- To the previous chapter
 - (red)
- To the next chapter
 - (green)

- To change aspect



- To display the subtitle (if available)



- To return to list



- You can also use the following buttons. (p. 28)

Set the position to "TV"

DVD/VCR TV



- To confirm or change the current status (if available) → **"Display the selectable settings for the current status"** (p. 19)

■ Chapter List

You can start playback from the chapter list you select.

- A recorded content is automatically divided into chapters (about five minutes for each).
- The chapter list is not displayed while the selected content is being recorded.

To play back from the chapter list

(yellow)

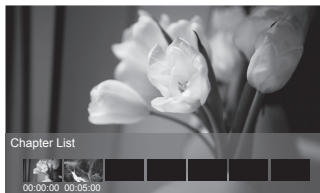

Note

- Depending on the recorded programmes, some playback operations may not work properly.

■ Change the device

You can change to the other device directly in the same mode if two or more devices are connected.

1 Display the option menu

OPTION



2 Select [Drive Select]

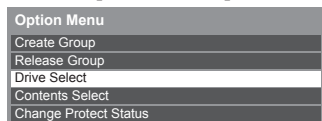

3 Select the device you want to access to



If you select the SD Card or USB Flash Memory, also change the contents to enjoy photo, video or music.

- To change the content

OPTION

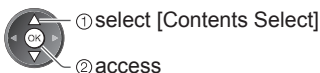

Audio output Settings

You can enjoy the multi-channel sound via an amplifier connected to DIGITAL AUDIO OUT or HDMI2 (ARC function) terminal.

- To confirm or change the current sound status → **“Confirm or change the current status”** (p. 66)

1 Display the menu



2 Select [Sound]

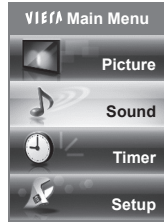

3 Select [SPDIF Selection] and set

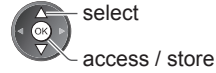

Menu	Item	Adjustments / Configurations (alternatives)
Sound	SPDIF Selection	<p>SPDIF : A standard audio transfer file format Selects the initial setting for digital audio output signal from DIGITAL AUDIO OUT and HDMI2 (ARC function) terminals [Auto] / [PCM] [Auto] : Dolby Digital Plus, Dolby Digital and HE-AAC (48 kHz) multi-channel are output as Dolby Digital Bitstream. DTS is output as DTS. MPEG is output as PCM. [PCM] : Digital output signal is fixed to PCM.</p>

Music mode

- Supported file format → (p. 94)



The thumbnail of music folders in the SD Card or USB Flash Memory will be displayed.

Example : Thumbnail - [Folder view]

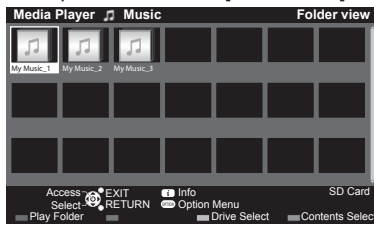

Selected device name

- To display the information of the highlighted folder

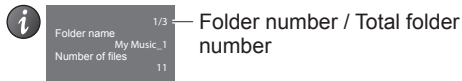

■ To return to TV

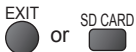

■ To return to the previous screen



■ Playback from Folder view

All the files in the selected folder will be played back.

1 Select the folder



2 Start playback



■ Playback from File view

Selected file will be played back.

1 Select the folder



2 Select the file

Example : Thumbnail - File view

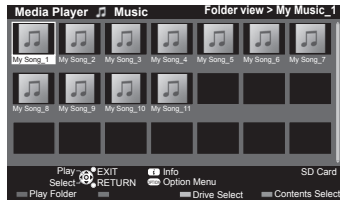

3 Start playback



- To display the information of the highlighted file

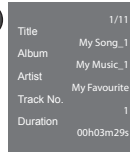

File number / Total file number

■ How to operate in the playback

Example : Playback

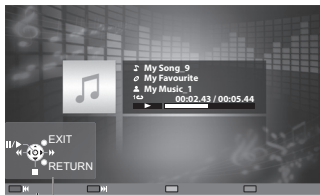

Operation guide

- To display / hide the operation guide



- To operate the playback



- ◀◀◀ Rewind
- ⏸ Pause / Playback
- ▶▶▶ Fast forward
- Stop

- To the previous track



- To the next track



- To return to thumbnail



- To change the device ➔ “Change the device” (p. 64)

- To change the content in the current device ➔ “Change the contents” (p. 64)

Music Setup

Setup the setting for Music mode (only available in the thumbnail view).

1 Display the option menu



2 Select [Music Setup]



3 Set

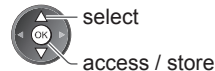

[Folder] : Playback repeat within the selected folder

[One] : Playback repeat of the selected one file

Using Network Services (DLNA / VIERA Connect)

DLNA®

This TV is a DLNA Certified™ product.

DLNA (Digital Living Network Alliance) is a standard that makes DLNA Certified digital electronics easier and more convenient to use on a home network. To learn more, visit www.dlna.org.

It allows you to share photos, videos and music stored in the DLNA Certified media server (for example, PC with windows 7 installed, DIGA Recorder etc.) connected to your home network, and enjoy the contents on the TV screen. It also allows you to control the TV with the DLNA Certified equipment connected to your home network. (DLNA Remote Control)

- For the supported file format ➔ (p. 94, 95)
- AVCHD and DivX files are not supported by DLNA, but can be played by Media Player (p. 59).

■ Media server

Store photos, videos or music into the DLNA Certified media server, and then you can enjoy them on the TV.

To use a PC as a media server

Prepare the PC with Windows 7 or ensure the server software is installed on the PC.

“Windows 7” and “TwonkyMedia server 6 (installed on the PC with Windows 7, Windows Vista or Windows XP)” are the server software that has been tested for compatibility with this TV (current as of January, 2011). Any other server software have not been tested with this TV, therefore compatibility and performance cannot be assured.

- Windows 7
The setup for homegroup settings of Windows 7 is required. For details, refer to the help functions of Windows 7.
- TwonkyMedia server
“TwonkyMedia server” is the product of PacketVideo Corporation.
To obtain the Installation Guides for installing and setting “TwonkyMedia server”, visit the website of TwonkyMedia.
Additional fees may be charged to obtain server software.

Note

- For more information about the server software, please consult each software company.
- When server software for the media server is installed on the PC, the data may be at risk of being accessed by other people. Please take care of the settings and connections under the network circumstances at the office, hotel or even at home when not using a router.

To use a DLNA compatible DIGA Recorder as a media server

By connecting a DLNA compatible DIGA Recorder to your home network, you can enjoy and control it as one of the media servers.

- Please refer to the manual of your DIGA Recorder to confirm whether the recorder is compatible with DLNA.

■ DLNA Remote Control

You can control the TV with the DLNA Certified equipment.

- To use this function, set the [Network Link Settings] ➔ (p. 73)
- “Windows 7” is the OS that has been tested for compatibility of this TV (current as of January, 2011).
For the operations, refer to the help functions of Windows 7.

Network connection ➔ “Example 1” or “Example 2” in “Network connections” (p. 72)

Network setup ➔ (p. 73 - 77)

DLNA operations ➔ (p. 78 - 81)

VIERA Connect

VIERA Connect is a gateway to the internet services unique to Panasonic and has expanded VIERA CAST features greatly.

VIERA Connect allows you to access some specific websites supported by Panasonic, and enjoy internet contents such as photos, videos, games, etc. from VIERA Connect home screen.

- This TV has no full browser function and all features of websites may not be available.

Network connection ➔ “Example 1” or “Example 3” in “Network connections” (p. 72)

Network setup ➔ (p. 73 - 77)

VIERA Connect operations ➔ (p. 16, 81)

Network connections

To use only DLNA features, you can operate the features without broadband network environment. To use VIERA Connect features, you need a broadband network environment.

- If you do not have any broadband network services, please consult your retailer for assistance.
- Set up and connect any equipment required for the network environment. You cannot make settings for the equipment on this TV. Read the manual of the equipment.
- Required speed (effective) : at least 1.5 Mbps for SD and 6 Mbps for HD picture quality, respectively. If the transfer speed is not enough, contents may not be played back properly.

Example 1

(For DLNA and VIERA Connect)

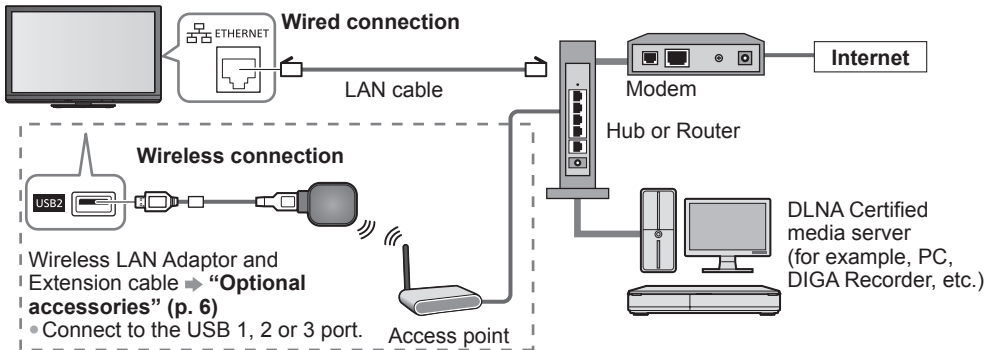

- Ensure to use a LAN straight cable for this connection.
- If your modem has no broadband router functions, use a broadband router.
- If your modem has broadband router functions but there are no vacant ports, use a hub.
- Ensure that the broadband routers and hubs are compatible with 10BASE-T / 100BASE-TX.
- If you use the equipment compatible only with 100BASE-TX, category 5 LAN cables are required.

Example 2

(For DLNA)

You can connect the TV and the equipment directly to use DLNA features.

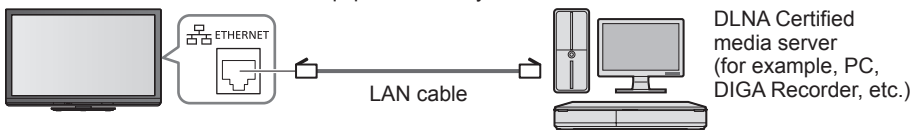

- Ensure to use a LAN cross cable for this connection.

Example 3

(For VIERA Connect)

You can connect the TV and the telecommunication equipment directly to use VIERA Connect features.

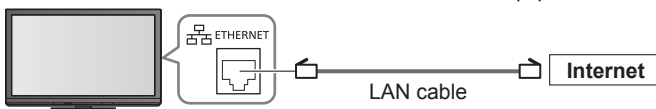

Note

- Contact your Internet Service Provider (ISP) telecommunications company for further assistance regarding the network equipment.
- Confirm the terms and conditions of the contracts with your Internet Service Provider (ISP) or telecommunications company. Depending on the contracts, additional fees may be charged or multiple connections to the internet may be impossible.

Network Setup

- Ensure the connections are completed before starting Network Setup.
➔ “Network connections” (p. 72)



1 Display the menu



2 Select [Setup]

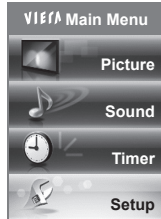

3 Select [Network Setup]



■ To return to TV

EXIT



Network Link settings

Settings which allow the TV to be controlled by the equipment connected to the network.

1 Select [Network Link Settings]

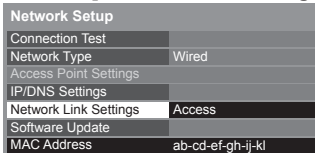

2 Select the items and set

Network Link Settings	
VIERA Name	VIERA
DLNA Remote Control	On
DLNA Remote Volume	On
Network Remote Control	On



Menu	Item	Adjustments / Configurations (alternatives)
Network Link Settings	VIERA Name	Sets your favourite name for this TV and this name will be used to display the name of this TV on the screen of the other DLNA compatible equipment.
	DLNA Remote Control	Enables to control the TV using Windows 7 via the network [Off] / [On]
	DLNA Remote Volume	Enables to control the volume of the TV using Windows 7 via the network [Off] / [On]
	Network Remote Control	Enables to control the TV from the network equipment (Smartphone, etc.) [Off] / [On] <ul style="list-style-type: none"> • Depending on the area, this function may not be available. For details, consult your local Panasonic dealer. • For more information of this function, visit the following website. http://panasonic.jp/support/global/cs/tv/

Wired connection settings

This setting is for the network connection by using the LAN cable.

1 Select [Network Type] and set to [Wired]

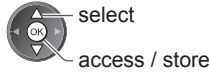
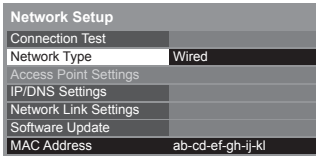

If you make the network connection like “Example 2” (p. 72), you do not have to set [Acquire DNS Address], [Proxy] and [Proxy Port].

2 Select [IP/DNS Settings] and set the items



■ [Acquire IP Address] / [Acquire DNS Address]

Sets [IP Address], [Subnet Mask], [Gateway], [Primary DNS] and [Secondary DNS].
 Select [Acquire IP Address] / [Acquire DNS Address] and set to [Auto] (recommended)

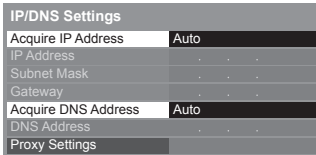

• The available settings are displayed automatically.

Manual settings
 ([IP Address], [Subnet Mask], [Gateway], [Primary DNS], [Secondary DNS])



3 Select [Proxy Settings] and set the items

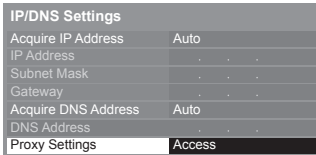

• After settings, return to [Network Setup] screen



■ [Proxy]

Sets Proxy address.

• This is the address of the relay server that is connected to the target server instead of the browser and sends data to the browser. Setting is required if specified by the provider.

1. Select [Proxy]

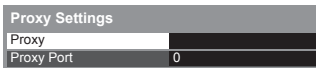

2. Enter the address



• To use numeric buttons
 ➔ “Characters table for numeric buttons” (p. 97)

3. Store



■ [Proxy Port]

Sets Proxy port number.

• This number is also specified by the provider with the Proxy address.

1. Select [Proxy Port]



2. Move the cursor and enter the number



4 Select [Connection Test] and access to test

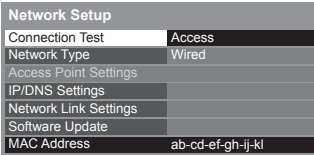

- Performs automatic testing of the network connection for the TV. (It takes a while to test.)

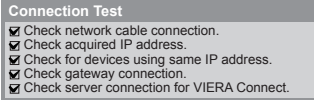

- : **succeeded**
The test is successful and the TV is connected to the network.
- : **failed**
Check the settings and connections, and then perform this function again.

Wireless connection settings

This setting is for the network connection by using the Wireless LAN Adaptor. (Wireless connection)

- Confirm the encryption key, settings and positions of your access point before starting setup. For details, read the manual of the access point.

1 Select [Network Type] and set to [Wireless]

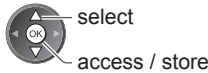
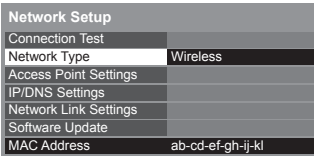

2 Select [Access Point Settings]

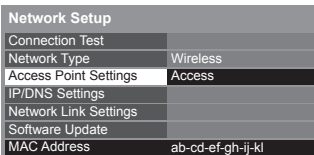

- When the access point is already set, [Current Settings] screen will be displayed. To change the settings, select [No] on this screen and go to the next step.

3 Select the connection type and set

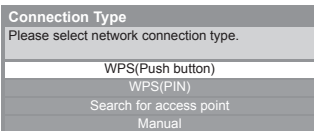

- For details of each connection type ➔ (p. 76, 77)
- After settings, return to [Network Setup] screen



4 Select [Connection Test] and access to test

Network Setup	
Connection Test	Access
Network Type	Wireless
Access Point Settings	
IP/DNS Settings	
Network Link Settings	
Software Update	
MAC Address	ab-cd-ef-gh-ij-kl



Performs automatic testing of the network connection for the TV.
(It takes a while to test.)

Connection Test	
<input checked="" type="checkbox"/>	Check access point connection.
<input checked="" type="checkbox"/>	Check acquired IP address.
<input checked="" type="checkbox"/>	Check for devices using same IP address.
<input checked="" type="checkbox"/>	Check gateway connection.
<input checked="" type="checkbox"/>	Check server connection for VIERA Connect.

- : **succeeded**
The test is successful and the TV is connected to the network.
- : **failed**
Check the settings and connections, and then perform this function again.
If you continue to have difficulty, please contact your internet service provider.

■ [WPS(Push button)]

WPS(Push button)

- 1) Please press the 'WPS' button on the access point until the light flashes.
- 2) When the light is flashing select 'Connect' on TV.

If you are unsure, please check the instruction manual of the access point.

Connect

① press the WPS button on the access point until the light flashes



② connect the Wireless LAN Adaptor and the access point

- Ensure that your access point supports WPS for this setup.
- WPS : Wi-Fi Protected Setup™

■ [WPS(PIN)]

1 Select your desired access point

Available Access Points

No.	SSID	Wireless type	Encrypt	Reception
1	Access Point A	11n(2.4GHz)	<input checked="" type="checkbox"/>	
2	Access Point B	11n(5GHz)	<input type="checkbox"/>	
3	Access Point C	11n(5GHz)	<input type="checkbox"/>	



- Ensure that your access point supports WPS for this setup.

- To search access points again
 (yellow)
- For the information of the highlighted access point
 (red)
- To set manually
 (red)

2 Enter the PIN code to the access point, and then select [Connect]

WPS(PIN)

Please register the following PIN codes on the access point.

PIN code : 12345678

Select 'Connect' after entering and saving the settings on the access point.

Connect



■ [Search for access point]

Access points found automatically are listed.

1 Select your desired access point

Available Access Points

No.	SSID	Wireless type	Encrypt	Reception
1	Access Point A	11n(2.4GHz)	<input checked="" type="checkbox"/>	
2	Access Point B	11n(5GHz)	<input type="checkbox"/>	
3	Access Point C	11n(5GHz)	<input type="checkbox"/>	



: Encrypted access point

- To search access points again
 (yellow)
- For the information of the highlighted access point
 (red)
- To set manually
 (red)

2 Access the encryption key input mode

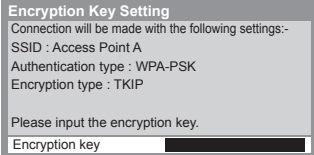

- If the selected access point is not encrypted, the confirmation screen will be displayed. It is recommended to select the encrypted access point.

3 Enter the encryption key of the access point (Set characters one by one)



- To use numeric buttons
➔ **“Characters table for numeric buttons” (p. 97)**

4 Select [Yes]

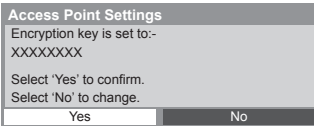

- To re-enter the encryption key, select [No].

■ [Manual]

You can setup SSID, authentication type, encryption type, and encryption key manually. Follow the on screen instructions and set manually.

- When you use 11n (5 GHz) for the wireless system between the Wireless LAN Adaptor and access point, please select [AES] for the encryption type.

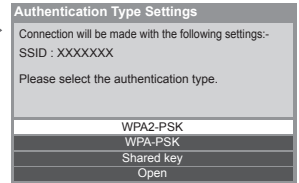
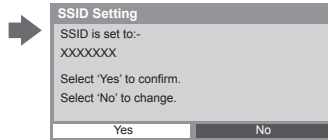
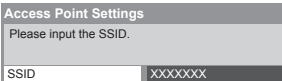

Update TV's software

Check for available software updates from the Panasonic website.

Select [Software Update]

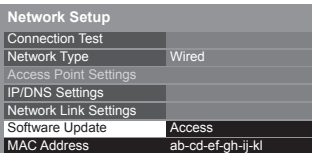

- Follow the on screen instructions

Note

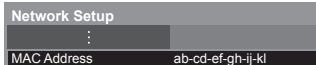

[MAC Address]

- MAC address is a unique address that identifies hardware in the network. (for information only)

Using DLNA® features

- Ensure the preparation of media server, network connections and network settings are completed.
➔ “Media server” (p. 71), “Network connections” (p. 72), [Network Setup] (p. 73 - 77)



■ To return to TV

EXIT

■ To return to the previous screen

BACK/RETURN

1 Display icons of the feature



2 Select [Media Server]



3 Select one of the media servers you want to access

Example : Media server list

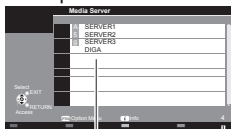

- To display the information of the highlighted media server



Available media servers

Total listed number

4 Select the file

Example : File list



- Depending on the condition of media server, you may need to select the folder before selecting the file.
- To display the information of the highlighted file



Note

- Non-playable files are also listed but cannot be selected.
- Turn the TV off, and then on again when changing or reconnecting the network connection.







For photo file

[Single view] - Photos are displayed one at a time.

Example :



Operation guide

- To display / hide the operation guide 
- To operate Single view
 - To the previous photo 
 - To the next photo 
 - Slideshow 
 - Stop (return to list) 
- To return to list 
- To rotate 90°  (blue)

[Slideshow] - Slideshow will complete when all photos have been viewed within the list.



1 Select the photo file from the list for the first view **2 Start Slideshow**



- To display / hide the operation guide 

 (red)



- To pause (return to Single view) 
- To return to list 

For video file





Playback - Playback will start.





Example : Playback



Operation guide

Information banner

- To display / hide the operation guide and information banner 
- To the previous content  (red)
- To the next content  (green)
- To change aspect 

- To operate the playback
 -  Rewind
 - [Manual skip]
 - Press to skip forward about 30 seconds
 - Press and hold to skip backward about 15 seconds
 -  Pause / Playback
 -  Fast forward
 -  Stop
- To return to list 







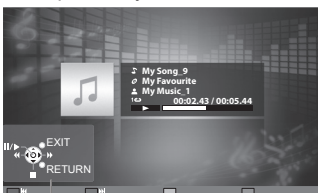

For music file

Playback - Playback will start

Example : Playback



Operation guide

- To display / hide the operation guide 
- To operate the playback
 -  Rewind
 -  Pause / Playback
 -  Fast forward
 -  Stop
- To the previous track  (red)
- To the next track  (green)
- To return to list 

For DIGA Recorder

Control the DIGA Recorder

The screen of the DIGA Recorder will be displayed. You can control the functions of the DIGA Recorder with this TV remote control according to the operation guide.

Example :

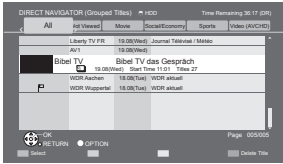

- Before operating, register this TV on the DIGA Recorder.
- For details, read the manual of the DIGA Recorder.

Option menu for each content

Setup the settings for Photo, Video and Music file operations.

1 Display the option menu

OPTION



2 Select [Slideshow Settings], [Video Setup] or [Music Setup]

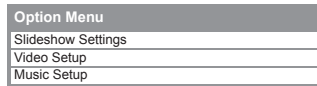

3 Select the items and set

Slideshow Settings	
Transition Effect	Fade
Interval	5 seconds
Repeat	On
Back Ground Music	

Video Setup Menu	
Video Preview	On
Repeat	Off

Music Setup Menu	
Repeat	One

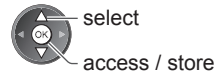

Menu	Item	Adjustments / Configurations (alternatives)
Slideshow Settings	Transition Effect	Selects the transition effect for switching the photo during the slideshow [Off] / [Fade] / [Slide] / [Dissolve] / [Motion] / [Random] [Fade] : The next photo fades in gradually. [Slide] : The next photo slides and appears from the left side. [Dissolve] : Each photo is dissolved when switching to the next photo. [Motion] : Each photo is displayed with an effect of enlarging, reducing, moving up or moving down. [Random] : Each transition is selected at random.
	Interval	Selects slideshow interval [5] / [10] / [15] / [30] / [60] / [90] / [120] (seconds) • This function is not available when [Transition Effect] is set to [Motion].
	Repeat	Slideshow repeat [Off] / [On]
	Back Ground Music	Selects the back ground music during Photo mode [Off] / [Type1] / [Type2] / [Type3]
Video Setup	Video Preview	Sets to start the preview of the title or scene in the thumbnail screen [Off] / [On] • Image may not be displayed for an instant in the thumbnail screen. Set the preview [Off] to resolve this.
	Repeat	Playback repeat within the selected file [Off] / [On]
Music Setup	Repeat	Playback repeat [Off] / [Folder] / [One] [Folder] : Playback repeat within the selected folder [One] : Playback repeat of the selected one file

Audio output settings (for video contents)

You can enjoy the multi-channel sound via an amplifier connected to DIGITAL AUDIO OUT or HDMI2 (ARC function) terminal.

1 To confirm or change the current sound status ➔ **“Confirm or change the current status” (p. 66)**

1 Display the menu



2 Select [Sound]

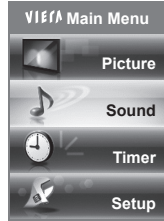

3 Select [SPDIF Selection] and set

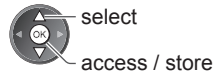
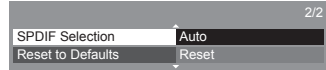

Menu	Item	Adjustments / Configurations (alternatives)
Sound	SPDIF Selection	SPDIF : A standard audio transfer file format Selects the initial setting for digital audio output signal from DIGITAL AUDIO OUT and HDMI2 (ARC function) terminals [Auto] / [PCM] [Auto] : Dolby Digital Plus, Dolby Digital and HE-AAC (48 kHz) multi-channel are output as Dolby Digital Bitstream. MPEG is output as PCM. [PCM] : Digital output signal is fixed to PCM.

VIERA Connect

You can access VIERA Connect and enjoy various network contents.

- VIERA Connect requires a broadband internet connection. Dial-up internet connections cannot be used.
- Ensure the network connections and network settings are completed. ➔ **“Network connections” (p. 72), [Network Setup] (p. 73 - 77)**
- For details about VIERA Connect operation ➔ **“Using “VIERA Connect”” (p. 16)**
- Setup menu (Items in [Setup] may change without notice.)

Customize HomeScreen	Changes the position of each services on VIERA Connect home screen
My Account	Confirms or removes the account information of the TV you entered on VIERA Connect
Lock	Sets to restrict access to some services
Beep	Sets beep sound On or Off when operating VIERA Connect
Notices	Displays the information of VIERA Connect

Note

- Be sure to update the software when a software update notice is displayed on the TV screen. If the software is not updated, you will not be able to use VIERA Connect.
You can update the software later manually ➔ **[Software Update] in [Network Setup] (p. 77)**
- VIERA Connect home screen is subject to change without notice.
- The services through VIERA Connect are operated by their respective service providers, and service may be discontinued either temporarily or permanently without notice. Therefore, Panasonic will make no warranty for the content or the continuity of the services.
- Some content may be inappropriate for some viewers.
- Some content may only be available for specific countries and may be presented in specific languages.
- Depending on the connection environment, the internet connection may be slow or may not be successful.
- During the operation, audio signal is output from AV1, AUDIO OUT, DIGITAL AUDIO OUT and HDMI2 (ARC function) terminals. But no video signals are output. AV1 can output audio signal if [AV1 out] is set to [Monitor] in the Setup Menu (p. 34). To use HDMI2 with ARC function, connect an amplifier that has ARC function (p. 83) and set to use theatre speakers (p. 89).
- You can restrict access to VIERA Connect ➔ **[Child Lock] (p. 47)**
- Turn the TV off, and then on again when changing or reconnecting the network connection.

Link Functions (Q-Link / VIERA Link)

Q-Link connects the TV and DVD Recorder / VCR, and enables easy recording, playback, etc. ➔ (p. 84)
 VIERA Link (HDAVI Control™) connects the TV and the equipment with VIERA Link function, and enables easy control, convenient recording, playback, energy saving, creation of a home theatre, etc., without complicated setting. ➔ (p. 85 - 89)
 You can use Q-Link and VIERA Link functions together.

- This TV supports "HDAVI Control 5" function. But available features are depending on the connected equipment's version of HDAVI Control. Please refer to the manual of the equipment to confirm the version.
- VIERA Link features may be available even with other manufacturers' equipment supporting HDMI CEC.

Summary of Q-Link and VIERA Link features

Q-Link (SCART connection only)

Connected equipment	DVD Recorder / VCR with Q-Link function
Features	
Analogue channel download	○
Easy playback	○
Power on link	○
Power off link	○
Direct TV Recording	○

Connection

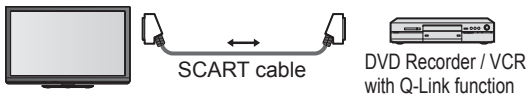

- Use a fully wired SCART cable.
- Connect the DVD Recorder / VCR supporting Q-Link to the TV's AV1 terminal via a SCART cable.

VIERA Link (HDMI connection only)

Connected equipment	DIGA Recorder with VIERA Link function	DVD Player / Blu-ray Disc Player with VIERA Link function	HD Video Camera / LUMIX Camera with VIERA Link function
Features			
Analogue channel download	—	—	—
Easy playback	○	○	○
Power on link	○	○	○
Power off link	○	○	○
Reduce unnecessary power consumption in standby	○*3	○*3	—
Auto standby for unnecessary equipment	○*3	○*3	—
Pause Live TV programme	○*3 *4	—	—
Direct TV Recording	○*3	—	—
Control the menu of the connected equipment by VIERA remote control	○*1	○*1	○*1
Speaker control	—	—	—

Connection

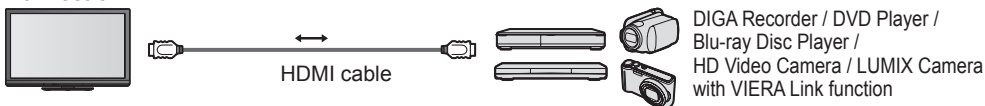

- Use a fully wired HDMI compliant cable.
- Connect the equipment supporting VIERA Link to the TV's HDMI1 or HDMI2 terminal via an HDMI cable.
- For information about using HDMI cables for connecting Panasonic HD Video Camera or LUMIX Camera, read the manual of the equipment.

VIERA Link (HDMI and SCART connections)

Connected equipment	DIGA Recorder with VIERA Link function
Features	
Analogue channel download	○
Easy playback	○
Power on link	○
Power off link	○
Reduce unnecessary power consumption in standby	○*3
Auto standby for unnecessary equipment	○*3
Pause Live TV programme	○*2 *4
Direct TV Recording	○*2
Control the menu of the connected equipment by VIERA remote control	○*1
Speaker control	—

Connection

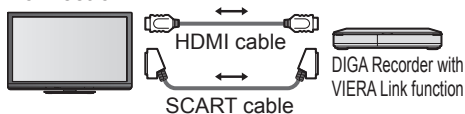

- Use a fully wired HDMI compliant cable.
- Connect the equipment supporting VIERA Link to the TV's HDMI1 or HDMI2 terminal via an HDMI cable.
- Use a fully wired SCART cable.
- Connect the equipment supporting VIERA Link to the TV's AV1 terminal via a SCART cable.

VIERA Link (HDMI and Audio out connections)

Features	Connected equipment	Player theatre with VIERA Link function	Blu-ray Disc theatre with VIERA Link function	Amplifier with VIERA Link function
Analogue channel download		—	—	—
Easy playback		○*5	○*5	—
Power on link		○	○	—
Power off link		○	○	○
Reduce unnecessary power consumption in standby		—	○*3	—
Auto standby for unnecessary equipment		○*3 *6	○*3 *6	○*3
Pause Live TV programme		—	—	—
Direct TV Recording		—	—	—
Control the menu of the connected equipment by VIERA remote control		○*1	○*1	—
Speaker control		○	○	○

Connection

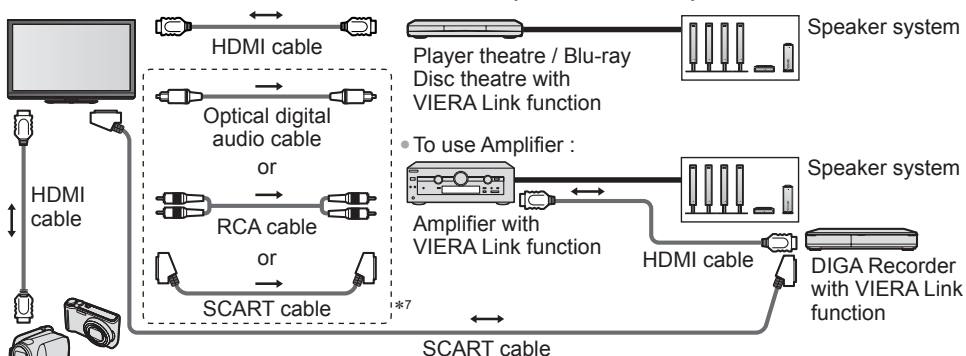

HD Video Camera / LUMIX Camera with VIERA Link function

- Use fully wired HDMI compliant cable.
- Connect the equipment supporting VIERA Link to the TV's HDMI2, HDMI3 or HDMI4 terminal via an HDMI cable.
- Use fully wired SCART cable.
- If you use a SCART cable for audio output, connect the equipment supporting VIERA Link to the TV's AV1 terminal and set [AV1 out] to [Monitor] in the Setup Menu (p. 34).
- Use the optical digital audio cable, RCA cable or SCART cable for audio output from the TV.

*1 : Available with the equipment which has "HDAVI Control 2 or later" function.

*2 : Available with the equipment which has "HDAVI Control 3 or later" function.

*3 : Available with the equipment which has "HDAVI Control 4 or later" function.

*4 : Available with DIGA Recorder which has HDD.

*5 : While playing a disc

*6 : Except for watching a disc

*7 : If the connected equipment has "HDAVI Control 5" function, you do not have to use this audio cable (Optical digital audio cable, RCA cable or SCART cable). In this case, connect the equipment to the TV's HDMI2 terminal via an HDMI cable.

VIERA Link Control of compatible equipment ([VIERA Link Control] ➔ p. 87)

- Table below displays maximum number of compatible equipment that can be controlled by VIERA Link Control. This includes connections to equipment already connected to the TV. For example, DIGA Recorder connected to Amplifier which is connected to the TV via an HDMI cable.

Type of the equipment	Maximum number
Recorder (DIGA Recorder, etc.)	3
Player (DVD Player, Blu-ray Disc Player, HD Video Camera, LUMIX Camera, Digital Camera, Player theatre, Blu-ray Disc theatre, etc.)	3
Audio system (Player theatre, Blu-ray Disc theatre, Amplifier, etc.)	1
Tuner (Set top box, etc.)	4

Preparations

- Connect the DVD Recorder / VCR with the following logos: "Q-Link", "NEXTVIEWLINK", "DATA LOGIC (a trademark of Metz Corporation)", "Easy Link (a trademark of Philips Corporation)", "Megalogic (a trademark of Grundig Corporation)" or "SMARTLINK (a trademark of Sony Corporation)"
- Q-Link connection ➔ (p. 82)
- Use fully wired SCART cable.
- Set up the DVD Recorder / VCR. Read the manual of the recorder.
- Q-Link terminal setup in the Setup Menu ➔ **[AV1 out] (p. 34)**
- Download Analogue channel setting ➔ **"Analogue channel download" (see below)**

Features available

Analogue channel download

Analogue channel settings can be downloaded to a recorder with an analogue tuner (where Analogue is still broadcast). Digital channel settings are not downloaded.

- To download the Analogue channel settings ➔ **[Q-Link Download] (p. 34) or [Auto Setup] in Analogue mode (p. 40) or "Auto Setup" - when first using the TV (p. 12)**

Direct TV Recording - What you see is What you record

Recording the current programme on a DVD Recorder / VCR immediately.

- Available conditions:



Picture source	Mode	Recording from
Analogue	TV	TV monitor out
	AV	Recorder's tuner
DVB	TV	TV monitor out
AV (watching recorder's tuner)	AV	Recorder's tuner
AV (watching recorder's external input)	AV	Recorder's external input
AV (watching TV's external input)	AV	TV monitor out

- When Direct TV Recording is performed, the recorder is automatically turned on if it is in Standby mode.
- Changing channel or turning off the TV is available while the recorder is recording from its own tuner.
- Changing channel is not available while the recorder is recording from the TV tuner.

■ To stop recording

Unlock the tuner



Tuner Locked
Press EXIT to unlock and stop recording



Power on link and Easy playback

When the DVD Recorder / VCR starts playback or the direct navigator / function menu for the equipment is activated, the TV is turned on and the input mode is switched automatically so that you can view the content. (Only when the TV is in Standby mode.)

Power off link

When the TV is set to Standby mode, the recorder is also automatically set to Standby. (Only when the videocassette or disc is not active.)

- This function will work even if the TV enters Standby mode automatically by auto power standby function.

Note

- Some recorders are not compatible. Read the manual of the recorder.

*Enjoy additional HDMI Inter-Operability with Panasonic products which have “HDAVI Control” function.

This TV supports “HDAVI Control 5” function.

Connections to the equipment (DIGA Recorder, HD Video Camera, Player theatre, Amplifier, etc.) with HDMI and SCART cables allow you to interface them automatically (p. 82, 83).

These features are limited to models incorporating “HDAVI Control” and “VIERA Link”.

• Some functions are not available depending on the equipment’s version of HDAVI Control.

Please confirm the connected equipment’s version of HDAVI Control.

• VIERA Link “HDAVI Control”, based on the control functions provided by HDMI which is an industry standard known as HDMI CEC (Consumer Electronics Control), is a unique function that we have developed and added.

As such, its operation with other manufacturers’ equipment that supports HDMI CEC cannot be guaranteed.

• Please refer to individual manuals for other manufacturers’ equipment supporting VIERA Link function.

• For information about applicable Panasonic equipment, consult your local Panasonic dealer or refer to www.panasonic.co.uk

Preparations

• Connect the equipment that supports VIERA Link.

• VIERA Link connection ➔ (p. 82, 83)

Use a fully wired HDMI compliant cable. Non-HDMI-compliant cables cannot be utilised.

Recommended Panasonic HDMI cables’ part numbers:

• RP-CDHS15 (1.5 m) • RP-CDHS30 (3.0 m) • RP-CDHS50 (5.0 m)

• Use a fully wired SCART cable.

• Set up the connected equipment. Read the manual of the equipment.

• For optimal recording, the settings of the recorder may need to be changed. For details, read the manual of the recorder.

• Download Analogue channel setting ➔ “Analogue channel download” (see below)

• Set [VIERA Link] [On] in the Setup Menu ➔ [VIERA Link] (p. 34)

• Set up the TV

➔ After connection, turn the equipment on and then switch the TV on.

Select the input mode to HDMI1, HDMI2, HDMI3 or HDMI4 (p. 27), and make sure that an image is displayed correctly.

This setup should be done each time when the following conditions occur:

- for the first time
- when adding or reconnecting equipment
- when changing setup

Features available

Analogue channel download

Analogue channel settings can be downloaded to a recorder with an analogue tuner (where Analogue is still broadcast). Digital channel settings are not downloaded.

• To download the Analogue channel settings ➔ [Q-Link Download] (p. 34) or [Auto Setup] in Analogue mode (p. 40) or “Auto Setup” - when first using the TV (p. 12)

Easy playback

Automatic Input switching - When the connected equipment is operated (during playback or menu operations, etc.), the input mode is switched automatically. When playback is stopped or menus are exited, the input mode returns to the original setting.

Power on link

When the connected equipment starts playback or the direct navigator / function menu for the equipment is activated, the TV is automatically turned on and the input mode is switched automatically so that you can view the content. (Only when the TV is in Standby mode.)

Power off link

When the TV is set to Standby mode, the connected equipment is also automatically set to Standby.

• This function will work even if the TV enters Standby mode automatically by auto power standby function.

Reduce unnecessary power consumption in standby [Standby Power Save]

Set Standby Power Save [On] in the Setup Menu to use this function ➔ [Standby Power Save] (p. 34)
The power consumption in Standby mode of the connected equipment is controlled in synchronization with the TV On / Off state.

When the TV is set to Standby mode, the connected equipment is automatically set to Standby and the power consumption in Standby mode of the connected equipment is automatically minimised.

When the TV is turned on and the connected equipment is still in Standby mode, the power consumption of the connected equipment is increased to reduce the startup time.

- This function is effective if the connected equipment can change the power consumption in Standby mode and is set to higher consumption.

Auto standby for unnecessary equipment [Intelligent Auto Standby]

Set Intelligent Auto Standby [On (With reminder)] or [On (No reminder)] in the Setup Menu to use this function ➔ [Intelligent Auto Standby] (p. 34)

When the TV is On, non-watched or non-used connected equipment goes into Standby mode automatically to reduce power consumption. For example, when the input mode is switched from HDMI, the connected equipment will go into Standby mode / when Speaker Selection is changed to [TV], the Player theatre will go into Standby mode (except when watching a disc).

- If you select [On (With reminder)], the on screen message will be displayed before the connected equipment turns to Standby.
- This function may not work properly depending on the connected equipment. If required, set to [Off].

Direct TV Recording - What you see is What you record [Direct TV Rec]

Recording the current programme on a DIGA Recorder immediately.

- If you connect a variety of recorders including other manufacturers' recorders at the same time, please connect the DIGA Recorder to the TV's lower HDMI terminal number. For example, if you use HDMI1 and HDMI2 for two recorders, connect the DIGA Recorder to HDMI1.
- If Direct TV Recording does not operate, check the settings and the equipment
➔ "Summary of Q-Link and VIERA Link features" (p. 82, 83), "Preparations" (p. 85)
- If you wish to record a programme that the DIGA Recorder does not support, a SCART connection is required and the programme is recorded by Q-Link function (p. 84).
- Depending on the programme, a SCART connection may be required to record.
- Changing channel or turning off the TV is available while the recorder is recording from its own tuner.
- Changing channel is not available while the recorder is recording from the TV tuner.



1 Display [VIERA Link Menu]

2 Select [Direct TV Rec] and start recording

VIERA Link Menu	
Pause Live TV	Start
Direct TV Rec	Start
VIERA Link Control	Recorder
Speaker Selection	Home Cinema



- You can also start recording directly.



■ To stop recording

Select [Stop] in [Direct TV Rec]

VIERA Link Menu	
Pause Live TV	Start
Direct TV Rec	Stop
VIERA Link Control	Recorder
Speaker Selection	Home Cinema

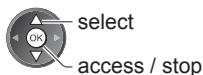

- You can also stop recording directly.

Unlock the tuner

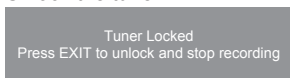

Pause Live TV programme [Pause Live TV]

You can pause the live TV programme and resume the programme later.

The live TV programme will be recorded on HDD of the connected DIGA Recorder.

- This function is available with a DIGA Recorder which has HDD.
- If you connect a variety of recorders including other manufacturers' recorders at the same time, please connect the DIGA Recorder which has HDD to the TV's lower HDMI terminal number. For example, if you use HDMI1 and HDMI2 for two recorders, connect the DIGA Recorder which has HDD to HDMI1.
- If Pause Live TV does not operate, check the settings and the equipment
 ➔ "Summary of Q-Link and VIERA Link features" (p. 82, 83), "Preparations" (p. 85)



1 Display [VIERA Link Menu]

2 Select [Pause Live TV] and pause

The TV picture will be paused.

VIERA Link Menu	
Pause Live TV	Start
Direct TV Rec	Start
VIERA Link Control	Recorder
Speaker Selection	Home Cinema



- Live TV programme is recorded on HDD from where it was paused.
- If the paused TV picture disappears after a few minutes.

OPTION



(the paused picture will be restored)

- Follow the operation guide to operate Pause Live TV function.

■ To operate Pause Live TV

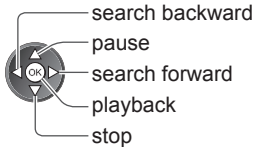

- Operations may be different depending on the recorder. In this case, follow the operation guide or read the manual of the recorder.

- If you stop playback, the recorded programme will be deleted from HDD.

■ To return to Live TV (stop playback of Pause Live TV / cancel pause)

Select [Yes]

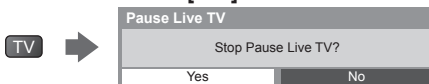

- If you stop playback or cancel pause, the recorded programme will be deleted from HDD.

Control the menu of the connected equipment by VIERA remote control [VIERA Link Control]

You can control some functions of the connected equipment with this TV remote control (point the remote control at the TV's signal receiver).

- If you cannot operate the menu of the connected equipment, check the settings and the equipment
 ➔ "Summary of Q-Link and VIERA Link features" (p. 82, 83), "Preparations" (p. 85)
- For details of the operations for the connected equipment, read the manual of the equipment.



1 Display [VIERA Link Menu]

2 Select [VIERA Link Control]

VIERA Link Menu	
Pause Live TV	Start
Direct TV Rec	Start
VIERA Link Control	Recorder
Speaker Selection	Home Cinema



3 Select the equipment you want to access

The type of the connected equipment is displayed. Select the type of the equipment and access.

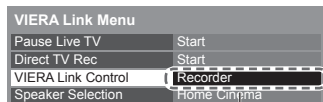

[Recorder] / [Player] / [Home Cinema] / [Video Camera] / [LUMIX] / [Digital Camera] / [Other]

- You can also access directly by using VIERA TOOLS ➔ “How to Use VIERA TOOLS” (p. 29)
- The displayed item may vary depending on the connected equipment.
- [Home Cinema] means Player theatre, Blu-ray Disc theatre or Recorder theatre.
- [Other] means Tuner set top box.

The menu of the accessed equipment (Input mode will be changed automatically)

4 Operate the menu of the equipment

Available VIERA remote control buttons:
(depending on the connected equipment)



1 Set the position to “TV”



2 Follow the operation guide

- To display the operation guide



If other manufacturers' equipment is accessed, Setup / Contents Selection menu may be displayed.

- When the key words are displayed on colour bar
 (red) (green) (yellow) (blue)

Note

- Some operations may not be available depending on the equipment. In this case use its own remote control to operate the equipment.

■ If multiple recorders or players are connected

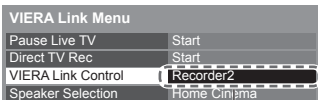

The number is given from the TV's lower HDMI terminal number connected to the same type equipment. For example, two recorders to HDMI2 and HDMI3, in this case the recorder connected to HDMI2 is displayed as [Recorder1], and the recorder connected to HDMI3 is displayed as [Recorder2].

[Recorder1-3 / Player1-3]

■ If you access non-VIERA Link equipment



The type of the connected equipment is displayed. You can access the menu of the equipment. But you cannot operate it. Use its own remote control to operate the equipment.

Speaker control [Speaker Selection]

You can control the home theatre speakers with this TV remote control (point the remote control at the TV's signal receiver).

- If you cannot operate, check the settings and the equipment.
➔ “Summary of Q-Link and VIERA Link features” (p. 82, 83), “Preparations” (p. 85)



1 Display [VIERA Link Menu]



2 Select [Speaker Selection]

VIERA Link menu	
Pause Live TV	Start
Direct TV Rec	Start
VIERA Link Control	Recorder
Speaker Selection	Home Cinema



3 Set to [Home Cinema] or [TV]



[Home Cinema]

The Player theatre, Blu-ray Disc theatre or Amplifier will be automatically turned on if it is in Standby mode and the sound will be output from the theatre speakers connected to the equipment.

- Volume up / down
- Mute



- The sound of the TV speakers is muted.
- When the equipment is turned off, the TV speakers will be activated.

[TV]

TV speakers are active.

Multi-channel sound

If you wish to enjoy multi-channel sound (e.g. Dolby Digital 5.1ch) via an Amplifier, connect the Amplifier to the TV with an HDMI cable and an Optical digital audio cable (p. 83), and then select “Home Cinema”. If your Amplifier has “HDAVI Control 5” function, you only need to connect with an HDMI cable. In this case, connect your Amplifier to the TV's HDMI2 terminal. To enjoy the sound from the DIGA Recorder in multi-channel sound, connect an HDMI cable from the DIGA Recorder to the Amplifier (p. 83).

Note

- These functions may not work properly depending on the connected equipment.
- Image or sound may not be available for the first few seconds when input mode is switched.
- Easy playback may be available by using the remote control for Player theatre, Blu-ray Disc theatre or Amplifier. Read the manual of the equipment.
- “HDAVI Control 5” is the newest standard (current as of December, 2010) for HDAVI Control compatible equipment. This standard is compatible with conventional HDAVI equipment.
- To confirm this TV's version of HDAVI Control ➔ [System Information] (p. 86)

External Equipment

These diagrams show our recommendations for connection of your TV to various pieces of equipment. For other connections, consult the instructions for each piece of equipment, the table below, and the specifications (p. 106, 107).

To record / playback

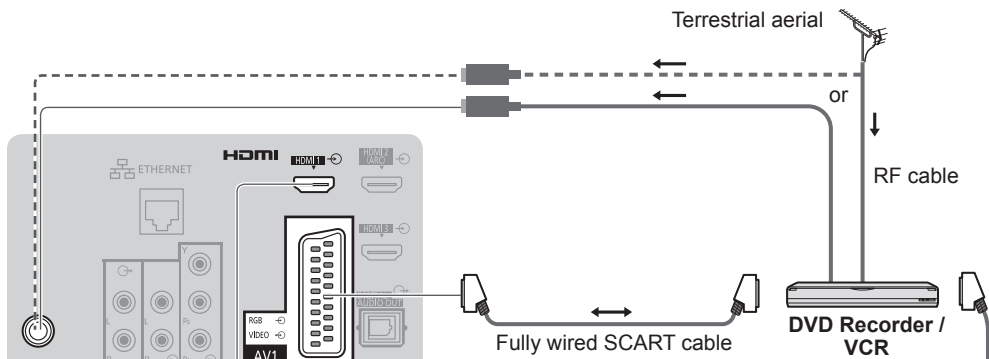

To watch satellite broadcasts

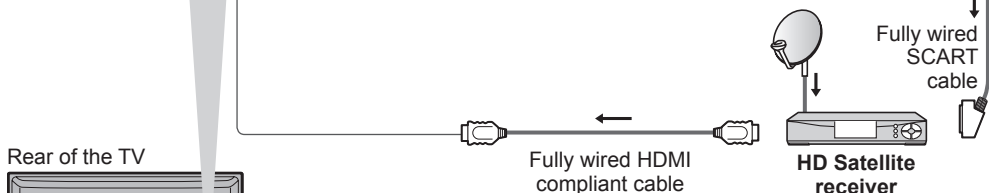

Rear of the TV

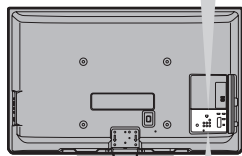

To watch DVDs

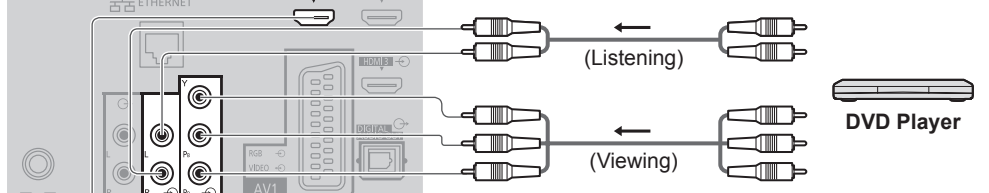

HDMI equipment

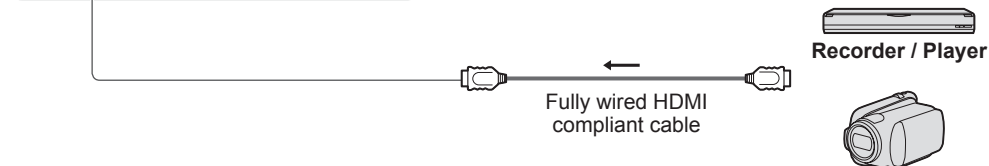

• HDMI connection → (p. 97)

Network (wired)

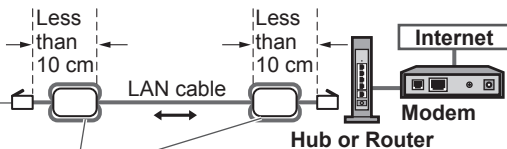

Ferrite core (supplied)

Installing the Ferrite core

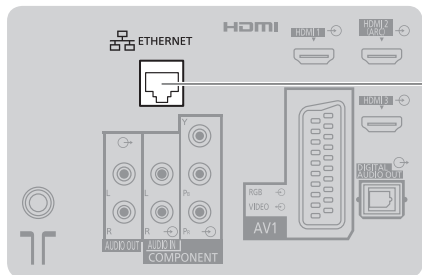
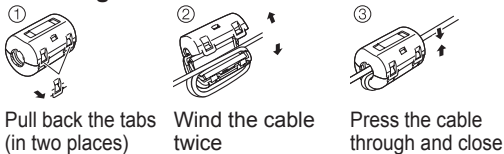

USB devices

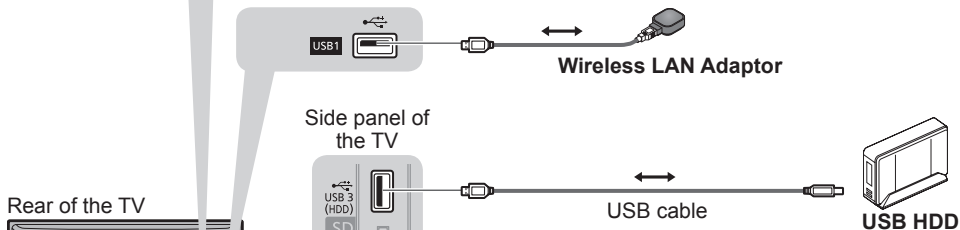

Rear of the TV

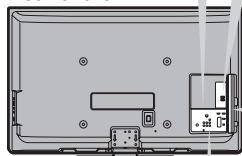

Camcorder / Game equipment

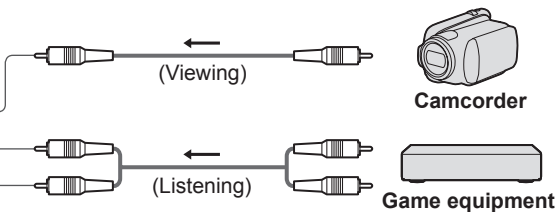

To listen with speakers

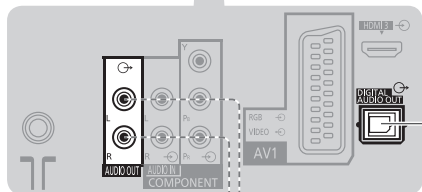
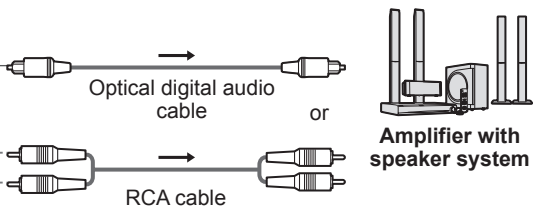

To enjoy the sound from the external equipment in multi-channel sound (e.g. Dolby Digital 5.1ch), connect the equipment to the amplifier. For the connections, read the manuals of the equipment and amplifier.

Rear of the TV

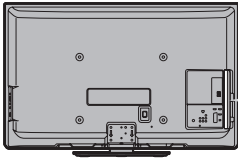

Side panel of the TV



Headphones

(M3 stereo mini plug)



- To adjust volume
➔ **[Headphone Volume]** (p. 33)

Types of connectable equipment to each terminal

Recording / Playback (equipment)	Terminal							
	AV1	AV2	COMPONENT	AUDIO OUT	DIGITAL AUDIO OUT	ETHERNET	HDMI 1 - 4	USB 1 - 3
To record / playback videocassettes / DVDs (VCR / DVD Recorder)	<input type="radio"/>							
To watch satellite broadcasts (Set top box)	<input type="radio"/>	<input type="radio"/>					<input type="radio"/> *1	
To watch DVDs (DVD Player)	<input type="radio"/>	<input type="radio"/>	<input type="radio"/>				<input type="radio"/>	
To watch camcorder images (Video camera)	<input type="radio"/>	<input type="radio"/>					<input type="radio"/>	
To play games (Game equipment)	<input type="radio"/>	<input type="radio"/>					<input type="radio"/>	
To use amplifier with speaker system				<input type="radio"/>	<input type="radio"/>		<input type="radio"/> *2	
To use network services						<input type="radio"/>		<input type="radio"/>
USB HDD Recording								<input type="radio"/> *3
Q-Link	<input type="radio"/>							
VIERA Link	<input type="radio"/> (with HDMI)						<input type="radio"/>	
Direct TV Recording	<input type="radio"/>						<input type="radio"/>	

○ : Recommended Connection

*1 : Use HDMI1 for automatic input switching.

*2 : Use HDMI2 for connecting an amplifier. This connection is applicable when using an amplifier that has ARC (Audio Return Channel) function.

*3 : Use USB 3 port for connecting the USB HDD.

Technical Information

Auto Aspect

The optimum size and aspect can be chosen automatically, and you can enjoy finer images. ➔ (p. 20)

Aspect Control Signal

[WIDE] will appear in the top left of the screen if a Widescreen signal (WSS) or a Control signal through SCART / HDMI terminal is found.

The aspect will switch to the appropriate 16:9 or 14:9 widescreen ratio.

This function will work in any aspect mode.

Input terminal	Input signal format	Aspect Control Signal	
		Widescreen signal (WSS)	Control signal through SCART (pin8) / HDMI terminal
RF	DVB	○	
	PAL I	○	
	PAL 525/60 6.0 MHz	–	
	M.NTSC 6.0 MHz	–	
AV1 / AV2 (Composite)	PAL	○	○
	PAL 525/60	–	○
	M.NTSC	–	○
	NTSC	–	○
COMPONENT	525 (480) / 60i, 60p	–	
	625 (576) / 50i, 50p	○	
	750 (720) / 60p, 50p	–	
	1,125 (1,080) / 60i, 50i	–	
HDMI1 HDMI2 HDMI3 HDMI4	525 (480) / 60i, 60p	–	○
	625 (576) / 50i, 50p	–	○
	750 (720) / 60p, 50p	–	○
	1,125 (1,080) / 60i, 50i	–	○
	1,125 (1,080) / 60p, 50p, 24p	–	○

Auto mode

Auto mode determines the best aspect ratio to fill the screen. It does this using a four step process (WSS, Control signal through SCART / HDMI terminal, Letterbox detection or Justify to fill the screen). This process may take several minutes, depending on the darkness of the image.

Letterbox detection:

If black bands at the top and bottom of the screen are detected, Auto mode chooses the best ratio and expands the image to fill the screen.

If no aspect signals are detected, Auto mode enhances the image for optimum viewing pleasure.

Note

- The ratio varies depending on the programme, etc. If the ratio is out of the standard 16:9, black bands at the top and bottom of the screen may appear.
- If the screen size looks unusual when a widescreen-recorded programme is played back on a VCR, adjust the tracking of the VCR. Read the manual of the VCR.

Supported file format in Media Player and media servers

■ Photo

Format	File extension	Image resolution (pixel)	Details / Restrictions
JPEG	.jpg	8 × 8 to 30,719 × 17,279	DCF*1 and EXIF*2 standards Sub-sampling : 4:4:4, 4:2:2, 4:2:0 ● Progressive JPEG is not supported.

*1 : Design rule for Camera File system - unified standard established by Japan Electronics and Information Technology Industries Association (JEITA)

*2 : Exchangeable Image File - image file format used by digital cameras

■ Video

Container	File extension	Video codec	Audio codec	Details / Restrictions
SD-Video	.mod	MPEG1 MPEG2	MPEG Dolby Digital	SD-Video Standard Ver. 1.3 (Entertainment Video Profile) ● The data may not be available if a folder structure on the device is modified.
AVCHD	.mts	H.264	Dolby Digital	AVCHD Standard ● The data may not be available if a folder structure on the device is modified.
AVI	.avi .divx	DIV3 DIV4 DIVX DX50 DIV6 XviD MPEG4 SP / ASP	MPEG MP3 Dolby Digital	● Certified to play DivX Plus HD video file in Media Player For details of DivX ➔ “DivX” (p. 95)
MKV	.mkv	H.264 BP / MP / HP	MPEG MP3 Dolby Digital DTS core	
ASF	.asf .wmv	Windows Media Video Ver. 9 VC-1	WMA	● Copy-protected files cannot be played back. ● WMA Pro and WMA Lossless are not supported.
MP4	.mp4	H.264 BP / MP / HP	AAC MP3 Dolby Digital	● This TV supports this container recorded by Panasonic products. For details, read the manual of the products.
MOV	.mov	MotionJPEG H.264 BP / MP / HP	Linear PCM (RAW / TWOS / SOWT) AAC MP3 Dolby Digital	● This TV supports Motion JPEG recorded by Panasonic LUMIX Camera*3. ● This TV is not available for playing back Motion JPEG with the media server.
PS	.mpg .mpeg	MPEG1 MPEG2	MPEG MP3 Linear PCM	–
TS	.ts .tp	MPEG2 H.264	AAC MP3 Dolby Digital Dolby Digital Plus HE-AAC	● This container can be played back only with the media server.

*3 : Some products of before the year 2004 may not be available. The compatibility with future products is not guaranteed.

■ Music

Codec	File extension	Restrictions
MP3	.mp3	–
AAC	.m4a	• Copy-protected files cannot be played back.
WMA	.wma	• Copy-protected files cannot be played back. • WMA Pro and WMA Lossless are not supported.

Note

- Some files may not be played back even if they fulfill these conditions.
- Do not use two-byte characters or other special codes for data.
- The device may become unusable with this TV if the file or folder names are changed.

DivX

DivX Certified® to play DivX® and DivX Plus™ HD (H.264/MKV) video up to 1080p HD including premium content.
ABOUT DIVX VIDEO :

DivX® is a digital video format created by DivX, Inc. This is an official DivX Certified® device that plays DivX video. Visit divx.com for more information and software tools to convert your files into DivX video.

Subtitle text file of DivX

Subtitles format - MicroDVD, SubRip, Tmplayer

- The DivX video file and subtitles text file are inside the same folder, and the file names are the same except for the file extensions.
- If there are more than one subtitles text files inside the same folder, they are displayed in the following order of priority : “.srt”, “.sub”, “.txt”.
- To confirm or change the current subtitle status while playing DivX content, press the OPTION button to display Option Menu.
- Depending on the methods used to create the file or the state of recording, only parts of the subtitles may be displayed, or the subtitles may not be displayed at all.

Note

- Depending on how you make SD Card, USB Flash Memory or the media server, files and folders may not be displayed in the order you numbered.
- Depending on how you create the files and the structure of folders, the files and folders may not be displayed.
- When there are many files and folders, operation may take time to complete or some files may not be displayed or playable.

ABOUT DIVX VIDEO-ON-DEMAND :

This DivX Certified® device must be registered in order to play purchased DivX Video-on-Demand (VOD) movies. To obtain your registration code, locate the DivX VOD section in the Setup Menu. Go to vod.divx.com for more information on how to complete your registration.

To show DivX VOD registration code

➔ [DivX® VOD] in the Setup Menu (p. 36)

- If you want to generate the new registration code, you have to deregister the present registration code. After playing DivX VOD content once, the confirmation screen to deregister will be displayed in [DivX® VOD] in the Setup Menu. If you press the OK button on the confirmation screen, the deregistration code will be generated and you will not be able to play any contents that you purchased using the present registration code.

You will obtain the new registration code by pressing the OK button on the deregistration code screen.

- If you purchase DivX VOD content using a registration code different from this TV's code, you will not be able to play this content. ([Your device is not authorized to play this DivX protected video.] is displayed.)

Regarding DivX content that can only be played a set number of times

Some DivX VOD content can only be played a set number of times.

When you play this content, the remaining number of plays is displayed. You cannot play this content when the number of remaining plays is zero. ([This DivX rental has expired.] is displayed.)

- When playing this content, the number of remaining plays is reduced by one in the following conditions :
 - If you exit the current application.
 - If you play the other content.
 - If you go to the next or previous content.

Devices for recording or playing back

■ SD Card (for playing back in Media Player)

Card format : SDXC Card - exFAT SDHC Card / SD Card - FAT16 or FAT32

Compliant card type (maximum capacity) :

SDXC Card (64 GB), SDHC Card (32 GB), SD Card (2 GB), miniSD Card (2 GB) (requiring miniSD adaptor)

- If miniSD Card is used, insert / remove it together with the adaptor.
- Check the latest information on the card type at the following website.
<http://panasonic.jp/support/global/cs/tv/>
- Use an SD Card which meets SD standards. If not, it may cause the TV to malfunction.

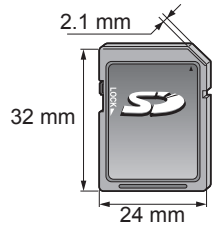

■ USB Flash Memory (for playing back in Media Player)

USB Flash Memory format : FAT16, FAT32 or exFAT

• A USB HDD formatted by PC is not supported in Media Player.

■ USB HDD (for recording the digital TV programmes with this TV and playing back in Media Player)

The capacity of USB HDD that have been tested for the performance with this TV : From 160 GB to 3 TB

- Connect the USB HDD to the socket outlet to record and play back properly with this TV.
- Format the USB HDD with this TV in order to use it. ➔ (p. 55)
- Regarding the performance, not all USB HDDs are guaranteed. Check the USB HDDs that have been tested for the performance with this TV at the following website.
<http://panasonic.jp/support/global/cs/tv/>

Note

- Data modified with a PC may not be displayed.
- Do not remove the device while the TV is accessing data (this can damage device or TV).
- Do not touch the pins on the device.
- Do not subject the device to a high pressure or impact.
- Insert the device in the correct direction (otherwise, device or TV may be damaged).
- Electrical interference, static electricity, or erroneous operation may damage the data or device.
- Back up the recorded data at regular intervals in case of deteriorated or damaged data or erratic operation of the TV. (Panasonic is not liable for any deterioration or damage of recorded data.)

SCART and HDMI terminal information

AV1 SCART terminal (RGB, VIDEO, Q-Link)

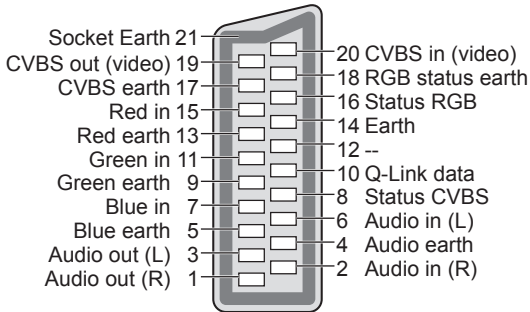

HDMI terminal

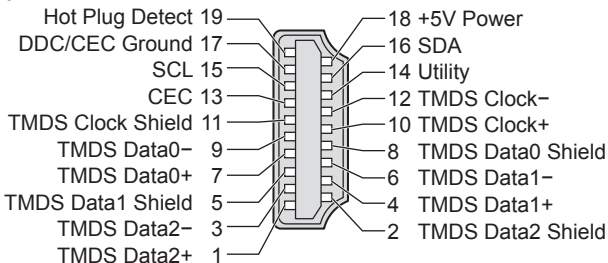

Characters table for numeric buttons

You can enter characters by using numeric buttons for free input items.

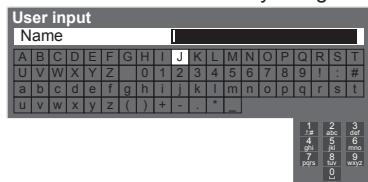

Press the numeric button repeatedly until you reach the desired character.

- The character is set automatically if you do not press the button for 1 second.
- You can also set the character by pressing the OK button or other numeric buttons within 1 second.

Characters table:

Numeric buttons	The number of times to press										
	1	2	3	4	5	6	7	8	9	10	11
1	.	1	!	:	#	+	-	*	_	()
2	a	b	c	2	A	B	C				
3	d	e	f	3	D	E	F				
4	g	h	i	4	G	H	I				
5	j	k	l	5	J	K	L				
6	m	n	o	6	M	N	O				
7	p	q	r	s	7	P	Q	R	S		
8	t	u	v	8	T	U	V				
9	w	x	y	z	9	W	X	Y	Z		
0	Space	0									

HDMI connection

HDMI (high-definition multimedia interface) is the world's first complete digital consumer AV interface complying with a non-compression standard.

HDMI allows you to enjoy high-definition digital images and high-quality sound by connecting the TV and the equipment.

HDMI-compatible equipment*1 with an HDMI or DVI output terminal, such as a DVD player, a set top box or a game equipment, can be connected to the HDMI terminal using an HDMI compliant (fully wired) cable. For information about connections, see "External Equipment" (p. 90).

Applicable HDMI features

- Input audio signal :
2ch Linear PCM
(sampling frequencies - 48 kHz, 44.1 kHz, 32 kHz)
- Input video signal :
480i, 480p, 576i, 576p, 720p, 1080i and 1080p
➔ **"Input signal that can be displayed"** (p. 98)
Match the output setting of the digital equipment.
- Input PC signal :
➔ **"Input signal that can be displayed"** (p. 98)
Match the output setting of the PC.
- VIERA Link (HDAVI Control 5)
➔ **[VIERA Link]** (p. 85)
- Content Type
- Deep Colour
- x.v.Colour™
- Audio Return Channel*2
(HDMI2 terminal only)

DVI connection

If the external equipment has only a DVI output, connect to the HDMI terminal via a DVI to HDMI adaptor cable*3. When the DVI to HDMI adaptor cable is used, connect the audio cable to the audio input terminal (HDMI1 / 2 / 3 : use AUDIO IN terminals / HDMI4 : use AV2 audio terminals).

Note

- Audio settings can be made on the [HDMI1 / 2 / 3 / 4 Input] in the Sound Menu. (p. 33)
- If the connected equipment has an aspect adjustment function, set the aspect ratio to [16:9].
- These HDMI connectors are "type A".
- These HDMI connectors are compatible with HDCP (High-Bandwidth Digital Content Protection) copyright protection.
- Equipment having no digital output terminal may be connected to the input terminal of "COMPONENT" or "VIDEO" to receive analogue signals.
- This TV incorporates HDMI™ technology.

*1 : The HDMI logo is displayed on HDMI-compliant equipment.

*2 : Audio Return Channel (ARC) is a function to be able to send digital sound signals via an HDMI cable.

*3 : Enquire at your local digital equipment retailer shop.

USB connection

- It is recommended to connect the USB HDD or USB Flash Memory directly to the TV's USB ports.
- Some USB devices or USB HUB may not be used with this TV.
- You cannot connect any devices by using USB card reader.
- You cannot use two or more same kind of USB devices simultaneously except USB Flash Memory or USB HDD.
- Additional information for USB devices may be on the following website.
<http://panasonic.jp/support/global/cs/tv/>

USB Keyboard

- The USB Keyboard which requires the driver is not supported.
- To change the language type ➔ **[USB Keyboard Layout] (p. 36)**
- Characters may not be displayed correctly on the TV screen depending on the connected keyboard or the keyboard layout setting.
- Some of the keys of USB keyboards may correspond to the operation of the remote control.

USB Keyboard	Remote Control	USB Keyboard	Remote Control
↑/↓/←/→	Cursor buttons	F2	VIERA TOOLS
Enter	OK	F3	MENU
Backspace	BACK/RETURN	F4	INPUT (AV)
Esc	EXIT	F5 / F6	Channel Down / Up
0 - 9 / Character	Numeric buttons	F7 / F8	Volume Down / Up
F1	GUIDE	F9 / F10 / F11 / F12	Coloured buttons

Gamepad

- Check the gamepads that have been tested for the performance with this TV at the following website.
<http://panasonic.jp/support/global/cs/tv/>
- Some of the keys of gamepads correspond to the operation of the remote control.

Example :

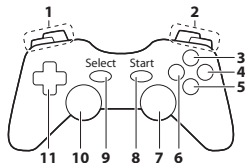

	Remote Control	Remote Control
1	Volume Up / Down	7 VIERA TOOLS
2	Channel Up / Down	8 EXIT
3	GUIDE	9 INPUT (AV)
4	OK	10 MENU
5	BACK/RETURN	11 Cursor buttons
6	VIERA Connect	

Input signal that can be displayed

COMPONENT (Y, P_B, P_R), HDMI

Signal name	COMPONENT	HDMI
525 (480) / 60i, 60p	○	○
625 (576) / 50i, 50p	○	○
750 (720) / 60p, 50p	○	○
1,125 (1,080) / 60i, 50i	○	○
1,125 (1,080) / 60p, 50p, 24p	○	○

○ Mark : Applicable input signal

PC (from HDMI terminal)

Signal name	Horizontal frequency (kHz)	Vertical frequency (Hz)
640 × 480 @60 Hz	31.47	60.00
750 (720) / 60p	45.00	60.00
1,125 (1,080) / 60p	67.50	60.00

Applicable input signal for PC is basically compatible to HDMI standard timing.

Note

- Signals other than above may not be displayed properly.
- The above signals are reformatted for optimal viewing on your display.
- PC signal is magnified or compressed for display, so that it may not be possible to show fine detail with sufficient clarity.

How to use Windows 7 as a media server

Follow the examples below to set up Windows 7 for use as a media server.

Confirm the MAC Address of VIERA in [Network Setup] (p. 77).

The following procedure and screens are examples. For more information, refer to the help functions of Windows 7.

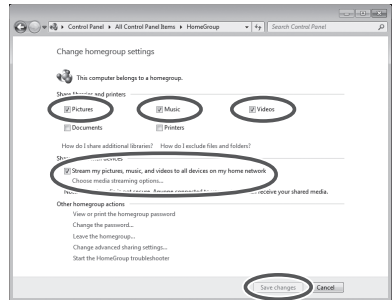
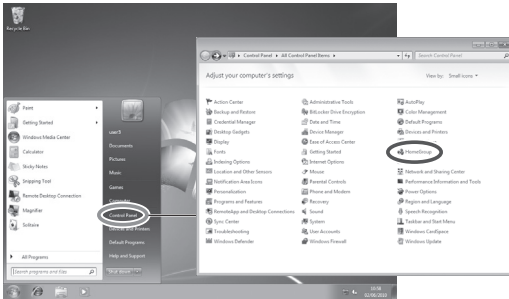

- ① Open the Windows start menu and select [Control Panel]. Select [HomeGroup] in Control Panel window.

- ② Be sure [Pictures], [Music] and [Videos] of "Share libraries and printers" and [Stream my pictures, music, and videos to all devices on my home network] of "Share media with devices" are checked. (Check them and click [Save changes] if necessary). Then select [Choose media streaming options...].

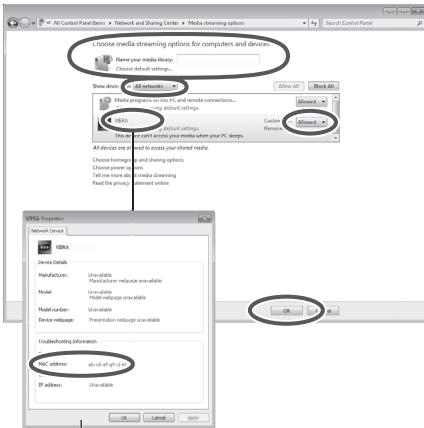

property window

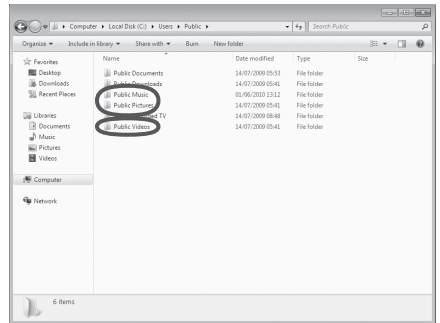

- ③ In [Name your media library:] text box, enter a name that will identify your PC on VIERA. On the Show devices drop bar, select [All networks] to display all the available devices in the list. VIERA Name stored in the [Network Link Settings] (p. 73) will be displayed. Select the VIERA Name and click [Allowed] so that VIERA can access your PC. Then, click [OK]. If the VIERA Name is not displayed correctly, click the device to confirm the MAC address of the device in property window. Find a device that has the same MAC address as VIERA: that is your VIERA.

- ④ To share photos, music and videos with VIERA, put photo files into [Public Pictures] folder and video files into [Public Videos] folder under \Computer\Local Disk (C:)\Users\Public.

FAQs

Before requesting service or assistance, please follow these simple guides to resolve the problem. If the problem still persists, please contact your local Panasonic dealer or Panasonic Customer Care Centre for assistance. For details ➔ (p. 108)

Block noise, frozen or disappearing image occurs in digital mode / White spots or shadow image (ghosting) occurs in Analogue mode / Some channels cannot be tuned

- Check the position, direction and connection of the aerial.
- Check [Signal Condition] (p. 42). If [Signal Quality] is displayed in red, the digital signal is weak.
- Check your postcode area is able to receive the Freeview channels at www.freeview.co.uk
- Digital signals may be relatively low to prevent interference with analogue signals for the period of Digital Switchover. Check the schedule of Digital Switchover at www.digitaluk.co.uk
- Weather conditions will affect signal reception (heavy rain, snow, etc.), in particular in poor reception areas. Even during good weather, high pressure can cause poor reception of some channels.
- Due to the digital reception technologies involved, quality of the digital signals may be relatively low in some cases, despite good reception of analogue channels.
- Turn the TV off with the Mains power On / Off switch, and then on again.
- If problem persists, consult your local dealer.

Neither image nor sound is produced

- Is the TV in AV mode?
- Check the correct AV input mode is selected.
- Check the mains lead is plugged into the socket outlet.
- Has the TV been turned On?
- Check the Picture Menu (p. 31) and volume.
- Check all required cables and connections are firmly in place.

Auto aspect

- Auto aspect is designed to provide you with the best ratio to fill the screen. ➔ (p. 93)
- Press the ASPECT button if you would like to change the aspect ratio manually. ➔ (p. 20)

Black and white picture

- When connecting with SCART, ensure the output setting of the external equipment is not S-Video.

Input mode, i.e. EC/AV1 remains on the screen

- Press the **i** button to clear this message.
Press again to redisplay.

Q-Link function does not work

- Confirm SCART cable and connection.
Also set [AV1 out] in the Setup Menu. ➔ (p. 34)

[VIERA Link] function does not work and an error message appears

- Confirm the connection. ➔ (p. 82, 83)
- Turn the connected equipment on and then switch the TV on. ➔ (p. 85)

Recording does not start immediately

- Check the settings of the recorder. For details, read the manual of the recorder.

Contrast is reduced

- Contrast is lowered in the following conditions without any user operation for a few minutes:
 - no signal in DVB or AV mode
 - selection of a locked channel
 - selection of an invalid channel
 - selection of a radio channel
 - displayed menu
 - digital teletext (no video contents)
 - thumbnail or still picture in Media Player or DLNA operations

	Problem	Actions
Screen	Chaotic image, noisy	<ul style="list-style-type: none"> Set [P-NR] in the Picture Menu (to remove noise). ➔ (p. 31) Check nearby electrical products. (fluorescent lamp, DECT phones, mobile phones, microwave, etc.)
	No image can be displayed	<ul style="list-style-type: none"> Is [Contrast], [Brightness] or [Colour] in the Picture Menu set to the minimum? ➔ (p. 31) Please also refer to “Neither image nor sound is produced” ➔ (p. 100)
	Blurry or distorted image (no sound or low volume)	<ul style="list-style-type: none"> Reset channels. ➔ (p. 40) Please also refer to “Neither image nor sound is produced” ➔ (p. 100)
	Unusual image is displayed	<ul style="list-style-type: none"> Turn the TV Off with Mains power On / Off switch, then turn it On again. If the problem persists, initialise all settings. ➔ [Shipping Condition] (p. 49)
Sound	No sound is produced	<ul style="list-style-type: none"> Is Sound Mute active? ➔ (p. 8) Is the volume set to the minimum? Is Speaker Selection (VIERA Link) set to [TV]? Please also refer to “Neither image nor sound is produced” ➔ (p. 100)
	Sound level is low or sound is distorted	<ul style="list-style-type: none"> Sound signal reception may be deteriorated. Set [NICAM] (p. 33) in the Sound Menu to [Off]. (Analogue only) Please also refer to “Neither image nor sound is produced” ➔ (p. 100)
	Unusual sound from the TV	<ul style="list-style-type: none"> When power is on, whirring sound of cooling fan or drive noise may be heard from inside the TV (not a sign of faulty operation).
	No programmes shown on TV Guide	<ul style="list-style-type: none"> Reset channels. ➔ (p. 40) Check the digital transmission by contacting Digital UK on 08456 50 50 50 or at www.digitaluk.co.uk Check the analogue broadcast (if still available in your area). Consult an aerial engineer to check the alignment of your aerial.
Digital Channel	Cannot find a channel you have previously watched	<ul style="list-style-type: none"> The channel may broadcast for part of the day. Check the channel in the TV Guide. ➔ (p. 21) Channel position numbers may be changed by broadcasters. Reset channels. ➔ (p. 40)
	Sound is unusual	<ul style="list-style-type: none"> Set the sound setting of the connected equipment to “2ch L.PCM”. Check the [HDMI1 / 2 / 3 / 4 Input] setting in the Sound Menu. ➔ (p. 33) If digital sound connection has a problem, select analogue sound connection. ➔ (p. 97)
HDMI	Pictures from external equipment are unusual when the equipment is connected via HDMI	<ul style="list-style-type: none"> Check the HDMI cable is connected properly. ➔ (p. 90) Turn the TV and equipment Off, then turn them On again. Check an input signal from the equipment. ➔ (p. 98) Check the output resolution of the equipment. Use equipment compliant with EIA/CEA-861/861D.
	Cannot connect to the network	<ul style="list-style-type: none"> Check the LAN cable is connected properly. ➔ (p. 72) Check the connections and settings. ➔ (p. 72 - 77) Check the network equipment and network environment. The router may not be set to issue IP address automatically. If the network administrator prefers to allocate an IP address, set an IP address manually. ➔ (p. 74) The router may be using MAC address filtering (security setting). Confirm the MAC Address of this TV (p. 76) and set the router to be able to use it. If the problem persists, consult your Internet Service Provider or telecommunications company.
Network	Cannot select the file during DLNA operations	<ul style="list-style-type: none"> Is media server of the connected equipment prepared? ➔ (p. 71) Check applicable data format. ➔ (p. 94, 95)
	Cannot operate VIERA Connect	<ul style="list-style-type: none"> Check the connections and settings. ➔ (p. 72 - 77) The server or connected line might be busy now.
	The TV does not switch On	<ul style="list-style-type: none"> Press and hold the standby On / Off switch on the remote control for about 1 second if Power LED is red. Check the mains lead is plugged into the socket. The fuse in the mains plug may have blown. Replace it with one of an identical rating ➔ (p. 4)
Other	The TV goes into Standby mode	<ul style="list-style-type: none"> Auto power standby function is activated. ➔ (p. 9) The TV enters Standby mode about 30 minutes after analogue broadcast ends.

Problem		Actions
Other	The remote control does not work or is intermittent	<ul style="list-style-type: none"> • Are the batteries installed correctly? ➔ (p. 7) • Has the TV been switched On? • The batteries may be running low. Replace them. • Point the remote control directly at the front of the TV (within about 7 m and a 30 degree angle of the front of the TV). • Situate the TV so that sunshine or other sources of bright light do not shine on the TV's remote control signal receiver.
	Parts of the TV become hot	<ul style="list-style-type: none"> • Temperature rises of parts of the front, top and rear panels will not pose any problems in terms of performance or quality of the TV.
	Overcurrent error message appears	<ul style="list-style-type: none"> • The connected USB device might cause this error. Remove the device and turn the TV Off with Mains power On / Off switch, then turn it On again. • Check if foreign objects are inside the USB port.
	An error message appears	<ul style="list-style-type: none"> • Follow the message's instructions. • If the problem persists, contact your local Panasonic dealer or the authorized Service Centre.

On screen messages

Message	Meaning / Action
All contents will be lost. Are you sure to delete this device?	<ul style="list-style-type: none"> • Once you format the USB HDD, all the recorded programme will be erased.
All tuning data will be erased Are you sure ?	<ul style="list-style-type: none"> • [Shipping Condition] will erase all tuning data ➔ (p. 49) • Confirm correct operation.
Are you sure you want to delete this timer ? Press OK to delete timer. Press RETURN to return.	<ul style="list-style-type: none"> • Confirm correct operation.
Bad signal	<ul style="list-style-type: none"> • The signal is weak. Check the aerial is plugged in properly. It may be necessary to have an aerial installer check the signal and aerial alignment. • Reset channels. ➔ (p. 40)
Child Lock is active! Press OK to enter PIN.	<ul style="list-style-type: none"> • The selected channel is locked in Child Lock (p. 47). You must enter the PIN number before the channel will be displayed.
External (USB-HDD) Recording Due to Start	<ul style="list-style-type: none"> • This message will appear 2 minutes before timer programming event for external (USB HDD) recording due to start.
Feature not available.	<ul style="list-style-type: none"> • It is not possible to record from COMPONENT or HDMI. Connect the recorder to the TV using a fully wired SCART cable for recording from the TV tuner. • Confirm Q-Link or VIERA Link settings ➔ (p. 82 - 85)
Feature not available. Press OK to view how it works.	<ul style="list-style-type: none"> • The selected feature on VIERA TOOLS is not available. Press the OK button to view the demonstration to explain how to use it.
Found new software version ***. Press OK to start update (may take over 40 mins) or press EXIT to ignore and you can update when TV is in standby	<ul style="list-style-type: none"> • There is a new software available.
Invalid operation - Please check settings and connections.	<ul style="list-style-type: none"> • Check the Q-Link or VIERA Link connection and setting ➔ (p. 82 - 85)
Invalid system time. Please exit !	<ul style="list-style-type: none"> • Cannot get the time information and cannot edit Timer Programming screen. Check the connection of the RF cable.
Invalid system time, Timer Programming will not work. Please press TV button on remote control and check time display on Banner	<ul style="list-style-type: none"> • Cannot get the time information. If there is no time displayed on the Information banner, check the connection of the RF cable.
Max. number of timers already set !	<ul style="list-style-type: none"> • The maximum number of timer programming events is 15.

Message	Meaning / Action
New channels found! Press OK to update channel list. Press EXIT to ignore.	<ul style="list-style-type: none"> • There may be new channels available. • This message will appear each time a change is made by the broadcasters. This message can be deactivated by setting [New Channel Message] to Off in [DVB Tuning Menu]. Selecting OK will perform [Update Channel List].
No channel found. Please check aerial or local signal availability. Press OK to start Auto Setup.	<ul style="list-style-type: none"> • Follow the on screen instructions. • Please also refer to p. 100. • If channels are still not found, consult your local Panasonic dealer.
No module inserted	<ul style="list-style-type: none"> • Check the CI module is inserted completely (p. 51).
No recording - Already recording	<ul style="list-style-type: none"> • The equipment may already be recording.
No recording - Check media	<ul style="list-style-type: none"> • The tape or disc may be "write protected", full, missing or damaged.
No recording - Playing	<ul style="list-style-type: none"> • The equipment may be playing the tape or disc.
No recording - Unknown reason	<ul style="list-style-type: none"> • The recording may not be performed. Check the equipment.
No service	<ul style="list-style-type: none"> • The broadcaster has stopped the service. Check the channel in the TV Guide. (p. 21)
No signal	<ul style="list-style-type: none"> • The TV cannot detect the signal. Check the connection of the RF cable.
Overcurrent error on USB device occurred. Please remove the USB device, and switch off the TV by mains power switch.	<ul style="list-style-type: none"> • The connected USB device might cause overcurrent error. Follow the on screen instructions. • Check if foreign objects are inside the USB port.
PIN incorrect!	<ul style="list-style-type: none"> • The PIN number you entered is wrong.
Please check settings and connections on HDMI devices.	<ul style="list-style-type: none"> • Communication error in VIERA Link function (p. 85).
Please wait.	<ul style="list-style-type: none"> • A function is in progress.
Recording this channel now	<ul style="list-style-type: none"> • The recorder is recording the programme from its own tuner. You can turn the TV off and leave the equipment recording in the normal way.
Reset to Factory Shipping Condition Completed. Please switch off TV.	<ul style="list-style-type: none"> • [Auto Setup] will automatically start when Mains power On / Off switch is next turned On. (p. 12)
Sending Preset Data	<ul style="list-style-type: none"> • Q-Link or VIERA Link channel download is in progress.
Software successfully updated. Press EXIT to continue.	<ul style="list-style-type: none"> • The software updating is finished.
Software update failed. Please try again later. Press EXIT to continue.	<ul style="list-style-type: none"> • Perform [System Update Search Now] in System Update (p. 52). If this is still unsuccessful, there may not be any new software available.
The device is not directly connected to the TV. The device may not work correctly.	<ul style="list-style-type: none"> • Please do not connect the device via a USB HUB.
This timer will not follow the TV Guide information. Press OK to continue, RETURN to restore original timer.	<p>UK only</p> <ul style="list-style-type: none"> • If you edit the start time or end time of Guide link programming by more than 10 minutes, it will no longer be performed as Guide link programming. The programming will be performed according to the time setting.
Timer already expired !	<ul style="list-style-type: none"> • The starting time in Timer Programming has already passed. Set the timer correctly (p. 46).
Timer incorrect !	<ul style="list-style-type: none"> • Set the start and end times in Timer Programming correctly (p. 46).
Timer overlap. Press OK to keep, RETURN to edit.	<ul style="list-style-type: none"> • Timer programming events are overlapped. Press the OK button to keep the overlapped setting. [Ext Rec.] and [USB HDD Rec.] are given priority over [Reminder]. When two or more [Ext Rec.] / [USB HDD Rec.] overlap, the first timer programming event starts and finishes as programmed. The next timer programming event can then start.
Tuner Locked Press EXIT to unlock and stop recording	<ul style="list-style-type: none"> • If you want to unlock the tuner, cancel Direct TV Recording (p. 84, 86), the recording of Timer Programming (p. 46) or One Touch Recording (p. 57).
Unable to download, please check equipment	<ul style="list-style-type: none"> • The tape or disc is active. Stop the equipment and try again.

■ Media Player

Message	Meaning / Action
Cannot read file	<ul style="list-style-type: none"> The file is broken or unreadable. Check applicable data format. (p. 94, 95)
No Device Inserted	<ul style="list-style-type: none"> Confirm the SD Card or USB device is inserted correctly.
No valid file to play	<ul style="list-style-type: none"> The card has no data.
This operation is not possible	<ul style="list-style-type: none"> The selected operation is not available.

■ Network

Message	Meaning / Action
An internal error occurred.	<ul style="list-style-type: none"> Check the settings. (p. 73 - 77)
Cannot read file	<ul style="list-style-type: none"> The file is broken or unreadable. Check applicable data format. (p. 94, 95)
Communication with the server failed.	<ul style="list-style-type: none"> This might be a problem of the media server. Read the manual of the server software.
Connection to the server failed.	<ul style="list-style-type: none"> Check the connections and settings. (p. 72 - 77)
Server not found	<ul style="list-style-type: none"> There are no available media server on your home network. Check the connections and settings. (p. 72 - 77)
The software update is not completed.	<ul style="list-style-type: none"> Network download failed. Check the connections and settings. (p. 72 - 77)
Ethernet cable not connected	<ul style="list-style-type: none"> Check the connection of the LAN cable. If you use a hub, also check the light on the hub is lit. The LAN cable might be defective.

Glossary

DLNA

Digital Living Network Alliance

DVI

Digital Visual Interface - A high quality video interface standard to connect to the display

ETHERNET

One of the popular standards of LAN

EPG

Electronic Programme Guide - A digital guide showing scheduled programmes

HDMI

High-Definition Multimedia Interface - A digital audio and video interface for transmitting uncompressed digital signals on a single cable

LAN

Local Area Network

MAC Address

Media Access control Address

NICAM

Near Instantaneous Companded Audio Multiplex - A format for digital sound over television

NTSC

National Television System Committee - One of the television signals used in USA, etc.

RF

Radio Frequency - Signal received from terrestrial aerial

RGB / Video

Choose between these three video formats depending on personal preference and equipment requirement (RGB - Red, Green and Blue)

SCART

21 pin connection used for video, audio and switching signals (Also known as Euro SCART and Peritel)

Shop viewing environment

Shop viewing environment is the demonstration mode to explain main features of this TV in an easy understandable way. This mode will work if you select [Shop] in "Auto Setup" (p. 15).

SPDIF

A standard audio transfer file format

USB

Universal Serial Bus - An interface specification to connect devices

VCR

Video Cassette Recorder

24p

Progressive images recorded at a rate of 24 frames per second (film source)

Maintenance

First, remove the mains plug from the socket outlet.

Display panel, Cabinet, Pedestal

Regular care:

Gently wipe the surface of the display panel, cabinet, or pedestal by using a soft cloth to clean the dirt or fingerprints.

Caution

- Do not use a hard cloth or rub the surface too hard. This may cause scratches on the surface.
- Take care not to subject the TV's surfaces to water or detergent more than requires. A liquid inside the TV could lead to product failure.
- Take care not to subject the surfaces to insect repellent, solvent, thinner or other volatile substances. This may degrade surface quality or cause peeling of the paint.
- The surface of the display panel is specially treated and may be easily damaged. Take care not to tap or scratch the surface with your fingernail or other hard objects.
- Do not allow the cabinet or pedestal to make contact with a rubber or PVC substance for a long time. This may degrade surface quality.

For stubborn dirt:

Dampen a soft cloth with clean water or diluted neutral detergent (1 part detergent to 100 parts water). Then wring the cloth and wipe the surface. Finally, wipe away all the moisture.

Mains plug

Index

- A** Accessories 6
- Advanced Settings 32, 53, 54
- Analogue Tuning Menu 35, 40, 43
- Aspect 20
- Audio Description 19, 33
- Auto Gain Control 33
- Auto Setup 12, 40
- Auto Standby 34
- AV1 out 34, 83
- B** Banner Display Timeout 35
- C** Category list 21
- C.A.T.S. 31
- Channel List 43, 44
- Channel Sorting by Region 41
- Child Lock 47
- Common Interface 51
- COMPONENT 93, 98
- Connection 10, 11, 55, 72, 82, 83, 90 - 92
- D** Direct TV Recording 84, 86
- DivX 95
- DLNA 78
- DTS 69
- DVB Tuning Menu 40 - 43
- DVD Recorder 10, 11, 28, 82, 90
- DVI 97
- DVI Input Setting 32
- E** EPG 21
- External equipment 10, 11, 27, 90 - 92
- External input 27, 28
- F** FAQs 100 - 102
- Favourites Edit 42
- Free input menu 30, 97
- G** Glossary 104
- Guide link programming 23
- GUIDE Plus+ Settings 34
- H** HDMI 96, 97, 104
- HDMI Content Detection 34
- Hold 19, 25
- Home Cinema 89
- I** Information banner 18
- Input Labels 48
- Input signal 98
- Intelligent Frame Creation 32
- L** Last view 18
- Licence 107
- M** Mains Lead 10
- Mains power On / Off switch 9, 12
- Maintenance 104
- Manual Tuning 41, 44
- Media Player 59 - 70
- Menu Functions 30 - 39
- Mode 30
- Monaural Audio 19
- Multi Audio 19
- Music mode 69
- N** Network connections 72
- Network Setup 73 - 77
- New Channel Message 42
- NICAM 33
- NTSC 31, 104
- O** Off Timer 19, 34
- One Touch Recording 57
- Optional accessories 6
- Owner ID 14, 50
- P** PAL 106
- Pedestal 7
- Photo mode 61
- PIN number 13, 14, 47, 50
- Pixel Orbiter 32
- Playing Time Display 35
- P-NR 31
- Power and Timer LED 9, 22, 45
- Q** Q-Link 82, 84
- Q-Link Download 12, 34
- Quick Start Guide 6 - 15
- R** Radio Mode 35
- Remote control 6, 8
- Reset to Defaults 32, 33
- Reversal Film Effect 31
- Rewind LIVE TV 58
- RGB 106
- S** Safely remove USB 19
- Sales and Support Information 108
- Satellite receiver 11, 90
- SCART 90, 96
- SD Card 59, 96
- Search list 22
- Shipping Condition 49
- Signal Condition 42
- Slideshow 62, 79
- Software Update 52, 77
- Specifications 106, 107
- Split Programme 23
- Subtitles 20, 26
- System Update 52
- T** Teletext 24 - 26
- THX 31
- Timer Programming 22, 45
- True Cinema 31
- TV Guide 21 - 23
- TV Guide Settings 34
- U** Update Channel List 43
- USB Flash Memory 59, 96
- USB HDD 55, 96
- USB connection 98
- V** V-Audio 33
- VCR 10, 11, 28, 90
- Video mode 65
- VIERA Connect 16, 81
- VIERA Link 82, 83, 85 - 89
- VIERA TOOLS 29
- Viewing Mode 31
- Vivid Colour 31
- Volume Correction 19, 33
- W** Wireless LAN Adaptor 6, 11, 13, 14, 72
- WSS 93
- Z** Zoom 20, 63
- 24p Smooth Film 32

Specifications

		TX-P42G30B	TX-P50G30B
Power Source		AC 220-240 V, 50 / 60 Hz	
Rated Power Consumption		275 W	320 W
Standby Power Consumption		0.40 W 16.00 W (With monitor out recording)	
Dimensions (W × H × D)		1,020 mm × 675 mm × 320 mm (With Pedestal) 1,020 mm × 640 mm × 70 mm (TV only)	1,204 mm × 779 mm × 335 mm (With Pedestal) 1,204 mm × 744 mm × 70 mm (TV only)
Mass		24.0 kg Net (With Pedestal) 20.5 kg Net (TV only)	30.0 kg Net (With Pedestal) 26.0 kg Net (TV only)
Display panel	Aspect Ratio	16:9	
	Visible screen size	106 cm (diagonal) 921 mm (W) × 518 mm (H)	127 cm (diagonal) 1,105 mm (W) × 662 mm (H)
	Number of pixels	2,073,600 (1,920 (W) × 1,080(H)) [5,760 × 1,080 dots]	
Sound	Speaker	(140 mm × 35 mm) × 2, 6 Ω	
	Audio Output	20 W (10 W + 10 W)	
	Headphones	M3 (3.5 mm) stereo mini Jack × 1	
Receiving Systems / Band name		UK DVB-T / T2 Digital terrestrial services. PAL I UHF E21-68 PAL 525/60 Playback of NTSC tape from some PAL Video recorders (VCR) or NTSC disc playback from DVD player and recorder. M.NTSC Playback from M.NTSC Video recorders (VCR). NTSC (AV input only) Playback from NTSC Video recorders (VCR).	
		Ireland DVB-T Digital terrestrial services. PAL I VHF A - J UHF E21 - E69 CATV S1 - S20 CATV S21 - S41 (Hyperband) PAL 525/60 Playback of NTSC tape from some PAL Video recorders (VCR) or NTSC disc playback from DVD player and recorder. M.NTSC Playback from M.NTSC Video recorders (VCR). NTSC (AV input only) Playback from NTSC Video recorders (VCR).	
Aerial input		UK UHF	Ireland VHF / UHF
Operating Conditions		Temperature: 0 °C - 35 °C Humidity: 20 % - 80 % RH (non-condensing)	
Connection Terminals	AV1 (SCART)	21 Pin terminal (Audio/Video in, Audio/Video out, RGB in, Q-Link)	
	AV2 input	VIDEO	RCA PIN Type × 1 1.0 V[p-p] (75 Ω)
		AUDIO L - R	RCA PIN Type × 2 0.5 V[rms]
	COMPONENT input	Y 1.0 V[p-p] (including synchronization) P_B, P_R ±0.35 V[p-p]	
HDMI 1 / 2 / 3 / 4 input	TYPE A Connectors HDMI1 / 3 / 4 : HDMI (Version 1.4 with Content Type), Deep Colour, x.v.Colour™ HDMI2 : HDMI (Version 1.4 with Content Type, Audio Return Channel), Deep Colour, x.v.Colour™ • This TV supports "HDAVI Control 5" function.		

Connection Terminals	Card slot	SD Card slot × 1 Common Interface slot × 1
	ETHERNET	RJ45, IEEE802.3 10BASE-T / 100BASE-TX
	USB 1 / 2 / 3	USB2.0 DC 5 V, Max. 500 mA
	AUDIO OUT	RCA PIN Type × 2 0.5 V[rms] (high impedance)
	DIGITAL AUDIO OUT	PCM / Dolby Digital / DTS, Fiber optic

- Design and Specifications are subject to change without notice. Mass and Dimensions shown are approximate.
- This equipment complies with the EMC standards listed below.
EN55013, EN61000-3-2, EN61000-3-3, EN55020, EN55022, EN55024

Licence

Even if no special notation has been made of company or product trademarks, these trademarks have been fully respected.

- DVB and the DVB logos are trademarks of the DVB Project.
- SDXC Logo is a trademark of SD-3C, LLC.
- HDMI, the HDMI Logo, and High-Definition Multimedia Interface are trademarks or registered trademarks of HDMI Licensing LLC in the United States and other countries.
- HDAVI Control™ is a trademark of Panasonic Corporation.
- “AVCHD” and the “AVCHD” logo are trademarks of Panasonic Corporation and Sony Corporation.
- x.v.Colour™ is a trademark.
- THX and the THX logo are trademarks of THX Ltd. which may be registered in some jurisdictions. All rights reserved.
- Manufactured under license from Dolby Laboratories.
Dolby and the double-D symbol are trademarks of Dolby Laboratories.
- Manufactured under license under U.S. Patent #'s: 5,451,942; 5,956,674; 5,974,380; 5,978,762; 6,487,535 & other U.S. and worldwide patents issued & pending. DTS and the Symbol are registered trademarks, & DTS 2.0+ Digital Out and the DTS logos are trademarks of DTS, Inc. Product includes software. © DTS, Inc. All Rights Reserved.
- VIERA Connect is a trademark of Panasonic Corporation.
- DLNA®, the DLNA Logo and DLNA CERTIFIED™ are trademarks, service marks, or certification marks of the Digital Living Network Alliance.
- Windows is a registered trademark of Microsoft Corporation in the United States and other countries.
- DivX®, DivX Certified®, DivX Plus™ HD and associated logos are trademarks of DivX, Inc. and are used under license.
- The Skype name, associated trade marks and logos and the “S” symbol are trade marks of Skype Limited.
- QuickTime and the QuickTime logo are trademarks or registered trademarks of Apple Inc., used under license therefrom.
- GUIDE Plus+ is (1) a registered trademark or trademark of, (2) manufactured under license from and (3) subject of various international patents and patent applications owned by, or licensed to, Rovi Corporation and/or its related affiliates.



Information for Users on Collection and Disposal of Old Equipment and used Batteries



These symbols on the products, packaging, and/or accompanying documents mean that used electrical and electronic products and batteries should not be mixed with general household waste. For proper treatment, recovery and recycling of old products and used batteries, please take them to applicable collection points, in accordance with your national legislation and the Directives 2002/96/EC and 2006/66/EC.

By disposing of these products and batteries correctly, you will help to save valuable resources and prevent any potential negative effects on human health and the environment which could otherwise arise from inappropriate waste handling.



For more information about collection and recycling of old products and batteries, please contact your local municipality, your waste disposal service or the point of sale where you purchased the items. Penalties may be applicable for incorrect disposal of this waste, in accordance with national legislation.

For business users in the European Union

If you wish to discard electrical and electronic equipment, please contact your dealer or supplier for further information.

[Information on Disposal in other Countries outside the European Union]

These symbols are only valid in the European Union. If you wish to discard these items, please contact your local authorities or dealer and ask for the correct method of disposal.



Note for the battery symbol (bottom two symbol examples) :

This symbol might be used in combination with a chemical symbol. In this case it complies with the requirement set by the Directive for the chemical involved.

Cd

Sales and Support Information

Customer Care Centre

- For customers within the UK: **0844 844 3852**
- For customers within Ireland: **01 289 8333**
- Visit our website for product information: www.panasonic.co.uk
- E-mail: customer.care@panasonic.co.uk

Direct Sales at Panasonic UK

- For customers: **0844 844 3856**
- Order accessory and consumable items for your product with ease and confidence by phoning our Customer Care Centre Monday – Thursday 9:00am – 5:30pm, Friday 9:30am – 5:30pm (Excluding public holidays).
- Or go on line through our Internet Accessory ordering application at www.pas-europe.com.
- Most major credit and debit cards accepted.
- All enquiries transactions and distribution facilities are provided directly by Panasonic UK Ltd.
- It couldn't be simpler!
- Also available through our Internet is direct shopping for a wide range of finished products, take a browse on our website for further details.



Declaration of Conformity (DoC)

Authorized Representative :
Panasonic Testing Centre
Panasonic Marketing Europe GmbH
Winsbergring 15, 22525 Hamburg, Germany

Customer's Record

The model number and serial number of this product may be found on its rear panel. You should note this serial number in the space provided below and retain this book, plus your purchase receipt, as a permanent record of your purchase to aid in identification in the event of theft or loss, and for Warranty Service purposes.

Model Number

Serial Number

Panasonic UK Ltd.

Willoughby Road, Bracknell, Berkshire, RG12 8FP

Web Site : <http://panasonic.net>

© Panasonic Corporation 2011

M0211-0

Printed in Czech Republic