

Panasonic®

Operating Instructions for advanced features

Digital Camera

Model No. **DMC-LX100**

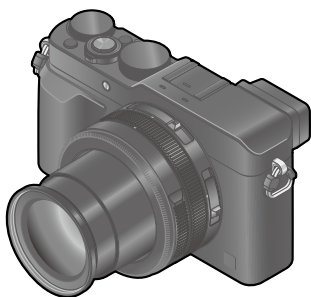

LUMIX

Please read these instructions carefully before using this product,
and save this manual for future use.

Message Display →299

Q&A Troubleshooting →310

Finding the information you need →2

Contents →4

Contents by Function →10

Menu list →303

Finding the information you need

In this “Operating Instructions for advanced features”, you can find the information you need from the following pages.

By clicking a page number, you can jump to the linked page and quickly find the information.

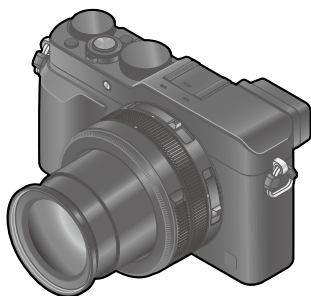

Search from “Contents” → [P.4 -](#)

Search from the list of function names → [P.10 -](#)
“Contents by Function”

Search from “Names and Functions of Main Parts” → [P.14 -](#)

Search from “List of monitor/viewfinder displays” → [P.293 -](#)

Search from the list of on-screen messages → [P.299 -](#)
“Message displays”

Search from the menu list → [P.303 -](#)
“Menu list”





[Rec]	P.303	[Setup]	P.308
[Motion Picture].....	P.305	[Playback]	P.309
[Custom]	P.306		

Search from “Q&A Troubleshooting” → [P.310 -](#)

For details on how to use this manual, see the next page.

Wi-Fi® function → [224](#)

Recording mode icons

Recording mode:     

In Recording Modes that show icons in black, you can select and execute indicated menus and functions.

- Click a cross reference in the text to jump to the corresponding page.
- By entering keywords in the search field at the top of the Adobe Reader screen, you can run a keyword search and jump to the corresponding page.
- Operations and other details of this manual may vary depending on the Adobe Reader version you are using.

■ About the symbols in the text

 Indicates that the menu can be set by pressing [MENU/SET] button.

 Indicates that the Wi-Fi setting can be made by pressing [Wi-Fi] button.

 Configurations that can be performed in the [Custom] menu.



 Tips for skilful use and points for recording.

 Conditions in which a particular function cannot be used.

(→00) Indicates the reference page. Click to go to the corresponding page.

 Click to view the description on the next page.

In this Operating Instructions, steps for setting a menu item are described as follows:

 →  [Rec] → [Quality] → []

 Click this icon to jump to “Finding the information you need”.

 Click this icon to jump to “Contents”.

 Click this icon to jump to “Menu list”.

 Click this icon to return to the previously displayed page.

■ Finding the information you need	2
■ How to use this manual	3
■ Contents by Function	10

Before Use

■ Before use	12
■ Standard Accessories	13
■ Names and Functions of Main Parts	14
[MENU/SET] button / Cursor button / Control dial	18

Preparations

■ Attaching the lens cap and shoulder strap	19
■ Charging battery	20
Remaining battery	21
Guidelines for number of recordable pictures and operating time	22
■ Inserting and removing the battery/ the card (optional)	24
■ About the Card	25
Formatting the card (initialisation)	26
Recording capacity guidelines (pictures/recording time)	27
■ Setting the clock	29
Changing time settings	30
■ Setting the menu	31
Setting the menu screen background	33
■ Calling frequently-used menus instantly (Quick Menu)	34
Change the Quick Menu to your preferred item	35
■ Assigning frequently used functions to the buttons (Function buttons)	37
■ Changing settings using the control ring	39
Changing the settings assigned to the control ring	40
■ Using the [Setup] menu	41
[Clock Set]	41
[World Time]	41
[Travel Date]	42
[Wi-Fi]	42
[Beep]	43
[Live View Mode]	43
[Monitor Display] / [Viewfinder]	44
[Monitor Luminance]	45
[Sleep Mode]	46
[USB Mode]	47
[TV Connection]	47
[Menu Resume]	49
[Menu Background]	49
[Menu Information]	49
[Language]	49
[Version Disp.]	50
[Self Timer Auto Off]	50
[No.Reset]	50
[Reset]	50
[Reset Wi-Fi Settings]	51
[Format]	51
■ Entering Text	52

Basics

- **Holding the camera**..... 53
- **Recording pictures using the viewfinder** 54
 - Switching between the monitor and viewfinder.....54
 - About Eye Sensor AF55
- **Taking pictures**..... 56
- **Recording motion pictures** 58
- **Select the recording mode**..... 59
- **Switching the display information on the recording screen** 62
- **Viewing your pictures**..... 67
 - Viewing motion pictures.....70
- **Switching the display information on the playback screen** 71
- **Deleting pictures**..... 73
 - [Delete Single]73
 - To delete multiple (up to 100)/
To delete all pictures74

Recording mode

- **Taking pictures with automatic settings**
- **[Intelligent Auto] Mode** 75
 - Taking pictures using a handheld camera ([iHandheld Night Shot])78
 - Combining pictures into a single still picture with rich gradation ([iHDR]).....79
- **Taking pictures after setting the aperture value and shutter speed ...** 80
 - Taking pictures after automatically setting the aperture value and shutter speed ([Program AE] Mode).....81
 - Taking pictures by setting the aperture value ([Aperture-Priority] Mode)..... 83
 - Taking pictures by setting the shutter speed ([Shutter-Priority] Mode)..... 84
 - Taking pictures by setting the aperture value and shutter speed ([Manual Exposure] Mode)86
 - Checking the effects of the aperture value and shutter speed ([Preview] Mode).....88

Picture effects (Filter)

- **Taking pictures using picture effects (Filter)** 89

Picture Quality and colouring Settings

- **Adjusting the picture quality with effects [Photo Style] 100**
- **Adjusting highlights and shadows [Highlight Shadow] 102**
- **Adjusting the White Balance 103**
- **Setting the picture quality and size 107**
 - Changing the aspect ratio of the still pictures 107
 - Setting the picture size 108
 - Setting the compression rate of pictures ([Quality]) 109
- **Using the picture correction functions effectively 111**
 - Correcting contrast and exposure ([i.Dynamic]) 111
 - Enhancing the impression of high-resolution ([i.Resolution]) 111
 - Combining still pictures with different exposures ([HDR]) 112
 - Suppressing the noise of a long exposure ([Long Shtr NR]) 113
 - Setting the colour space 113

Adjusting the focus and brightness (exposure)

- **Taking pictures with Auto Focus... 114**
 - Select the focus mode (AFS, AFF, AFC) 114
 - Switching [AF Mode] 115
 - Changing the position and size of the AF area 121
 - Setting your preferred focusing method ... 124
- **Taking close-up pictures (Macro recording) 126**
 - Focus range 126
- **Taking pictures with Manual Focus 128**
 - MF Assist 131
- **Taking pictures by locking the focus and/or exposure [AF/AE Lock] 133**
- **Taking pictures with Exposure Compensation 135**
- **Setting the ISO Sensitivity 136**
 - Setting the upper limit of ISO Sensitivity 137
 - Setting the incremental value of ISO Sensitivity 138
 - Extending the ISO Sensitivity setting 138
- **Setting the metering mode 139**

Shutter and Drive Settings

- **Setting the Shutter Type 140**
- **Selecting a Drive Mode 141**
- **Burst function 142**
- **Recording while exposure is changed automatically [Auto Bracket] 145**
- **Automatically changing the aspect ratio while taking pictures [Aspect Bracket] 147**
- **Taking pictures with self-timer 148**
- **Recording panorama pictures 150**

Functions for specific subjects and purposes

- Taking pictures automatically at set intervals
[Time Lapse Shot] 153
- Creating stop motion animation
[Stop Motion Animation] 156
- Performing multiple exposures for a single picture [Multi Exp.] 159
- Disabling the beeps and flash at the same time
[Silent Mode] 161
- Recording with the Face Recognition function
[Face Recog.] 162
- Setting the profile for a baby or pet to record in a picture 165
- Displaying the appropriate screen for specific recording conditions... 166

Stabiliser, Zoom and Flash

- Correcting jitter 168
- Using Zoom 170
 - Zoom types and use 171
- Taking pictures using the flash (supplied)..... 176
 - Attaching the flash 176
 - Changing the firing mode (Manual flash)..... 179
 - Changing Flash Mode..... 180
 - Setting the 2nd curtain sync 182
 - Adjusting the flash output 183
 - Synchronising the flash output with the camera during Exposure Compensation 183
 - Performing wireless flash settings 184

Recording motion pictures

- Recording motion pictures 187
 - Setting the format, picture size and recording frame rate 187
 - Adjusting the focus while recording motion pictures ([Continuous AF]) 189
 - Recording motion pictures 190
 - Recording 4K motion pictures..... 194
 - Creating a high-resolution still picture from a 4K motion picture [4K PHOTO] 195
- Taking still pictures while a motion picture is being recorded 198
- Using the [Motion Picture] menu... 199
 - [4K PHOTO]..... 199
 - [Rec Format]..... 199
 - [Rec Quality] 199
 - [Picture Mode]..... 199
 - [Continuous AF] 199
 - [Mic Level Disp.] 200
 - [Mic Level Adj.]..... 200
 - [Wind Cut] 200

Playing Back and Editing Pictures

■ Viewing the group picture	201	[Time Lapse Video]	215
■ Capturing still pictures from motion pictures	203	[Stop Motion Video]	215
■ Using the [Playback] menu	204	[Resize]	216
[Slide Show]	204	[Cropping]	217
[Playback Mode]	206	[Rotate] / [Rotate Disp.]	218
[Location Logging]	207	[Favorite]	219
[RAW Processing]	208	[Print Set]	220
[Title Edit]	211	[Protect]	221
[Text Stamp]	212	[Face Rec Edit]	222
[Video Divide]	214	[Picture Sort]	223
		[Delete Confirmation]	223

Wi-Fi

■ Wi-Fi® Function and NFC Function	224	■ Displaying still pictures on a TV....	242
■ What you can do with the Wi-Fi function	227	■ Wireless printing	243
■ Operating the camera by connecting it to a smartphone.....	228	■ Sending pictures to AV device.....	244
Installing the smartphone/tablet app		■ Sending pictures to a PC	247
"Panasonic Image App"	228	■ Using WEB services	251
Connecting to a smartphone.....	229	When sending images to WEB service....	251
Connecting to a smartphone using NFC function.....	233	When sending images to [Cloud Sync. Service]	255
Taking pictures via a smartphone (remote recording)	234	■ Using "LUMIX CLUB"	258
Playing back pictures in the camera on a smartphone.....	235	About the [LUMIX CLUB]	258
Saving pictures in the camera to the smartphone.....	235	■ About connections	263
Easily transferring pictures in the camera.....	236	[Via Network]	
Sending pictures in the camera to social networking services	237	Connecting via a wireless access point...264	
Adding location information to pictures in the camera from a smartphone.....	237	[Direct]	
Operating the camera to send pictures to a smartphone.....	239	Connecting directly	267
		Connecting quickly with the same settings as used previously	
		([Select a destination from History] / [Select a destination from Favorite]).....	268
		Settings for sending pictures	270
		■ [Wi-Fi Setup]	272

Connecting with other devices

- **Enjoying 4K motion pictures 274**
 - Viewing 4K motion pictures 274
 - Storing 4K motion pictures..... 275
- **Viewing on TV screen..... 276**
 - VIERA Link (HDMI) (HDAVI Control™)..... 278
- **Storing recorded still pictures and motion pictures on your PC..... 280**
 - About supplied software 281
 - Installing supplied software..... 283
 - Copying still pictures and motion pictures 284
- **Storing recorded still pictures and motion pictures in the recorder..... 286**
 - Copying by inserting the card into the recorder 286
 - Dubbing playback pictures via AV cables (optional)..... 286
- **Printing 287**
 - Printing multiple pictures..... 288
 - Printing with date and text 289
 - Making print settings on the camera..... 290

Others

- **Optional accessories..... 291**
 - External Flash (optional)..... 291
 - Using the AC adaptor (optional) and DC coupler (optional) instead of the battery..... 292
- **List of monitor/viewfinder displays..... 293**
- **Message displays 299**
- **Menu list 303**
- **Q&A Troubleshooting..... 310**
- **Usage cautions and notes 326**



Recording

Recording

Recording mode	59
[Preview]	88
Picture effects (Filter)	89
Macro recording	126
Recording panorama pictures	150
[Time Lapse Shot]	153
[Stop Motion Animation]	156
[Multi Exp.]	159
[Silent Mode]	161

Focus (AF/MF)

Focus Mode	114
AF Mode	115
Adjusting the AF area position	121
Manual Focus	128
AF/AE Lock	133

Exposure

AF/AE Lock	133
Exposure Compensation	135
ISO sensitivity	136
[Metering Mode]	139
[Auto Bracket]	145

Drive

Drive Mode	141
[Aspect Bracket]	147
[Self Timer]	148

Picture Quality and Colour Tone

[Photo Style]	100
[Highlight Shadow]	102
White Balance	103
[Picture Size]	108
[Quality]	109
[i.Dynamic]	111
[i.Resolution]	111
[HDR]	112
[Long Shtr NR]	113
[Color Space]	113

Flash

[Flash Mode]	180
2nd curtain synchro	182
[Flash Adjust.]	183
Wireless flash settings	184

Screen settings

[Monochrome Live View]	167
[Mic Level Disp.]	200



Motion Picture

Motion Picture

[Rec Format]	187
[Rec Quality]	187
Motion pictures in 4K	194
[4K PHOTO]	195
Taking still pictures while a motion picture is being recorded	198

Audio

[Mic Level Adj.]	200
[Wind Cut]	200



Setup/Custom

Basic settings

[Format]	26
[Clock Set]	29
How to set menu items	31
[Q.MENU]	34
[Beep]	43
[Sleep Mode]	46
[Reset] (initialisation)	50
Diopter adjustment	55
Display switching	62, 71

Customisation

[CUSTOM] in the Quick Menu	35
Function buttons	37
Control ring	40
Custom Set	60
[Custom] menu	306
[Cursor Button Lock]	38
Motion picture button	192



Playback

Playback

[Auto Review]	57
Picture playback	67
Playback Zoom	68
Multi Playback	68
Motion picture playback	70
Delete	73

Display/playback settings

[Slide Show]	204
[Rotate]/[Rotate Disp.]	218

Edit

[RAW Processing]	208
[Resize]	216
[Cropping]	217

Adding information

[Location Logging]	207
[Title Edit]	211
[Text Stamp]	212

Image settings

[Favorite]	219
[Print Set]	220
[Protect]	221



Wi-Fi

Connect

"Image App"	228
NFC	233
[WPS (Push-Button)]	264, 267
Direct connection	267

Image App

Remote recording	234
Saving images	235
Sending images	236, 239
Sending and adding location information ...	237
[Touch Sharing]	272

In combination with other devices

Playing back pictures on a TV	242
Printing images	243
Sending images to an AV device	244
Sending images to a PC	247
Sending images to a WEB service	251
Using [Cloud Sync. Service]	255



Connecting with other devices

PC

"PHOTOfunSTUDIO"	281
SILKYPIX	282

TV

[VIERA Link]	278
--------------------	-----

Recorder

Dubbing	286
---------------	-----

Printer

PictBridge	287
------------------	-----

Before use

■ Camera handling

Keep the camera away from excessive vibration, force, or pressure.

- Avoid using the camera under the following conditions, which may damage the lens, monitor, viewfinder, or camera body. This may also cause the camera to malfunction or prevent recording.
 - Dropping or hitting the camera against a hard surface
 - Pushing with excessive force on the lens or monitor

The camera is not dust resistant, splash resistant, or waterproof.

Avoid using the camera in places with excessive dust or sand, or where water can come into contact with the camera.

- Avoid using the camera under the following conditions, which present a risk that sand, water, or foreign material may enter the camera through the lens or openings around buttons. Be especially careful because these conditions may damage the camera, and such damage may not be repairable.
 - In extremely dusty or sandy places
 - In the rain or by the shore, where the camera may be exposed to water

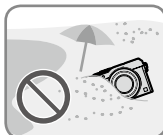
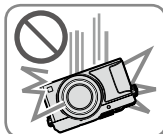

■ Condensation (When the lens, the monitor, or viewfinder, is fogged up)

- Condensation may occur when the camera is exposed to sudden changes of temperature or humidity. Avoid these conditions, which may make the lens, monitor, or viewfinder, dirty, cause mould, or damage the camera.
- If condensation does occur, turn off the camera and wait about two hours before using it. Once the camera adjusts to the surrounding temperature, the fogging will clear naturally.

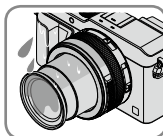

■ Always take a test shot first

Before important events when you will use the camera (at weddings, for example), always take a test shot to make sure that pictures and sound record correctly.

■ No compensation for missed shots

We cannot compensate for missed shots if technical problems with the camera or card prevent recording.

■ Carefully observe copyright laws

Unauthorised use of recordings that contain works with copyright for purposes other than personal use is prohibited under copyright law. Recording of certain material may be restricted even for the purpose of personal use.

■ Also refer to “Usage cautions and notes” (→326)

Standard Accessories

Check that all the accessories are supplied before using the camera.

- The accessories and their shape will differ depending on the country or area where the camera was purchased.

For details on the accessories, refer to Basic Operating Instructions.

- Battery Pack is indicated as battery pack or battery in the text.
- SD Memory Card, SDHC Memory Card and SDXC Memory Card are indicated as card in the text.
- Please dispose of all packaging appropriately.
- Keep small parts in a safe place out of the reach of children.

■ Optional accessories

- Cards are optional.

Names and Functions of Main Parts

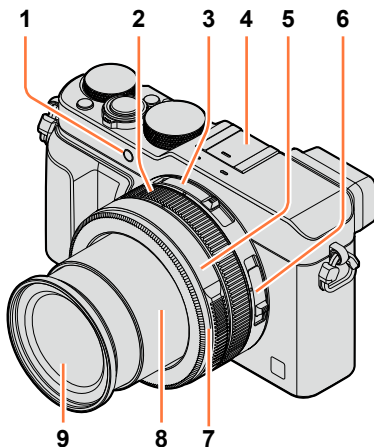

- | | |
|---|--|
| 1 | Self-timer indicator (→148) / AF Assist Lamp (→53, 125) |
| 2 | Control ring (→39) |
| 3 | Aspect ratio selector switch (→107) |
| 4 | Hot shoe (Hot shoe cover) (→176)
The hot shoe cover is already attached to the hot shoe at the time of purchase. |
| 5 | Aperture ring (→59) |
| 6 | Focus selector switch (→114, 126, 128) |
| 7 | Lens front ring
To attach the auto lens cap (optional), remove the lens front ring. |
| 8 | Lens barrel |
| 9 | Lens (Filter diameter Φ43 mm) |

Names and Functions of Main Parts

(Top)

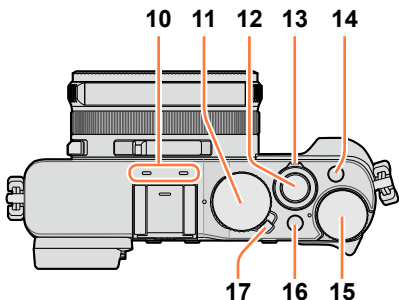

- 10 Stereo microphone** (→53, 200)
Be careful not to cover the microphone with your finger. Doing so may make sound difficult to record.
- 11 Shutter speed dial** (→59)
- 12 Shutter button**
- 13 Zoom lever** (→170)
- 14 [FILTER] button** (→89)
- 15 Exposure compensation dial** (→135)
- 16 [iA] button** (→59)
- 17 Camera [ON/OFF] switch**

(Bottom)

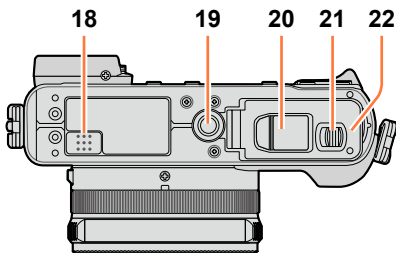

- 18 Speaker**
Be careful not to cover the speaker with your finger. Doing so may make sound difficult to hear.
- 19 Tripod mount** (→329)
Do not attach to a tripod with a 5.5 mm (0.22 inch) or longer screw. Doing so may damage this unit. It may not be possible to attach certain types of tripods properly.
- 20 DC coupler cover**
Open this cover to use an AC adaptor (optional) and DC coupler (optional) in place of the battery. When using an AC adaptor (optional), ensure that the Panasonic DC coupler (optional) and AC adaptor are used. (→292)
- 21 Release lever** (→24)
- 22 Card/Battery door** (→24)

Names and Functions of Main Parts

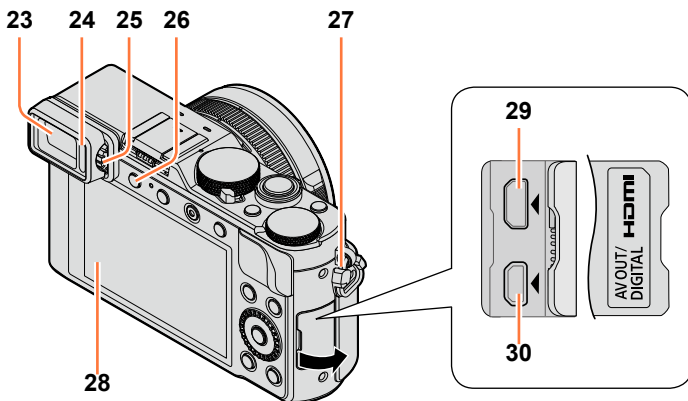
**23 Viewfinder (LVF) (→54)**

In this manual, “viewfinder” is used to indicate the LVF.

24 Eye Sensor (→54)**25 Diopter adjustment dial (→55)****26 [LVF] button (→54) / [Fn3] button (→37)****27 Strap eyelet (→19)****28 Monitor****29 [HDMI] socket (→276)****30 [AV OUT/DIGITAL] socket (→276, 284, 286, 287)**

Names and Functions of Main Parts

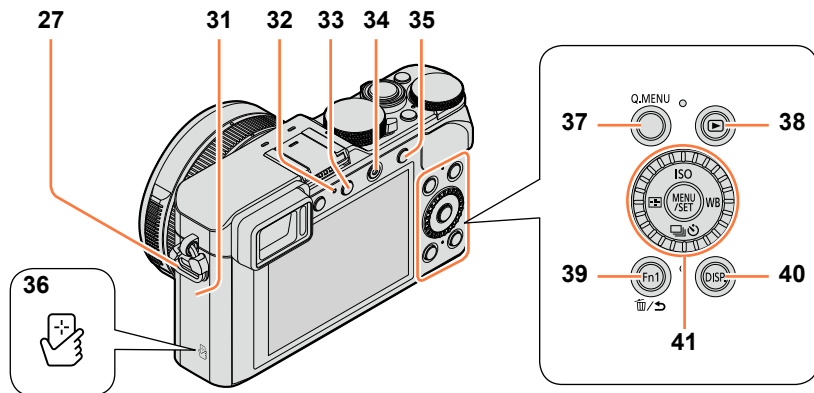

- 27 **Strap eyelet** (→19)
- 31 **Wi-Fi® antenna**
- 32 **Wi-Fi connection lamp** (→225)
- 33 **[Wi-Fi] button** (→225) / **[Fn2] button** (→37)
- 34 **Motion picture button** (→58)
- 35 **[AF/AE LOCK] button** (→133)
- 36 **NFC antenna** (→233)
- 37 **[Q.MENU] button** (→34)
- 38 **Playback button** (→67)
- 39 **[Fn1] button** (→37) / **[/↵] (Delete/Cancel) button** (→32, 73)
- 40 **[DISP.] button** (→62, 71)
- 41 **[MENU/SET] button / Cursor button / Control dial** (→18)

● The illustrations and screens in this manual may differ from the actual product.

[MENU/SET] button / Cursor button / Control dial

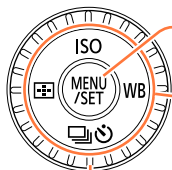

[MENU/SET] button

Use this button to display the menus, enter the settings, etc. (→31)

Cursor button

This button is used to move the cursor on the menu screens and for other functions. (→32)

You can perform the following operations while recording.

[ISO] button (▲) (→136)

[WB] (White Balance) button (▶) (→103)

[Drive Mode] button (▼)

Single (→141), Burst (→142), Auto Bracket (→145),

Aspect Bracket (→147), Self-timer (→148), Panorama (→150)

[AF Mode] button (◀) (→115, 131)

Control dial

Turn the dial to select setting items and change setting values. (→32, 67)





Disabling the button and dial operation (while recording)

When the [Cursor Button Lock] is assigned to the function button, operation of the [MENU/SET] button, cursor button, and control dial is disabled. (→38)



Enabling/disabling the operation guide display

MENU → **fC** [Custom] → [Dial Guide] → [ON] / [OFF]

- When you set the operation guide to [ON], the operation guide for the control ring ([]), control dial ([]), and other parts appear on the recording screen.



- In this manual, the button that is to be used is indicated by ▲▼◀▶.

Attaching the lens cap and shoulder strap

Cover the lens with the lens cap to protect it when you are not taking pictures. We recommend attaching the lens cap to the camera using the lens cap string to prevent loss of the lens cap. We also recommend attaching the shoulder strap to prevent the camera from being dropped.

1 Use the lens cap string (supplied) to attach the lens cap to the camera

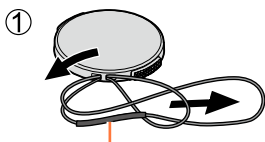

Make sure that the thicker portion of the string is not hanging over the lens cap or the shoulder strap eyelet.

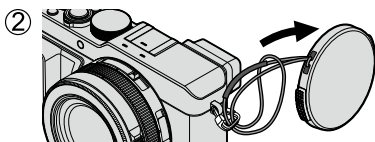

2 Attach the lens cap

To attach and remove the lens cap, press the areas shown by arrows in the illustration.

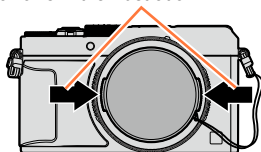

3 Attach the shoulder strap

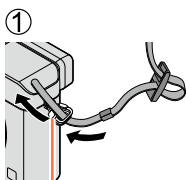

Shoulder strap eyelet

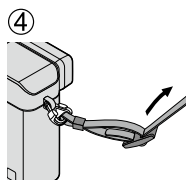
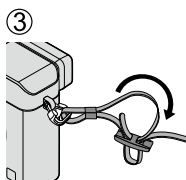
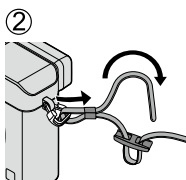

- Attach the other end of the shoulder strap.
- Make sure that the shoulder strap does not come loose.
- Attach the shoulder strap with the LUMIX logo on the strap facing out.
- Use the shoulder strap around your shoulder.
 - Do not wrap the strap around your neck. It may result in injury or accident.
- Do not leave the shoulder strap where an infant can reach it.
 - It may result in an accident by mistakenly wrapping around the neck.

Charging battery

Always charge before first use! (battery shipped uncharged)

About batteries that you can use with this unit

It has been found that counterfeit battery packs which look very similar to the genuine products are made available to purchase in some markets. Some of these battery packs are not adequately protected with internal protection to meet the requirements of appropriate safety standards. There is a possibility that these battery packs may lead to fire or explosion. Please be advised that we are not liable for any accident or failure occurring as a result of use of a counterfeit battery pack. To ensure that safe products are used we recommend that a genuine Panasonic battery pack is used.

- Use the dedicated charger and battery.

1 Attach the battery paying attention to the direction of the battery

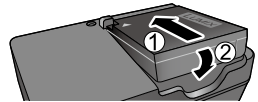

2 Connect the charger to the electrical outlet

Plug-in type

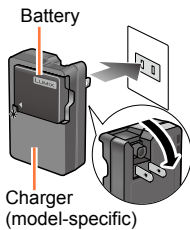

Inlet type

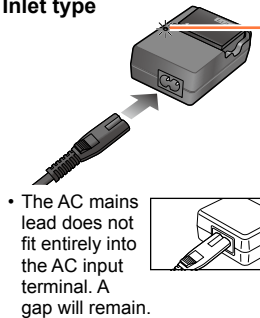

Charging light ([CHARGE])

On: Charging in progress
Off: Charging complete

If light is flashing:

- Battery temperature is too high or too low. We recommend charging in a location where the ambient temperature is between 10 °C and 30 °C (50 °F to 86 °F).
- Battery/charger connector is dirty. Clean with a dry cloth.

- Charge the battery with the charger indoors.

3 Detach the battery after charging is completed

- The battery charger is in the standby condition when the AC power is supplied. The primary circuit is always "live" as long as the battery charger is connected to an electrical outlet.

Notes on charging time

Charging time	Approx. 190 min
---------------	-----------------

- The charging time indicated above is the time required for charging in case when the battery is completely used up. The time required for charging differs depending on conditions of battery usage. Charging takes longer in cases when temperatures are either high or low and when the battery has not been used for a long period of time.

Remaining battery

When using the camera, the remaining battery capacity is displayed.



Remaining battery (only when using battery)

 (flashes red)

If the battery mark flashes red, recharge or replace a fully charged battery.

- Always use genuine Panasonic batteries.
- If you use other batteries, we cannot guarantee the quality of this product.
- **Remove battery from camera after use.**
 - Keep the battery in a plastic bag, making sure that it is kept away from metallic objects (such as clips) when carrying or storing it.
- To remove the battery, turn the camera off and wait until the LUMIX indicator on the monitor goes off. (Failure to wait may cause the camera to malfunction and may damage the card or recorded data.)

Guidelines for number of recordable pictures and operating time

Recording still pictures (When using monitor)

Number of recordable pictures	Approx. 350 pictures (Approx. 300 pictures)	By CIPA standard
Recording time	Approx. 175 min (Approx. 150 min)	

Recording still pictures (When using viewfinder (LVF))

Number of recordable pictures	Approx. 320 pictures (Approx. 270 pictures)	By CIPA standard
Recording time	Approx. 160 min (Approx. 135 min)	

- The values when the flash (supplied) is used are provided in parentheses.

Recording conditions by CIPA standard

CIPA is an abbreviation of "Camera & Imaging Products Association".

- [Program AE] Mode
- Temperature: 23 °C (73.4 °F)/Humidity: 50%RH when monitor is on.
- Using a Panasonic SDHC Memory Card.
- Using the supplied battery.
- Starting recording 30 seconds after the camera is turned on (when [Stabilizer] is set to [OFF]).
- Recording once every 30 seconds with full flash every second recording.
- Rotating the zoom lever from Tele to Wide or vice versa in every recording.
- Turning the camera off every 10 recordings and leaving it until the temperature of the battery decreases.

Number reduced if intervals are longer (e.g. to approx. one quarter for 2-minute intervals under the above conditions).

Recording motion pictures (When using monitor)

[Rec Format]	[AVCHD]	[MP4]	[MP4]
[Rec Quality]	[FHD/17M/50i]	[FHD/20M/25p]	[4K/100M/25p]
Available recording time	Approx. 125 min	Approx. 135 min	Approx. 90 min
Actual available recording time*	Approx. 60 min	Approx. 65 min	Approx. 45 min

* The time you can actually record when repeatedly turning the camera on and off, starting and stopping recording and using zoom.

■ Recording conditions

- Temperature 23 °C (73.4 °F), humidity 50%RH
- [AVCHD] motion pictures:
Recording stops when the continuous recording time exceeds 29 minutes and 59 seconds.
- Motion pictures with their file size set to [FHD], [HD] or [VGA] in [MP4]:
Recording stops when the continuous recording time exceeds 29 minutes and 59 seconds or the file size exceeds 4 GB.
 - Since the file size becomes larger with [FHD], recording with [FHD] will stop before 29 minutes 59 seconds.
- Motion pictures with their file size set to [4K] in [MP4]:
Recording stops when the continuous recording time exceeds 15 minutes. (You can continue recording without interruption even if the file exceeds 4 GB, but the motion picture file will be recorded and played back in separate files.)

Viewing pictures (When using monitor)

Playback time	Approx. 260 min
---------------	-----------------

- **The operating times and number of recordable pictures will differ according to the environment and the operating conditions.**
For example, in the following cases, the operating times shorten and the number of recordable pictures is reduced.
 - In low-temperature environments, such as on ski slopes.
 - When operations such as the flash and zoom are used repeatedly.
- If available battery power is significantly reduced, battery is reaching end of lifespan. Please purchase a new battery.

Inserting and removing the battery/the card (optional)

- Make sure that the camera is turned off.

1 Slide the release lever to the [OPEN] position and open the card/battery door

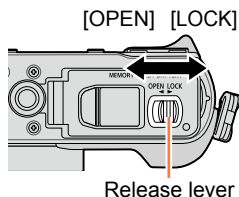

2 Insert the battery and card, making sure that their orientation is correct

• **Battery:**

Insert the battery all the way firmly until a locking sound is heard, and check that the lever is hooked over the battery.

• **Card:**

Insert the card all the way firmly until it clicks.

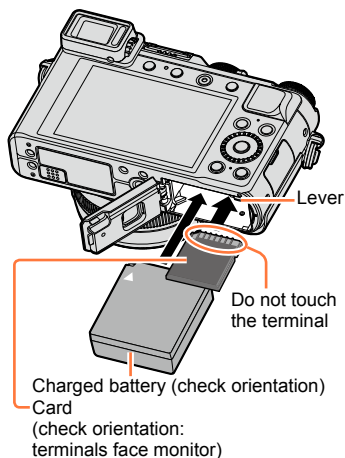

3 Close the card/battery door and slide the release lever to the [LOCK] position

■ **To remove**

• **To remove battery:**

Move lever in direction of arrow.

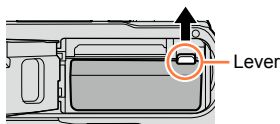

• **To remove card:**

Press the centre of the card.

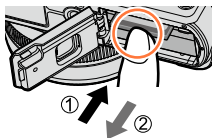

- Remove battery from camera after use.
- Keep the Memory Card out of reach of children to prevent swallowing.
- To remove the card or battery, turn the camera off and wait until the LUMIX indicator on the monitor turns off. (Failure to wait may cause the camera to malfunction and may damage the card or recorded data.)

About the Card

The following SD standard-based cards (Panasonic brand recommended) can be used.

Type of Card	Capacity	Notes
SD Memory Cards	8 MB – 2 GB	<ul style="list-style-type: none"> • Can be used with devices compatible with the respective formats. • Before using SDXC Memory Cards, check that your computer and other devices support this type of card. http://panasonic.net/avc/sdcard/information/SDXC.html • This unit is compatible with UHS-I UHS Speed Class 3 standard SDHC/SDXC memory cards. • Only the cards listed on the left with the given capacities are supported.
SDHC Memory Cards	4 GB – 32 GB	
SDXC Memory Cards	48 GB, 64 GB	

■ About the motion picture recording and speed class

According to the [Rec Format] (→187) and [Rec Quality] (→187) of a motion picture, the required card differs. Use a card that meets the following ratings of the SD Speed Class or UHS Speed Class.

- SD Speed Class and UHS Speed Class are the speed standards regarding continuous writing. Confirm the SD speed by checking the card label or other card related materials.

[Rec Format]	[Rec Quality]	Speed class	Label example
[AVCHD]	All	Class 4 or higher	CLASS 4 4
[MP4]	FHD/HD/VGA		
[MP4]	4K	UHS Speed Class 3	U3

- Latest information:
<http://panasonic.jp/support/global/cs/dsc/>
(This site is available in English only.)

Access to the card

The access indication displays red when pictures are being recorded on the card.



- While the camera is accessing the card (for an operation such as picture writing, reading, deletion, or formatting), do not turn off the camera or remove the battery, card, AC adaptor (optional) or DC coupler (optional). Do not subject the camera to vibrations, impact, or static electricity. The card or the data on the card may be damaged, and this unit may no longer operate normally. If operation fails due to vibration, impact or static electricity, perform the operation again.

- If you set the write-protect switch to “LOCK”, you may not be able to write, delete or format the data or display it by recording date. These operations become available again when you unlock the switch.
- It is recommended that you copy important pictures to your computer (as electromagnetic waves, static electricity, or faults may cause data to be damaged).



Formatting the card (initialisation)

Format the card before recording a picture with this unit. **Since data cannot be recovered after formatting, make sure to back up necessary data in advance.**

1 Set the menu

MENU →  **[Setup]** → **[Format]**



- A confirmation screen is displayed. If you select [Yes], the operation is executed.
- This requires a sufficiently charged battery, or an AC adaptor (optional) and DC coupler (optional).
- Do not turn off the camera or perform other operations during formatting.
- Always format cards with this camera. Please reformat the card with this camera if it has already been formatted with a computer or another device.
- If the card cannot be formatted, please try another card before contacting Panasonic.

Recording capacity guidelines (pictures/recording time)

The number of pictures you can take and the recording time vary in proportion to card capacity (and depending on recording conditions and type of card).

Recording picture capacity (still pictures)

When aspect ratio is set to [4:3] and [Quality] is set to [ⓘ]

[Picture Size]	8 GB	16 GB	32 GB	64 GB
L (12.5M)	1090	2200	4420	8820
 M (6.5M)	1880	3810	7630	14970
 S (3M)	3220	6500	13030	24700

When aspect ratio is set to [4:3] and [Quality] is set to [RAW ⓘ]

[Picture Size]	8 GB	16 GB	32 GB	64 GB
L (12.5M)	340	700	1400	2800
M (6.5M)	400	810	1620	3230
S (3M)	440	890	1780	3530

- When the number of recordable pictures exceeds 9,999, “9999+” is displayed.

Recording time capacity (motion pictures)

- The recordable time is the total time of all the motion pictures which have been recorded.

([h], [m] and [s] indicate “hour”, “minute” and “second”).

When [Rec Format] is [AVCHD]

[Rec Quality]	8 GB	16 GB	32 GB	64 GB
[FHD/28M/50p]	37m00s	1h15m00s	2h30m00s	5h00m00s
[FHD/17M/50i]	1h00m00s	2h00m00s	4h05m00s	8h15m00s
[FHD/24M/25p]	43m00s	1h25m00s	2h55m00s	5h50m00s
[FHD/24M/24p]	43m00s	1h25m00s	2h55m00s	5h50m00s

When [Rec Format] is [MP4]

[Rec Quality]	8 GB	16 GB	32 GB	64 GB
[4K/100M/25p]	9m00s	20m00s	42m00s	1h20m00s
[4K/100M/24p]	9m00s	20m00s	42m00s	1h20m00s
[FHD/28M/50p]	37m00s	1h15m00s	2h30m00s	5h00m00s
[FHD/20M/25p]	49m00s	1h40m00s	3h20m00s	6h40m00s
[HD/10M/25p]	1h30m00s	3h10m00s	6h25m00s	12h50m00s
[VGA/4M/25p]	3h25m00s	7h00m00s	14h10m00s	28h15m00s

- If the surrounding temperature is high, or a motion picture is recorded continuously, [] is displayed and recording may be stopped halfway through to protect the camera.
- [AVCHD] motion pictures:
Recording stops when the continuous recording time exceeds 29 minutes and 59 seconds.
- Motion pictures with their file size set to [FHD], [HD] or [VGA] in [MP4]:
Recording stops when the continuous recording time exceeds 29 minutes and 59 seconds or the file size exceeds 4 GB.
 - Since the file size becomes larger with [FHD], recording with [FHD] will stop before 29 minutes 59 seconds.
- Motion pictures with their file size set to [4K] in [MP4]:
Recording stops when the continuous recording time exceeds 15 minutes. (You can continue recording without interruption even if the file exceeds 4 GB, but the motion picture file will be recorded and played back in separate files.)
- **The maximum available continuous recording time is displayed on the screen.**



Switching the display between the number of recordable pictures that you can take and the available recording time

MENU →  [Custom] → [Remaining Disp.]

[] (Remaining shots):

Displays the number of pictures that can be recorded.

[] (Remaining time):

Displays the remaining recording time.

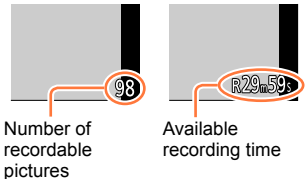

Setting the clock

The clock is not set when the camera is shipped.

1 Turn the camera on

- If the language select screen is not displayed, proceed to step 4.

2 Press [MENU/SET] while the message is displayed

3 Press ▲ ▼ to select the language, and press [MENU/SET]

- The [Please set the clock] message appears.

4 Press [MENU/SET]

5 Press ◀ ▶ to select the items (year, month, day, hour, minute), and press ▲ ▼ to set

- To cancel → Press [⏪/⏩] button.

To set the display order or time display format

- Select [Style] and press [MENU/SET] to display the setting screen for display order and time display format.

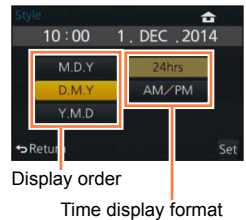
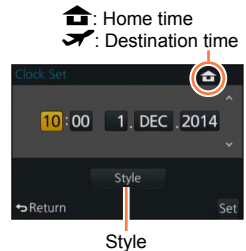
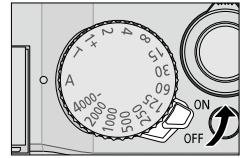

6 Press [MENU/SET]

- A confirmation screen is displayed. Press [MENU/SET].

7 When [Please set the home area] is displayed, press [MENU/SET]

Setting the clock

- 8** Press ◀▶ to set your home area and press [MENU/SET]



- If the clock is not set, the correct date cannot be printed when you order a photo studio to print the picture, or when you stamp the date on the pictures with [Text Stamp].

Changing time settings

Select [Clock Set] from the [Setup] menu to change the current time settings.

- Clock settings will be saved for approx. 3 months even after the battery is removed, provided a fully charged battery was installed in the camera for 24 hours beforehand.

1 Select [Clock Set] from the [Setup] menu

- For details about how to set the menu (→31)

2 Set the date and time (Perform steps 5 - 6. (→29))

Setting the menu

You can use the menu to set camera and recording functions, operate playback functions, and perform other operations. In particular, the [Setup] menu contains some important settings relating to the camera's clock and power. Check the settings of this menu before proceeding to use the camera.



- When [Menu Resume] (→49) in the [Setup] menu is set to [ON], the screen displayed last after you selected the menu item will reappear. It is set to [ON] at the time of purchase.
- When the [Menu Information] (→49) in the [Setup] menu is set to [ON], descriptions of the menu items and settings will appear on the menu screen.

Example: To change the [Quality] setting from [3:3] to [1:1] in the [Rec] menu

In this Operating Instructions, steps for setting a menu item are described as follows:

MENU → [Rec] → [Quality] → [1:1]

1 Press [MENU/SET] to bring up the menu

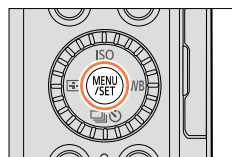

[Rec] (→303 -)	You can perform settings for picture size and the flash.
[Motion Picture] (→305)	You can select the recording format and picture quality and other settings.
[Custom] (→306 -)	Operation of the unit, such as displaying of the screen and button operations, can be set up according to your preferences. Also, it is possible to register the modified settings.
[Setup] (→308)	You can perform settings that make usage more convenient, such as the changing the clock settings and beep volume. You can also perform Wi-Fi function-related settings.
[Playback] (→309)	You can specify picture protection, cropping, print settings, and other settings for pictures you have taken.

Setting the menu

2 Press ▲▼ to select the menu item and press [MENU/SET]

- Items can also be selected by turning the control dial.
- You can also switch to the next page by pressing [DISP.] button or rotating the zoom lever.

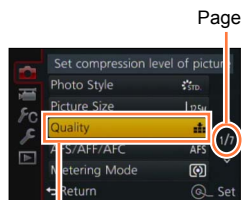

Item

3 Press ▲▼ to select the setting and press [MENU/SET]

- Items can also be selected by turning the control dial.

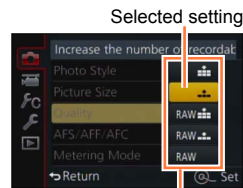

Settings

4 Press the [DISP./ZOOM] button repeatedly until the recording or playback screen reappears

- During recording, the menu screen can also be exited by pressing the shutter button halfway.

Switching menu type

Example: Switching to the [Setup] menu from [Rec] menu

1 Press ◀

2 Press ▲ ▼ to select a menu switch icon [🔧]

- Items can also be selected by turning the control dial.

3 Press [MENU/SET]

- Select the menu item and perform the setting.



Menu type

- The menu types and items that are displayed vary according to the mode.
- The setting methods vary depending on the menu item.

Setting the menu screen background

You can set the background for the menu screen according to your preferences.

1 Set the menu

MENU → 🔧 [Setup] → [Menu Background]

2 Press ▲ ▼ to select the background colour and then press [MENU/SET]

- Exit the menu after it is set.

Calling frequently-used menus instantly (Quick Menu)

You can easily call some of the menu items and set them.

- The menu items and setting items that are displayed differ depending on the recording mode and settings during recording.

- 1 Press [Q.MENU] button to display the Quick menu**
- 2 Turn the control dial to select the menu item, and press ▼ or ▲**
 - The menu item can also be selected by pressing ◀▶.
- 3 Turn the control dial to select the setting**
 - The setting can also be selected with ◀▶.
- 4 Press [Q.MENU] button to close the Quick menu**

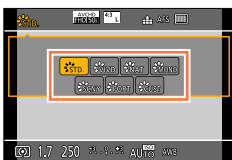
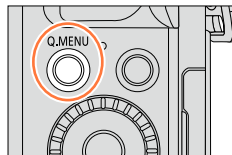

Switching the method for setting Quick Menu items

MENU → **ƒC [Custom]** → **[Q.MENU]**

[PRESET]: The default items can be set.

[CUSTOM]: The Quick Menu will consist of desired items. (→35)

Using the Quick menu on the monitor recording information screen (→62) of  (monitor style)

(Press the [DISP.] button repeatedly until the screen appears.)

Press the [Q.MENU] button and turn the control dial to select an item, and press [MENU/SET].

Turn the control dial to select the setting and press [MENU/SET] to set.

- You can also set with ▲▼◀▶ and [MENU/SET].

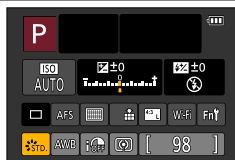

Calling frequently-used menus instantly (Quick Menu)

Change the Quick Menu to your preferred item

When [Q.MENU] (→34) in the [Custom] menu is set to [CUSTOM], the Quick Menu can be changed as desired. Up to 15 items can be set to the Quick Menu.

1 Press ▼ to select [Q.M] and press [MENU/SET]

2 Press ▲▼◀▶ to select the menu item in the top row and press [MENU/SET]

3 Press ◀▶ to select the empty space in the bottom row and then press [MENU/SET]

- If there is no empty space in the bottom row, you can replace an existing item with a new select item by selecting the existing item.
- To cancel the setting, move to the bottom row by pressing ▼ and select an item to cancel, and then press [MENU/SET].
- Items that can be set are as follows:



Items that can be setup as Quick Menus

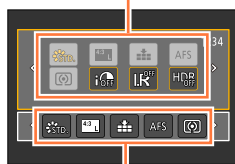

Items that can be displayed in the Quick Menu screen

[Rec] menu/Recording functions

- | | |
|--------------------------|--------------------------|
| • [Photo Style] (→100) | • [Flash Mode] (→180) |
| • [Picture Size] (→108) | • [Flash Adjust.] (→183) |
| • [Quality] (→109) | • [i.Zoom] (→172) |
| • [AFS/AFF/AFC] (→114) | • [Digital Zoom] (→173) |
| • [Metering Mode] (→139) | • [Stabilizer] (→168) |
| • [i.Dynamic] (→111) | • [Sensitivity] (→136) |
| • [i.Resolution] (→111) | • [White Balance] (→103) |
| • [HDR] (→112) | • [AF Mode] (→115) |
| • [Shutter Type] (→140) | • [Drive Mode] (→141) |

[Motion Picture] menu

- | | |
|----------------------------|-------------------------|
| • [4K PHOTO] (→195) | • [Picture Mode] (→198) |
| • [Motion Pic. Set] (→187) | |

Calling frequently-used menus instantly (Quick Menu)

[Custom] menu	
• [Silent Mode] (→161)	• [Zebra Pattern] (→166)
• [Peaking] (→130)	• [Monochrome Live View] (→167)
• [Histogram] (→64)	• [Rec Area] (→192)
• [Guide Line] (→65)	• [Zoom lever] (→175)

4 Press [] button

- It will return to screen of step **1** (→35). Press [MENU/SET] to switch to the recording screen.

Assigning frequently used functions to the buttons

(Function buttons)

You can assign frequently-used functions to particular buttons.

1 Set the menu

MENU → **fC** [Custom] → [Fn Button Set]

2 Press ▲ ▼ to select the function button you want to assign a function to and press [MENU/SET]

3 Press ▲ ▼ to select the function you want to assign and press [MENU/SET]

- For details on the functions that can be assigned, refer to (→38).
- To restore the default function button settings, select [Restore to Default].

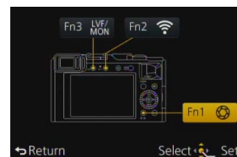

Assigning frequently used functions to the buttons (Function buttons)

Assigning a function to a function button

Press the function button to use the assigned function.

- You can assign the following functions to the [Fn1], [Fn2], and [Fn3] buttons.

[Rec] menu/Recording functions		
<ul style="list-style-type: none"> [Wi-Fi] (→225): [Fn2]* [LVF/Monitor Switch] (→55): [Fn3]* [AF/AE Lock] (→133) [AF-ON] (→129, 133) [Preview] (→88): [Fn1]* [Level Gauge] (→66) [Focus Area Set] [Cursor Button Lock] [Photo Style] (→100) 	<ul style="list-style-type: none"> [Picture Size] (→108) [Quality] (→109) [AFS/AFF/AFC] (→114) [Metering Mode] (→139) [Highlight Shadow] (→102) [i.Dynamic] (→111) [i.Resolution] (→111) [HDR] (→112) [Shutter Type] (→140) [Flash Mode] (→180) 	<ul style="list-style-type: none"> [Flash Adjust.] (→183) [i.Zoom] (→172) [Digital Zoom] (→173) [Stabilizer] (→168) [Sensitivity] (→136) [White Balance] (→103) [AF Mode/MF] (→115) [Drive Mode] (→141) [Restore to Default]

[Motion Picture] menu	
<ul style="list-style-type: none"> [4K PHOTO] (→195) [Motion Pic. Set] (→187) 	<ul style="list-style-type: none"> [Picture Mode] (→198)

[Custom] menu		
<ul style="list-style-type: none"> [Utilize Custom Set feature] (→60) [Silent Mode] (→161) [Peaking] (→130) [Histogram] (→64) 	<ul style="list-style-type: none"> [Guide Line] (→65) [Zebra Pattern] (→166) [Monochrome Live View] (→167) 	<ul style="list-style-type: none"> [Rec Area] (→192) [Zoom lever] (→175)

* Function button settings at the time of purchase.

- Certain functions cannot be assigned to some function buttons.

- The function assigned to the function button may not work in some modes or on some display screens.
- When [Focus Area Set] is assigned to the function button, you can display the AF area or the MF Assist position setting screen.
- When the cursor button is locked, operation of the cursor button, [MENU/SET] button, and control dial is disabled. To enable operation, press the function button again.



Not available in the following cases:



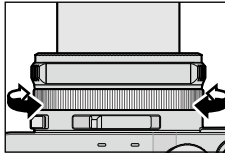

- The function assigned to the [Fn1] button will not work in the following cases:
 - When the picture effect (Filter) is set ([Miniature Effect], [One Point Color], [Sunshine])
 - When [Multi Exp.] is set
- The function assigned to the [Fn2] button will not work in the following case:
 - When using [Time Lapse Shot]
 - When recording 4K motion pictures after setting [4K PHOTO] to [ON]

Changing settings using the control ring

The “Control Ring” is an easy and convenient way to adjust several settings, depending on the camera mode selected. You can use the control ring to change the settings of the unit.



Items that can be set by the control ring vary depending on recording modes. Following are the pre-assigned settings.

Recording mode	Setting
iA [Intelligent Auto] Mode	 Step Zoom (→174)
P [Program AE] Mode	 Step Zoom (→174)
A [Aperture-Priority] Mode	 Step Zoom (→174)
S [Shutter-Priority] Mode	 Shutter speed adjustment* (→84)
M [Manual Exposure] Mode	 Shutter speed adjustment* (→86)

* You can use the control ring to change the following settings values, which cannot be set using the shutter speed dial.

- Higher speed than 1/4000 seconds (electronic shutter ([→140](#)))
- Slower speed than 1 second (mechanical shutter ([→140](#)))
- Setting in 1/3 EV steps

- The control ring is assigned to selecting the picture effect (Filter) when you are recording a panorama picture. ([→150](#))
- When Manual Focus is set, focus adjustment is assigned to the control ring. ([→128](#))
- The control ring can be used to change to your preferred settings. ([→40](#))

Changing the settings assigned to the control ring

Changes the settings assigned to the control ring.

1 Set the menu

MENU → **fC [Custom]** → **[Control Ring]**

2 Use ▲ ▼ to select the setting and press [MENU/SET]

Settings that can be assigned
[DEFLT] [Normal]
Q [Zoom] (→170)
Q. [Step Zoom] (→174)
ISO [Sensitivity] (→136)
WB [White Balance] (→103)
Ⓕ [Filter Select] (→89)
[OFF] [Not Set]

- To return to the default setting, select [Normal]. (→39)
- If you do not use the control ring, select [OFF] ([Not Set]).

- The assigned function setting applies to all the Recording Modes. The function assigned to the control ring may not work in some combinations of Recording Mode or settings used for recording (panorama picture recording, Filter setting, etc.)
- When Manual Focus is set, the control ring is fixed to the function for adjusting the focus. You cannot use the settings assigned using the [Control Ring]. (→128)

Using the [Setup] menu

[Clock Set] and [Sleep Mode] are important for clock setting and battery life. Please check these before use.

For details on how to select the [Setup] menu settings, refer to (→31)

[Clock Set]

Set time, date, and display format. (→30)

[World Time]

Set the recording date and time with the local time at your destination.

- Set [Home] when you use the camera for the first time after purchasing it. You can set [Destination] after setting [Home].

Settings: [Destination] / [Home]

1 Use ▲ ▼ to select [Destination] or [Home] and press [MENU/SET]

2 Use ◀ ▶ to select area and press [MENU/SET]



■ To set summer time

Press ▲ in step **2**. (Press again to release the setting)

- When summer time (☀) is set, the current time is advanced by 1 hour. If the setting is cancelled, the time automatically returns to the current time.

■ When you come back from your travel destination

Select [Home] in step **1** and press [MENU/SET].

- If you cannot find your destination in the area displayed on the screen, set based on difference with home time.

For details on how to select the [Setup] menu settings, refer to (→31)

[Travel Date]

If you set your travel schedule and record pictures, the day of your trip on which the picture was taken will be recorded.

■ [Travel Setup]

Settings: [SET] / [OFF]

- 1 Use ▲ ▼ to select [Travel Setup] and press [MENU/SET]
- 2 Use ▲ ▼ to select [SET] and press [MENU/SET]
- 3 Use ▲ ▼ ◀ ▶ to select the departure date and press [MENU/SET]
- 4 Use ▲ ▼ ◀ ▶ to select the return date and press [MENU/SET]

■ To record [Location]

Once the [Travel Setup] is set, you can set the location.

- ① Select [Location] in step 1 above, and press [MENU/SET]
- ② Use ▲ ▼ to select [SET] and press [MENU/SET]
- ③ Enter your location (Entering text (→52))

- To print [Location] or the number of days that have passed, either use [Text Stamp] or print using the "PHOTOfunSTUDIO" software on the supplied DVD.
- The travel date is calculated from the set departure date and the date set in the camera's clock. When destination is set in [World Time], days elapsed are calculated based on local destination time.
- When [Travel Setup] is set to [OFF], the number of days elapsed is not recorded. It is not displayed even if [Travel Setup] is set to [SET] after recording.
- When the current date passes the return date, [Travel Setup] is automatically cancelled.
- [Travel Date] cannot be recorded for AVCHD motion pictures.
- [Location] is not recorded when you record motion pictures.

[Wi-Fi]

Settings: [Wi-Fi Function] / [Wi-Fi Setup]

Configure the settings required for the Wi-Fi function. (→227, 272)

For details on how to select the [Setup] menu settings, refer to (→31)

[Beep]

Sets the beep sounds or shutter sounds.

■ [Beep Volume]

Settings: (High) / (Low) / (Off)

■ [Shutter Vol.]

Settings: (High) / (Low) / (Off)

■ [Shutter Tone]

Settings: ① / ② / ③

- When [Silent Mode] is set to [ON], [Beep Volume] and [Shutter Vol.] are set to “Off”.

[Live View Mode]

Sets the display speed and picture quality of the screen (Live View screen) when recording pictures.

Settings

[30fps]	Picture quality has higher priority over display speed and pictures are displayed at 30 fps. For example, use when you want to record a comparatively slow-moving subject while confirming the focusing. Minimises power consumption and the operating time is extended.
[60fps]	Display speed has higher priority over picture quality and pictures are displayed at 60 fps. The displayed pictures will appear slightly grainy. For example, use when you want to record a fast-moving subject.

- The [Live View Mode] setting does not affect the recorded picture.
- The display speed may slow down in dark locations.
- When the viewfinder is used, [Live View Mode] is fixed to [60fps].
- When the AC adaptor (optional) is used, [Live View Mode] is fixed to [60fps].





For details on how to select the [Setup] menu settings, refer to (→31)

[Monitor Display] / [Viewfinder]

Adjust brightness and colour of the monitor or viewfinder. It is suggested to use the default settings.

These are intended to provide a preview of the actual picture, as accurately as possible.

Settings

 [Brightness]	Adjusts the brightness.
 [Contrast]	Adjusts the contrast.
 [Saturation]	Adjusts the vividness of colours.
 [Red Tint]	Adjusts red hues.
 [Blue Tint]	Adjusts blue hues.

1 Press ▲ ▼ to select the setting item and press ◀ ▶ to make adjustments

- You can also make adjustments with the control dial.

2 Press [MENU/SET]





- It will adjust the monitor when the monitor is in use, and the viewfinder when the viewfinder is in use.
- Some subjects may look different from their actual appearance, but the recorded picture will not be affected.





For details on how to select the [Setup] menu settings, refer to (→31)

[Monitor Luminance]

Sets the monitor brightness according to the ambient light level.

Settings

	The brightness is adjusted automatically depending on how bright it is around the camera.
	The brightness is increased.
	The brightness is standard.
	The brightness is decreased.

- Because the picture shown on the monitor screen emphasises brightness, some subjects may look different than their actual appearance, but this will not affect the recorded picture.
- [] returns to ordinary brightness if there is no operation for 30 seconds when recording. (Press any button to make the screen brighter again.)
- Setting [] or [] reduces the operating time.
- Cannot select [] during playback.
- When the AC adaptor (optional) is used, the initial setting is [].

For details on how to select the [Setup] menu settings, refer to (→31)

[Sleep Mode]

The camera automatically turns off if no operation is performed for a preset period of time.

- To restore → Press the shutter button halfway, or turn on the power again.

Settings: [10MIN.] / [5MIN.] / [2MIN.] / [1MIN.] / [OFF]



Not available in the following cases:



- During motion picture recording/playback
- When [Multi Exp.] is set
- When connected to computer/printer
- During Slide Shows
- When using [Time Lapse Shot]
- When using [Stop Motion Animation] (only available with [Auto Shooting] setting)
- When using the AC adaptor (optional) and DC coupler (optional)

For details on how to select the [Setup] menu settings, refer to (→31)

[USB Mode]

Select communication method for when connecting camera to a computer or printer with USB connection cable (supplied).

Settings

 [Select on connection]	Select communication method each time you connect to a computer or PictBridge-compatible printer.
 [PictBridge(PTP)]	Select when connecting to a PictBridge-compatible printer.
 [PC]	Select when connecting to a computer.

[TV Connection]

Change the settings to be used when the camera is connected to a TV or other device.

■ [Video Out]

This setting performs when the AV cable (optional) or HDMI micro cable is connected.

Settings

[NTSC]	Video output is set to NTSC system.
[PAL]	Video output is set to PAL system.

■ [TV Aspect]

This setting performs when an AV cable (optional) is connected.

Settings: [16:9] / [4:3]

For details on how to select the [Setup] menu settings, refer to (→31)

[TV Connection] (continued)

■ [HDMI Mode]

Set the format for the HDMI output when playing back on the HDMI compatible high-definition TV connected with this unit using the HDMI micro cable.

Settings

[AUTO]	Automatically sets the output resolution based on information from a connected TV.
[4K]	Outputs pictures with a resolution of 3840×2160 pixels using a progressive scan method for the number of effective scanning lines (2,160 lines).
[1080p]	Outputs pictures using a progressive scan method for the number of effective scanning lines (1,080 lines).
[1080i]	Outputs pictures using an interlace scan method for the number of effective scanning lines (1,080 lines).
[720p]	Outputs pictures using a progressive scan method for the number of effective scanning lines (720 lines).
[576p]*1/[480p]*2	Outputs pictures using a progressive scan method for the number of effective scanning lines (576*1/480*2 lines).

*1 When [Video Out] is set to [PAL]

*2 When [Video Out] is set to [NTSC]

- This will work when the HDMI micro cable is connected.
- If no image appears on the TV with [AUTO], switch the setting to a constant setting other than [AUTO] to set a format supported by your TV. (Please read the operating instructions for the TV.)

For details on how to select the [Setup] menu settings, refer to (→31)

[TV Connection] (continued)

■ [VIERA Link]

Enable automatic linking with other VIERA Link-compatible devices, and operability with a VIERA remote control when connecting via an HDMI micro cable. (→278)

Settings

[ON]	Operations may be performed via the remote control of the VIERA Link-compatible device. <ul style="list-style-type: none"> • Not all operations will be available. • Operability of the camera's own buttons will be limited.
[OFF]	Operations must be performed via the camera's own buttons.

- This will work when the HDMI micro cable is connected.

[Menu Resume]

Save the last operated menu position.

Settings: [ON] / [OFF]

[Menu Background]

Set the background colour for the menu screen. (→33)

[Menu Information]

Explanations of the menu items and settings are displayed on the menu screen.

Settings: [ON] / [OFF]

[Language]

Change display language.

Set the language displayed on the screen.

For details on how to select the [Setup] menu settings, refer to (→31)

[Version Disp.]

Check the firmware version of the camera or supplied flash (when the flash is attached).

- When you press [MENU/SET] while the version is displayed, software information for this unit, such as the licence, is displayed.

[Self Timer Auto Off]

The self-timer is cancelled if the unit is turned off.

Settings: [ON] / [OFF]

[No.Reset]

Reset picture file numbers. (The folder number is updated and the file number starts from 0001.)

- To reset folder number to 100:
First, format the card, and reset the file numbers using [No.Reset]. Then, select [Yes] on the folder number reset screen.

- A folder number between 100 and 999 can be assigned.
Numbers cannot be reset once folder number reaches 999. In this case, save all necessary pictures to your computer, and format the card (→26).

[Reset]

Reset to the default settings.

■ [Reset Rec. settings?]

■ [Reset setup/custom settings?]

- Information registered in [Face Recog.] is reset if recording settings are reset.
- When the setup/custom settings are reset, the following settings are also reset:
 - The [Profile Setup] setting
 - The settings of [Rotate Disp.], [Picture Sort], [Delete Confirmation] in the [Playback] menu
- Folder numbers and clock settings will not be reset.

For details on how to select the [Setup] menu settings, refer to (→31)

[Reset Wi-Fi Settings]

Returns [Wi-Fi] settings to default settings.

- If you want to dispose or give away your camera, always reset it to prevent your personal information from being mistakenly used.
- When you request your camera to be fixed, backup your personal information and always reset it as well.

[Format]

Format (initialise) a memory card. (→26)

Entering Text

Use the cursor button to enter names with the Face Recognition function and in [Profile Setup] (babies and pets), or to register locations in [Travel Date] etc.

- Only alphabetical characters and symbols can be entered.
- Example of operation for displaying a screen:

MENU → [Rec] → [Profile Setup] → [SET] → [Baby1] → [Name] → [SET]

1 Use ▲▼◀▶ to select characters

2 Press [MENU/SET] several times until the desired character is displayed

Cursor position

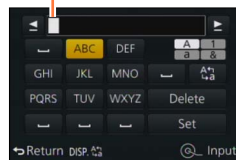

Text is inserted at the cursor position.

- []: Enter a blank.

■ To change the character type

- Press [DISP.] button
- Use ▲▼◀▶ to select [] and press [MENU/SET]

■ To continue entering characters

- Use ▲▼◀▶ to select [] and press [MENU/SET]
- Move the zoom lever toward T side
- Turn the control dial to the right

■ Editing text

- ① Use ▲▼◀▶ to select [] [] and press [MENU/SET]. Then, move the cursor to the text to edit
 - You can also use the zoom lever or control dial to reposition the cursor.
- ② Use ▲▼◀▶ to select [Delete] and press [MENU/SET]
- ③ Use ▲▼◀▶ to select the correct text, and then press [MENU/SET]

3 When you are finished entering text, use ▲▼◀▶ to select [Set] and press [MENU/SET]

- A maximum of 30 characters can be entered (maximum of 9 characters when setting names in [Face Recog.]).
- A maximum of 15 characters can be entered for [\], [], [], [•] and [—] (maximum of 6 characters when setting names in [Face Recog.]).

Holding the camera

- To avoid camera shake, hold it with both hands keeping your arms close to your body while standing with your feet slightly apart.
- Do not touch the lens.
- Do not block the microphone when recording motion pictures.
- Do not block the AF Assist Lamp, or the flash when you take a picture using it. Do not look at it from close range.
- Make sure that the camera does not move at the moment the shutter button is pressed.
- **We recommend using the supplied shoulder strap to avoid dropping the camera.**

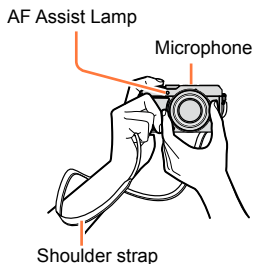

About the direction detect function

Still pictures recorded with the camera held vertically can be automatically displayed in portrait orientation during playback. (Only when [Rotate Disp.] is set to [ON].)

- The direction detect function may not operate correctly if pictures are taken with the camera pointing up or down.
- Motion pictures cannot be displayed in portrait orientation.

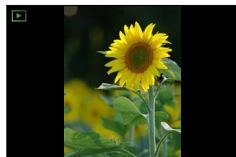

Recording pictures using the viewfinder

When you use the viewfinder, you can check the view of the subject even if you are in a bright area.

Switching between the monitor and viewfinder

You can operate the [LVF]/[Fn3] button in two ways, using it either as the [LVF] button or as a function button [Fn3]. You can use this button as the [LVF] button at the time of purchase.

- For details on the function button, refer to (→37).

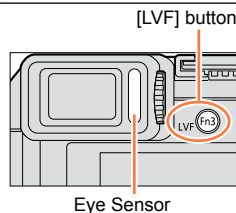

1 Press [LVF] button

- The display is switched as shown below.

**Automatic switching
between viewfinder and
monitor**

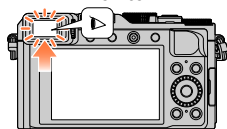

Viewfinder display

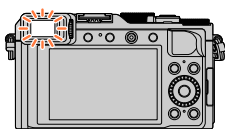

Monitor display

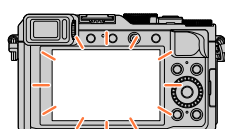

Automatic switching between viewfinder and monitor

For automatic switching between the viewfinder and monitor, the eye sensor automatically switches the display to viewfinder when your eye or an object moves close to the viewfinder.

- The eye sensor may not work correctly depending on the shape of your eyeglasses, the way you hold the camera, or whether the eyepiece and nearby area are exposed to strong light. In this case, press the [LVF] button to switch the display.
- During motion picture playback or Slide Show, the eye sensor will not automatically switch the display to the viewfinder.
- The sensitivity of the eye sensor can be set using [Eye Sensor] in the [Custom] menu. (→55)



Setting the sensitivity of the eye sensor or setting to switch the display between the viewfinder and monitor

MENU → **ƒC** [Custom] → [Eye Sensor]

[Sensitivity]	Use this setting to set the sensitivity of the eye sensor. [HIGH] / [LOW]
[LVF/Monitor Switch]	Use this setting to switch the display between the viewfinder and monitor. [LVF/MON AUTO] (Automatic switching between viewfinder and monitor) / [LVF] (Viewfinder display) / [MON] (Monitor display) • After the display is switched using the [LVF] button, the setting of [LVF/Monitor Switch] will also change.

About diopter adjustment

Adjust the diopter to suit your vision so that you can see the viewfinder clearly.

Turn the diopter adjustment dial to adjust until you are able to clearly see the characters displayed in the viewfinder.

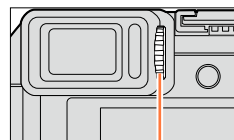

Diopter adjustment dial

About Eye Sensor AF

If the eye sensor is activated when [Eye Sensor AF] in the [Custom] menu is set to [ON], the camera automatically adjusts the focus.



- Eye Sensor AF adjusts focus only once when you look into the viewfinder. It does not continuously adjust the focus while you are looking into the viewfinder.
- Even when [Eye Sensor AF] is set and the camera automatically adjusts the focus, a beep will not sound.



Not available in the following case:

- [Eye Sensor AF] may not work when the lighting is low.

Taking pictures



- Press the  (▼) to set the drive mode to  ([Single]).

1 Select the recording mode (→59)

2 Adjust focus according to subject



Press halfway (press lightly to focus)

- The aperture value and shutter speed are displayed. (If the aperture value and shutter speed are shown in red and flashing, you do not have the appropriate exposure, unless you are using the flash.)
- When you take a picture in a dark location, [●_{LOW}] is displayed for the focus display and it may take longer to adjust focus than usual.
- When [AFS/AFF/AFC] in the [Rec] menu is set to [AFF] or [AFC]
 - A beep sounds only the first time the camera is focused while you press the shutter button halfway.
 - When Auto Focus mode is set to Custom Multi, such as  and , the AF area will be momentarily displayed only for the first time when the camera is focused while you press the shutter button halfway.

Focus display

(When focus is aligned:
illuminated
When focus is not aligned:
flashing)

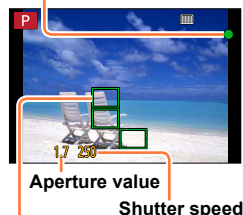

AF area

(When focus is aligned:
green)

3 Take a picture



Press fully (press the button all the way to record)

- The focus display flashes and beep sounds when focus is not aligned. Use the focus range displayed in red as a reference. Even if the focus display is lit, the camera may be unable to bring the subject into focus if it is out of range.
- The AF area display may be larger depending on recording conditions such as dark locations or zoom ratio.
- The quality of the picture display may be lower during Auto Focus.

Focus display

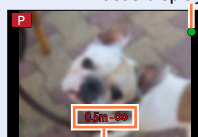

Focus range



- Subjects/environments which may make focusing difficult:
 - Fast-moving or extremely bright objects, or objects with no colour contrast.
 - Taking pictures through glass or near objects emitting light.
 - In the dark, or with significant jitter.
 - When too close to object or when taking pictures of both distant and close objects together in the same picture.



Displaying still pictures immediately after taking them

MENU → **FC** [Custom] → [Auto Review]

[Duration Time]	Set the time to display the pictures you have taken after taking still pictures. [HOLD]: Displaying pictures until you press the shutter button halfway [5SEC] / [4SEC] / [3SEC] / [2SEC] / [1SEC] / [OFF]
[Playback Operation Priority]	[ON]: During [Auto Review], you can switch the playback screen or delete pictures. [OFF]: During [Auto Review], you can perform the same button operations as when you take a picture.

- When [Duration Time] is set to [HOLD], [Playback Operation Priority] is fixed to [ON].

Recording motion pictures

You can record full high-definition quality images that comply with the AVCHD standard, as well as motion pictures recorded in MP4. You can also record a 4K motion picture in MP4. (→194)

Audio is recorded in stereo.

1 Press the motion picture button to start recording

- Immediately release the motion picture button after pressing it.
- You can record motion pictures fitting each Recording Mode (→59).
- While you are recording motion pictures, the recording status indicator (red) will flash.
- If you do not perform any operation for approximately 1 minute or longer, some of the information on the screen is turned off. To display the information again, press the [DISP.] button.
- Do not block the microphones when recording motion pictures.
- You can also use zoom while recording motion pictures.
 - The operating sounds of the zoom lever or control ring may be recorded in some cases.
- Still pictures can be taken during motion picture recording. (→198)

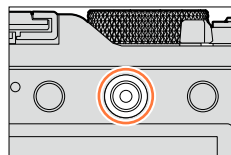

Recording state indicator

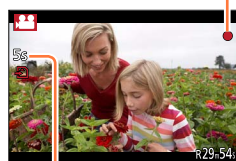

Elapsed recording time

Remaining recording time (approx.)

2 Press the motion picture button again to end recording

- For details, read “Recording motion pictures”. (→187)

Select the recording mode

To select the recording mode using the aperture ring and shutter speed dial

1 Turn the aperture ring and shutter speed dial

- Slowly turn the aperture ring and shutter speed dial until they click to properly align the position.
You can set the aperture ring to [A] (AUTO) or to values between [1.7] and [16].

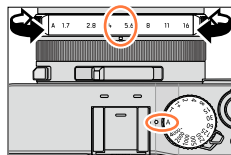

To select [Intelligent Auto] Mode

1 Press [iA] button

- [Intelligent Auto] Mode is set and the recording mode icon changes to [iA]. When you press the [iA] button again, the recording mode is switched to one that enables settings to be made using the aperture ring and shutter speed dial.
- When [Intelligent Auto] Mode is selected, the recording mode that was set using the aperture ring and shutter speed dial is cancelled.

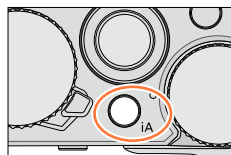

iA [Intelligent Auto] Mode (→75)

Take pictures with automatic settings.



P [Program AE] Mode (→81)

Record pictures with the aperture value and shutter speed settings automatically adjusted.

A [Aperture-Priority] Mode (→83)

Determine aperture, then record pictures.

S [Shutter-Priority] Mode (→84)

Determine shutter speed, then record pictures.

M [Manual Exposure] Mode (→86)

Determine the aperture value and shutter speed respectively, and then record pictures.

Registering a combination of settings to be used during recording (Custom Set)

You can register up to three combinations of your preferred menu settings. Selecting [Utilize Custom Set feature] from the [Custom] menu enables you to switch quickly to the settings you selected for the custom settings.

■ Registering the custom set

- ① Set your preferred menu settings such as [Rec] menu, [Motion Picture] menu, and [Custom] menu
- ② Set the menu

MENU → **fC** [Custom] → [Cust.Set Mem.]

- ③ Use **▲▼** to select custom set (C1-C3) for registration and press [MENU/SET]
 - A confirmation screen is displayed. If you select [Yes], the operation is executed.

- The following menu items are not registered as custom settings.

[Rec] menu	[Setup] menu	[Playback] menu
<ul style="list-style-type: none"> • Data registered with [Face Recog.] • The [Profile Setup] setting 	<ul style="list-style-type: none"> • All menus 	<ul style="list-style-type: none"> • [Rotate Disp.] • [Picture Sort] • [Delete Confirmation]

■ Using the custom set

- ① Set the menu

MENU → **fC** [Custom] → [Utilize Custom Set feature]

- ② Use **▲▼** to select custom set
- ③ Press [MENU/SET]
 - The settings are switched to those settings you selected for the custom set.



Using the function button to call up the custom settings

Setting the function button to [Utilize Custom Set feature] allows you to switch quickly to your preferred settings by pressing the function button.

- ① Assign [Utilize Custom Set feature] to your preferred function button using [Fn Button Set] in the [Custom] menu. (→37)
- ② Press the function button to which [Utilize Custom Set feature] is assigned. Use **◀▶** to select custom set and press [MENU/SET]



When changing the menu settings

Even if the menu settings are changed temporarily while any one of the custom settings is selected, the currently registered settings will remain unchanged.

To change the currently registered settings, overwrite the registered data using [Cust.Set Mem.] on the [Custom] menu.



Not available in the following case:

- In the [Intelligent Auto] Mode

Switching the display information on the recording screen

You can also turn off the recording information (such as icons for various settings) and the level gauge (→66).

1 Press [DISP.] button to switch the display

- You can use [Monitor Disp. Style] and [LVF Disp. Style] in the [Custom] menu to select either [Histogram] (Monitor style display layout) or [Live View] (Live View Finder style display layout) for the display screen of the monitor and viewfinder.

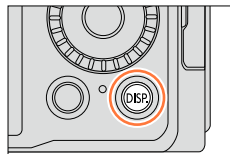

[Histogram] Monitor style display layout

- The display is switched as shown below. (Example of monitor style display)

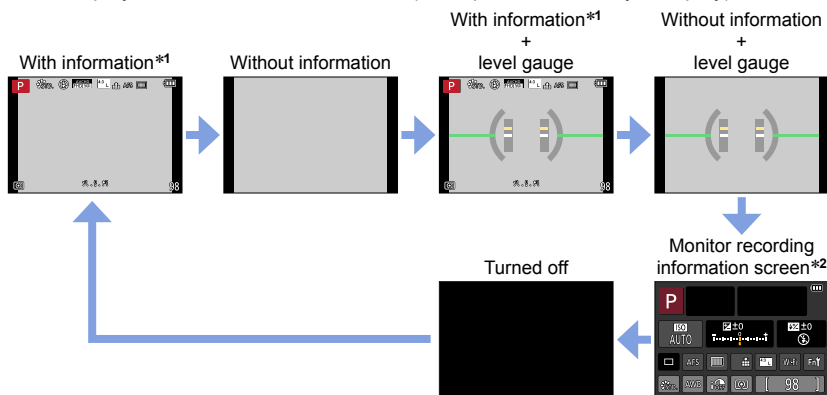

*1 When [Histogram] in the [Custom] menu is set to [ON], a histogram is displayed. (→64) When [Expo.Meter] in the [Custom] menu is set to [ON], the exposure meter is displayed. (→81)

*2 This screen is displayed only when [Monitor Info. Disp.] in the [Custom] menu is set to [ON]. (→65) While you are checking the recording information on the monitor, you can use the viewfinder to record pictures.

Switching the display information on the recording screen

■ [] Live View Finder style display layout

- The display is switched as shown below. (Example of viewfinder style display)

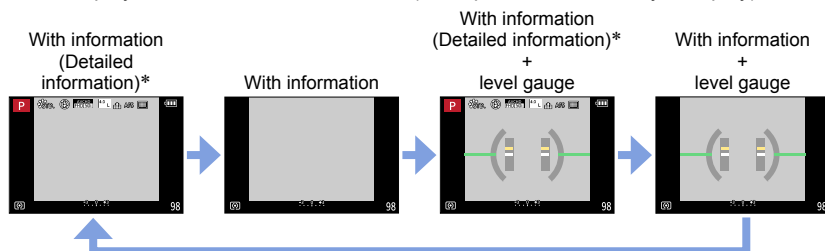



*When [Histogram] in the [Custom] menu is set to [ON], a histogram is displayed. (→64) When [Expo.Meter] in the [Custom] menu is set to [ON], the exposure meter is displayed. (→81)

- If you do not perform any operation for approximately 1 minute or longer, some of the information on the screen is turned off. To display the information again, press the [DISP.] button.

Switching the monitor display method

MENU → **FC** [Custom] → [Monitor Disp. Style]

: Live View Finder style display layout

: Monitor style display layout

Switching the viewfinder display method

MENU → **FC** [Custom] → [LVF Disp.Style]

: Live View Finder style display layout

: Monitor style display layout

Switching the display information on the recording screen

Enabling/disabling the histogram display

MENU → **fC** [Custom] → [Histogram] → [ON] / [OFF]

Use ▲ ▼ ◀ ▶ to set the position.

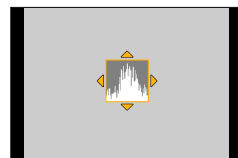

(Example)

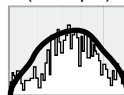

Dark ← OK → Bright

- When the histogram is not the same as that of the recorded picture under the following conditions, histogram will be displayed in orange:
 - When manual exposure assist indicates settings other than 0 EV in [Manual Exposure] Mode or during Exposure Compensation.
 - When the flash fires.
 - When the correct exposure is not achieved or when the brightness of the screen cannot be displayed accurately in a dark location.
- The histogram displayed during recording is only a reference.
- The histogram is different from those displayed using the image editing software of a computer.

Switching the display information on the recording screen

fc Enabling/disabling the guideline display**MENU** → **fc** [Custom] → [Guide Line] → [] / [] / [] / [OFF]

- The guideline is not displayed during panorama picture recording.

When you select [], you can use ▲ ▼ ◀ ▶ to set the position.

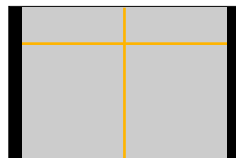
**fc** Turning on/off the recording information screen of the monitor**MENU** → **fc** [Custom] → [Monitor Info. Disp.] → [ON] / [OFF]

Switching the display information on the recording screen

Using the level gauge

If you want to make sure that the camera is not slanted or tilted, for example, when you take a picture of a landscape, use the level gauge indication as a reference.

1 Press [DISP.] button to switch the display

Press the button to switch the display. Press the button until the level gauge is displayed.

2 Correct camera angle

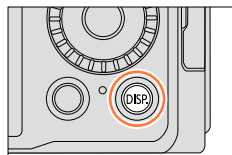

Using the level gauge

The yellow line indicates the current angle. Correct the angle of the camera so that it matches the white line.

Tilting up or down

- In this case, it is facing upward.

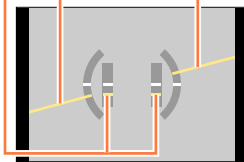
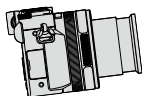

Tilting left or right

- In this case, the right side has dropped.

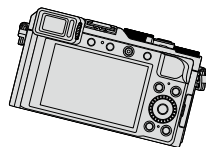

- When the camera is tilted very little or not at all, the level gauge will turn green.
- When pictures are taken in portrait orientation, the level gauge is automatically switched to one for portrait orientation.

- Even when angle is more or less corrected, there may be an error of about ± 1 degree.
- When [Level Gauge] is assigned to a function button, you can turn the level gauge on and off every time you press the function button.

 Not available in the following cases:

- When the camera is being moved, the level gauge may not be displayed correctly.
- The level gauge may not be displayed correctly or the direction detect function (→53) may not operate correctly if the pictures are taken with the camera pointing sharply up or down.

Viewing your pictures

1 Press the Playback button

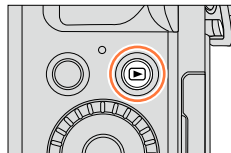

2 Press ◀▶ or turn the control dial to select the picture to be displayed

- When you press and hold ◀▶, the pictures are displayed one after another.
- The playback speed of pictures varies depending on the playback conditions.



■ Ending Playback

Press the Playback button again or press the Motion picture button. The Playback can also be ended by pressing the shutter button halfway.

- When the camera is switched to the playback screen, the lens barrel is retracted after approx. 15 seconds.

Not available in the following cases:

- This camera is compliant with the unified DCF (Design rule for Camera File system) standard formulated by the Japan Electronics and Information Technology Industries Association (JEITA), and with Exif (Exchangeable image file format). Files that are not DCF-compliant cannot be played back.
- It may not be possible to properly play back pictures taken using other cameras on this unit or it may not be possible to use the functions of this unit for those pictures.

Sending pictures to the WEB services

If you press ▼ while a single picture is being displayed, you can send the picture to the WEB service quickly. (→254)

Zooming in and viewing “Playback Zoom”

1 Move the zoom lever toward T side

- Each time you move the zoom lever toward the T side, the magnification increases through four levels: 2x, 4x, 8x, and 16x. (The picture quality displayed becomes successively lower.)
- To reduce zoom → Move the zoom lever toward W side.
- Move zoom position → Press ▲▼◀▶.

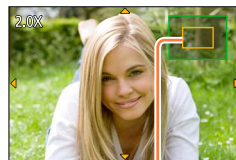
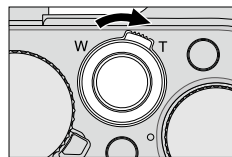

Current zoom position

- Playback zoom cannot be used during motion picture playback, automatic scrolling playback of panorama pictures or continuous playback.

Viewing a list of pictures “Multi Playback”

1 Move the zoom lever toward W side

- Move the zoom lever toward the W side and you can switch the display methods in the following order: 1-picture screen (full-screen) → 12-picture screen → 30-picture screen → Calendar screen. (Move the lever to the T side to return.)
- When you select a picture using the cursor button and press [MENU/SET] on the 12-picture or 30-picture screen, the selected picture is displayed on the 1-picture screen (full-screen).
- Pictures can also be selected with the control dial.

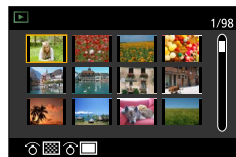
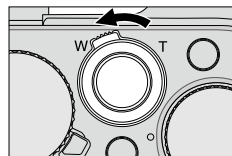

- Pictures displayed with [!] cannot be played back.

Viewing pictures by their recording date “Calendar Playback”

- 1 Move the zoom lever toward the W side to display the calendar screen

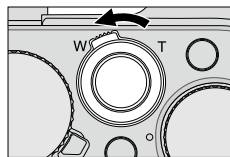

- 2 Use ▲▼◀▶ to select recording date and press [MENU/SET]

- Pictures are displayed in a 12-picture screen.
- You can also select the date with the control dial.

Selected date



- You can display the calendar between January 2000 to December 2099.
- Only months when pictures were taken are shown on the calendar screen. Pictures taken without clock settings are displayed with the date 1st January, 2014.
- Pictures taken with destination settings made in [World Time] are displayed in the calendar screen using the appropriate date for the destination's time zone.

Viewing motion pictures

This unit was designed to play motion pictures using the AVCHD and MP4 formats.

1 Select a picture with the motion picture icon ([) in playback mode, and press **▲** to start playback

- After playback starts, the elapsed playback time is displayed on the screen.
- Some information will not be displayed for motion pictures recorded in [AVCHD].



Motion picture recording time

Example:
29 minutes and
30 seconds: [29m30s]

Operations during motion picture playback

▲ : Pause/play

▼ : Stop

◀ : Fast rewind (2 steps*1)/Single-frame rewind*2 (while paused)

▶ : Fast forward (2 steps*1)/Single-frame forward (while paused)

Control dial (counterclockwise): Volume down

Control dial (clockwise): Volume up

[MENU/SET]: Capturing still pictures from motion pictures (while paused) (→203)

*1 The fast forward or rewind speed increases if you press ◀▶ again.

*2 Motion pictures recorded in [AVCHD] are reworded frame by frame approximately every 0.5 seconds.

- If ▲ is pressed during fast forward or rewind, it will return to normal playback speed.

- Motion pictures can be viewed on your computer using "PHOTOfunSTUDIO" on the supplied DVD.
- Motion pictures that were recorded by setting the picture effect (Filter) to [Miniature Effect] are played back at approximately 8x speed.

Switching the display information on the playback screen

You can disable the display of picture information (file number, etc.) and recording information (settings used for recording, etc.) when a picture is played back.

1 Press [DISP.] button to switch the display

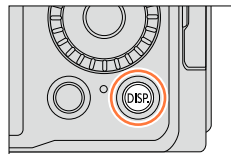

- The display is switched as shown below.

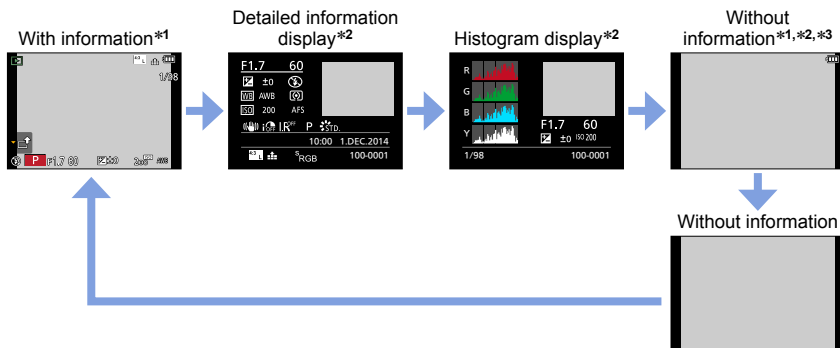

- *1 If you do not perform any operation for approximately 1 minute or longer, some of the information on the screen is turned off. To display the information again, press the [DISP.] button.
- *2 During Playback Zoom, Motion Picture Playback, Automatic Scrolling Playback of panorama pictures, continuous playback or Slide Show: You can only turn the display on or off.
- *3 This screen is displayed only when [Highlight] (→72) in the [Custom] menu is set to [ON].

- A histogram of each colour, including R (red), G (green), B (blue), and Y (luminance), is separately displayed during playback.
- During Multi Playback or calendar screen: Display cannot be changed.

Enabling/disabling the overexposed area display

MENU → **fC** [Custom] → [Highlight] → [ON] / [OFF]

You can set overexposed areas (areas that are too bright and where there are no shades of grey) to flash on the screen when the [Auto Review] function is activated or during playback. This does not affect recorded pictures.

- To reduce overexposed areas, record a picture by setting negative exposure compensation (→135) using the histogram display (→64) and so on as a reference. (The right edge of the histogram shows the overexposed portion.)
- This feature is disabled during Multi Playback, Calendar Playback or Playback Zoom.

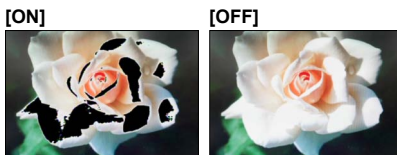

Deleting pictures

Deleted pictures cannot be recovered.

Pictures will not be deleted in the following cases:

- Protected pictures.
- Card switch is in "LOCK" position.
- Pictures that are not based on the DCF standard. (→67)

- Do not turn off the camera while deleting.
- Use a sufficiently charged battery or an AC adaptor (optional) and DC coupler (optional).

[Delete Single]

1 Press [🗑️/➡️] button to delete displayed picture

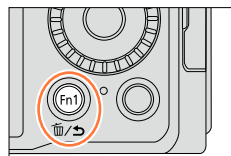

2 Use ▲ to select [Delete Single] and press [MENU/SET]

- A confirmation screen is displayed. Select [Yes] and press [MENU/SET].

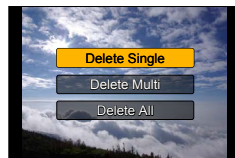

- You can set either [Yes] or [No] as the default setting on the deletion confirmation screen when you perform [Delete Confirmation] in the [Playback] menu. [No] is selected at the time of purchase. (→223)

To delete multiple (up to 100)/To delete all pictures

A picture group (→201) is handled as 1 picture. (All the pictures in the selected picture group are deleted.)

1 Press [Fn/↵] button while viewing a picture

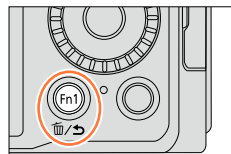

2 Use ▲▼ to select [Delete Multi]/[Delete All] and press [MENU/SET]

- Items can also be selected by turning the control dial.
- When [Delete All] is selected
→ A confirmation screen is displayed. Select [Yes] and press [MENU/SET].
- You can select [All Delete Except Favorite] in [Delete All] if there are pictures that have been set as [Favorite] (→219).

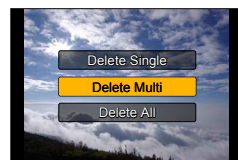

3 (When [Delete Multi] is selected) Use ▲▼◀▶ to select picture and press [MENU/SET]

- To cancel → Press [MENU/SET] again.
- Pictures can also be selected with the control dial.

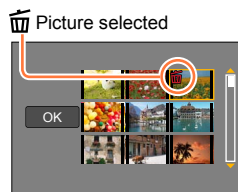

4 (When [Delete Multi] is selected) Use ◀ to select [OK] and press [MENU/SET]

- A confirmation screen is displayed. Select [Yes] and press [MENU/SET].
- May take time depending on number of pictures deleted.

Taking pictures with automatic settings

[Intelligent Auto] Mode

Recording mode: **[iA]** **P** **A** **S** **M**

This mode is recommended for those who want to point and shoot as the camera optimises settings to match the subject and recording environment.

The camera optimises the settings and the following functions are activated automatically.

- Automatic Scene Detection / Backlight Compensation / [Face/Eye Detection] / Auto White Balance / Intelligent ISO sensitivity control / [Red-Eye Removal] / [i.Zoom] / [i.Resolution] / [Stabilizer] / [i.Dynamic] / [Long Shtr NR] / [Quick AF] / [AF Assist Lamp]

1 Press [iA] button

The camera switches to [Intelligent Auto] Mode.

- When you press the [iA] button again, the recording mode is switched to one that is set using the aperture ring and shutter speed dial.

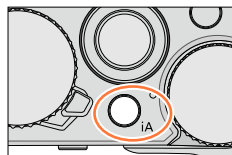

2 Point the camera at the subject

- When the camera identifies the optimal scene, the icon for each scene turns blue for 2 seconds and then changes to the normal red indication.
- When you press \blacktriangleleft and press the shutter button halfway, AF Tracking is activated. For details (\rightarrow 117).



Changing the operation method of the [iA] button

MENU \rightarrow **fC** [Custom] \rightarrow [iA Button Switch]











[Single Press]: When you press the [iA] button, the camera switches to [Intelligent Auto] Mode.

[Press and hold]: If you press and hold the [iA] button, the camera switches to [Intelligent Auto] Mode.

Taking pictures with automatic settings [Intelligent Auto] Mode

Automatic Scene Detection

When taking pictures





 [i-Portrait]	 [i-Scenery]	 [i-Macro]	 [i-Night Portrait]*1
 [i-Night Scenery]	 [i-Handheld Night Shot]*2	 [i-Food]	 [i-Baby]*3
 [i-Sunset]	 When scene does not correspond to any of the above		







*1 When the flash (supplied/optional) is used.

*2 When [i-Handheld Night Shot] is [ON]. (→78)

*3 When children (that are registered in the camera with Face Recognition) under 3 years old are recognised.

When recording motion pictures

 [i-Portrait]	 [i-Scenery]	 [i-Low Light]	 [i-Macro]
 When scene does not correspond to any of the above			

- In [, [, and [, the camera adjusts the focus on the eye that is closest to this unit and matches the exposure with the face. In [Intelligent Auto] Mode, the eye to be focused on cannot be changed. (**[Face/Eye Detection]**)
- When the camera identifies [] as the optimal scene and if the camera determines that jitter is reduced by the use of a tripod or by other means, a shutter speed that is slower than usual is selected. After pressing the shutter button, do not move the camera while recording.
- Automatic Scene Detection does not function until the focus is locked on a subject during AF Tracking.
- When [Face Recog.] is set to [ON] and if the camera recognises a face similar to a registered face, [R] is displayed on the upper right corner of the [, [, and [] icons.

- Depending on recording conditions, different scene types may be determined for the same subject.



About Backlight Compensation

Backlight compensation is automatically activated in [Intelligent Auto] Mode. Backlight is a condition where a light shines from behind a subject. When there is a backlight, the subject appears darker and the camera will automatically attempt to correct it by increasing the brightness of the picture.

Taking pictures with automatic settings [Intelligent Auto] Mode

Using the flash (supplied/optional)

- 1 Turn off the camera
- 2 Remove the hot shoe cover
- 3 Attach the flash
- 4 Turn on the camera and the flash

For details (→176, 291).

■ Flash

When the [ON/OFF] switch for the flash (supplied/optional) is set to [OFF], the flash is set to [☒] (Forced Flash Off). When the [ON/OFF] switch is set to [ON], the flash is set to [A] (AUTO).

When the flash is turned on, the camera automatically sets [A], [RE], or [SR] based on the type of subject and brightness.

- When [RE] or [SR] is displayed, the [Red-Eye Removal] function is activated to automatically detect red-eye and correct the picture data.
- When [RE] or [SR] is selected, the shutter speed is reduced.

Available menus



You can set only the following menus.

Menu	Item
[Rec]	[Picture Size] / [Quality] / [AFS/AFF/AFC] / [Burst Rate] / [Self Timer] / [iHandheld Night Shot] / [iHDR] / [Time Lapse Shot] / [Stop Motion Animation] / [Face Recog.]
[Motion Picture]	[Rec Format] / [Rec Quality] / [AFS/AFF/AFC]
[Custom]	[Silent Mode] / [Guide Line] / [Remaining Disp.]
[Setup]	All menu items can be set. (→41)

Taking pictures using a handheld camera ([iHandheld Night Shot])

If a night scene is detected automatically while the unit is being handheld, [iHandheld Night Shot] can record a still picture with less jitter and less noise without using a tripod by combining a burst of pictures.

MENU →  **[Rec]** → **[iHandheld Night Shot]** → **[ON] / [OFF]**

- The angle of view becomes narrow slightly.
- A message indicating that multiple pictures are to be recorded appears on the screen. After the shutter button has been pressed, do not move the camera during the burst operation.
- When the camera is fixed in place on a tripod or by other means,  will not be identified.
- The flash is fixed to the  (Forced Flash Off) setting.

Not available in the following cases:

- This function will not work for still pictures while motion pictures are being recorded.
- [iHandheld Night Shot] cannot be used in the following cases:
 - When using [Time Lapse Shot]
 - When using [Stop Motion Animation] (only available with [Auto Shooting] setting)

Combining pictures into a single still picture with rich gradation ([iHDR])

When there is, for example, strong contrast between the background and the subject, [iHDR] records multiple still pictures with differing exposures and combines them to create a single still picture rich in gradation. [iHDR] is activated when required. When activated, [HDR] will be displayed on the screen.

MENU →  **[Rec]** → **[iHDR]** → **[ON]** / **[OFF]**

- The angle of view becomes narrow slightly.
- A message indicating that multiple pictures are to be recorded appears on the screen. After the shutter button has been pressed, do not move the camera during the burst operation.
- Since a burst of still pictures are combined after they have been recorded, it will be a few moments before you can record another picture.
- In the case of composition from a burst, afterimages may appear if the subject was moving.

Not available in the following cases:

- This function will not work for still pictures while motion pictures are being recorded.
- [iHDR] cannot be used in the following cases:
 - When the flash is used
 - When using [Burst]
 - When using [Time Lapse Shot]
 - When using [Stop Motion Animation] (only available with [Auto Shooting] setting)

Taking pictures after setting the aperture value and shutter speed

Recording mode: **[iA]** **[P]** **[A]** **[S]** **[M]**

You can set the exposure using the aperture ring and shutter speed dial settings. Using the [Rec] menu to change settings and set up your own recording environment. You can also record pictures by applying picture effects. (→89)

1 Turn the aperture ring and shutter speed dial to set your preferred recording mode.

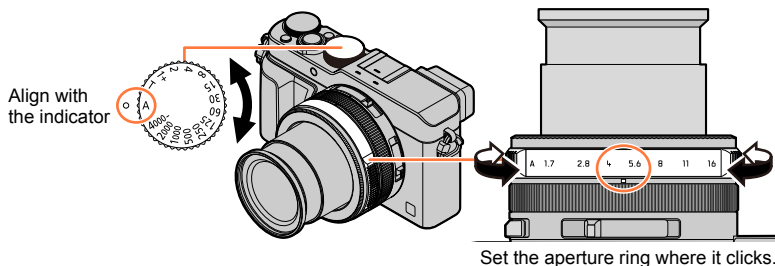

Recording mode	Aperture ring	Shutter speed dial
P [Program AE] Mode (→81)	[A] (AUTO)	[A] (AUTO)
A [Aperture-Priority] Mode (→83)	Your preferred settings*1	[A] (AUTO)
S [Shutter-Priority] Mode (→84)	[A] (AUTO)	Your preferred settings*2
M [Manual Exposure] Mode (→86)	Your preferred settings*1	Your preferred settings*2

- In [Aperture-Priority] Mode, [Shutter-Priority] Mode, and [Manual Exposure] Mode, the effect of the aperture value and shutter speed you have set is not applied to the recording screen. To check the effect on the recording screen, use [Preview] Mode. (→88)

The brightness of the screen may vary from the actual pictures recorded. Check the brightness of pictures using the playback screen.

A faster shutter speed than the set shutter speed may be used when you record a motion picture.

*1 You can set the aperture values between F1.7 and F16.

You may not be able to select some values depending on zoom position.

*2 You can set the shutter speed between 1 second and 1/4000 seconds.

Turn the control ring or control dial to set the shutter speed in the following cases.

- Higher speed than 1/4000 seconds or slower shutter speed than 1 second
- Shutter speed setting in 1/3 EV steps

Taking pictures after setting the aperture value and shutter speed

Taking pictures after automatically setting the aperture value and shutter speed ([Program AE] Mode)

Take pictures using automatic aperture values and shutter speed settings in accordance with the brightness of a subject.

1 Turn the aperture ring to select [A] (AUTO)

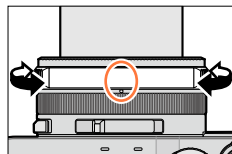

2 Turn the shutter speed dial to select [A] (AUTO)

[Program AE] Mode is set and the recording mode icon changes to [P].

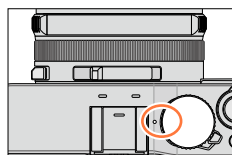

3 Press the shutter button halfway

- If the aperture value and shutter speed flash red, you do not have the correct exposure.



Programme Shift indication

4 While the numeric values are displayed in yellow (approximately 10 seconds), turn the control dial to change the values using Programme Shift (→82)

- To cancel Programme Shift, either turn off the camera or turn the control dial until the Programme Shift indication turns off.
- To correct the exposure, use the exposure compensation dial to adjust the compensation value. (→135)



Enabling/disabling the exposure meter display

MENU → **fC** [Custom] → [Expo.Meter] → [ON] / [OFF]

- When you set this function to [ON], an exposure meter is displayed during Programme Shift, aperture setting, and shutter speed operation.
- Proper exposure is not possible in the range indicated in red.
- If the exposure meter is not displayed, press the [DISP.] button to switch the display of the monitor. (→62)
- The exposure meter will turn off if no operation is performed for approximately 4 seconds.



Taking pictures after setting the aperture value and shutter speed

About Programme Shift

The function for maintaining the same exposure (brightness) while changing the shutter speed and aperture value combination is called "Programme Shift". You can use "Programme Shift" to take pictures by adjusting the shutter speed and aperture value even in [Program AE] Mode.

<Example of Programme Shift>

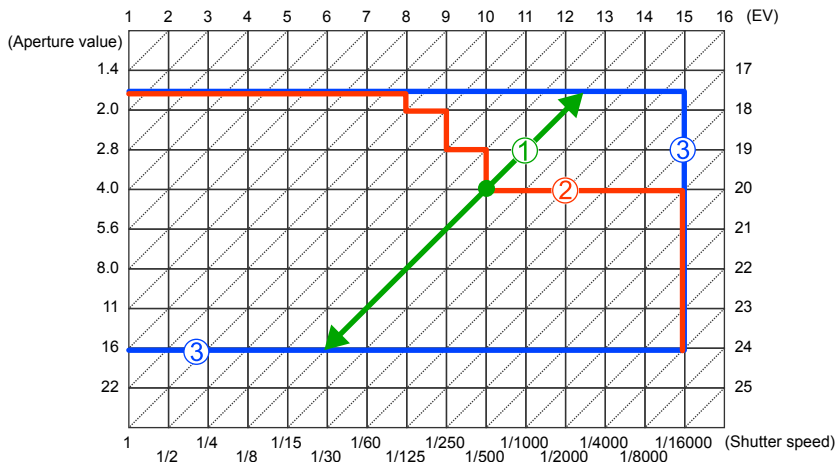

- ① Programme Shift amount
- ② Programme Shift diagram
- ③ Programme Shift limit

- EV is an abbreviation of "Exposure Value", a unit indicating the amount of exposure. The EV changes with the aperture value or the shutter speed.

 **Not available in the following cases:**

- Programme Shift cannot be used in the following cases:
 - During motion picture recording
 - When [Sensitivity] is set to [ISO]

Taking pictures after setting the aperture value and shutter speed

Taking pictures by setting the aperture value ([Aperture-Priority] Mode)

When the aperture value is increased, the range of depth in focus expands, and the picture shows up clearly from the position of the camera to the background. When the aperture value is reduced, the range of depth in focus shrinks, and the background can get blurry.

1 Turn the shutter speed dial to select [A] (AUTO)

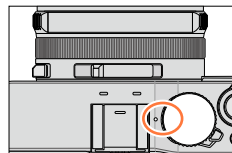

2 Turn the aperture ring to select the aperture value

[Aperture-Priority] Mode is set and the recording mode icon changes to [A].

- To correct the exposure, use the exposure compensation dial to adjust the compensation value. (→135)

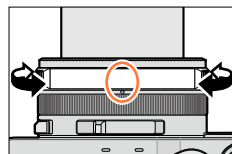

Aperture values that can be set*	Shutter speed set (seconds)
F1.7 - F16	60 - 1/4000 (When the mechanical shutter is used)
	1 - 1/16000 (When the electronic shutter is used)

* You may not be able to select some values depending on zoom position.

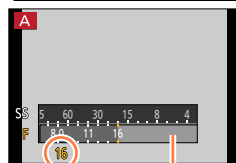

Exposure meter
Aperture value

- When you turn the aperture ring, an exposure meter is displayed. If the correct exposure is not achieved, the numeric values of the aperture are shown in red.
- If the correct exposure is not achieved when you press the shutter button halfway, the numeric values of the aperture and shutter speed are displayed in flashing red.

Taking pictures after setting the aperture value and shutter speed

Taking pictures by setting the shutter speed ([Shutter-Priority] Mode)

When you increase the shutter speed, you can reduce jitter when recording a subject. When you decrease the shutter speed, the subject's movement is shown.

1 Turn the aperture ring to select [A] (AUTO)

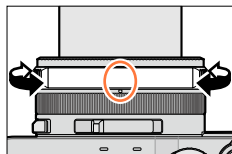

2 Turn the shutter speed dial to select the shutter speed

[Shutter-Priority] Mode is set and the recording mode icon changes to [S].

- To correct the exposure, use the exposure compensation dial to adjust the compensation value. (→135)

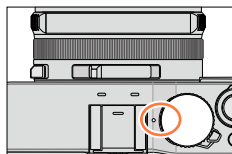

Shutter speeds that can be set (seconds)	Aperture value set
60 - 1/4000 (When the mechanical shutter is used)	F1.7 - F16
1 - 1/16000 (When the electronic shutter is used)	

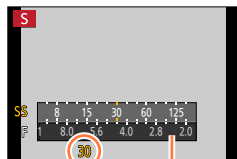

Exposure meter
Shutter speed

■ Setting the shutter speed to values not provided on the shutter speed dial

Turn the control ring or control dial to set the following shutter speeds. Check the shutter speed on the screen.

For details on setting the shutter method, refer to (→140).

- Higher speed than 1/4000 seconds or slower shutter speed than 1 second

① Turn the shutter speed dial to select [4000-] or [1+]

② Turn the control ring or control dial to select the shutter speed

- Shutter speed setting in 1/3 EV steps

You can set the shutter speed from the setting value of the shutter speed dial in the range of $\pm 2/3$ steps.

Example: To set the shutter speed to 1/400 seconds

① Turn the shutter speed dial to select [500]

② Turn the control ring or control dial to select [400]

Taking pictures after setting the aperture value and shutter speed

- When you turn the shutter speed dial, an exposure meter is displayed. If the correct exposure is not achieved, the numeric value of the shutter speed is shown in red.
- If the correct exposure is not achieved when you press the shutter button halfway, the numeric values of the aperture and shutter speed are displayed in flashing red.
- If you switch the recording mode to [Shutter-Priority] Mode when [Sensitivity] is set to [ISO], [Sensitivity] will change to [AUTO].
- We recommend using a tripod or self-timer when the shutter speed is slow.

Taking pictures after setting the aperture value and shutter speed

Taking pictures by setting the aperture value and shutter speed ([Manual Exposure] Mode)

Determine the exposure by manually setting the aperture value and the shutter speed. The Manual Exposure Assist appears on the lower portion of the screen to indicate the exposure.

1 Turn the aperture ring to select the aperture value

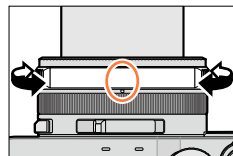

2 Turn the shutter speed dial to select the shutter speed

[Manual Exposure] Mode is set and the recording mode icon changes to [M].

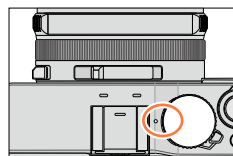

Aperture values that can be set*1	Shutter speeds that can be set*2 (seconds)
F1.7 - F16	T (Time), 60 - 1/4000 (When the mechanical shutter is used) 1 - 1/16000 (When the electronic shutter is used)

*1 You may not be able to select some values depending on zoom position.

*2 You may not be able to select some shutter speeds depending on the aperture value.

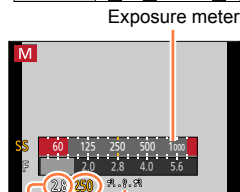

Exposure meter

Manual Exposure Assist

Shutter speed

Aperture value

■ Setting the shutter speed to values not provided on the shutter speed dial

Turn the control ring or control dial to set the following shutter speeds. For the setting procedures, refer to (→84).

- Higher speed than 1/4000 seconds or slower shutter speed than 1 second
- Shutter speed setting in 1/3 EV steps

- If the correct exposure is not achieved when you press the shutter button halfway, the numeric values of the aperture and shutter speed are displayed in flashing red.
- If you switch the recording mode to [Manual Exposure] Mode when [Sensitivity] is set to [ISO], [Sensitivity] will change to [AUTO].
- We recommend using a tripod or self-timer when the shutter speed is slow.

Taking pictures after setting the aperture value and shutter speed

**Manual exposure assist (estimate)**

	Shows pictures with standard brightness (appropriate exposure).
	Shows brighter pictures. For the appropriate exposure, either use a faster shutter speed or increase aperture value.
	Shows darker pictures. For the appropriate exposure, either use a slower shutter speed or reduce aperture value.

About T (time)

When you set the shutter speed to T (time) and fully press the shutter button, the shutter opens. (Approximately up to 120 seconds)

When you press the shutter button again, the shutter closes. Use this function when you want to keep the shutter open for an extended period, for example, to record pictures of fireworks or night scenes.

- When you take pictures with the shutter speed set to T (time), make sure to use a fully charged battery (→20).
- Manual exposure assist is not displayed.
- If you set the shutter speed to T (time) when [Sensitivity] is set to [AUTO], [Sensitivity] will change to [200].
- You cannot use this function when the electronic shutter is used.
- You can use this function only in [Manual Exposure] Mode.



- When you take pictures with the shutter speed set to T (time), we recommend using remote recording with a tripod or smartphone as a remote shutter release (→228, 234), in order to prevent jitter.
- When you take still pictures with the shutter speed set to T (time), the pictures may have higher noise levels. If you want to suppress noise, we recommend taking pictures by setting [Long Shtr NR] to [ON] in the [Rec] menu. (→113)

**Enabling/disabling the preview of the selected aperture value and shutter speed effects on the recording screen**

MENU → **fC** [Custom] → [Constant Preview] (M Mode) → [ON] / [OFF]

- This function is disabled when the flash is used.
- You can use this function only in [Manual Exposure] Mode.

Taking pictures after setting the aperture value and shutter speed

Checking the effects of the aperture value and shutter speed ([Preview] Mode)

Recording mode: **[iA] [P] [A] [S] [M]**

You can use [Preview] Mode to check the effects of the selected aperture value and shutter speed.

- **Checking the effect of the selected aperture value:** This enables you to check the depth of field (focus range) by physically narrowing the lens aperture blades to the aperture value used for the actual recording.
- **Checking the effect of the selected shutter speed:** This allows you to check motion in a scene by displaying the screen at the shutter speed used for the actual recording. When the shutter speed is increased, the screen is displayed like a frame dropping. Use this function to check the effect when you want to capture an image in a scene by stopping the motion, for example, when you take a picture of water flowing.

1 Assign [Preview] to the function button (→37)

- The following step is an example of assigning [Preview] to the [Fn1] button.

2 Press the [Fn1] button to switch the confirmation screen

- Every time you press the [Fn1] button, the screen switches.

Normal recording screen



Effect of aperture value



Effect of shutter speed



Depth of field characteristic

Recording conditions	Aperture value	Small	Large
	Focal length	Telephoto	Wide-angle
	Distance to a subject	Close	Far
Depth of field (Focus range)	Shallow (narrow) Example: To take a picture by deliberately blurring the background	Deep (wide) Example: To take a picture by adjusting the focus while including the background	

- You can take a picture even when [Preview] Mode is activated.
- The range in which you can check the effect of a selected shutter speed is between 8 seconds and 1/16000 seconds.

Taking pictures using picture effects (Filter)

Recording mode: **IA P A S M**

You can select your own settings from various effects and take pictures while confirming these effects on the screen. You can set the effects to be applied to a picture by selecting a sample picture. You can add picture effects while you record a panorama picture.

1 Press [FILTER] button

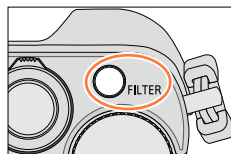

2 Press ▲▼ or turn the control dial to select the picture effect (Filter)

- You can select from among 22 picture effects (Filter). (→92 - 99)
- The picture effect for the sample picture you selected is applied to the picture shown on the preview display.

Preview display

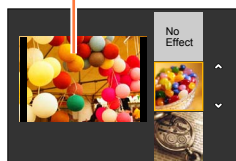

3 Press [MENU/SET]

The display of a picture with a selected picture effect appears on the screen.

Example: When the picture effect ([Sunshine]) is selected in [Program AE] Mode

- Ⓐ Picture effects
(This is not displayed when [No Effect] is selected.)
- Ⓑ Adjusting the picture effect (→91)
(This is displayed only when a picture effect is selected.)



Changing the picture effect (Filter)

Press the [FILTER] button again and perform the same procedure from step 2 above.

Taking pictures using picture effects (Filter)

- Settings will be stored even if the recording mode is changed or the camera is turned off.
- If you do not want to add picture effects, please select [No Effect].
- When you set a picture effect, the following settings are fixed.
 - White Balance: [AWB]
 - [Photo Style]: [Standard]
 - [Highlight Shadow]: [Standard]
 - [i.Dynamic]: [OFF]
 - [HDR]: [OFF]
 - [Color Space]: [sRGB]
- The flash is set to [⊗] (Forced Flash Off).
- The display of a picture reflecting a selected effect in the preview screen or recording screen may differ from the actual recorded pictures.

Switching the display of a selection screen for applying picture effects (Filter)

1 Press the [DISP.] button to switch the display

- Every time you press the [DISP.] button, the screen for which picture effects are selected changes.
- When you switch the screen to the guide display, a description of the picture effects appears.

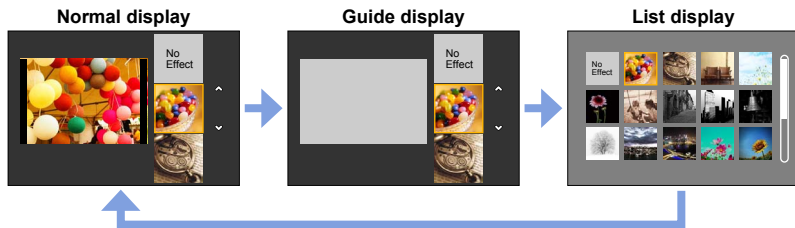

Taking pictures using picture effects (Filter)

Adjusting the picture effects according to your preferences

You can easily adjust the setting conditions (such as degree and colouring of an effect) of the picture effects according to your preferences.

1 Press ► to display the setting screen**2 Turn the control dial to adjust the setting conditions of the picture effects**

- The settings that can be adjusted vary depending on the selected picture effect. Refer to “Items that can be set” for the corresponding picture effect.
- Press [MENU/SET] to return to the recording screen.
- When you select picture effects, [↻] appears on the screen.
- If you do not want to change the current setting, select the centre point (standard) in the adjustment level bar.

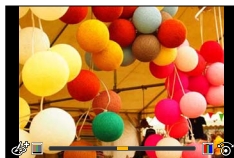
**Taking two still pictures with and without picture effects ([Simultaneous record w/o filter])**

You can take two still pictures at the same time by pressing the shutter button once; one with effects and one without effects.

MENU → **[Rec]** → **[Simultaneous record w/o filter]**

Settings: [ON] / [OFF]

- When [ON] is set, the camera will take a still picture with the effects applied and then a still picture without the effects.
- A still picture recorded without effects applied will use the same menu settings as when the picture effects (Filter) were applied. The following settings are fixed.
 - White Balance: [AWB] (You cannot perform fine adjustments.)
 - [i.Dynamic]: [OFF]
- After taking the picture, [Auto Review] will display only the still picture with the effects applied.
 - If you set this function to [ON], burst, Auto Bracket, Aspect Bracket, White Balance Bracket, [Time Lapse Shot], [Stop Motion Animation] and panorama picture recording will be disabled.
 - This function is disabled during motion picture recording.

Taking pictures using picture effects (Filter)

For the setting procedures for picture effects (Filter), refer to (→89).

[Expressive]

This effect emphasises the colour to make a pop art picture.

Items that can be set (Press ► to display the setting screen)

Vividness	Subdued colouring	◀→	Gaudy colouring
-----------	-------------------	----	-----------------

**[Retro]**

This effect gives a faded image.

Items that can be set (Press ► to display the setting screen)

Colouring	Yellowish colouring	◀→	Reddish colouring
-----------	---------------------	----	-------------------

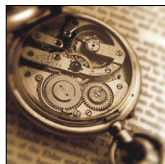
**[Old Days]**

This effect adds a bright, soft and nostalgic feel to the overall image.

Items that can be set (Press ► to display the setting screen)

Contrast	Low contrast	◀→	High contrast
----------	--------------	----	---------------

**[High Key]**

This effect adds a bright, airy and soft feel to the overall image.

Items that can be set (Press ► to display the setting screen)

Colouring	Pinkish colouring	◀→	Light-bluish colouring
-----------	-------------------	----	------------------------

- When recording a panorama picture in a scene with low brightness, you may not be able to achieve the desired results.



Taking pictures using picture effects (Filter)

For the setting procedures for picture effects (Filter), refer to (→89).

[Low Key]

This effect adds a dark and relaxing feel to the overall image and enhances bright parts.

Items that can be set (Press ► to display the setting screen)

Colouring	Reddish colouring	◀▶	Bluish colouring
-----------	-------------------	----	------------------

**[Sepia]**

This effect creates a sepia image.

Items that can be set (Press ► to display the setting screen)

Contrast	Low contrast	◀▶	High contrast
----------	--------------	----	---------------

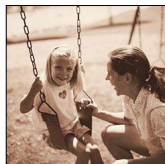
**[Monochrome]**

This effect creates a black and white picture.

Items that can be set (Press ► to display the setting screen)

Colouring	Yellowish colouring	◀▶	Bluish colouring
-----------	---------------------	----	------------------

**[Dynamic Monochrome]**

This effect gives a higher contrast to create an impressive black and white picture.

Items that can be set (Press ► to display the setting screen)

Contrast	Low contrast	◀▶	High contrast
----------	--------------	----	---------------



Taking pictures using picture effects (Filter)

For the setting procedures for picture effects (Filter), refer to (→89).

[Rough Monochrome]

This effect creates a black and white picture with granular noise.

Items that can be set (Press ► to display the setting screen)

Grainy image effect	Weak grainy image effect	◀▶	Strong grainy image effect
---------------------	--------------------------	----	----------------------------

- The recording screen is displayed like a frame dropping with a slight delay compared to normal recording.



[Silky Monochrome]

This effect blurs the overall image to add a soft feel to a black and white picture.

Items that can be set (Press ► to display the setting screen)

Degree of defocusing	Slight defocusing	◀▶	Strong defocusing
----------------------	-------------------	----	-------------------

- The recording screen is displayed like a frame dropping with a slight delay compared to normal recording.



[Impressive Art]

This effect gives your photo a dramatic contrast look.

Items that can be set (Press ► to display the setting screen)

Vividness	Black & white	◀▶	Gaudy colouring
-----------	---------------	----	-----------------

- When recording a panorama picture, the places where successively taken pictures are stitched may be noticeable.



[High Dynamic]

This effect produces the optimum brightness for both dark and bright parts.

Items that can be set (Press ► to display the setting screen)

Vividness	Black & white	◀▶	Gaudy colouring
-----------	---------------	----	-----------------



Taking pictures using picture effects (Filter)

For the setting procedures for picture effects (Filter), refer to (→89).

[Cross Process]

This effect gives your photo a dramatic colour look.

Items that can be set (Press ► to display the setting screen)

Colouring	Greenish colouring / Bluish colouring / Yellowish colouring / Reddish colouring
-----------	--

**[Toy Effect]**

This effect reduces peripheral brightness to give the impression of a toy camera.

Items that can be set (Press ► to display the setting screen)

Colouring	Orangish colour ←→ Bluish colouring
-----------	-------------------------------------

**[Toy Pop]**

This effect creates a vivid and bright image with the look of a toy camera.

Items that can be set (Press ► to display the setting screen)

Range in which peripheral brightness is reduced	Small ←→ Large
---	----------------

**[Bleach Bypass]**

This effect gives a higher contrast and a lower saturation to create a calm and tranquil picture.

Items that can be set (Press ► to display the setting screen)

Contrast	Low contrast ←→ High contrast
----------	-------------------------------



Taking pictures using picture effects (Filter)

For the setting procedures for picture effects (Filter), refer to (→89).

[Miniature Effect]

This effect blurs peripheral areas to give the impression of a diorama.

Items that can be set (Press ► to display the setting screen)

Vividness	Subdued colouring	◀→	Gaudy colouring
-----------	-------------------	----	-----------------



■ Defocusing a picture

You can create the impression of a diorama by intentionally creating a blurred area and focusing area using [Miniature Effect]. You can set the recording direction (direction of blurred area), position and size of the focusing area.

- ① Press [Fn1] button
- ② Press ▲▼ or ◀▶ to move the focusing area (frame)
- ③ Turn the control dial to select the size of the focusing area (frame)
- ④ Press [MENU/SET]
 - When you press [DISP.] button, the initial setting condition is restored.

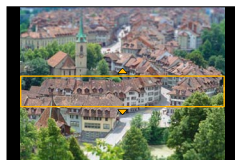

- The recording screen is displayed like a frame dropping with a slight delay compared to normal recording.
- No audio is recorded for motion pictures.
- When a motion picture is recorded, the finished recording will be approximately 1/8th of the actual recorded time period. (If you record a motion picture for 8 minutes, the resulting motion picture recording time will be approximately 1 minute.) The recordable time displayed on the camera is approx. 8x longer than actual time needed for recording. When the Recording Mode is changed, be sure to check the recordable time.
- If you stop recording motion pictures too soon, the camera may continue recording until a certain time. Hold the camera until the camera stops recording.
- If [MF] is selected for the focus mode, move the focusing area to the position at which the focus has been adjusted.

Taking pictures using picture effects (Filter)

For the setting procedures for picture effects (Filter), refer to (→89).

[Soft Focus]

This effect blurs the overall image to produce a soft feel.

Items that can be set (Press ► to display the setting screen)

Degree of defocusing	Slight defocusing	◀→	Strong defocusing
----------------------	-------------------	----	-------------------

- The recording screen is displayed like a frame dropping with a slight delay compared to normal recording.



[Fantasy]

This effect creates a fantastical image in a pale colour tone.

Items that can be set (Press ► to display the setting screen)

Vividness	Subdued colouring	◀→	Gaudy colouring
-----------	-------------------	----	-----------------

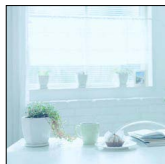

[Star Filter]

This effect transforms pin-points of light into a star effect.

Items that can be set (Press ► to display the setting screen)

Length of the rays of light	Rays of light is short	◀→	Rays of light is long
-----------------------------	------------------------	----	-----------------------

- The recording screen is displayed like a frame dropping with a slight delay compared to normal recording.



Taking pictures using picture effects (Filter)

For the setting procedures for picture effects (Filter), refer to (→89).

[One Point Color]

This effect leaves one selected colour to emphasise impressiveness.

Items that can be set (Press ► to display the setting screen)

Amount of colour retained	Leaves a small amount of colour	◀▶	Leaves a large amount of colour
---------------------------	---------------------------------	----	---------------------------------



■ Selecting colour

- ① Press [Fn1] button
- ② Select the colour to be retained with ▲▼◀▶ and press [MENU/SET]
 - When you press [DISP.] button, the initial setting condition is restored.



- The selected colour may not be retained for some subjects.

Taking pictures using picture effects (Filter)

For the setting procedures for picture effects (Filter), refer to (→89).

[Sunshine]

This effect adds a cast of light to the scene.

Items that can be set (Press ► to display the setting screen)

Colouring	Yellowish colouring / Reddish colouring / Bluish colouring / Whitish colouring
-----------	---



■ Setting the light source

- ① Press [Fn1] button
- ② Press ▲▼◀▶ to move the centre of the light source to a different position
 - You can move the centre of the light source to the edge of the screen.

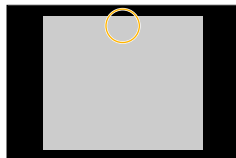

Tips on positioning the centre of the light source

You can move the centre of the light source to a point outside the image to obtain a more natural finish.

- ③ Turn the control dial to adjust the size of the light source
 - You can change the light source among four sizes.
 - When you press [DISP.] button, the initial setting condition is restored.
 - ④ Press [MENU/SET]
- The recording screen is displayed like a frame dropping with a slight delay compared to normal recording.

Adjusting the picture quality with effects [Photo Style]

Recording mode:

You can adjust the colours and picture quality according to the concept of the picture that you want to create.

MENU → **[Rec]** → **[Photo Style]**

[Standard]	Standard setting.
[Vivid]	Setting with slightly high contrast and saturation.
[Natural]	Setting with slightly low contrast.
[Monochrome]	Setting that creates a picture using monochrome shades of grey only, such as black and white.
[Scenery]	Setting that creates a picture using vivid colours for the blue sky and green.
[Portrait]	Setting that produces the look of a healthy complexion.
[Custom]	Setting for using colours and picture quality that were registered in advance.

- [Photo Style] is fixed to [Standard] when the picture effect (Filter) is set.
- The menu item is common for both the [Rec] and [Motion Picture] menus. If a setting in one menu is changed, the setting with the same name in other menu will also be changed automatically.

Adjusting the picture quality with effects [Photo Style]

■ Adjusting the picture quality

① Press ◀▶ to select the type of Photo Style

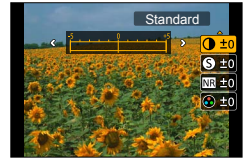

② Press ▲▼ to select an item and press ◀▶ to adjust

ⓘ [Contrast]	[+]	Increases the contrast in a picture.
	[-]	Decreases the contrast in a picture.
Ⓢ [Sharpness]	[+]	Enhances the outlines in a picture.
	[-]	Softens the outlines in a picture.
NR [Noise Reduction]	[+]	Increases the noise reduction effect to reduce noise. This setting may slightly lower the resolution.
	[-]	Lowers the noise reduction effect to achieve a picture quality with clearer resolution.
🌈 [Saturation]*1	[+]	Gaudy colouring
	[-]	Subdued colouring
🌈 [Color Tone]*1	[+]	Bluish colouring
	[-]	Yellowish colouring
🎛️ [Filter Effect]*2	[Yellow]	Enhances the contrast of a subject. (Effect: Low) Records a blue sky clearly.
	[Orange]	Enhances the contrast of a subject. (Effect: Medium) Records a blue sky with vibrant colours.
	[Red]	Enhances the contrast of a subject. (Effect: High) Records a blue sky with even more vibrant colours.
	[Green]	Applies subdued colouring for the skin and lips of a person. Emphasises green leaves and makes them brighter.
	[Off]	—

*1 [Color Tone] is displayed only when [Monochrome] is selected. Otherwise, [Saturation] is displayed.

*2 [Filter Effect] is displayed only when [Monochrome] is selected.

• When the picture quality is adjusted, [+] will be displayed in the icon.

③ Press [MENU/SET]

■ Registering the setting for the adjusted picture quality to [Custom]

① Perform the picture quality adjustment in Step ② of “Adjusting the picture quality” and press the [DISP.] button

• A confirmation screen is displayed. Select [Yes] and press [MENU/SET].

Adjusting highlights and shadows [Highlight Shadow]

Recording mode: **IA P A S M**

You can adjust the highlights and shadows in a picture while confirming the brightness of these areas on the screen.

1 Set the menu

MENU → **[Rec]** → **[Highlight Shadow]**

2 Press ◀▶ to select the item

<input checked="" type="checkbox"/> [[Standard]]	No adjustments.
<input checked="" type="checkbox"/> [[Higher contrast]]	Makes the highlighted areas brighter and shadowed areas darker.
<input checked="" type="checkbox"/> [[Lower contrast]]	Makes the highlighted areas darker and shadowed areas brighter.
<input checked="" type="checkbox"/> [[Brighten shadows]]	Makes the shadowed areas brighter.
<input checked="" type="checkbox"/> / <input checked="" type="checkbox"/> / <input checked="" type="checkbox"/> (Custom)	You can set a custom registration shape.

3 Turn the control ring to adjust the brightness of the highlighted areas and turn the control dial to adjust the brightness of the shadowed areas

- To register your preferred settings, press ▲ to select the registration target icon (Custom 1 (), Custom 2 (), and Custom 3 ()).

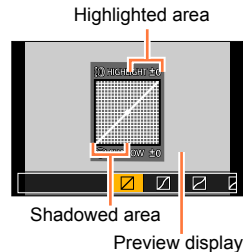

4 Press [MENU/SET]

- You can press the [DISP.] button on the brightness adjustment screen to switch the screen display.

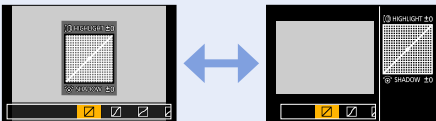

- The settings registered in , , or will be retained even if the camera is turned off.
- The settings adjusted in , , , or will be restored to the default settings when the camera is turned off.
- The menu item is common for both the [Rec] and [Motion Picture] menus. If a setting in one menu is changed, the setting with the same name in other menu will also be changed automatically.

Adjusting the White Balance

Recording mode: **iA P A S M**

In sunlight, under incandescent lights or in other such conditions where the colour of white takes on a reddish or bluish tinge, this item adjusts to the colour of white which is closest to what is seen by the eye in accordance with the light source.

1 Press [WB] button (▶)

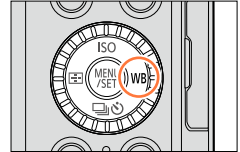

2 Turn the control dial to select the White Balance and press [MENU/SET]

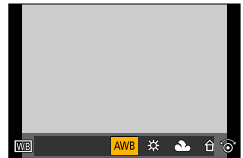

[AWB]	Automatic adjustment in accordance with the light source.
[☀]	Adjust to the colour under a clear sky.
[☁]	Adjust to the colour under a cloudy sky.
[🏠]	Adjust to the colour in the shade.
[💡]	Adjust to the colour under incandescent lights.
[WB]*	Adjust to the colour that is optimal for taking pictures using the flash.
[1]/[2]/[3]/[4]	Use the White Balance value that was set manually.
[K]	Use the preset colour temperature setting.

* The [AWB] setting is applied when recording motion pictures.



Under fluorescent lighting, LED lighting fixtures, etc., the optimal White Balance will vary depending on the lighting type, so use [AWB], [1], [2], [3] or [4].

- The White Balance may not operate correctly if you take pictures using a flash or the subject is recorded outside of the effective flash range (→177).
- [White Balance] setting is fixed to [AWB] in the following case:
 - When the picture effect (Filter) is set

Adjusting the White Balance

Auto White Balance

When [AWB] (Automatic White Balance) is set, the colouring is adjusted in accordance with the light source. However, if the scene is too bright or too dark or if other extreme conditions apply, the pictures may appear reddish or bluish. The White Balance may not operate correctly if there is a multiple number of light sources. In that case, set the [White Balance] to settings other than [AWB] to adjust the colouring.

 : [AWB] operational range

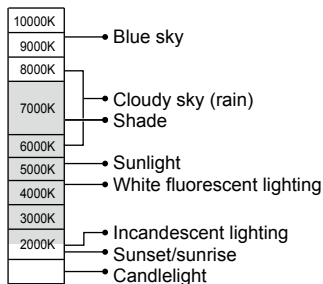

K=Kelvin Colour Temperature

Setting the White Balance manually

Take a picture of a white object under the target light source to adjust colours.

- 1 Press [WB] button (▶)
- 2 Turn the control dial to select [1], [2], [3], or [4], and press ▲
- 3 Point the camera at a white object such as a piece of paper, ensuring that it is inside the frame at the centre of the screen, and press [MENU/SET]

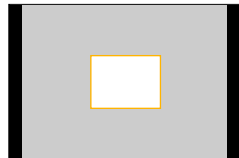

- It may not be possible to set the correct White Balance if subjects are too bright or too dark. In this case, adjust the brightness and try to set the White Balance again.

Adjusting the White Balance

Setting the White Balance using colour temperature

You can set the White Balance using colour temperature. Colour temperature is a numeric value that expresses the colour of light (unit: K*). A picture becomes bluish when the colour temperature value is higher, and reddish when the temperature value is lower.

1 Press [WB] button (▶)

2 Turn the control dial to select [K] and press ▲

3 Use ▲ ▼ to select the colour temperature value and press [MENU/SET]

- You can set the colour temperature from 2,500 K to 10,000 K.



Performing White Balance fine adjustments

White Balance settings can be individually fine-tuned if colours still do not appear as anticipated.

1 Select the White Balance and press ▼

2 Use ▲ ▼ ◀ ▶ to perform White Balance fine adjustments

- ◀: A (amber: orangish colours)
- ▶: B (blue: bluish colours)
- ▲: G (green: greenish colours)
- ▼: M (magenta: reddish colours)

- Pressing [DISP.] button resets the position back to the centre.

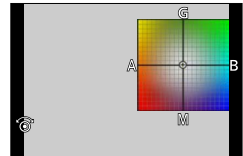

3 Press [MENU/SET]

- When you perform fine adjustments of the White Balance toward the A (amber) or B (blue) side, the colour of the White Balance icon displayed on the screen will change to the fine-tuned colour.
- When you perform fine adjustments of the White Balance toward the G (green) or M (magenta) side, [+] (green) or [-] (magenta) will be displayed in the White Balance icon on the screen.
- Settings remain applied when using flash.
- You can perform fine adjustments of the White Balance independently for each White Balance setting item.
- When you set a new White Balance value by selecting [1], [2], [3], or [4], or change the colour temperature by selecting [K], the White Balance fine adjustment level will be returned to the standard setting (centre point).

Adjusting the White Balance

Bracket recording using White Balance

Bracket settings are performed based on the fine adjustment values for White Balance, and three pictures with different colouring are automatically recorded when the shutter button is pressed once.

1 Perform fine adjustments of the White Balance in step 2 of “Performing White Balance fine adjustments” and turn the control dial to perform the Bracket setting

Turning the control dial to the right : Horizontal ([A] to [B])

Turning the control dial to the left : Vertical ([G] to [M])

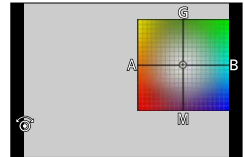

2 Press [MENU/SET]

- When the White Balance Bracket is set, [BKT] appears on the White Balance icon.
- When the camera is turned off (Including [Sleep Mode]), the White Balance Bracket setting is cancelled.
- The shutter sound will be emitted only once.

ⓘ Not available in the following cases:

- The White Balance Bracket does not function in the following cases:
 - During panorama picture recording
 - During motion picture recording
 - When [4K PHOTO] is set to [ON]
 - When the [Quality] setting is set to [RAW], [RAW] or [RAW]
 - When [HDR] is set to [ON]
 - When [Multi Exp.] is set
 - When using [Time Lapse Shot]

Setting the picture quality and size

Changing the aspect ratio of the still pictures

Recording mode: **[A]** **[P]** **[A]** **[S]** **[M]**

You can easily switch the aspect ratio of still pictures using the aspect ratio selector switch.

1 Switching the aspect ratio selector switch

[4:3]	Aspect ratio of a 4:3 TV
[1:1]	Aspect ratio of a square image
[16:9]	Aspect ratio of high-definition TV, etc.
[3:2]	Aspect ratio of standard film cameras

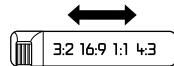
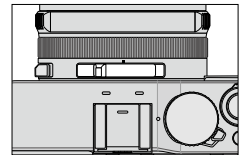

- Edges may be cut off when printing - be sure to check in advance. (→324)

Not available in the following case:

- During panorama picture recording

Setting the picture quality and size

Setting the picture size

Recording mode: **[A]** **[P]** **[A]** **[S]** **[M]**

The higher the numbers of pixels, the finer the detail of the pictures will appear even when they are printed onto large sheets.

MENU →  **[Rec]** → **[Picture Size]**

Aspect ratio	4:3	1:1	16:9	3:2
[Picture Size]	[L] 12.5M 4112×3088	[L] 10M 3088×3088	[L] 11M 4480×2520	[L] 12M 4272×2856
	[EX M] 6.5M 2976×2232	[EX M] 5M 2240×2240	[EX M] 8M 3840×2160	[EX M] 6.5M 3120×2080
	[EX S] 3M 2048×1536	[EX S] 2.5M 1536×1536	[EX S] 2M 1920×1080	[EX S] 3M 2112×1408

- When [Burst Rate] is set to [SH], [Picture Size] is fixed to [S].



Not available in the following case:





- During panorama picture recording

Setting the compression rate of pictures ([Quality])

Recording mode: **[A]** **[P]** **[A]** **[S]** **[M]**

Set the compression rate used for storing pictures.

MENU →  **[Rec]** → **[Quality]**

Settings	File format	Description
	JPEG	Gives priority to picture quality and saves pictures in JPEG file format.
		Saves pictures in JPEG file format using standard picture quality. This setting is useful when you want to increase the number of recordable pictures without changing the number of pixels.
 	RAW + JPEG	Saves pictures in JPEG file format in addition to the RAW file format.*1
	RAW	Saves pictures in the RAW file format.*2

*1 If you delete a RAW file from the camera, the corresponding JPEG file is also deleted.

*2 The picture size is fixed to the maximum recordable pixels for each image aspect ratio ([L]).



About RAW file



In RAW file format the data is saved without any picture processing by the camera. This format delivers a higher picture quality than the JPEG format, but the amount of data is greater. To play back and edit RAW file pictures, you must use this unit or dedicated software.

You can perform advanced editing of RAW file pictures, such as correcting the White Balance of pictures recorded previously, and save the pictures in file formats that can be displayed on a PC.

- You can develop the RAW file pictures using [RAW Processing] in the [Playback] menu. ([→208](#))
- To develop and edit RAW file pictures on a PC, use the supplied DVD software (Ichikawa Soft Laboratory's "SILKYPIX Developer Studio").



Not available in the following cases:

- The following effects cannot be used on RAW file pictures.
 - [Intelligent Auto] Mode
 - Picture effects (Filter)
 - White Balance*1
 - [Photo Style]*1 / [Highlight Shadow]*1 / [i.Dynamic]*1 / [Red-Eye Removal]*2 / [i.Resolution]*1 / [Color Space]*1 ([Rec] menu)
 - You cannot set to [RAW , [RAW , or [RAW] in the following case:
 - During panorama picture recording
- *1 When you use [RAW Processing] in the [Playback] menu, the adjustments are made based on the settings used during recording. Therefore, you can save JPEG file pictures by using the settings applied during recording.
- *2 If [Red-Eye Removal] is activated during recording, you can use [RAW Processing] in the [Playback] menu to save JPEG file pictures in which red-eye was detected and corrected.

Using the picture correction functions effectively

Correcting contrast and exposure ([i.Dynamic])

Recording mode: **P** **A** **S** **M**

Automatically adjusts contrast and exposure to give more lifelike colours when there is significant contrast between background and subject.

MENU → **[Rec]** → **[i.Dynamic]**

Settings: **[AUTO]** / **[HIGH]** / **[STANDARD]** / **[LOW]** / **[OFF]**

- When **[AUTO]** is set, you can automatically set the strength of the effects based on the recording conditions.
- The menu item is common for both the **[Rec]** and **[Motion Picture]** menus. If a setting in one menu is changed, the setting with the same name in other menu will also be changed automatically.



Not available in the following cases:

- Compensation effect may not be achieved depending on the conditions.
- The **[i.Dynamic]** does not function in the following cases:
 - During panorama picture recording
 - When **[HDR]** is set to **[ON]**

Enhancing the impression of high-resolution ([i.Resolution])

Recording mode: **P** **A** **S** **M**

You can use the camera's Intelligent Resolution technology to record still pictures with sharper outlines and clearer resolution.

MENU → **[Rec]** → **[i.Resolution]**

Settings: **[HIGH]** / **[STANDARD]** / **[LOW]** / **[EXTENDED]** / **[OFF]**

- When **[EXTENDED]** is set, you can take more natural pictures with the impression of high-resolution.
- The **[EXTENDED]** setting will automatically change to the **[LOW]** setting when recording motion pictures.
- The menu item is common for both the **[Rec]** and **[Motion Picture]** menus. If a setting in one menu is changed, the setting with the same name in other menu will also be changed automatically.

Combining still pictures with different exposures ([HDR])

Recording mode:

The camera can combine 3 still pictures taken at different exposures into a single properly exposed picture with rich gradation. The individual pictures used to create the HDR picture are not saved. You can minimise the loss of gradations in bright areas and dark areas when, for example, the contrast between the background and the subject is large.

A combined HDR picture is saved in JPEG format.

MENU → **[Rec]** → **[HDR]**

[ON]	Creates a combined HDR picture.	
[OFF]	Does not create a combined HDR picture.	
[SET]	[Dynamic Range]	<p>[AUTO]: Takes pictures after automatically setting the adjustment range of the exposure based on the contrast of a subject.</p> <p>[±1EV] / [±2EV] / [±3EV]: Takes pictures using the adjustment range of the exposure being set.</p>
	[Auto Align]	<p>[ON]: Automatically adjusts the displacement of pictures caused by jitter, etc. We recommend using this setting to take pictures with a handheld camera.</p> <p>[OFF]: Does not adjust the displacement of pictures. We recommend using this setting when you use a tripod.</p>

What is HDR?

HDR stands for High Dynamic Range and refers to a technique for expressing a wide contrast range.

- After the shutter button has been pressed, do not move the camera during the burst operation.
- Since a burst of still pictures are combined after they have been recorded, it will be a few moments before you will be able to record another picture.
- A subject that was in motion when it was recorded may be recorded as an afterimage.
- When [Auto Align] is set to [ON], the angle of view narrows slightly.
- When you take pictures using a flash, the flash mode is fixed to (Forced Flash Off).

Not available in the following cases:

- This function will not work for still pictures while motion pictures are being recorded.
- [HDR] cannot be used in the following cases:
 - When the [Quality] setting is set to [RAW], [RAW] or [RAW]
 - When using [Time Lapse Shot]
 - When using [Stop Motion Animation] (only available with [Auto Shooting] setting)

Using the picture correction functions effectively

Suppressing the noise of a long exposure ([Long Shtr NR])

Recording mode: **P** **A** **S** **M**

The camera can automatically eliminate the noise made when taking pictures with a slower shutter speed (e.g. to record night scenes) in order to take sharp pictures.

MENU → **[Rec]** → **[Long Shtr NR]**

Settings: **[ON]** / **[OFF]**

- While the camera eliminates the noise, [Long shutter noise reduction ongoing] is displayed for the same period as the shutter speed selected for the signal processing time.



Not available in the following cases:

- The [Long Shtr NR] does not function in the following cases:
 - During panorama picture recording
 - During motion picture recording
 - When [Burst Rate] is set to [SH]
 - When using the electronic shutter

Setting the colour space

Recording mode: **P** **A** **S** **M**

You can set the method for reproducing the colours to correctly display the recorded pictures on the screens of a PC or printer, etc.

MENU → **[Rec]** → **[Color Space]**

[sRGB]	Sets the sRGB colour space. This setting is widely used for devices such as PCs.
[AdobeRGB]	Sets the AdobeRGB colour space. AdobeRGB colour space has a wider colour reproduction range than sRGB colour space. Therefore, AdobeRGB colour space is mainly used for business applications such as commercial printing.

- Select [sRGB] if you do not have expert knowledge about AdobeRGB colour space.
- During motion picture recording, the setting is fixed to [sRGB].

Taking pictures with Auto Focus

1 Switch the focus selector switch to [AF] or [AF ∞]

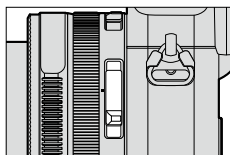

Auto Focus is activated.



Align with the indicator.

Select the focus mode (AFS, AFF, AFC)

Recording mode: **[iA]** **[P]** **[A]** **[S]** **[M]**

Set the focusing operation to be performed when the shutter button is pressed halfway.

[MENU] → **[Rec]** → **[AFS/AFF/AFC]**

Focus selector switch	Settings	The movement of the subject and the scene (recommended)	Description
AF* AF ∞ *	[AFS]	Subject is still (Scenery, anniversary photograph, etc.)	"AFS" is an abbreviation of "Auto Focus Single". Focus is set automatically when the shutter button is pressed halfway. Focus will be fixed while it is pressed halfway.
	[AFF]	Movement cannot be predicted (Children, pets, etc.)	"AFF" is an abbreviation of "Auto Focus Flexible". In this mode, focusing is performed automatically when the shutter button is pressed halfway. If the subject moves while the shutter button is pressed halfway, the focus is corrected to match the movement automatically.
	[AFC]	Subject is moving (Sport, trains, etc.)	"AFC" is an abbreviation of "Auto Focus Continuous". In this mode, while the shutter button is pressed halfway, focusing is constantly performed to match the movement of the subject. When the subject is moving, the focusing is performed by predicting the subject position at the time of recording.
MF	—	—	Focusing is performed manually. (→128)

* In [Intelligent Auto] Mode, the setting is fixed to AF Macro even if you switch the focus selector switch to [AF] or [AF ∞] (AF Macro).

Taking pictures with Auto Focus

**When recording using [AFF], [AFC]**

- Focusing may take time if the zoom is suddenly changed from max. W to max. T, or if you suddenly move closer to a subject from a greater distance.
- Press the shutter button halfway again when it is difficult to focus on the subject.
- While the shutter button pressed halfway, shake may be seen on the screen.

- If the light on a subject is insufficient when using [AFF] or [AFC], the camera performs the same focusing operation as [AFS]. In this case, the indication on the screen will change to yellow [AFS].

**Not available in the following case:**

- The camera adjusts the focus using [AFS] in the following case:
 - During panorama picture recording

Switching [AF Mode]

Recording mode: **iA P A S M**

This allows the focusing method that suits the positions and number of the subjects to be selected.

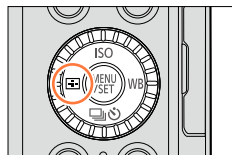
1 Press [MENU/SET] button (◀)**2 Press ◀▶ to select Auto Focus mode and press [MENU/SET]**

- If you press ▼ when [iA], [P], [A], or [S] is selected, the AF area setting screen appears. For details on operation of the AF area setting screen, refer to (→121).

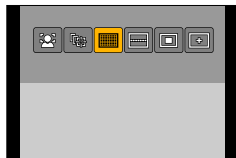

- Auto Focus is fixed to [A] (1-area-focusing) in the following case:
 - When the picture effect (Filter) is set ([Miniature Effect])

**Not available in the following case:**

- Cannot set to [P+] (Pinpoint-focusing) in the following case:
 - When [AFS/AFF/AFC] (→114) is set to [AFF] or [AFC]

Taking front-on pictures of people (Face/Eye Detection)

The camera automatically detects the faces and eyes of subjects. The camera adjusts the focus on the eye that is closer to the camera and the exposure using the face (when [Metering Mode] is set to  (Multi Metering)).

- The camera can detect up to 15 faces. The camera can detect only the eyes of faces to be focused on.

When the camera recognises a face, the AF area and eye used for focusing are displayed.

Yellow: When the shutter button is pressed halfway, the frame turns green when the camera is focused.

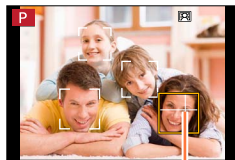

White: Displayed when more than one face is detected. Other faces that are the same distance away as faces within the yellow AF area are also focused.



Eye used for focusing

- You can change the position and size of the AF area and eye to be used for focusing.

(→121)

- If [Metering Mode] is set to  (Multi Metering) when  (Face/Eye Detection) is selected, the camera will adjust the exposure using the face of a subject. (→139)



Not available in the following case:

- If conditions prevent the face from being recognised, such as when the movement of the subject is too rapid, the AF Mode setting switches to  (49-area-focusing).



Automatically locking the focus on a moving subject (AF Tracking)



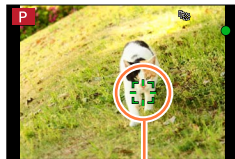

1 Align the AF Tracking frame with the subject and press the shutter button halfway

When the subject is recognised, the AF Tracking frame changes from white to yellow, and the subject is automatically kept in focus. If AF Lock fails, a red frame flashes for a while and then turns off. Retry the locking operation.





AF Tracking frame

- To release AF Tracking → Press [MENU/SET].
- Focus range: same as macro recording [.
- In [Intelligent Auto] Mode, every time you press , AF Tracking and Face Detection are switched.

- When you set [Metering Mode] to [] (Multi Metering), the camera adjusts the exposure using a locked subject. (→139)
- Under certain recording conditions, such as when the subject is small or dark, [] (AF Tracking) may not operate correctly. When [] (AF Tracking) does not work, focus will be on [] (1-area-focusing).

Not available in the following cases:

- [] (AF Tracking) cannot be used in the following case:
 - When using [Time Lapse Shot]
- In the following cases, [] (AF Tracking) performs the operation of [] (1-area-focusing).
 - When the picture effect (Filter) is set ([Sepia], [Monochrome], [Dynamic Monochrome], [Rough Monochrome], [Silky Monochrome], [Soft Focus], [Star Filter], [Sunshine])
 - [Monochrome] in [Photo Style]

Subject not centred in picture (49-area-focusing) / , etc. (Custom Multi)

(49-area-focusing)

Focuses on the subject in the wide range area (up to 49-area-focusing) on the recording screen.

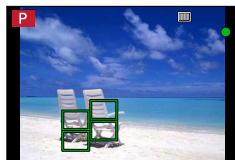

- You can select the focusing area. (→121)

[], etc. (Custom Multi)

You can set the preferred shape of an AF area by selecting 49 points in the AF area, based on the subject.

1 Press [] button (◀)**2 Select a Custom Multi icon ([], etc.), and press ▲**





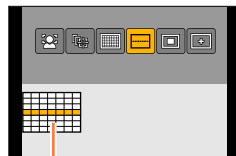

- When you press ▼, the AF area setting screen appears.

3 Use ◀▶ to select the setting item

- The currently set shape of an AF area is displayed on the bottom-left of the screen.



Current AF area shape

 ([Horizontal Pattern])	Horizontal line shape Ideal shape for panning, etc.	
 ([Vertical Pattern])	Vertical line shape Ideal shape for recording structures, etc.	
 ([User Defined])	Custom shape	
 ([Custom])	You can set a custom registration shape.	



4 Press ▼

- The AF area setting screen appears.

5 Select the AF area

- The selected AF area is displayed in yellow whereas the unselected area is displayed in white.

When selecting [] / []

When [] is selected, you can set the size and position of the area in the vertical direction and when [] is selected, you can set the size and position of the area in the horizontal direction.

Operation of buttons	Description
▲ ▼ ◀ ▶	Moves position
Control dial	Changes the size (up to three lines)
[DISP.] button	Restores to the initial settings

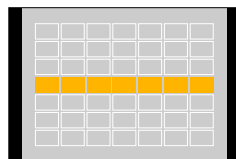

Taking pictures with Auto Focus

When selecting [FREE] / [C1] / [C2] / [C3]

Use ▲▼◀▶ to select AF area and press [MENU/SET] to set (repeat)

- If you press [MENU/SET] again, the setting will be cancelled.
- To cancel all the settings, press the [DISP.] button.

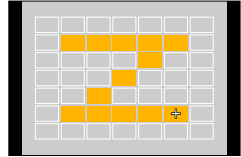
**6 Press [Fn2] button****■ Registering the set AF area in [C1], [C2], and [C3] (Custom)**

- ① Press ▲ on the screen of step 3 on (→118)
- ② Use ▲▼ to select the registration target icon and press [MENU/SET]
 - A confirmation screen is displayed. If you select [Yes], the operation is executed.

- The settings registered in [C1], [C2], or [C3] will be retained even if the camera is turned off.
- The settings adjusted in [FREE], [C1], or [C2] will be restored to the default settings when the camera is turned off.
- If you press the cursor button when [Direct Focus Area] in the [Custom] menu is set to [ON], the AF area setting screen will appear.

Determined position for focus  (1-area-focusing) /  (Pinpoint-focusing)** (1-area-focusing)**

Focuses on AF area in centre of picture. (Recommended when focus is difficult to align)

- You can change the position and size of the AF area. (→121)

**Locking the focus**

If a subject you want to record is not in the centre, follow the steps below. (Only when [AFS/AFF/AFC] is set to [AFS])

1 Adjust focus according to subject

Align the AF area with the subject



Hold down halfway

Focus display

(When focus is aligned: illuminated
When focus is not aligned: flashing)

**AF area**



(When focus is aligned: green
When focus is not aligned: red)

2 Return to desired composition

Press fully

** (Pinpoint-focusing)**

Enables more precise focusing on a smaller point than  (1-area-focusing).

- You can set the focus position using the enlarged screen. (→122)
- When you press the shutter button halfway, an enlarged display of the focus position appears.
- You can set the timeout for the enlarged display using [Pinpoint AF Time] in the [Custom] menu. (→122)
- If  (Pinpoint-focusing) is selected while recording motion pictures, the setting is changed to  (1-area-focusing).

**Not available in the following case:**

- Cannot set to  (Pinpoint-focusing) in the following case:
 - When [AFS/AFF/AFC] (→114) is set to [AFF] or [AFC]

Changing the position and size of the AF area

■ When selecting [] / []

You can change the position and size of the AF area.

- ① Select [] or [] and press ▼
 - The AF area setting screen appears.
- ② To change the AF area
 - To move the position of the AF area: Press ▲▼◀▶
 - To change the size of the AF area: Turn the control dial
 - If you set the AF area to an eye in the yellow frame when [] is selected, the eye to be used for focusing will be changed.
 - To restore the AF area to its initial state (position)
 - Press [DISP.] button.
- ③ Press [MENU/SET]

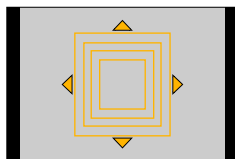

■ When selecting []

You can set the focus position by selecting an AF area group. The AF area, which is configured with 49 points, is divided into groups consisting of 9 points each (6 points or 4 points for the groups located at the edges of the screen).

- ① Select [] and press ▼
 - The AF area setting screen appears.
- ② Press ▲▼◀▶ to select an AF area group
- ③ Press [MENU/SET]
 - Only the [+] indications (centre points of the selected group) remain on the screen.
 - To cancel the settings for the AF area frame, press [MENU/SET].

Examples of group

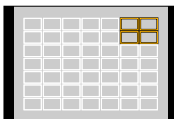
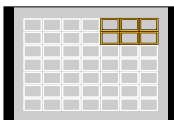
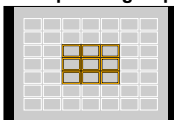

Taking pictures with Auto Focus

■ When selecting [⊕]

You can enlarge the screen to perform more precise settings of the focus position.

- You cannot set the focus position at the edges of the screen.

- ① Select [⊕] and press ▼
- ② Use ▲▼◀▶ to set the focus position and press [MENU/SET]
 - The enlarged assist screen will appear for setting the focus position.
- ③ Move [⊕] to the focus position with ▲▼◀▶
 - Pressing [DISP.] button will bring the focus position back to the centre of the assist screen.

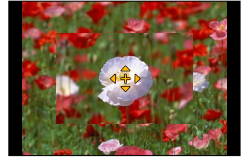

Changing the display of the assist screen

MENU → **fC [Custom]** → **[Pinpoint AF Display]**

[FULL]: Enlarges the assist screen using the entire screen.



[PIP]: Enlarges the assist screen on part of the screen.



- When [PIP] is selected, the size of the screen is enlarged or reduced approximately 3 times to 6 times. When [FULL] is selected, the size of the screen is enlarged or reduced approximately 3 times to 10 times. Enlarge or reduce the screen by magnification factors of x1 steps using the control dial.





Setting the timeout for the enlarged display

MENU → **fC [Custom]** → **[Pinpoint AF Time]** →
[LONG] (approx. 1.5 seconds) / **[MID]** (approx. 1.0 seconds) /
[SHORT] (approx. 0.5 seconds)

- If you release the shutter button, the enlarged display will turn off even before the screen timeout.

Enabling/disabling use of cursor button to move the AF area

MENU →  [Custom] → [Direct Focus Area] → [ON] / [OFF]

When [], [], or [] is selected, you can move the AF area and when [] is selected, you can move the enlarged position.

- When [Custom Multi] such as [] is selected, the AF area setting screen is displayed.
- Use the Quick menu ([→34](#)) to set functions to be assigned to the cursor button, such as [Drive Mode], [White Balance] and [Sensitivity].

- When you set [Metering Mode] ([→139](#)) to [] (spot-focusing), the metering target will move along with the AF area. When the AF area is moved to the edges of the screen, the metering operation may be affected by the surrounding brightness.

Not available in the following cases:

- [Direct Focus Area] is fixed to [OFF] in the following case:
 - When the picture effect (Filter) is set
- The position and size of the AF area cannot be changed in the Digital Zoom range.

Setting your preferred focusing method

You can use the [Custom] menu to set the focusing method in detail.



Enabling/disabling focus adjustment when the shutter button is pressed halfway

MENU → **fC** [Custom] → [Shutter AF] → [ON] / [OFF]



Enabling/disabling shutter release when the shutter button is pressed halfway

MENU → **fC** [Custom] → [Half Press Release] → [ON] / [OFF]



Focusing using the [AF/AE LOCK] button

You can use the [AF/AE LOCK] button instead of the shutter button to focus on a subject.

1 Set the [Custom] menu

MENU → **fC** [Custom] → [Shutter AF] → [OFF]

MENU → **fC** [Custom] → [AF/AE Lock] → [AF-ON]

2 Press the [AF/AE LOCK] button

The camera focuses on a subject.

3 Press the shutter button to take a picture

- The camera takes a picture by adjusting the exposure.

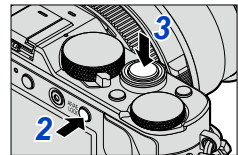

Enabling/disabling pre-adjustment of focus

MENU → **fC** [Custom] → [Quick AF] → [ON] / [OFF]

The focus is automatically adjusted when camera blurring is small even when the shutter button is not pressed. (Increases battery consumption)

- Press shutter button halfway if focus is difficult to align.
- [Quick AF] cannot be used in the following cases:
 - In the [Preview] Mode
 - When the lighting is low

Turning on/off the AF Assist Lamp

MENU → **fC** [Custom] → [AF Assist Lamp] → [ON] / [OFF]

Illuminates the AF Assist Lamp when the shutter button is pressed halfway when it is too dark to facilitate focusing. (A large AF area is displayed based on recording conditions.)

- The AF Assist Lamp has an effective distance of 1.5 m (4.9 feet).
- AF Assist Lamp is effective for a subject at the centre of the screen. Use the lamp by positioning a subject at the centre of the screen.
- If you do not want to illuminate the AF Assist Lamp when you take a picture in a dark location (e.g. taking a picture of an animal in the dark), set this function to [OFF]. When the AF Assist Lamp is set to [OFF], sharper focusing will become difficult.
- The setting is fixed to [OFF] in the following case:
 - When [Silent Mode] is set to [ON]

Enabling/disabling recording when a subject is out of focus

MENU → **fC** [Custom] → [Focus/Release Priority]

[FOCUS]: Recording is disabled unless the focusing is performed properly.

[RELEASE]: Recording is performed when you fully press the shutter button to place priority on the shutter release timing that helps to avoid missed opportunities.

- Note that a picture may be out of focus when [RELEASE] is set, even if the focus mode is set to [AFS], [AFF], or [AFC].
- This function is disabled during motion picture recording.

Enabling/disabling manual focus adjustment after AF

MENU → **fC** [Custom] → [AF+MF] → [ON] / [OFF]

You can manually perform fine focusing during AF Lock (pressing the shutter button halfway when [AFS/AFF/AFC] is set to [AFS] or setting AF Lock using the [AF/AE LOCK] button).

Taking close-up pictures (Macro recording)

Recording mode: **iA P A S M**

When you want to enlarge the subject, setting to [AF \updownarrow] (AF Macro) enables you to take pictures at an even closer distance than the normal focus range (up to 3 cm (0.098 feet) for max. Wide).

1 Switch the focus selector switch to [AF \updownarrow]

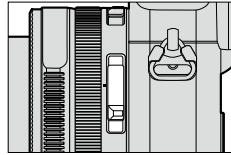

Enables close-up focusing on a subject. (Auto Focus functions.)



Align with the indicator.

Focus range

When a subject is too close to the camera, the picture may not be properly focused.

Shortest recording distance

The shortest recording distance is the distance from the lens front to the subject. This distance changes gradually depending on the zoom position.

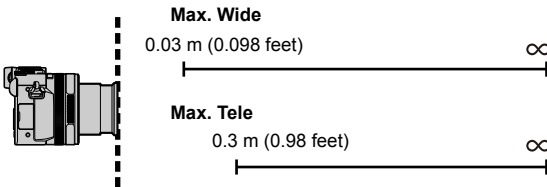

When the focus selector switch is set to [AF \updownarrow] (AF Macro).

Focus selector switch	Zoom	
	Max. Wide	Max. Tele
[AF]	50 cm (1.6 feet)	50 cm (1.6 feet)
[AF \updownarrow] (AF Macro)	3 cm (0.098 feet)	30 cm (0.98 feet)
[MF] (\rightarrow 128)	3 cm (0.098 feet)	30 cm (0.98 feet)

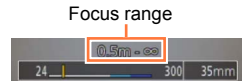

- Focus range is displayed when operating the zoom, etc.

Taking close-up pictures (Macro recording)

- In [Intelligent Auto] Mode, the shortest recording distance will be the same as that for [AF \uparrow], regardless of the focus selector switch setting.
- It may take some time until distant subjects come into focus.
- Using a tripod and [Self Timer] is recommended. Also, when recording a subject close to the camera, we recommend taking a picture without using the flash.
- Moving the camera after aligning the focus is likely to result in poorly focused pictures if subject is close to the camera, due to the margin for focus alignment being severely reduced.
- Resolution may be reduced around the edges of the picture.

Taking pictures with Manual Focus

Recording mode: **[iA] [P] [A] [S] [M]**

Manual Focus is convenient when you want to lock the focus to take pictures or when it is difficult to adjust focus using Auto Focus.

1 Switch the focus selector switch to [MF]

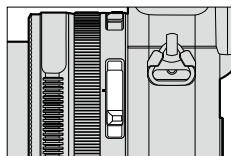

Focus manually on a subject.



Align with the indicator.

2 Press [MF] button (◀)

3 Press ▲▼◀▶ to determine the area to be enlarged, and press [MENU/SET]

- The screen changes to the assist screen and an enlarged display appears. (MF Assist) (→131)
- If you press [DISP.] button, the area to be enlarged will be reset to the centre.

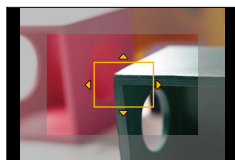

4 Turn the control ring to adjust focus

Turning the control ring to the right:

Focusing on a nearby subject

Turning the control ring to the left:

Focusing on a distant subject

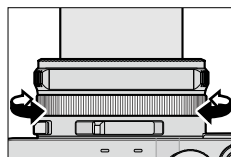

- Colour is added to the portions of the image that are in focus. (Peaking) (→130)
- You can confirm the direction of focus adjustment toward the close distance side or far distance side. (MF Guide) (→129)

MF Assist
(Enlarged screen)
Peaking

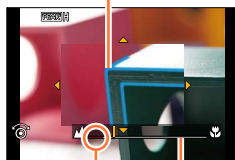

MF Guide
Indicator for ∞ (infinity)

- After zoom operation, readjust the focus.
- After cancelling [Sleep Mode], be sure to readjust the focus.

Enabling/disabling MF Guide display

MENU → **fC** [Custom] → [MF Guide] → [ON] / [OFF]

Quickly adjusting the focus using Auto Focus

MENU → **fC** [Custom] → [AF/AE Lock] → [AF-ON]

If you press the [AF/AE LOCK] button in Manual Focus, Auto Focus is activated.

- Auto Focus is activated at the centre of the frame.
- When Auto Focus is activated on the MF Assist screen, the camera will adjust the focus at the centre of the MF Assist screen.

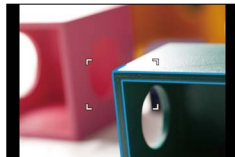

**Enabling/disabling [Peaking] to add colour to the portions of the image that are in focus****MENU** → **ƒC [Custom]** → **[Peaking]**

- [Peaking] functions during Manual Focus or when you are adjusting focus manually using [AF+MF].

[ON]	Colour is added to the portions of the image that are in focus.																
[OFF]	The portions of the image that are in focus are not displayed.																
[SET]	[Detect Level]	<p>The detection level for in-focus portions is set. When [HIGH] is set, portions to be highlighted are reduced, allowing you to achieve a more precise focus.</p> <p>Settings: [HIGH] / [LOW]</p> <ul style="list-style-type: none"> • The detection level setting does not affect the focus range. 															
	[Display Color]	<p>Sets the highlighting colour used for [Peaking].</p> <p>Settings</p> <p>The available colour settings differ depending on the setting of [Detect Level]. Changing the [Detect Level] setting also changes the [Display Color] setting as follows.</p> <table border="1"> <tr> <td>[Detect Level]</td> <td>[HIGH]</td> <td>↔</td> <td>[LOW]</td> </tr> <tr> <td></td> <td>[] (Light blue)</td> <td>↔</td> <td>[] (Blue)</td> </tr> <tr> <td>[Display Color]</td> <td>[] (Yellow)</td> <td>↔</td> <td>[] (Orange)</td> </tr> <tr> <td></td> <td>[] (Green)</td> <td>↔</td> <td>[] (White)</td> </tr> </table>	[Detect Level]	[HIGH]	↔	[LOW]		[] (Light blue)	↔	[] (Blue)	[Display Color]	[] (Yellow)	↔	[] (Orange)		[] (Green)	↔
[Detect Level]	[HIGH]	↔	[LOW]														
	[] (Light blue)	↔	[] (Blue)														
[Display Color]	[] (Yellow)	↔	[] (Orange)														
	[] (Green)	↔	[] (White)														

- When [Peaking] is set to [ON], [**PEAK H**] ([Detect Level]: [HIGH]) or [**PEAK L**] ([Detect Level]: [LOW]) will be displayed.
- When [Fn Button Set] (→37) in the [Custom] menu is set to [Peaking], you can switch the setting in the following order every time the assigned function button is pressed: [ON] ([Detect Level]: [LOW]) → [ON] ([Detect Level]: [HIGH]) → [OFF].
- Since portions with clear outlines on the screen are highlighted as in-focus portions, portions to be highlighted vary depending on the recording conditions.
- The colour used for highlighting does not affect recorded pictures.

**Not available in the following case:**

- [Peaking] does not function in the following case:
 - When the picture effect (Filter) is set ([Rough Monochrome])

MF Assist

■ Displaying the MF Assist

- Turn the control ring to display MF Assist.
- You can also display MF Assist by pressing ◀ to display the setting screen, pressing the cursor button to set the position to be enlarged, and then pressing [MENU/SET].
- When you perform the following operation, the position to be enlarged will be returned to the centre.
 - When you press the [DISP.] button on the screen used for setting of the position to be enlarged
- If you press the cursor button when [Direct Focus Area] in the [Custom] menu is set to [ON], the setting screen for the enlarged position appears.

■ Closing the MF Assist

- To exit MF Assist, press the shutter button halfway.
- You can also exit MF Assist by pressing [MENU/SET].
- When you display MF Assist by turning the control ring, MF Assist is automatically ended approximately 10 seconds after you finish the operation.



Not available in the following case:

- The MF Assist is disabled in the Digital Zoom range or when recording motion pictures.



Setting the display method of MF Assist

MENU → **Ⓕ** [Custom] → **[MF Assist]**

[M]	Turn the control ring or press the [M] button (◀) to enlarge the position.
[M] <small>FOCUS</small>	Turn the control ring to enlarge the position.
[M]	Press the [M] button (◀) to enlarge the position.
[OFF]	The control ring or [M] button (◀) cannot be used to enlarge the position.

Changing the MF Assist display

MENU → **fC** [Custom] → [MF Assist Display]

[FULL]: Enlarges the assist screen using the entire screen.



[PIP]: Enlarges the assist screen on part of the screen.



- When [PIP] is selected, the size of the screen is enlarged or reduced approximately 3 times to 6 times. When [FULL] is selected, the size of the screen is enlarged or reduced approximately 3 times to 10 times. Enlarge or reduce the screen by magnification factors of x1 steps using the control dial.

Taking pictures by locking the focus and/or exposure

[AF/AE Lock]

Recording mode: **iA P A S M**

The AF/AE Lock function is convenient, for example, when there is too much contrast with the subject and you cannot get appropriate exposure (AE Lock) or when you want to take a still picture composed with the subject outside the AF area (AF Lock).

- 1 Point the camera at the subject
- 2 Lock the focus and/or exposure while you press and hold the [AF/AE LOCK] button

- When you release the [AF/AE LOCK] button, the focus and/or exposure lock is cancelled.
- Only the exposure is locked at the time of purchase.

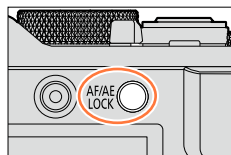

- 3 While you press and hold the [AF/AE LOCK] button, move the camera to compose the picture you want to take and fully press the shutter button

- When [AE LOCK] is set, press the shutter button halfway to focus, then press it fully.

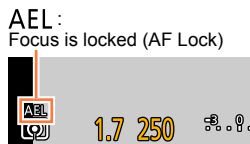

Setting the function of the [AF/AE LOCK] button

MENU → **fC** [Custom] → [AF/AE Lock]

[AE LOCK]	Locks exposure only. • [AEL], aperture value, and shutter speed are displayed when the correct exposure is achieved.
[AF LOCK]	Locks focus only. • [AFL], focus, aperture value, and shutter speed are displayed when the subject comes into focus.
[AF/AE LOCK]	Locks focus and exposure. • [AFL], [AEL], focus, aperture value, and shutter speed are displayed when the subject is in focus and the correct exposure is achieved.
[AF-ON]	Auto Focus is activated.

Maintaining/not maintaining the lock when [AF/AE LOCK] button is released

MENU → **fC** [Custom] → [AF/AE Lock Hold] → [ON] / [OFF]

Taking pictures by locking the focus and/or exposure [AF/AE Lock]

- AF Lock only is effective in the following case:
 - [Manual Exposure] Mode
- During Manual Focus, only AE Lock can be used.
- Only the AF Lock is enabled when you are recording motion pictures. Once you cancel AF Lock while recording motion pictures, you cannot perform the AF Lock operation again.
- The subject can be focused again by pressing the shutter button halfway, even when AE is locked.
- Programme Shift can be set even when AE is locked.
- Lock is cancelled when a zoom operation is performed after locking the exposure and/or focus. Perform the locking operation again.

Taking pictures with Exposure Compensation

Recording mode: **iA** **P** **A** **S** **M**

Corrects the exposure when there is a backlight or when the subject is too dark or too bright.

1 Turn the exposure compensation dial to select the compensation value

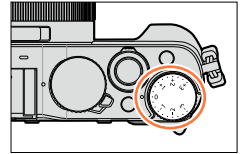

Under-exposed



Optimum exposure



Over-exposed



Adjust the exposure to the [+] direction

Adjust the exposure to the [-] direction

- You can set the exposure compensation value in the range between -3 EV and $+3$ EV.

- Depending on the brightness, this may not be possible in some cases.
- When [Auto Exposure Comp.] of [Flash] in the [Rec] menu is set to [ON], the flash output is also automatically adjusted based on the exposure compensation value. (→183)

Setting the ISO Sensitivity

Recording mode: **iA P A S M**

Set ISO Sensitivity (sensitivity to lighting) manually.

We recommend higher settings to take clear pictures in darker locations.

1 Press [ISO] button (▲)

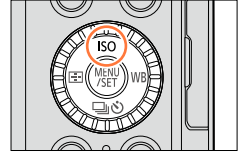

2 Turn the control dial to select ISO Sensitivity and press [MENU/SET]



AUTO	ISO Sensitivity is automatically set in a range up to 3200* ¹ depending on the brightness of a subject.
ISO (Intelligent ISO)	ISO Sensitivity is automatically set in a range up to 3200* ¹ depending on the movement and brightness of a subject.
100*²/200/400/800/1600/3200/6400/12800/25600	ISO Sensitivity is fixed at the selected setting. • When [ISO Increments] is set to [1/3EV], more ISO Sensitivity settings can be selected. (→138)

*¹ When [ISO Limit Set] (→137) in the [Rec] menu is set to other than [OFF], the ISO Sensitivity is automatically set in the range up to the [ISO Limit Set] setting value.

*² Only when [Extended ISO] is [ON].







Setting guide

Sensitivity	[200]	↔	[25600]
Location (recommended)	Bright (outdoors)		Dark
Shutter speed	Slow		Fast
Interference	Low		High
Subject blur	High		Low

Setting the ISO Sensitivity

- When [High Dynamic] is selected for the picture effect (Filter), [Sensitivity] is fixed to [AUTO].
- When a picture effect (Filter) other than [High Dynamic] is selected or when [Multi Exp.] is set, ISO Sensitivity can be set in a range up to [3200].
- For details on the available flash range used when the [Sensitivity] is set to [AUTO], refer to (→177).
- Cannot select [ISO] in the following cases:
 - [Shutter-Priority] Mode
 - [Manual Exposure] Mode
- When [Direct Focus Area] (→123) is set to [ON], the cursor button functions as an operation for moving the AF area. In that case, use the Quick menu (→34) to set the ISO Sensitivity.
- You can use the following settings when recording motion pictures:
[AUTO], [200] - [6400]

Setting the upper limit of ISO Sensitivity

Recording mode:     

You can set the upper limit of ISO Sensitivity when [Sensitivity] is set to [AUTO] or [ISO].

MENU →  **[Rec]** → **[ISO Limit Set]**

Settings: [400] / [800] / [1600] / [3200] / [6400] / [12800] / [25600] / [OFF]



Not available in the following case:

- During motion picture recording

Setting the incremental value of ISO Sensitivity

Recording mode: **P** **A** **S** **M**

You can change the setting to increase ISO Sensitivity by 1 EV or 1/3 EV.

MENU → **[Rec]** → **[ISO Increments]**

[1/3EV]	[L.100]* / [L.125]* / [L.160]* / [200] / [250] / [320] / [400] / [500] / [640] / [800] / [1000] / [1250] / [1600] / [2000] / [2500] / [3200] / [4000] / [5000] / [6400] / [8000] / [10000] / [12800] / [16000] / [20000] / [25600]
[1 EV]	[L.100]* / [200] / [400] / [800] / [1600] / [3200] / [6400] / [12800] / [25600]

* Only when [Extended ISO] is [ON].

- When this setting is changed from [1/3EV] to [1 EV], the setting for [Sensitivity] may be changed. (The closest ISO Sensitivity that can be set for [1 EV] will be used.)

Extending the ISO Sensitivity setting

Recording mode: **P** **A** **S** **M**

You can extend the numeric values that can be set for ISO Sensitivity.

MENU → **[Rec]** → **[Extended ISO]**



Settings: [ON] / [OFF]

Setting the metering mode

Recording mode: **iA P A S M**

You can change the metering method used for measuring brightness.

MENU →  **[Rec]** → **[Metering Mode]**

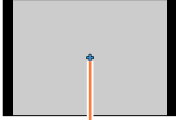
[Metering Mode]	Brightness measurement position	Conditions
 (Multiple)	Whole screen	Normal usage (produces balanced pictures)
 (Centre weighted)	Centre and surrounding area	Subject in centre
 (Spot)	Centre of [+] (spot metering target)  Spot metering target	Great difference between brightness of subject and background (e.g. person in spotlight on stage, backlighting)

- The menu item is common for both the [Rec] and [Motion Picture] menus. If a setting in one menu is changed, the setting with the same name in other menu will also be changed automatically.

Setting the Shutter Type

Recording mode:

You can take pictures using two types of shutter modes: the mechanical shutter and electronic shutter.

	Mechanical shutter	Electronic shutter
Description	Starts the exposure electronically and ends the exposure using the mechanical shutter.	Starts and ends the exposure electronically.
Flash	○	—
Shutter Speed (seconds)	60 - 1/4000	1*1 - 1/16000
Shutter sound	Mechanical shutter sound*2 + Electronic shutter sound*3	Electronic shutter sound*3

*1 You can set ISO Sensitivity up to [ISO 3200]. When ISO Sensitivity is higher than [ISO 3200], the shutter speed will be faster than 1 second.

*2 You cannot turn off the mechanical shutter sound.

*3 You can use [Shutter Vol.] to adjust the volume of the electronic shutter sound. (→43)

1 Set the menu

MENU → **[Rec]** → **[Shutter Type]**

[AUTO]	The shutter mode automatically switches based on the recording conditions and shutter speed. • The mechanical shutter mode has higher priority over the electronic shutter mode because the mechanical shutter has less function-related restrictions when recording with a flash, etc.
[MSHTR]	Uses only the mechanical shutter mode to take a picture.
[ESHTR]	Uses only the electronic shutter mode to take a picture.

- When [] is displayed on the screen, the electronic shutter is used to take a picture.
- When [Burst Rate] is set to [SH], the electronic shutter is used to take a picture.
- When [Silent Mode] is set to [ON], the electronic shutter is used to take a picture.
- **If you take a picture of a moving subject using the electronic shutter, the subject in the picture may be skewed in some cases.**
- **When you take a picture under a fluorescent or LED lighting fixture using the electronic shutter, the recorded picture may have horizontal stripes. If you use a slower shutter speed, the horizontal stripes may be reduced. (→84)**
- **Be sure to pay special attention to the privacy, likeness rights, etc. of a subject when you use this function. Use at your own risk.**

Selecting a Drive Mode

Recording mode: **[iA] [P] [A] [S] [M]**

You can switch the operation to be performed when you press the shutter button.

1 Press **[ ** button (**▼**)

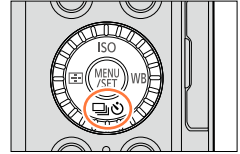

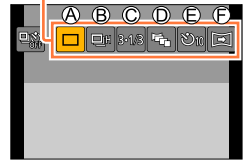

2 Press **◀▶** to select the drive mode and press **[MENU/SET]**

Drive Mode



Ⓐ [Single]	When the shutter button is pressed, only one picture is recorded.
Ⓑ [Burst] (→142)	The pictures are recorded in succession while the shutter button is pressed.
Ⓒ [Auto Bracket]* (→145)	Each time the shutter button is pressed, the pictures are recorded with different exposure settings based on the Exposure Compensation range.
Ⓓ [Aspect Bracket]* (→147)	When the shutter button is pressed, 4 pictures with 4 different aspect ratios are automatically recorded.
Ⓔ [Self Timer] (→148)	When the shutter button is pressed, recording takes place after the set time has elapsed.
Ⓕ [Panorama Shot]* (→150)	The pictures are recorded in succession while you press the shutter button and move the camera horizontally or vertically, and then the camera combines the pictures into a single panorama picture.

* Cannot be set when using [Intelligent Auto] Mode.



- To cancel drive mode, select **[**] ([Single]) or **[ OFF]**. The recording is switched to "Single".
- When you press **▲**, you can change the settings of each drive mode. Note, however, that you cannot change the settings of [Single] and [Aspect Bracket].

Burst function

Recording mode: **[iA] [P] [A] [S] [M]**

The pictures are recorded in succession while the shutter button is pressed.

- Pictures that are taken while the [Burst Rate] is set to [SH] are recorded together as a single burst group (→201).

- 1 Press **[ ** button (**▼**)
- 2 Press **◀▶** to select the burst icon (**[H]**, etc.) and press **▲**

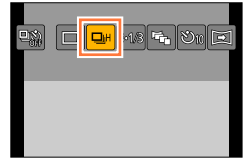

- 3 Press **◀▶** to select the burst speed and press **[MENU/SET]**

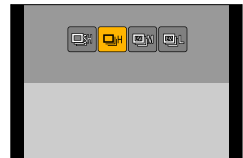

		[SH] (Super high speed)*1	[H] (High speed)	[M] (Middle speed)	[L] (Low speed)
Speed (pictures/ sec.)	[AFS]	40	11	7	2
	[AFF] / [AFC]	—	6.5	6.5	2
Live View during burst recording		None	None	Available	Available
No. of pictures*2	With RAW files	—	20*3	20*3	20*3
	Without RAW files	60	Depends on the capacity of the card*3		

*1 The electronic shutter will be activated.

*2 The number of burst pictures is limited by the picture-taking conditions and the type and/or status of the card used.

*3 Pictures can be taken until the card becomes full. However, the burst speed will become slower halfway through the recording. The exact time when the slower burst speed will start depends on the settings of the aspect ratio, picture size, and quality as well as the type of card used.

- The burst speed may become slower depending on the following settings:
 - [Picture Size] (→108), [Quality] (→109), Sensitivity (→136), Focus mode (→114), [Focus/Release Priority] (→125)
- Burst speed can also be set with [Burst Rate] in the [Rec] menu.
- For information about RAW files, refer to (→109).

4 Focus on the subject and take a picture

- Hold down the shutter button fully to activate the Burst Mode.



■ To cancel burst

In step 2, select [] ([Single]) or [OFF].



Focusing in burst mode

Focusing varies depending on the focus mode (→114) and the setting of [Focus/Release Priority] (→125) in the [Custom] menu.

Focus mode	[Focus/Release Priority]	Focus
[AFS]	[FOCUS]	At the first picture
	[RELEASE]	
[AFF] / [AFC]*1	[FOCUS]	Normal focusing*2
	[RELEASE]	Predicted focusing*3
[MF]	—	Focus set with Manual Focus



*1 Focus is fixed in the first picture when dark subjects are recorded or the burst speed is set to [SH].

*2 Since the camera records a burst of pictures while it adjusts the focus, the burst speed may be slower.

*3 The camera predicts the focus within a possible range by giving higher priority to the burst speed.

- When the burst speed is set to [H] and if many burst pictures are taken, the burst speed may be reduced while burst pictures are being taken.
- When the burst speed is set to [SH] or [H] (the focus mode is set to [AFS] or [MF]), and the exposure and White Balance are fixed to those of the first picture.
When the burst speed is set to [H] (the focus mode is set to [AFF] or [AFC]), [M], or [L], and the exposure and White Balance are adjusted individually for each still picture.
- Burst speed may be reduced if shutter speed (pictures/sec.) is reduced in darker locations.
- With repeated recordings, it may take a while between recordings, depending on the usage conditions.
- **It may take a while to store still pictures that were taken using the burst function. If you continue to record while storing, the number of burst pictures that can be taken will be reduced. A high-speed card is recommended when recording using the burst function.**

Not available in the following cases:

- The Burst Mode is disabled in the following cases:
 - When the picture effect (Filter) is set ([Rough Monochrome], [Silky Monochrome], [Miniature Effect], [Soft Focus], [Star Filter], [Sunshine])
 - When White Balance Bracket is set
 - When using [Time Lapse Shot]
 - When using [Stop Motion Animation] (only available with [Auto Shooting] setting)
 - During motion picture recording
 - When [4K PHOTO] is set to [ON]
 - When recording using the flash
 - During T (time) recording
 - When recording with [iHandheld Night Shot]
 - When [HDR] is set to [ON]
 - When [Multi Exp.] is set
 - When [Simultaneous record w/o filter] is set to [ON]
- [SH] in Burst Mode cannot be used in the following cases:
 - When [Quality] is set to [RAW ], [RAW ] or [RAW]
 - When using [Stop Motion Animation]

Recording while exposure is changed automatically

[Auto Bracket]

Recording mode: **iA P A S M**

Each time the shutter button is pressed, recordings are made of up to 7 pictures with different exposure settings based on the Exposure Compensation range.

Example of Auto Bracket recording when [Step] is set to [3·1/3] and [Sequence] is set to [0/-/+]



- 1 Press [] button (▼)
- 2 Press ◀▶ to select the Auto Bracket icon ([3·1/3], etc.) and press ▲
- 3 Press ◀▶ to select the compensation range and press [MENU/SET]

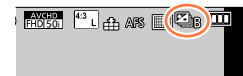
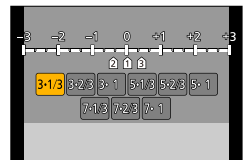
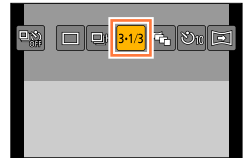

4 Focus on the subject and take a picture

- If you press and hold the shutter button, a burst of pictures can be recorded.
- The display of Auto Bracket flashes until all of the burst pictures you have set are recorded.
- The camera restarts recording from the first still picture if you change the Auto Bracket settings or turn off the camera before all of the burst pictures you have set are recorded.

■ To cancel [Auto Bracket]

In step 2, select [] ([Single]) or [] ([Off]).

Recording while exposure is changed automatically [Auto Bracket]



■ Changing the Single/Burst setting, compensation range, and recording sequence of Auto Bracket



① Set the menu

MENU →  **[Rec]** → **[Auto Bracket]**

② Press **▲▼** to select [Single/Burst Settings], [Step] or [Sequence] and press **[MENU/SET]**

③ Press **▲▼** to select the setting and press **[MENU/SET]**

[Single/Burst Settings]		(single)	[Step]	3·1/3	(3 pictures)	[Sequence]	0/-/+
		(burst)		3·2/3	(3 pictures)		-/0/+
				3·1	(3 pictures)		
				5·1/3	(5 pictures)		
				5·2/3	(5 pictures)		
				5·1	(5 pictures)		
				7·1/3	(7 pictures)		
				7·2/3	(7 pictures)		
				7·1	(7 pictures)		

- You can take one picture at a time when  is set.
- A burst of pictures can be recorded up to the number of pictures you have set when  is set.
- Close the menu after changing settings.

- When you take pictures using Auto Bracket after performing Exposure Compensation, the camera will take pictures using the corrected exposure value as a reference.

Not available in the following cases:

- The [Auto Bracket] is disabled in the following cases:
 - When the picture effect (Filter) is set ([Rough Monochrome], [Silky Monochrome], [Miniature Effect], [Soft Focus], [Star Filter], [Sunshine])
 - When White Balance Bracket is set
 - During motion picture recording
 - When [4K PHOTO] is set to [ON]
 - When recording using the flash
 - During T (time) recording
 - When [HDR] is set to [ON]
 - When [Multi Exp.] is set
 - When using [Time Lapse Shot]
 - When using [Stop Motion Animation] (only available with [Auto Shooting] setting)
 - When [Simultaneous record w/o filter] is set to [ON]

Automatically changing the aspect ratio while taking pictures [Aspect Bracket]

Recording mode: **iA** **P** **A** **S** **M**

When you press the shutter button once, the camera automatically takes four pictures with four types of aspect ratios (4:3, 3:2, 16:9, and 1:1). (The shutter sounds only once.)

1 Press [] button (▼)

2 Press ◀▶ to select the aspect bracket icon () and press [MENU/SET]

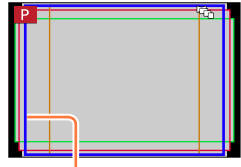

The range that can be recorded for each aspect ratio is displayed.

3 Focus on the subject and take a picture

■ To cancel aspect bracket

In step 2, select [] ([Single]) or [] ([OFF]).

- When [Picture Size] is set to [S], the setting is automatically changed to [M].
- The same shutter speed, aperture value, focus, [Exposure], [White Balance], and [Sensitivity] settings are used for all four pictures.

Not available in the following cases:

- The [Aspect Bracket] is disabled in the following cases:
 - When the picture effect (Filter) is set ([Rough Monochrome], [Silky Monochrome], [Toy Effect], [Toy Pop], [Miniature Effect], [Soft Focus], [Star Filter], [Sunshine])
 - During motion picture recording
 - When [4K PHOTO] is set to [ON]
 - During T (time) recording
 - When White Balance Bracket is set
 - When [Quality] is set to [RAW], [RAW] or [RAW]
 - When using [Time Lapse Shot]
 - When using [Stop Motion Animation] (only available with [Auto Shooting] setting)
 - When [HDR] is set to [ON]
 - When [Multi Exp.] is set
 - When [Simultaneous record w/o filter] is set to [ON]

Taking pictures with self-timer

Recording mode: **iA P A S M**

We recommend using a tripod. This is also effective for preventing jitter when pressing the shutter button, by setting the self-timer to 2 seconds.

1 Press [] button (▼)

2 Press ◀▶ to select the self-timer icon ([], etc.) and press ▲

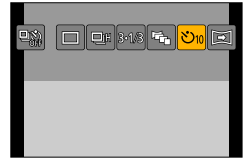

3 Press ◀▶ to select the self-timer operation setting and press [MENU/SET]



	The shutter is activated after 10 seconds.
	The shutter is activated after 10 seconds and three pictures are taken at intervals of approximately 2 seconds.
	The shutter is activated after 2 seconds.

- You can also set the time for the self-timer using [Self Timer] in the [Rec] menu.

4 Press the shutter button halfway to focus, then press it fully to start recording

- The focus and exposure are fixed when the shutter button is pressed halfway.
- After the self-timer indicator flashes, recording will start.

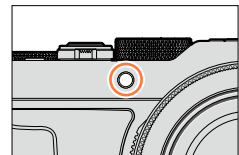

■ To cancel self-timer

In step **2**, select [] ([Single]) or [] ([Off]).

- You can cancel the self-timer by turning off the camera. (When [Self Timer Auto Off] (→50) is set to [ON].)

Taking pictures with self-timer

- If you take a picture with a flash when  is set, the flash output may not be stable in some cases.

 **Not available in the following cases:**

- It cannot be set to  in the following cases:
 - When White Balance Bracket is set
 - When [Multi Exp.] is set
 - During T (time) recording
- Self-timer is disabled in the following cases:
 - During motion picture recording
 - When [4K PHOTO] is set to [ON]
 - When using [Time Lapse Shot]
 - When using [Stop Motion Animation] (only available with [Auto Shooting] setting)

Recording panorama pictures

Recording mode: **iA P A S M**

You can easily record a panorama picture by panning the camera towards the direction you want to record, and automatically combining the burst of pictures taken during that time.

- 1** Press [] button (▼)
- 2** Press ◀▶ to select the panorama icon ([], etc.) and press ▲
- 3** Press ◀▶ to select the recording direction and then press [MENU/SET]

Left → Right	A horizontal guide line is displayed.
Right → Left	
Down → Up	A vertical guide line is displayed.
Up → Down	

- You can also select the recording direction using [Panorama Direction] in the [Rec] menu.



Applying a picture effect (Filter)

- ① Press the [FILTER] button to select a picture effect (→89)
 - Ⓐ Recording direction
 - Ⓑ Picture effects
(This is not displayed when [No Effect] is selected.)
 - Ⓒ Adjusting the picture effect
(This is displayed only when a picture effect is selected.)
 - You can also set the picture effects by turning the control ring.
 - [Toy Effect], [Toy Pop], [Miniature Effect], and [Sunshine] are not available.
 - When recording panorama pictures, the following effects are not applied to the recording screen.
 - [Rough Monochrome], [Silky Monochrome], [Soft Focus], [Star Filter]
- ② Press [MENU/SET]



- 4** Press the shutter button halfway to focus

Recording panorama pictures

5 Press the shutter button fully and pan the camera in a small circular motion to the recording direction to start recording

Taking pictures from left to right



Recording direction and progress status (approximate)

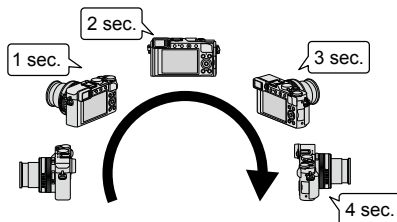

- Pan the camera at a constant speed.
- You may not be able to take pictures successfully if you move the camera too quickly or too slowly.

6 Press the shutter button fully again to end recording

- You can also end recording if you stop panning the camera while taking pictures.
- Recording can also be ended by moving the camera to the end of the guide.

**Tips**

- Pan the camera in the recording direction as steadily as possible.

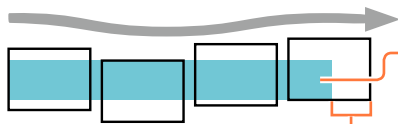

If the camera shakes too much, it may not be able to take pictures or may end up creating a narrow (small) panorama picture.

Pan the camera to a point slightly ahead of the point that you want to take. (However, the last frame is not recorded to the end.)

Recording panorama pictures

About panorama picture playback

Panorama pictures can be enlarged by operating the zoom lever the same way as with other still pictures. If you play back panorama pictures in the same way as playing back a motion picture, the panorama pictures are scrolled automatically. (→70)



- Unlike motion picture playback, you cannot perform fast forward or fast rewind while the panorama pictures are scrolling automatically. (You can perform single-frame forward or rewind while the automatic scrolling operation is paused.)

To cancel

In step 2, select [□] ([Single]) or [] ([Off]).

- The zoom position is fixed to the W end.
- [Stabilizer] does not work when it is set to [] (Normal).
- Since the aperture value and shutter speed are automatically controlled during panorama picture recording, settings made by the aperture ring or shutter speed dial are disabled.
- The focus, exposure and White Balance are all fixed to optimal values for the first picture. If the focusing or brightness of pictures recorded as part of a panorama picture after the first picture are significantly different from those of the first picture, the panorama picture as a whole (when all pictures are stitched together) may not have consistent focus and brightness.
- When the picture effect (Filter) is set, [White Balance] is fixed to [AWB].
- Since several pictures are stitched together to create a panorama picture, some subjects may be distorted or the joining portions of successively taken pictures that are stitched may be noticeable.
- The number of recording pixels per horizontal line and vertical line of a panorama picture varies depending on the recording direction and number of stitched pictures.
The maximum number of recording pixels is as follows:
 - Taking pictures in landscape orientation: Approx. 8176×1920
 - Taking pictures in portrait orientation: Approx. 2560×7680
- [Shutter Type] is fixed to [AUTO].

 Not available in the following cases:

- You cannot record a panorama picture in the following cases.
 - When White Balance Bracket is set
 - When [Quality] is set to [RAW , [RAW ] or [RAW]
 - When [HDR] is set to [ON]
 - When [Multi Exp.] is set
 - During T (time) recording
 - When using [Time Lapse Shot]
 - When using [Stop Motion Animation]
 - When [Silent Mode] is set
 - When the [Simultaneous record w/o filter] is set to [ON]
 - When [4K PHOTO] is set to [ON]
- Panorama pictures may not be created or pictures may not be recorded properly when taking pictures of the following subjects or when taking pictures in the following recording conditions:
 - Subjects that have a continuous monotone or pattern (sky, beach, etc.)
 - Moving subjects (person, pet, vehicle, waves, or flowers swaying in the wind, etc.)
 - Subjects whose colours or patterns change quickly (such as an image appearing on a display)
 - Dark locations
 - Locations with a flickering light source (fluorescent lamp, candle light, etc.)

Taking pictures automatically at set intervals

[Time Lapse Shot]

Recording mode: **[iA] [P] [A] [S] [M]**

You can preset data such as recording start time and time lapse to take still pictures automatically. This setting is convenient for taking pictures at constant intervals for landscape scenes, observation of the gradual changes in animals/plants, and other applications. The pictures are recorded as a single group picture (→201). When [Time Lapse Video] in the [Playback] menu is used, you can create a motion picture. (→215)

- Complete the date and time settings in advance. (→29)

1 Set the menu

[MENU] → **[Rec]** → **[Time Lapse Shot]**

2 Press ▲▼ to select the item and press [MENU/SET]

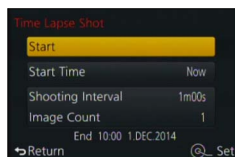

[Start Time]	[Now]	Starts the recording by fully-pressing the shutter button.
	[Start Time Set]	Set the time to start recording. Any time up to 23 hours 59 minutes ahead can be set. Press ◀▶ to select the item (hour and/or minute), and ▲▼ to set the start time, and then press [MENU/SET]
[Shooting Interval] / [Image Count]	<p>The recording interval and the number of pictures can be set.</p> <p>◀▶ : Select the item (minute/second/number of pictures)</p> <p>▲▼ : Setting</p> <p>[MENU/SET]: Set</p> <ul style="list-style-type: none"> • You can set the interval from 1 second to 99 minutes 59 seconds in 1-second intervals. • You can set the number of pictures to be recorded from 1 picture to 9,999 pictures. <hr/> <ul style="list-style-type: none"> • Be sure to use an interval (A) setting that is longer than the exposure time (shutter speed) (B). (Illustration below) <p>If the interval (A) setting is shorter than the exposure time (shutter speed) (B) (e.g. recording at night), it may cause the recording to skip.</p>	
<p style="text-align: center;">First Second Third</p>		

3 Press ▲▼ to select [Start] and press [MENU/SET]

Taking pictures automatically at set intervals [Time Lapse Shot]

4 Press the shutter button fully

- The recording starts automatically.
- During recording standby, the camera turns off automatically when no operation is performed for a preset interval. The [Time Lapse Shot] recording will continue even if the camera is turned off, and the camera is automatically turned on at the recording start time. If you want to turn on the camera manually, press the shutter button halfway.
- When you press the [Fn2] button while the camera is turned on, the pause or end selection screen will appear. Perform the operation based on the instructions on the screen. When you press the [Fn2] button while the camera is in the pause state, the restart or end selection screen will appear. You can also restart the operation from the pause state by fully pressing the shutter button.
- When a confirmation screen for continuing the creation of a motion picture is displayed, select [Yes].

5 Select the motion picture creation method

- [Rec Format]: [MP4]

[Rec Quality]	Sets the picture quality of the motion picture. [4K/25p] / [4K/24p] / [FHD/50p] / [FHD/25p] / [HD/25p] / [VGA/25p]
[Frame Rate]	Set the number of frames per second. When you set a higher number, you can create a more seamless stop motion animation. [50fps]* / [25fps] / [12.5fps] / [8.3fps] / [6.25fps] / [5fps] / [2.5fps] / [1fps] * Only available with [FHD/50p] setting • You can set the number of frames to [24fps], [12fps], [8fps], [6fps], [4.8fps], [2.4fps], or [1fps] when [Rec Quality] is set to [4K/24p].
[Sequence]	[NORMAL]: Stitches the still pictures in the recording sequence. [REVERSE]: Stitches the still pictures in the reverse order of recording.

6 Use ▲ ▼ to select [OK] and press [MENU/SET]

- A confirmation screen is displayed. If you select [Yes], the operation is executed.
- You can also create a motion picture using [Time Lapse Video] in the [Playback] menu. (→215)

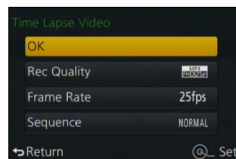

Taking pictures automatically at set intervals [Time Lapse Shot]

- This function is not intended for application-specific systems (monitoring cameras).
- **If you leave the camera unattended during [Time Lapse Shot] recording, make sure that the camera is not stolen.**
- **Exercise caution when you perform [Time Lapse Shot] recording for a long period of time in cold regions or in a low-temperature or high-temperature/high-humidity environment, since such use could cause malfunctions.**
- The camera may not be able to record using the preset interval and number of pictures to be recorded under some recording conditions.
- If the recording time is longer than the preset interval due to a long exposure, this may cause the recording to skip.
- Use a sufficiently charged battery or an AC adaptor (optional) and DC coupler (optional).
- [Time Lapse Shot] is paused in the following cases:
 - When the remaining battery power runs out
 - Turning the camera off

If this occurs during [Time Lapse Shot] recording, you can restart the operation by replacing the battery or card in the pause state and turning the Camera [ON/OFF] switch to [ON]. (Note, however, that the pictures recorded after restarting the operation are saved as another group picture.) When you replace the battery or card, turn the Camera [ON/OFF] switch to [OFF].

- Do not connect the AV cable (optional), HDMI micro cable or USB connection cable (supplied) during [Time Lapse Shot] recording.
- When you select the picture quality for an aspect ratio that is different from the original picture, the picture will be displayed with a black band on the upper/lower side or the left/right side of a stop motion animation.
- If the power supply is cut off due to a power outage or AC adaptor disconnection while a motion picture is being recorded using the AC adaptor (optional), that motion picture will not be recorded.
- You cannot create a motion picture that is longer than 29 minutes 59 seconds, or whose file exceeds 4 GB.
- When a stop motion animation is shorter than 2 seconds, “2s” will be displayed for the motion picture recording time (→70).
- When the number of recorded pictures is one, it will not be saved as a group picture.

**Not available in the following cases:**

- [Time Lapse Shot] cannot be used in the following cases:
 - During panorama picture recording
 - When [Multi Exp.] is set
 - When using [Stop Motion Animation]
 - When the [Simultaneous record w/o filter] is set to [ON]

Creating stop motion animation [Stop Motion Animation]

Recording mode: **[iA] [P] [A] [S] [M]**

You can stitch still pictures to create stop motion animation.

- **Complete the date and time settings in advance.** (→29)
- Still pictures that were captured using frame-by-frame recording are grouped into a single group picture. (→201)



Before creating stop motion animation

When you use [Stop Motion Animation] to record still pictures by moving a subject such as a doll little by little and then stitching those pictures, you can create a stop motion animation as if the subject is moving.

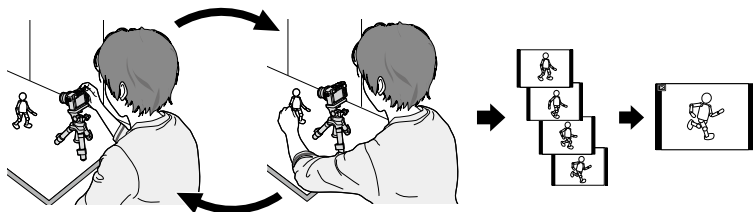

- To create stop motion animation using this camera, it is necessary to record 1 to 50 frames of still pictures for every 1 second of motion picture.
- To produce smooth movement of the subject, record the motion using as many frames as possible and set a higher number of frames per second (frame rate) when you create a stop motion animation.

1 Set the menu

[MENU] → [Rec] → [Stop Motion Animation]

2 Press ▲▼ to select the recording method, and press [MENU/SET]

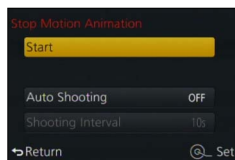

[Auto Shooting]	[ON]	Takes pictures automatically at a set recording interval. When the shutter button is pressed fully, recording starts.
	[OFF]	Takes pictures manually, one frame at a time.
[Shooting Interval]	<p>(Available only when [Auto Shooting] is set to [ON]) Set the interval used for [Auto Shooting]. You can set the interval from 1 second to 60 seconds in 1-second intervals. Press ◀▶ to select the interval (seconds), press ▲▼ to set the selected time, and then press [MENU/SET]</p>	

Creating stop motion animation [Stop Motion Animation]

3 Press ▲ ▼ to select [Start] and press [MENU/SET]

4 Press ▲ ▼ to select [New] and press [MENU/SET]

5 Press the shutter button fully

- Up to 9,999 frames can be recorded.

6 Move the subject to decide on the composition

- Repeat the recording of still pictures in the same way.
- When you turn off the camera during recording, a message to restart recording will appear when you turn on the camera. To start recording from the next still picture, select [Yes].



How to create stop motion animation effectively

- Up to two previously recorded pictures are displayed on the recording screen. Check this screen as a guideline for determining the amount of required motion.
- You can press the Playback button to check the recorded pictures. Press the [⏮/⏪] button to delete unnecessary pictures. To return to the recording screen, press the Playback button again.

7 Press [MENU/SET] to end recording. Next, select [Stop Motion Animation] in the [Rec] menu and then press [MENU/SET] again

- A confirmation screen is displayed. It is ended when [Yes] is selected.
- A confirmation screen for creating a motion picture is displayed next, so select [Yes].

8 Select a method to create a stop motion animation

- [Rec Format]: [MP4]

[Rec Quality]	Sets the picture quality of the motion picture. [4K/25p] / [4K/24p] / [FHD/50p] / [FHD/25p] / [HD/25p] / [VGA/25p]
[Frame Rate]	Set the number of frames per second. When you set a higher number, you can create a more seamless stop motion animation. [50fps]* / [25fps] / [12.5fps] / [8.3fps] / [6.25fps] / [5fps] / [2.5fps] / [1fps] * Only available with [FHD/50p] setting • You can set the number of frames to [24fps], [12fps], [8fps], [6fps], [4.8fps], [2.4fps], or [1fps] when [Rec Quality] is set to [4K/24p].
[Sequence]	[NORMAL]: Stitches the still pictures in the recording sequence. [REVERSE]: Stitches the still pictures in the reverse order of recording.

Creating stop motion animation [Stop Motion Animation]

9 Press ▲ ▼ to select [OK] and press [MENU/SET]

- A confirmation screen is displayed. If you select [Yes], the operation is executed.
- You can also create a stop motion animation using [Stop Motion Video] in the [Playback] menu. (→215)

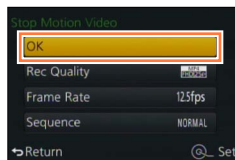

■ Adding pictures to an already recorded stop motion animation group

When you select [Additional] in step 4, group pictures recorded using [Stop Motion Animation] are displayed. Select a group picture and press [MENU/SET]. Then, select [Yes] on the confirmation screen.

- [Auto Shooting] may not be performed according to the preset interval because recording could take time under some recording conditions, such as when pictures are taken using a flash.
- When you select the picture quality for an aspect ratio that is different from the original picture, the picture will be displayed with a black band on the upper/lower side or the left/right side of a stop motion animation.
- When you select the picture quality for an aspect ratio that is different from the original picture, this will produce grainy pictures in a stop motion animation.
- Use a sufficiently charged battery or an AC adaptor (optional) and DC coupler (optional).
- If the power supply is cut off due to a power outage or AC adaptor disconnection while a motion picture is being recorded using the AC adaptor (optional), that motion picture will not be recorded.
- You cannot create a motion picture that is longer than 29 minutes 59 seconds, or whose file exceeds 4 GB.
- When a stop motion animation is shorter than 2 seconds, “2s” will be displayed for the motion picture recording time (→70).
- If only one still picture is recorded, it will not be recorded as a group picture. You cannot select only one recorded still picture using [Additional].

ⓘ Not available in the following cases:

- [Stop Motion Animation] cannot be used in the following cases:
 - During panorama picture recording
 - When [Multi Exp.] is set
 - When using [Time Lapse Shot]
 - When the [Simultaneous record w/o filter] is set to [ON]

Performing multiple exposures for a single picture

[Multi Exp.]

Recording mode: **iA P A S M**

You can create an effect similar to the operation of up to four times of exposure on a single picture.

1 Set the menu

MENU → **[Rec]** → **[Multi Exp.]**

2 Press **▲▼** to select **[Start]** and press **[MENU/SET]**

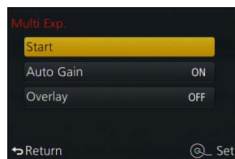

3 Decide on your composition and take the first picture

- After recording the first picture, press the shutter halfway to proceed to the next recording.
- Press **▲▼** to select the item and then press **[MENU/SET]**. You can perform the following operations.
 - **[Next]**: Proceed to the next recording.
 - **[Retake]**: Delete the result of the last shot and take another picture.
 - **[Exit]**: Exit Multi Exposure and save the picture that was taken.

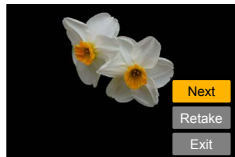

4 Record the second, third, and fourth pictures

- When you press **[Fn1]** button while taking pictures, the pictures that you took are saved and Multi Exposure is closed.

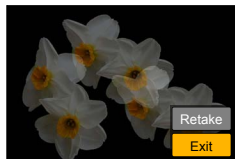

5 Press **▼** to select **[Exit]** and press **[MENU/SET]**

- You can also end the operation by pressing the shutter button halfway.

Performing multiple exposures for a single picture [Multi Exp.]

■ About the automatic gain compensation setting

Select [Auto Gain] on the screen in step **2** (→159).

- **[ON]:** Combines several pictures into one by automatically adjusting the brightness in accordance with the number of pictures taken.
- **[OFF]:** Combines several pictures into one by simply overlapping the exposure results of all pictures, as is. Perform the Exposure Compensation based on the requirements of a subject.

■ To overlay the pictures on the RAW file picture in a card

Set [Overlay] to [ON] on the screen in step **2** (→159). After selecting [Start], the pictures on a card will be displayed. Select the RAW file pictures and press [MENU/SET] to continue recording.

- You can perform [Overlay] on RAW file pictures recorded using this camera only.

- Pictures are not saved in memory until Multi Exposure is ended.
- Information for the picture taken last will be used as recording information of pictures taken using Multi Exposure.
- While [Multi Exp.] recording is being performed, you cannot set items displayed in grey on the menu screen.

**Not available in the following cases:**

- [Multi Exp.] cannot be used in the following cases:
 - When the picture effect (Filter) is set
 - During panorama picture recording
 - When using [Time Lapse Shot]
 - When using [Stop Motion Animation]

Disabling the beeps and flash at the same time

[Silent Mode]

Recording mode: **[iA] [P] [A] [S] [M]**

This mode is useful when you are taking pictures in a quiet environment or public facilities or when you take pictures of a subject such as a baby or animal.

1 Set the menu

MENU → **ƒC [Custom]** → **[Silent Mode]**

Settings: [ON] / [OFF]

- This mode will mute beeps, set the flash to [Forced Flash Off], and disable AF Assist Lamp. The settings for the following functions are fixed:
 - [Shutter Type]: [ESHTR]
 - [Flash Mode]: [] (Forced Flash Off)
 - [AF Assist Lamp]: [OFF]
 - [Beep Volume]: [] (Off)
 - [Shutter Vol.]: [] (Off)

- Even when this mode is set to [ON], the following lamps/indicators will light or flash.
 - Self-timer indicator
 - Wi-Fi connection lamp
- The operation sounds of this camera such as the lens aperture sound are not muted.
- **Be sure to pay special attention to the privacy, likeness rights, etc. of a subject when you use this function. Use at your own risk.**

Recording with the Face Recognition function

[Face Recog.]

Recording mode:

The Face Recognition function recognises a face similar to a registered face and automatically adjusts focus and exposure for the face with higher priority. Even if a person you want to focus on is standing at the back or corner in a group photo, the camera will automatically recognise the person and record this person's face clearly.

1 Set the menu

MENU → **[Rec]** → **[Face Recog.]**

Settings: **[ON]** / **[OFF]** / **[MEMORY]**

Default [Face Recog.] setting is [OFF].

When the face pictures are registered, the setting will be [ON] automatically.

■ How the Face Recognition function works

During recording

- The camera recognises a registered face and adjusts focus and exposure.
- When registered faces that have set names are recognised, the names are displayed (max. 3 people).

During playback

- The name and age are displayed (if information is registered).
- The names that have been set for the recognised faces are displayed (max. 3 people).
- Only pictures of the selected registered people are played back ([Category Play]).

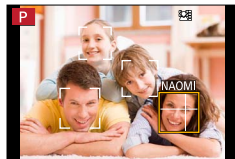

- **[Face Recog.] functions only when Auto Focus mode is set to .**
- Only the first picture of the burst recording will contain Face Recognition information.
- The name of the person recognised in the first picture is displayed in the case of group pictures.
- Face Recognition searches for faces similar to those registered, but there is no guarantee it will always recognise these faces. In some cases, the camera cannot recognise or incorrectly recognises even registered people depending on their expression or the environment.
- Even if Face Recognition information is registered, pictures recorded when the name is [OFF] are not categorised for Face Recognition in [Category Play].
- **Even if Face Recognition information is changed, Face Recognition information for previously recorded pictures is not changed.**
For example, if a name is changed, pictures recorded before the change are not categorised for Face Recognition in [Category Play].
- To change name information for pictures already recorded, perform a [REPLACE] (→222) in [Face Rec Edit].

Recording with the Face Recognition function [Face Recog.]

 **Not available in the following cases:**

- [Face Recog.] cannot be set in the following cases:
 - During panorama picture recording
 - When the picture effect (Filter) is set ([Miniature Effect])
 - During motion picture recording
 - When using [Time Lapse Shot]

Registering face pictures

Up to 6 people's face pictures can be registered along with such information as name and birthdate.

Recording tips when registering face pictures

- Make sure the subject's eyes are open and mouth closed; have the subject face the camera directly, and make sure the outline of the face, the eyes and eyebrows are not hidden by hair.
- Make sure there are no heavy shadows on the face. (During registration, the flash is not used.)

Good example for registering a face

**If the camera seems to have difficulty recognising faces when recording**

- Register additional pictures of the same person's face, indoors and outdoors or with different expressions or angles.
- Register additional pictures at the place you are recording.
- If a registered person is no longer recognised, re-register that person.

1 Use ▲ ▼ to select [MEMORY] and then press [MENU/SET]**2 Use ▲ ▼ ◀ ▶ to select [New] and then press [MENU/SET]**

- If 6 people are already registered, first delete a registered person. (→164)

3 Align the face with the guide and record

- A confirmation screen is displayed. If you select [Yes], the operation is executed.
- Faces of subjects other than people (e.g. pets) cannot be registered.
- When ▶ is pressed, an explanation is displayed.

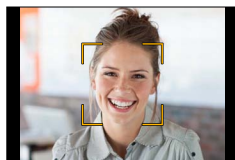
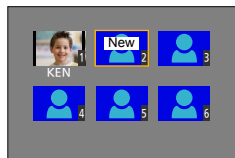

Recording with the Face Recognition function [Face Recog.]

4 Use ▲ ▼ to select the item for editing and press [MENU/SET]

[Name]	① Use ▼ to select [SET] and then press [MENU/SET] ② Enter the name (See "Entering Text": (→52))
[Age]	Set the birthdate. ① Use ▼ to select [SET] and then press [MENU/SET] ② Use ◀▶ to select year, month and day, set with ▲▼, and press [MENU/SET]
[Add Images]	Up to 3 face pictures of the person can be registered. ① Use ◀▶ to select [Add] and press [MENU/SET] <ul style="list-style-type: none"> • If only one picture is registered, you can skip the cursor button operation. Just press [MENU/SET] to register an additional face picture. • When a registered face picture is selected with cursor button, a screen to confirm deletion is displayed. Select [Yes] to delete the face picture. (If only one picture is registered, it cannot be deleted.) ② Record the picture (step 3 (→163))

Editing or deleting information about registered persons

Information about registered people can be edited or deleted.

1 Use ▼ to select [MEMORY] and then press [MENU/SET]**2 Use ▲ ▼ ◀▶ to select the picture of the person to be edited or deleted and press [MENU/SET]****3 Use ▲ ▼ to select the item and press [MENU/SET]**

[Info Edit]	Edit name or other registered information. (Step 4 above)
[Priority]	Set priority order for focus and exposure. ① Use ▲ ▼ ◀▶ to select the registration order and press [MENU/SET]
[Delete]	Delete information and face pictures of registered persons. <ul style="list-style-type: none"> • A confirmation screen is displayed. If you select [Yes], the operation is executed.

Setting the profile for a baby or pet to record in a picture

Recording mode: **IA P A S M**

You can set a name or birthday of a baby or pet before taking a picture to record the name or age in months/years in the picture.

■ Setting the name and age in months/years

① Set the menu

MENU → [Rec] → **[Profile Setup]**

Settings: [¹] ([Baby1]) / [²] ([Baby2]) / [] ([Pet]) / [OFF] / [SET]

② Use **▲▼** to select [SET] and then press [MENU/SET]

③ Use **▲▼** to select [Baby1], [Baby2] or [Pet] and then press [MENU/SET]

④ Use **▲▼** to select [Age] or [Name] and then press [MENU/SET]

⑤ Use **▲▼** to select [SET] and then press [MENU/SET]

Age: Set birthday with **▲▼◀▶**, and press [MENU/SET]

Name: (See "Entering Text": (→52))

⑥ Use **▼** to select [Exit] and then press [MENU/SET] to finish

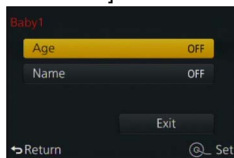

■ Cancelling the display of the name and age in months/years

Select [OFF] in step ④.

- [Age] and [Name] print setting can be made on your computer using "PHOTOfunSTUDIO" on the supplied DVD. Text may also be stamped onto the still picture using [Text Stamp].

Not available in the following case:

- You cannot record the name or age in months/years in still pictures that are taken while recording motion pictures ((motion picture priorities)) (→198).



Displaying the appropriate screen for specific recording conditions

Checking the area where overexposure may occur ([Zebra Pattern])

Recording mode: **IA P A S M**

You can check the area in a picture that is brighter than a certain brightness, which could result in overexposure, by displaying such an area using a zebra pattern. You can also set the brightness to be represented by the zebra pattern.

MENU → **fC** [Custom] → [Zebra Pattern]

[ZEBRA1]	Displays an area brighter than a certain brightness using a right-leaning zebra pattern.	
[ZEBRA2]	Displays an area brighter than a certain brightness using a left-leaning zebra pattern.	
[OFF]	—	
[SET]	<p>Sets the brightness to be displayed for each zebra pattern. [Zebra 1] / [Zebra 2]</p> <p>1 Use ▲ ▼ to select the brightness and then press [MENU/SET]</p> <ul style="list-style-type: none"> The range of brightness you can select from is [50%] to [105%]. The [OFF] setting is available for [Zebra 2]. When [100%] or [105%] is selected, only the overexposed areas are displayed with the zebra pattern. When a smaller numeric value is set, the range of brightness to be displayed by each zebra pattern will increase. 	

Displaying the appropriate screen for specific recording conditions

- If there is overexposure, we recommend taking pictures using a lower exposure value (→135), using the histogram (→64) as a guideline.
- The displayed zebra pattern is not recorded.
- If you set [Zebra Pattern] to [Fn Button Set] (→37) in the [Custom] menu, every time you press the assigned function button the setting will switch in the following order: [Zebra 1] → [Zebra 2] → [Zebra OFF]. When [ZEBRA2] is set to [OFF], you can switch the setting quickly in the following order: [Zebra 1] → [Zebra OFF].

Setting a monochrome display for the recording screen ([Monochrome Live View])

Recording mode: **iA P A S M**

You can display the recording screen in black and white. This function is useful when a black and white screen will make it easier to adjust focus in Manual Focus mode.

MENU → **fC** [Custom] → **[Monochrome Live View]**

Settings: **[ON] / [OFF]**

- This does not affect recorded pictures.

Correcting jitter



Recording mode: **IA P A S M**

Automatically detects and prevents jitter.

1 Set the menu

MENU →  **[Rec]** → **[Stabilizer]**

2 Use ▲ ▼ to select the item and press **[MENU/SET]**



 (Normal)	Corrects vertical and horizontal jitter.
 (Panning)	Corrects vertical jitter. This setting is ideal for panning (technique of recording a subject by matching the camera movement with the movement of a subject going in a specific direction).
[OFF]	[Stabilizer] does not work.

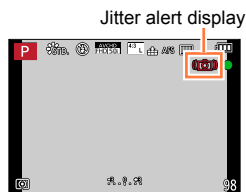

To prevent jitter

If a warning is displayed about jitter, use [Stabilizer], a tripod, or [Self Timer]. In some cases, jitter can be reduced by using a higher setting for [Sensitivity].



- When you use a tripod, we recommend setting [Stabilizer] to [OFF].
- To perform a panning by selecting [, we recommend taking pictures using the viewfinder.
- Cases where the stabiliser function may be ineffective:
 - When there is a lot of jitter
 - When the zoom magnification is high (also in the Digital Zoom range)
 - When taking pictures while following a moving subject
 - When the shutter speed becomes slower to take pictures indoors or in dark places
- The panning effect by selecting [] is not fully achieved in the following cases:
 - Bright summer days or other bright locations
 - When the shutter speed is higher than 1/100 seconds
 - When the motion of a subject is slow and the speed with which the camera is moved is too slow (a nice background blur is not achieved)
 - When the camera is not adequately tracking the motion of a subject

**Not available in the following case:**

- [Stabilizer] cannot be used by selecting [] (Normal) during panorama picture recording.

Using Zoom

Recording mode: **[iA] [P] [A] [S] [M]**

You can adjust the area of a picture to be taken using zoom.

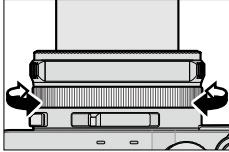
Zoom lever	Control ring
<p>① Move the zoom lever</p> 	<p>① Turn the control ring*</p>  <p>* You can perform zoom operation by assigning the [Zoom] setting to the control ring. (→40)</p>
<p>T side : Telephoto, Enlarge the subject W side : Wide-angle, Capture a wider area</p>	<p>Clockwise: Telephoto, Enlarge the subject Counterclockwise: Wide-angle, Capture a wider area</p>

The illustration is an example of when using Optical Zoom, [i.Zoom], and [Digital Zoom] in [Program AE] Mode.

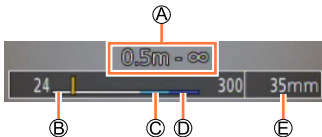

- Ⓐ Focus range
- Ⓑ Optical Zoom range
- Ⓒ i.Zoom range
- Ⓓ Digital Zoom range
- Ⓔ Current zoom position (Focal lengths the same as those of a 35 mm film camera)

- Do not touch the lens barrel during zooming.
- Adjust the focus after adjusting the zoom.
- The zoom ratio and the zoom bar displayed on the screen are estimates.
- The camera may make a rattling noise and vibrate when the zoom lever is operated - this is not a malfunction.

Zoom types and use

The zoom ratio changes when the picture size is changed.

Optical Zoom

You can zoom in without degrading the picture quality.

Maximum magnification: 3.1x



Not available in the following case:

- During panorama picture recording

Extra optical zoom

This function works when picture sizes with [EX] have been selected in [Picture Size] (→108). Extra optical zoom allows you to zoom in using a higher zoom ratio than Optical Zoom, without degrading the picture quality.

Maximum magnification: 6.2x

(Including the optical zoom ratio. This maximum zoom ratio varies depending on the picture size.)







Not available in the following cases:

- When the picture effect (Filter) is set ([Toy Effect], [Toy Pop])
- During panorama picture recording
- When [Burst Rate] is set to [SH]
- When [HDR] is set to [ON]
- When [Multi Exp.] is set
- When [iHandheld Night Shot] is set to [ON]
- When [iHDR] is set to [ON]
- When the [Quality] setting is set to [RAW:⚡], [RAW:⚡] or [RAW]
- During motion picture recording

To increase the zoom ratio further, the following zoom can be used in combination.

[i.Zoom]

Recording mode:     

You can use the camera's Intelligent Resolution technology to increase the zoom ratio up to 2x higher than the original zoom ratio with limited deterioration of picture quality.

MENU →  **[Rec]** → **[i.Zoom]** → **[ON]** / **[OFF]**

MENU →  **[Motion Picture]** → **[i.Zoom]** → **[ON]** / **[OFF]**



Not available in the following cases:

- When the picture effect (Filter) is set ([Impressive Art], [Toy Effect], [Toy Pop])
- During panorama picture recording
- When [Burst Rate] is set to [SH]
- When [HDR] is set to [ON]
- When [Multi Exp.] is set
- When [iHandheld Night Shot] is set to [ON]
- When [iHDR] is set to [ON]
- When the [Quality] setting is set to [RAW⁺], [RAW⁺] or [RAW]

[Digital Zoom]

Recording mode:

Zoom 4x further than Optical/Extra optical zoom. Note that, with Digital Zoom, enlarging will decrease picture quality.

MENU → **[Rec]** → **[Digital Zoom]** → **[ON] / [OFF]**

MENU → **[Motion Picture]** → **[Digital Zoom]** → **[ON] / [OFF]**

- When [Digital Zoom] is used simultaneously with [i.Zoom], you can only increase the zoom ratio up to 2x.
- When using [Digital Zoom], we recommend using a tripod and the self-timer (→148) for taking pictures.
- The AF area is largely displayed at the centre in the Digital Zoom range.

**Not available in the following cases:**

- When the picture effect (Filter) is set ([Impressive Art], [Toy Effect], [Toy Pop], [Miniature Effect])
- During panorama picture recording
- When [Burst Rate] is set to [SH]
- When [HDR] is set to [ON]
- When [Multi Exp.] is set
- When the [Quality] setting is set to [RAW], [RAW] or [RAW]

[Step Zoom]

Recording mode: **[A] [P] [A] [S] [M]**

You can set the zoom operation to allow easy visualisation of the angle of view (picture angle) for the focal length of a regular fixed focal length lens (as with a 35 mm film camera). When using the [Step Zoom], you can operate the zoom ratio as easily as changing the camera lens.

1 Turn the control ring (→39)

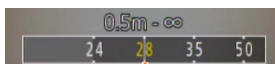

Current zoom position
(Focal lengths the same as those of a 35 mm film camera)

■ Using the zoom lever for [Step Zoom]

You can use the zoom lever for [Step Zoom] by setting [Zoom lever] to [Step Zoom] in the [Custom] menu.

- The focal length values are for reference only.

⊘ Not available in the following case:

- During motion picture recording

Changing the zoom operation settings

MENU → **fC** [Custom] → [Zoom lever]

MENU → **fC** [Custom] → [Control Ring]

Q Zoom	The zoom operates in the normal way.
Q Step Zoom	Each time zoom is operated, the zoom stops at the position for one of the preset focal lengths.

Retaining the zoom position when the camera is turned off

MENU → **fC** [Custom] → [Zoom Resume] → [ON] / [OFF]

Taking pictures using the flash (supplied)

Recording mode: **[iA] [P] [A] [S] [M]**

When the flash (supplied) is attached, you can use all flash modes ([MANUAL] setting, etc.) available for this unit. (Note, however, that this flash cannot be used as a wireless flash unit.) This section describes how to take a picture using the flash (supplied).

- For details on how to take a picture using the external flash (optional), refer to (→291).

With the flash you can take pictures in dark places or adjust the entire contrast of a picture by illuminating a subject with a bright background.

Attaching the flash

The hot shoe cover is already attached to the hot shoe at the time of purchase. Attach the flash to the hot shoe after removing the hot shoe cover.

Removing the hot shoe cover

- Make sure that the Camera [ON/OFF] switch is set to [OFF].

1 Remove the hot shoe cover by pulling it in the direction indicated by arrow ② while pressing it in the direction indicated by arrow ①

- Be sure to attach the hot shoe cover when the hot shoe is not in use.
- Keep the hot shoe cover safely after removing it so that you do not lose it.

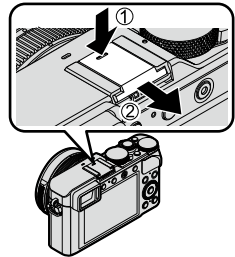

Attaching the flash

1 Turn off the flash

2 Firmly insert the flash into the hot shoe of this unit until it clicks

- Set the Camera [ON/OFF] switch to [ON] and turn on the flash when you take a picture.

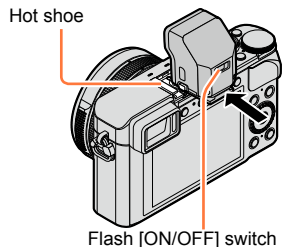

- Keep the hot shoe cover out of reach of children to prevent swallowing.
- Do not carry the camera holding by the flash when the flash is mounted on the camera.

Taking pictures using the flash (supplied)

■ Removing the flash

- ① Turn off the camera and the flash
- ② Press and hold the lock release button and pull the flash in the direction indicated by the arrow to detach the flash
 - When detaching the flash, do so slowly and carefully.
 - Attach the hot shoe cover to the hot shoe of the camera.
 - Store the detached flash in its soft case.

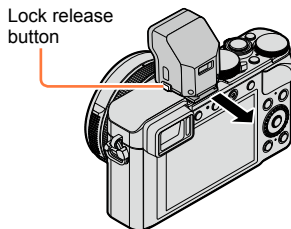

About [Forced Flash Off] ([⊕])

[⊕] (Forced Flash Off) will appear on the recording screen and the flash will not fire in the following cases.

Communication light emission with a wireless flash is also disabled. (→184)

- When the flash is not attached to the camera
- When the flash [ON/OFF] switch is set to [OFF] even if the flash is attached
- When the flash cannot be used to take pictures, for example, when recording motion pictures

■ The available flash range when [Sensitivity] setting is [AUTO]

Edges of picture may become slightly dark if using flash at short distances without using zoom (close to max. W). This may be remedied by using a little zoom.

Max. Wide	Max. Tele
Approx. 60 cm - 14.1 m (1.97 feet - 46 feet)*	Approx. 30 cm - 8.5 m (0.98 feet - 27.9 feet)*

*When the flash (supplied) is attached and [ISO Limit Set] is [OFF].

Taking pictures using the flash (supplied)

**How to use the flash effectively**

Taking a picture using the flash with the subject too close may cause overexposure. When you set [Highlight] in the [Custom] menu to [ON], the overexposed areas will flash black and white during [Auto Review] or playback. If that happens, we recommend taking the picture again, for example, after setting a lower flash output using [Flash Adjust.] (→183).

- Do not put your hands over the light-emitting area of the flash or look at it from close range. Do not use the flash at close distances to other subjects (heat/light may damage subject).
- Flash charging may take time if battery is low or if using flash repeatedly. When the flash is being charged, the flash icon flashes red, and you cannot take a picture even when you fully press the shutter button.
- The flash is fixed to [🚫] (Forced Flash Off) in following cases:
 - During motion picture recording
 - When the picture effect (Filter) is set
 - During panorama picture recording
 - When using the electronic shutter
 - When [HDR] is set to [ON]
 - When [Silent Mode] is set to [ON]

Taking pictures using the flash (supplied)

Changing the firing mode (Manual flash)

Recording mode: **P** **A** **S** **M**

You can select whether the flash output is set automatically or manually.

1 Set the menu

MENU → **[Rec]** → **[Flash]** → **[Firing Mode]**

2 Use ▲ ▼ to select the item and press [MENU/SET]

[TTL]	The camera automatically sets the flash output.
[MANUAL]	You can set the flash ratio manually. Using [TTL] allows you to take a picture as intended, even for dark scenes where the flash output tends to be higher.

- When [MANUAL] is selected, the flash ratio (e.g. [1/1]) is displayed with the flash icon on the screen.

■ Setting the flash ratio (When [MANUAL] is selected)

① Set the menu

MENU → **[Rec]** → **[Flash]** → **[Manual Flash Adjust.]**

② Press ◀▶ to select an item and press [MENU/SET]

- You can set the flash ratio from [1/1] (flash firing full power) to [1/64] in 1/3 steps.

Taking pictures using the flash (supplied)

Changing Flash Mode

Recording mode: **P** **A** **S** **M**

Set the flash to match the recording.

1 Set the menu

MENU → **[Rec]** → **[Flash]** → **[Flash Mode]**

2 Press ▲ ▼ to select the item and press [MENU/SET]

: [Forced Flash On] : [Forced On/Red-Eye]*	Always takes pictures using the flash. • Ideal for taking pictures with a backlight or when a subject is located under bright lighting such as a fluorescent light.
: [Slow Sync.] : [Slow Sync./Red-Eye]*	Takes brighter pictures such as pictures of subjects against a nightscape by decreasing the shutter speed when firing a flash. • Ideal for taking pictures of people against a nightscape.
: [Forced Flash Off]	Always takes pictures without flash under all recording conditions. • Ideal for taking pictures where the use of flash is prohibited.

* This is available only when [Wireless] in the [Flash] is set to [OFF] (→184) and [Firing Mode] is set to [TTL] (→179).

Two flashes will be emitted. Do not move until after the second flash. Interval between flashes varies according to brightness of subject.

- The red-eye reduction effect varies depending on the subject and is affected by factors such as distance from the subject and whether the subject is looking at the camera during the preliminary flash. In some cases, red-eye reduction may be negligible.

■ Reducing red-eye

Recording mode: **P** **A** **S** **M**

Automatically detects red-eye and corrects still picture data when recording with flash red-eye reduction (,).

MENU → **[Rec]** → **[Red-Eye Removal]**

Settings: [ON] / [OFF]

- When this function is set to [ON], the flash icon changes to /.



Not available in the following case:

- Depending on the circumstance, it may not be possible to correct red-eye.

Taking pictures using the flash (supplied)

■ Shutter speeds for each flash mode

Flash Mode	Shutter speed (seconds)
	1/60*1 - 1/4000

Flash Mode	Shutter speed (seconds)
	1 - 1/16000
	120*2 - 1/16000

*1 The shutter speed is set to 60 seconds in [Shutter-Priority] Mode and to T (time) in [Manual Exposure] Mode.

*2 The shutter speed is set to T (time) in [Manual Exposure] Mode.

- In [Intelligent Auto] Mode, shutter speed changes depending on the identified scene.

 ■ Flash settings for each Recording Mode (When the flash (supplied) is attached)
 (○: Available, -: Not available)

Recording Mode					
IA [Intelligent Auto] Mode	-*	-*	-*	-*	○
P [Program AE] Mode	○	○	○	○	○
A [Aperture-Priority] Mode	○	○	○	○	○
S [Shutter-Priority] Mode	○	○	-	-	○
M [Manual Exposure] Mode	○	○	-	-	○

*You cannot perform flash settings using the [Rec] menu. Set to [A], [SA], [S_{eye}] or [S_{eye}] depending on the subject and brightness.

- Flash settings may be changed when changing Recording Mode.
- Flash settings will be retained even if the camera is turned off.

Taking pictures using the flash (supplied)

Setting the 2nd curtain sync



Recording mode: **iA P A S M**

2nd curtain sync is a recording method in which the flash fires just before the shutter closes when you take a picture of a moving subject (such as a car) using the flash with a slow shutter speed.

1 Set the menu

MENU → **[Rec]** → **[Flash]** → **[Flash Synchro]**

2 Press ▲ ▼ to select the setting item and press [MENU/SET]

[1ST]	1st curtain sync is the normal recording method when using the flash.	
[2ND]	The light source is captured in back of the subject and this produces a picture that is vibrant and lively.	

- Normally, set to [1ST].
- If you set to [2ND], [2nd] will be displayed in the flash icon on the screen.
- [2ND] is available only when [Wireless] in the [Flash] is set to [OFF]. (→184)
- The [Flash Synchro] setting functions even when an external flash other than the supplied flash is used. (→291)
- When a fast shutter speed is set, the [Flash Synchro] effect may not be sufficiently achieved.
- When [2ND] is set, you cannot set the flash setting to [$\frac{1}{4}$ Ⓞ] or [$\frac{1}{5}$ Ⓞ].

Adjusting the flash output

Recording mode: **P** **A** **S** **M**

Adjust the flash output if a picture taken using the flash is too bright or too dark.

1 Set the menu

MENU → **[Rec]** → **[Flash]** → **[Flash Adjust.]**

2 Press ◀▶ to set the flash output and press [MENU/SET]

Settings: -3 EV to +3 EV (unit: 1/3 EV)

When you do not want to adjust the intensity of the flash, select [±0 EV].

- When the intensity of the flash is adjusted, [+] or [-] is displayed on the flash icon.
- [Flash Adjust.] is available only when [Wireless] in the [Flash] is set to [OFF] (→184) and [Firing Mode] is set to [TTL] (→179).
- The [Flash Adjust.] setting functions even when an external flash other than the supplied flash is used. (→291)

Synchronising the flash output with the camera during Exposure Compensation

Recording mode: **P** **A** **S** **M**

The flash output is automatically adjusted in accordance with the exposure compensation value.

MENU → **[Rec]** → **[Flash]** → **[Auto Exposure Comp.]**

Settings: **[ON]** / **[OFF]**

- About Exposure Compensation (→135)
- The [Auto Exposure Comp.] setting functions even when an external flash other than the supplied flash is used. (→291)

Performing wireless flash settings

Recording mode: **IA P A S M**

When you use the flashes (optional: DMW-FL360L, DMW-FL580L) with the wireless flash recording function, you can separately control the firing of the flashes in three groups and of the flash attached to the hot shoe of the camera.

Although the flash (supplied) is not equipped with the wireless flash recording function, it can be attached to the hot shoe of this unit and you can control the firing of the wireless flash.

Positioning the wireless flash

Position the wireless flash with its wireless sensor facing the camera. The following illustration is an example of the range within which the flash can be positioned. The flash controllable range varies depending on the surrounding environment.

Flash controllable range (when a supplied flash is attached)

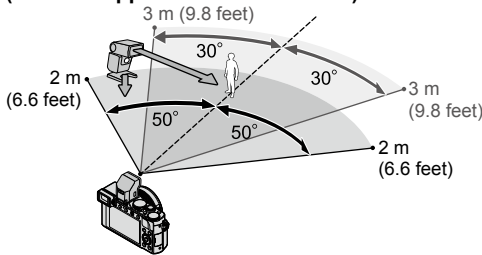

Example of positioning flashes

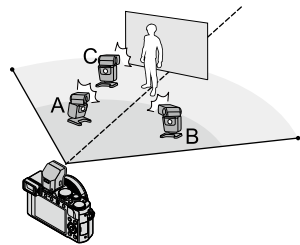

- This flash positioning example shows a case where flash unit C is positioned in order to eliminate the shadows from the subject's background, which is produced by flash unit A and flash unit B of the flash group.
- For the number of wireless flashes to be controlled, we recommend setting up to three flash units in each group.
- When a subject is too close, the communication light emission may affect the exposure of the picture. This problem can be mitigated if you decrease the flash output by setting [Communication Light] to [LOW] or using a flash diffuser or similar device.

Preparation

Attach a supplied flash or an optional flash (DMW-FL360L, DMW-FL580L) to this unit.

1 Set the wireless flash to RC mode and position the flash

- Select the channel and group of the wireless flash.

Taking pictures using the flash (supplied)

2 Set the menu

MENU → **[Rec]** → **[Flash]** → **[Wireless]**

3 Press **▲ ▼** to select **[ON]** and press **[MENU/SET]**

- When [Wireless] is set to [ON], [WL] will appear with the flash icon on the recording screen.
- To perform detailed settings for the wireless flash, perform the following settings from the [Flash].

4 Press **▲ ▼** to select **[Wireless Channel]** and press **[MENU/SET]**5 Press **▲ ▼** to select the channel and press **[MENU/SET]**

- Select the same channel as the channel set for the wireless flash in step 1.

6 Press **▲ ▼** to select **[Wireless Setup]** and press **[MENU/SET]**7 Use **▲ ▼** to select the item and press **[MENU/SET]**

- Press the [DISP.] button to perform a test firing.

Firing Mode Flash output

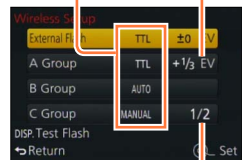

Luminosity ratio

[External Flash]	[Firing Mode]	[TTL]: The camera automatically sets the flash output. [AUTO]*: Sets the flash output using an external flash. [MANUAL]: Manually sets the flash ratio of an external flash. [OFF]: An external flash fires only for a communication light emission.
	[Flash Adjust.]	Adjusts the flash output of an external flash manually when [Firing Mode] is set to [TTL].
	[Manual Flash Adjust.]	Sets the flash ratio of an external flash when [Firing Mode] is set to [MANUAL]. • You can set the flash ratio from [1/1] (flash firing full power) to [1/64] in 1/3 steps.
[A Group]/ [B Group]/ [C Group]	[Firing Mode]	[TTL]: The camera automatically sets the wireless flash output. [AUTO]: Sets the flash output using the wireless flash. [MANUAL]: Manually sets the flash ratio of the wireless flash. [OFF]: The wireless flashes of the set group do not fire.
	[Flash Adjust.]	Adjusts the flash output of the wireless flash manually when [Firing Mode] is set to [TTL].
	[Manual Flash Adjust.]	Sets the flash ratio of the wireless flash when [Firing Mode] is set to [MANUAL]. • You can set the flash ratio from [1/1] (flash firing full power) to [1/64] in 1/3 steps.

* When the flash (supplied) is attached to this unit, you cannot perform these settings.

Taking pictures using the flash (supplied)

- **Setting the communication light emission to be used when wireless flash recording is performed**

MENU →  [Rec] → [Flash] → [Communication Light]





Settings: [HIGH] / [STANDARD] / [LOW]

Recording motion pictures

You can record full high-definition quality images that comply with the AVCHD standard, as well as motion pictures recorded in MP4. You can also record a 4K motion picture in MP4. (→194)

Audio is recorded in stereo.

Setting the format, picture size and recording frame rate

Recording mode:     

1 Set the menu

MENU →  **[Motion Picture]** → **[Rec Format]**

2 Use ▲ ▼ to select the item and press **[MENU/SET]**

[AVCHD]	This is a data format suitable for playback on high-definition TVs.
[MP4]	This data format is suited for playing back motion pictures on a computer and other such devices.

3 Use ▲ ▼ to select **[Rec Quality]** and press **[MENU/SET]**

4 Use ▲ ▼ to select the item and press **[MENU/SET]**

- Exit the menu after it is executed.

Recording motion pictures

When [AVCHD] is selected

Item	Picture size	Recording frame rate	Sensor output	Bit rate
[FHD/28M/50p]*	1920×1080	50p	50 fps	Approx. 28 Mbps
[FHD/17M/50i]	1920×1080	50i	50 fps	Approx. 17 Mbps
[FHD/24M/25p]	1920×1080	50i	25 fps	Approx. 24 Mbps
[FHD/24M/24p]	1920×1080	24p	24 fps	Approx. 24 Mbps

* AVCHD Progressive

When [MP4] is selected

Item	Picture size	Recording frame rate	Sensor output	Bit rate
[4K/100M/25p]	3840×2160	25p	25 fps	Approx. 100 Mbps
[4K/100M/24p]	3840×2160	24p	24 fps	Approx. 100 Mbps
[FHD/28M/50p]	1920×1080	50p	50 fps	Approx. 28 Mbps
[FHD/20M/25p]	1920×1080	25p	25 fps	Approx. 20 Mbps
[HD/10M/25p]	1280×720	25p	25 fps	Approx. 10 Mbps
[VGA/4M/25p]	640×480	25p	25 fps	Approx. 4 Mbps

- What is bit rate

Bit rate is the volume of data for a definite period of time, and the quality becomes higher when the number gets bigger. This unit uses the "VBR" recording method. "VBR" is an abbreviation of "Variable Bit Rate", and the bit rate (volume of data for definite period of time) is changed automatically depending on the subject to record. Therefore, the recording time is shortened when a subject with fast movement is recorded.

About the compatibility of the recorded motion pictures

Motion pictures recorded in [AVCHD] or [MP4] may be played back with poor picture or sound quality or playback may not be possible even when played back with equipment compatible with these formats. Also, the recording information may not be displayed properly. In this case, use this unit.

- When you import and play back motion pictures recorded with [FHD/28M/50p], [FHD/24M/25p], or [FHD/24M/24p] in [AVCHD] using a device other than this unit, a compatible Blu-ray disc recorder or PC installed with "PHOTOfunSTUDIO" is required.
- For details on motion pictures recorded with [4K/100M/25p] or [4K/100M/24p] in the [MP4] format, refer to "Enjoying 4K motion pictures" (→274).

Adjusting the focus while recording motion pictures ([Continuous AF])

Recording mode: **iA P A S M**

Focusing varies depending on the focus mode (→114) and the setting of [Continuous AF] in the [Motion Picture] menu.

[Focus]	[Continuous AF]	Setting
[AFS]/[AFF]/ [AFC]	[ON]	Allow the focus to be constantly adjusted automatically while recording motion pictures. (→114)
	[OFF]	Fix focus position at the start of motion picture recording.
[MF]	[ON] / [OFF]	Allow the focus to be adjusted manually. (→128)

- When the focus mode is set to [AFS], [AFF], or [AFC], the camera will refocus if the shutter button is pressed halfway while recording motion pictures.
- When Auto Focus is activated while you are recording motion pictures, the focusing operation sound may be recorded under some conditions. If you want to suppress this sound, we recommend taking pictures after setting [Continuous AF] to [OFF] in the [Motion Picture] menu.
- When using zoom while recording motion pictures, it may take some time to focus.

Recording motion pictures

Recording mode: **[A] P A S M**

You can record motion pictures by manually setting the aperture value and shutter speed. (→80)

The camera automatically sets the aperture value and shutter speed and identifies the optimal scene to record motion pictures in [Intelligent Auto] Mode. (→76)

1 Press the motion picture button to start recording

- Immediately release the motion picture button after pressing it.
- While you are recording motion pictures, the recording status indicator (red) will flash.
- If you do not perform any operation for approximately 1 minute or longer, some of the information on the screen is turned off. To display the information again, press the [DISP.] button. This operation takes place to prevent screen burn-in. This is not a malfunction.
- Do not block the microphones when recording motion pictures.
- You can also use zoom while recording motion pictures.
 - The operating sounds of the zoom lever or control ring may be recorded in some cases.
- Still pictures can be taken during motion picture recording. (→198)

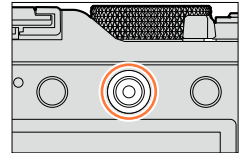

Recording state indicator



Elapsed recording time

Remaining recording time (approx.)

2 Press the motion picture button again to end recording



About the aperture value and shutter speed to be used for recording motion pictures

● About aperture value

- To record motion pictures with a sharp focus on both subject and background, set the aperture value to a higher number. To record motion pictures with a defocused background, set a lower number.

● About the shutter speed

- To record a sharp motion picture of a fast-moving subject, set a faster shutter speed. To record a motion picture with a trailing effect for a subject's movements, set a slower shutter speed.
- When you set a faster shutter speed, the screen noise may increase due to the higher sensitivity.
- When you record a subject under fluorescent or LED lighting fixtures, etc., the colours and screen brightness may change or horizontal striping may appear on the screen. If this happens, we recommend manually adjusting the shutter speed to 1/60 seconds or 1/100 seconds.



About operation sound when recording ends

Since motion pictures are recorded until the motion picture button is pressed to stop recording, the operating sound level in the picture may be higher. To suppress this sound, we recommend trying the following method.



- Divide the end part of a motion picture using [Video Divide] ([→214](#)) in the [Playback] menu. In some cases, motion pictures cannot be divided at a position close to the end part of the motion picture. To avoid this problem, continue recording for an extra 3 seconds.

Enabling/disabling the motion picture button

MENU → **fC** [Custom] → [Video Button] → [ON] / [OFF]

- This function prevents incorrect operation of the button.

Switching the angle of view setting used for recording still pictures and motion pictures

MENU → **fC** [Custom] → [Rec Area] →  (Picture) /  (Motion picture)

- If the aspect ratio is different for still pictures and motion pictures, the angle of view will change when starting to record a motion picture.
When you set [Rec Area] to , the angle of view setting used for recording motion pictures is displayed.
- [Rec Area] should be interpreted as a guideline.

- If the surrounding temperature is high, or a motion picture is recorded continuously, [] is displayed and recording may be stopped halfway through to protect the camera.
- If Extra optical zoom is used before pressing the motion picture button, these settings will be cleared, and the recordable area will be changed significantly.
- Note that if you perform operations such as zoom, using buttons or dials, while recording a motion picture, operation noise may be recorded.
- The zoom speed will be slower than normal during motion picture recording.
- The available recording time displayed on the screen may not decrease regularly.
- Depending on the type of the card, the card access indication may appear for a while after recording motion pictures. This is not a malfunction.
- If you stop recording motion pictures too soon when you have set picture effect (Filter) of [Miniature Effect], the camera may continue recording for a certain time. Hold the camera until the camera stops recording.
- [ISO Limit Set] is disabled when you are recording motion pictures.
- Even if you set [Stabilizer] to [] (Panning) when you are recording motion pictures, it is fixed to [] (Normal).
- It is recommended to use a fully charged battery or an AC adaptor (optional) and DC coupler (optional) when recording motion pictures. (→292)
- If while recording motion pictures using the AC adaptor and the power supply is cut off due to a power outage or if the AC adaptor is disconnected etc., the motion picture being recorded will not be recorded.



Not available in the following cases:

- Motion pictures cannot be recorded in the following cases:
 - During panorama picture recording
 - When the picture effect (Filter) is set ([Rough Monochrome], [Silky Monochrome], [Miniature Effect]*, [Soft Focus], [Star Filter], [Sunshine])
 - * Only when recording motion pictures with [Rec Quality] of [4K]
 - When using [Time Lapse Shot]
 - When using [Stop Motion Animation]

Recording 4K motion pictures

Recording mode: **[iA] [P] [A] [S] [M]**

You can record high-resolution 4K motion pictures by setting [Rec Quality] to [4K].

- To record 4K motion pictures, use a UHS Speed Class 3 card. (→25)
- When you record 4K motion pictures, the angle of view will be narrower than motion pictures of other sizes.

■ To record 4K motion pictures

- ① Select the recording mode (→59)
- ② Set the [Rec Format] in the [Motion Picture] menu to [MP4] (→187)
- ③ Set [Rec Quality] in the [Motion Picture] menu to [4K/100M/25p] or [4K/100M/24p] (→188)
- ④ Press the motion picture button to start recording
- ⑤ Press the motion picture button again to end recording

Creating a high-resolution still picture from a 4K motion picture [4K PHOTO]

You can create a still picture with approximately 8 megapixel resolution from a 4K motion picture recorded by setting [4K PHOTO]. You can create a still picture that captures a moment, similar to high-speed burst recording. This setting is not available in [Intelligent Auto] Mode.

Recording 4K motion pictures

- To record 4K motion pictures, use a UHS Speed Class 3 card. (→25)

1 Set the menu

MENU →  **[Motion Picture]** → **[4K PHOTO]**



2 Press ▲▼ to select [ON] and press [MENU/SET]

A confirmation screen is displayed. If you select [Yes], the operation is executed.

- The appropriate motion picture mode for capturing a still picture from a 4K motion picture is selected and the motion picture can be recorded using still picture quality.
- Since the camera puts higher priority on the focus of a still picture captured from a 4K motion picture, focusing movement during motion picture recording may be noticeable.

The camera will automatically perform the following setting items.

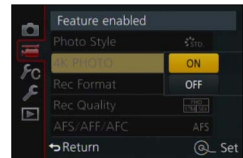

Menu	Item
[Rec Format]	[MP4]
[Rec Quality]	[4K/100M/25p]

3 Press button to display the recording screen

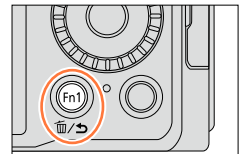

Recording motion pictures

4 Turn the aperture ring and shutter speed dial to set the recording mode

- We recommend setting [Shutter-Priority] Mode and setting the shutter speed to 1/1000 seconds or higher to minimise subject blur. To record a subject that is moving quickly, set the shutter speed to 1/2000 seconds or higher.

5 Operate the aspect ratio selector switch to set the aspect ratio for a motion picture

- The aspect ratio of a still picture captured from a 4K motion picture is the same as the aspect ratio of the motion picture.

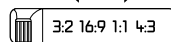
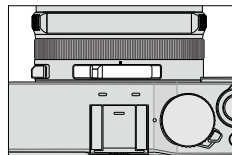
**6 Press the motion picture button to start recording**

- When you record 4K motion pictures, the angle of view will be narrower than motion pictures of other sizes.

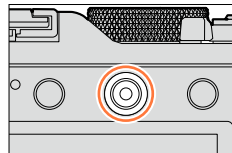
**Setting a marker**

- When you press the [Fn2] button while recording, you can add a marker to the motion picture.
- When you create still pictures from a motion picture, you can quickly move to a marker position you want to capture as a still picture.
- You can add up to 40 markers in a single motion picture.

7 Press the motion picture button again to end recording

- Motion picture recording can also be started or finished by pressing the shutter button.

Creating still pictures from a motion picture

1 Display the picture that you want to capture as a still picture by pressing ▲ to pause a motion picture being played back on the camera

- You can press ◀▶ to perform single-frame forward/rewind operations.
- When you press the [Fn2] button and press ◀▶, you can quickly move to the marker position you set while recording the motion picture. (You can perform the same operation even during motion picture playback.)
If you press the [Fn2] button again, you can perform single-frame forward/rewind operations by pressing ◀▶.



2 Press [MENU/SET]

- A confirmation screen is displayed. Select [Yes] and press [MENU/SET].
 - [Still] is displayed for a captured still picture.
- If you want to capture a still picture from a motion picture while the camera is connected to a TV with the HDMI micro cable, set [VIERA Link] of [TV Connection] in the [Setup] menu to [OFF].

Taking still pictures while a motion picture is being recorded

Recording mode: **[iA] [P] [A] [S] [M]**

Still pictures can be recorded even while a motion picture is being recorded.
(Simultaneous recording)

1 Press the shutter button fully during the motion picture recording



- When you take a still picture, the simultaneous still/motion picture recording icon is displayed.



Setting the motion picture priority or still picture priority mode

Recording mode: **[iA] [P] [A] [S] [M]**

You can use [Picture Mode] in the [Motion Picture] menu to set the recording method of a still picture to be taken while you record a motion picture.

 <p>(motion picture priorities)</p>	<ul style="list-style-type: none"> • Takes a still picture using [Picture Size] [S] (2M). The picture quality may be different to [S] (2M) of standard pictures. • Only pictures in JPEG file format are recorded when [Quality] is set to [RAW], [RAW], or [RAW]. ([Quality] is used with the [RAW] setting when [RAW] is set.) • You can take up to 30 still pictures while you are recording a motion picture. • When the picture effect (Filter) is set to [Miniature Effect], a still picture may be taken with a slight delay from the time you fully press the shutter button.
 <p>(Still picture priorities)</p>	<ul style="list-style-type: none"> • A still picture is taken with [Picture Size] and [Quality] that you have set. • While a still picture is being taken, the screen turns black. During this period, the still picture is taken in the motion picture and the audio is muted. • You can take up to 4 still pictures while you are recording a motion picture.

- The aspect ratio of a still picture is fixed to [16:9].



Not available in the following cases:

- Still pictures cannot be recorded in the following cases:
 - When [Rec Format] is set to [MP4], [Rec Quality] is set to [4K/100M/25p], [4K/100M/24p], or [VGA/4M/25p]
 - When [Rec Format] is set to [AVCHD], [Rec Quality] is set to [FHD/24M/24p] (only available with [Photo Priority] setting)

Using the [Motion Picture] menu

For the setting procedures for the [Motion Picture] menu, refer to (→31).

- The [Photo Style], [AFS/AFF/AFC], [Metering Mode], [Highlight Shadow], [i.Dynamic], [i.Resolution], [i.Zoom], and [Digital Zoom] menu items are common for both [Rec] and [Motion Picture] menus.
If a setting in one menu is changed, the setting with the same name in other menu will also be changed automatically.
- [Motion Picture] menu will not be displayed in the following cases:
 - During panorama picture recording

[4K PHOTO]

- For details (→195).

[Rec Format]

- For details (→187).

[Rec Quality]

- For details (→187).

[Picture Mode]

- For details (→198).

[Continuous AF]

- For details (→189).

Using the [Motion Picture] menu

For the setting procedures for the [Motion Picture] menu, refer to (→31).

[Mic Level Disp.]

Recording mode:     

You can set whether or not to display the microphone level on the recording screen.





Settings: [ON] / [OFF]



Not available in the following case:

- When the picture effect (Filter) is set ([Miniature Effect])

[Mic Level Adj.]

Recording mode:     





You can adjust the audio input level in 4 steps.



Not available in the following case:

- When the picture effect (Filter) is set ([Miniature Effect])

[Wind Cut]

Recording mode:     

If you hear wind noise during an audio recording, you can use [Wind Cut] to effectively reduce the wind noise.

Settings: [AUTO] / [HIGH] / [STANDARD] / [LOW] / [OFF]

- When [Wind Cut] is set, the sound quality may differ from that of normal recordings.



Not available in the following case:

- When the picture effect (Filter) is set ([Miniature Effect])

Viewing the group picture

You can consecutively play back multiple pictures in a group or play back group pictures one by one.

- [▲📷]: Group pictures recorded consecutively by setting [Burst Rate] to [SH] (→142)
- [▲📷🕒]: Group pictures recorded using [Time Lapse Shot] (→153)
- [▲📷🎞️]: Group pictures recorded using [Stop Motion Animation] (→156)



- You can delete or edit pictures in group units. (For example, if you delete one of pictures in a group, all pictures in that group will be deleted.)

Playing back group pictures consecutively

1 Select a picture with the group picture icon ([▲📷], [▲📷🕒], or [▲📷🎞️]), and press ▲

- When you play back group pictures one by one, the option settings are displayed.
 - [From the first picture]: Play back the group pictures consecutively from the first picture in a group.
 - [From the current picture]: Play back the group pictures consecutively from the picture currently played back.

■ Operations during continuous playback

▲	Continuous playback / Pause	▼	Stop
◀	Fast rewind playback	▶	Fast forward playback
	Returning to the previous picture (while paused)		Scrolling to the next picture (while paused)

Viewing the group picture

Playing back group pictures one by one

1 Select a picture with the submenu icon ([, SUB MENU]), and press ▼

- The submenu screen will appear.

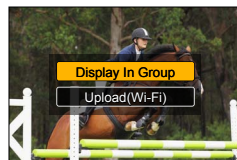
2 Use ▲ ▼ to select [Display In Group] and press [MENU/SET]**3 Use ◀ ▶ to scroll through the pictures**

- When you use ▲ ▼ to select [Exit Display In Group] and press [MENU/SET] after pressing ▼ again, the normal playback screen reappears.
- You can use the same operations for pictures stored in a group as in normal still picture playback. (Multi Playback, Playback Zoom, deletion of pictures, etc.)



- Pictures will not be grouped if they are recorded without setting [Clock Set].
- Burst pictures recorded on another device may not be recognised as group pictures.

Capturing still pictures from motion pictures

Save a scene from a motion picture as a still picture.

- For the method of capturing a still picture from a 4K motion picture recorded by setting [4K PHOTO] to [ON], refer to (→195).

1 Display the picture that you want to capture as a still picture by pressing ▲ to pause a motion picture being played back on the camera

- When you press ◀▶ while paused, you can perform fast forward/rewind operations.



2 Press [MENU/SET]

- A confirmation screen is displayed. Select [Yes] and press [MENU/SET].
- The still picture is saved with aspect ratio of [16:9] and [Quality] of [..]. The picture size varies depending on the motion picture being played back.
 - For motion pictures recorded in [Rec Quality] with [4K]: [M] (8M)
 - For motion pictures recorded in [Rec Quality] with [FHD], [HD]: [S] (2M)

- The picture quality becomes slightly lower depending on the [Rec Quality] setting of the original motion picture.
- When a still picture captured from a motion picture is played back, [] is displayed.
- If you want to capture a still picture from a motion picture while the camera is connected to a TV with the HDMI micro cable, set [VIERA Link] of [TV Connection] in the [Setup] menu to [OFF].

Not available in the following case:

- You cannot capture a still picture from the following motion pictures.
 - Motion pictures recorded in [MP4] using the [VGA/4M/25p] setting

Using the [Playback] menu

You can specify picture protection, resizing, print settings, and other settings for pictures you have taken.

- For the setting procedures of the menu. (→31)

- In the following cases, new pictures are created after they have been edited. Before starting to edit, make sure that there is enough free space in the memory card.

- [RAW Processing]
- [Text Stamp]
- [Time Lapse Video]
- [Stop Motion Video]
- [Resize]
- [Cropping]

- It may not be possible to set or edit pictures taken with other cameras.

[Slide Show]

Automatically play pictures in order. Recommended when viewing on TV screen.

1 Set the menu

[MENU] →  **[Playback]** → **[Slide Show]**

2 Use ▲▼ to select the item and press [MENU/SET]

- When you select [Category Selection], use ▲▼◀▶ to select category and press [MENU/SET]. For details about category, refer to (→206).

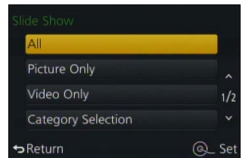

3 Use ▲ to select [Start] and press [MENU/SET]

■ Operations during Slide Show



▲	Pause/Play	▼	Stop
◀	Previous	▶	Next
Control dial (counterclockwise)	Volume down	Control dial (clockwise)	Volume up

Using the [Playback] menu

■ To change settings such as music or display time

Select [Effect] or [Setup] and then press [MENU/SET].

[Effect]		[AUTO] / [NATURAL] / [SLOW] / [SWING] / [URBAN] / [OFF]
[Setup]	[Duration]	[1SEC] / [2SEC] / [3SEC] / [5SEC]
	[Repeat]	[ON] / [OFF]
	[Sound]	[OFF]: Music and audio will not play back. [AUTO]: With still pictures, music will play back, and with motion pictures, audio will play back. [Music]: Music effect will play back. [Audio]: Audio is played back from motion pictures.

- When [URBAN] has been selected, the picture may appear in black and white as a screen effect.
- [AUTO] can be used only when [Category Selection] is selected. The pictures are played back with the recommended effects for each category.
- When you perform a Slide Show playback by setting [Video Only] or [Category Selection] to , , or , [Effect] is fixed to [OFF].
- When you perform a Slide Show playback for a group picture, and even if [Effect] is set, the effects are disabled.
- When panorama pictures, motion pictures, or group pictures are played back, the [Duration] setting is disabled.
- [Duration] can be set only when [Effect] is set to [OFF].
- Part of [Effect] cannot be used when displaying pictures on television using an HDMI micro cable or when displaying pictures recorded in portrait position.
- Music effects cannot be added.

Using the [Playback] menu

[Playback Mode]

Recorded pictures can be played back in a variety of ways.

1 Set the menu

[MENU] → **[▶]** **[Playback]** → **[Playback Mode]**

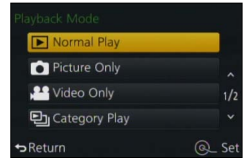
2 Use ▲ ▼ to select the item and press [MENU/SET]

When selecting [Category Play] in step 2 above

3 Use ▲ ▼ ◀ ▶ to select the category and press [MENU/SET]

- The available categories are as follows.

	[Face Recog.]*
	[i-Portrait], [i-Night Portrait], [i-Baby] in Automatic Scene Detection
	[i-Scenery], [i-Sunset] in Automatic Scene Detection
	[i-Night Portrait], [i-Night Scenery], [i-Handheld Night Shot] in Automatic Scene Detection
	[i-Food] in Automatic Scene Detection
	[Travel Date]
	A burst of pictures recorded by setting [Burst Rate] to [SH]
	[Time Lapse Shot], [Time Lapse Video]
	[Stop Motion Animation], [Stop Motion Video]

* Use ▲ ▼ ◀ ▶ to select a person to be played back and press [MENU/SET]. Face Recognition is applied for all the pictures in the group.

- [Playback Mode] automatically changes to [Normal Play] when the camera is turned on, or when switching from the recording standby screen to the playback screen.
- The category for recording motion pictures is different from the category of still pictures used in some Recording Modes. For that reason, the pictures may not be played back.

[Location Logging]

After you send location information (latitude and longitude) obtained by your smartphone/tablet to this unit, you can write this information on pictures using the unit.

Preparation

Send location information to this unit from your smartphone/tablet. (→237)

- You must install "Panasonic Image App" on your smartphone/tablet. (→228)

1 Set the menu

MENU →  **[Playback]** → **[Location Logging]** → **[Add Location Data]**

2 Use ▲▼ to select a period for writing location information, and then press [MENU/SET]

- A confirmation screen is displayed. If you select [Yes], the operation is executed.
- [GPS] is displayed for pictures that have location information written to it.

■ Abort writing location information

- ① Press [MENU/SET] while location information is being written.
 - [○] is displayed for the period of the abort operation.
 - If selected again while [○] is displayed, writing location information will resume where it left off.

■ Delete received location information

- ① Use ▲▼ to select [Delete Location Data] and press [MENU/SET]
- ② Use ▲▼ to select a period for deleting location information, and then press [MENU/SET]
 - A confirmation screen is displayed. If you select [Yes], the operation is executed.

- Location information can be written only to pictures recorded with this unit.



Not available in the following cases:

- Location information may not be written if there is not enough free space on your card.
- The location information will not be written on pictures that were recorded after you sent the location information (→237).
- Location information will not be written to AVCHD motion pictures.
- The location information cannot be written to pictures recorded without setting [Clock Set].



Writing the location information using a smartphone/tablet

When you use your smartphone/tablet as a remote controller for this unit, you can write the location information on pictures using the smartphone/tablet. (→238)

[RAW Processing]

You can use the camera to develop still pictures that were recorded in RAW format. The created still pictures are saved in JPEG format. You can develop the pictures while confirming the effects on the screen.

1 Set the menu

MENU → **[Playback]** → **[RAW Processing]**

2 Press ◀▶ to select RAW file and press [MENU/SET]

3 Press ▲▼ to select the item

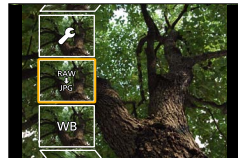

- The following items can be set. The settings used during recording are applied at the time of setting.

[White Balance]	You can select White Balance to make adjustments. When you select an item with [Q] , you can develop the pictures using the same settings that were applied for recording.
[Exposure Comp.]	You can perform Exposure Compensation in the range from -1 EV to +1 EV.
[Photo Style]	You can select the [Photo Style] effects ([Standard], [Vivid], [Natural], [Monochrome], [Scenery], or [Portrait]).
[i.Dynamic]	You can select the [i.Dynamic] settings ([HIGH], [STANDARD], [LOW], or [OFF]).
[Contrast]	You can adjust the contrast.
[Highlight]	You can adjust the brightness of a highlighted area.
[Shadow]	You can adjust the brightness of a shadowed area.
[Saturation] / [Color Tone]	You can adjust the saturation. (You can adjust the colouring when [Monochrome] is selected for [Photo Style].)
[Filter Effect]	You can select a Filter effect. (Only when [Monochrome] is selected for [Photo Style])
[Noise Reduction]	You can set noise reduction.
[i.Resolution]	You can select the [i.Resolution] settings ([HIGH], [STANDARD], [LOW], [EXTENDED], or [OFF]).
[Sharpness]	You can adjust the impression of resolution.
[Setup]	You can perform the following settings. [Reinstate Adjustments]: You can restore the settings to the ones used during recording. [Color Space]: You can select [Color Space] from either [sRGB] or [Adobe RGB]. [Picture Size]: You can select the picture size ([L], [M], or [S]) of a JPEG file when saving pictures.

Using the [Playback] menu

4 Press [MENU/SET] to set

- The setting methods vary depending on the item. For details, refer to “Setting each item”.

5 Press [MENU/SET]



- The screen in step 3 reappears. To set another item, repeat steps 3 to 5.

6 Press ▲ ▼ to select [Begin Processing] and press [MENU/SET]

- Confirmation screen is displayed. If you select [Yes], the operation is executed.

■ Setting each item

When you select an item, the setting screen appears.

 Control dial	Used to make adjustments
	Used to display the colour temperature setting screen (→105) (Only when [White Balance] is set to [K])
	Used to display the White Balance fine adjustment screen (→105) (Only when [White Balance] is set)
[DISP.]	Used to display the comparison screen
[MENU/SET]	Used to finalise an adjustment you just made and to return to the item selection screen



- If you have selected [Noise Reduction], [i.Resolution], or [Sharpness], the comparison screen is not displayed.
- Pictures can be enlarged by operating the zoom lever.

The following operating methods are available to make adjustments on the comparison screen.

 Control dial	Used to make adjustments
[DISP.]	Used to return to the setting screen
[MENU/SET]	Used to finalise an adjustment you just made and to return to the item selection screen

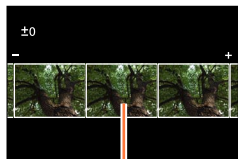

Current setting

Using the [Playback] menu

When [Setup] is selected

When you select an item, the screen for selecting [Reinstate Adjustments], [Color Space], or [Picture Size] is displayed.

- ① Use ▲ ▼ to select the item and press [MENU/SET]
 - When [Reinstate Adjustments] is selected, confirmation screen is displayed. When you select [Yes], the item selection screen reappears.
- ② Use ▲ ▼ to select the setting and press [MENU/SET]

- The result of a RAW file developed by this camera and a RAW file developed by the supplied DVD software "SILKYPIX Developer Studio" will not be exactly the same.
- The range that can be set using Exposure Compensation varies from the range used during recording.
- The [White Balance] setting of still pictures recorded using [Multi Exp.] is fixed to the setting used during recording.
- If [Red-Eye Removal] is activated during recording, you can use [RAW Processing] in the [Playback] menu to save JPEG file pictures in which red-eye was detected and corrected.
- You cannot perform RAW processing using multiple still pictures simultaneously.

**Not available in the following cases:**

- When an AV cable (optional) or an HDMI micro cable is connected, [RAW Processing] is disabled.
- You can perform RAW processing on pictures recorded using this unit only. [RAW Processing] cannot be used for pictures recorded on other devices or for pictures recorded in formats other than the RAW format.

[Title Edit]

You can enter characters (comments) on a recorded picture.

1 Set the menu

[MENU] → **[▶]** **[Playback]** → **[Title Edit]** → **[Single]** or **[Multi]**

2 Select a still picture

[Single]

① Use **◀▶** to select a still picture and press [MENU/SET]



[Multi] (up to 100 pictures)

① Use **▲▼◀▶** to select a still picture and press [MENU/SET]

- To cancel → Press [MENU/SET] again.
- To execute → Use **◀** to select [OK] and press [MENU/SET].



3 Enter characters (Entering text (→52))

- To delete a title, delete all the characters in the character input screen.

- To print text, use [Text Stamp] or "PHOTOfunSTUDIO" on the supplied DVD.

Not available in the following cases:

- Motion pictures
- Still pictures recorded with the [Quality] setting [RAW:⏏], [RAW:⏏] or [RAW]

[Text Stamp]

You can stamp the recording date and time, names, travel destination, travel dates, etc. on the recorded still pictures.

1 Set the menu

[MENU] → **[▶]** **[Playback]** → **[Text Stamp]** → **[Single]** or **[Multi]**

2 Select a still picture

[Single]

① Use **[◀]** **[▶]** to select a still picture and press [MENU/SET]



[Multi] (up to 100 pictures)

① Use **[▲]** **[▼]** **[◀]** **[▶]** to select a still picture and press [MENU/SET]

[Text Stamp] setting
 [Text Stamp] already set

- To cancel → Press [MENU/SET] again.
- To execute → Use **[◀]** to select [OK] and press [MENU/SET].

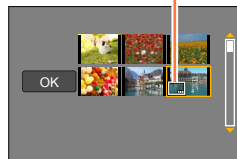

3 Use **[▲]** **[▼]** to select [Set] and press [MENU/SET]

4 Use **[▲]** **[▼]** to select the item and press [MENU/SET] (→213)



5 Use **[▲]** **[▼]** to select the setting and press [MENU/SET] (→213)

6 Press **[🗑️/↶]** button

7 Use **[▲]** **[▼]** to select [OK] and press [MENU/SET]

- Confirmation screen is displayed. If you select [Yes], the operation is executed.

■ Items that can be stamped

[Shooting Date]	[W/O TIME]: Stamp recording date [WITH TIME]: Stamp recording date and time
[Name]	 : Stamp name registered in Face Recognition  : Stamp name registered in [Profile Setup]
[Location]	Stamp location registered in [Setup] menu's [Travel Date]
[Travel Date]	Stamp number of days that have elapsed since the travel date set in [Setup] menu's [Travel Date]
[Title]	Stamp text registered in [Title Edit]

- Items set to [OFF] are not stamped.

- **Do not request date printing in store or make date printing on printer for still pictures with date stamps. (Date printing may be overlapped.)**
- Characters may be cut off on certain printers.
- If you stamp text on the pictures in a group, those pictures are saved as new pictures.
- Text is difficult to read when stamped on pictures of 0.3M or less.



Not available in the following cases:

- Motion pictures
- Still pictures recorded with the [Quality] setting [RAW]
- Panorama pictures
- Still pictures that other texts had already been stamped
- Still pictures taken without setting clock

[Video Divide]

A single motion picture can be split into 2 parts. This is convenient when you want to keep just the necessary scenes, or if you wish to delete unnecessary scenes to increase free space on your card, such as when travelling.

1 Set the menu

MENU →  **[Playback]** → **[Video Divide]**

2 Use ◀▶ to select a motion picture to split and press [MENU/SET]

3 Press ▲ at where you want to split a motion picture to pause it

- If you press ◀▶ while paused, you can make finer adjustments to the splitting positions in a motion picture.
- If you press ▲ again, the motion picture is played back from the last position prior to activating pause.

4 Press ▼

- A confirmation screen is displayed. Select [Yes] and press [MENU/SET].
- **The original motion picture that was split does not remain.** (There will only be the 2 motion pictures that were created after the split.)



- During dividing, do not turn off the camera or remove the card or battery. If you do so, the motion picture may be deleted.
- If you divide a motion picture recorded in [MP4] when the picture display sequence is set to [FILE NAME], the order of the pictures will change. It is recommended to set the display sequence to [DATE/TIME] or to display using [Calendar].

Not available in the following cases:

- Motion pictures cannot be divided at a location close to the start or end of the motion picture.
- Motion pictures with a short recording time cannot be divided.

[Time Lapse Video]

You can create a motion picture from the pictures in a group that was recorded using [Time Lapse Shot]. The motion picture you created is saved in the MP4 recording format.

1 Set the menu

MENU →  **[Playback]** → **[Time Lapse Video]**

2 Use ◀▶ to select the [Time Lapse Shot] picture group and press [MENU/SET]

3 Create a motion picture after selecting a production method

- The process is the same as that used to create a motion picture after recording pictures using [Time Lapse Shot]. For details, refer to step 5 and the subsequent steps (→154). For details on the motion picture you created, refer to (→155).

[Stop Motion Video]

You can create a motion picture from the pictures in a group that was recorded using [Stop Motion Animation]. The motion picture you created is saved in the MP4 recording format.

1 Set the menu

MENU →  **[Playback]** → **[Stop Motion Video]**

2 Use ◀▶ to select a stop motion animation group and press [MENU/SET]

3 Create a motion picture after selecting a production method

- The process is the same as that used to create a motion picture after recording pictures using [Stop Motion Animation]. For details, refer to step 8 and the subsequent steps (→157). For details on the motion picture you created, refer to (→158).

[Resize]

Picture size can be reduced to facilitate e-mail attachment and use in web pages, etc.

1 Set the menu

MENU →  **[Playback]** → **[Resize]** → **[Single]** or **[Multi]**

2 Select a still picture and size

[Single]

- ① Use ◀▶ to select a still picture and press [MENU/SET]
- ② Use ▲▼ to select size and press [MENU/SET]
 - A confirmation screen is displayed. If you select [Yes], the operation is executed.

[Multi] (up to 100 pictures)

- ① Use ▲▼ to select size and press [MENU/SET]
 - ② Use ▲▼◀▶ to select a still picture and press [MENU/SET]
 - A confirmation screen is displayed. If you select [Yes], the operation is executed.
- To cancel → Press [MENU/SET] again.
 - To execute → Use ◀ to select [OK] and press [MENU/SET].

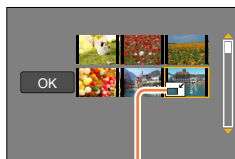
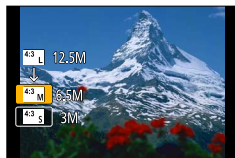

Resize setting

- Picture quality is reduced after resizing.

Not available in the following cases:

- Still pictures recorded at the smallest recording pixel level cannot be further reduced.
- Cannot resize the following pictures:
 - Motion pictures
 - Still pictures recorded with the [Quality] setting [RAW]
 - Panorama pictures
 - Group pictures
 - Still pictures that other texts had already been stamped

[Cropping]

Enlarge your still pictures and crop unwanted areas.

1 Set the menu

MENU →  **[Playback]** → **[Cropping]**

2 Use ◀▶ to select a still picture and press [MENU/SET]

3 Select area to crop and press [MENU/SET]

- A confirmation screen is displayed. If you select [Yes], the operation is executed.

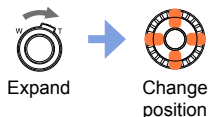

- Perform cropping for each picture in the group. (You cannot edit pictures in group units.)
- If you crop a picture in the group, it is saved as a new picture.
- Original Face Recognition information will not be copied when still pictures are cropped.
- Picture quality is reduced after cropping.

Not available in the following cases:

- Motion pictures
- Still pictures recorded with the [Quality] setting [RAW]
- Panorama pictures
- Still pictures that other texts had already been stamped

Using the [Playback] menu

[Rotate] / [Rotate Disp.]

You can automatically display a still picture recorded in portrait orientation by taking the picture with the camera held vertically, or manually rotate the picture in 90-degree units.

[Rotate] Rotating a picture manually

- You cannot select [Rotate] when [Rotate Disp.] is set to [OFF].

1 Set the menu

MENU → **[Playback]** → **[Rotate]**

2 Use ◀▶ to select picture and press [MENU/SET]

- You cannot rotate group pictures.

3 Use ▲▼ to select the rotation direction and press [MENU/SET]

[↻]: Rotate a picture 90 degrees clockwise.

[↶]: Rotate a picture 90 degrees counterclockwise.

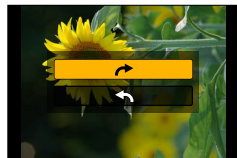
**[Rotate Disp.] Rotating a picture automatically to display****1 Set the menu**

MENU → **[Playback]** → **[Rotate Disp.]** → **[ON]**

- When this function is set to [OFF], the picture is displayed without changing its orientation.

**Not available in the following cases:**

- When you play back pictures on a PC, they cannot be displayed in the rotated direction unless the OS or software is compatible with Exif. Exif is a file format for still pictures which allows recording information, etc. to be added. It was established by "JEITA (Japan Electronics and Information Technology Industries Association)".
- A picture may not be automatically rotated to display it with portrait orientation on the Multi Playback screen, which is displayed for settings such as [Delete Multi].

Using the [Playback] menu

[Favorite]

By labelling your favourite pictures with a star [★], you can play back your favourite pictures only, or you can delete all pictures except your favourites.

1 Set the menu

[MENU] → **[▶]** **[Playback]** → **[Favorite]** → **[Single]** or **[Multi]**

2 Select picture**[Single]**

- ① Use **◀▶** to select picture and press **[MENU/SET]**
- To cancel → Press **[MENU/SET]** again.



Favourite picture setting

[Multi] (up to 999 pictures)

- ① Use **▲▼◀▶** to select picture and press **[MENU/SET]**
- To cancel → Press **[MENU/SET]** again.

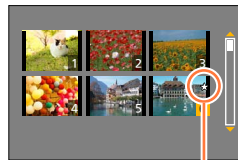

Favourite picture setting

■ To clear all

In step **1**, select **[Favorite]** → **[Cancel]** → **[Yes]**, and then press **[MENU/SET]**

- When you set **[Favorite]** for a picture in a group, the number of pictures set is displayed with the **[Favorite]** icon of the first picture.
- Only when **[Playback Mode]** is set to **[Normal Play]**, you can select **[Cancel]**.

**Not available in the following case:**

- Still pictures recorded with the **[Quality]** setting **[RAW]**

[Print Set]

Picture/picture no./date printing settings can be made for when printing with DPOF print-compatible shops or printers. (Ask at the shop to check for compatibility.)

1 Set the menu

[MENU] → **[Playback]** → **[Print Set]** → **[Single]** or **[Multi]**

2 Select a still picture

[Single]

① Use **◀▶** to select still picture and press **[MENU/SET]**

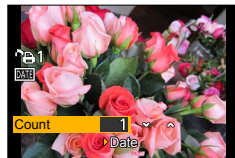

[Multi]

① Use **▲▼◀▶** to select still picture and press **[MENU/SET]**

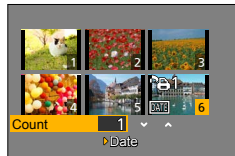

3 Use **▲▼** to set number of still pictures and press **[MENU/SET]**

(Repeat steps **2** and **3** when using **[Multi]** (up to 999 pictures))

- Date print setting/release → Press **▶**.

■ To clear all

In step **1**, select **[Print Set]** → **[Cancel]** → **[Yes]**, and then press **[MENU/SET]**

- When you have performed **[Print Set]** for pictures in a group, printing settings are made for the total of number of pictures set in that group. If the total number of pictures is 1,000 or higher, [999+] is displayed.
- When you perform **[Print Set]** for a picture in a group, the number of pictures set and the total number of pictures are displayed with the Print Set icon of the first picture.
- Date print setting cannot be made for pictures with a **[Text Stamp]** applied.
- Depending on the type of printer, the printer settings may take priority over camera settings.
- Some DPOF information (print settings) set by other equipment cannot be used. In such cases, delete all of the DPOF information and then set it again with this camera.



Not available in the following cases:

- Motion pictures
- Still pictures recorded with the **[Quality]** setting **[RAW]**
- Cannot be set for files that are not compliant with the DCF standard.

[Protect]

Set protection to disable picture deletion. Prevents deletion of important pictures.

1 Set the menu

MENU → **[Playback]** → **[Protect]** → **[Single]** or **[Multi]**

2 Select picture

[Single]

- ① Use **◀▶** to select picture and press **[MENU/SET]**
- To cancel → Press **[MENU/SET]** again.



Picture protected

[Multi]

- ① Use **▲▼◀▶** to select picture and press **[MENU/SET]**
- To cancel → Press **[MENU/SET]** again.

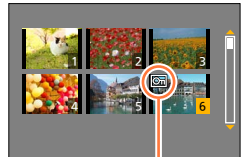

Picture protected

■ To clear all

In step **1**, select **[Protect]** → **[Cancel]** → **[Yes]**, and then press **[MENU/SET]**



When you set the write-protect switch on the card to the "LOCK" position, the picture is not erased.

- The picture is erased when formatting, even if it is protected.
- May not be effective when using other devices.
- When you set **[Protect]** for a picture in a group, the number of pictures set is displayed with the **[Protect]** icon of the first picture.

[Face Rec Edit]

Edit or delete the recognition information for pictures with mistaken Face Recognition.

1 Set the menu

MENU →  **[Playback]** → **[Face Rec Edit]** → **[REPLACE]** or **[DELETE]**

2 Use ◀▶ to select picture and press [MENU/SET]

3 Use ◀▶ to select a person and press [MENU/SET]

- If [DELETE], go to step 5.
- People whose Face Recognition information has not been registered cannot be selected.

4 Use ▲▼◀▶ to select the person to replace for another and press [MENU/SET]

5 Use ◀▶ to select [Yes] and press [MENU/SET]

- When Face Recognition information is deleted, it cannot be restored.
- Pictures for which all Face Recognition information has been deleted are not categorised in Face Recognition during [Category Play] or [Category Selection].
- Edit the Face Recognition information in group units for a group picture. (You cannot edit the information for each picture in a group.)
- You can edit only the first picture in a group.

[Picture Sort]

You can set the display sequence used for playing back pictures on this unit.

1 Set the menu

[MENU] →  **[Playback]** → **[Picture Sort]**

2 Use ▲ ▼ to select the item and press [MENU/SET]

[FILE NAME]	Displays pictures in the folder name or file name sequence. This display format allows you to find the storage location of a picture on a card more easily.
[DATE/TIME]	Displays pictures according to the date and time that the pictures were taken in chronological order. When the pictures are taken using several cameras and stored on the same card, this display format allows you find a specific picture more easily.

- Pictures may not be displayed according to the [DATE/TIME] sequence immediately after a card is inserted into this unit. In that case, wait a while, and the pictures will be displayed in the [DATE/TIME] sequence.

[Delete Confirmation]

You can set the Yes/No options that you want to select first on the confirmation screen when you delete a picture from either [Yes] or [No].

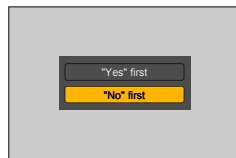

1 Set the menu

[MENU] →  **[Playback]** → **[Delete Confirmation]**

2 Use ▲ ▼ to select the item and press [MENU/SET]

["Yes" first]	[Yes] is selected by default to quickly perform a deletion.
["No" first]	[No] is selected by default. This setting will prevent you from accidentally deleting pictures.

Wi-Fi® Function and NFC Function

■ Use the camera as a wireless LAN device

When using equipment or computer systems that require more reliable security than wireless LAN devices, ensure that the appropriate measures are taken for safety designs and defects for the systems used. Panasonic will not take any responsibility for any damage that arises when using the camera for any purpose other than as a wireless LAN device.

■ Use of the Wi-Fi function of this camera is presumed to be in countries where this camera is sold

There is the risk that the camera violates the radio wave regulations if used in countries other than those where this camera is sold, and Panasonic takes no responsibility for any violations.

■ There is the risk that data sent and received via radio waves may be intercepted

Please note that there is the risk that data sent and received via radio waves may be intercepted by a third party. We strongly recommend that you enable encryption in the settings of your wireless access point to ensure information security.

■ Do not use the camera in areas with magnetic fields, static electricity or interference

- Do not use the camera in areas with magnetic fields, static electricity or interference, such as near microwave ovens. Radio waves may not reach the camera.
- Using the camera near devices such as microwave ovens or cordless telephones that use the 2.4 GHz radio wave band may cause a decrease in performance in both devices.

■ Do not connect to the wireless network you are not authorised to use

When the camera utilises its Wi-Fi function, wireless networks will be searched automatically. When this happens, wireless networks that you are not authorised to use (SSID*) may be displayed, however do not attempt to connect to the network as it may be considered as unauthorised access.

*SSID refers to the name that is used to identify a network over a wireless LAN connection. If the SSID matches for both devices, transmission is possible.

■ Before Use

- To use the Wi-Fi function on this unit, a wireless access point or a destination device equipped with the wireless LAN function is required.

■ The camera is compatible with NFC

Using the NFC (Near Field Communication) function, the camera and a smartphone/tablet can easily exchange the information needed to establish a Wi-Fi connection.

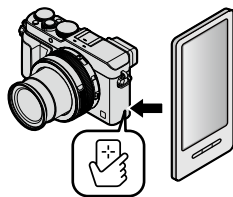

■ About the Wi-Fi connection lamp

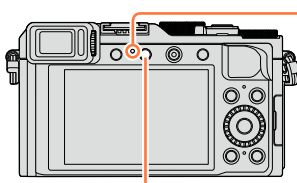

Wi-Fi connection lamp
 Lit blue: When the Wi-Fi function is ON
 Blinking blue: When sending data

[Wi-Fi] button

■ About the [Wi-Fi] button

You can operate the [Wi-Fi]/[Fn2] button in two ways, using it either as the [Wi-Fi] button or as a function button [Fn2].
 It is set to [Wi-Fi] at the time of purchase.
 For more details about the function button (→37)

- Before a Wi-Fi connection is established, press the [Wi-Fi] button to perform the following operations:
 (You can also display the same menu by selecting **MENU** →  [Setup] → [Wi-Fi] → [Wi-Fi Function].)

[New Connection]
[Select a destination from History] (→268)
[Select a destination from Favorite] (→268)

Wi-Fi® Function and NFC Function

- Pressing the [Wi-Fi] button during a Wi-Fi connection enables the following operation.

[Terminate the Connection]	Terminates the Wi-Fi connection.
[Change the Destination]*1	Terminates the Wi-Fi connection, and allows you to select a different Wi-Fi connection.
[Change Settings for Sending Images]*2	For details (→271).
[Register the Current Destination to Favorite]*1	Registering the current connection destination or the connection method, you can easily connect with the same connection method next time.
[Network Address]	Displays the MAC address and IP address of this unit (→273).

*1 This item will not be displayed if you press ▼ to send pictures to WEB services while the pictures are displayed (→254).

*2 This item will not be displayed if the destination for [Remote Shooting & View], [Playback on TV] or [Send Images Stored in the Camera] is set to [Printer].

- Do not remove the memory card or battery or move to an area without any reception while sending images.**

- The camera cannot be used to connect to a public wireless LAN connection.
- Use a IEEE802.11b, IEEE802.11g or IEEE802.11n compatible device when using a wireless access point.
- We recommend that you use a fully charged battery when you send pictures.
- When the battery indicator is flashing red, the connection with other equipment may not start or the connection may be disrupted. (A message such as [Communication error] is displayed.)
- When sending images on a mobile network, high packet communication fees may be incurred depending on the details of your contract.
- Pictures may not be completely sent depending on radio wave conditions. If the connection is terminated while sending pictures, pictures with missing sections may be sent.
- The monitor display may become distorted for an instant while connected to the service, however this will not affect the image being sent.

What you can do with the Wi-Fi function

Operating the camera by connecting it to a smartphone (→228)

Taking pictures via a smartphone (remote recording)

Playing back pictures in the camera on a smartphone/tablet

Saving pictures in the camera to the smartphone/tablet

Sending pictures in the camera to social networking services

Writing the location information on pictures in the camera

Connect easily, transfer pictures easily

You can easily use the Wi-Fi function by pressing and holding the [Wi-Fi] button or using the NFC function.

Press and hold

Hold the device close to the camera

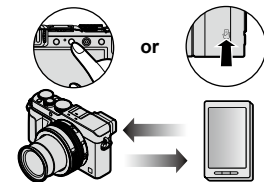

Displaying still pictures on a TV (→242)

Wireless printing (→243)

Sending pictures to AV device (→244)

Still pictures and motion pictures can be sent to AV device in the home (home AV device).

Sending pictures to a PC (→247)

Using WEB services (→251)

Through “LUMIX CLUB”, you can send still pictures and motion pictures to social networking services, etc. You can receive still pictures and motion pictures on a PC or a smartphone/tablet using the Cloud Sync. Service.

- Hereafter, this manual uses the term “smartphone” for both smartphones and tablets unless it is necessary to distinguish between them.



Operating the camera by connecting it to a smartphone

You can remotely operate the camera using a smartphone.

The “Panasonic Image App” (hereafter “Image App”) must be installed on your smartphone.

Installing the smartphone/tablet app “Panasonic Image App”

The “Image App” is an application provided by Panasonic that allows your smartphone to perform the following operations of a Wi-Fi-compatible LUMIX.

	For Android™ apps	For iOS apps
Supported OS	Android 2.3.3 or later*	iOS 6.0 or later (iPhone 3GS is not supported.)
Installation procedure	① Connect your Android device to a network ② Select “Google Play™ Store” ③ Enter “Panasonic Image App” or “LUMIX” to search for the app ④ Select “Panasonic Image App” and install it • The icon will be added to the menu. 	① Connect the iOS device to the network ② Select “App Store SM ” ③ Enter “Panasonic Image App” or “LUMIX” to search for the app ④ Select “Panasonic Image App” and install it • The icon will be added to the menu. 

* To connect this unit with [Wi-Fi Direct], Android OS 4.0 or above is required and the device must be compatible with Wi-Fi Direct™.

- Use the latest version.
- Supported OS versions as of September 2014. Supported OS versions may be changed without prior notice.
- Some of the screens and information provided in this document may be different depending on the supported operating system and “Image App” version.
- The service may not be able to be used properly depending on the type of smartphone being used.
- For details about the operating procedure, etc., refer to [Help] in the “Image App” menu.
- For the latest information on the “Image App”, refer to the support site below. <http://panasonic.jp/support/global/cs/dsc/> (This site is available in English only.)
- When downloading the app on a mobile network, high packet communication fees may be incurred depending on the details of your contract.

Connecting to a smartphone

You can easily establish a Wi-Fi connection on the camera by pressing and holding the [Wi-Fi] button or using the NFC function.

Preparation

Install "Image App" in advance. (→228)

1 Press and hold the [Wi-Fi] button

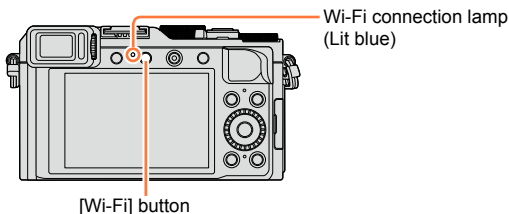

- The information (QR Code, SSID and Password) required for directly connecting your smartphone to this unit is displayed.
- After the second time, the screen for the previously used connection method will appear.
- The same screen can be displayed by selecting items from the menu as follows.

Wi-Fi → **[New Connection]** →
[Remote Shooting & View]

- When you press [MENU/SET] on the camera, the QR code is displayed in an enlarged size. If it is difficult to read the code, use the enlarge view. (If your smartphone cannot read the QR code, move the camera away from the smartphone or use a connection method other than the QR code.)
- To change the connection method, press the [DISP.] button and select the connection method. (→232)

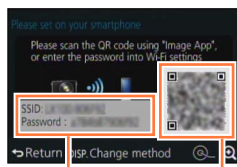

SSID and Password

QR Code

2 Operate the smartphone

- When the connection is complete, live images being captured by the camera are displayed on the smartphone.
(It may take some time after the operation for the connection to be established.)
- The connection method differs depending on the smartphone used. (→230, 231)

Operating the camera by connecting it to a smartphone

■ Using an iOS device

- When reading a QR Code to connect
(Steps ① to ⑤ are not necessary when reconnecting.)

① Start “Image App” (→228)

② Select [QR Code] → [OK]

③ Read the QR Code displayed on this unit with “Image App”

(When you press [MENU/SET] on the camera, the QR code is displayed in an enlarged size.)

④ Install the IMAGE APP profile

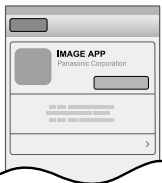

Select [Install]*, then select [Install Now]* → [Done]*.

- The message is displayed in the Web browser.
- If a passcode is required to unlock the smartphone, you will have to input the passcode.

⑤ Press the home button to close the Web browser

⑥ Select [Wi-Fi]* under [Settings]* on the smartphone

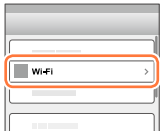

⑦ Turn on [Wi-Fi]* and select the SSID displayed on this unit



⑧ Return to the home screen and start “Image App” (→228)

*The display may differ depending on the system language setting.

Operating the camera by connecting it to a smartphone

- When connecting with SSID and password
 - ① Select [Wi-Fi]* under [Settings]* on the smartphone
 - ② Turn on [Wi-Fi]* and select the SSID displayed on this unit
 - ③ Enter the password displayed on this unit (First time connecting only)
 - ④ Return to the home screen and start “Image App” (→228)

*The display may differ depending on the system language setting.

■ Using an Android device

- When reading a QR Code to connect
 - ① Start “Image App” (→228)
 - ② Select [QR Code]
 - ③ Read the QR Code displayed on this unit with “Image App”
(When you press [MENU/SET] on the camera, the QR code is displayed in an enlarged size.)
- When connecting with SSID and password
 - ① Start “Image App” (→228)
 - ② Select [Wi-Fi]
 - ③ Select the SSID displayed on this unit
 - ④ Enter the password displayed on this unit (First time connecting only)
 - If you check the item to display the password, you can confirm the password as you enter it.

Operating the camera by connecting it to a smartphone

Changing the connection method

To change the connection method, press the [DISP.] button and select the connection method.



■ When connecting with [Via Network]

(On the camera)

① Select [Via Network] and press [MENU/SET]

- Connect the camera to a wireless access point by following the connection method (→264).

(On your smartphone)

② Set Wi-Fi function to “ON”

③ Select the wireless access point you connected to the camera, and set

④ Start “Image App” (→228)

■ When connecting with [Direct]

(On the camera)

① Select [Direct] and press [MENU/SET]

- Select [Wi-Fi Direct] or [WPS Connection], and connect the camera to the smartphone by following the connection method (→267).

(On your smartphone)

② Start “Image App” (→228)

Closing the connection

After use, close the connection with the smartphone.

(On the camera)

1 Press [Wi-Fi] button

(On the recording standby screen, you can also close the connection by pressing

MENU → [Setup] → [Wi-Fi] → [Wi-Fi Function] → [Yes].)

2 Select [Terminate the Connection]

- A confirmation screen is displayed. Select [Yes] and press [MENU/SET].

(On your smartphone)

3 Close “Image App”

<Using an iOS device>

From the “Image App” screen, press the home button on the smartphone to close the app

<Using an Android device>

From the “Image App” screen, press the back button on the smartphone twice to close the app

Operating the camera by connecting it to a smartphone

Connecting to a smartphone using NFC function

Using the NFC (Near Field Communication) function, the camera and a smartphone can easily exchange the information needed to establish a Wi-Fi connection.

Compatible models:

This function can be used with NFC compatible devices with Android (2.3.3 or above).
(Not available in certain models)

- See the operating instructions of your NFC-compatible smartphone for more information about smartphone operation and settings.

Preparations

(On the camera)

- Set [NFC Operation] to [ON] (→272)

(On your smartphone)

- Check if your smartphone is a compatible model
- Set Wi-Fi function to "ON"
- Install "Image App" in advance (→228)

- 1 Start "Image App" on your smartphone**
- 2 While the [] is displayed on the connection screen of the "Image App", hold the smartphone close to the camera**
- 3 Use ◀ to select [Yes] and press [MENU/SET]**
- 4 Hold the smartphone close to this area of the unit again**
 - When the connection is complete, live images captured by the camera will be displayed on your smartphone.
 - It may take some time to complete the connection.
 - Connected smartphones are registered to this unit.
 - From the next time and on, you can connect by performing steps 1 and 2.

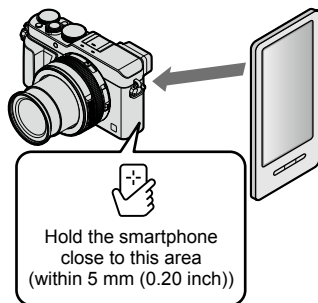

Operating the camera by connecting it to a smartphone

- You can register up to 20 smartphones. If the number of registered smartphones exceeds 20, registrations will be deleted starting from the smartphone touched first.
- If you perform [Reset Wi-Fi Settings], smartphone registration will be deleted.
- If the communication environment is bad, the NFC function may not be usable.
- If there is not a response immediately, shift the position slightly.
- Do not bump your smartphone strongly against this unit.
- See the operating instructions of your NFC-compatible smartphone for more information about smartphone operation and settings.
- Metal objects between this unit and the smartphone may interfere with communication. Also, any stickers, etc., near the NFC area may affect communication performance.



Not available in the following cases:

- The NFC function cannot be used in the following cases:
 - When the camera is turned off (Including [Sleep Mode])
 - During motion picture recording
 - While recording still pictures (during self-timer countdown)
 - When using [Time Lapse Shot]
 - When using [Stop Motion Animation]
 - When using [Multi Exp.]
 - During motion picture playback, during slide shows, during panorama picture playback, and during continuous playback of group pictures (including pauses in each case)
 - While sending pictures by Wi-Fi
 - When connected to computer/printer
- You cannot transfer still pictures in RAW format, AVCHD motion pictures, or MP4 motion pictures with [Rec Quality] of [4K].

Taking pictures via a smartphone (remote recording)

1 Connect to a smartphone (→229)

2 Select [] from “Image App”

3 Take pictures

- The recorded images are saved in the camera.
- When using zoom, the camera could tilt when the lens barrel extends. Make sure to secure the camera in place with a tripod or by other means.
- Some settings are not available.

Playing back pictures in the camera on a smartphone

1 Connect to a smartphone (→229)

2 Select [▶] from “Image App”

- The images captured by the camera are displayed on the smartphone.
- You can switch a picture to be displayed using the icon at the top left on the screen. Select [LUMIX] to display a picture saved in the camera.
- When the picture is touched, it is played back at a larger size.

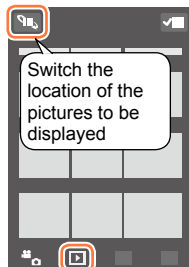

Saving pictures in the camera to the smartphone

1 Connect to a smartphone (→229)

2 Select [▶] from “Image App”

3 Press and hold the picture and drag it to save it on the smartphone

- The picture is saved on the smartphone.
- Functions can be assigned to the top, bottom, left and right as you wish.



Not available in the following case:

- You cannot save still pictures in RAW format, AVCHD motion pictures, or MP4 motion pictures with [Rec Quality] of [4K].

Easily transferring pictures in the camera

You can establish a Wi-Fi connection using the NFC function and easily transfer over Wi-Fi the picture on display simply by holding the smartphone close to the camera. Pictures can be transferred as soon as they are recorded, so you can easily transfer them to your friends' and family's smartphones.*

* "Image App" must be installed to use this function.

Preparations

(On the camera)

- Set [NFC Operation] to [ON] (→272)
- Set [Touch Sharing] to [ON] (→272)

(On your smartphone)

- Check if your smartphone is a compatible model
- Set Wi-Fi function to "ON"
- Install "Image App" in advance (→228)

- 1 On the camera, play back the picture you wish to transfer to a smartphone**
- 2 Start "Image App" on the smartphone you are transferring the picture to**
- 3 While the [] is displayed on the connection screen of the "Image App", hold the smartphone close to the camera**
 - It will be transferred to the smartphone.
 - If you are transferring multiple pictures, repeat steps **1** and **3**. (Multiple pictures cannot be transferred in one batch.)
 - It may take several minutes to complete the picture transfer depending on the environment used.

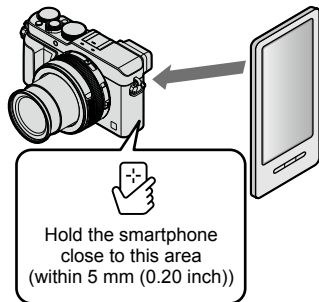

Sending pictures in the camera to social networking services

1 Connect to a smartphone (→229)

2 Select [] from “Image App”

3 Press and hold the picture and drag it to send it to the social networking service, etc.

- The picture will be sent to the social networking service or other WEB services.
- Functions can be assigned to the top, bottom, left and right as you wish.

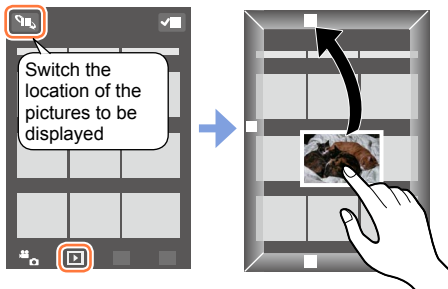

Adding location information to pictures in the camera from a smartphone

You can send the location information acquired from a smartphone to the camera. After the information is sent, you can write it on the pictures in the camera.

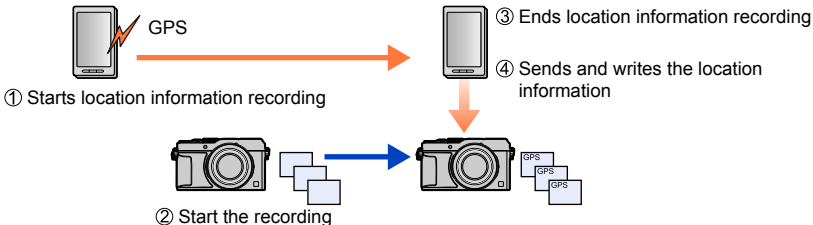

- Location information that is different from the information acquired during recording may be written. Take care regarding the following matters.
 - Set [Home] of [World Time] of the camera to your home area.
 - Once a smartphone starts recording the location information, do not change the [Home] setting of [World Time] of the camera.
- The location information cannot be written to pictures recorded without setting [Clock Set].

Operating the camera by connecting it to a smartphone

Starts location information recording

① Operate the smartphone

- ① Select [📶]
- ② Select [Geotagging]
- ③ Select [▶]



Ends location information recording

① Operate the smartphone

- ① Select [📶]
- ② Select [Geotagging]
- ③ Select [⏸]



Sends and writes the location information

① Connect to a smartphone (→229)

② Operate the smartphone

- ① Select [📶]
- ② Select [Geotagging]
- ③ Select [📶]

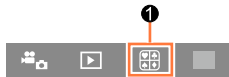

- Follow the messages on the screen to perform the operation.
- Location information will not be written to AVCHD motion pictures.
- Location information may not be written if there is not enough free space on your card.
- You can also use [Location Logging] in the [Playback] menu to write the sent location information to the pictures.

● **Caution:**

Be sure to pay special attention to the privacy, the likeness rights, etc. of the subject when you use this function. Use at your own risk.

- On the smartphone, you can set the acquisition interval of location information and check the transfer status of location information. Refer to [Help] in the "Image App" menu for details.
- (When using "Image App" for iOS)
If you press the Home or On/Off button of a smartphone while location information recording is in progress, recording is stopped.

Operating the camera to send pictures to a smartphone

■ Sending method, and pictures that can be sent

	JPEG	RAW	MP4	AVCHD
[Send Images While Recording] (→240)	○	—	—	—
[Send Images Stored in the Camera] (→241)	○	—	○*	—

*Excluding motion pictures recorded with [Rec Quality] of [4K]

- Some images may not be played back or sent depending on the device.
- See the operating instructions of the destination device for more information about picture playback.
- For more details about picture sending methods. (→270)

Preparation

Install "Image App" in advance. (→228)

[Send Images While Recording]**1 Set the menu**

Wi-Fi → **[New Connection]** → **[Send Images While Recording]** → **[Smartphone]**

2 Select [Via Network] or [Direct] and press [MENU/SET]**■ When connecting with [Via Network]****(On the camera)**

① Connect the camera to a wireless access point (→264)

(On your smartphone)

② Set Wi-Fi function to "ON"

③ Select the wireless access point you connected to the camera, and set

④ Start "Image App" (→228)

■ When connecting with [Wi-Fi Direct] or [WPS Connection] in [Direct]**(On the camera)**

① Connect the camera to a smartphone (→267)

(On your smartphone)

② Start "Image App" (→228)

■ When connecting with [Manual Connection] in [Direct]

Perform step 2 (→229).

3 Select the device you wish to connect to

- When the connection is established, the confirmation screen for the transmission setting is displayed. Check the setting and press [MENU/SET]. To change the send setting, press the [DISP.] button. (→271)

4 Take still pictures

- The still pictures are sent automatically after taking them.
- To change the setting or disconnect, press [Wi-Fi] button. You cannot change the settings while sending still pictures. Wait until sending is complete.

(You can also close the connection by pressing **MENU** →  [Setup] → [Wi-Fi] → [Wi-Fi Function] → [Yes].)

[Send Images Stored in the Camera]

1 Set the menu

Wi-Fi → **[New Connection]** → **[Send Images Stored in the Camera]**
→ **[Smartphone]**

2 Select **[Via Network]** or **[Direct]** and press **[MENU/SET]**

■ When connecting with **[Via Network]**

(On the camera)

① Connect the camera to a wireless access point (→264)

(On your smartphone)

② Set Wi-Fi function to "ON"

③ Select the wireless access point you connected to the camera, and set

④ Start "Image App" (→228)

■ When connecting with **[Wi-Fi Direct]** or **[WPS Connection]** in **[Direct]**

(On the camera)

① Connect the camera to a smartphone (→267)

(On your smartphone)

② Start "Image App" (→228)

■ When connecting with **[Manual Connection]** in **[Direct]**

Perform step 2 (→229).

3 Select the device you wish to connect to

- When the connection is established, the confirmation screen for the transmission setting is displayed. Check the setting and press **[MENU/SET]**. To change the send setting, press the **[DISP.]** button. (→271)

4 Select **[Single Select]** or **[Multi Select]**

[Single Select]

① Select the picture

② Press **[MENU/SET]**

[Multi Select]

① Select the picture (repeat)

- If selected again, the setting will be cancelled.

② Select **[OK]**

- The number of pictures that can be sent by **[Multi Select]** is limited.

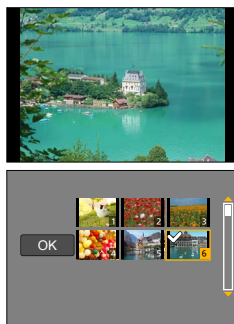

- A confirmation screen is displayed. If you select **[Yes]**, the operation is executed.
- To change the send setting, press **[DISP.]** button.
- To close the connection, select **[Exit]**.

Displaying still pictures on a TV

You can display still pictures on a TV that is compatible with a DLNA certified digital media renderer (DMR) function.

Preparation

Set the TV to DLNA waiting Mode.

- Read the operating instructions for your TV.

1 Set the menu

Wi-Fi → **[New Connection]** → **[Playback on TV]**

2 Select **[Via Network]** or **[Direct]** to connect (→263)

3 Select the device you wish to connect to

- When the connection is established, the screen is displayed.

4 Take or play back still pictures on this unit

- To change the setting or disconnect, press **[Wi-Fi]** button. (→226)

(You can also close the connection by pressing **MENU** →  **[Setup]** → **[Wi-Fi]** → **[Wi-Fi Function]** → **[Yes]**.)

- When you display the pictures on a TV using the Wi-Fi function, they are not output using 4K resolution. To output pictures using 4K resolution, connect this unit to the TV using an HDMI micro cable. (→276)
- When a TV is connected to this unit, the TV screen may temporarily return to the status before the connection. Pictures are displayed again when you take or play back pictures.
- Even if **[Effect]** and **[Sound]** are set on this unit, these settings are disabled when the pictures are played back on a TV during Slide Show playback.
- It may take some time to establish the Wi-Fi connection or it may not be connected at all depending on the distance from this unit to the TV.



Not available in the following cases:

- Playback of motion pictures or panorama pictures, and continuous playback of group pictures are not displayed on a TV.
- During the multi/calendar playback, pictures displayed on the screen of this unit are not displayed on TV.

Wireless printing

You can print out recorded still pictures wirelessly from a PictBridge (wireless LAN-compatible)* printer.

* Compliant with the DPS over IP standards.

Contact the printer manufacturers for details on PictBridge (wireless LAN-compatible) printers.

■ Sending method, and pictures that can be sent

	JPEG	RAW	MP4	AVCHD
[Send Images Stored in the Camera]	○	—	—	—

- Some images may not be played back or sent depending on the device.
- For more details about picture sending methods. ([→270](#))

1 Set the menu

Wi-Fi → [New Connection] → [Send Images Stored in the Camera] → [Printer]

2 Select [Via Network] or [Direct] to connect ([→263](#))

3 Select a printer you want to connect

4 Select the still picture and print

- Pictures are selected the same way as when connecting by USB connection cable (supplied). For more details ([→287](#)).
- To change the setting or disconnect, press [Wi-Fi] button. ([→226](#))
(You can also close the connection by pressing the [⏏/➔] button.)



Not available in the following case:

- Motion pictures cannot be printed.

Sending pictures to AV device

Still pictures and motion pictures can be sent to AV devices in the home (home AV devices), such as DLNA compatible recorders.

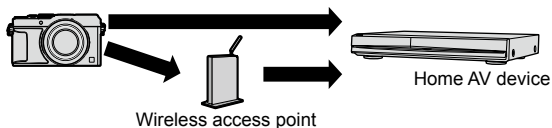

■ Sending method, and pictures that can be sent

	JPEG	RAW	MP4	AVCHD
[Send Images While Recording] (→245)	○	–	–	–
[Send Images Stored in the Camera] (→246)	○	–	–	–

- Some images may not be played back or sent depending on the device.
- See the operating instructions of the destination device for more information about picture playback.
- For more details about picture sending methods. (→270)

Preparations

When sending a picture to AV devices, set your device to DLNA waiting Mode.

- Read the operating instructions of your device for details.

[Send Images While Recording]**1 Set the menu**

Wi-Fi → **[New Connection]** → **[Send Images While Recording]** → **[AV device]**

2 Select [Via Network] or [Direct] to connect (→263)**3 Select the device you wish to connect to**

- When the connection is established, the confirmation screen for the transmission setting is displayed. Check the setting and press [MENU/SET]. To change the send setting, press [DISP.] button. (→271)

4 Take still pictures

- To change the setting or disconnect, press [Wi-Fi] button. (→226)
You cannot change the settings while sending still pictures. Wait until sending is complete.
(You can also close the connection by pressing **MENU** →  [Setup] → [Wi-Fi] → [Wi-Fi Function] → [Yes].)

[Send Images Stored in the Camera]

1 Set the menu

Wi-Fi → [New Connection] → [Send Images Stored in the Camera]
→ [AV device]

2 Select [Via Network] or [Direct] to connect (→263)

3 Select the device you wish to connect to

- When the connection is established, the confirmation screen for the transmission setting is displayed. Check the setting and press [MENU/SET]. To change the send setting, press [DISP.] button. (→271)

4 Select [Single Select] or [Multi Select]

[Single Select]

- ① Select the picture
- ② Press [MENU/SET]

[Multi Select]

- ① Select the picture (repeat)
 - If selected again, the setting will be cancelled.
- ② Select [OK]
 - The number of pictures that can be sent by [Multi Select] is limited.

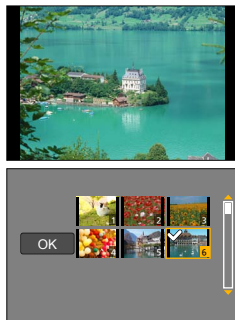

- A confirmation screen is displayed. If you select [Yes], the operation is executed.
- To change the send setting, press [DISP.] button.
- To close the connection, select [Exit].

Sending pictures to a PC

Still pictures and motion pictures recorded by the camera can be sent to a PC.

■ Sending method, and pictures that can be sent

	JPEG	RAW	MP4	AVCHD*
[Send Images While Recording] (→249)	○	○	—	—
[Send Images Stored in the Camera] (→250)	○	○	○	○

*Motion pictures recorded in [AVCHD] can be sent in file sizes of up to 4 GB. Files larger than 4 GB cannot be sent.

- Some images may not be played back or sent depending on the device.
- See the operating instructions of the destination device for more information about picture playback.
- For more details about picture sending methods. ([→270](#))

Preparations

- Turn the computer on.
- Prepare folders for receiving images on the PC before sending a picture to the PC. ([→248](#))
- If the standard settings are changed for the workgroup on the connected PC, you must change settings in [PC Connection] on this unit. ([→272](#))

To create a folder that receives images

- Create a PC user account (account name (up to 254 characters) and password (up to 32 characters)) consisting of alphanumeric characters. An attempt to create a receive folder may fail if the account includes non-alphanumeric characters.

■ When using “PHOTOfunSTUDIO”

① Install “PHOTOfunSTUDIO” on the PC

- “PHOTOfunSTUDIO” is not compatible with Mac.
- For details on hardware requirements and installation, read “Installing supplied software” (→281, 283).

② Create a folder that receives images with “PHOTOfunSTUDIO”

- To create the folder automatically, select [Auto-create]. To specify a folder, create a new folder, or set a password to the folder, select [Create manually].
- For details, refer to the operating instructions of “PHOTOfunSTUDIO” (PDF).

■ When not using “PHOTOfunSTUDIO”

(For Windows)

Supported OS: Windows 8.1 / Windows 8 / Windows 7 / Windows Vista

Example: Windows 7

① Select a folder you intend to use for receiving, then right-click

② Select [Properties], then enable sharing of the folder

- For details, refer to the operating instructions of your PC or Help on the operating system.

(For Mac)

Supported OS: OS X v10.5 to v10.9

Example: OS X v10.8

① Select a folder you intend to use for receiving, then click on the items in the following order

[File] → [Get Info]

② Enable sharing of the folder

- For details, refer to the operating instructions of your PC or Help on the operating system.

[Send Images While Recording]**1 Set the menu**

Wi-Fi → **[New Connection]** → **[Send Images While Recording]** → **[PC]**

2 Select [Via Network] or [Direct] to connect (→263)**3 Select the PC you want to connect to**

- If the PC you want to connect to is not displayed, select [Manual Input], then enter the computer name (for Mac, enter the NetBIOS name).

4 Select the folder you want to send to

- When the connection is established, the confirmation screen for the transmission setting is displayed. Check the setting and press [MENU/SET]. To change the send setting, press [DISP.] button. (→271)

5 Take still pictures

- To change the setting or disconnect, press [Wi-Fi] button. (→226)
You cannot change the settings while sending still pictures. Wait until sending is complete.
(You can also close the connection by pressing **MENU** →  [Setup] → [Wi-Fi] → [Wi-Fi Function] → [Yes].)

[Send Images Stored in the Camera]

1 Set the menu

Wi-Fi → **[New Connection]** → **[Send Images Stored in the Camera]** → **[PC]**

2 Select **[Via Network]** or **[Direct]** to connect (→263)

3 Select the **PC** you want to connect to

- If the PC you want to connect to is not displayed, select **[Manual Input]**, then enter the computer name (for Mac, enter the NetBIOS name).

4 Select the folder you want to send to

- When the connection is established, the confirmation screen for the transmission setting is displayed. Check the setting and press **[MENU/SET]**. To change the send setting, press **[DISP.]** button. (→271)

5 Select **[Single Select]** or **[Multi Select]**

[Single Select]

- ① Select the picture
- ② Press **[MENU/SET]**

[Multi Select]

- ① Select the picture (repeat)
 - If selected again, the setting will be cancelled.
- ② Select **[OK]**
 - The number of pictures that can be sent by **[Multi Select]** is limited.

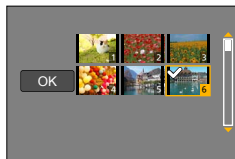

- A confirmation screen is displayed. If you select **[Yes]**, the operation is executed.
- To change the send setting, press **[DISP.]** button.
- To close the connection, select **[Exit]**.

- Folders sorted by the sent date are created in the specified folder, and pictures are saved in those folders.
- If the screen for a user account and password entry appears, enter the one you set on your PC.
- If the computer name (for Mac, the NetBIOS name) contains spaces, etc., the name may not be properly recognised. If you cannot connect, we recommend changing the computer name (for Mac, the NetBIOS name) to a combination of 15 or less alphanumeric characters only.

Using WEB services

Through “LUMIX CLUB”, you can send still pictures and motion pictures to social networking services, etc. By selecting the setting to automatically transfer still pictures and motion pictures to [Cloud Sync. Service], you can receive the transferred still pictures and motion pictures on a PC or a smartphone.

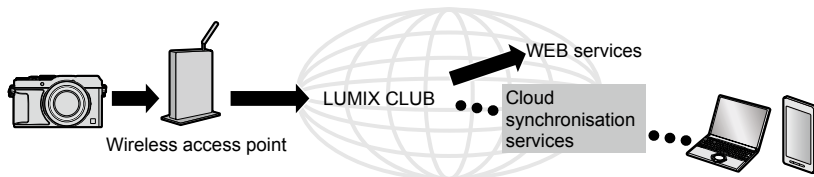

When sending images to WEB service

■ Sending method, and pictures that can be sent

	JPEG	RAW	MP4	AVCHD
[Send Images While Recording] (→253)	○	—	—	—
[Send Images Stored in the Camera] (→253)	○	—	○*	—

*Excluding motion pictures recorded with [Rec Quality] of [4K]

- Some images may not be played back or sent depending on the device.
- For details about playback of pictures, check the WEB service to which you will send the pictures.
- For more details about picture sending methods. ([→270](#))

Preparation

You need to register to “LUMIX CLUB” ([→258](#)) to send a picture to a WEB service. To send images to a WEB service, you need to register the WEB service. ([→252](#))

- Images may contain personal information that can be used to identify the user, such as a title, the time and date when the images were taken, and the location where the image was taken. Check this information before uploading images to WEB services.
- Panasonic assumes no responsibility for the damages resulting from the leakage, loss, etc. of images uploaded on WEB services.
- When uploading images to the WEB service, do not delete images from this camera, even after they have finished sending, until you have checked that they have been properly uploaded to the WEB service. Panasonic assumes no responsibility for the damages resulting from the deletion of images stored in this unit.
- Images uploaded to the WEB service cannot be displayed or deleted with this camera. Check images by accessing the WEB service with your smartphone or computer.
- If sending images fails, a report email outlining the failure will be sent to the email address registered with "LUMIX CLUB".

Registering the WEB service to "LUMIX CLUB"

When sending images to WEB services, the WEB service being used must be registered with the "LUMIX CLUB".

- Check the "FAQ/Contact us" on the following site for compatible WEB services.
http://lumixclub.panasonic.net/eng/c/lumix_faqs/

Preparation

Make sure that you have created an account on the WEB service you want to use, and have the login information available.

- 1 Connect to the "LUMIX CLUB" site using a smartphone or computer**
<http://lumixclub.panasonic.net/eng/c/>
- 2 Enter your "LUMIX CLUB" login ID and password and log in to the service**
- 3 If you have not registered your email address with "LUMIX CLUB", register the email address**
- 4 Select the WEB service to be used for WEB service link settings and register it**
 - Follow the instructions on the screen to register the service.

[Send Images While Recording]

1 Set the menu

Wi-Fi → [New Connection] → [Send Images While Recording] → [Web service]

2 Select [Via Network] and connect (→264)

3 Select a WEB service you want to connect

- When the connection is established, the confirmation screen for the transmission setting is displayed. Check the setting and press [MENU/SET]. To change the send setting, press [DISP.] button. (→271)

4 Take still pictures

- To change the setting or disconnect, press [Wi-Fi] button. (→226)
You cannot change the settings while sending still pictures. Wait until sending is complete.
(You can also close the connection by pressing **MENU** →  [Setup] → [Wi-Fi] → [Wi-Fi Function] → [Yes].)

[Send Images Stored in the Camera]

1 Set the menu

Wi-Fi → [New Connection] → [Send Images Stored in the Camera]
→ [Web service]

2 Select [Via Network] and connect (→264)

3 Select a WEB service you want to connect

- When the connection is established, the confirmation screen for the transmission setting is displayed. Check the setting and press [MENU/SET]. To change the send setting, press [DISP.] button. (→271)

4 Select [Single Select] or [Multi Select]

[Single Select]

- ① Select the picture
- ② Press [MENU/SET]

[Multi Select]

- ① Select the picture (repeat)
 - If selected again, the setting will be cancelled.
- ② Select [OK]
 - The number of pictures that can be sent by [Multi Select] is limited.

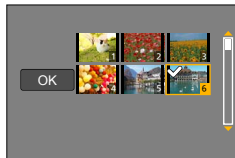

- A confirmation screen is displayed. If you select [Yes], the operation is executed.
- To change the send setting, press [DISP.] button.
- To close the connection, select [Exit].

■ Quickly sending pictures in the camera to WEB services

Once you send a picture, you can send pictures to the WEB service as quickly and easily as using a smartphone, only when the environment for connecting to a wireless access point is available.

① Display the picture



② Use ◀▶ to select [Yes] after pressing ▼
 (When a group picture is being displayed, select [Upload(Wi-Fi)] → [Yes])

- The camera is connected to the previously used wireless access point and the pictures are sent to the WEB service.*1,*2



*1 When no connection history is available for the wireless access point, proceed to the connection method selection screen. Select the connection method and connect the camera to a wireless access point. (→264)

*2 If you do not have a "LUMIX CLUB" login ID, proceed to the new login ID sign up screen. Get a login ID and set a password. (→259)

Performing the operation for the first time

After you select [Yes] in step ② above, the WEB service selection screen appears.

- ① Use ▲▼◀▶ to select WEB services and press [MENU/SET]
- ② Check the setting on the confirmation screen for the transmission setting and press [MENU/SET]
 - The picture is sent to the WEB service.
 - To change the transmission setting for the picture, press the [DISP.] button. (→271)
 - After the second time, the pictures are sent using the same WEB service and the same picture transmission settings as before.

- When pictures are displayed as a group, they are all sent. When a single picture in a group is displayed, only the picture being displayed is sent.
- To change the transmission settings of a picture or to close the Wi-Fi connection, press the [Wi-Fi] button. You can also close the connection by pressing the Playback button or [MENU/SET] and selecting [Yes]. When you switch to Recording Mode, the Wi-Fi connection is closed.

When sending images to [Cloud Sync. Service]

■ Sending method, and pictures that can be sent

	JPEG	RAW	MP4	AVCHD
[Send Images While Recording] (→256)	○	—	—	—
[Send Images Stored in the Camera] (→257)	○	—	○*	—

*Excluding motion pictures recorded with [Rec Quality] of [4K]

- Some images may not be played back or sent depending on the device.
- See the operating instructions of the destination device for more information about picture playback.
- For more details about picture sending methods. (→270)

Preparation

You need to register to “LUMIX CLUB” (→258) and configure the Cloud Sync. setting to send a picture to a Cloud Folder. Use “PHOTOfunSTUDIO” on a PC or “Image App” on a smartphone to configure the Cloud Sync. settings.

■ About the images sent to a Cloud Folder by the use of [Cloud Sync. Service] (Current as of September 2014)

- If you set the picture destination to [Cloud Sync. Service], sent pictures are temporarily saved in the cloud folder, and they can be synchronised with the device in use, such as the PC or smartphone.
- A Cloud Folder stores transferred images for 30 days (up to 1,000 pictures). Transferred images are deleted automatically 30 days after the transfer. Furthermore, when the number of stored images exceeds 1,000, some images may be deleted depending on the [Cloud Limit] (→271) setting even within 30 days after the transfer.
- When the download of images from a Cloud Folder to all specified devices is complete, images may be deleted from the Cloud Folder even within 30 days after the transfer.

[Send Images While Recording]**1 Set the menu**

Wi-Fi → [New Connection] → [Send Images While Recording]
→ [Cloud Sync. Service]

2 Check the message and press [MENU/SET]**3 Select [Via Network] and connect (→264)****4 Check the send setting**

- When the connection is established, the confirmation screen for the transmission setting is displayed. Check the setting and press [MENU/SET]. To change the send setting, press [DISP.] button. (→271)

5 Take still pictures

- To change the setting or disconnect, press [Wi-Fi] button. (→226)
You cannot change the settings while sending still pictures. Wait until sending is complete.
(You can also close the connection by pressing **MENU** →  [Setup] → [Wi-Fi] → [Wi-Fi Function] → [Yes].)

[Send Images Stored in the Camera]

1 Set the menu

Wi-Fi → [New Connection] → [Send Images Stored in the Camera]
→ [Cloud Sync. Service]

2 Check the message and press [MENU/SET]

3 Select [Via Network] and connect (→264)

4 Check the send setting

- When the connection is established, the confirmation screen for the transmission setting is displayed. Check the setting and press [MENU/SET]. To change the send setting, press [DISP.] button. (→271)

5 Select [Single Select] or [Multi Select]

[Single Select]

- ① Select the picture
- ② Press [MENU/SET]

[Multi Select]

- ① Select the picture (repeat)
 - If selected again, the setting will be cancelled.
- ② Select [OK]
 - The number of pictures that can be sent by [Multi Select] is limited.

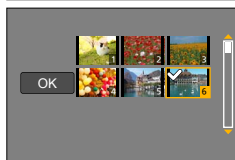

- A confirmation screen is displayed. If you select [Yes], the operation is executed.
- To change the send setting, press [DISP.] button.
- To close the connection, select [Exit].

Using “LUMIX CLUB”

About the [LUMIX CLUB]

Acquire a “LUMIX CLUB” login ID (free).

If you register this unit to the “LUMIX CLUB”, you can synchronise images between the devices you are using, or transfer these images to WEB services.

Use the “LUMIX CLUB” when uploading pictures to WEB services.

- You can set the same “LUMIX CLUB” login ID for this unit and a smartphone. (→261)

Refer to the “LUMIX CLUB” site for details.
<http://lumixclub.panasonic.net/eng/c/>

Please note;

- The service may be suspended due to regular maintenance or unexpected problems, and service contents may be changed or added to, without prior notice to the users.
- The service may be stopped in whole or in part with a reasonable period of advance notice.

Acquiring a new login ID ([New account])

1 Set the menu

MENU →  [Setup] → [Wi-Fi] → [Wi-Fi Setup] → [LUMIX CLUB]

2 Select [Set/Add Account]

3 Select [New account]

- Connect to the network. Proceed to the next page by pressing [MENU/SET].
- A confirmation screen will be displayed if a login ID has already been acquired for the camera. Select [Yes] to acquire a new login ID, or [No] if you do not need to acquire a new login ID.

4 Select the method for connecting to a wireless access point, and set

- For details (→264).
- The settings screen will only appear during the first connection. Connection methods set on this unit are stored and will be used for subsequent connections. If you want to change the wireless access point to connect to, press the [DISP.] button, then change the connecting destination.

5 Read through the "LUMIX CLUB" terms of use and press [MENU/SET]

- You can press ▲▼ to switch pages.
- Turn the zoom lever clockwise to enlarge the page display (x2 magnification).
- If you turn the zoom lever counterclockwise after enlarging the page, the page returns to its original size (no magnification).
- You can use ▲▼◀▶ to move the position of the area to be enlarged.
- Press [/S] button to cancel the process without acquiring a login ID.

6 Enter the password

- Enter any combination of 8 to 16 characters and numbers for the password.
- For details on how to enter characters, refer to "Entering Text" (→52).

7 Check the login ID and press [MENU/SET]

- The login ID (12-digit number) will be displayed automatically. When logging in to the "LUMIX CLUB" with a computer, you only need to enter the numbers.
- A message is displayed when the connection is complete. Press [MENU/SET].
- Be sure to make a note of the login ID and password.

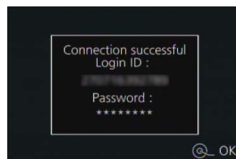

Using a previously acquired login ID/confirming and changing login ID and password ([Set Login ID])

Preparation

To use a previously acquired login ID, confirm your ID and password.

To change the "LUMIX CLUB" password on the camera, access the "LUMIX CLUB" website from your smartphone or PC and change the "LUMIX CLUB" password in advance.

1 Set the menu

MENU →  [Setup] → [Wi-Fi] → [Wi-Fi Setup] → [LUMIX CLUB]

2 Select [Set/Add Account]

3 Select [Set Login ID]

- The login ID and password are displayed.
- The password is displayed as "★".
- Close the menu if only checking the login ID.

4 Select the item you wish to change

5 Enter your login ID or password

- Refer to "Entering Text" (→52) for information on how to enter text.
- Enter the new password you have created on your smartphone or PC into the camera. If the password differs from the one you created on your smartphone or PC, you will not be able to upload images.

6 Select [Exit]

To set the same login ID for the camera and the smartphone

- Setting the same login ID on this unit and your smartphone is convenient for sending images on this unit to other devices or WEB services.

■ When either this unit or the smartphone has acquired the login ID

- ① Connect this unit to the smartphone (→229)
- ② From the "Image App" menu, set the common login ID
 - The login IDs for this unit and the smartphone become the same.
 - After connecting this unit to the smartphone, the setup screen for a common login ID may appear when you display the playback screen. You can also set a common login ID by following the on-screen instructions.
 - This operation is not available for [Wi-Fi Direct] connection.

■ When this unit and the smartphone have acquired different login IDs

When you want to use the smartphone's login ID for this unit

Change the login ID and password for this unit to those acquired by the smartphone.

When you want to use this unit's login ID for the smartphone

Change the login ID and password for the smartphone to those acquired by this unit.

Check the "LUMIX CLUB" terms of use

Check the details if the terms of use have been updated.

1 Set the menu

MENU →  [Setup] → [Wi-Fi] → [Wi-Fi Setup] → [LUMIX CLUB]

2 Select [Terms of use]

- The camera will connect to the network and the terms of use will be displayed.

Delete your login ID and account from the “LUMIX CLUB”

Delete the login ID from the camera when transferring it to another party or disposing of it. You can also delete your “LUMIX CLUB” account.

1 Set the menu

MENU →  **[Setup]** → **[Wi-Fi]** → **[Wi-Fi Setup]** → **[LUMIX CLUB]**

2 Select [Delete account]

- The message is displayed. Press [MENU/SET].

3 Select [Yes] in the login ID delete confirmation screen

- The message is displayed. Press [MENU/SET].

4 Select [Yes] on the confirmation screen for deleting the “LUMIX CLUB” account

- If you want to continue using the service, selecting [No] will only delete the login ID. Exit the menu after it is executed.

5 Press [MENU/SET]

- The login ID is deleted, and then the message notifying the deletion of your account is displayed. Press [MENU/SET].

- Changes and other actions to login IDs can only be made to the login ID acquired with the camera.

About connections

After selecting the Wi-Fi function and sending destination, select the connection method. If you are out and unable to use your wireless access point, or temporarily connecting to equipment you do not ordinarily use, or in a similar situation, it is convenient to make a direct connection.

If you are connecting with the same settings as used previously, you can quickly start using the Wi-Fi function by connecting with [Select a destination from History] or [Select a destination from Favorite].

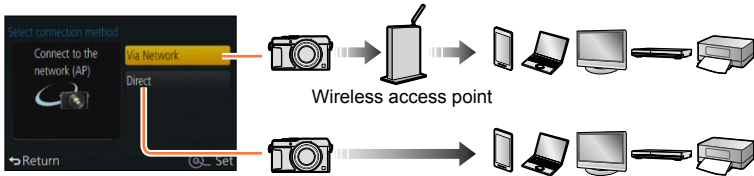

Connection method	Description	
[Via Network]	Connects through a wireless access point.	(→264)
[Direct]	Your equipment connects directly to the camera.	(→267)

[Via Network] Connecting via a wireless access point

Select a connection method to the wireless access point.

- WPS refers to a function that allows you to easily configure the settings related to the connection and security of wireless LAN devices. To check if the wireless access point you are using is compatible with WPS, refer to the instruction manual of the wireless access point.

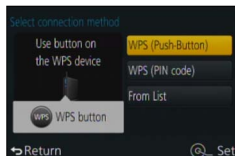

Connection method	Description
[WPS (Push-Button)]	<p>Save push button type wireless access point that is compatible with Wi-Fi Protected Setup™ with a WPS mark.</p> <ol style="list-style-type: none"> 1 Press the wireless access point WPS button until it switches to WPS Mode <ul style="list-style-type: none"> • Refer to the wireless access point instruction manual for details.
[WPS (PIN code)]	<p>Save PIN code type wireless access point that is compatible with Wi-Fi Protected Setup with a WPS mark.</p> <ol style="list-style-type: none"> 1 Select the wireless access point you are connecting to 2 Enter the PIN code displayed on the camera screen into the wireless access point 3 Press [MENU/SET] <ul style="list-style-type: none"> • Refer to the wireless access point instruction manual for details.
[From List]	<p>Select this option when you are not sure about the WPS compatibility, or when you want to search for and connect to a wireless access point.</p> <ul style="list-style-type: none"> • For details (→265).

If you are not sure about the WPS compatibility (connecting by [From List])

Search for available wireless access points.

- Confirm encryption key of the selected wireless access point if the network authentication is encrypted.
- When connecting by [Manual Input], confirm SSID, network authentication type, encryption type, encryption key of the wireless access point you are using.

1 Select the wireless access point you are connecting to

- Pressing [DISP.] button will search for a wireless access point again.
- If no wireless access point is found, refer to “When connecting with [Manual Input]” (→266).

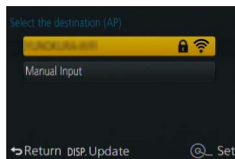

2 (If network authentication is encrypted)

Enter the encryption key

- For details on how to enter characters, refer to “Entering Text” (→52).

■ When connecting with [Manual Input]

- ① On the screen of step **1** of “If you are not sure about the WPS compatibility (connecting by [From List])”, select [Manual Input] (→265)
- ② Enter the SSID of the wireless access point you are connecting to, then select [Set]
 - For details on how to enter characters, refer to “Entering Text” (→52).
- ③ Select the network authentication type
 - For information on network authentication, see the instruction manual of the wireless access point.
- ④ Select the encryption type
 - The type of settings that can be changed may vary depending on the details of network authentication settings.

Network authentication type	Encryption types that can be set
[WPA2-PSK] / [WPA-PSK]	[TKIP] / [AES]
[Common Key]	[WEP]
[Open]	[No Encryption] / [WEP]

(When an option other than [No Encryption] is selected)

- ⑤ Enter the encryption key
- Check the wireless access points instruction manual and settings when a saving wireless access point.
 - If no connection can be established, the wireless access point's radio waves may be too weak. Refer to “Message displays” (→299) and “Q&A Troubleshooting” (→310) for details.
 - Transmission speed may decrease, or may not be usable depending on the environment it is used in.

[Direct] Connecting directly

You can select the connection method to your equipment. Select a connection method with which your equipment is compatible.



Connection method	Description
[Wi-Fi Direct]*1	<ol style="list-style-type: none"> 1 Set the device to Wi-Fi Direct™ mode 2 Select [Wi-Fi Direct] 3 Select the device to connect to <ul style="list-style-type: none"> • Read the operating instructions of your device for details.
[WPS Connection]**2	[WPS (Push-Button)] <ol style="list-style-type: none"> 1 Select [WPS (Push-Button)] 2 Set the device to WPS mode <ul style="list-style-type: none"> • You can wait longer for a connection by pressing the [DISP.] button on this unit.
	[WPS (PIN code)] <ol style="list-style-type: none"> 1 Select [WPS (PIN code)] 2 Enter the PIN code of the device into this unit
[Manual Connection]	<ol style="list-style-type: none"> 1 Enter the SSID and password into the device. The SSID and password are displayed on the connection waiting screen of this unit. <ul style="list-style-type: none"> • If the transfer destination is [Smartphone], you can read the QR Code with your smartphone to connect. (→229)

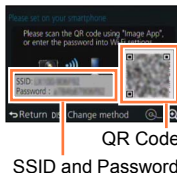
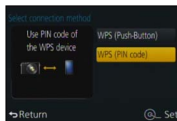
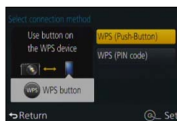

*1 To connect this unit with [Wi-Fi Direct], Android OS 4.0 or above is required and the device must be compatible with Wi-Fi Direct™.

*2 WPS refers to a function that allows you to easily configure the settings related to the connection and security of wireless LAN devices.

Connecting quickly with the same settings as used previously ([Select a destination from History] / [Select a destination from Favorite])

The camera keeps a History of times you used the Wi-Fi function. You can register items in the History to Favourite.

You can easily connect with the same settings as used previously by connecting from History or Favourite.

1 Press [Wi-Fi] button

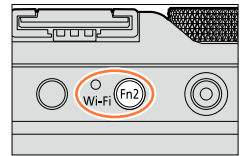

2 Select [Select a destination from History] or [Select a destination from Favorite]

Item	Description
[Select a destination from History]	Connects using the same settings as used previously.
[Select a destination from Favorite]	Connects using settings registered in Favourite.

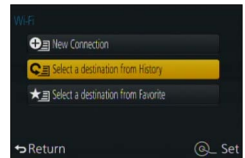

3 Select the desired connection setting

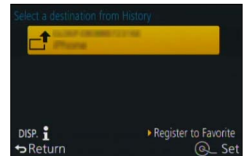

Registering History items to Favourite

1 Press [Wi-Fi] button

2 Select [Select a destination from History]

3 Select the item you wish to register and press ►

4 Enter a registration name

- For details on how to enter characters, refer to "Entering Text" (→52).
- Up to 30 characters can be entered. A double-byte character will be treated as two characters.

Editing items registered in Favourite

- 1 Press [Wi-Fi] button
- 2 Select [Select a destination from Favorite]
- 3 Select the Favourite item you wish to edit and press ►
- 4 Select item

Item	Description
[Remove from Favorite]	—
[Change the Order in Favorite]	Select the destination
[Change the Registered Name]	<ul style="list-style-type: none"> • For details on how to enter characters, refer to "Entering Text" (→52). • Up to 30 characters can be entered. A double-byte character will be treated as two characters.



Registering and saving frequently used Wi-Fi connection settings to Favourites

- The number of settings that can be saved in the history is limited. We recommend that you register and save frequently used Wi-Fi connection settings to Favourite. ([→268](#))



Checking connection details of History or Favourite

- When selecting History or Favourite items, you can view connection details by pressing the [DISP.] button.

- Performing [Reset Wi-Fi Settings] deletes content registered in History and Favourite.
- When using [Select a destination from History] or [Select a destination from Favorite] to connect to a network to which many PCs are connected, it may be difficult to make the connection because the camera searches for previously connected equipment out of a large number of equipment pieces. If you cannot connect, retry the connection using [New Connection].

Settings for sending pictures

When sending pictures, first select [New Connection], then select the method of sending pictures.

After you have completed connecting, you can also change the sending settings, such as the size of pictures to be sent.

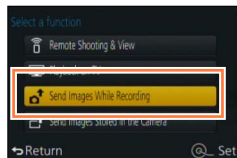

[Send Images While Recording]

A picture can be automatically sent to a specified device every time you take it.

- [Wi-Fi] is displayed on the recording screen while connected by [Send Images While Recording], and [Send] is displayed while files are being sent.
- If you turn off the camera before you have completed sending, or if you close the Wi-Fi connection, or in similar situations, unsent files will not be resent.
- You may not be able to delete files or use the [Playback] menu while sending.

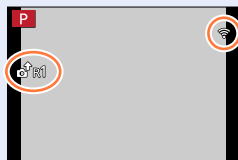

Not available in the following case:

- Motion pictures cannot be sent.

[Send Images Stored in the Camera]

You can select and send recorded images.

- Details of the [Playback] menu [Favorite] or [Print Set] settings will not be sent.

Not available in the following cases:

- Some images taken with a different camera may not be able to be sent.
- Images that have been modified or edited with a computer may not be able to be sent.

Changing the settings for sending images

After you have completed connecting, you can change the sending settings, such as the size of pictures to be sent, by pressing the [DISP.] button.

Item	Description
[Size]	Resize the image to send. [Original] / [Auto]*1 / [Change] <ul style="list-style-type: none"> If you select [Auto], the image size is determined by the circumstances at the destination. You can select the image size for [Change] from [M], [S], or [VGA]. The aspect ratio does not change.
[File Format]*2	[JPG] / [RAW+JPG] / [RAW]
[Delete Location Data]*3	Select whether to delete the location information from images before sending them. [ON]: Delete the location information, then send. [OFF]: Keep the location information and send. <ul style="list-style-type: none"> This operation only deletes the location information from the images that are set to be sent. (The location information will not be deleted from the original images stored in this unit.)
[Cloud Limit]*4	You can select whether to send images when the Cloud Folder runs out of free space. [ON]: Do not send images. [OFF]: Delete images from the oldest ones, then send new images.

*1 Only available when the destination is set to [Web service].

*2 Only available when the destination is set to [PC].

*3 Only available when the destination for [Send Images Stored in the Camera] is set to [Cloud Sync. Service] or [Web service].

*4 Only available when the destination is set to [Cloud Sync. Service].

[Wi-Fi Setup]

Configure the settings required for the Wi-Fi function.
[Wi-Fi Setup] cannot be changed when connected to Wi-Fi.

1 Set the menu

MENU →  **[Setup]** → **[Wi-Fi]** → **[Wi-Fi Setup]** → **Desired setting**

Item	Description
[LUMIX CLUB] Acquires or changes the "LUMIX CLUB" login ID.	<ul style="list-style-type: none"> For details (→258).
[PC Connection] You can set the workgroup.	<p>You must connect to the same workgroup as the destination computer when sending pictures to the computer. (The default is set to "WORKGROUP")</p> <p>[Change Workgroup Name]: Enter the workgroup of the connecting computer. Close the menu after changing settings.</p> <p>[Restore to Default]: Returns settings to default settings. A confirmation screen is displayed. It is executed when [Yes] is selected. Exit the menu after it is executed.</p> <hr/> <ul style="list-style-type: none"> Refer to "Entering Text" (→52) for information on how to enter text. To use with a computer of the standard settings, you do not have to change the workgroup.
[Device Name] You can change the name of this unit.	<ol style="list-style-type: none"> Press [DISP.] button Enter the desired device name <ul style="list-style-type: none"> Refer to "Entering Text" (→52) for information on how to enter text. Up to 32 characters can be entered.
[NFC Operation] Makes NFC function setting.	<p>[ON]: The NFC function works.</p> <p>[OFF]</p>
[Touch Sharing] Set the operation to be performed when a Wi-Fi connection is established using the NFC function.	<p>[ON]: When a Wi-Fi connection is established using the NFC function while playing back a single picture, the picture (1 picture) is transferred.</p> <p>[OFF]</p>

Item	Description
<p>[Wi-Fi Password] To prevent incorrect operation or use of the Wi-Fi function by a third party and to protect saved personal information, it is recommended that you protect the Wi-Fi function with a password.</p>	<p>Setting a password will automatically display the password input screen when the Wi-Fi function is used.</p> <p>[Setup]: Enter any 4-digit numbers as the password. Close the menu after changing settings.</p> <p>[Delete]: A confirmation screen is displayed. It is executed when [Yes] is selected. Exit the menu after it is executed.</p> <hr/> <ul style="list-style-type: none"> • For details on how to enter characters, refer to “Entering Text” (→52). • Make a copy of password. If you forget the password, you can reset it with [Reset Wi-Fi Settings] in the [Setup] menu, however other settings will also be reset. (excluding [LUMIX CLUB])
<p>[Network Address] Displays the MAC address and IP address of this unit.</p>	<ul style="list-style-type: none"> • A “MAC Address” is a unique address that is used to identify network equipment. • “IP address” refers to a number that identifies a PC connected to a network such as the Internet. Usually, the addresses for homes are automatically assigned by the DHCP function such as a wireless access point. (Example: 192.168.0.87)

Enjoying 4K motion pictures

Viewing 4K motion pictures

■ Viewing on TV screen

When you connect this unit to a 4K-compatible TV and play back a motion picture recorded with [Rec Quality] of [4K], you can enjoy high-resolution 4K motion pictures. Although resolution output will be lower, you can also play back 4K motion pictures by connecting to a high-definition TV and other devices that do not have 4K support.

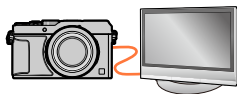

Preparation

When motion pictures are recorded in [Rec Quality] with [4K], set [HDMI Mode] (→48) to [AUTO] or [4K].

① Connect this unit to a 4K-compatible TV using an HDMI micro cable and display the playback screen (→276)

- When the [VIERA Link] setting on the camera is set to [ON] and the camera is connected to a VIERA Link (HDMI)-compatible Panasonic television (VIERA), the television automatically switches its input and the playback screen is displayed. For details, refer to (→278).
- You can also play back motion pictures by inserting the card in a 4K-compatible TV equipped with a SD card slot.
- Read the operating instructions for the TV.

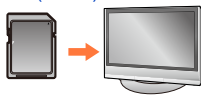

■ Viewing 4K motion pictures on a PC screen

To play back motion pictures recorded with [Rec Quality] of [4K] on a PC, use the software "PHOTOfunSTUDIO" stored in the DVD (supplied).

- To play back and edit 4K motion pictures, a high-performance PC environment is required.
- For details, refer to the operating instructions of "PHOTOfunSTUDIO" (PDF).



Storing 4K motion pictures

■ Storing 4K motion pictures on your PC

Still/motion pictures can be copied from the camera to your computer by connecting the two together. For details, refer to (→280).

■ Storing 4K motion pictures on a DVD

You cannot transfer or copy motion pictures recorded in [Rec Quality] with [4K] to a Blu-ray disc or DVD using a Panasonic recorder. (Current as of October 2014)

You can use the supplied DVD software “PHOTOfunSTUDIO” to convert the file size of a motion picture to a smaller size or copy it to a DVD.

- For details, refer to the operating instructions of “PHOTOfunSTUDIO” (PDF).

Viewing on TV screen

You can view pictures on a TV screen by connecting your camera to your TV with the HDMI micro cable or AV cable (optional).

Preparation

Turn off both camera and TV.

1 Connect camera to TV

Check the plug direction and insert it straight in. (If the cable is inserted in the wrong direction, the plug could become deformed and cause faulty operation) Also, do not insert into the wrong socket. Doing so may cause damage to this unit.

■ To connect with an HDMI micro cable

An HDMI micro cable can be used to enable viewing of still and motion pictures in high-resolution.

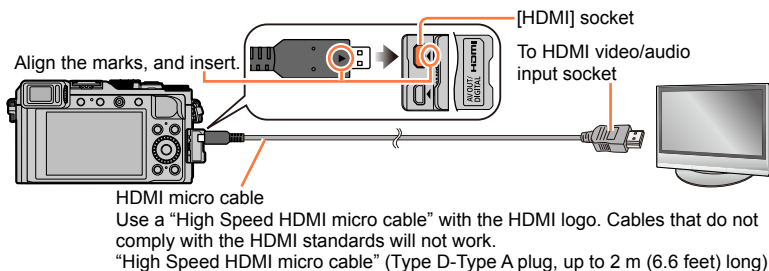

■ To connect with an AV cable (optional)

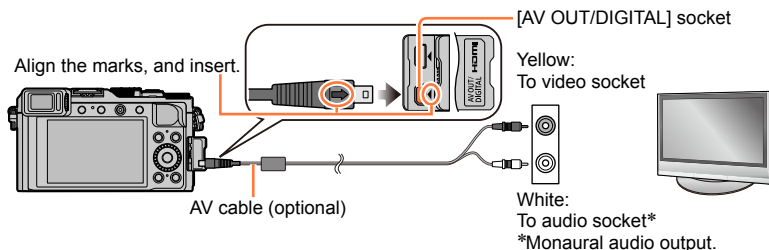

2 Turn on the TV and switch the TV input source to match the connection socket

3 Turn on the camera and press the playback button

■ To connect with an HDMI micro cable

- Check the [HDMI Mode]. (→48)
- To play back 24p motion pictures, set [HDMI Mode] to [AUTO]. Otherwise, the picture is not output at 24 frames per second.
- Bars may appear at the sides or at the top and bottom of the screen, depending on the aspect ratio setting.
- Cables that do not comply with HDMI standards will not work.
- When an HDMI micro cable is connected, pictures are not displayed on the screen.
- HDMI output will be cancelled if a USB connection cable (supplied) is connected simultaneously.
- When the AV cable (optional) and HDMI micro cable are connected at the same time, no picture is output from the AV cable.
- Pictures may be momentarily distorted immediately after commencing playback or pausing on certain televisions.
- Audio output is stereo.
- Read the operating instructions for the TV.

■ To connect with an AV cable (optional)

- Check the [TV Aspect]. (→47)
- Always use a genuine Panasonic AV cable (DMW-AVC1: optional).
- You can play back pictures on TVs in other countries (regions) which use the NTSC or PAL system. You can find [Video Out] setting in [TV Connection] from the [Setup] menu.
- Pictures rotated to portrait may be blurred slightly.
- Change picture mode settings on TV if aspect ratios are not displayed correctly on widescreen or high-definition televisions.
- The viewfinder display cannot be used.
- Read the operating instructions for the TV.

The recorded pictures can be played back on a TV with an SD Memory Card slot

- Proper playback (aspect ratio) will be dependent on the TV used for viewing.
- The file format of the motion pictures that can be played back differs depending on the TV model.
- You may not be able to play back panorama pictures. Also you cannot perform automatic scrolling playback of panorama pictures.
- For cards compatible with playback, refer to the operating instructions of the TV.

VIERA Link (HDMI) (HDAVI Control™)

What is VIERA Link (HDMI)?

- VIERA Link is a function that automatically links this camera to VIERA Link-compatible devices by connecting HDMI micro cables for enabling easy operation with the VIERA remote control. (Some operations are not available.)
- VIERA Link (HDMI) is an exclusive Panasonic function added to the industry-standard HDMI control functions known as HDMI CEC (Consumer Electronics Control). Operation is not guaranteed when connecting with non-Panasonic HDMI CEC-compatible devices. Refer to your product manual to verify compatibility with VIERA Link (HDMI).
- This camera supports VIERA Link (HDMI) Version 5. This is the Panasonic standard that also supports previous Panasonic VIERA Link devices.

Preparation

Set [VIERA Link] to [ON] (→49).

- 1 Connect the camera to a VIERA Link (HDMI)-compatible Panasonic television (VIERA) with an HDMI micro cable (→276)**
- 2 Turn on the camera and press the playback button**
- 3 Operate with the remote control for the TV**
 - Operate with reference to the operation icons displayed on the screen.

■ Other related operations

Turning the unit OFF

- The camera can also be turned off when the television is turned off with the remote control.

Automatic input select

- This function automatically switches the television input to the camera screen whenever the camera is turned on while it is connected via the HDMI micro cable. The television can also be switched on via the camera from Standby Mode (if "Power on link" on the television is set to "on").
 - If VIERA Link (HDMI) does not function correctly (→323)
- Use a "High Speed HDMI micro cable" with the HDMI logo. Cables that do not comply with the HDMI standards will not work.
"High Speed HDMI micro cable" (Type D-Type A plug, up to 2 m (6.6 feet) long)
 - If you do not know if your TV is VIERA Link (HDMI) compatible, see the TV's operating instructions.
 - Cables that do not comply with HDMI standards will not work.
 - When VIERA Link is activated, the [HDMI Mode] setting of this unit is automatically recognised.
 - If the [VIERA Link] setting on the camera is [ON], operations via the camera buttons will be limited.
 - Ensure that the television you are connecting to has been set up to enable VIERA Link (HDMI) (consult your television operating instructions for details).

Storing recorded still pictures and motion pictures on your PC

Still/motion pictures can be copied from the camera to your computer by connecting the two together.

- Some computers can read directly from the camera's memory card.
For details, see the instruction manual for your computer.
- If your computer does not support SDXC Memory Cards, a message will be displayed requesting you to format the card. (Do not format the card. This will erase recorded pictures.)

If the card is not recognised, refer to the following support website.

<http://panasonic.net/avc/sdcard/information/SDXC.html>

■ Computer specifications

You can connect the camera to a computer that can detect a mass storage device (device that stores a large volume of data).

- Windows: Windows 8.1 / Windows 8 / Windows 7 / Windows Vista
- Mac: OS X v10.5 - v10.9



Some motion pictures recorded in [AVCHD] may not be scanned correctly by copying a file or folder

- When using Windows, be sure to use the "PHOTOfunSTUDIO" software on the supplied DVD to copy motion pictures recorded in [AVCHD].
- When using Mac, you can copy motion pictures recorded in [AVCHD] using "iMovie". Note, however, that it may not be possible to copy pictures depending on the picture quality settings.
(For details about iMovie, please contact Apple Inc.)

Storing recorded still pictures and motion pictures on your PC

About supplied software

The supplied DVD contains the following software. Install the software on your computer before using.

PHOTOfunSTUDIO 9.6 PE

You can capture still pictures or motion pictures to your PC, or organise captured pictures by categorising by recording date, model name of the digital camera used to record, etc. You can also correct still pictures, edit motion pictures, or write to DVD.

• Operating environment

Supported OS	Windows® 8.1 (32-bit/64-bit) Windows® 8 (32-bit/64-bit) Windows® 7 (32-bit/64-bit) and SP1 Windows Vista® (32-bit) SP2	
CPU	Windows® 8.1	Pentium® III 1 GHz or higher
	Windows® 8	
	Windows® 7	
	Windows Vista®	Pentium® III 800 MHz or higher
Display	1024×768 pixels or more (1920×1080 pixels or more recommended)	
RAM	Windows® 8.1	1 GB or more (32-bit) / 2 GB or more (64-bit)
	Windows® 8	
	Windows® 7	
	Windows Vista®	512 MB or more
Free hard disk space	450 MB or more for installing software	

- To edit 4K motion pictures, you need the 64-bit versions of Windows 8.1, Windows 8, or Windows 7.
- Refer to the Operating Instructions of "PHOTOfunSTUDIO" (PDF) for further information about the operating environment. You can read the Operating Instructions after launching the software.

Storing recorded still pictures and motion pictures on your PC

SILKYPIX Developer Studio 4.2 SE

This software develops and edits RAW file pictures. Edited pictures can be saved in a file format such as JPEG or TIFF that can be displayed on a PC, etc.

- **Operating environment**

Supported OS	Windows® 8.1 Windows® 8 Windows® 7 Windows Vista® Mac® OS X v10.5/v10.6/v10.7/v10.8/v10.9
---------------------	---

- For details on how to use the SILKYPIX Developer Studio, refer to the “Help” or the Ichikawa Soft Laboratory’s support website:
<http://www.isl.co.jp/SILKYPIX/english/p/support/>

LoiLoScope 30 day full trial version

(Windows 8.1 / 8 / 7 / Vista)

LoiLoScope is a video editing software that draws out the full power of your PC. Creating videos is as easy as organising cards on top of a desk. Use your music, picture and video files to create videos to share with your friends and family by burning it to a DVD, uploading it to websites, or simply share your videos with your friends via e-mail.

- This will only install a shortcut to the trial version download site.
- **For more information on how to use LoiLoScope, read the LoiLoScope manual available for download at the link below.**
Manual URL: <http://loilo.tv/product/20>

Storing recorded still pictures and motion pictures on your PC

Installing supplied software

The software compatible with your PC will be installed.

Preparations

- Check your PC's specifications and operating environment for each software.
- Before inserting the DVD (supplied), close all running applications.

1 Insert the DVD with the supplied software

- If the automatic playback screen is displayed, you can display the menu by selecting and executing [Launcher.exe].
- In Windows 8.1/Windows 8, you can display the menu by clicking a message that is displayed after inserting the DVD and then selecting and executing [Launcher.exe].
- You can also display the menu by double-clicking [SFMXXXX] in [Computer]. (The "XXXX" portion differs depending on the model.)

2 Click [Applications]

3 Click [Recommended Installation]

- Continue the installation procedure following the instructions displayed on the screen.

- If you are using a Mac, you can manually install SILKYPIX.

- ① Insert the DVD with the supplied software
- ② Double-click the application folder on the DVD
- ③ Double-click the folder that automatically appears
- ④ Double-click the icon in the folder



Not available in the following case:

- PHOTOfunSTUDIO / LoiLoScope are not compatible with Mac.

Storing recorded still pictures and motion pictures on your PC

Copying still pictures and motion pictures

Preparations

- Install “PHOTOfunSTUDIO” on your computer before starting the copying procedure. (→283)
- Turn on the camera and computer.

1 Connect camera to computer

- Check the plug direction and insert it straight in. (If the cable is inserted in the wrong direction, the plug could become deformed and cause faulty operation) Also, do not insert into the wrong socket. Doing so may cause damage to this unit.
- Do not use any other USB connection cables except the supplied one or a genuine Panasonic USB connection cable (DMW-USBC1: optional). Using cables other than the above may cause a malfunction.

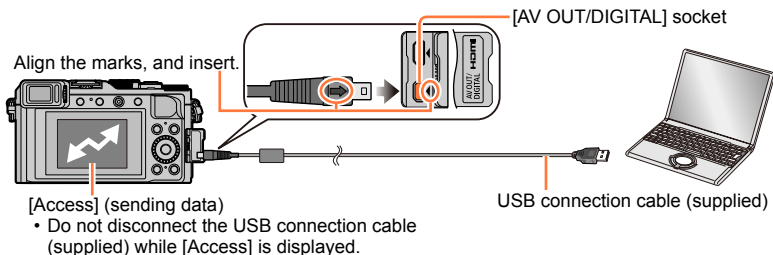

2 Use ▲ ▼ to select [PC] and press [MENU/SET]

- Setting the [USB Mode] to [PC] removes the need to make the setting each time the camera is connected to the computer.

3 Use “PHOTOfunSTUDIO” to copy pictures to your computer

- For details on how to use “PHOTOfunSTUDIO”, see the “PHOTOfunSTUDIO” manual (PDF).

- Do not delete or move copied files and folders using Windows Explorer or other browsers. Otherwise, you will not be able to play back or edit the files using “PHOTOfunSTUDIO”.

■ For PTP mode

The camera can be connected to your computer even if [USB Mode] (→47) is set to [PictBridge(PTP)].

- Only picture output can be performed.
- If you cannot connect to your PC in PTP mode, set [USB Mode] to [PC] and reconnect.
- It may not be possible to import if there are 1,000 or more pictures on the card.
- Motion pictures or RAW pictures cannot be read.

Storing recorded still pictures and motion pictures on your PC

Copying to your computer without using “PHOTOfunSTUDIO”

You can save pictures to use on your computer by dragging and dropping folders and files into separate folders on your computer.

- The card of this unit contains the following files (folder structure).

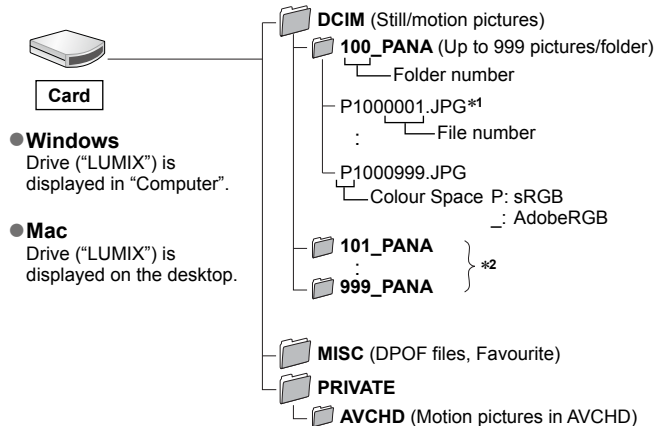

*1 .JPG: Still pictures

.RW2: Still pictures recorded in RAW file

.MP4: [MP4] Motion Pictures

*2 New folders are created in the following cases:

- When there is a picture with file number 999 inside the folder.
- When using cards already containing the same folder number (for example, pictures taken with other cameras, etc.).
- When recording after performing [No.Reset]. (→50)

- Turn off the camera before inserting or removing memory cards.
- Use a sufficiently charged battery or an AC adaptor (optional) and DC coupler (optional). When the battery starts to run out during communications, a warning beep sounds. Cancel communication via your computer immediately.
- For more details, consult your computer operating manual.

Storing recorded still pictures and motion pictures in the recorder

Follow the correct method for your device.

Copying by inserting the card into the recorder

You can copy pictures using Panasonic equipment (such as Blu-ray disc recorders) with support for each file format.

- See the instruction manual for the recorder for details for copying and playing back.

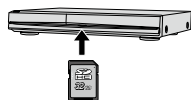

Dubbing playback pictures via AV cables (optional)

You can transfer or copy the pictures played back on this unit to a recorder, disc, video tapes, or other media using the standard picture quality. This method is useful as it allows dubbing to be performed even with devices that are not compatible with high definition images. Audio will be monaural.

1 Connect camera to recorder

- Check the plug direction and insert it straight in. (If the cable is inserted in the wrong direction, the plug could become deformed and cause faulty operation) Also, do not insert into the wrong socket. Doing so may cause damage to this unit.

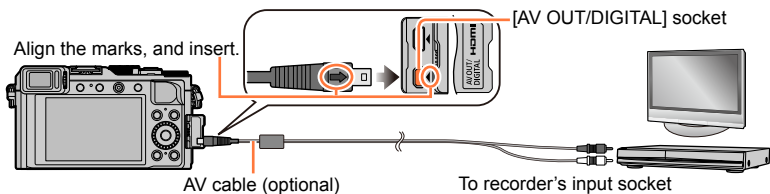

2 Start recording on recorder

3 Start playback on camera

- To stop recording (dubbing), stop the recording on your recorder first before stopping the playback on the camera.

- Always use a genuine Panasonic AV cable (DMW-AVC1: optional).
- When using a TV with a 4:3 aspect ratio, always change the camera's [TV Aspect] setting (→47) to [4:3] before dubbing. Motion pictures copied in the [16:9] setting will appear vertically stretched when viewed on a 4:3 TV screen.
- For details on dubbing and playback methods, refer to your recorder's operating instructions.

Printing

You can connect directly to a PictBridge-compatible printer for printing.

- Some printers can print directly from the camera's memory card.
For details, see the manual for your printer.

Preparations

- Adjust the print quality or other settings on your printer, as needed.
- Turn on the camera and printer.

1 Connect camera to printer

- Check the plug direction and insert it straight in. (If the cable is inserted in the wrong direction, the plug could become deformed and cause faulty operation) Also, do not insert into the wrong socket. Doing so may cause damage to this unit.
- Do not use any other USB connection cables except the supplied one or a genuine Panasonic USB connection cable (DMW-USBC1: optional). Using cables other than the above may cause a malfunction.

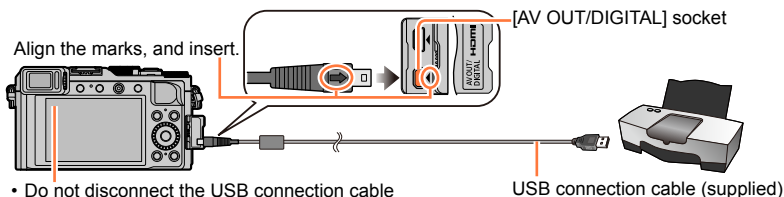

- Do not disconnect the USB connection cable (supplied) when the cable disconnection icon [⊗] is displayed (may not be displayed with some printers).

2 Use ▲ ▼ to select [PictBridge(PTP)] and press [MENU/SET]

3 Use ◀ ▶ to select a picture and press [MENU/SET]

4 Use ▲ to select [Print start] and press [MENU/SET]
(Print settings (→290))

■ To cancel print

Press [MENU/SET].

Printing multiple pictures

Multiple pictures are printed at one time.

1 Press **▲** to select [Multi Print] in step 3 (→287)

2 Use **▲ ▼** to select the item and press [MENU/SET]

- **[Multi Select]:**
 - ① Scroll between pictures with **▲ ▼ ◀ ▶**, select pictures to print with the [MENU/SET]. (Press [MENU/SET] again to release selection.)
 - ② Use **◀** to select [OK], and press [MENU/SET].
- **[Select All]:** Print all pictures.
- **[Print Set (DPOF)]:** Print pictures selected in [Print Set]. (→220)
- **[Favorite]:** Print pictures selected as [Favorite]. (→219)

3 Use **▲** to select [Print start] and press [MENU/SET]

(Print settings (→290))

- Select [Yes] if print confirmation screen is displayed.

- The group pictures are displayed one by one instead of all pictures at the same time.
- Turn off the camera before inserting or removing memory cards.
- Disconnect USB connection cable (supplied) after printing.
- Use a sufficiently charged battery or an AC adaptor (optional) and DC coupler (optional). When the battery starts to run out during connection, a warning beep sounds. Cancel printing and disconnect USB connection cable.
- An orange "●" displayed during printing indicates an error message.
- Print may be divided into several pictures if printing a large amount of pictures.
(Remaining sheets display may differ from the number of pictures set for printing.)

Not available in the following cases:

- Motion pictures cannot be printed.
- Still pictures recorded in a RAW file cannot be printed. (The still pictures recorded in JPEG file format at the same time as the RAW file can be printed.)

Printing with date and text

Time and date can be set to be printed on the picture when taking the picture by activating the [Text Stamp] function in the [Playback] menu. (→212)

■ Printing date without [Text Stamp]

Printing in store:

Only recording date can be printed. Request date printing in store.

- Making [Print Set] (→220) settings on the camera in advance allows settings for numbers of copies and date printing to be designated before giving the card to the store.
- When printing still pictures of 16:9 Aspect Ratio, check in advance that the store can accept this size.

Using computer:

Print settings for recording date and text information can be made using "PHOTOfunSTUDIO" software on the supplied DVD.

Using printer:

Recording date can be printed by setting [Print Set] on the camera, or by setting [Print with Date] (→290) to [ON] when connecting to a printer compatible with date printing.

Making print settings on the camera

Setting options include the number of printed pictures and their size. Make settings before selecting [Print start].

1 Use ▲▼ to select the item and press [MENU/SET]

Item	Settings
[Print with Date]	[ON] / [OFF]
[Num.of prints]	Set number of pictures (up to 999 pictures)
[Paper Size]	When [🖨️] is selected, the printer settings take priority.
[Page Layout]	[🖨️] (printer takes priority) / [🖨️] (1 picture, no border) / [🖨️] (1 picture, with border) / [🖨️] (2 pictures) / [🖨️] (4 pictures)

2 Use ▲▼ to select the setting and press [MENU/SET]

- When setting [Print with Date] to [ON], check the date printing settings on the printer (printer settings may be prioritised).
- To print a picture on which text or a date has been stamped, set [Print with Date] to [OFF]. (The still picture is printed with the date superimposed on it.)
- Items may not be displayed if incompatible with printer.
- To arrange [🖨️] "2 pictures" or [🖨️] "4 pictures" in the same still picture, set the number of prints for the still picture to 2 or 4.
- To print to paper sizes/layouts not supported by this camera, set to [🖨️] and make settings on the printer. (Consult your printer's operating manual.)
- Even with completed [Print Set] settings, dates may not be printed, depending on the shop or printer used.

Optional accessories

External Flash (optional)

When you use the flashes (optional: DMW-FL220, DMW-FL360L, or DMW-FL580L), a wider effective flash range is provided than with the flash (supplied).

Preparation

Set the camera [ON/OFF] switch to [OFF].

Removing the hot shoe cover

The hot shoe cover is already attached to the hot shoe at the time of purchase.

Remove the hot shoe cover by pulling it in the direction indicated by arrow ② while pressing it in the direction indicated by arrow ①

- Be sure to attach the hot shoe cover when the hot shoe is not in use.
- Keep the hot shoe cover safely after removing it so that you do not lose it.

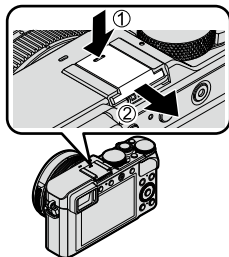

■ Using the flash (DMW-FL360L: optional)

- ① Attach the external flash to the hot shoe and then turn on the camera and the external flash
- ② Set the menu

MENU → **[Rec]** → **[Flash]**

- ③ Press **▲▼** to select [Flash Mode] and press **[MENU/SET]**
- ④ Press **▲▼** to select the item and press **[MENU/SET]**
 - While the external flash is connected, the following icons are displayed.
 - ⚡: External flash Forced ON
 - ⚡⊙: External flash Red-Eye Removal Forced ON*
 - ⚡S: External flash Slow Sync.
 - ⚡⊙S: External flash Red-Eye Removal Slow Sync.*
 - ⚡⊖: External flash Forced OFF
 - Signal-flashing with wireless flashes is also disabled.

* When the flash mode is set to [AUTO] or [MANUAL] on the external flash, you cannot select the item.

When using other commercially available external flashes that don't offer direct communication with the camera (DMC-LX100)

- It is necessary to set the exposure on the external flash when it is used. When you use an external flash in Auto Mode, use an external flash that allows you to set the aperture value and ISO Sensitivity to match the same settings on the camera.
 - Set the camera to [Aperture-Priority] Mode or [Manual Exposure] Mode and then set the same aperture value and ISO Sensitivity on the external flash. (The proper exposure cannot be achieved because the aperture value changes in [Shutter-Priority] Mode. The light of the external flash cannot be properly adjusted since the aperture value cannot be fixed in [Program AE] Mode.)
- You can set the aperture value, shutter speed and ISO Sensitivity on the camera even when the external flash is attached.
 - Some commercially available external flashes have synchro terminals with high-voltage or reversed polarity. If such flashes are used, they could cause a malfunction or hinder normal operation of the camera.
 - If you use commercially available external flashes (with communication functions) other than the ones compatible with this unit, they may not operate normally or they may be damaged. Do not use them.
 - Even if the external flash is turned off, the camera may enter the external flash mode when the external flash is attached. When you are not using the external flash, detach it.
 - When the external flash is attached, the camera will become unstable, and therefore we recommend using a tripod to take pictures.
 - Detach the external flash when you carry the camera.
 - Be sure to hold both the camera and the external flash when it is attached to the camera. If you hold only the external flash, it could become detached from the camera.
 - If the White Balance is set to [☀] when the external flash is used, perform fine adjustment of the White Balance if the recording results are not satisfactory. (→105)
 - If you take pictures close to the subject while taking wide-angle pictures, the light of the flash is obstructed by the lens and the bottom of the screen may be dark.
 - Refer to (→184) about the settings for the wireless flash.
 - Refer to the operating instructions of the external flash for further details.

Using the AC adaptor (optional) and DC coupler (optional) instead of the battery

By using the AC adaptor (optional) and DC coupler (optional), you can record and play back without worrying about the remaining battery charge.

The optional DC coupler can only be used with the designated Panasonic AC adaptor.

- Always use a genuine Panasonic AC adaptor (optional).
- Also read the AC adaptor and DC coupler operating instructions.

List of monitor/viewfinder displays

- The following images are examples of when the display screen is set to [MONITOR] (monitor style) in the monitor.

In recording

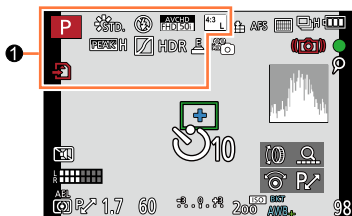

1	
	Recording Mode (→59)
	Motion picture recording mode (→58)
	Motion picture recording mode when [4K PHOTO] is set to [ON] (→195)
	Custom Set (→60)
	Panorama picture recording mode (→150)
	[Photo Style] (→100)
	Flash Mode (→180, 291)
	Flash (→182, 184)
	[Rec Format]/[Rec Quality] (→187)
	Aspect Ratio/[Picture Size] (→108)
	Card (displayed only during recording) (→25)
	Panorama Direction (→150)
EXPS	Types of picture effects (Filter) (→89)
	Picture effect (Filter) adjustment display (→91)

XXmXXs	Elapsed recording time* (→190)
	Simultaneous recording indicator (→198)
	Automatic switching between viewfinder and monitor (→54)
	[Peaking] (→130)
	[Highlight Shadow] (→102)
HDR	[HDR] (→112)
	[Multi Exp.] (→159)
	Electronic shutter (→140)

* [m] and [s] indicate "minute" and "second".

List of monitor/viewfinder displays

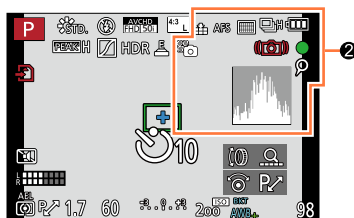

②

	RAW [Quality] (→109)
	Focus Mode (→114)
	AF Mode (→115)
	[Face Recog.] (→162)
	AF Lock (→133)
	Burst (→142)
	[Auto Bracket] (→145)
	[Aspect Bracket] (→147)
	Self-timer (→148)
	Panorama Direction (→150)
	Remaining battery (→21)
	Picture Mode (Still picture priorities) (→198)
	Macro recording (→126)
	Stabiliser (→168)
	Jitter alert (→168)

	Recording state (Flashes red./ Focus (Lights green.) (→56)
	Focus (Under low illumination) (→56)
	Wi-Fi connection status
	[4K PHOTO] marker (→196)
	[Time Lapse Shot] (→153)
	[Stop Motion Animation] (→156)
	Histogram (→64)

List of monitor/viewfinder displays

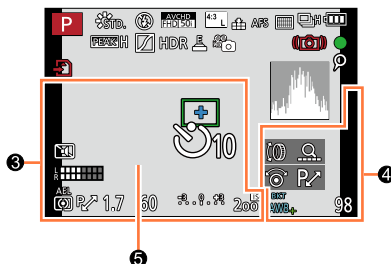

③

Destination settings / Travel elapsed days*2
(→42)

Name*2 (→165)

Age in years/months*2 (→165)

Current date/time*2

World time*2: ✈️ (→41)

	AF area (→56, 121)
+	Spot metering target (→139)
	Self-timer*3 (→148)
	[Silent Mode] (→161)
	[Mic Level Disp.] (→200)
AEL	AE Lock (→133)
	[Metering Mode] (→139)
P/	Programme Shift (→81)
1.7	Aperture value (→56)
60	Shutter speed (→56)
-3 . 0 . +3	Exposure compensation value (→135)
	Manual Exposure Assist (→87)
200 ^{ISO}	ISO Sensitivity (→136)

④

	[Dial Guide] (→18)
BKT AWB	White Balance Bracket (→106) White Balance Fine Adjustment (→105)
	White Balance (→103)
98	Number of recordable pictures*4 (→27)
R8m30s	Available recording time*1*4 (→27)

⑤

Exposure meter (→81)

Zoom (→170, 174)

*1 [m] and [s] indicate "minute" and "second".

*2 This is displayed for about 5 seconds when the camera is turned on, after setting the clock and after switching from Playback Mode to Recording Mode.

*3 This is displayed during countdown.

*4 It is possible to switch the display between the number of recordable pictures and available recording time with the [Remaining Disp.] setting in the [Custom] menu.

List of monitor/viewfinder displays

■ On-monitor recording information

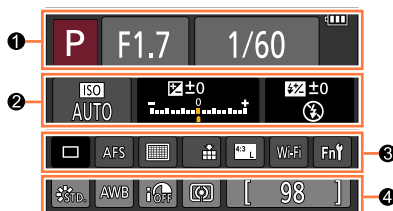

1		Recording Mode (→59)
		Programme Shift (→81)
		Motion picture recording mode (→58)
		Motion picture recording mode when [4K PHOTO] is set to [ON] (→195)
		Custom Set (→60)
		Panorama picture recording mode (→150)
	F1.7	Aperture value (→56)
	1/60	Shutter speed (→56)
	TIME	T (time) recording (→87)
		Remaining battery (→21)
		Card (displayed only during motion picture recording) (→25)

2		ISO Sensitivity (→136)
		Exposure compensation value (→135)
		Manual Exposure Assist (→87)
		Flash Mode (→180, 291)
		Flash (→182, 184)

3		Single (→141)
		Burst (→142)
		[Auto Bracket] (→145)
		[Aspect Bracket] (→147)
		Self-timer (→148)
		Panorama Direction (→150)
	AFS AFF AFC MF	Focus Mode (→114)
		AF Mode (→115)
		[Quality] (→109)
		[Rec Format]/[Rec Quality] (→187)
		Aspect Ratio/[Picture Size] (→108)
	Wi-Fi	Wi-Fi (→225)
	Fn	Function button setting (→37)

4		[Photo Style] (→100)
		White Balance (→103)
		[i.Dynamic] (→111)
		[Metering Mode] (→139)
	98	Number of recordable pictures (→27)
	R8m30s	Available recording time* (→27)

* [m] and [s] indicate "minute" and "second".

In playback

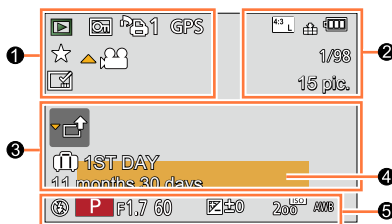

1		Playback Mode (→206)
		Protected picture (→221)
		Number of prints (→220)
	GPS	With location information (→207)
		Favourites (→219)
		Cable disconnect prohibit icon (→287)
		Motion picture playback (→70)
		Panorama picture playback (→152)
		Continuous playback of burst picture group (→201)
		Continuous playback of Time Lapse Shot picture group (→201)
		Continuous playback of stop motion animation group (→201)
		Text stamped display (→212)
	XXmXXs	Elapsed playback time *1 (→70)

2		Aspect Ratio/[Picture Size] (→108)
		[Rec Format]/[Rec Quality] (→187)
		[Quality] (→109)
		Remaining battery (→21)
	1/98	Picture number/Total pictures
	15 pic.	Number of pictures in burst
	XXmXXs	Motion picture recording time *1 (→70)

3		Acquiring information icon (→302)
		Travel elapsed days (→42)
		Upload (Wi-Fi) icon (→254)
		Submenu icon (→202, 254)
		[Silent Mode] (→161)
	11 months 30 days	Age in years/months (→165)
4		Name *2 (→164, 165)
		Location *2 (→42)
		Title *2 (→211)
5		Recording information *3

*1 [m] and [s] indicate "minute" and "second".

*2 The displaying is performed in the following priority order: title, travel destination, name (babies and pets), and name ([Face Rec.]).

*3 This is not displayed for motion pictures recorded in [AVCHD].

List of monitor/viewfinder displays

■ Detailed information display

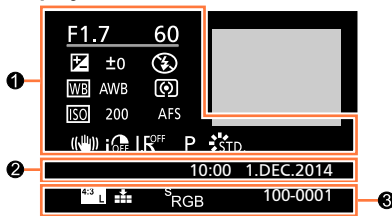

①

Recording information

	[i.Dynamic]* ¹ (→111)
	[HDR]* ² (→112)
	[i.Resolution] (→111)
	4K motion picture recorded by setting [4K PHOTO] to [ON] or a still picture captured from that 4K motion picture (→195)

②

Recording date/time

World time (→41)

③

	Aspect Ratio/[Picture Size] (→108)
	[Quality] (→109)
	[Rec Format]/[Rec Quality] (→187)
	[Color Space]* ² (→113)
100-0001	Folder/File number* ¹ (→285)

■ Histogram display

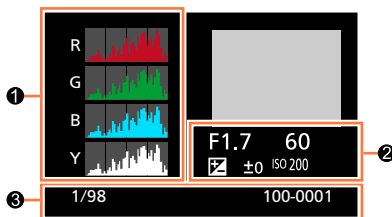

①

Histogram (→64)

②

Recording information*¹

③

1/98	Picture number/Total pictures
100-0001	Folder/File number* ¹ (→285)

*¹ This is not displayed for motion pictures recorded in [AVCHD].*² This is not displayed for motion pictures.

Message displays

The following explains the meaning of major messages displayed on the monitor or viewfinder, and how to respond to them.

■ Memory cards

[Memory Card Error] [Format this card?]

- The card format cannot be used with this camera.
→ Save needed data on a computer or other device, and then use [Format] on the camera. (→26)

[Insert SD card again] [Try another card]

- Access to card has failed.
→ Insert card again.
- Try with a different card.

[Read Error] / [Write Error] [Please check the card]

- Data read has failed.
→ Check whether card has been inserted correctly (→24)
- Data write has failed.
→ Turn off the camera and remove the card. Reinsert the card and turn the camera on again.
- Card may possibly be damaged.
→ Try with a different card.

[Motion recording was cancelled due to the limitation of the writing speed of the card]

- The speed class of a required card varies depending on [Rec Format] and [Rec Quality] of a motion picture. Be sure to use a card of the recommended speed class. For details, refer to "About the motion picture recording and speed class" (→25).
→ If recording stops even when using a card of the recommended speed class (→25), the data writing speed has dropped. If this happens, we recommend backing up the data on the memory card and formatting it (→26).

[Memory Card Error] [This memory card cannot be used]

- Not compatible with the camera. Use a compatible card.

[Cannot record due to incompatible format(NTSC/PAL) data on this card.]

- Format the card after saving necessary data on a PC etc. (→26)
→ Insert a different card.

■ Battery

[This battery cannot be used]

- Use a genuine Panasonic battery.
- Battery cannot be recognised as terminal is dirty.
 - Wipe any dirt away from the battery terminal.

■ Wi-Fi function

[Failed to connect wireless access point] / [Connection failed] / [No destination found]

- Check following regarding the wireless access point.
 - The wireless access point information set on this unit is wrong. Check the authentication type, encryption type, and encryption key. (→266)
 - Power of the wireless access point is not turned on.
 - Setting of the wireless access point is not supported by this unit.
- Check the network setting of the destination.
- Radio waves from other devices may block the connection to a wireless access point.
 - Check other devices that are connected to the wireless access point and devices that use the 2.4 GHz band.

[No picture to send]

- This is displayed when there is no image to transmit due to the restriction of the destination. Check the file type of the image to transmit. (→239, 243, 244, 247, 251, 255)

[Connection failed. Please retry in a few minutes.] / [Network disconnected. Transfer stopped.]

- Radio waves from the wireless access point are getting weak.
 - Perform the connection closer to the wireless access point.
- There is no reply from the server or it has exceeded the communication processing time.
 - Try again after a while.
- Depending on the wireless access point, connection may be automatically disconnected after specific time has passed.
 - Reconnect the connection again.

[Upload to the Cloud Folder is available after Cloud Sync settings have been set up on downloadable devices such as PCs or smartphones.]

- Devices that download images from a cloud folder are not registered.
- Perform Cloud Sync setting. Configure the settings on a PC with "PHOTOfunSTUDIO" or on a smartphone with "Image App". For details on [Cloud Sync. Service], refer to (→255).

[Connection failed]

- Check following regarding the smartphones you intend to connect.
 - The smartphone does not operate.
 - Change the access point to connect to in the smartphone Wi-Fi settings to this camera.
 - There is no free storage space on the smartphone.

[Login failed. Please check Login ID and Password.]

- Login ID or password for the “LUMIX CLUB” is not correct. Please enter it again. If you have forgotten the login ID or the password, there is information in the login screen of the “LUMIX CLUB” website.

[Some files cannot be sent because of destination limit] /**[Transfer completed. Some files are left because of destination limit.]**

- Check the file format of the image to send.
- Sending motion pictures may fail if the file size is too large. Split the motion picture using [Video Divide]. (→214)

[Unavailable. Please set Login settings on LUMIX CLUB web site.]

- Login to the “LUMIX CLUB” from your smartphone or PC, and set the login details of the destination WEB service.

[Both picture and video sharing service cannot be selected together]

- WEB services designed only for pictures, and WEB services designed only for motion pictures cannot be selected at the same time. Deselect one of the services.

[Cannot get IP address. Please set wireless AP's IP address setting to DHCP.]

- Turn on DHCP settings of the IP address of the connected wireless access points.

[Cannot connect to server]

- If a message is displaying asking to update the root certificate, agree to update the root certificate.

■ Others

[Some pictures cannot be deleted] [This picture cannot be deleted]

- Non-DCF pictures (→67) cannot be deleted.
→ Save needed data on a computer or other device, and then use [Format] on the camera. (→26)

[Cannot be set on this picture]

- [Print Set], [Title Edit], [Text Stamp], and other functions cannot be used for pictures that are not compliant with the DCF standard (→67).

[Please turn camera off and then on again] [System Error]

- The lens is not working correctly.
→ Turn the camera on again. (Consult the dealer or your nearest Service Centre if display still remains.)



[A folder cannot be created]

- Folder numbers in use have reached 999.
→ Save needed data on a computer or other device, and then use [Format] on the camera (→26).
Folder number is reset to 100 when performing [No.Reset] (→50).

[Picture is displayed for 16:9 TV] [Picture is displayed for 4:3 TV]

- AV cable (optional) is connected to camera.
→ To remove message immediately → Press [MENU/SET].
→ To change aspect ratio → Change [TV Aspect] (→47).
- USB connection cable (supplied) is only connected to camera.
→ Message disappears when cable is also connected to another device.

[Editing operation cannot proceed as information processing is ongoing.]

- If you display the playback screen when the camera contains many picture files, the acquiring information icon [] or [] may be displayed for a long time. While either one of these icons is displayed, some of the [Playback] menus cannot be used.
→ When the camera is turned off while information is being acquired, only the pictures whose information has been acquired up to that time are saved as a group. When the camera is turned on again, the camera once again begins acquiring information of the remaining pictures in the group.

Menu list

[Rec]

You can perform settings such as picture size and flash (supplied/optional).

- The [Photo Style], [AFS/AFF/AFC], [Metering Mode], [Highlight Shadow], [i.Dynamic], [i.Resolution], [i.Zoom], and [Digital Zoom] menu items are common for both [Rec] and [Motion Picture] menus. If a setting in one menu is changed, the setting with the same name in other menu will also be changed automatically.

[Photo Style]	You can select the effects according to the concept of the picture that you want to create. Adjusts the colours of effects and picture quality.	→100
[Picture Size]	Set the number of pixels.	→108
[Quality]	Set the compression rate used for storing pictures.	→109
[AFS/AFF/AFC]	Select how the focus is adjusted.	→114
[Metering Mode]	Type of optical measurement to measure brightness can be changed.	→139
[Burst Rate]	Sets the burst speed to be used for burst recording.	→142
[Auto Bracket]	Sets the Single/Burst setting, compensation range, and recording sequence of Auto Bracket.	→146
[Self Timer]	Sets the time before recording starts when you take a picture using the self-timer.	→148
[Highlight Shadow]	You can adjust the highlights and shadows in a picture while confirming the brightness of these areas on the screen.	→102
[i.Dynamic]	Correcting contrast and exposure.	→111
[i.Resolution]	Records still pictures with sharper outlines and the impression of high-resolution.	→111
[Simultaneous record w/o filter]	Sets whether to record pictures with Filter and those without Filter at the same time.	→91
[iHandheld Night Shot]	Combines nightscape pictures recorded using high-speed burst recording into a single picture.	→78
[iHDR]	When there is, for example, strong contrast between the background and the subject, [iHDR] records multiple still pictures with differing exposures and combines them to create a single still picture rich in gradation.	→79
[HDR]	The camera can combine 3 still pictures taken with different exposures into a single properly exposed picture with rich gradation.	→112
[Multi Exp.]	You can create an effect similar to the operation of up to four times of exposure on a single picture.	→159

Menu list

[Time Lapse Shot]	You can preset the recording start time, recording interval, and the number of pictures to be taken when automatically recording time lapse motion pictures of subjects such as animals and plants.	→153
[Stop Motion Animation]	You can stitch still pictures to create stop motion animation.	→156
[Panorama Direction]	You can set the recording direction to be used for recording panorama pictures.	→150
[Shutter Type]	You can take pictures using two types of shutter modes: the mechanical shutter and electronic shutter.	→140
[Flash]	Performs flash settings in accordance with the recording conditions.	→180
[Red-Eye Removal]	Automatically detects red-eye and corrects still picture data when recording with flash.	→180
[ISO Limit Set]	Sets the optimal ISO Sensitivity using the selected value as the upper limit of ISO Sensitivity when [Sensitivity] is set to [AUTO] or [ISO].	→137
[ISO Increments]	Changes the ISO Sensitivity settings every 1/3 EV or 1 EV steps.	→138
[Extended ISO]	You can extend the numeric values that can be set for ISO Sensitivity.	→138
[Long Shtr NR]	Eliminates the noise made when taking pictures at a slower shutter speed.	→113
[i.Zoom]	Allows increasing the zoom ratio while suppressing the deterioration of picture quality.	→172
[Digital Zoom]	Improves the telephoto effect of your pictures. Note that enlarging will decrease picture quality.	→173
[Color Space]	You can set the method for reproducing the colours to correctly display the recorded pictures on the screens of a PC or printer, etc.	→113
[Stabilizer]	Automatically detects jitter during recording and makes corrections.	→168
[Face Recog.]	Recognises a registered face and automatically adjusts the focus and exposure for this face with higher priority.	→162
[Profile Setup]	You can set a name or birthday of a baby or pet before taking a picture to record the name or age in months/years in the picture.	→165

[Motion Picture]

You can perform settings, such as recording format and quality, for recording motion pictures.

- The [Photo Style], [AFS/AFF/AFC], [Metering Mode], [Highlight Shadow], [i.Dynamic], [i.Resolution], [i.Zoom], and [Digital Zoom] menu items are common for both [Rec] and [Motion Picture] menus. If a setting in one menu is changed, the setting with the same name in other menu will also be changed automatically.

For details, refer to the corresponding item of the [Rec] menu.

[4K PHOTO]	You can set the motion picture mode used for creating a high-resolution still picture by capturing a single frame from a 4K motion picture.	→195
[Rec Format]	Sets the file format (AVCHD, MP4) of the motion picture to be recorded.	→187
[Rec Quality]	Sets the picture quality of the motion picture (size, frame rate, etc.) to be recorded.	→187
[Picture Mode]	Sets the recording method of still pictures to be taken while recording motion pictures.	→198
[Continuous AF]	Constantly adjusts the focus on a subject that is in focus.	→189
[Mic Level Disp.]	You can set whether or not to display the microphone level on the recording screen.	→200
[Mic Level Adj.]	You can adjust the audio input level in 4 steps.	→200
[Wind Cut]	If you hear wind noise during an audio recording, you can use [Wind Cut] to effectively reduce the wind noise.	→200

f_c [Custom]

You can set operations of this unit, such as the screen display method and functions of a button, according to your preferences. You can also register the changed settings.

[Utilize Custom Set feature]	Calls up the setting registered using [Cust.Set Mem.].	→60
[Cust.Set Mem.]	Registers the current camera settings as a custom setting.	→60
[Silent Mode]	Disabling the beeps and flash at the same time.	→161
[AF/AE Lock]	Performs the lock setting of the focus and/or exposure used for executing AF/AE lock.	→133
[AF/AE Lock Hold]	Sets the [AF/AE LOCK] button operation used for recording by fixing the focus and/or exposure.	→133
[Shutter AF]	Enables focus adjustment automatically when the shutter button is pressed halfway.	→124
[Half Press Release]	Enables shutter release when the shutter button is pressed halfway.	→124
[Quick AF]	Enables faster focusing when the shutter button is pressed.	→124
[Eye Sensor AF]	Automatically adjusts the focus when the eye sensor is activated.	→55
[Pinpoint AF Time]	Sets the time for displaying the enlarged screen if the shutter button is pressed halfway when Auto Focus mode is set to [+] .	→122
[Pinpoint AF Display]	Sets whether the assist screen is to be enlarged on a part of the screen or the entire screen when Auto Focus mode is set to [+] .	→122
[AF Assist Lamp]	Illuminates the AF Assist Lamp when the shutter button is pressed halfway when it is too dark to facilitate focusing.	→125
[Direct Focus Area]	Moves the AF area or MF assist using the cursor button while recording.	→123 →131
[Focus/Release Priority]	Disables recording when a subject is out of focus.	→125
[AF+MF]	Allows manual adjustment of the focus after AF is performed.	→125
[MF Assist]	Sets the display method for MF Assist (enlarged screen).	→131
[MF Assist Display]	Sets whether the Assist screen (enlarged screen) is to be enlarged on part of the screen or over the entire screen.	→132
[MF Guide]	Displays the MF guide used to check the direction of focus on the screen when the focus is manually adjusted.	→129

Menu list

[Peaking]	When you perform Manual Focus operation, this function automatically adds colour to the portions of the image that are in focus.	→130
[Histogram]	Sets whether to display the histogram.	→64
[Guide Line]	Sets the pattern of the guidelines to be displayed while recording.	→65
[Highlight]	Flashes the overexposed areas in black and white during [Auto Review] or playback.	→72
[Zebra Pattern]	Displays the area, where overexposure may occur, using a zebra pattern.	→166
[Monochrome Live View]	You can display the recording screen in black and white.	→167
[Constant Preview] (M Mode)	Allows the effects of the aperture value and shutter speed on the recording screen to be checked when [Manual Exposure] Mode is set.	→87
[Expo.Meter]	Sets whether to display the exposure meter.	→81
[Dial Guide]	Sets whether to display the operation guide.	→18
[LVF Disp.Style]	Sets the viewfinder display method.	→63
[Monitor Disp. Style]	Switching the monitor display method.	→62
[Monitor Info. Disp.]	Switches the recording information screen of the monitor.	→65
[Rec Area]	Switching the angle of view setting used for recording still pictures and motion pictures.	→192
[Remaining Disp.]	Switching the display between the number of recordable pictures that you can take and the available recording time.	→28
[Auto Review]	Set the time to display the pictures you have taken after taking still pictures.	→57
[Fn Button Set]	You can assign frequently-used functions to particular buttons.	→37
[Zoom lever]	Switches the zoom lever operation setting.	→175
[Control Ring]	You can assign frequently-used functions to control ring.	→40
[Zoom Resume]	Retaining the zoom position when the camera is turned off.	→175
[Q.MENU]	Switches the method for setting Quick Menu items.	→34
[iA Button Switch]	Changes the operation method of the [iA] button used for switching to [Intelligent Auto] Mode.	→75
[Video Button]	Enabling/disabling the motion picture button.	→192
[Eye Sensor]	Setting the sensitivity of the eye sensor or setting to switch the display between the viewfinder and monitor.	→55

[Setup]

You can perform settings for convenience of use such as the clock setting and changing of the beep sounds. You can also perform Wi-Fi function related settings.

[Clock Set]	Set time, date, and display format.	→29
[World Time]	Set the local time at travel destination.	→41
[Travel Date]	If you set your travel schedule and record pictures, the day of your trip on which the picture was taken will be recorded.	→42
[Wi-Fi]	Configure the settings required for the Wi-Fi function.	→272
[Beep]	Sets the beep sounds or shutter sounds.	→43
[Live View Mode]	Sets the display speed and picture quality of the screen (Live View screen) when recording pictures.	→43
[Monitor Display]/ [Viewfinder]	Adjust brightness and colour of the monitor or viewfinder.	→44
[Monitor Luminance]	You can adjust the brightness of the monitor depending on how bright it is around the camera.	→45
[Sleep Mode]	The camera automatically turns off if no operation is performed for a preset period of time.	→46
[USB Mode]	Select communication method for when connecting camera to a computer or printer with USB connection cable (supplied).	→47
[TV Connection]	Change the settings to be used when the camera is connected to a TV or other device.	→47
[Menu Resume]	Save the last operated menu position.	→49
[Menu Background]	Set the background colour for the menu screen.	→49
[Menu Information]	Explanations of the menu items and settings are displayed on the menu screen.	→49
[Language]	Set the language displayed on the screen.	→49
[Version Disp.]	Check the firmware version of the camera or supplied flash (when the flash is attached).	→50
[Self Timer Auto Off]	The self-timer is cancelled if the unit is turned off.	→50
[No.Reset]	Reset picture file numbers.	→50
[Reset]	Reset to the default settings.	→50
[Reset Wi-Fi Settings]	Return [Wi-Fi] settings to default settings.	→51
[Format]	Format (initialise) a memory card.	→26

▶ [Playback]

You can specify picture protection, resizing, print settings, and other settings for pictures you have taken.

[Slide Show]	Automatically play pictures in order.	→204
[Playback Mode]	You can narrow down the pictures to be displayed with set filters, such as categories or favourite pictures.	→206
[Location Logging]	You can write location information (longitude/latitude) sent from the smartphone to the pictures.	→207
[RAW Processing]	You can use the camera to develop still pictures that were recorded in RAW format. The created still pictures are saved in JPEG format.	→208
[Title Edit]	Allows characters (comments) to be entered on a recorded picture.	→211
[Text Stamp]	You can stamp the recording date and time, names, travel destination, travel dates, etc. on the recorded still pictures.	→212
[Video Divide]	A single motion picture can be split into 2 parts.	→214
[Time Lapse Video]	You can create a motion picture from the pictures in a group that was recorded using [Time Lapse Shot].	→215
[Stop Motion Video]	You can create a motion picture from the pictures in a group that was recorded using [Stop Motion Animation].	→215
[Resize]	Picture size can be reduced.	→216
[Cropping]	Enlarge your still pictures and crop unwanted areas.	→217
[Rotate]	Manually rotate pictures by 90°.	→218
[Rotate Disp.]	Automatically rotate portrait pictures.	→218
[Favorite]	Allows a label to be assigned to a picture with a mark to set it as your favourite picture.	→219
[Print Set]	Sets the pictures and the number of pictures to be printed.	→220
[Protect]	Set protection to prevent deletion of pictures by mistake.	→221
[Face Rec Edit]	Edit or delete the recognition information for pictures with mistaken Face Recognition.	→222
[Picture Sort]	You can set the display sequence used for playing back pictures on this unit.	→223
[Delete Confirmation]	You can set the Yes/No options that you want to select first on the confirmation screen when you delete a picture from either [Yes] or [No].	→223

Q&A Troubleshooting

① Try checking these items (→310 - 325) first.

If the problem persists,

- ② Performing [Reset] in the [Setup] menu may resolve the issue (→50). (Note that except for some items such as [Clock Set], all settings are returned to their values at the time of purchase.)
- ③ Also, see the Panasonic support site for the latest support information.
<http://panasonic.jp/support/global/cs/dsc/>
 (This site is available in English only.)

■ Battery, power

Camera does not work even if the camera is turned on.

- Battery is not inserted correctly (→24), or needs recharging.

Camera switches off as soon as the camera is turned on.

- Battery needs recharging.

This unit is turned off automatically.

- [Sleep Mode] is activated. (→46)
- If you connect to a TV compatible with VIERA Link (HDMI) with an HDMI micro cable and turn off the TV with the remote control for the TV, this unit also turns off.
 → If you are not using VIERA Link (HDMI), set [VIERA Link] to [OFF]. (→49)

The battery runs down quickly.

- The Wi-Fi connection has been on for a long time.
 → The battery is used up faster with a Wi-Fi connection. Turn off the camera as often as possible using [Sleep Mode] (→46) or other methods.

■ Recording

Cannot record pictures.

- Card is full.
→ Free space by deleting unwanted pictures (→73).
- When a large capacity card is used, you may not be able to take a picture for a while after you turn on the camera.
- Focus is not aligned.
→ When [Focus/Release Priority] is set to [FOCUS], the camera will not record until proper focusing is achieved. (→125)

Recorded pictures look white.

- Lens is dirty (fingerprints, etc.).
→ Turn the camera on to extract lens barrel, and clean lens surface with a soft, dry cloth.
- Lens is foggy (→12).

Recorded pictures are too bright/too dark.

- Adjust the exposure (→135).
- AE Lock (→133) is set inappropriately.

Zooming stops instantaneously.

- When using the Extra Optical Zoom, the zooming action will stop temporarily. This is not a malfunction.

Some pictures are taken when I press the shutter button just once.

- Camera is set to use [Auto Bracket], White Balance Bracket, [Aspect Bracket], or [Burst]. Self-Timer is set to [ON].
→ Clear the setting. (→106, 141)

Unable to perform bracket recording.

- The remaining memory space in the card is low.
→ Check the remaining memory space in the card.

Focus not aligned correctly.

- Subject outside of focus range. (→126)
- Caused by jitter or subject movement. (→168)
- [Focus/Release Priority] is set to [RELEASE]. (→125)
- [Shutter AF] is set to [OFF]. (→124)
- AF Lock (→133) is set inappropriately.

Recorded pictures are blurred. The stabiliser function ineffective.

- Shutter speed is slower in dark locations and the stabiliser function is less effective.
→ Hold camera firmly with both hands, keeping arms close to body.
- Use a tripod and the self-timer when using a slower shutter speed (→148).

Recorded pictures appear coarse, or there is interference.

- We recommend trying the following methods.
 - Lower [Sensitivity] (→136).
 - Take pictures in brighter locations.
 - Either adjust [Noise Reduction] of [Photo Style] to a higher setting or set each item other than [Noise Reduction] to a lower setting. (→101)
 - Set [Long Shtr NR] to [ON]. (→113)
 - Change the settings of [Picture Size] (→108) and [Quality] (→109).
- When Digital Zoom is used, the picture quality will become lower if you zoom in higher.

Striping or flicker may appear under lighting such as fluorescent lighting and LED lighting fixture. The subject appears distorted.

- This is characteristic of MOS sensors which serve as the camera's pickup sensors. This is not a malfunction. If the subject passes quickly in front of the lens, it will appear slightly distorted.
- If you are taking still pictures using [ESHTR], the striping may be reduced by setting a slower shutter speed. (→84)

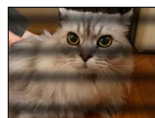
**Brightness or colouring of recorded picture different from real life.**

- When recording under fluorescent or LED lighting fixture etc., increasing the shutter speed may introduce slight changes to brightness and colour. These are a result of the characteristics of the light source and do not indicate a malfunction.
- When recording subjects in extremely bright locations or recording under fluorescent lighting, LED lighting fixture, mercury lamp, sodium lighting etc., the colours and screen brightness may change or horizontal striping may appear on the screen.

Reddish horizontal streaks appear on the screen during recording.

- This is characteristic of the MOS sensors, which serve as the camera's pickup sensors. The streaks appear when the subject has a bright part. Some unevenness may occur in the surrounding areas, but this is not a malfunction. It is recorded in motion pictures but is not recorded on still pictures.
- It is recommended that you take pictures while taking care not to expose the screen to sunlight or any other source of strong light.

Motion picture recording stops midway.

- The speed class of a required card varies depending on [Rec Format] and [Rec Quality] of a motion picture. Be sure to use a card of the recommended speed class. For details, refer to "About the motion picture recording and speed class" (→25).
- If recording stops even when using a card of the recommended speed class, the data writing speed has dropped. If this happens, we recommend backing up the data on the memory card and formatting it (→26).

The screen turns dark while recording motion pictures.

- While motion pictures are being recorded, the screen may turn dark as time passes in order to slow battery consumption. This condition, however, will not affect the recorded motion picture.

The screen turns momentarily black or noise is recorded.

- While motion pictures are being recorded, the screen may momentarily turn black or noise may be recorded due to static electricity or strong electromagnetic waves (radio transmitters, high-voltage lines, etc.) under some environmental conditions.

Sometimes focus adjustment with Auto Focus mode is difficult while recording 4K motion pictures.

- This may occur when taking a picture by reducing the Auto Focus speed in order to adjust the focus at high precision. This is not a malfunction.

Panorama picture recording stops before finishing.

- If the pan motion of the camera is too slow, the camera assumes that the operation has been aborted and stops recording.
- If the pan motion of the camera is too shaky when it is moved toward the recording direction, the camera stops recording.

The subject cannot be locked. (AF track fails)

- If the colour of the subject is similar to that of its background, AF Tracking may not function. Set the AF lock to the colours specific to the subject.

Low or inaudible operating sound.

- The speaker is blocked.
- [Silent Mode] is set to [ON] (→161).

■ Monitor/viewfinder

The monitor/viewfinder is turned off although the camera is turned on.

- When a hand or object is close to the eye sensor, the monitor display mode could be switched to viewfinder display mode without your knowledge. (→54)

Pictures do not show on the monitor.

- Viewfinder display mode is activated.
→ Press the [LVF] button to switch to the monitor display mode. (→54)
- Monitor is turned off.
→ Press the [DISP.] button to switch the display information. (→62)
- When you connect the camera to a TV using an HDMI micro cable, the picture is not displayed on a monitor/viewfinder in the following cases.
 - During playback

Brightness is unstable.

- Aperture value is set while shutter button is pressed halfway. (Does not affect recorded picture.)
This symptom may also occur when the brightness changes because the zoom is operated or the camera is moved. This is the automatic aperture operation of the camera and is not a malfunction.

The screen flickers indoors.

- The screen may flicker for a few seconds after turning on. This is an operation to correct flicker caused by lighting such as fluorescent lights, LED lights, etc. and is not a malfunction.

The screen is too bright/too dark.

- Check [Monitor Luminance] setting. (→45)
- Use [Monitor Display]/[Viewfinder] to adjust the brightness of the screen. (→44)

Black/blue/red/green dots or interference appears. Monitor looks distorted when touched.

- This is not a fault, and will not be recorded on the actual pictures.

Noise appears on the monitor/viewfinder.

- In dark places, noise may appear to maintain the brightness of the monitor/viewfinder.

Cannot switch between the monitor and viewfinder when pressing [LVF] button.

- When it is connected to a computer or printer, the camera can display pictures on the monitor only.

■ Flash

Unable to perform [Flash].

- Flash (supplied/optional) is not attached properly.
→ Properly attach a flash (supplied/optional) to the camera. (→176, 291)
- For details about flash settings, refer to (→176 - 186, 291).

No flash emitted.

The flash becomes unavailable in the following cases.

- When the picture effect (Filter) is set
- When camera is set to use [Auto Bracket], White Balance Bracket, or [Aspect Bracket]
- When using [Burst]
- During panorama picture recording
- When [HDR] is set to [ON]
- When the electronic shutter is used (→140)
→ Set [Shutter Type] to [AUTO] or [MSHTR].
- When [Silent Mode] is set to [ON] (→161)
→ Set [Silent Mode] to [OFF].

The flash fires twice.

- The flash (supplied) fires twice. (Except when [Firing Mode] of [Flash] is set to [MANUAL]) When red-eye reduction (→180) is set, the firing interval will be longer. Make sure that the subject does not move until the second firing is completed.

■ Playback

Pictures have been rotated.

- [Rotate Disp.] is activated. (→218)

Cannot view pictures. There are no recorded pictures.

- A card is not inserted in the camera.
- There is no picture on the card to play back.
- Has the file name of the picture been changed on a computer? If so, it cannot be played back on the camera.
- [Playback Mode] is set to other than [Normal Play].
→ Set [Playback Mode] to [Normal Play]. (→206)

Folder/file number displayed as [-]. Picture is black.

- Picture edited on computer or taken with different device.
- Battery removed immediately after picture taken, or picture taken with low battery.
→ Use [Format] to delete (→26).

Incorrect date displayed in Calendar Search.

- Picture edited on computer or taken with different device.
- [Clock Set] is incorrect (→29). (Incorrect date may be displayed in Calendar Search on pictures copied to a computer and then back to this unit, if computer and camera dates differ.)

White round spots like soap bubbles appear on the recorded picture.

- If you take a picture with the flash in a dark place or indoors, white round spots may appear on the picture caused by the flash reflecting particles of dust in the air. This is not a fault. A characteristic of this is that the number of round spots and their position differ in every picture.



[Thumbnail is displayed] is shown on the screen.

- The pictures may have been recorded on another device. If so, they may be displayed with poor picture quality.

Red areas in pictures appear blackened.

- When digital red-eye correction ([Red-Eye Correction], [Red-Eye Correction]) is operating, if a subject is recorded that has skin-coloured areas with red areas inside, the digital red-eye correction function may blacken the red areas.
→ We recommend setting the flash (supplied/optional) to [Flash On], or [Red-Eye Removal] to [OFF] before recording. (→180)

An unusual noise, such as a clicking or buzzing noise, is recorded on a motion picture. Audio is recorded at low volumes.

- When recording a motion picture in a quiet environment, noise due to the motion of the aperture and focusing mechanism may be recorded on the motion picture. Note that this is not a fault. You can set the focus operation during motion picture recording to [OFF] using [Continuous AF] (→189).
- Note that if you perform operations such as zoom, using buttons or dials, while recording a motion picture, operation noise may be recorded.
- If you block the microphone with your fingers while motion pictures are being recorded, the audio may be recorded at a low volume or may not be recorded at all. In this case, the camera may pick up the lens operating sounds more easily.

Operating sounds are recorded at the end of the motion picture recording.

- Since motion pictures are recorded until the motion picture button is pressed to stop recording, the operating sound level in the picture may be higher. To suppress this sound, we recommend trying the following method.
 - Divide the end part of a motion picture using [Video Divide] (→214) in the [Playback] menu. In some cases, motion pictures cannot be divided at a position close to the end part of the motion picture. To avoid this problem, continue recording for an extra 3 seconds.

Playback and operation sounds are too low.

- The speaker is blocked. (→15)

Motion pictures taken with this camera cannot be played in other cameras.

- Even if a device is compatible with AVCHD and MP4, the motion pictures that were recorded on this unit may have bad picture quality or sound quality upon playback, or may be unable to be played back. Also, the recording information may not be displayed correctly.

■ Wi-Fi function

It cannot connect to the wireless LAN. Radio waves get disconnected.

- Use within the communication range of the wireless LAN network.
- Connection types and security setting methods are different depending on the wireless access point.
 - Refer to the operating instructions of the wireless access point.
- When the radio waves are interrupted, the condition may improve by moving the location or changing the angle of the wireless access point.
- When this unit is placed on a metal table or shelf, the connection may not be established easily because the camera is affected by radio waves. Use the camera away from metal surfaces.
- It may not automatically connect when the network SSID of the wireless access point is set not to broadcast.
 - Set the network SSID of the wireless access point to broadcast.
- Is any device, such as microwave oven, cordless phone, etc., that uses 2.4 GHz frequency operated nearby?
 - Radio waves may get interrupted when used simultaneously. Use them sufficiently away from the device.
- Is the 5 GHz/2.4 GHz switchable wireless access point connected to other equipment using the 5 GHz band?
 - The use of a wireless access point that can use 5 GHz/2.4 GHz simultaneously is recommended. It cannot be used simultaneously with this camera if it is not compatible.
- When the battery indicator is flashing red, the connection with other equipment may not start or the connection may be disrupted. (A message such as [Communication error] is displayed.)
- Perform [Reset Wi-Fi Settings] in the [Setup] menu.

Wireless access point is not displayed. Or it cannot be connected.

- Check if the wireless access point to connect is in operating state.
- The camera may not display or connect to a wireless access point depending on the radio wave condition.
 - Perform the connection closer to the wireless access point.
 - Remove the obstacles between this unit and the wireless access point.
 - Change the direction of this unit.
- It may not display even if the radio waves exist depending on the setting of the wireless access point.
 - Check the settings of the wireless access point.
- The wireless access point may not be found depending on the radio wave condition.
 - Perform the [Manual Input]. (→266)
- Is the network SSID of the wireless access point set not to broadcast?
 - It may not be detected when it is set not to broadcast. Enter and set the network SSID. (→265)
- Connection methods differ depending on the wireless access point.
 - Refer to the operating instructions of the wireless access point.

It takes long time every time to connect to a smartphone.

- It may take longer time to connect depending on the Wi-Fi connection setting of the smartphone, but it is not a malfunction.

This unit is not displayed in the Wi-Fi setting screen of the smartphone.

→ Try switching the ON/OFF of the Wi-Fi function in the Wi-Fi settings of the smartphone.

I have forgotten the login ID or password for the “LUMIX CLUB”.

- Check the information in the login screen of “LUMIX CLUB”.
<http://lumixclub.panasonic.net/eng/c/>

I do not have a wireless access point at my home, but I would like to perform service user registration of the “LUMIX CLUB”.

- Service user registration for the “LUMIX CLUB” is not possible in the environment without a wireless access point.

The camera cannot be connected to Mac computer/Windows PC via Wi-Fi connection.

- Please confirm login name and password are correctly typed.
- When the system time of Mac computer or Windows PC connected to a camera differs severely from that of the camera, the camera cannot be connected to the computer or PC in some OSs. Please confirm clock set and world time of the camera matches with time, date and time zone in Windows PC or Mac computer. When both settings do not match severely, please match them.

I am having a problem connecting to my Windows 8 PC. The user name and password are not recognised.

- Depending on the OS version, on Windows 8, for example, there are two types of user account (local account/Microsoft account).
 - Be sure to set the local account and use the user name and password for the local account.

The Wi-Fi connection is not recognising my PC.

- By default, the Wi-Fi connection uses the default workgroup name of “WORKGROUP”. If the name of the workgroup has been changed, it will not be recognised.
 - Select [PC Connection] then [Change Workgroup Name] in the [Wi-Fi Setup] to change the workgroup name to match that of your PC. (→272)

Pictures cannot be transmitted to the computer.

- If a firewall is enabled by the OS or security software, this unit may be unable to connect to the computer.

Images cannot be transmitted to the WEB service.

- Confirm that the login information (login ID/user name/email address/password) is correct.
- WEB service server or the network may be busy.
 - Try again after a while.
 - Check the site of the WEB service you are sending the image to.

It takes time to transmit an image to the WEB service.

- Is the size of the image too large?
 - Transmit after dividing the motion picture with [Video Divide] (→214).
 - Reduce the image size at [Size] (→271), and then send.
- It may take longer time to transmit when distance to the wireless access point is far.
 - Transmit closer to the wireless access point.

The image that was supposed to have uploaded to the WEB service is not there.

- Upload may not complete when it is disconnected while transmitting the image.
- It may take some time after uploading the image to be reflected in the WEB service depending on the status of the server.
 - Wait for a while and try again.
- You can check the transmission status on the WEB service link settings by logging into “LUMIX CLUB”.

I would like to return the image in the WEB service to the camera.

- The images in the WEB Service cannot be saved (downloaded) to this unit. Do not delete the uploaded images, and make a backup of them.

I cannot display or delete the images uploaded to the WEB service by this unit.

- The images uploaded to the WEB service cannot be displayed or deleted by this unit.
 - Perform the task using a smartphone or a PC.

Your “LUMIX CLUB” login ID and password were deleted after sending the camera in to be repaired.

- The settings stored in the camera may be deleted depending on the type of repair.
 - Always make a copy of important settings.

Transmission of the image fails midway. There is an image that could not be transmitted.

- Image cannot be transmitted when the battery indicator is flashing red.
- Is the size of the image too large?
 - Divide the motion picture using [Video Divide] (→214).
 - Reduce the image size at [Size] (→271), and then send.
- File format of the picture that can be sent differs depending on the destination.
(→239, 243, 244, 247, 251, 255)
- Capacity or number of images in the WEB service is full.
 - Login to “LUMIX CLUB”, and check the status of the destination on the WEB service link settings.

I have forgotten the password for the Wi-Fi.

- Execute the [Reset Wi-Fi Settings] in the [Setup] menu. (→51)
However, the information you have set on the [Wi-Fi Setup] will be reset.

I cannot send images to an AV device.

- Sending may fail depending on the operational status of the AV device. Also, sending may take a while.

I cannot connect using the NFC function.

- The smartphone is not NFC compatible.
This function can be used with NFC compatible devices with Android (2.3.3 or above).
- Is the NFC function on the smartphone turned off?
- The [NFC Operation] on this unit is set to [OFF]. (→272)
- The camera has a hard time recognising some smartphone models. If it is not recognised, slowly shift the smartphone while it is beside the unit.
- If you hold the smartphone for too short a time, the camera may not be able to recognise the smartphone. Hold the smartphone for a while.

■ TV, computer, printer

No image appears on TV. Image blurred or not coloured.

- Not connected correctly (→276).
- The television has not been switched to auxiliary input.

The display on the TV and on the camera do not match.

- Aspect ratio may be incorrect or edges may be cut off with certain televisions.

Cannot play motion pictures on TV.

- Card is inserted into TV.
→ Connect with AV cable (optional) or HDMI micro cable and play on camera (→276).

Picture is not displayed on full TV screen.

- Check [TV Aspect] settings (→47).

No sound is output from the camera speaker.

- When the AV cable (optional) or HDMI micro cable is connected to the camera, no sound is output from the camera.

VIERA Link (HDMI) is not working.

- Is the HDMI micro cable connected correctly? (→276)
→ Check that the HDMI micro cable is fully inserted.
- Is the camera's [VIERA Link] setting set to [ON]? (→49)
→ The input setting may not be able to be changed automatically with certain television HDMI sockets. In this case, please change the input setting with your television's remote control (consult your television's operating instructions for details).
→ Check the VIERA Link (HDMI) settings on the device you are connecting to.
→ Turn the camera off and on again.
→ Turn the "VIERA Link control (HDMI device control)" setting on your television (VIERA) to off and then to on again. (Consult your VIERA's operating instructions for details.)

Cannot communicate with the computer.

- Not connected correctly (→284).
- Check whether computer has recognised camera.
→ Set [USB Mode] to [PC] (→47).
→ Turn the camera off and then on again.

Computer does not recognise card.

- Disconnect USB connection cable (supplied) and reconnect with card in place.
- If there are two or more USB terminal on a single PC, try connecting the USB connection cable to another USB terminal.

Computer does not recognise card. (When using an SDXC Memory Card)

- Check whether your computer is compatible with SDXC Memory Cards.
<http://panasonic.net/avc/sdcard/information/SDXC.html>
- A message prompting you to format the card may appear when you connect it. Do not format the card.
- If the [Access] indicator on the screen does not go off, turn the camera off before disconnecting the USB connection cable.

Cannot print when connecting to printer.

- Printer not compatible with PictBridge.
- Set [USB Mode] to [PictBridge(PTP)] (→47, 287).

The edges of pictures are cut off when printing.

- Release any trimming or edgeless printing settings on printer before printing. (Refer to the instruction manual for the printer.)
- The aspect ratio of pictures is different from that of paper used for printing.
→ If printing in shop, check if 16:9 sizes can be printed.

Cannot print panorama pictures properly.

- The aspect ratio of panorama pictures is different from that of regular still pictures, and some panorama pictures may not be printed correctly.
→ Use a printer with support for panorama pictures. (Refer to the instruction manual for the printer.)
→ We recommend adjusting the size of a picture in accordance with print paper using the "PHOTOfunSTUDIO" software on the DVD (supplied).

■ Others

Menu not displayed in desired language.

- Change [Language] setting (→49).

Camera rattles if shaken.

- This sound is made by the lens movement and is not a fault.

The lens makes a clicking noise.

- When the camera is turned on or off, the lens is moved, or an aperture operation is performed, such a noise may be heard. This is not a malfunction.
- When the brightness changes after a zooming operation or moving the camera, the lens may make a noise while adjusting the aperture. This is not a malfunction.

Red lamp illuminated when pressing shutter button halfway in dark locations.

- [AF Assist Lamp] is set to [ON] (→125).

AF Assist Lamp is not illuminated.

- [AF Assist Lamp] is set to [OFF] (→125).
- Not illuminated in bright locations.

Part of a picture flashes black and white.

- [Highlight] is set to [ON]. (→72)

Camera is hot.

- Camera may become a little warm during use, but this does not affect performance or quality.

Clock is incorrect.

- Camera has been left for a long period.
→ Reset the clock (→30).
- A long time was taken to set the clock (clock will be behind by the same lapse of time).

When using zoom, picture becomes slightly warped and the edges of the subject become coloured.

- Pictures may be slightly warped or coloured around the edges, depending on the zoom ratio, but this is not a fault.

File numbers are not recorded in sequence.

- File numbers are reset when new folders are created (→50).
- If you perform this operation after performing a specific operation, the picture may be saved in a folder with a different folder number than the previous folder number.

File numbers have jumped backwards.

- Battery was removed/inserted with the camera turned on. (Numbers may jump backwards if folder/file numbers are not correctly recorded.)

Usage cautions and notes

When in use

- Camera may become warm if used for long periods of time, but this is not a fault.
- **Keep this unit as far away as possible from electromagnetic equipment (such as microwave ovens, TVs, video games etc.).**
 - If you use this unit on top of or near a TV, the pictures and/or sound on this unit may be disrupted by electromagnetic wave radiation.
 - Do not use this unit near cell phones because doing so may result in noise adversely affecting the pictures and/or sound.
 - Recorded data may be damaged, or pictures may be distorted, by strong magnetic fields created by speakers or large motors.
 - Electromagnetic wave radiation may adversely affect this unit, disturbing the pictures and/or sound.
 - If this unit is adversely affected by electromagnetic equipment and stops functioning properly, turn this unit off and remove the battery or disconnect AC adaptor (optional). Then reinsert the battery or reconnect AC adaptor and turn this unit on.
- **Do not use this unit near radio transmitters or high-voltage lines.**
 - If you record near radio transmitters or high-voltage lines, the recorded pictures and/or sound may be adversely affected.
- Do not extend the supplied cord or cable.
- Do not allow camera to come into contact with pesticides or volatile substances (can cause surface damage or coating to peel).
- Do not keep objects that may be influenced magnetically close to the speaker.
 - Magnetised objects such as bank cards, commuter passes, watches, may be adversely affected by the magnetic influence of the speaker.
- Never leave the camera and the battery in a car or on a car hood in the summer. Doing so may cause leakage of the battery electrolyte, overheating, fire or a battery explosion due to the high temperature.

Caring for your camera

To clean your camera, remove the battery or the DC coupler (optional), or disconnect the power plug from the outlet, and wipe with a soft, dry cloth.

- Use a damp cloth to remove stubborn stains, before wiping with a dry cloth.
- Do not use benzine, thinners, alcohol, or kitchen detergent, as these may damage the outer casing and finish of the camera.
- If using a chemically-treated cloth, read the supplied instructions carefully.

When not using for a while

- Turn off the camera before removing battery and card (ensure that battery is removed to prevent damage through over-discharge).
- Do not leave in contact with rubber or plastic bags.
- Store together with a drying agent (silica gel) if leaving in drawer, etc. Store batteries in cool (15 °C to 25 °C (59 °F to 77 °F)) places with low humidity (40%RH to 60%RH) and no major temperature changes.
- Charge battery once per year and use completely before storing again.

Memory cards

- To prevent damage to cards and data
 - Avoid high temperatures, direct sunlight, electromagnetic waves, and static electricity.
 - Do not bend, drop, or expose to strong impacts.
 - Do not touch terminals on reverse of card or allow them to become dirty or wet.
- Recorded data may be damaged or lost if the camera breaks down due to inappropriate handling. Panasonic will not be liable for any damage caused due to loss of recorded data.
- When disposing of/transferring memory cards
 - If using the “format” or “delete” functions on your camera or computer, this only changes the file management information, and does not completely delete the data from within the memory card. When disposing of or transferring your memory cards, we recommend physically destroying them, or using commercially available computer data erasing software to completely delete the data from the card. Data within memory cards should be managed responsibly.

Monitor/viewfinder

- Do not press hard on the monitor. This may cause uneven display and damage the monitor.
- In cold climates or other situations when the camera becomes cold, the monitor or the viewfinder may appear slightly darker than normal immediately after the camera is turned on. Normal brightness will return once the internal components have warmed up.

The monitor and viewfinder are made with extremely high precision technology. However there may be some dark or bright spots (red, blue or green) on the screen. This is not a malfunction. The monitor and viewfinder screens are controlled with extremely high precision, but some pixels may be inactive. The spots will not be recorded on pictures on a card.

Battery

The battery is a rechargeable lithium ion battery.

This battery is easily affected by temperature and humidity, and is affected more when the temperature is high or low.

- The time required for charging varies depending on conditions of battery usage.
Charging takes longer at high or low temperatures and when the battery has not been used in some time.
- Battery will be warm during charging and for some time thereafter.
- Battery will run out if not used for long periods of time, even after being charged.
- Do not leave any metal items (such as clips) near the contact areas of the power plug. Otherwise, a fire and/or electric shocks may be caused by short-circuiting or the resulting heat generated.
- Frequently charging up battery is not recommended.
(Frequently charging battery reduces maximum usage time and can cause battery to expand.)
- If available battery power is significantly reduced, battery is reaching end of lifespan. Please purchase a new battery.
- When charging:
 - Wipe dirt from the battery terminal with a dry cloth.
 - Keep at least 1 m (3.3 feet) away from AM radio (may cause radio interference).
- Do not use a damaged or dented battery (especially connectors), e.g. by dropping (can cause faults).

Charger

- Depending on the environment while charging, the charging light may flicker due to static electricity or electromagnetic radiation, etc. This has no effect on charging.
- Keep at least 1 m (3.3 feet) away from AM radio (may cause radio interference).
- The charger may generate whirring sounds when it is being used. This is not a malfunction.
- After use, be sure to disconnect the power supply device from the electrical outlet. (A very small amount of current is consumed if it is left connected.)
- Keep the terminals of the charger and battery clean. When they get dirty, clean with a dry cloth.

Lens

- Images may appear slightly white if lens is dirty (fingerprints, etc.). Turn the camera on, hold the extracted lens barrel with your fingers, and gently wipe the lens surface with a soft, dry cloth.
- Do not leave the lens exposed to direct sunlight.

When using a tripod or unipod

- Do not apply excessive force or tighten screws when they are crooked. (This may damage the camera, screw hole, or label.)
- Ensure that the tripod is stable. (Refer to the tripod instructions.)
- You may not be able to remove the card or the battery when using a tripod or unipod.

Personal Information

To protect personal information, we recommend that you set a Wi-Fi password. (→273)
If names or birthdays are set in [Profile Setup] or in the [Face Recog.] function, keep in mind that the camera and recorded pictures will contain personal information.

● Disclaimer

- Data containing personal information can be altered or lost due to malfunction, static electricity, accidents, breakdowns, repairs, or other operations.
Panasonic will not be liable for any damage that occurs, direct or indirect, as a result of the alteration or loss of data containing personal information.

● When ordering repairs or transferring/disposing of the camera

- After you make a note of the personal information, perform [Reset Wi-Fi Settings]/ [Delete account] to delete data containing personal information such as wireless LAN connection settings that you registered or set in this unit. (→51, 262)
- To protect your personal information, please reset the settings. (→50)
- Remove the memory card from the camera.
- When ordering repairs, settings may be returned to the initial purchase state.
- If the above operations cannot be performed because of a camera malfunction, consult with the dealer or nearest Service Centre.

● When transferring or disposing of your memory card, see “When disposing of/ transferring memory cards” in the previous section. (→327)

● Uploading pictures to WEB services

- Pictures may contain personal information that can be used to identify the user, such as titles, recording dates and times, and location information. Before uploading the pictures to WEB services, check the pictures carefully for information that should not be disclosed.

Usage cautions and notes

- SDXC Logo is a trademark of SD-3C, LLC.
- HDMI, the HDMI Logo, and High-Definition Multimedia Interface are trademarks or registered trademarks of HDMI Licensing LLC in the United States and other countries.
- HDAVI Control™ is a trademark of Panasonic Corporation.
- “AVCHD”, “AVCHD Progressive” and the “AVCHD Progressive” logo are trademarks of Panasonic Corporation and Sony Corporation.
- Manufactured under license from Dolby Laboratories.
Dolby and the double-D symbol are trademarks of Dolby Laboratories.
- Adobe is a trademark or registered trademark of Adobe Systems Incorporated in the United States and/or other countries.
- Pentium is a trademark of Intel Corporation in the U.S. and/or other countries.
- Windows and Windows Vista are either registered trademarks or trademarks of Microsoft Corporation in the United States and/or other countries.
- iMovie, Mac and Mac OS are trademarks of Apple Inc., registered in the U.S. and other countries.
- iPad, iPhone, and iPod touch are trademarks of Apple Inc., registered in the U.S. and other countries.
- App Store is a service mark of Apple Inc.
- Android and Google Play are trademarks or registered trademarks of Google Inc.
- The Wi-Fi CERTIFIED™ Logo is a certification mark of Wi-Fi Alliance®.
- The Wi-Fi Protected Setup™ Identifier mark is a certification mark of Wi-Fi Alliance®.
- “Wi-Fi®” and “Wi-Fi Direct®” are registered trademarks of Wi-Fi Alliance®.
- “Wi-Fi Protected Setup™”, “WPA™” and “WPA2™” are trademarks of Wi-Fi Alliance®.
- DLNA, the DLNA Logo and DLNA CERTIFIED are trademarks, service marks, or certification marks of the Digital Living Network Alliance.
- QR Code is a registered trademark of DENSO WAVE INCORPORATED.
- This product uses “DynaFont” from DynaComware Corporation. DynaFont is a registered trademark of DynaComware Taiwan Inc.
- Other names, company names, and product names mentioned in these instructions are trademarks or registered trademarks of the companies concerned.



Usage cautions and notes

This product is licensed under the AVC patent portfolio license for the personal and non-commercial use of a consumer to (i) encode video in compliance with the AVC Standard ("AVC Video") and/or (ii) decode AVC Video that was encoded by a consumer engaged in a personal and non-commercial activity and/or was obtained from a video provider licensed to provide AVC Video. No license is granted or shall be implied for any other use. Additional information may be obtained from MPEG LA, LLC.
See <http://www.mpegla.com>.

This product incorporates the following software:

- (1) the software developed independently by or for Panasonic Corporation,
- (2) the software owned by third party and licenced to Panasonic Corporation, and/or
- (3) open source software

The software categorised as (3) is distributed in the hope that it will be useful, but WITHOUT ANY WARRANTY, without even the implied warranty of MERCHANTABILITY or FITNESS FOR A PARTICULAR PURPOSE.

Please refer to the detailed terms and conditions thereof displayed by selecting [MENU/SET] → [Setup] → [Version Disp.] → [Software info].

Disposal of Old Equipment and Batteries Only for European Union and countries with recycling systems



These symbols on the products, packaging, and/or accompanying documents mean that used electrical and electronic products and batteries must not be mixed with general household waste.

For proper treatment, recovery and recycling of old products and used batteries, please take them to applicable collection points in accordance with your national legislation.

By disposing of them correctly, you will help to save valuable resources and prevent any potential negative effects on human health and the environment.

For more information about collection and recycling, please contact your local municipality.

Penalties may be applicable for incorrect disposal of this waste, in accordance with national legislation.



Note for the battery symbol (bottom symbol):

This symbol might be used in combination with a chemical symbol. In this case it complies with the requirement set by the Directive for the chemical involved.