

Panasonic[®]

TX-65EZ1002B TX-77EZ1002B

TX-55EZ952B TX-65EZ952B

*e***HELP**

Read first

Before use

- Licence 13

Features

- 4K resolution 16
- Home Screen 17
- Info Frame 18
- Touch Pad Controller 19
- TV Anywhere 20
- Freeview Play EPG 21
- Dual Tuner 22
- Easy Mirroring 23

Home Screen

Home Screen

- Information 24
- How to use 26
- Pin to HOME 27
- Option menu 28

Live TV

- How to use 29
- Option menu 30

Apps

- How to use 31
- My App 32
- Option menu 33

Devices

- How to use 34
- Option menu 35

Watching

Basic

- Satellite connection 36

• Basic connection	38
• Selecting channel	40
• Freeview Play banner (UK)	42
• Information banner	44
• AV Options	47
• Subtitle	49
• Last view	50
• Off Timer	51
• Energy saving functions	52
• Adjusting time	54
• Language	55
4K resolution	
• 4K compatible equipment	57
• HDMI Auto Setting	58
• Valid 4K format	59
External equipment	
• External connection	60
• Watching external input	63
• Operating with TV's remote control	65
• HDMI features	67
• HDMI HDR Setting	69
• Valid input signals	70
For best picture	
• Viewing Mode	71
• Ambient Sensor	73
• Aspect	74
• Aspect Control Signal	75
• Basic settings	77
• Noise reduction settings	80
• Advanced Settings	81
• Option Settings	86
• Screen Settings	89
• Lock Settings	91
• Copy Adjustment	92

For best audio

• Sound mode	93
• Basic settings	94
• Volume settings	96
• Voice Guidance Settings	98
• Audio Description	99
• Advanced settings	100

TV Guide

• Freeview Play EPG (UK)	103
• TV Guide	105
• Timer Programming	107
• Guide link programming	108

Teletext

• Digital text service	109
• Viewing Teletext	110
• Teletext mode	112
• Teletext Character Set	113

Tuning and editing channels

• Setting menu	114
• Channel List Editor	115
• Favourites Editor	117
• Regional Channel Edit	120
• Auto Setup	121
• Channel Sorting by Region	124
• Manual Tuning	125
• Update Channel List	127
• Signal Condition	128
• Add New Channels	129
• Other settings	130

Recording

USB HDD setup

• Preparations	131
----------------	-----

• Setting for USB HDD	133

Recording current programme	
• One Touch Recording	135
• Rewind LIVE TV	136

Timer Programming	
• Setting Timer Programming	138
• Editing Timer Programming	140
• Remote recording	141
• Note	142

Technical information	
• USB HDD	143

Media Player

Using Media Player	
• Information	144
• Selecting device / mode	147
• Network device	149
• Sharing file	150

Easy List View	
• Selecting file	151
• Filtering files	153

Mix Folder View	
• Selecting file	154
• Filtering files	156
• Sorting files	157

Playback	
• Playback	158
• Slideshow Settings	160
• Video Setup	162
• Audio output settings	163

Recorded TV mode	
• Selecting content	164

• Watching recorded TV	165
• Grouping content	167
• Deleting content	168
• Chapter List	169
• Audio output settings	170
Connected device	
• Device handling caution	171
• SD Card	172
• USB devices	173
Supported format	
• Photo format	174
• Video format	175
• Music format	178
Network	
Internet content	
• Information	179
• Selecting internet content	180
• Note	181
DLNA	
• In-House streaming	182
• Using DLNA	184
Network connections	
• Internet connection	185
• DLNA connection	186
• Note	188
Network settings	
• Network Connection	189
• Custom - Wireless	191
• Custom - Wired	194
• Custom - Wireless Access Point	196
• Network Status	197
• my Home Cloud Settings	198

• VIERA Name	199
• TV Remote App Settings	200
• Network Link Settings	202
• TV Anywhere Settings	204
• File Sharing Settings	205
• Mirroring Settings	206
• Control4 Settings	207
• Software Update	208
• New Software Message	209

Photos

• Selecting file	210
• Viewing photo	211
• Using Slideshow	212

Videos

• Selecting file	213
• Watching video	214
• Video Setup	216
• Audio output settings	218

Music

• Selecting file	219
• Playing music	220
• Music Setup	221

Supported format

• Photo format	222
• Video format	223
• Music format	226

Functions

Info Frame

• Information	227
• How to use	228
• Settings	229

Voice Control	
• Information	230
• How to use	231
• Settings	232
• Note	233
Touch Pad Controller	
• Information	234
• Pairing	235
• Identifying controls	236
• Settings	238
TV Anywhere	
• How to use	239
• TV Anywhere Settings	240
Mirroring	
• How to use	241
• Mirroring Settings	242
Multi Window	
• Information	243
• Multi Window	244
• Note	245
VIERA Link “HDAVI Control™”	
• Summary of VIERA Link	246
• Preparations	251
• Easy playback	252
• Power on Link	253
• Power off Link	254
• Standby Power Save	255
• Intelligent Auto Standby	256
• VIERA Link Control	257
• Speaker Selection	259
• Note	260
Child Lock	
• Using Child Lock	261

• PIN number	263
• Parental Rating	264
Data Service Application	
• Using Data Service Application	265
• Privacy Setting	266
• Note	267
Common Interface	
• Caution	268
• Using Common Interface	269
Shipping Condition	
• Shipping Condition	270
Updating the TV Software	
• Information	271
• Auto update	272
• Manual update	273
Setting characters	
• Using Numeric buttons	274
Bluetooth devices	
• Bluetooth Setup	275
Keyboard	
• Keyboard	276
Settings	
Setting menu	
• How to use	277
Picture	
• Viewing Mode	279
• Basic settings	280
• Ambient Sensor	282
• Noise reduction settings	283
• Advanced Settings	284
• Option Settings	285

• Screen Settings	287
• Lock Settings	288
• Copy Adjustment	289
• Reset to Defaults	290
Sound	
• Mode	291
• Basic settings	292
• Volume settings	293
• Voice Guidance Settings	294
• Audio Description	295
• Advanced settings	296
• Reset to Defaults	297
Network	
• Network Connection	298
• Network Status	299
• my Home Cloud Settings	300
• VIERA Name	301
• TV Remote App Settings	302
• Network Link Settings	303
• TV Anywhere Settings	304
• File Sharing Settings	305
• Mirroring Settings	306
• Control4 Settings	307
• Other settings	308
Timer	
• Off Timer	309
• Timer Programming	310
• Time Zone	311
• Auto Standby	312
• No signal Power off	313
Setup	
• Eco Navigation	314
• Voice Control Settings	315

• USB Device Setup	316
• Recording Setup	317
• VIERA Touch Pad Controller	318
• Bluetooth Setup	319
• Child Lock	320
• Tuning Menu	321
• Language	323
• Display Settings	324
• HDMI Auto Setting	326
• HDMI HDR Setting	327
• VIERA Link Settings	328
• Data Service Application	329
• System Menu	330
• Other Settings	331

Support

Help menu

• Using Help menu	332
-------------------	-----

FAQs

• Picture	333
• Digital TV	335
• Analogue TV	337
• Sound	338
• HDMI	339
• Network	340
• Other	342
• Detailed information	344

Maintenance

• Care and Cleaning	345
---------------------	-----

How to use

■ Meaning of signs

OK :

Letters enclosed in brackets indicate remote control buttons.

Menu :

Letters in cyan indicate on-screen display items.

 → :

References in this eHELP

You can jump to the page by pressing **OK** while the cursor is on the references.

■ Operation guide

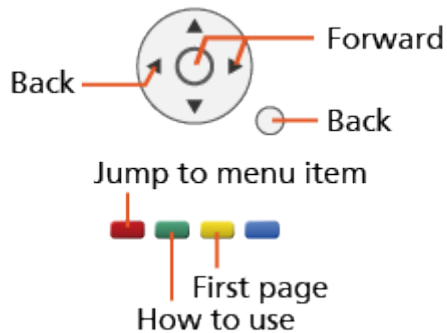

= Note =

- Design and specifications are subject to change without notice.
- The images shown in this eHELP are for illustrative purposes only.
- This eHELP covers all models, however, some features may not be available on certain models.
- Refer to the paper manual and the actual menu in the TV etc. to confirm your model's features.

Read first

Before use

Licence

Even if no special notation has been made of company or product trademarks, these trademarks have been fully respected.

“freesat” is a registered trademark and the “freesat” logo is a trademark of Freesat (UK) Ltd.

DVB and the DVB logos are trademarks of the DVB Project.

THX and the THX logo are trademarks of THX Ltd., registered in the United States and other countries.

The Bluetooth® word mark and logos are registered trademarks owned by Bluetooth SIG, Inc. and any use of such marks by Panasonic Corporation is under license. Other trademarks and trade names are those of their respective owners.

SDXC Logo is a trademark of SD-3C, LLC.

“AVCHD” and “AVCHD Progressive” are trademarks of Panasonic Corporation and Sony Corporation.

DLNA®, the DLNA Logo and DLNA CERTIFIED™ are trademarks, service marks, or certification marks of the Digital Living Network Alliance.

The terms HDMI and HDMI High-Definition Multimedia Interface, and the HDMI Logo are trademarks or registered trademarks of HDMI Licensing Administrator, Inc. in the United States and other countries.

x.v.Colour™ is a trademark.

HDAVI Control™ is a trademark of Panasonic Corporation.

Manufactured under license from Dolby Laboratories.

Dolby, Dolby Audio, and the double-D symbol are trademarks of Dolby Laboratories.

Speech Powered by Dragon

2002-2017 Nuance Communications, Inc. All rights reserved.

“PlayReady” is a trademark registered by Microsoft. Please be aware of the following.

(a) This product contains technology subject to certain intellectual property rights of Microsoft. Use or distribution of this technology outside of this product is prohibited without the appropriate license(s) from Microsoft.

(b) Content owners use Microsoft PlayReady™ content access technology to protect their intellectual property, including copyrighted content. This device uses PlayReady technology to access PlayReady-protected content and/or WMDRM-protected content. If the device fails to properly enforce restrictions on content usage, content owners may require Microsoft to revoke the device’s ability to consume PlayReady-protected content. Revocation should not affect unprotected content or content protected by other content access technologies.

Content owners may require you to upgrade PlayReady to access their content.

If you decline an upgrade, you will not be able to access content that requires the upgrade.

Firefox® OS is a registered trademark of the Mozilla Foundation.

This product incorporates the following software:

- (1) the software developed independently by or for Panasonic Corporation,
- (2) the software owned by third party and licensed to Panasonic Corporation,
- (3) Firefox OS is powered by Mozilla,
- (4) the software licensed under the GNU GENERAL PUBLIC LICENSE Version 2.0 (GPL V2.0),
- (5) the software licensed under the GNU LESSER GENERAL PUBLIC LICENSE Version 2.1 (LGPL V2.1), and/or,
- (6) open source software other than the software licensed under the GPL V2.0 and/or LGPL V2.1.

About the software categorized as (3), please refer to the “About Firefox OS” menu on this product.

The software categorized as (4) - (6) are distributed in the hope that it will be useful, but WITHOUT ANY WARRANTY, without even the implied warranty of MERCHANTABILITY or FITNESS FOR A PARTICULAR PURPOSE. Please refer to the detailed terms and conditions thereof shown in the “Software Licence” menu on this product.

At least three (3) years from delivery of this product, Panasonic will give to any third party who contacts us at the contact information provided below, for a charge no more than our cost of physically performing source code distribution, a complete machine-readable copy of the corresponding source code covered under GPL V2.0, LGPL V2.1 or the other licenses with the obligation to do so, as well as the respective copyright notice thereof.

Contact Information: cdrequest@unipf.jp

The source code and the copyright notice are also available for free in our website below.

<http://www.unipf.jp/dl/EUIDTV17/>

Features

4K resolution

You can watch content in 4K format that has twice the horizontal and vertical resolution of the 1080p signal.

 → [Watching > 4K resolution > 4K compatible equipment](#)

Home Screen

“Home Screen” is a gateway to the TV programmes, applications and connected devices.

It provides you an easy way to access all the features.

 → [Home Screen](#) > [Home Screen](#) > [Information](#)

Info Frame

Info Frame is a convenient feature to provide you relevant information of the programme being watched, recommendations, etc. It is displayed on the edge of screen when you need it.

 → [Functions](#) > [Info Frame](#) > [Information](#)

Touch Pad Controller

The Touch Pad Controller is designed for convenient and intuitive operation of applications and internet content.

 → [Functions](#) > [Touch Pad Controller](#) > [Information](#)

TV Anywhere

You can watch TV and set timer event with the network equipment (smartphone, etc.) from outside the home network.

- Due to network conditions or certain broadcaster restrictions, this function may not be available.

 → [Functions > TV Anywhere > How to use](#)

Freeview Play EPG

Using the Freeview Play EPG enables you to select a programme easily, view programme information, etc.

 → [Watching > TV Guide > Freeview Play EPG \(UK\)](#)

Dual Tuner

You can watch or record 2 programmes simultaneously, watch a programme while recording another programme, etc.

 → [Functions](#) > [Multi Window](#) > [Multi Window](#)

Easy Mirroring

You can watch and display images of other devices (smartphone, etc.) on the TV screen using a mirroring function. You can also start the mirroring function from the other devices without operating the TV.

 → [Functions > Mirroring > How to use](#)

Home Screen

Home Screen

Information

“Home Screen” is a gateway to the TV programmes, applications and connected devices.

Home Screen is displayed by pressing **HOME** and it provides you an easy way to access all the features as shown below (example).

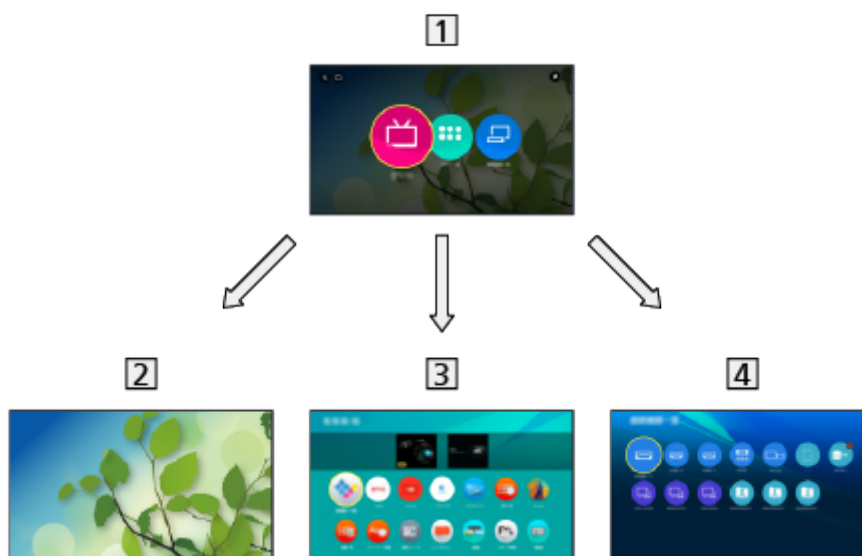

1 Home Screen

2 Live TV

- Gateway to TV programmes

 → Home Screen > Live TV

3 Apps

- Gateway to various applications (internet content, etc.)

 → Home Screen > Apps

4 Devices

- Gateway to connected devices (HDMI equipment, USB device, network device, etc.)

 → Home Screen > Devices

= Note =

- Be sure to update the software when a software update notice is displayed on the TV screen. If the software is not updated, you may not be able to use Home Screen. You can update the software later manually.

 → [Network](#) > [Network settings](#) > [Software Update](#)

How to use

From Home Screen, you can access all the features such as TV programmes, applications and connected devices.

1. Display Home Screen with **HOME**.

(Example)

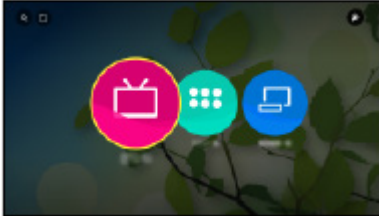

2. Select **Live TV / Apps / Devices** and press **OK** to access.

- To watch full-screen TV, select **Live TV**.

(Example)



- Also refer to  on the top right of Home Screen for the operations.

■ Search

You can search for content from various sources.



1. Display Home Screen with **HOME**.
2. Select  on the top left of Home Screen and press **OK** to access.
3. Follow the on-screen instructions.

■ My Folder

You can create a folder to store your favourite shortcut icons (TV programme / application / device) on Home Screen. Up to 9 shortcuts can be registered in a folder.

- To add a shortcut icon

 → **Home Screen > Home Screen > Pin to HOME**

1. Display Home Screen with **HOME**.
2. Select  on the top left of Home Screen and press **OK** to access.
 -  is not displayed while no shortcut icon is added on Home Screen.
3. Follow the on-screen instructions.

Pin to HOME

You can add a shortcut for a frequently used feature on Home Screen.

1. Display Home Screen with **HOME**.
2. Select [Live TV](#) / [Apps](#) / [Devices](#) and press **OK** to access.
3. Select a feature (TV programme / application / device).
4. Display the option menu with **OPTION**.
5. Select [Pin to HOME](#) and press **OK** to set.
 - To remove a shortcut from Home Screen, set [Unpin from HOME](#).

 → [Home Screen](#) > [Home Screen](#) > [Option menu](#)

Option menu

You can customise Home Screen.

1. Display the option menu with **OPTION**.
2. Select one of the following items and press **OK** to access.

[Unpin from HOME](#) / [Move](#) / [Edit folder](#)

3. Set the item and press **OK** to store.
-

[Unpin from HOME](#)

Removes a shortcut from Home Screen.

[Move](#)

Arranges the position of the icons.

[Edit folder](#)

Edits the folder for the favourite shortcut icons (TV programme / application / device) and the folder name.

- Select the folder name on the top right of the screen and press **OK** to edit the name.

Live TV

How to use

Live TV is a gateway to the TV programmes.

1. Display Home Screen with **HOME**.
2. Select **Live TV**.

(Example)

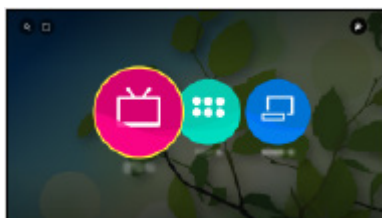

3. Press **OK** to access.

(Example)



- For details of watching TV

 → [Watching > Basic](#)

- To add a shortcut icon

 → [Home Screen > Home Screen > Pin to HOME](#)

Option menu

1. Display the option menu with **OPTION**.
 2. Select one of the following items and press **OK** to access.
[Pin to HOME](#) / [Accessibility](#) / [AV Options](#)
 3. Set the item and press **OK** to store.
-

[Pin to HOME](#)

Adds a shortcut for a frequently used feature on Home Screen.

 → [Home Screen](#) > [Home Screen](#) > [Pin to HOME](#)

[Accessibility](#)

Guidance settings for visually impaired users

 → [Watching](#) > [For best audio](#) > [Voice Guidance Settings](#)

[AV Options](#)

Easy optional setting for viewing, sound, etc.

 → [Watching](#) > [Basic](#) > [AV Options](#)

- Menu items and selectable options vary depending on the TV mode.

Apps

How to use

Various applications (internet content, etc.) can be accessed easily from [Apps](#).

1. Display Home Screen with **HOME**.
2. Select [Apps](#) and press **OK** to access.

(Example)



- To exit [Apps](#)

EXIT

- To add a shortcut icon

 → [Home Screen](#) > [Home Screen](#) > [Pin to HOME](#)

3. Select an application and press **OK** to access.
4. Follow the on-screen instructions.

= Note =

- A broadband network environment is required to fully use this function.
- Design and specifications are subject to change without notice.

My App

You can assign your favourite application to **MY APP** of the TV's remote control. After setting, you can easily start the application only by pressing **MY APP**.

- Only one application can be assigned to **MY APP**.

■ To assign an application for the first time

1. Press **MY APP** to display **My App**.
2. Select the application to assign and press **OK** to set.
 -  is displayed on the assigned application.

■ To change the application to assign

1. Display Home Screen with **HOME**.
2. Select **Apps** and press **OK** to access.
3. Select **My App** and press **OK** to access.
4. Select the application to assign and press **OK** to set.

Option menu

1. Display the option menu with **OPTION**.
 2. Select one of the following items and press **OK** to access.
[Pin to HOME](#) / [Move](#) / [Lock](#) / [Unlock](#) / [Uninstall](#) / [Show Info](#).
 3. Set the item and press **OK** to store.
-

[Pin to HOME](#)

Adds a shortcut for a frequently used feature on Home Screen.

 → [Home Screen](#) > [Home Screen](#) > [Pin to HOME](#)

[Move](#)

Arranges the position of the applications.

[Lock, Unlock](#)

Locks / unlocks a specific application to restrict access (if available).

- Child Lock PIN number is required to access to locked application.

 → [Functions](#) > [Child Lock](#) > [PIN number](#)

[Uninstall](#)

Deletes an application from [Apps](#) (if available).

[Show Info](#).

Displays the information about the selected application.

Devices

How to use

Connected devices (HDMI equipment, USB device, network device, etc.) can be accessed easily from [Devices](#).

1. Display Home Screen with **HOME**.
2. Select [Devices](#) and press **OK** to access.

(Example)

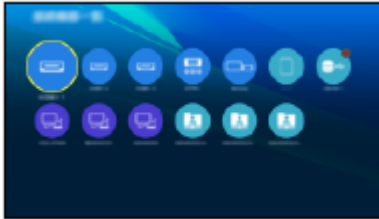

- To exit [Devices](#)

EXIT

- To add a shortcut icon

 → [Home Screen](#) > [Home Screen](#) > [Pin to HOME](#)

3. Select a device and press **OK** to access.

- For external equipment

 → [Watching](#) > [External equipment](#)

- For SD Card, USB device, network device for Media Player

 → [Media Player](#) > [Using Media Player](#)

- For network equipment for DLNA

 → [Network](#) > [DLNA](#)

- For mirroring function

 → [Functions](#) > [Mirroring](#)

= Note =

- Design and specifications are subject to change without notice.

Option menu

1. Display the option menu with **OPTION**.
 2. Select one of the following items and press **OK** to access.
[Pin to HOME](#) / [Accessibility](#) / [Switch to Component](#) / [Switch to Video](#) / [Show Info](#).
 3. Set the item and press **OK** to store.
-

[Pin to HOME](#)

Adds a shortcut for a frequently used feature on Home Screen.

 → [Home Screen](#) > [Home Screen](#) > [Pin to HOME](#)

[Accessibility](#)

Guidance settings for visually impaired users

 → [Watching](#) > [For best audio](#) > [Voice Guidance Settings](#)

[Switch to Component](#) / [Switch to Video](#)

You can select **COMPONENT** and **VIDEO** in **AV**.

[Show Info](#).

Displays the information about the selected device.

Watching

Basic

Satellite connection

Please ensure that the unit is disconnected from the mains socket before attaching or disconnecting any cables.

- External equipment and cables shown are not supplied with this TV.
- Depending on the model, it may be necessary to remove the terminal cover / cable cover before connecting or disconnecting cables.
- For Freesat, Other Sat., Satellite

■ Dual Tuner

Connecting both satellite terminals IN 1 and IN 2 to a satellite dish allows you to watch or record 2 satellite programmes simultaneously.

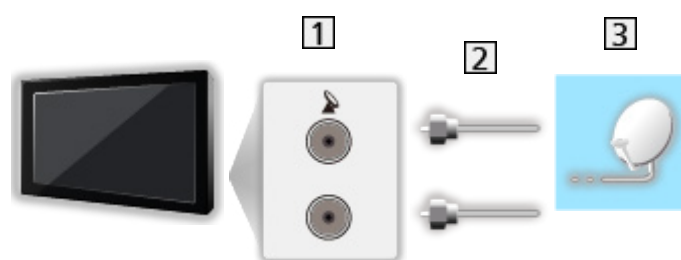

1 Satellite IN 1 / IN 2 terminals

2 Satellite cables

3 Satellite dish

■ Single Tuner

Connect the satellite IN 1 terminal to the satellite dish.

- Watching or recording 2 satellite programmes simultaneously, etc. is not supported in single tuner mode.



1 Satellite IN 1 terminal

2 Satellite cable

3 Satellite dish

= Note =

- To ensure your satellite dish is correctly installed, please consult your local dealer. Also consult the received satellite broadcasting companies for details.
- The Freesat channel uses Astra2 at 28.2° East and Eurobird1 at 28.5° East satellites. To ensure your satellite dish is correctly installed, consult your Freesat registered dealer. (UK only)
- Keep the TV away from electronic equipment (video equipment, etc.) or equipment with an infrared sensor, otherwise distortion of image / sound may occur or operation of other equipment may be affected.
- Check the terminal type and cable plugs are correct for connection.

Basic connection

Please ensure that the unit is disconnected from the mains socket before attaching or disconnecting any cables.

- External equipment and cables shown are not supplied with this TV.
- Depending on the model, it may be necessary to remove the terminal cover / cable cover before connecting or disconnecting cables.

■ Aerial

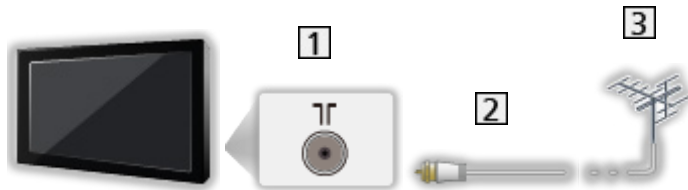

1 Terrestrial terminal

2 RF cable

3 Terrestrial aerial

- For DVB, Analogue

■ DVD Recorder / Blu-ray Recorder, etc.

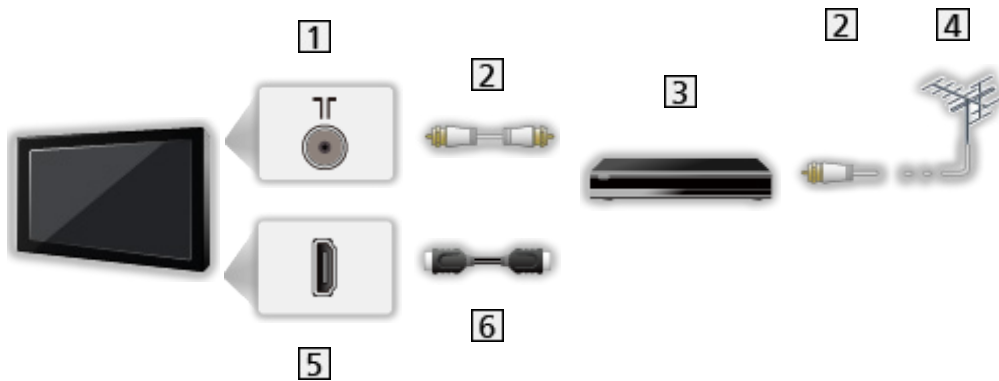

1 Terrestrial terminal

2 RF cable

3 DVD Recorder / Blu-ray Recorder, etc.

4 Terrestrial aerial

5 HDMI terminal

6 HDMI cable

■ Cable TV box

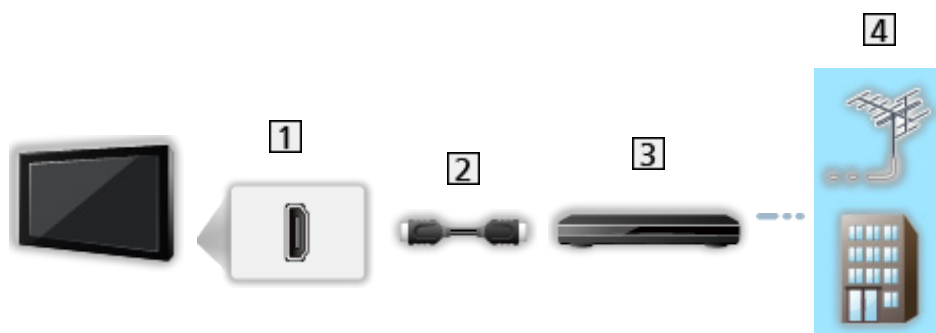

- 1 HDMI terminal
- 2 HDMI cable
- 3 Cable TV box
- 4 Terrestrial aerial / Cable

= Note =

- For details of VIERA Link connections
 → [Functions > VIERA Link "HDAVI Control™" > Summary of VIERA Link](#)
- Please also read the manual of the equipment being connected.
- Keep the TV away from electronic equipment (video equipment, etc.) or equipment with an infrared sensor, otherwise distortion of image / sound may occur or operation of other equipment may be affected.
- Use a fully wired HDMI compliant cable.
- Check the terminal type and cable plugs are correct for connection.

Selecting channel

1. Select the mode with **TV**.

[Freesat](#) (UK only) / [DVB](#) / [Analogue](#) / [Other Sat.](#) (UK only) / [Satellite](#) (Ireland only)

- Selectable modes vary depending on the channels stored.

2. Select a channel with **Channel Up / Down** or **Numeric buttons**.



- Freesat channel position numbers are in the 101 - 999 and 0101 - 0999 ranges. DVB and Other Sat. / Satellite channel position begin from number 1 upward. Analogue channel position numbers are in the 0 - 99 range.

■ To select a channel using information banner

1. Display information banner with **i** if it is not displayed.
2. Select a channel and press **OK** to watch while the banner is displayed.

→ [Watching > Basic > Freeview Play banner \(UK\)](#)

→ [Watching > Basic > Information banner](#)

■ To select a channel using TV Guide

1. Display [TV Guide](#) with **GUIDE**.
2. Select the current programme and press **OK** to access.
 - The current programme is displayed on the top left of the screen.
3. Select [Watch Now](#) or [View](#) and press **OK** to watch.

- For Ireland

→ [Watching > TV Guide > TV Guide](#)

- For details of Freeview Play EPG

→ [Watching > TV Guide > Freeview Play EPG \(UK\)](#)

- Not valid in Analogue

■ To display the application bar (UK and DVB only)

1. Display the application bar with **OK**.
2. Select the application and press **OK** to access.
 - For the applications, follow the on-screen instructions.

■ To select the type of channel list

- For DVB (Ireland only), Other Sat., Satellite

Automatically selects all channels or favourites list in the information banner when the TV is turned on.

1. Display the menu with **MENU**.
2. Select [Setup](#) > [Other Settings](#) > [Power on Channel List](#) and press **OK** to access.
3. Select [All Channel List](#) / [Last](#) and press **OK** to set.

■ To watch pay-TV

- For details of the encrypted channels

 → [Functions](#) > [Common Interface](#) > [Using Common Interface](#)

- Consult the operator / broadcaster or CI module manufacturer for more information and conditions of the services.

Freeview Play banner (UK)

Display information banner with .

- Also appears when changing a channel.
- For DVB (UK only)

(Example)

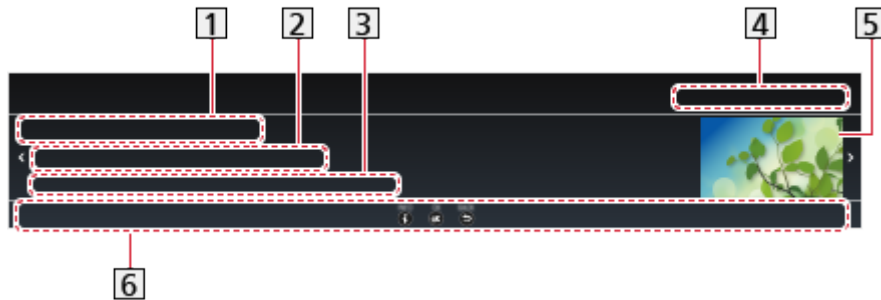

- 1 Channel position and name
- 2 Programme
- 3 Date / Start time / End time
- 4 Current date and time
- 5 Event image (when available)
- 6 Features available / message meanings

AD:

Audio Description service available

- This function can aid visually-impaired viewers by providing an additional audio track to describe events on screen.

 → [Watching > For best audio > Audio Description](#)

SD:

SD broadcasts available

SD>HD:











Same programme available as HD broadcast

SL:



Sign language available

S:

Subtitle service available

- To confirm another tuned channel

- To watch the channel listed in the banner

- Information on the next programme

- Extra information

 - Press again to hide the banner.
- To hide the banner

- To adjust banner timeout, set [Banner Display Timeout](#).
 - 1) Display the menu with .
 - 2) Select [Setup](#) > [Display Settings](#) > [Banner Display Timeout](#) and press  to access.
 - 3) Set the item and press  to store.
- To display the introduction banner for the internet service
 - 1) Display the menu with .
 - 2) Select [Setup](#) > [Display Settings](#) > [Smart Banner](#) and press  to access.
 - 3) Select [On / Off](#) and press  to set.

= Note =





- In Freesat / Other Sat., the information banner will appear when pressing .
-  → [Watching](#) > [Basic](#) > [Information banner](#)

Information banner

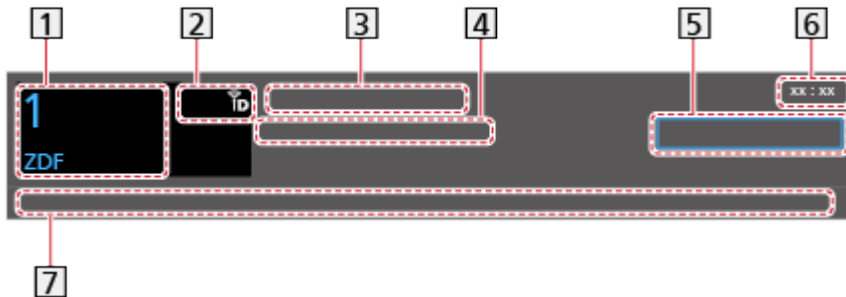
Display information banner with .

- Also appears when changing a channel.
- For Analogue, DVB (Ireland only), Freesat, Other Sat., Satellite (Example)



- 1** Channel position and name
- 2** Channel type (Radio, HDTV, etc.) / Encrypted channel () / TV mode (, , )
- 3** Programme
- 4** Start time / End time (except Analogue)
Channel position, etc. (Analogue)
Progress time indicator of the selected programme (except Analogue)
- 5** [All DVB Channels](#) / [All Other Sat. Channels](#) / [All Satellite Channels](#) / [All Analogue Channels](#) / [Favourites](#)
 - Press  (blue) to switch. (DVB / Other Sat. / Satellite)
 - To list favourite channels, set [Favourites Editor](#).
- 6** Current time
- 7** Features available / message meanings

Bad signal:

Poor quality TV signal

DD+, DD, HE-AAC:

Dolby Audio (Dolby Digital Plus, Dolby Digital) or HE-AAC audio track

AD:

Audio Description service available

- This function can aid visually-impaired viewers by providing an additional audio track to describe events on screen.

 → [Watching > For best audio > Audio Description](#)

Also in :

Same programme available as HD broadcast (UK only)

- To display the extra information for details



STTL:

Subtitle service available

TEXT:

Text service available

Multi Audio:

Multiple audio available

Stereo, Mono, NICAM:

Audio mode

1 – 90:

Off Timer remaining time

 → [Watching > Basic > Off Timer](#)

- To confirm another tuned channel



- To watch the channel listed in the banner



- Information on the next programme (DVB)



- Extra information (DVB)



– Press again to hide the banner.

- To hide the banner



- To adjust banner timeout, set [Banner Display Timeout](#).

1) Display the menu with .

2) Select [Setup > Display Settings > Banner Display Timeout](#) and press  to access.

3) Set the item and press  to store.

- To display the introduction banner for the internet service
 - 1) Display the menu with **MENU**.
 - 2) Select **Setup > Display Settings > Smart Banner** and press **OK** to access.
 - 3) Select **On / Off** and press **OK** to set.
- **AD, STTL, TEXT, Multi Audio** indications are displayed as available on particular programmes, but may not be available for all individual programmes being broadcast. Display the extra information to confirm availability of these functions.

AV Options

Confirm or change the current status.

- Display the full-screen TV to use this function.
1. Display the option menu with **OPTION**.
 2. Select **AV Options** and press **OK** to access.
 3. Select one of the following items and press **OK** to access.
[Audio Type](#) / [Multi Audio](#) / [Monaural Audio](#) / [Sub Channel](#) / [Subtitle Language](#) / [Teletext Character Set](#) / [Teletext Language](#) / [NICAM](#) / [Volume Correction](#)
 - The function items vary depending on the TV mode and country you select.
 4. Set the item and press **OK** to store.
-

Audio Type

Set to **Audio Description** if the programme has Audio Description service, then you will hear an additional audio track to describe events on screen (if available).

- For DVB
 - To adjust the volume for Audio Description
 → **Watching > For best audio > Audio Description**
 - Not valid in multi window mode
-

Multi Audio

Selects between alternative language or Audio Description for sound tracks (if available).

- This setting is not memorised and it returns to the default setting once you exit the current programme.
 - For DVB
 - **Multi Audio / AD** is displayed instead of **Multi Audio**. (Ireland only)
-

Monaural Audio

Selects stereo / monaural (if available).

- This setting is not memorised and it returns to the default setting once you exit the current programme.
 - Not valid in Analogue
-

Sub Channel

Selects the multifeed programme - sub channel (if available).

- For Other Sat., Satellite
-

Subtitle Language

Selects the language in which subtitles should appear (if available).

- This setting is not memorised and it returns to the default setting once you exit the current programme.
 - Not valid in Analogue
 - Not valid on the sub screen in multi window mode
-

Teletext Character Set

Sets the teletext language font.

 → Watching > Teletext > Teletext Character Set

- Ireland only
-

Teletext Language

Selects between alternative languages for teletext (if available).

- For DVB (Ireland only), Satellite
-

NICAM

Switches NICAM sound (if available).

 → Watching > For best audio > Advanced settings

- For Analogue
-

Volume Correction

Adjusts the volume of each individual channel or input mode.

Subtitle

■ Freesat, DVB, Other Sat., Satellite

Display / hide subtitles (if available) with **STTL**.

- To select the preferred subtitle type
 - 1) Display the menu with **MENU**.
 - 2) Select **Setup > Display Settings > Preferred Subtitle Type** and press **OK** to access.
 - 3) Select **Standard / Hard of Hearing** and press **OK** to set.
 - **Hard of Hearing** provides aids in understanding and enjoyment with digital channel subtitles (depending on the broadcaster).
 - Ireland only
- **Preferred Subtitles 1 / 2** in Language are given priority.
 -  → **Watching > Basic > Language**
 - Ireland only

■ Analogue

Display subtitles with **STTL**.

- Hide subtitles with **EXIT**.

= Note =

- If you press **STTL** in Analogue, the TV switches to teletext service and calls up a favourite page. Press **EXIT** to return to TV mode.
- This is the same as switching to analogue teletext service and selecting “P888” (subtitle service).

 → **Watching > Teletext > Viewing Teletext**

- Not valid on the sub screen in multi window mode

Last view

Switch to a previously viewed channel or input mode easily with last view button.



- Press again to return to the current view.

= Note =

- Switching channel may not be available depending on the condition.
- Watching less than 10 seconds is not reflected in the previously viewed channel or input mode.

Off Timer

Switch to TV Standby mode automatically after a fixed period.

1. Display the menu with **MENU**.
2. Select **Timer** > **Off Timer** and press **OK** to access.
3. Select the time in 15-minute increments and press **OK** to set.
90 / 75 / 60 / 45 / 30 / 15 / Off (minutes)
 - To cancel, set to **Off** or turn the TV off.
 - The remaining time is displayed on the bottom right of the screen.
 - The remaining time will flash on the screen when less than 3 minutes.

Energy saving functions

The TV can be eco-friendly using energy-saving functions.

The TV goes into Standby mode in the following conditions:

- [Eco Navigation](#) is set to [Set to Eco](#).
- [Off Timer](#) is active.
 → [Watching](#) > [Basic](#) > [Off Timer](#)
- No operation is performed for 4 hours while [Auto Standby](#) is set to [On](#).
- No signal is received and no operation is performed for 10 minutes while [No signal Power off](#) is set to [On](#).

= Note =

- This function does not affect the recording.

■ Auto Standby

1. Display the menu with **MENU**.
 2. Select [Timer](#) > [Auto Standby](#) and press **OK** to access.
 3. Select [On](#) / [Off](#) and press **OK** to set.
-

[Auto Standby](#)

([On](#) / [Off](#))

Automatically turns the TV to Standby mode for energy saving when no operation is performed for 4 hours.

- Automatic input switching with the connected equipment affects this function and time-count resets.
- A notification message will appear 3 minutes before going into Standby mode.
- Changing the default configuration may result in higher energy consumption of the product.

■ No signal Power off

1. Display the menu with **MENU**.
 2. Select **Timer** > **No signal Power off** and press **OK** to access.
 3. Select **On / Off** and press **OK** to set.
-

No signal Power off

(On / Off)

Automatically turns the TV to Standby mode to prevent unnecessary power consumption when no signal is received and no operation is performed for 10 minutes.

- A notification message will appear 3 minutes before going into Standby mode.

■ Eco Navigation

Automatically sets the TV to the most suitable energy-saving mode.

The concerned items and their current settings are displayed. Select **Set to Eco** to set them to the energy-saving settings at once.

1. Display the menu with **MENU**.
 2. Select **Setup** > **Eco Navigation** and press **OK** to access.
 3. Select **Set to Eco** and press **OK** to set.
- **Auto Standby** and **No signal Power off** are active when **Eco Navigation** is set to **Set to Eco**.

■ Radio Mode

Sets the timer for turning off the screen automatically when a radio channel is selected.

1. Display the menu with **MENU**.
2. Select **Setup** > **Display Settings** > **Radio Mode** and press **OK** to access.
3. Select the time and press **OK** to set.

20 / 15 / 10 / 5 / Off (seconds)

- Sound is active even if the screen is turned off. This function is effective in reducing power consumption when listening to a radio channel.
- Press any buttons except Standby On / Off switch, **Volume Up / Down** and **MUTE** to turn the screen on.



- Not valid in Analogue

Adjusting time

Adjusts the time data.

1. Display the menu with **MENU**.
2. Select **Timer > Time Zone** and press **OK** to access.
3. Set the item and press **OK** to store.
 - The time data are corrected based on GMT.
 - Ireland only

Language

1. Display the menu with **MENU**.
2. Select **Setup > Language** and press **OK** to access.
3. Select one of the following items and press **OK** to access.

[Preferred Multi Audio](#) / [Preferred Audio 1 / 2](#) / [Preferred Subtitles 1 / 2](#) / [Preferred Subtitles](#) / [Preferred Teletext](#)

4. Set the item and press **OK** to store.
-

Preferred Multi Audio

Selects the preferred language for digital channel multi audio (depending on the broadcaster).

- UK only
-

Preferred Audio 1 / 2

Selects the first and second preferred language for digital channel multi audio (depending on the broadcaster).

- Ireland only
-

Preferred Subtitles 1 / 2

Selects the first and second preferred language for digital channel subtitles (depending on the broadcaster).

- Ireland only
- To display subtitles

 → [Watching > Basic > Subtitle](#)

Preferred Subtitles

Selects the preferred language for digital channel subtitles (depending on the broadcaster).

- To display subtitles

 → [Watching > Basic > Subtitle](#)

- provides aids in understanding and enjoyment with subtitles (depending on the broadcaster).
 - UK only
-

Preferred Teletext

Selects the preferred language for digital channel teletext service (depending on the broadcaster).

- Ireland only

4K resolution

4K compatible equipment

You can watch content in 4K format that has twice the horizontal and vertical resolution of the 1080p signal.

- For details of valid 4K format

 → [Watching > 4K resolution > Valid 4K format](#)

- Connect the 4K compatible equipment to HDMI terminal using a 4K compatible cable and you can watch content in 4K format.
- Depending on the model, it may be necessary to remove the terminal cover / cable cover before connecting or disconnecting cables.

■ 4K compatible equipment



1 HDMI terminal

2 HDMI cable

3 4K compatible equipment

- Check the terminal type and cable plugs are correct for connection.
- Use a fully wired HDMI compliant cable.

HDMI Auto Setting

1. Display the menu with **MENU**.
 2. Select **Setup > HDMI Auto Setting** and press **OK** to access.
 3. Set the item and press **OK** to store.
-

HDMI Auto Setting

([Mode1](#) / [Mode2](#))

Reproduces the image more precisely with the expanded colour gamut when connecting the 4K compatible equipment. Select the mode depending on the equipment.

[Mode1](#):

For better compatibility. Set to [Mode1](#) when the image or sound in HDMI input is not played properly.

[Mode2](#):

For the 4K compatible equipment that has the function to output the image precisely with the expanded colour gamut

- The setting can be stored for each HDMI input.
- For HDMI1/2
- Valid format (4K)
 - [Mode1](#): 4:4:4 / 4:2:2 (30p, 25p, 24p), 4:2:0 (60p, 50p)
 - [Mode2](#): 4:4:4 / 4:2:2 (30p, 25p, 24p), 4:4:4 / 4:2:2 / 4:2:0 (60p, 50p)

Valid 4K format

■ Valid 4K format (HDMI)

- 4K UHD

3 840 × 2 160 (60p, 50p, 30p, 25p, 24p)

- Aspect is fixed to **16:9**.
-

- DCI 4K

4 096 × 2 160 (60p, 50p, 30p, 25p, 24p)

- Actual resolution is 3 840 × 2 160p.
 - Aspect is fixed to **V Full**.
-

= Note =

- Connect to HDMI1 or HDMI2 for the following formats.
 - 60p, 50p / 4:4:4, 4:2:2
- The above signals are reformatted for optimal viewing on your display.
- For details of aspect

 → **Watching > For best picture > Aspect**

External equipment

External connection

These diagrams show our recommendations for connection of your TV to various pieces of equipment. For other connections, consult the instructions for each piece of equipment.

- For details of basic connection

 → [Watching > Basic > Basic connection](#)

- To use the specific devices supporting Bluetooth wireless technology

 → [Functions > Bluetooth devices](#)

- Check the terminal type and cable plugs are correct for connection.
- External equipment and cables shown are not supplied with this TV.
- Depending on the model, it may be necessary to remove the terminal cover / cable cover before connecting or disconnecting cables.

■ HDMI equipment

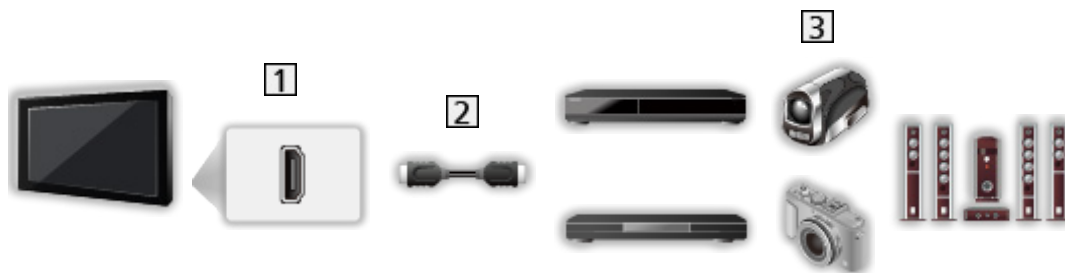

1 HDMI terminal

2 HDMI cable

3 Recorder / Player / Cable TV box / Camcorder / Amplifier with speaker system

= Note =

- Use a fully wired HDMI compliant cable.
- For details of VIERA Link connections

 → [Functions > VIERA Link "HDAVI Control™" > Summary of VIERA Link](#)

- Use HDMI2 to connect the TV to an amplifier which has ARC (Audio Return Channel) function.

■ AV devices

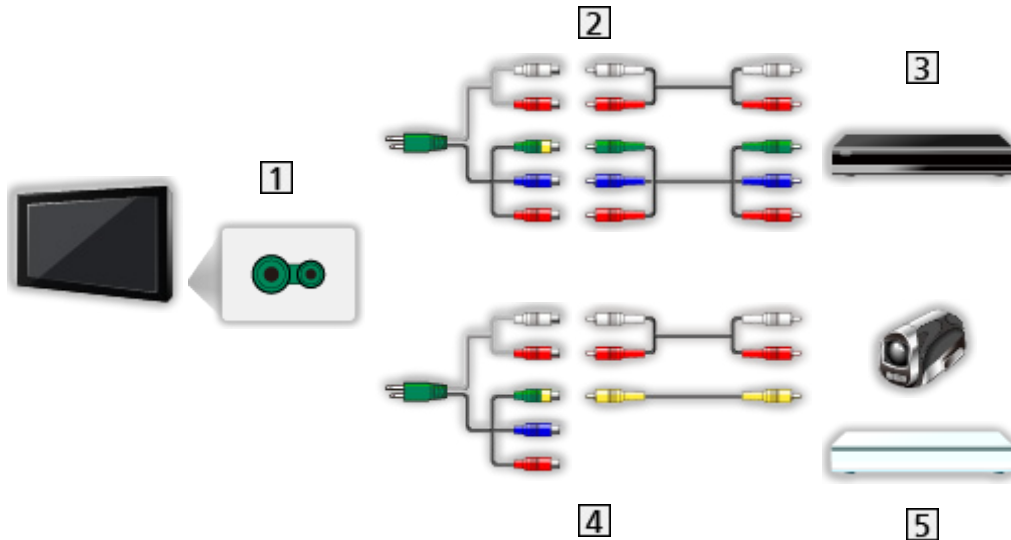

1 AV (COMPONENT) terminals

2 Component cables

- AV (COMPONENT / VIDEO) adaptor (supplied) is necessary when connecting to the TV.

3 DVD Player, etc.

4 Composite cables

- AV (COMPONENT / VIDEO) adaptor (supplied) is necessary when connecting to the TV.

5 Camcorder / Game equipment

■ USB devices



1 USB port

2 USB cable

3 USB HDD, etc.

= Note =

- It is recommended to connect the device to the TV's USB port directly.
- You cannot use two or more of the same kind of USB devices simultaneously except USB Flash Memory or USB HDD.
- Use USB 1 port for connecting the USB HDD.
- Some USB devices or USB HUB may not be used with this TV.
- You cannot connect any devices by using USB card reader.

■ Listening with external speakers



1 DIGITAL AUDIO

2 Optical digital audio cable

3 Amplifier with speaker system

- To enjoy multi-channel sound from external equipment (e.g. Dolby Audio (Dolby Digital) 5.1ch), connect the equipment to the amplifier. For information about the connections, read the manuals of the equipment and amplifier.
- To select the sound output to adjust volume, set [TV Speaker Setting](#).

 → [Watching > For best audio > Volume settings](#)

■ Headphones

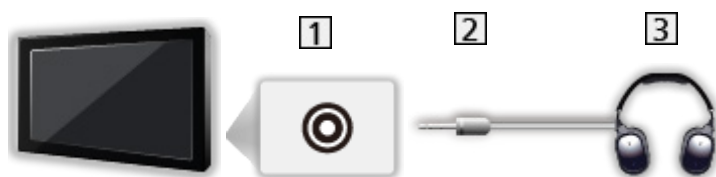

1 Headphone jack

2 M3 stereo mini plug

3 Headphones

- To adjust volume, set [Headphone Volume](#).
- To select the sound output to adjust volume, set [TV Speaker Setting](#).

 → [Watching > For best audio > Volume settings](#)

Watching external input

Connect the external equipment (VCR, DVD, etc.) and you can watch through the input.

1. Display the input selection menu with **AV**.
2. Select the input mode connected to the equipment and press **OK** to watch. (The selected mode is displayed on the top left of the screen.)
 - You can also select the input pressing **AV**. Press repeatedly until the desired input is selected.
 - You can select **COMPONENT** and **VIDEO** in **AV**.
 - You can label or skip each input mode. Skipped inputs will not be displayed when **AV** is pressed. ([Input Labels](#))
 - The remote control is capable of operating the content or external equipment.

 → [Watching > External equipment > Operating with TV's remote control](#)

- To return to TV mode



= Note =

- If the external equipment has an aspect adjustment function, set it to **16:9**.
- For details, read the manual of the equipment or ask your local dealer.

■ Input Labels

Accessing the input labels list allows you to change the input name or skip the input if unconnected, improving identification and selection in the [Input Selection](#) banner.

 → [Watching > Basic > Freeview Play banner \(UK\)](#)

 → [Watching > Basic > Information banner](#)

1. Display the menu with **MENU**.
2. Select [Setup > Display Settings > Input Labels](#) and press **OK** to access.
3. Set the item and press **OK** to set.
 - To name each input mode freely, select [User input](#) and set characters (maximum 10 characters).
 - To skip the input mode, select [Skip](#).

■ Playing Time Display

Set to **On** to display a time period of continuous use in Game Mode on the top right of the screen every 30 minutes.

1. Display the menu with **MENU**.
2. Select **Setup > Display Settings > Playing Time Display** and press **OK** to access.
3. Select **On / Off** and press **OK** to set.
 - This function is available when **Game Mode** is set to **On**.

Operating with TV's remote control

You can operate the content in Media Player / media server, recording functions or the connected equipment with the following buttons of this TV's remote control.



Playback (VCR / DVD / video content)



Stop the operations



Rewind, view the picture rapidly in reverse (VCR)

Skip to the previous track, title or chapter (DVD / video content)



Rewind, view the picture rapidly in reverse (VCR)

Search backward (DVD / video content)



Fast-forward, view the picture rapidly forward (VCR)

Skip to the next track, title or chapter (DVD / video content)



Fast-forward, view the picture rapidly forward (VCR)

Search forward (DVD / video content)



Pause / Resume

Press and hold to play at slow speed (DVD)



[One Touch Recording](#)

 → [Recording > Recording current programme > One Touch Recording](#)

■ How to change the code

Each Panasonic product has its own remote control code. Change the code according to the product for operation.

1. Press and hold Standby On / Off switch during the following operations.



2. Enter the appropriate code as follows with **Numeric buttons**.



- Codes for each product and features

70: DVD Recorder, DVD Player, Blu-ray Disc Player

71: Player theatre, Blu-ray Disc theatre

72: VCR

73 (default):

Using in USB HDD recording, Media Player, DLNA features or VIERA Link

3. Press  to change.

= Note =

- Confirm if the remote control works correctly after changing the code.
- The codes may be reset to defaults if batteries are replaced.
- Some operations may not be available depending on the equipment.

HDMI features

HDMI (high-definition multimedia interface) is the world's first complete digital consumer AV interface complying with a non-compression standard.

HDMI allows you to enjoy high-definition digital images and high-quality sound by connecting the TV to external equipment.

HDMI-compatible equipment* with an HDMI or DVI output terminal, such as a DVD player, a set top box or game equipment, can be connected to the HDMI terminal using a fully wired HDMI compliant cable.

 → [Watching > External equipment > External connection](#)

*: The HDMI logo is displayed on HDMI-compliant equipment.

■ Applicable HDMI features

- Input audio signal:

2ch LPCM, Dolby Audio (Dolby Digital, Dolby Digital Plus)

- Audio settings can be made on [HDMI Audio Format](#) in the Sound Menu.

 → [Watching > For best audio > Advanced settings](#)

- Input video signal:

Matches the output setting of the digital equipment.

 → [Watching > External equipment > Valid input signals](#)

- VIERA Link (HDAVI Control 5)

 → [Functions > VIERA Link "HDAVI Control™" > Summary of VIERA Link](#)

- Content Type

- Deep Colour

- Audio Return Channel

- Audio Return Channel (ARC) is a function to send digital sound signals via an HDMI cable.

- For HDMI2

- x.v.Colour™

- 4K

 → [Watching > 4K resolution > Valid 4K format](#)

■ DVI connection

If the external equipment has only a DVI output, connect to the HDMI terminal via a DVI to HDMI adaptor cable. When using the DVI to HDMI adaptor cable, connect the audio cable to the audio input terminal (use COMPONENT / VIDEO audio terminals).

- AV (COMPONENT / VIDEO) adaptor (supplied) is necessary when connecting to the COMPONENT / VIDEO audio terminals.
- Enquire HDMI adaptor cable at your local digital equipment retailer shop.

= Note =

- Audio settings can be made on [HDMI Audio Format](#) / [HDMI Input](#) in the Sound Menu.
 → [Watching > For best audio > Advanced settings](#)
- If the connected equipment has an aspect adjustment function, set the aspect ratio to “16:9”.
- These HDMI connectors are “type A”.
- These HDMI connectors are compatible with HDCP (High-Bandwidth Digital Content Protection) copyright protection.
- Equipment having no digital output terminal may be connected to the input terminal of component or video to receive analogue signals.
- This TV incorporates HDMI™ technology.

HDMI HDR Setting

1. Display the menu with **MENU**.
 2. Select **Setup > HDMI HDR Setting** and press **OK** to access.
 3. Set the item and press **OK** to store.
-

HDMI HDR Setting

(On / Off)

Set to **On** when the HDR device is connected to the TV.

- Please turn **Off** this function if the image looks unnatural. This may occur in some cases such as compatibility with the connected device, source images or with use of multi-window function.
- Image may disappear for a few seconds when the setting is changed.
- For HDMI

Valid input signals

■ COMPONENT, HDMI

Signal name	COMPONENT	HDMI
525 (480) / 60i, 60p	○	○
625 (576) / 50i, 50p	○	○
750 (720) / 60p, 50p	○	○
1 125 (1 080) / 60i, 50i	○	○
1 125 (1 080) / 60p, 50p, 24p		○
3 840 × 2 160 / 60p, 50p, 30p, 25p, 24p		○
4 096 × 2 160 / 60p, 50p, 30p, 25p, 24p		○

○: Applicable input signal

= Note =

- Signals other than above may not be displayed properly.
- The above signals are reformatted for optimal viewing on your display.
- For details of valid 4K format

 → [Watching > 4K resolution > Valid 4K format](#)

For best picture

Viewing Mode

Some features are not available on all models. Available menu items are displayed on your TV screen.

1. Display the menu with **MENU**.
 2. Select **Picture** > **Viewing Mode** and press **OK** to access.
 3. Select the mode and press **OK** to set.
-

Viewing Mode

([Dynamic](#) / [Normal](#) / [Professional Photo](#) / [Cinema](#) / [THX Cinema](#) / [THX Bright Room](#) / [True Cinema](#) / [Custom](#) / [Professional1](#) / [Professional2](#))

Selects your favourite picture mode for each input.

Dynamic:

Improves contrast and sharpness for viewing in a bright room.

Normal:

Normal use for viewing in a normal lighting condition.

Professional Photo:

Reproduces the original image for photo.

- For photo content

Cinema:

Improves the performance of contrast, black and colour reproduction for watching movies in a darkened room.

THX Cinema*:

Reproduces the original image quality precisely in a darkened room.

THX Bright Room*:

Reproduces the original image quality precisely in a bright room.

True Cinema:

Reproduces the original image quality precisely without any revision.

Custom:

Adjusts each menu item manually to suit your favourite picture quality.

Professional1 / 2:

Allows you to set and lock the professional picture settings.

 → [Watching](#) > [For best picture](#) > [Advanced Settings](#)

- If a certified professional dealer sets these modes, [Professional1](#) and [Professional2](#) may be displayed as [isf Day](#) and [isf Night](#).

- The following items can be adjusted and stored for each mode.
Luminance Level / Contrast / Brightness / Colour / Tint / Sharpness /
Colour Temperature / Vivid Colour / Colour Remaster / Rec.2020 Colour
Remaster / Reversal Film Effect / Ambient Sensor / Noise Reduction /
MPEG Remaster / Resolution Remaster / Dynamic Range Remaster /
Intelligent Frame Creation / Clear Motion
 - This function can be memorised respectively for input or TV mode.
- *: THX modes are used to mirror the picture settings used by professional filmmakers, faithfully reproducing the image quality of THX Certified movies. THX Certified movies have the THX logo on the disc. THX modes are not available for photo content.

Ambient Sensor

1. Display the menu with **MENU**.
 2. Select **Picture > Ambient Sensor** and press **OK** to access.
 3. Select **On / Off** and press **OK** to set.
-

Ambient Sensor

(On / Off)

- Automatic Brightness Control function

Adjusts picture settings automatically depending on ambient lighting condition.

Aspect

Change the aspect ratio (image size) with **ASPECT**.

■ To change the aspect ratio manually

1. Display **Aspect Selection** with **ASPECT**.
2. Select the mode and press **OK** to set.
 - You can also change the mode pressing **ASPECT**.
(Press repeatedly until you reach the desired mode.)

Auto:

The best ratio is selected automatically according to the “Aspect Control Signal”.

 → Watching > For best picture > Aspect Control Signal

16:9:

Directly displays the image at 16:9 without distortion (anamorphic).

4:3:

Displays the image at the standard 4:3 without distortion.

Zoom:

Displays a 16:9 letterbox or 4:3 image without distortion.

4:3 Full:

Displays a 4:3 image enlarged horizontally to fit the screen.

V Full:

Displays the image enlarged vertically to fit the screen without distortion.

- For DCI 4K format

= Note =

- Display the image (TV, external input, etc.) full-screen to use this function completely.
- Aspect mode can be memorised separately for SD (Standard definition) and HD (High definition) signals.
- Aspect cannot be changed in teletext service.
- Aspect is fixed to **16:9** in the following conditions:
 - **Game Mode** is set to **On**.
 - **1080p Pure Direct** is set to **On**.
 - **4K Pure Direct** is set to **On**.
 - **1080p Pixel by 4pixels** is set to **On**.
 - 4K content except DCI 4K

Aspect Control Signal

Programmes usually contain an “Aspect Control Signal”. (Widescreen signal, Control signal through HDMI terminal)

In **Auto** mode, aspect mode will appear in the top left of the screen if a Widescreen signal (WSS) or a Control signal through HDMI terminal is found. The aspect switches to the appropriate ratio.

 → Watching > For best picture > Aspect

■ Available conditions

● Terrestrial terminal (WSS only)

Valid input signal format:

DVB

PAL I

Invalid input signal format:

PAL 525/60 6.0 MHz

M.NTSC 6.0 MHz

● Satellite terminal (WSS only)

Valid input signal format:

Freesat, Other Sat., Satellite

● AV (VIDEO) terminals

Valid input signal format:

PAL

PAL 525/60 *

M.NTSC *

NTSC *

*: Control signal through HDMI terminal only

- AV (COMPONENT) terminals (WSS only)

Valid input signal format:

625 (576) / 50i, 50p

Invalid input signal format:

525 (480) / 60i, 60p

750 (720) / 60p, 50p

1 125 (1 080) / 60i, 50i

- HDMI terminal

Valid input signal format:

525 (480) / 60i, 60p

625 (576) / 50i, 50p

750 (720) / 60p, 50p

1 125 (1 080) / 60i, 50i

1 125 (1 080) / 60p, 50p, 24p

3 840 × 2 160 / 60p, 50p, 30p, 25p, 24p

4 096 × 2 160 / 60p, 50p, 30p, 25p, 24p

- HDMI terminal does not receive WSS signal.
-

= Note =

- If the screen size looks unusual when a widescreen-recorded programme is played back on a VCR, adjust the tracking of the VCR. Read the manual of the VCR.
- For details of valid 4K format

 → [Watching > 4K resolution > Valid 4K format](#)

Basic settings

1. Display the menu with **MENU**.
 2. Select **Picture** and press **OK** to access.
 3. Select one of the following items and press **OK** to access.
Luminance Level / Contrast / Brightness / Colour / Tint / Sharpness / Colour Temperature / Vivid Colour / Colour Remaster / Rec.2020 Colour Remaster / Reversal Film Effect / Resolution Remaster / Dynamic Range Remaster / Intelligent Frame Creation / Clear Motion
 4. Set the item and press **OK** to store.
-

Luminance Level, Contrast, Brightness, Colour, Tint, Sharpness

Adjusts the levels of these options according to your personal preference.

- **Sharpness** is not available when **1080p Pixel by 4pixels** is set to **On**.
-

Colour Temperature

Sets the overall colour tone of the picture (bluer - redder).

Vivid Colour

(On / Off)

Automatically adjusts colours to vivid ones.

Colour Remaster

(Max / Min / Off)

Displays the vivid images with the expanded colour gamut.

- Not valid in the following conditions:
 - Photo content
 - **Viewing Mode** is THX mode.
-

Rec.2020 Colour Remaster

(Max / Min / Off)

Displays the vivid images with the suitable colour gamut.

- This function is available only for Rec. 2020 and displayed instead of **Colour Remaster**.
-

Reversal Film Effect

(Max / Min / Off)

Provides the picture effect such as the reversal film for photo content.

- For photo content
 - Not valid when [Viewing Mode](#) is THX mode
-

Resolution Remaster

(Auto / Max / Mid / Min / Off)

Enhances picture resolution to make the image sharper.

- Not valid when [1080p Pixel by 4pixels](#) is set to [On](#)
-

Dynamic Range Remaster

(On / Off)

Enhances bright areas of the image closer to the original luminance making improved picture impact.

- Not valid in the following conditions:
 - Multi window
 - [Contrast Control](#) is set to [Off](#).
-

Intelligent Frame Creation

(Custom / Max / Mid / Min / Off)

Automatically compensates the picture frame rate and removes juddering movements to make the images smooth.

- Depending on the content, images may be noisy. To prevent the noise, change the setting.
- Select [Custom](#) to set [Intelligent Frame Creation](#) manually.

[Blur Reduction](#):

Adjusts the smoothness of camera content to minimise blur.

[Film Smooth](#):

Adjusts the smoothness of film content.

[Reset to Defaults](#):

Resets items for [Intelligent Frame Creation](#).

- Not valid in the following conditions:
 - [Game Mode](#) is set to [On](#).
 - [1080p Pixel by 4pixels](#) is set to [On](#).
 - [1080p Pure Direct](#) is set to [On](#).

- 4K Pure Direct is set to On.
 - Photo content
-

Clear Motion

(On / Off)

Makes the blurring image clearer such as when [Game Mode](#) is set, etc.

- Not valid for photo content

Noise reduction settings

1. Display the menu with **MENU**.
 2. Select **Picture** > **Noise Reduction** / **MPEG Remaster** and press **OK** to access.
 3. Set the item and press **OK** to store.
-

Noise Reduction

(Auto / Max / Mid / Min / Off)

Reduces unwanted picture noise.

MPEG Remaster

(Auto / Max / Mid / Min / Off)

Reduces flicker noise in contoured parts of a picture and block noise.

Advanced Settings

Some features are not available on all models. Available menu items are displayed on your TV screen.

You can adjust and set up the detailed picture settings when **Viewing Mode** is set to **Professional Photo**, **Cinema**, **True Cinema**, **Custom** or **Professional1 / 2**. The settings in **True Cinema**, **Custom** or **Professional1 / 2** can be stored for each input.

 → **Watching** > **For best picture** > **Viewing Mode**

1. Select the input mode with **AV** or **TV**.
2. Display the menu with **MENU**.
3. Select **Picture** > **Viewing Mode** and press **OK** to access.
4. Select the mode and press **OK** to set.

Professional Photo / Cinema / True Cinema / Custom / Professional1 / Professional2

■ Adjust the detailed picture settings

1. Display the menu with **MENU**.
2. Select **Picture** > **Advanced Settings** and press **OK** to access.
3. Select one of the following items and press **OK** to access.

Contrast Control / HDR Brightness Enhancer / Colour Gamut / White Balance / Colour Management / Gamma / Reset to Defaults

4. Set the item and press **OK** to store.

■ Contrast Control

Contrast Control

(**Custom / Auto / Off**)

Automatically adjusts the detailed contrast settings. Select **Custom** to set **Contrast Control Setting** manually.

Contrast Control Setting

Adaptive Gamma Control:

Adjusts the gamma curve to make the image brighter.

Black Expander:

Gradually adjusts the shades of black.

Clear White Effect:

Makes the white area clearer.

Reset to Defaults:

Resets items for **Contrast Control Setting**.

■ HDR Brightness Enhancer

HDR Brightness Enhancer

(On / Off)

Enhances the luminance when watching HDR video in a bright environment.

■ Colour Gamut

Colour Gamut

(Native / Rec. 709 / SMPTE-C / EBU / Rec. 2020 / DCI-P3 / Auto / sRGB / Adobe)

Reproduces image colour precisely according to the colour gamut standards.

Native:

Displays deep colours by expanding the colour gamut to its maximum.

Rec. 709:

Standard for HD (High definition)

SMPTE-C:

Standard for NTSC

EBU:

Standard for PAL

Rec. 2020:

Provides the suitable colour gamut for Rec. 2020.

DCI-P3:

Provides the suitable colour gamut for DCI 4K.

Auto:

Automatically adjusts the colour gamut according to the input signal.
(For photo content)

sRGB:

Standard for sRGB (For photo content)

Adobe:

Standard for AdobeRGB (For photo content)

- Set [Colour Remaster](#), [Rec.2020 Colour Remaster](#) and [Reversal Film Effect](#) to [Off](#) to use this function.
- [Auto](#) / [sRGB](#) / [Adobe](#) are available for the photo content.

■ White Balance

[R-Gain / G-Gain / B-Gain](#)

Adjusts the white balance of bright red / green / blue areas.

[R-Cutoff / G-Cutoff / B-Cutoff](#)

Adjusts the white balance of dark red / green / blue areas.

[More Detailed Adjustment](#)

Adjusts more detailed items for [White Balance](#).

[Input Signal Level:](#)

Adjusts the input signal level.

[R-Gain / G-Gain / B-Gain:](#)

Adjusts the detailed white balance of bright red / green / blue areas.

[Reset to Defaults:](#)

Resets items for [More Detailed Adjustment](#).

[Reset to Defaults](#)

Resets [White Balance](#) to the default settings.

■ Colour Management

[R-Hue / R-Saturation / R-Luminance](#)

Adjusts the picture hue / saturation / luminance of red areas.

[G-Hue / G-Saturation / G-Luminance](#)

Adjusts the picture hue / saturation / luminance of green areas.

[B-Hue / B-Saturation / B-Luminance](#)

Adjusts the picture hue / saturation / luminance of blue areas.

[More Detailed Adjustment](#)

Adjusts more detailed items for [Colour Management](#).

[C-Hue / M-Hue / Y-Hue:](#)

Adjusts the picture hue of cyan / magenta / yellow areas.

[C-Saturation / M-Saturation / Y-Saturation:](#)

Adjusts the saturation of cyan / magenta / yellow areas.

[C-Luminance / M-Luminance / Y-Luminance:](#)

Adjusts the luminance of cyan / magenta / yellow areas.

[Reset to Defaults:](#)

Resets items for [More Detailed Adjustment](#).

[Reset to Defaults](#)

Resets [Colour Management](#) to the default settings.

■ Gamma

Gamma

Switches the gamma curve.

- Please note the numerical values are reference for the adjustment.
-

More Detailed Adjustment

Adjusts more detailed items for [Gamma](#).

Input Signal Level:

Adjusts the input signal level.

Gain:

Adjusts the gain of gamma for selected signal level.

Reset to Defaults:

Resets items for [More Detailed Adjustment](#).

Reset to Defaults

Resets [Gamma](#) to the default settings.

■ Reset to Defaults

Reset to Defaults

Resets [Advanced Settings](#) to the default settings.

Option Settings

Some features are not available on all models. Available menu items are displayed on your TV screen.

1. Display the menu with **MENU**.
2. Select **Picture > Option Settings** and press **OK** to access.
3. Select one of the following items and press **OK** to access.

[Game Mode](#) / [Film Cadence Mode](#) / [1080p Pure Direct](#) / [4K Pure Direct](#) / [1080p Pixel by 4pixels](#) / [HDMI Content Type](#) / [HDMI EOTF Type](#) / [EOTF Type](#) / [HDMI Colorimetry Type](#) / [HDMI RGB Range](#) / [HDMI YCbCr Range](#) / [3D-COMB](#)

4. Set the item and press **OK** to store.
-

Game Mode

(On / Off)

Provides suitable images for fast response signals when playing games.

- Not valid in the following conditions:
 - TV mode
 - [1080p Pixel by 4pixels](#) is set to [On](#).
 - [1080p Pure Direct](#) is set to [On](#).
 - [4K Pure Direct](#) is set to [On](#).
 - To display a continuous record of time spent using Game Mode, set [Playing Time Display](#).
-

Film Cadence Mode

(Auto / On / Off)

Improves vertical resolution for movie images.

- This function is available for interlaced signals (except in the mode of multi window, Network services or when [Game Mode](#) is set to [On](#)).
-

1080p Pure Direct

(On / Off)

Reproduces the original image quality in detail for 1080p (HDMI) input signal.

- Not valid in the following conditions:
 - Multi window
 - [1080p Pixel by 4pixels](#) is set to [On](#).
-

4K Pure Direct

(On / Off)

Reproduces the original image quality in detail for 4K (HDMI) input signal.

- Not valid in the following conditions:
 - Multi window
-

1080p Pixel by 4pixels

(On / Off)

Displays like pixel by pixel to make the image sharper for 1080p signal.

- For HDMI
 - Not all image may be displayed as pixel by pixel precisely.
 - Not valid in the following conditions:
 - Multi window
-

HDMI Content Type

(Graphics / Photos / Auto / Off)

Adjusts the picture settings of each HDMI input according to the selected content type.

Auto:

Automatically adjusts the picture settings according to the received HDMI content if the connected equipment supports HDMI Content Type.

- To set the availability of each content type for Auto mode, select [Auto Detail Setting](#).
 - For HDMI
 - Not valid when [Viewing Mode](#) is set to [Professional Photo](#)
-

HDMI EOTF Type

(Auto / Traditional gamma / HLG / PQ)

Selects the EOTF type for each HDMI input. Set to [Auto](#) for general use.

- For HDMI
-

EOTF Type

(Auto / Traditional gamma / HLG / PQ)

Selects the EOTF type of broadcast or video content.

It works correctly only when the signal corresponds the each EOTF type. Set to **Auto** for general use.

- Automatically switches to **Auto** for broadcast each time another input / channel is selected.
 - For digital, video content
-

HDMI Colorimetry Type

(Auto / Rec. 601 / Rec. 709 / Rec. 2020)

Selects the colourimetry type for each HDMI input.

- For HDMI
-

HDMI RGB Range

(Auto / Full / Normal)

Adjusts the black level of the image for each HDMI input.

- When the black level is not suitable, select **Full**.
 - For HDMI
-

HDMI YCbCr Range

(Full / Normal)

Adjusts the black level of the image in the YCbCr signal for each HDMI input.

- For HDMI
-

3D-COMB

(On / Off)

Makes still or slow moving pictures more vivid.

- Occasionally, while viewing still or slow moving pictures, colour patterning may be seen. Set to **On** to display sharper and more accurate colours.
- For PAL / NTSC signal reception in TV mode or from composite connection

Screen Settings

1. Display the menu with **MENU**.
 2. Select **Picture > Screen Settings** and press **OK** to access.
 3. Select one of the following items and press **OK** to access.
[16:9 Overscan](#) / [Zoom Adjustments](#) / [Screen Display](#) / [Pixel Orbiter](#) / [Panel Maintenance](#) / [Panel Maintenance Message](#)
 4. Set the item and press **OK** to store.
-

16:9 Overscan

(On / Off)

Selects the screen area displaying the image for 16:9 aspect.

On:

Enlarges the image to hide the edge of the image.

Off:

Displays the image in the original size.

- Set to **On** if noise occurs on the edge of the screen.
 - This function can be memorised for SD (Standard definition) and HD (High definition) signals respectively.
 - Not valid in the following conditions:
 - 4K content
 - Photo content
 - **Game Mode** is set to **On**.
 - **1080p Pixel by 4pixels** is set to **On**.
 - **1080p Pure Direct** is set to **On**.
 - **4K Pure Direct** is set to **On**.
 - Multi window
-

Zoom Adjustments

Adjusts the vertical position and size when aspect is set to **Zoom**.

- Not valid in the following conditions:
 - 4K content
 - Multi window
-

Screen Display

(On / Off)

Turns the screen off when you select **Off**.

- This function is effective in reducing power consumption when listening to the sound without watching the TV screen.
 - Press any buttons (except Standby On / Off switch) to turn the screen on.
-

Pixel Orbiter

(On / Off)

Sets the pixel shifting of the image to prevent panel “image retention”.

Panel Maintenance

Turns the screen off and perform the maintenance to prevent the panel “image retention”.

- It takes approx. 80 minutes to finish the maintenance.
 - LED turns to orange during adjustment of the panel.
 - To cancel the maintenance, turn the TV on while the maintenance is in progress.
 - A white horizontal line appears on the screen for a while to adjust the panel. This is not a malfunction.
 - Completion message will be displayed when turning the TV on after panel maintenance.
-

Panel Maintenance Message

(On / Off)

Enables to display the regular panel maintenance notification.

On:

The message automatically displays for maintenance when the TV is turned off with Standby On / Off switch of the TV’s remote control after watching for a certain period of time.

Off:

The message does not display. Select **Panel Maintenance** and perform the panel maintenance manually. (see above)

Lock Settings

Locks the settings of [Professional1](#) / [2](#) for each input.

- Select [Professional1](#) / [Professional2](#) in Viewing Mode in advance.

 → [Watching](#) > [For best picture](#) > [Viewing Mode](#)

1. Display the menu with **MENU**.
2. Select [Picture](#) > [Lock Settings](#) and press **OK** to access.
3. Enter the PIN number (4 digits) with **Numeric buttons**.



- Enter the PIN number twice at first setting.
 - Make a note of the PIN number in case you forget it.
4. Select [Adjustment Lock](#) and press **OK** to access.
 5. Select [On](#) and press **OK** to set.

- The following items can be locked.

[Luminance Level](#) / [Contrast](#) / [Brightness](#) / [Colour](#) / [Tint](#) / [Sharpness](#) / [Colour Temperature](#) / [Vivid Colour](#) / [Resolution Remaster](#) / [Dynamic Range Remaster](#) / [Advanced Settings](#) / [Reset to Defaults](#)

■ To change the PIN number

1. Select [Change PIN](#) and press **OK** to access.
2. Enter a new PIN number twice with **Numeric buttons**.



Copy Adjustment

Copies the picture settings of [True Cinema](#), [Custom](#), [Professional1](#) or [Professional2](#) to those of the other input mode or Viewing Mode.

1. Display the menu with **MENU**.
2. Select [Picture](#) > [Copy Adjustment](#) > [Destination Viewing Mode](#) / [Destination Input](#) and press **OK** to access.
3. Select the destination to copy to and press **OK** to set.
4. Select [Copy Start](#) and press **OK** to copy.
5. When a confirmation screen is displayed, select [Yes](#) and press **OK** to set.

= Note =

- [Option Settings](#) and [Screen Settings](#) are not copied.
- You cannot copy to the locked mode.

For best audio

Sound mode

1. Display the menu with **MENU**.
 2. Select **Sound** > **Mode** and press **OK** to access.
 3. Select the mode and press **OK** to set.
-

Mode

(**Standard** / **Music** / **Ambience** / **User**)

Selects your favourite sound mode for each input.

Standard:

Provides the suitable sound quality for all types of scenes.

Music:

Improves sound quality for watching music videos, etc.

Ambience:

Improves spatial effects and provides clear sounds.

User:

Adjusts the sounds manually using the equaliser to suit your favourite sound quality.

- The following items can be adjusted and stored for each mode.

Bass / **Treble** / **Surround** / **Bass Boost**

- For the User mode, **Equaliser** is available in the Sound Menu instead of **Bass** and **Treble**. Select **Equaliser** and adjust the frequency.

 → **Watching** > **For best audio** > **Basic settings**

- This function is effective only for the sound from TV speakers.

Basic settings

1. Display the menu with **MENU**.
 2. Select **Sound** and press **OK** to access.
 3. Select one of the following items and press **OK** to access.
Bass / Treble / Equaliser / Balance / Surround / Bass Boost
 4. Set the item and press **OK** to store.
-

Bass

Adjusts level to enhance or minimise lower, deeper sound output.

Treble

Adjusts level to enhance or minimise sharper, higher sound output.

Equaliser

Adjusts the frequency level to suit your favourite sound quality.

- This function is available when **Mode** is set to **User**.
 - Select the frequency and adjust the frequency level.
 - To enhance the bass sound, raise the level of the lower frequency. To enhance the treble sound, raise the level of the higher frequency.
 - To reset the levels of each frequency to the default settings, select **Reset to Defaults** and press **OK**.
 - This function is effective only for the sound from TV speakers.
-

Balance

Adjusts volume level of right and left speakers.

Surround

(**Virtual Surround+** / **Virtual Surround** / **Off**)

Selects surround sound settings.

Virtual Surround+:

Provides a more progressive enhancer and reverberation to simulate improved spatial effects.

Virtual Surround:

Provides a dynamic enhancer of width and depth to simulate improved spatial effects.

- This function is effective only for the sound from TV speakers.

Bass Boost

(On / Off)

Enhances the effect of bass sounds.

- This function is effective only for the sound from TV speakers.

Volume settings

1. Display the menu with **MENU**.
2. Select **Sound** and press **OK** to access.
3. Select one of the following items and press **OK** to access.

[Speaker Selection](#) / [TV Speaker Setting](#) / [Headphone Volume](#) / [Auto Gain Control](#) / [Volume Correction](#) / [Clear Sound Adjustment](#)

4. Set the item and press **OK** to store.
-

Speaker Selection

([TV](#) / [Home Cinema](#))

Enables controlling the theatre speaker with this TV's remote control by pointing at the TV's signal receiver.

TV:

TV speakers are active.

Home Cinema:

The sound is delivered from theatre speakers. Player theatre, Blu-ray Disc theatre or Amplifier will be automatically turned on if it is in Standby mode.

- The sound of TV speakers is mute. When the equipment is turned off, TV speakers will be activated.
- You can use **Volume Up / Down** and **MUTE**.



- This function is available when the theatre speakers supporting VIERA Link function is connected to this TV.
-

TV Speaker Setting

([TV Speaker](#) / [Headphone](#) / [Off](#))

Selects the sound output to adjust volume.

- Sound from TV speaker turns off when [Headphone](#) or [Off](#) is selected.
-

Headphone Volume

Adjusts the volume of headphones.

Auto Gain Control

(On / Off)

Automatically regulates large sound level differences between channels and inputs.

Volume Correction

Adjusts the volume of each individual channel or input mode.

Clear Sound Adjustment

(On / Off)

If the sound from TV speakers is unclear due to installation environment, **On** is recommended.

- This function is effective only for the sound from TV speakers.

Voice Guidance Settings

1. Display the menu with **MENU**.
 2. Select **Sound** > **Voice Guidance Settings** and press **OK** to access.
 3. Select one of the following items and press **OK** to access.
Voice Guidance / **Speed** / **Volume** / **User Level** / **Web Browser**
 4. Set the item and press **OK** to store.
-

Voice Guidance

(On / Off)

Set to **On** to enable voice guidance of the basic features (on-screen messages, etc.) for visually impaired users.

- Not valid in multi window mode
-

Speed

(Fast / Normal / Slow)

Selects the readout speed for the voice guidance.

Volume

(Max / Mid / Min)

Selects the volume for the voice guidance.

User Level

(Beginner / Expert)

Selects the level of verbosity for the voice guidance.

Web Browser

(On / Off)

Set to **On** to enable voice guidance of the network content in web browser function.

= Note =

- Voice guidance function may not correspond exactly.

Audio Description

1. Display the menu with **MENU**.
 2. Select **Sound** > **Audio Description** and press **OK** to access.
 3. Select one of the following items and press **OK** to access.
Preferred Audio Type / **Volume** / **Speakers** / **Headphones**
 4. Set the item and press **OK** to store.
 - For DVB
-

Preferred Audio Type

(**Audio Description** / **Standard**)

Narration settings for visually impaired users

Set to **Audio Description** to activate the narration sound track when available on the broadcast.

- The availability of audio description sound track is indicated by **AD** in the information banner.
 - Not valid in multi window mode
-

Volume

Adjusts the volume for Audio Description.

Speakers

(**Mix** / **Standard**)

Set to **Mix** to activate the description sound track from TV speakers.

Headphones

(**Mix** / **Standard**)

Set to **Mix** to activate the description sound track from headphones.

Advanced settings

1. Display the menu with **MENU**.
 2. Select **Sound** and press **OK** to access.
 3. Select one of the following items and press **OK** to access.
NICAM / Audio Preference / SPDIF Selection / HDMI Audio Format / PCM Optical Level / SPDIF Delay / HDMI Input
 4. Set the item and press **OK** to store.
-

NICAM

(On / Off)

Near Instantaneous Companded Audio Multiplex

Reproduces NICAM stereo sound.

- Set to **Off** if reception is poor. (FM monaural sound)
 - For Analogue
-

Audio Preference

(Multichannel / Stereo / MPEG)

Selects the initial setting for audio tracks.

Multichannel:

The priority is given to multi-channel audio track.

Stereo:

The priority is given to stereo (2ch) audio track.

MPEG:

The priority is given to MPEG.

- MPEG is an audio compression method that compresses audio to the smaller size without any considerable loss of audio quality.
 - For digital
 - Ireland only
-

SPDIF Selection

(Auto / PCM)

Selects the initial setting for digital audio output signal from DIGITAL AUDIO and HDMI2 (ARC function) terminals.

- SPDIF is a standard audio transfer file format.

Auto:

Dolby Audio (Dolby Digital, Dolby Digital Plus) and HE-AAC multi-channel are output as Dolby Digital Bitstream. MPEG is output as PCM.

PCM:

Digital output signal is fixed to PCM.

- ARC (Audio Return Channel) is a function of digital audio output using HDMI cable.
- For digital, video content

 → [Media Player > Playback > Audio output settings](#)

 → [Network > Videos > Audio output settings](#)

HDMI Audio Format

(Auto / Bitstream / PCM)

Selects the audio format for the HDMI input signal.

Auto:

When the TV speakers are active, audio format is fixed to PCM. When the sound is delivered from theatre speakers, audio format is fixed to Bitstream.

Bitstream:

Dolby Audio (Dolby Digital, Dolby Digital Plus) is output as Dolby Audio Bitstream. Other digital audio output signals are output as PCM.

PCM:

Digital audio signal is output as PCM.

PCM Optical Level

Adjusts the audio level of PCM output from DIGITAL AUDIO and HDMI2 (ARC function) terminals to equalise with that of the other audio types.

SPDIF Delay

Adjusts the delay time of the sound output from DIGITAL AUDIO and HDMI2 (ARC function) terminals if the sound does not synchronise the image.

- For digital
 - Ireland only
-

HDMI Input

(Digital / Analogue)

Selects to fit the input signal.

 → [Watching > External equipment > HDMI features](#)

Digital:

When sound is carried via the HDMI cable connection

Analogue:

When sound is not carried via the HDMI-DVI adaptor cable connection

- For HDMI

TV Guide

Freeview Play EPG (UK)

Using the Freeview Play EPG enables you to select a programme easily, view programme information, etc.

- For DVB (UK only)
- A broadband network environment is required to fully use this function. Ensure the network connections and network settings are completed.





 → Network > Network connections

 → Network > Network settings

1. Select **DVB** with **TV**.
2. Display **TV Guide** with **GUIDE**.
(Example)



- 1 TV screen
- 2 Date and time
- 3 Programme
- 4 Channel position and name

- To watch the programme
 - 1) Select a programme and press **OK** to access.
 - 2) Select **Watch now** and press **OK** to watch.
 - To use **Timer Programming**, select **Record**.
 → **Watching > TV Guide > Timer Programming**
 - If a programme exists in both HD and SD broadcasts, **Watch in HD** can be selected.
- To display the schedule information
 (red)
- To jump to the currently selected channel
 (green)
- To access to the Catch-Up menu (if available)
 (yellow)
- To search programme (if available)
 (blue)
- To view more details of the programme
 - 1) Select the programme.
 - 2) Press **i** to view.
 - Press again to return to **TV Guide**.
- To exit **TV Guide**
EXIT

= Note =

- In Other Sat., the channel list will appear when pressing **GUIDE**.
- Be sure to update the software when a software update notice is displayed on the TV screen. If the software is not updated, you may not be able to use the Freeview Play EPG. You can update the software later manually.
 → **Network > Network settings > Software Update**
- When this TV is turned on for the first time, or the TV is switched off for more than a week, it may take some time before TV Guide is completely shown.
- The features may vary depending on the broadcaster.

TV Guide

TV Guide - Electronic Programme Guide (EPG) provides an on-screen listing of the programmes currently broadcast and the forthcoming broadcasts over the next seven days (depending on the broadcaster).

For DVB (Ireland only), Freesat (UK only)

1. Select the mode with **TV**.

DVB / Freesat

2. Display **TV Guide** with **GUIDE**.

(Example)

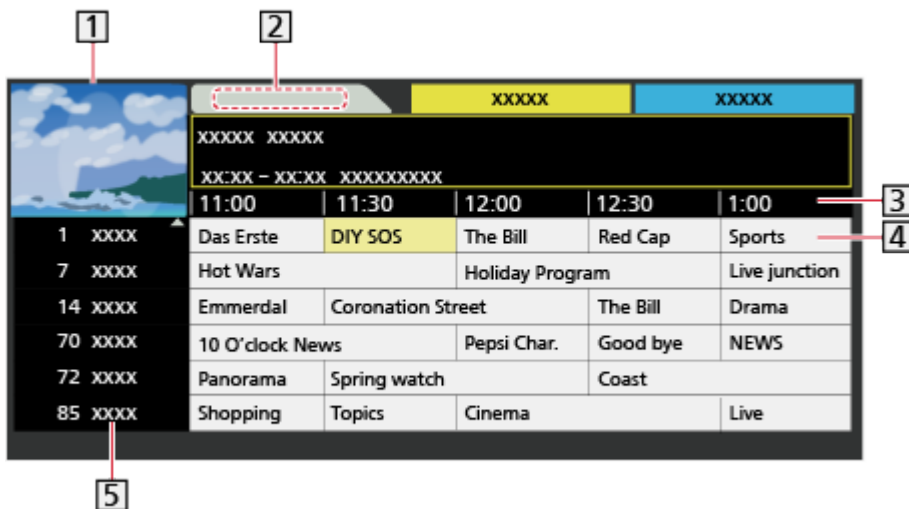

1 TV screen (DVB)

2 Date

3 Time

4 Programme

5 Channel position and name

- To watch the programme

- 1) Select the current programme and press **OK** to access.

- The current programme is displayed on the top left of the screen.

- 2) Select **View** and press **OK** to watch.

- To use **Timer Programming**

→ **Watching > TV Guide > Timer Programming**

- To the previous day





(red)

- To the next day

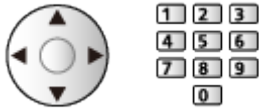
(green)

- To search programme titles and view a list of the searched programmes (if available)
 - 1) Display the search list with  (yellow).
 - 2) Select [Search](#) and press **OK** to access.
 - 3) Enter characters with **Cursor buttons** or **Numeric buttons**, and press **OK** to set.



- 4) Press  (green) to start searching.
 - All the programme titles including the word you set are listed.
 - Searching without any characters lists all programmes including current programmes.
- To view a channel list of the selected category
 - 1) Display the category list with  (blue).
 - 2) Select the category and press **OK** to view.
 - To list favourite channels, set [Favourites Editor](#).
-  → [Watching > Tuning and editing channels > Favourites Editor](#)
- To view more details of the programme
 - 1) Select the programme.
 - 2) Press  to view.
 - Press again to return to [TV Guide](#).
 - To exit [TV Guide](#)



EXIT

= Note =



- When this TV is turned on for the first time, or the TV is switched off for more than a week, it may take some time before TV Guide is completely shown.
- In Satellite, the channel list will appear when pressing **GUIDE**.

Timer Programming

This function allows you to select programmes that you want to record to the USB HDD.

1. Display [TV Guide](#) with **GUIDE**.
2. Select the forthcoming programme and press **OK** to access.
3. Select [Record](#) and press **OK** to set. (UK only)
 - You can also set a timer event pressing .
 - To check / change / cancel a timer event
 → [Recording > Timer Programming > Editing Timer Programming](#)
 - LED turns to orange in Standby mode when [Timer Programming](#) is set.
 - To return to [TV Guide](#)
BACK/RETURN
 - If you select the current programme, a confirmation screen asking whether you want to watch or record the programme appears. Select [Timer Programming](#) and press **OK** to set [USB HDD Rec.](#) to record from the time you finish the timer event setting. (Ireland only)
 -  is displayed on the TV Guide screen if [Timer Programming](#) is set from [TV Guide](#). (UK only)

= Note =

- Not valid in Analogue
- [Timer Programming](#) only works reliably if correct time information is received via the signal from the broadcaster or service provider.
- When recording programmes to the USB HDD, be sure to format the USB HDD and enable it to record in [USB Device Setup](#).
 → [Recording > USB HDD setup](#)
- To set timer programming events of this TV on the network equipment (smartphone, etc.) from outside the home network
 → [Recording > Timer Programming > Remote recording](#)

Guide link programming

Guide link programming is [Timer Programming](#) which is controlled by information from the TV Guide; if programme start and end times are changed by the broadcaster, the timer event will follow the change.

- UK only
-  is displayed on the timer event if the timer is set from the TV Guide. (Guide link programming)
- Not valid in Analogue

= Note =

- If you edit the start time or end time of a Guide link programming event by more than 10 minutes, it will no longer follow the broadcaster's changes to the start or end time. The start and end times will become fixed.

Teletext

Digital text service

Digital text services (MHEG) differ greatly from analogue teletext.

When you switch to a digital text service, the images you see can contain graphics and text, laid out and controlled in a manner decided by the broadcaster.

1. Select [Freesat](#) (UK only) / [DVB](#) with **TV**.
 - DVB programmes may have digital text services (MHEG).
2. Switch to a digital text service with **TEXT**.

■ How to operate services

In all cases, it is possible to navigate the pages using buttons on the remote control, but because the commands available must apply to all manufacturers of digital equipment, some on-screen commands may not correspond exactly to the remote control buttons.



- To exit a digital text service

TEXT

= Note =

- As soon as you switch to a digital channel with links to a digital text service, software is downloaded in the background over air to enable the teletext function. This means that when switching to a digital channel, you should wait for approx. 5 seconds before pressing **TEXT** - this allows the software to be downloaded. If you press **TEXT** before download is complete, it will be ignored and you will have to press **TEXT** again when the download is complete.

Viewing Teletext

1. Switch to teletext with **TEXT**.
 - Displays the index page (content varies depending on the broadcaster).
 - Current / sub page numbers are displayed on the top left of the screen.
 - Time / date is displayed on the top right of the screen.
 - Colour bar is displayed on the bottom of the screen.
2. Select the page with **Cursor buttons**, **Numeric buttons** or   (coloured buttons).

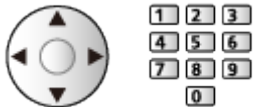



- To adjust contrast
 - 1) Press **MENU** twice to display **Contrast**.
 - 2) Adjust and press **OK** to set.
- To exit teletext
EXIT

■ Reveal hidden data

1. Press **MENU**.
2. Reveal with  (red).
 - Press again to hide.

■ To view a favourite page stored

Press **STTL** to view a favourite page.

- Call up the page stored on  (blue). (List mode)
- Factory setting is "P888" (subtitle service) on  (blue). (List mode)





■ FULL / TOP / BOTTOM





1. Press **MENU**.
2. Press  (green) to change the layout.

■ Watch TV and teletext in two windows at once

1. Press **TEXT** to view in multi window.
 - Operations can be made only in teletext screen.
2. Press **TEXT** repeatedly to return to TV or teletext.

■ Store frequently viewed pages in the colour bar (List mode)

1. Press     (coloured buttons) while the page is displayed.
2. Press and hold **OK**.





- The stored page number changes to white.
- If you use subtitles, do not change number on  (blue).
- To change stored pages
 - 1) Press     (coloured buttons) to change.
 - 2) Enter a new page number with **Numeric buttons**.



- 3) Press and hold **OK**.

■ View sub page

The number of sub pages is displayed on the top of the screen. Press ◀ / ▶ to view sub page. (Only when teletext has more than one page.)

- The number of sub pages varies depending on the broadcaster (up to 79 pages).
- Searching may take time while you are watching TV.
- To view a specific sub page
 - 1) Press **MENU**.
 - 2) Press  (blue).
 - 3) Enter the 4-digit number (e.g. P6, press    ).

Teletext mode

Teletext services are the text information provided by the broadcaster.

- The features may vary depending on the broadcaster.
 - The availability of teletext services for a programme is indicated by **TEXT** in the information banner. (Ireland only)
1. Display the menu with **MENU**.
 2. Select **Setup > Display Settings > Teletext** and press **OK** to access.
 3. Select **FASTEXT / List** and press **OK** to set.

■ FASTEXT mode

In FASTEXT mode, four differently coloured subjects are situated on the bottom of the screen.

To access more information about one of these subjects, press the appropriate coloured button.

This facility enables fast access to information on the subjects shown.

■ List mode

In List mode, four differently coloured page numbers are situated on the bottom of the screen. Each of these numbers can be changed and stored in the TV's memory.

 → **Watching > Teletext > Viewing Teletext**

Teletext Character Set

Selects teletext language font.

1. Display the menu with **MENU**.
 2. Select [Setup](#) > [Display Settings](#) > [Teletext Character Set](#) and press **OK** to access.
 3. Select the font and press **OK** to set.
-

West:

English, French, German, Greek, Italian, Spanish, Swedish, Turkish, etc.

East1:

Czech, English, Estonian, Lettish, Rumanian, Russian, Ukrainian, etc.

East2:

Czech, Hungarian, Lettish, Polish, Rumanian, etc.

- Ireland only

Tuning and editing channels

Setting menu

You can retune channels, edit channel lists, create your favourite channel lists, etc.

1. Select the mode with **TV**.
[Freesat \(UK only\)](#) / [DVB](#) / [Analogue](#) / [Other Sat. \(UK only\)](#) / [Satellite \(Ireland only\)](#)
2. Display the menu with **MENU**.
3. Select [Setup](#) > [Tuning Menu](#) and press **OK** to access.
[Freesat Tuning Menu](#) / [DVB Tuning Menu](#) / [Analogue Tuning Menu](#) / [Other Sat. Tuning Menu](#) / [Satellite Tuning Menu](#)
 - The menu name varies depending on the TV mode.
4. Select one of the functions and press **OK** to access.
[Channel List Editor](#) / [Favourites Editor](#) / [Regional Channel Edit](#) / [Auto Setup](#) / [Channel Sorting by Region](#) / [Manual Tuning](#) / [Update Channel List](#) / [New Channel Message](#) / [Signal Condition](#) / [Add New Channels](#) / [Add TV Signal](#)
 - The function items vary depending on the TV mode and country you select.

Channel List Editor

■ Skip unwanted Freesat / DVB / Analogue channels

You can hide (skip) unwanted channels. The hidden channels cannot be displayed except in this function.

1. Select **Channel List Editor** and press **OK** to access.
2. Select a channel.
3. Press **OK** to set **Reveal / Hide** (skip).

: **Reveal**

: **Hide** (skip)

- To reveal all channels (if available)

 (yellow)

■ Edit DVB / Analogue Channels

- To swap the channel position number (logical channel number)

1) Press  (green) to edit.

2) Enter the new position number with **Numeric buttons**, and press  (green) to store.



- To retune each channel (**Manual Tuning**)

 (red)

- Only for the revealed channels

- To rename the channel name (Analogue)

1) Press  (blue) to edit.

2) Enter characters (maximum 5 characters) with **Cursor buttons** or **Numeric buttons**, and press **OK** to set.

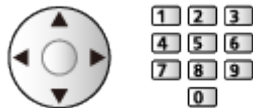

3) Press **BACK/RETURN** to store.

= Note =

- If a VCR is connected only with the RF cable in Analogue, edit **VCR**.

■ Create the channel list for Other Sat. / Satellite

Create your channel list of Other Sat. / Satellite for viewing from all the found channels to exclude the duplicated channels or to reduce the number of channels. And then you can select your desired channels easily.

1. Select a channel to list from [Channels Found](#).

- To change the category

 (red)

2. Press **OK** to add it to [Channels for Viewing](#).

- To add consecutive channels to the list at once

1) Press  (yellow).

2) Make the channel block and press **OK** to add.

- To delete the selected channel from the list of [Channels Found](#)

 (green)

- To exclude the selected channel from the list of [Channels for Viewing](#)

OK

- To move the selected channel in the list of [Channels for Viewing](#)

1) Press  (green).

2) Select the new position with **Cursor buttons** or select the turn with **Numeric buttons**.

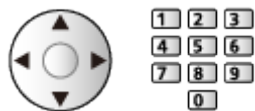

3) Press  (green) to store.



Favourites Editor

■ List favourite Freesat channels

Create your favourite channel list from various broadcasters.

The Freesat favourites list is available for switching in the information banner and the TV Guide screen

 → Watching > TV Guide > TV Guide

1. Select **Favourites Editor** and press **OK** to access.
2. Select a channel to list from all Freesat channels.
 -  appears when the channel is encrypted.
 - To add all channels to the list, press  (yellow).
 - To delete a channel
 - 1) Select the channel.
 - 2) Press **OK** to delete.
 - Press  (yellow) to delete all channels

■ List favourite Other Sat. / Satellite channels

Create your favourite channel lists from various broadcasters (up to 4: **Favourites 1 to 4**).

The Other Sat. / Satellite favourites lists are available for switching in the information banner.

 → Watching > Basic > Information banner





■ List favourite DVB channels

Create your favourite channel lists from various broadcasters (up to 4: [Favourites 1 to 4](#)).

The favourites lists are available for switching in the information banner and the TV Guide screen. (Ireland only)

 → Watching > Basic > Information banner

 → Watching > TV Guide > TV Guide



1. Select [Favourites Editor](#) and press **OK** to access.
2. Select a channel to list from all DVB channels.
 -  appears when the channel is encrypted.
 - To display other favourites
 -  (green)
3. Press **OK** to add it to favourites list.
 - To add all channels to the list (if available)
 - 1) Press  (yellow).
 - 2) Press  (green) to add all.
4. Press **BACK/RETURN** and **OK** to store.

■ Edit DVB favourites list

You can edit the favourites list while the cursor is on the channel in the favourites list.

- To move the channel
 - 1) Select the channel.
 - 2) Press  (green).
 - 3) Select the new position with **Cursor buttons** or select the turn with **Numeric buttons**.



- 4) Press  (green) to store.
- To delete the channel
 - 1) Select the channel.
 - 2) Press **OK** to delete.
 - Press  (yellow) to delete all channels.
 - To name the favourites
 - 1) Press  (red).
 - 2) Enter characters (maximum 10 characters) with **Cursor buttons** or **Numeric buttons**, and press **OK** to set.

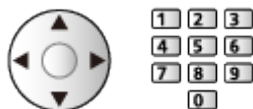

- 3) Press **BACK/RETURN** to store.

= Note =

- Channel position numbers (known as logical channel numbers) can be swapped in [Channel List](#).
 -  → [Watching > Tuning and editing channels > Channel List Editor](#)
- The hidden channels cannot be displayed in the favourite list (Live TV).

Regional Channel Edit

You can replace some regional channels with the available channels from another region channel (if available).

1. Select a channel to replace from [Freesat Regional Channels](#).
2. Select a channel to be replaced from [Alternative Regional Channels](#).

Auto Setup

Automatically retunes the channels received in the area.

- This function is available if channel tuning is already performed.
- Only the selected mode is retuned. All the previous tuning settings are erased.
- Child Lock PIN number is required to retune locked channels.

 → [Functions > Child Lock > PIN number](#)

- If tuning has not been done completely, set [Manual Tuning](#).

 → [Watching > Tuning and editing channels > Manual Tuning](#)

- For DVB, Analogue, Other Sat., Satellite

■ Freesat

- To use dual tuner function, set [Dual Tuner Mode](#) to [On](#).

1. Select [Auto Setup](#) and press **OK** to access.
2. A confirmation screen is displayed and press **OK** to start [Auto Setup](#).
(Settings are made automatically.)
3. Enter your postcode with **Cursor buttons** or **Numeric buttons**, and press **OK** to set.



- When the operation is completed, the channel at the lowest position will be displayed.

■ DVB, Analogue

1. Select [Auto Setup](#) and press **OK** to access.
2. A confirmation screen is displayed and press **OK** to start [Auto Setup](#).
(Settings are made automatically.)
 - When the operation is completed, the channel at the lowest position will be displayed.

■ Other Sat. / Satellite

- To use dual tuner function, set [Dual Tuner Mode](#) to [On](#).
1. Select [Auto Setup](#) and press **OK** to access.
 2. Select the satellite.
 - Select [IN 1 / IN 2](#) in [Signal Input](#) to set for each tuner.
 - Selectable satellites are [Astra2/Eurobird](#), [Astra1](#) and [Hotbird](#).
 - Check the dish alignment for the satellite to select.
 - The Freesat channel uses Astra2 at 28.2° East and Eurobird1 at 28.5° East satellites. To ensure your satellite dish is correctly installed, consult your Freesat registered dealer. (UK only)
 - For information about [Astra1](#) and [Hotbird](#), consult the received satellite broadcasting companies.
 - If you want to tune from all available satellites, select [Any Satellite](#).
 3. Select [Start](#) and press **OK** to access.
 4. The signal condition is displayed and press **OK** to access.
 - If you select [Any Satellite](#), this step is skipped.
 - It takes a while to check the connection for your selected satellite.
 - Ensure that the [Signal Lock](#) status is shown as [Locked](#). If it is not locked, the search cannot be executed.
 - If the status is shown as [Not locked](#) and [Signal Quality / Signal Strength](#) have no indications, please check the dish alignment. If the status is shown as [Not locked](#) but there are some levels of [Signal Quality / Signal Strength](#) indicated, select [Any Satellite](#) in step 2 and try again.
 5. A confirmation screen is displayed and press **OK** to access.
 6. Select a search mode and press **OK** to start [Auto Setup](#). (Settings are made automatically.)
 - If you select [Astra2/Eurobird](#) or [Any Satellite](#), Freesat channels will also be searched.
 - When the operation is completed, the channel at the lowest position will be displayed.

■ Auto Setup using the buttons on the TV

1. Press and hold INPUT/OK/HOLD for MENU button for 3 seconds to display the menu.
2. Set **Auto Setup** with following control panel buttons.
 - Move the cursor / select from a range of options / select the menu item



- Access the menu / store settings after adjustments have been made or options have been set with INPUT/OK/HOLD for MENU button

Channel Sorting by Region

You can sort DVB channels so that those with the best signal quality, or those for your preferred region, appear nearer the top of your channel list. (UK only)

1. Select the region and press **OK** to access.
2. Select repeatedly until you reach the available region.
 - Normally, you should select [Best signal quality \(All Regions\)](#).
 - If you choose to select your preferred region, you could find channels with a weaker signal appear nearer the top of your channel list. If you have any image or sound problems, select [Best signal quality \(All Regions\)](#) instead.

Manual Tuning

- Normally use [Auto Setup](#) or [Update Channel List](#) to retune DVB channels.
- If tuning has not been done completely or for adjusting the direction of the aerial or dish, use this function. (DVB)
- All DVB channels found are added to [Channel List Editor](#).

■ DVB (UK only)

1. Select [Frequency](#).
2. Press **OK** to search.
 - All channels found are added to [Channel List](#).

■ DVB (Ireland only)

1. Select a channel and adjust frequency for each channel.
 - Set where the level of [Signal Quality](#) becomes the maximum.
2. Press **OK** to search.

■ Analogue

Set Analogue channel manually after [Auto Setup](#).

1. Select the channel position with **Numeric buttons**.



2. Select the channel with **Channel Up / Down**.



3. Set [Manual Tuning](#).
4. Select [Store](#) and press **OK** to set.
 - Use [Fine Tuning](#) to make small adjustments to the tuning of an individual programme (affected by weather conditions, etc.).
 - Ireland only
 - If a VCR is connected only with the RF cable, select channel position **0**.

■ Other Sat. / Satellite

Set tuning parameters for the required satellite, details can usually be found in a satellite TV magazine.

- Normally use [Auto Setup](#) or [Add New Channels](#) to retune Other Sat. / Satellite channels.
- Please consult the received satellite broadcasting companies for the setting.

Update Channel List

By updating the DVB channel list, you can add new channels, delete removed channels or change channel names and positions automatically.

- The channel list is updated while keeping your settings in [Channel List Editor](#), [Favourites Editor](#), [Child Lock](#), etc.
- Depending on the signal condition, the update may not work properly.

Signal Condition

Selects a channel and checks the signal condition with indicators.

- A good Signal Strength is not an indication of suitable signal reception.
- Vertical lines show the maximum signal value of the selected channel.
- To change the channel



- Not valid in Analogue

Add New Channels

You can add any new channels found automatically to channel list.

1. The signal condition is displayed and press **OK** to access.
 - If you select [Any Satellite](#) in [Auto Setup](#), this step is skipped.
 - It takes a while to check the connection for your selected satellite.
 - Ensure that the [Signal Lock](#) status is shown as [Locked](#). If it is not locked, the search cannot be executed.
 - If the status is shown as [Not locked](#) and [Signal Quality](#) / [Signal Strength](#) have no indications, please check the dish alignment.
2. Select a search mode and press **OK** to start [Add New Channels](#).
 - New channels can only be added to the existing channel list from the same satellite.

Other settings

New Channel Message

Selects whether to give a notification message when a new DVB channel is found or not.

- When a notification message appears, you can perform [Update Channel List](#) pressing **OK**.
-

Add TV Signal

Adds the TV mode.

- Allows you to add any TV mode which was skipped during initial [Auto Setup](#).

Recording

USB HDD setup

Preparations

You can record the digital TV programmes to the connected USB HDD and enjoy playing back in various ways.

- Prepare the USB HDD for the exclusive use of recording with this TV.
- Depending on the model, it may be necessary to remove the terminal cover / cable cover before connecting or disconnecting cables.
- Connect the USB HDD to the USB 1 port with the USB cable.
- Be sure to connect the USB HDD to the mains socket.
- To remove the USB HDD safely from the TV, perform [Safely remove USB](#) in [USB Device Setup](#).

 → [Recording > USB HDD setup > Setting for USB HDD](#)

- Check the terminal type and cable plugs are correct for connection.



- 1 USB port
- 2 USB cable
- 3 USB HDD
- 4 Mains socket

= Caution =

- All data in the USB HDD will be erased in the following cases:
 - When formatting the USB HDD with this TV
 -  → [Recording > USB HDD setup > Setting for USB HDD](#)
 - When formatting the USB HDD to use on PC, etc.
- When the TV is repaired due to a malfunction, you may have to format the USB HDD again with this TV to use it. (All data will be erased after formatting.)

- To use the USB HDD with your PC after recording with this TV, format it again on your PC. (Special operations or tools may be necessary to format on your PC. For details, read the manual of the USB HDD.)
- The data recorded on the USB HDD with this TV can only be played back on this TV. You cannot play back its content with another TV (including the TV of the same model number) or any equipment.
- Do not turn the TV off, pull out the mains plug or remove the USB HDD during operation (formatting, recording, etc.). Doing so may cause malfunction of the device or damage the recorded data. (An electric outage may also be a cause of malfunction.)

= Note =

- Analogue TV programme cannot be recorded on the USB HDD.
- The data broadcasting (MHEG, etc.), radio broadcasting are not recorded, and also the recording function does not work during the period without any signal.
- Not all the programmes can be recorded depending on the broadcaster and service provider.
- You cannot copy the recorded TV programmes of the USB HDD.
- The recorded content may not be played back properly depending on the progress of recording.
- For details of the USB HDD



→ [Recording > Technical information > USB HDD](#)

Setting for USB HDD

Format and set up the USB HDD with this TV in order to use it for recording.

All the USB devices recognised as a mass storage device are listed.

- Please note that USB HDD will be formatted and all data in it will be erased after this setup.
- Before setting, connect the USB HDD and be sure to turn on the USB HDD.

 → Recording > USB HDD setup > Preparations

1. Display the menu with **MENU**.
2. Select **Setup** > **USB Device Setup** and press **OK** to access.
3. Select the USB HDD for recording and press **OK** to start setup.
 - Some USB HDD may not be displayed.
 - To display information of the highlighted device
4. When the caution and confirmation screen for using USB HDD is displayed, select **Yes** and press **OK** to proceed.
5. When a confirmation screen of USB HDD name is displayed, select **Yes** and press **OK** to set.







- The name for the USB HDD is created automatically. If you want to edit the name, select **Yes**.

- 1) Enter characters with **Cursor buttons** or **Numeric buttons**, and press **OK** to set.



- 2) Press **BACK/RETURN** to store.

6. When a confirmation screen to enable USB HDD for recording is displayed, select **Yes** and press **OK** to set.
 - If another formatted USB HDD for recording already exists, this confirmation screen will be displayed to switch to enable this USB HDD for recording.

- Mode of the USB HDD
 -  : The USB HDD is available for recording / playing back.
Only one USB HDD on the list is available for recording.
 -  : The USB HDD is available for playing back.
- To change the mode

- To edit USB HDD name
 (green)
- To format
 (red)
- To remove the USB HDD safely from the TV
 (yellow)

= Note =

- You can only select one USB HDD for recording at a time.
- You cannot change the settings for the USB HDD while recording is in progress.
- Ensure that [Dual Tuner Mode](#) is set to [On](#) in [Tuning Menu](#) to record 2 programmes simultaneously in Freesat or Other Sat. / Satellite.

Recording current programme

One Touch Recording

Records the current programme to the USB HDD immediately.

- Confirm the remote control code is “73”.

 → Watching > External equipment > Operating with TV's remote control

1. Display the menu with **MENU**.
2. Select **Setup** > **Recording Setup** > **One Touch Recording** and press **OK** to access.
3. Select the maximum recording time **30 / 60 / 90 / 120 / 180 (minutes)** and press **OK** to set.

■ To start One Touch Recording

Press  to start.

■ To stop recording in progress

Press  to stop.

■ To play back or delete the recorded content

Recorded TV programmes can be played back in Media Player.

1. Display Home Screen with **HOME**.
2. Select **Devices** and press **OK** to access.
3. Select USB HDD for recording and press **OK** to access.

 → Media Player > Recorded TV mode

- Even if **One Touch Recording** is in progress, you can play back all the content. (Depending on the USB HDD, playback may not be possible or the recording may not work properly during playback.)

Rewind LIVE TV

Records the current programme to the USB HDD constantly within the maximum recordable time.

- Confirm the remote control code is “73”.

 → Watching > External equipment > Operating with TV's remote control

1. Display the menu with **MENU**.
2. Select **Setup** > **Recording Setup** > **Rewind LIVE TV** and press **OK** to access.
3. Select **Auto** to start **Rewind LIVE TV**.
 - When you select **Auto**, recording will start automatically.
 - This recording may not start if another recording is in progress, TV signal condition is bad or there are no images displayed.

■ To operate Rewind LIVE TV

- To pause



- To search backward (up to 90 minutes)



- After pausing or searching backward, the following buttons are available for operation.

◀ : Search backward

▶ : Search forward

▽ : Return to the current programme

OK : Playback / Pause

◀▶ : Search backward / Search forward

⏸ : Pause / Resume

■ To stop Rewind LIVE TV

1. Display the menu with **MENU**.
2. Select **Setup** > **Recording Setup** > **Rewind LIVE TV** and press **OK** to access.
3. Select **Off** to stop **Rewind LIVE TV**.
 - If you stop **Rewind LIVE TV**, the recorded content for **Rewind LIVE TV** will be deleted.
 - **Rewind LIVE TV** is stopped and the recorded content is deleted automatically in the following conditions: (Even if **Rewind LIVE TV** stops for the following conditions, as long as the setting is **Auto**, a new recording starts automatically in a condition that makes the recording available.)
 - Other channels selected
 - Locked channel selected
 - Invalid channel selected
 - No TV signal
 - External input selected
 - When the full-screen application (TV Guide, Media Player, eHELP, etc.) is launched
 - When the TV enters Standby or is turned off

Timer Programming

Setting Timer Programming

This function allows you to select programmes that you want to record to the USB HDD.

- Not valid in Analogue

1. Select the mode with **TV**.

[Freesat](#) (UK only)/ [DVB](#) / [Other Sat.](#) (UK only)/ [Satellite](#) (Ireland only)

2. Display the menu with **MENU**.

3. Select [Timer](#) > [Timer Programming](#) and press **OK** to access.

4. Press **OK** to start making the settings.

[USB HDD Rec.:](#)

Records the programme to the USB HDD.

5. Select and set the item (channel, date, start time, end time).

- **4** and **7** can also be entered with **Numeric buttons**.



(Example)

1	2	3	4	5	6	7
			1 ZDF		-- / --	--:-- --:-- (-- xxx)
					-- / --	--:-- --:-- (-- xxx)
					-- / --	--:-- --:-- (-- xxx)

1 !: Overlapped timer events

2 Function ([USB HDD Rec.](#))

3 TV mode

- For UK

: DVB

: Other Sat.

- For Ireland

: DVB

: Satellite

– You cannot change the mode within the menu.

4 Channel position, channel name, etc.

5 : Signal Supported Recording (if available)

→ [Watching > TV Guide > Timer Programming](#)

6 Date

- [Daily Sun-Sat](#): Sunday to Saturday
- [Daily Mon-Sat](#): Monday to Saturday
- [Daily Mon-Fri](#): Monday to Friday
- [Weekly Sun / Mon / Tue / Wed / Thu / Fri / Sat](#): Same time on the same day every week

7 Start time / End time / Duration (automatic display)

6. Store with .



■ Guide link programming

: Guide link programming - Programmes according to the TV Guide signal

→ [Watching > TV Guide > Guide link programming](#)

- UK only
- Guide link programming is [Timer Programming](#) which is controlled by information from the TV Guide; if programme start and end times are changed by the broadcaster, the timer event will follow the change.

Editing Timer Programming

1. Display the menu with **MENU**.
2. Select **Timer > Timer Programming** and press **OK** to access.
3. Select the event.
 - To change a timer event
OK
 - Correct as necessary.
 → **Recording > Timer Programming > Setting Timer Programming**
 - To delete a timer event
 - 1) Press  (red).
 - 2) Press **OK** to delete.

■ To stop recording

1. Press .
2. Select the programme and press **OK** to access (when 2 recordings are in progress).
3. Select **Yes** and press **OK** to stop.

■ To play back or delete the recorded content

Recorded TV programmes can be played back in Media Player.

1. Display Home Screen with **HOME**.
2. Select **Devices** and press **OK** to access.
3. Select USB HDD for recording and press **OK** to access.

 → **Media Player > Recorded TV mode**

- The recorded content may not be played back properly depending on the progress of recording.

Remote recording

You can set timer programming with the network equipment (smartphone, etc.) from outside the home network using TV Anywhere function.

- Ensure the network connections and network settings are completed.

 → [Network > Network connections](#)

 → [Network > Network settings](#)

- Set [TV Anywhere](#) to [On](#) to use this function.

 → [Functions > TV Anywhere](#)

- To use TV Anywhere function, you need to install the application for controlling VIERA on your smartphone.



 → [Support > FAQs > Detailed information](#)

For the operations, refer to the support information of the application.

= Note =

- This function is not available when the TV is turned off with Mains Power On / Off switch.
- Due to network conditions or certain broadcaster restrictions, this function may not be available.

Note

- [TV Guide](#) may also be used to set timer event.
 → [Watching > TV Guide > Timer Programming](#)
- [Timer Programming](#) can store up to 15 events.
- [Timer Programming](#) only works reliably if correct time information is received via the signal from the broadcaster or service provider.
- For recording using [Timer Programming](#), the TV must be either on or in Standby.
- Depending on the progress of recording, analogue channel may not be selected.
- Recording an encrypted (copy-protected) programme may not be possible.
- When the start time comes, the channel may be switched automatically and the video and audio signals may be output. 2 minutes before the start time, a reminder message may appear if you are watching TV.
 - To remove the message and start the programming, press **OK**.
 - To cancel the programming, press **EXIT**.
- LED turns to orange in Standby mode when [Timer Programming](#) is set.
- “!” identifies that three or more timer events are overlapped. As for the overlapped recording events, the first event starts and finishes as programmed. The next event can then start.
- The recording of [Timer Programming](#) may automatically change the channel to the programmed channel a few seconds before the start time.
- For details of the USB HDD
 → [Recording > Technical information](#)

Technical information

USB HDD

■ USB HDD

(for recording the digital TV programmes with this TV)

- The capacity of USB HDD that works with this TV is from 160 GB to 6 TB.
- Connect the USB HDD to the mains socket to record and play back properly with this TV.
- Use the USB HDD formatted with this TV.
 → [Recording > USB HDD setup > Setting for USB HDD](#)
- Regarding performance, not all USB HDDs are guaranteed.

= Note =

- Data modified with a PC may not be displayed.
- Do not remove the device while the TV is accessing data. Otherwise this can damage the device or TV.
- Do not touch the pins on the device.
- Do not subject the device to a high pressure or impact.
- Insert the device in the correct direction. Otherwise this can damage the device or TV.
- Electrical interference, static electricity, or erroneous operation may damage the data or device.

Media Player

Using Media Player

Information

Media Player allows you to enjoy photo, video or music recorded on the SD Card / USB Flash Memory / USB HDD / network device, and content recorded with this TV to the formatted USB HDD.

(Example)

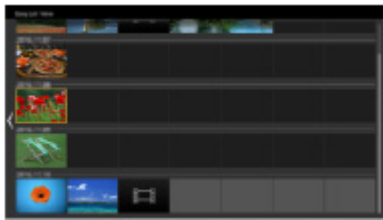

Easy List View:

Still pictures / moving pictures recorded with digital camera or digital video camera are played back.

Mix Folder View:

All files grouped by folder are displayed.

Recorded TV mode:

(For exclusive USB HDD) TV programmes recorded on the USB HDD with this TV are played back.

- During the operation, audio signal is output from DIGITAL AUDIO and HDMI2 (ARC function) terminals. But no video signals are output. To use HDMI2 with ARC function, connect an amplifier that has ARC function and set to use theatre speakers.

 → [Functions > VIERA Link "HDAVI Control™"](#)

- Pictures may not appear correctly on this TV depending on the recording equipment used.
- Displaying may take some time when there are many files and folders.
- Partially degraded files may be displayed with reduced resolution.
- Picture setting may not work depending on the condition.
- Folder and file names may be different from those on the digital camera or digital video camera used.

■ To insert or remove the SD Card

- Depending on the model, it may be necessary to remove the terminal cover / cable cover before inserting or removing the SD Card.

Gently insert the SD Card with the label surface facing front. Push the centre of the card until a click is heard. (To remove, push it again.)

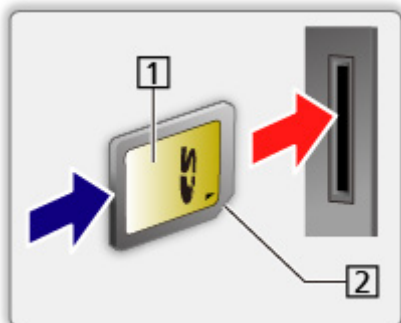

1 Label surface

2 Cutout

■ To insert or remove the USB Flash Memory

- Depending on the model, it may be necessary to remove the terminal cover / cable cover before inserting or removing the USB Flash Memory.

Ensure alignment is straight and complete when inserting or removing.



- To remove the USB Flash Memory safely from the TV, perform [Safely remove USB](#) in [USB Device Setup](#).
 - 1) Display the menu with **MENU**.
 - 2) Select [Setup](#) > [USB Device Setup](#) and press **OK** to access.
 - 3) Select the device and press **YELLOW** (yellow) to set.

= Note =

- To connect the USB HDD

 → Recording > USB HDD setup

- Check the terminal type and devices are correct for connection.



- For details of the devices

 → Media Player > Connected device

- For details of supported file formats

 → Media Player > Supported format

Selecting device / mode

1. Insert the SD Card or USB Flash Memory to the TV.
 - When you insert the SD Card, Media Player will start automatically.
 → [Media Player > Using Media Player > Information](#)
 - To play back content in the USB HDD, ensure the connection and settings are completed.
 → [Recording > USB HDD setup](#)
 - To play back content in the network device, ensure the connection and settings are completed.
 → [Media Player > Using Media Player > Network device](#)
2. Display Home Screen with **HOME**.
3. Select [Devices](#) and press **OK** to access.
4. Select the device (SD Card / USB Flash Memory / USB HDD / network device) and press **OK** to access.
 - When a confirmation screen about the network device is displayed, enter [User](#) / [Password](#) to access.
5. Select [Easy List View](#) / [Mix Folder View](#) / [Recorded TV](#) and press **OK** to access.

Easy List View

 → [Media Player > Easy List View](#)

Mix Folder View

 → [Media Player > Mix Folder View](#)

Recorded TV

 → [Media Player > Recorded TV mode](#)

6. The thumbnail view is displayed.

(Example)

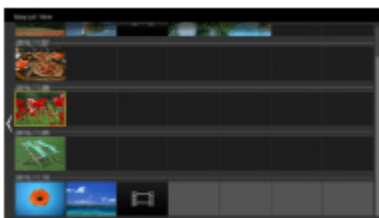

- To display / hide information of the highlighted content



= Note =

- **Recorded TV** is available for content recorded on the USB HDD with this TV.
- Select the appropriate device and content for playing back each file.
- You can use the following buttons during playback. Confirm the remote control code is “73”.



 → [Watching > External equipment > Operating with TV's remote control](#)

Network device

You can enjoy photo, video or music stored in the network devices.

- To enable this function, connect this TV to your home network.

 → Network > Network connections

 → Network > Network settings

■ How to set User / Password

1. Display the menu with **MENU**.
2. Select **Network** > **File Sharing Settings** > **Network Device List** and press **OK** to access.
3. Select the network device and press **OK** to access.
4. Enter **User** / **Password** with **Cursor buttons** or **Numeric buttons**, and press **OK** to set.



- Press **BACK/RETURN** to store.
 - To register the new network device, set **Server Name** / **Shared Folder**.
For details, read the manual of the equipment.
5. Select **Register** and press **OK** to set.
 - To delete the registered device, select **Delete** and press **OK** to set.

= Note =

- Regarding performance, not all servers are guaranteed.
- Up to 48 devices can be registered.

Sharing file

You can share the files between PC and devices connected to this TV.

- To enable this function, connect this TV to your home network.

 → Network > Network connections

 → Network > Network settings

1. Display the menu with **MENU**.
2. Select **Network** > **File Sharing Settings** > **File Sharing Server** and press **OK** to access.
3. Select **On** and press **OK** to set.
4. Operate your PC to share the files.
 - This function is not available when the TV is turned off with Mains Power On / Off switch. You can share the files in Standby mode when **DLNA Server** is set to **On**.

= Note =

- Regarding performance, not all PCs are guaranteed.
- Do not turn the TV off, pull out the mains plug or remove the device during operation (reading, copying, etc.). Doing so may cause malfunction of the device or damage the recorded data.
- All data in the USB HDD will be erased when you format the USB HDD with this TV for recording.
- To connect the USB HDD

 → Recording > USB HDD setup

- Picture noise may occur on the screen when playback starts during operation (reading, copying, etc.).
- For details of the devices

 → Media Player > Connected device

Easy List View

Selecting file

Still pictures / moving pictures recorded with digital camera or digital video camera are played back.

Select the file in the thumbnail view and press **OK** to start playback.

- If a file or folder is edited or renamed by digital camera, digital video camera, PC, etc., the thumbnail may not be displayed properly.

 : Error display

- To sort by month
 - 1) Display the option menu with **OPTION**.
 - 2) Select **Calendar** and press **OK** to access.
- The preview will start when the title / scene is highlighted in the thumbnail view if it supports a preview. To turn off the preview, set **Video Preview** to **Off**.
 - 1) Display the option menu with **OPTION**.
 - 2) Select  and press **OK** to access.
 - 3) Select **Video Setup** > **Video Preview** and press **OK** to access.
 - 4) Select **On / Off** and press **OK** to set.
 - Images may not be displayed for an instant in the thumbnail view. Set the preview **Off** to solve this.
 - This function is available in the thumbnail view.
- For details of supported file formats

 ⇒ **Media Player > Supported format**
- To play back the file

 ⇒ **Media Player > Playback > Playback**

■ Settings

1. Display the option menu with **OPTION**.
 2. Select  and press **OK** to access.
 3. Select one of the following items and press **OK** to access.
[Play Select](#) / [Repeat](#) / [Shuffle](#)
 4. Set the item and press **OK** to store.
-

[Play Select](#)

Settings for playback file selection

[Repeat](#)

([Folder](#) / [File Repeat](#) / [Off](#))

Playback repeat

[Folder](#):

Playback repeat within the selected folder

[File Repeat](#):

Playback repeat of the selected one file

[Shuffle](#)

([On](#) / [Off](#))

Files are played back at random.

Filtering files

You can filter the files as the content type. (Photo / Video)

1. Display the option menu with **OPTION**.
 2. Select **Filter** and press **OK** to access.
 3. Select **Photo / Video** and press **OK** to set.
 4. Select **OK** and press **OK** to change.
- To select the music file

 → [Media Player > Mix Folder View > Filtering files](#)



Mix Folder View

Selecting file

Displays the thumbnail of all files which are grouped by folder.

Select the folder / file and press **OK** to start playback.

 : Error display

- The preview will start when the title / scene is highlighted in the thumbnail view if it supports a preview. To turn off the preview, set [Video Preview](#) to [Off](#).
 - 1) Display the option menu with **OPTION**.
 - 2) Select  and press **OK** to access.
 - 3) Select [Video Setup](#) > [Video Preview](#) and press **OK** to access.
 - 4) Select [On](#) / [Off](#) and press **OK** to set.
 - Images may not be displayed for an instant in the thumbnail view. Set the preview [Off](#) to solve this.
 - This function is available in the thumbnail view.
- For details of supported file formats
 → [Media Player > Supported format](#)
- To play back the file
 → [Media Player > Playback > Playback](#)

■ Settings

1. Display the option menu with **OPTION**.
2. Select  and press **OK** to access.
3. Select one of the following items and press **OK** to access.

[Play Select](#) / [Repeat](#) / [Shuffle](#)

4. Set the item and press **OK** to store.
-

[Play Select](#)

Settings for playback file selection

[Repeat](#)

([Folder](#) / [File Repeat](#) / [Off](#))

Playback repeat

[Folder](#):

Playback repeat within the selected folder

[File Repeat](#):

Playback repeat of the selected one file

[Shuffle](#)

([On](#) / [Off](#))

Files are played back at random.

Filtering files

You can filter the files as the content type. (Photo / Video / Music)

1. Display the option menu with **OPTION**.
2. Select **Filter** and press **OK** to access.
3. Select **Photo / Video / Music** and press **OK** to set.
4. Select **OK** and press **OK** to change.

Sorting files

You can sort the files in alphabetical / date order.

1. Display the option menu with **OPTION**.
2. Select **Sort** and press **OK** to access.
3. Select **Alphabet(A...Z)** / **Alphabet(Z...A)** / **Date(1...9)** / **Date(9...1)** and press **OK** to change.

Playback

Playback

■ Photo playback



To the previous photo



To the next photo



Stop



Switch the playback mode (Single view / Slideshow).



Rotate



Display / hide the operation guide.



Return to thumbnail.

■ Video / Music playback



Rewind



Fast forward



Stop



Pause (displays the time seek bar) / Playback

- To jump to the specified time point
 - 1) Display the time seek bar with **OK**.
 - 2) While the time seek bar is displayed

Press ◀ / ▶:

Search approx. 10 seconds

Press and hold ◀ / ▶:

Search rapidly

- 3) Jump to the specified time point with **OK**.

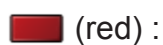

To the previous title / scene / track



To the next title / scene / track



Display / hide the operation guide.



Return to thumbnail.

= Note =

- To set [Repeat](#) / [Shuffle](#) for playback

→ [Media Player > Easy List View > Selecting file](#)

→ [Media Player > Mix Folder View > Selecting file](#)

Slideshow Settings

Set up the settings for Photo mode.

1. Display the option menu with **OPTION**.
 2. Select **Slideshow Settings** with **OK**.
 3. Select one of the following items and press **OK** to access.
Aspect / Interval / Back Ground Music
 4. Set the item and press **OK** to store.
-

Aspect

(**Original / Zoom**)

Selects enlarged or normal viewing.

- Depending on the photo size, the photo may not be fully enlarged to fill the screen (e.g. portrait style picture).
-

Interval

(**Long / Normal / Short**)

Selects slideshow interval.

Back Ground Music

(**Off / Type1 / Type2 / Type3 / Type4 / Type5 / User / Auto**)

Selects the background music during Photo mode.

Type1 - 5:

Music files installed on this TV at the factory settings are played back.

Auto:

Music files stored in the current device are played back.

- If there is no available music data, no sound is played back.

User:

Music files in the device registered by yourself are played back.

- If no music files have been registered or the device which had registered music files is removed, no sound is played back.

- To register music

- 1) Select the music file and press **OK** to access.

- Depending on the condition of the device, select folders until you reach the desired music file.

- 2) Select **File / Folder** and press **OK** to set.

File:

The selected music file is registered.

Folder:

All the music files in the folder which contains the selected music file are registered.

= Note =

- Picture quality may be degraded depending on the slideshow setting.
- Picture setting may not work depending on the slideshow setting.

Video Setup

Set up the settings for Video mode.

1. Display the option menu with **OPTION**.
 2. Select **Video Setup** with **OK**.
 3. Select one of the following items and press **OK** to access.
Multi Audio / Dual Mono Audio / Subtitle Settings
 - Menu items and selectable options vary depending on the content.
 4. Set the item and press **OK** to store.
-

Multi Audio, Dual Mono Audio

Selects for selectable sound tracks (if available).

- It may take several seconds to change the sound.
 - This function is available during playback.
-

Subtitle Settings

Sets the subtitle setting.

- This function is available during playback.

Subtitle:

Display / hide subtitles (if available).

Subtitle Text:

Selects the font type to display subtitles correctly (if available).

Subtitle Text Size:

Selects the font size of subtitles.

Subtitle Text Colour:

Selects the colour of subtitles.

Subtitle Text Position:

Adjusts the position of subtitles on the screen.

Subtitle Text Delay:

Adjusts the delay time for the subtitles.

Audio output settings

You can enjoy the multi-channel sound via an amplifier connected to DIGITAL AUDIO or HDMI2 (ARC function) terminal.

- To confirm or change the current sound status

 → Media Player > Playback > Video Setup

1. Display the menu with **MENU**.
 2. Select **Sound** > **SPDIF Selection** and press **OK** to access.
 3. Select **Auto** / **PCM** and press **OK** to set.
-

SPDIF Selection

(Auto / PCM)

Selects the initial setting for digital audio output signal from DIGITAL AUDIO and HDMI2 (ARC function) terminals.

- SPDIF is a standard audio transfer file format.

Auto:

Dolby Audio (Dolby Digital, Dolby Digital Plus) and HE-AAC multi-channel are output as Dolby Digital Bitstream. MPEG is output as PCM.

PCM:

Digital output signal is fixed to PCM.

- ARC (Audio Return Channel) is a function of digital audio output using HDMI cable.

Recorded TV mode

Selecting content

- For exclusive USB HDD
- To play back content in the USB HDD, ensure the connection and settings are completed.

 → Recording > USB HDD setup





1. Content list of the selected device is displayed in Recorded TV mode.
 - Remaining capacity of the selected device is displayed on the top right. (This value may not be accurate depending on the condition.)
 - Content list is displayed as **All** or **Not Viewed**.

All:

All the recorded TV programmes are listed.

Not Viewed:

Content not played back yet are listed.

- Icons are displayed.
 -  : Content not played back yet (Once you play back the content, this icon will disappear.)
 -  : Protected content cannot be deleted.
 -  : Currently recording (You can play back this recording content.)
 -  : Group of content

2. Select the content and press **OK** to start playback.

- If you have stopped the last playback halfway, a confirmation screen may be displayed to select whether to start from where you stopped last time or from the beginning.
- If the content has multiple programmes with different parental ratings, the highest restriction is applied to the content. Once you unlock the restriction, all the programmes in the content can be played back.
 - Ireland only
- For details of supported file formats

 → Media Player > Supported format > Video format

Watching recorded TV

■ Playback

- To operate playback

 : Manual skip

- Press to skip forward approx. 30 seconds.
- Press and hold to skip backward approx. 15 seconds.

 : Rewind

 : Fast forward

 : Stop

 : Pause (displays the time seek bar) / Playback



- To jump to the specified time point

1) Display the time seek bar with .

2) While the time seek bar is displayed

Press  /  :

Search approx. 10 seconds

Press and hold  /  :

Search rapidly

3) Jump to the specified time point with .

- To display / hide the operation guide and information banner



- To repeat between the starting point “A” and finishing point “B”

 (blue)

(Set “A” and “B” in order.)

- The points are reset by pressing again or by other operations.

- To the previous / next chapter

 (red) /  (green)

- A recorded content is automatically divided into chapters (approx. 5 minutes for each).

- To change aspect



 → Watching > For best picture > Aspect

- To display the subtitle (if available)



- To confirm or change the current status (if available)

 → [Watching](#) > [Basic](#) > [AV Options](#)

- To return to list

BACK/RETURN

= Note =

- The recorded content may not be played back properly depending on the progress of recording.

Grouping content

1. Select the content to edit and press  (blue) to tick in the content list.
2. Display the option menu with **OPTION**.
3. Select [Create Group](#) / [Release Group](#) / [Exclude from Group](#) / [Change Protect Status](#) and press **OK** to set.

[Create Group](#):

Create a group of content. Select and tick all the desired content, and then select [Create Group](#).

[Release Group](#):

Select the created group to release, and then select [Release Group](#). (To release several groups at once, tick all the desired groups.)



[Exclude from Group](#):

Select the group and press **OK** to display the grouped content. To exclude specific content from the group, tick it and then select [Exclude from Group](#). (To exclude some of the content at once, tick all the desired content.)

[Change Protect Status](#):



Select the content to protect from deletion, and then select [Change Protect Status](#). Perform the same way to cancel the protection. (To change the status of some of the content at once, tick all the desired content.)

Deleting content

1. Select the content to edit and press  (blue) to tick in the content list.
2. Delete the content with  (red).
3. When a confirmation screen is displayed, select **Yes** and press **OK** to set.

Chapter List

You can start playback from the chapter list you select.

1. Display the chapter list with  (yellow).
2. Select the chapter and press  to start playback.

= Note =

- The chapter list is not displayed while the selected content is being recorded.
- Depending on the recorded programmes, some playback operations may not work properly.

Audio output settings

You can enjoy the multi-channel sound via an amplifier connected to DIGITAL AUDIO or HDMI2 (ARC function) terminal.

- To confirm or change the current sound status

 → Media Player > Playback > Video Setup

1. Display the menu with **MENU**.
 2. Select **Sound** > **SPDIF Selection** and press **OK** to access.
 3. Select **Auto** / **PCM** and press **OK** to set.
-

SPDIF Selection

(Auto / PCM)

Selects the initial setting for digital audio output signal from DIGITAL AUDIO and HDMI2 (ARC function) terminals.

- SPDIF is a standard audio transfer file format.

Auto:

Dolby Audio (Dolby Digital, Dolby Digital Plus) and HE-AAC multi-channel are output as Dolby Digital Bitstream. MPEG is output as PCM.

PCM:

Digital output signal is fixed to PCM.

- ARC (Audio Return Channel) is a function of digital audio output using HDMI cable.

Connected device

Device handling caution

- Data modified with a PC may not be displayed.
- Do not remove the device while the TV is accessing data. Otherwise this can damage the device or TV.
- Do not touch the pins on the device.
- Do not subject the device to a high pressure or impact.
- Insert the device in the correct direction. Otherwise this can damage the device or TV.
- Electrical interference, static electricity, or erroneous operation may damage the data or device.
- Back up the recorded data at regular intervals to prevent data deterioration, data damage or erratic operation of the TV. Panasonic is not liable for any deterioration or damage of recorded data.

SD Card

■ SD Card

Use an SD Card which meets SD standards. Failure to do so may cause the TV to malfunction.

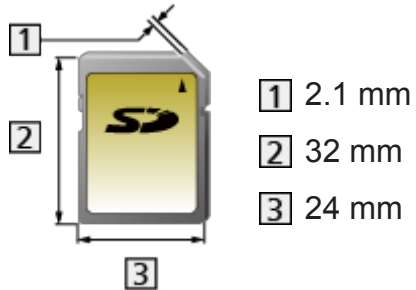

Card format:

SDXC Card - exFAT

SDHC Card / SD Card - FAT16 or FAT32

Compliant card type (maximum capacity):

SDXC Card (64 GB), SDHC Card (32 GB), microSDHC Card (32 GB), SD Card (2 GB), miniSD Card (2 GB), microSD Card (2 GB)

(requiring microSDHC Card / miniSD Card / microSD Card adaptor)

- If a microSDHC Card, miniSD Card or microSD Card is used, insert / remove it together with the adaptor.

USB devices

- It is recommended to connect the device to the TV's USB port directly.
- Some USB devices or USB HUB may not be used with this TV.
- You cannot connect any devices using a USB card reader.

■ USB Flash Memory

USB Flash Memory format:

FAT16, FAT32 or exFAT

- USB HDDs formatted on a PC are not guaranteed to work in Media Player.

■ USB HDD

- The capacity of USB HDD that works with this TV is from 160 GB to 6 TB.
- Connect the USB HDD to the mains socket to record and play back properly with this TV.
- Use the USB HDD formatted with this TV.

 → [Recording > USB HDD setup > Setting for USB HDD](#)

- Regarding performance, not all USB HDDs are guaranteed.

Supported format

Photo format

■ Supported Photo formats

- JPEG (.jpg, .jpeg)

Sub-sampling:

4:4:4, 4:2:2, 4:2:0

Image resolution (pixel):

8 × 8 to 30 719 × 17 279

- DCF and EXIF standards
 - Progressive JPEG is not supported.
-

= Note =

- Some files may not be played back even if they fulfil these conditions.
- Some files may not be played back correctly depending on the resolution, etc.
- Do not use multi-byte characters or other special codes for file names.
- Connected devices may become unusable with this TV if the file or folder names are changed.

Video format

■ Supported Video formats

- AVCHD (.mts)

Video codec:

H.264

Audio codec:

Dolby Audio (Dolby Digital)

- AVCHD Standard Ver. 2.0 (AVCHD Progressive)
 - The data may not be available if a folder structure on the device is modified.
-

- AVI (.avi)

Video codec:

H.264, MPEG1, MPEG2, MPEG4, VC-1, WMV9

Audio codec:

AAC, ADPCM, Dolby Audio (Dolby Digital, Dolby Digital Plus), HE-AAC, LPCM, MP3, WMA, WMA Pro

- MP4 (.f4v, .m4v, .mp4)

Video codec:

H.264, H.265 (HEVC), MPEG1, MPEG2, MPEG4

Audio codec:

AAC, Dolby Audio (Dolby Digital, Dolby Digital Plus), HE-AAC, MP3

- This TV supports this container recorded with Panasonic products. For details, read the manual of the products.
-

- MKV (.mkv)

Video codec:

H.264, H.265 (HEVC), MPEG1, MPEG2, MPEG4

Audio codec:

AAC, Dolby Audio (Dolby Digital, Dolby Digital Plus), HE-AAC, MP3, Vorbis

- ASF (.asf, .wmv)

Video codec:

MPEG4, VC-1, WMV9

Audio codec:

AAC, Dolby Audio (Dolby Digital, Dolby Digital Plus), HE-AAC, LPCM, MP3, WMA, WMA Pro

- Copy-protected files cannot be played back.
-

- FLV (.flv)

Video codec:

H.264

Audio codec:

AAC, MP3

- 3GPP (.3gp, .3g2)

Video codec:

H.264, MPEG4

Audio codec:

AAC, HE-AAC

- PS (.mod, .mpg, .mpeg, .vob, .vro)

Video codec:

H.264, MPEG1, MPEG2, VC-1

Audio codec:

AAC, Dolby Audio (Dolby Digital, Dolby Digital Plus), HE-AAC, LPCM, MP3

- TS (.mts, .m2ts, .tp, .trp, .ts, .tts)

Video codec:

H.264, H.265 (HEVC), MPEG1, MPEG2, VC-1

Audio codec:

AAC, Dolby Audio (Dolby Digital, Dolby Digital Plus), HE-AAC, MP3

- WebM (.webm)

Video codec:

VP9

Audio codec:

Vorbis

■ Supported Subtitles formats

- MicroDVD, SubRip, TMLPlayer (.srt, .sub, .txt)

- The video file and subtitles text file are inside the same folder, and the file names are the same except for the file extensions.
 - If there are more than one subtitles text files inside the same folder, they are displayed in the following order of priority: “.srt”, “.sub”, “.txt”.
-

= Note =

- Some files may not be played back even if they fulfil these conditions.
- Some files may not be played back correctly depending on the resolution, frame rate condition, etc.
- Some subtitles or chapter functions may not be available.
- Do not use multi-byte characters or other special codes for file names.
- Connected devices may become unusable with this TV if the file or folder names are changed.
- Supported formats are different in Media Player and media server.

Music format

■ Supported Music formats

- MP3 (.mp3)
-

- AAC / Apple Lossless (.m4a)
 - Copy-protected files cannot be played back.
-

- FLAC (.flac)
-

- WMA / WMA Pro (.wma)
 - Copy-protected files cannot be played back.
-

- LPCM (.wav)
-

= Note =

- Some files may not be played back even if they fulfil these conditions.
- Do not use multi-byte characters or other special codes for file names.
- Connected devices may become unusable with this TV if the file or folder names are changed.

Network

Internet content

Information

You can access some specific websites supported by Panasonic, and enjoy internet content such as videos, games, communication tools, etc. from [Apps](#).

(Example)



- A broadband network environment is required to use this function. Ensure the network connections and network settings are completed.

 → [Network > Network connections](#)

 → [Network > Network settings](#)

Selecting internet content

1. Display **Apps** with **APPS**.

- For details of **Apps**

 → Home Screen > Apps

- Depending on the usage conditions, it may take a while to read all the data.

2. Select the desired item and press **OK** to access.

(Example)



- To exit **Apps**

EXIT

- You may operate the internet content with the free cursor and Voice Control function of Touch Pad Controller (supplied).

 → Functions > Voice Control

- You can connect a keyboard for character input in the applications. You can also use the keyboard for TV operation.

 → Functions > Bluetooth devices

 → Functions > Keyboard

Note

- If you cannot access the internet content, check the network connections and settings.

 → Network > Network connections

 → Network > Network settings

- Design and specifications are subject to change without notice.
- Not all the features of the websites are available.
- Be sure to update the software when a software update notice is displayed on the TV screen. If the software is not updated, you may not be able to use [Apps](#). You can update the software later manually.

 → Network > Network settings > Software Update

- The services through [Apps](#) are operated by their respective service providers and such service may be discontinued either temporarily or permanently without notice. Therefore, Panasonic will make no warranty for the content or the continuity of the services.
- Content may not be available depending on the country you select.
- Content may be presented in specific languages.
- Depending on the connection environment, the internet connection may be slow or may not be successful.

DLNA

In-House streaming

This TV is a DLNA Certified™ product.

DLNA® (Digital Living Network Alliance) is a standard that makes DLNA Certified digital electronics easier and more convenient to use on a home network. To learn more, visit www.dlna.org.

- To enable this function, connect this TV to your home network.

 → [Network > Network connections](#)

 → [Network > Network settings](#)

■ Playback of sharing content stored in the media server

Store photo, video or music content into the DLNA Certified media server connected to your home network. And then you can enjoy the content on this TV.

(Example)

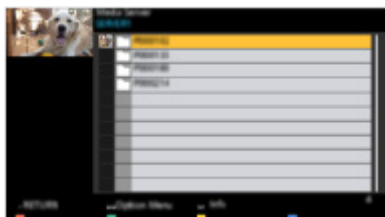

- For details of watching and operating content on this TV

 → [Network > DLNA > Using DLNA](#)

- For details of supported file formats

 → [Network > Supported format](#)

■ Playback of sharing content on this TV with the DMC (Digital Media Controller) network equipment

You can enjoy content stored in the media server by controlling with the DMC network equipment connected to your home network.

- To use this function with your smartphone or PC, set [TV Remote App Settings](#) of this TV.

 → [Network > Network settings > TV Remote App Settings](#)

And you need to install the application for controlling VIERA on your smartphone.

 → [Support > FAQs > Detailed information](#)

For the operations, refer to the support information of the application.

■ Sharing the content of this TV with another piece of network equipment

You can enjoy the content of this TV with another network equipment connected to your home network.

Available content:

- Photo, video or music content of this TV
- Current digital TV programme
- TV programmes recorded on USB HDDs with this TV

Available network equipment:

- DLNA Certified VIERA
- Smartphone, etc.
- To use this function with your smartphone, you need to install the application for controlling VIERA on your smartphone.

 → [Support > FAQs > Detailed information](#)

For the operations, refer to the support information of the application.

- To use this function with another DLNA Certified VIERA, set [Network Link Settings](#) of this TV.

 → [Network > Network settings > Network Link Settings](#)

- Sharing the current programme may not be available when selecting radio channels, encrypted (copy-protected) programmes or when the broadcast prohibits the output of video and audio.
- Display the TV full-screen for sharing the TV programme with another piece of network equipment.
- Only 1 piece of other equipment can share the content of this TV.

= Note =

- This function is not available when the TV is turned off with Mains Power On / Off switch.
- This function may not be available in the following condition of this TV:
 - While the recording is in progress
- Selecting the channel or TV mode on your smartphone may not be available while the recording is in progress.

Using DLNA

To use DLNA® features, ensure the preparations of the media server, network connections and network settings are completed.

 → Network > DLNA > In-House streaming

 → Network > Network connections

 → Network > Network settings

1. Display Home Screen with **HOME**.
2. Select **Devices** and press **OK** to access.
3. Select the media server and press **OK** to access.
 - To display / hide information of the highlighted media server
 - 1) Display the option menu with **OPTION**.
 - 2) Select **Show Info.** and press **OK** to access.
4. Select the file and press **OK** to access.

(Example)



- Depending on the condition of media server, you may need to select the folder before selecting the file.
- To display / hide information of the highlighted file



= Note =

- Non-playable files are also listed but cannot be selected.
- You can use the following buttons during playback. Confirm the remote control code is “73”.



 → Watching > External equipment > Operating with TV's remote control

Network connections

Internet connection

A broadband network environment is required to use internet services.

- Depending on the model, it may be necessary to remove the terminal cover / cable cover before connecting or disconnecting the LAN cable.
- If you do not have any broadband network services, please consult your retailer for assistance.
- Dial-up internet connections cannot be used.
- Required speed (effective): at least 1.5 Mbps for SD (Standard Definition) and 6 Mbps for HD (High Definition) picture quality, respectively. If the transfer speed is not enough, content may not be played back properly.

■ Wireless connection



1 Built-in wireless LAN (Rear of the TV)

2 Access point

3 Internet environment

■ Wired connection



1 ETHERNET terminal

2 LAN cable (Shielded)

- Use Shielded Twist Pair (STP) LAN cable.

3 Internet environment

DLNA connection

To use DLNA features, you need a home network environment and you can operate the features without a broadband network environment.

- A broadband network environment is required to use internet services.

 → Network > Network connections > Internet connection

- Depending on the model, it may be necessary to remove the terminal cover / cable cover before connecting or disconnecting the LAN cable.

■ Wireless connection (For DLNA and internet service)

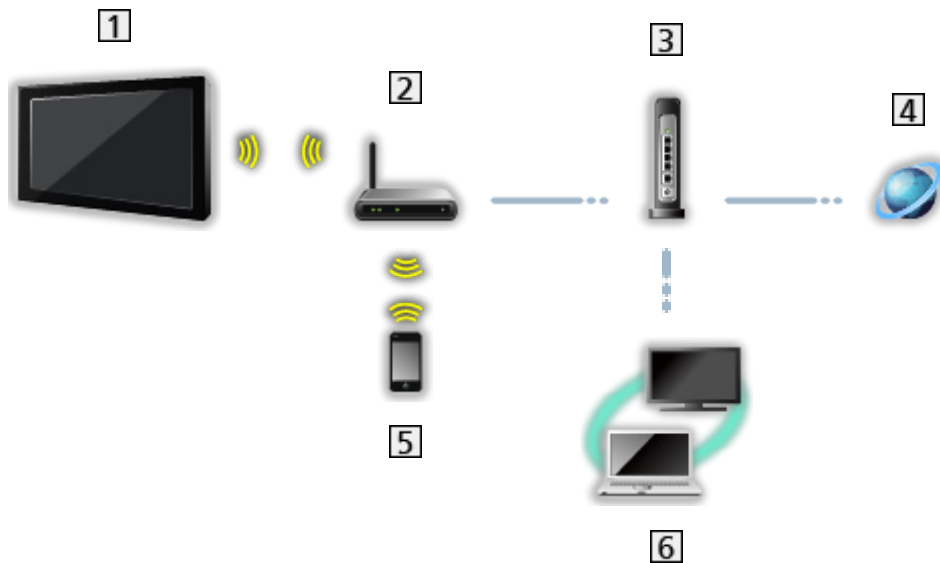

1 Built-in wireless LAN (Rear of the TV)

2 Access point

3 Hub / Router

4 Internet environment

5 Smartphone, etc.

6 DLNA Certified media server (PC, etc.)

■ Wired connection (For DLNA and internet service)

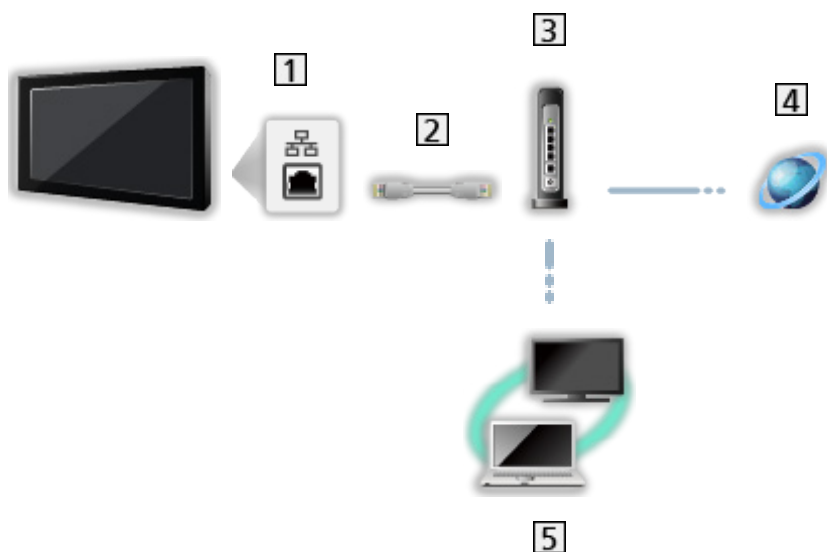

1 ETHERNET terminal

2 LAN cable (Shielded)

- Use Shielded Twist Pair (STP) LAN cable.

3 Hub / Router

4 Internet environment

5 DLNA Certified media server (PC, etc.)

■ Wireless connection (For DLNA)

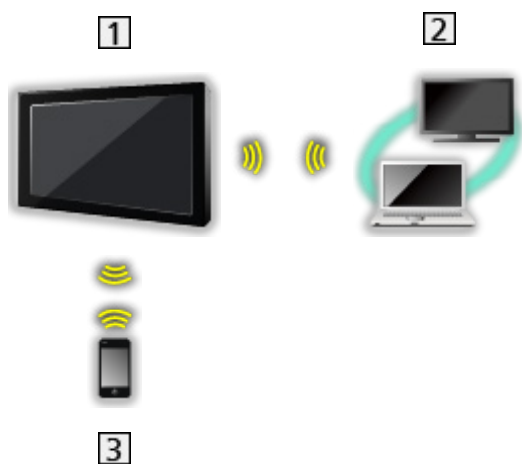

1 TV

- To use the TV as a wireless access point

 → Network > Network settings > Custom - Wireless Access Point

2 DLNA Certified media server (PC, etc.)

3 Smartphone, etc.

Note

- Ensure to use a LAN straight cable.
- Set up and connect equipment required for the network environment. You cannot make such settings on this TV. Read the manual of the equipment.
- If your modem has no broadband router functions, use a broadband router.
- If your modem has broadband router functions but there are no vacant ports, use a hub.
- Ensure that the broadband routers and hubs are compatible with 10BASE-T / 100BASE-TX.
- If you use the equipment compatible only with 100BASE-TX, category 5 or later LAN cables are required.
- Contact your Internet Service Provider (ISP) or telecommunications company for further assistance regarding the network equipment.
- Confirm the terms and conditions of the contracts with your Internet Service Provider (ISP) or telecommunications company. Depending on the contracts, additional fees may be charged or multiple connections to the internet may be impossible.
- Turn the TV off with Mains Power On / Off switch, then turn it on again when changing or making the network connection again.
- Depending on the network condition, the content may not be played back properly.

Network settings

Network Connection

Ensure the connections are completed before starting network setup.

 → Network > Network connections

■ Quick setup - Wireless

1. Display the menu with **MENU**.
2. Select **Network** > **Network Connection** and press **OK** to access.
 - Confirm the encryption key, settings and position of your access point before starting setup. For details, read the manual of the access point.
3. Select **Quick setup** and press **OK** to access.
 - When the LAN cable is connected, wired setup will be done automatically.
4. Select your desired access point and press **OK** to access.
 - Available Wireless Networks are displayed automatically.
 -  : Encrypted access point
 - For WPS(Push button)
 - 1) Select **Easy setup with Push button** and press **OK** to access.
 - 2) Press the WPS button on the access point until the light flashes.
 - 3) Connect the TV with the access point with **OK**.
 - WPS: Wi-Fi Protected Setup™
 - If the connection fails, check the settings and positions of your access point. And then, follow the on-screen instructions.
 - It is recommended to select the encrypted access point.
5. Enter the encryption key of the access point and press **OK** to set.
 - You can set characters using **Numeric buttons**.



- Press **BACK/RETURN** to store.
6. Automatically setup is done and **Network Status** is displayed.

 → Network > Network settings > Network Status

7. Select **Exit** and press **OK** to set.

- To set manually

 → Network > Network settings > Custom - Wireless

■ Quick setup - Wired

1. Display the menu with **MENU**.
2. Select **Network** > **Network Connection** and press **OK** to access.
3. Select **Quick setup** and press **OK** to access.
4. Automatically setup is done and **Network Status** is displayed.

 → **Network** > **Network settings** > **Network Status**

5. Select **Exit** and press **OK** to set.

- To set manually

 → **Network** > **Network settings** > **Custom - Wired**







= Note =

- To deactivate wireless, set **Easy Mirroring** to **Off** and confirm the network connection type is set to **Wired**.

Custom - Wireless

Ensure the connections are completed before starting network setup.

 → Network > Network connections

1. Display the menu with **MENU**.
2. Select **Network > Network Connection > Custom > Wireless** and press **OK** to access.
 - Confirm the encryption key, settings and position of your access point before starting setup. For details, read the manual of the access point.
3. Select your desired access point and press **OK** to access.
 - Available Wireless Networks are displayed automatically.
 -  : Encrypted access point
 - For **WPS(Push button)**
 - 1) Press  (red).
 - 2) Press the WPS button on the access point until the light flashes.
 - 3) Connect the TV with the access point with **OK**.
 - WPS: Wi-Fi Protected Setup™
 - If the connection fails, check the settings and positions of your access point. And then, follow the on-screen instructions.
 - For **WPS(PIN)**
 - 1) Press  (green).
 - 2) Enter the PIN code to the access point.
 - 3) Connect the TV with the access point with **OK**.
 - For **Manual**
 - 1) Press  (yellow).
 - 2) You can set up SSID, security settings and encryption key manually.
 - 3) Follow the on-screen instructions and set manually.
 - To search access points again
 (blue)
 - To display / hide information of the highlighted access point

 - It is recommended to select the encrypted access point.

4. Enter the encryption key of the access point and press **OK** to set.

- You can set characters using **Numeric buttons**.



- Press **BACK/RETURN** to store.

5. **IP/DNS Settings** is displayed.

Acquire IP Address / Acquire DNS Address

- **Auto** is recommended.
 - Available settings are displayed automatically.
 - To set manually, select and set **IP Address** / **Subnet Mask** / **Default Gateway** / **DNS Address**.
-

Proxy Settings

- It is not required for normal household use.
- Some internet services may not be available depending on the proxy setting.

Proxy:

This is the address of the relay server which is connected between the browser and the target server to send data to the browser.

- 1) Select **Proxy** and press **OK** to access.
- 2) Enter the address with **Cursor buttons** or **Numeric buttons**, and press **OK** to set.

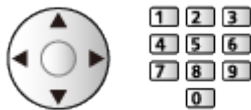

- 3) Press **BACK/RETURN** to store.

Proxy Port:

This number is also specified by the provider with the proxy address.

- 1) Select **Proxy Port**.
- 2) Enter the number with **Numeric buttons**.



- 3) Press **BACK/RETURN** to store.
-

6. Select **Network Status** and press **OK** to access.

 → **Network > Network settings > Network Status**

7. Select **Exit** and press **OK** to set.

Custom - Wired

Ensure the connections are completed before starting network setup.

 → Network > Network connections

1. Display the menu with **MENU**.
 2. Select **Network** > **Network Connection** > **Custom** > **Wired** and press **OK** to access.
 3. **IP/DNS Settings** is displayed.
-

Acquire IP Address / Acquire DNS Address

- **Auto** is recommended.
 - Available settings are displayed automatically.
 - To set manually, select and set **IP Address** / **Subnet Mask** / **Default Gateway** / **DNS Address**.
-

Proxy Settings

- It is not required for normal household use.
- Some internet services may not be available depending on the proxy setting.

Proxy:

This is the address of the relay server which is connected between the browser and the target server to send data to the browser.

- 1) Select **Proxy** and press **OK** to access.
- 2) Enter the address with **Cursor buttons** or **Numeric buttons**, and press **OK** to set.

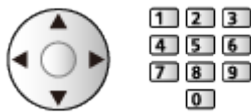

- 3) Press **BACK/RETURN** to store.

Proxy Port:

This number is also specified by the provider with the proxy address.

- 1) Select **Proxy Port**.
- 2) Enter the number with **Numeric buttons**.



- 3) Press **BACK/RETURN** to store.
-

4. Select **Network Status** and press **OK** to access.

 → **Network > Network settings > Network Status**

5. Select **Exit** and press **OK** to set.

= Note =

- To deactivate wireless, set **Easy Mirroring** to **Off** and confirm the network connection type is set to **Wired**.

Custom - Wireless Access Point

You can use the TV as a wireless access point and connect the network equipment without an access point.

- Confirm the PIN code, network settings of the equipment before starting setup. For details, read the manual of the equipment.
1. Display the menu with **MENU**.
 2. Select [Network](#) > [Network Connection](#) > [Custom](#) > [Wireless Access Point](#) and press **OK** to access.
 3. Select [Connect to device in WPS](#) and press **OK** to access.
 - To set manually, select [Change settings](#) (see below).
 4. Select and set [WPS\(Push button\)](#) / [WPS\(PIN\)](#) and press **OK** to access.

[WPS\(Push button\)](#):

Set up the equipment for [WPS\(Push button\)](#). For details, read the manual of the equipment.

[WPS\(PIN\)](#):

Enter the PIN code of the equipment.

- If the connection fails, check the settings and positions of the equipment. And then, follow the on-screen instructions.

■ Change settings

You can set up [Network Name\(SSID\)](#), [Encryption key](#), [Wireless type](#) and [Channel setting method](#) manually.

Follow the on-screen instructions and set manually.

- Set [Reset settings](#) to reset the items for [Change settings](#).

= Note =

- You cannot connect the internet service while the TV is set to [Wireless Access Point](#).
- You can connect up to 7 devices. But the transfer rate varies according to communication environment or the numbers of connected equipment.
- To confirm the current network settings
 → [Network](#) > [Network settings](#) > [Network Status](#)
- Ensure the equipment to connect supports WPS for this setup.
- WPS: Wi-Fi Protected Setup™

Network Status

Displays and checks the network status (MAC Address, current network settings, etc.).

1. Display the menu with **MENU**.
2. Select **Network** > **Network Status** and press **OK** to access.
3. Automatically testing is done and **Network Status** is displayed.

Try Again:

Performs automatic testing of the network connection for the TV and displays the current status again.

Status Details:

Displays the detailed network status (SSID, security settings, etc.).

- For information about the network connection, select **Help**.

my Home Cloud Settings

Displays the terms of service.

1. Display the menu with **MENU**.
2. Select **Network** > **my Home Cloud Settings** > **Notices** and press **OK** to access.
3. Follow the on-screen instructions.

VIERA Name

Sets your favourite name for this TV.

1. Display the menu with **MENU**.
2. Select **Network** > **VIERA Name** and press **OK** to access.
3. Enter characters and press **OK** to set.
 - This name is used as the name of this TV on the screen of the other network equipment.
 - When you use two or more TVs in your network environment, set the names of the TVs for each.

TV Remote App Settings

Sets to control the TV with the equipment (smartphone, etc.) connected to your network.

1. Display the menu with **MENU**.
 2. Select **Network > TV Remote App Settings** and press **OK** to access.
 3. Select one of the following items and press **OK** to access.
TV Remote / Powered On by Apps / Networked Standby / Home Streaming / Device to upload contents
 4. Set the item and press **OK** to store.
-

TV Remote

(On / Off)

Enables controlling the TV from the network equipment (smartphone, etc.).

Powered On by Apps

(On / Off)

Enables turning the TV on from the network equipment (smartphone, etc.).

- Depending on the network condition, you may have to turn the TV on with Standby On / Off switch of the TV's remote control.
 - Changing the default configuration may result in higher energy consumption of the product.
 - LED turns to orange in Standby mode when **Powered On by Apps** is set to **On**.
-

Networked Standby

(On / Off)

Enables turning the TV on via the LAN cable or wireless LAN using a wake-up message sent from the network equipment in the home network.

- Changing the default configuration may result in higher energy consumption of the product.
-

Home Streaming

(Always / Only when powered on)

Enables sharing the TV programme and content of this TV with the network equipment (smartphone, etc.) in the home network.

- Changing the default configuration may result in higher energy consumption of the product.
 - LED turns to orange in Standby mode when **Home Streaming** is set to **Always**.
-

Device to upload contents

Selects device to upload content from the network equipment (smartphone, etc.).

= Note =

- This function is not available when the TV is turned off with Mains Power On / Off switch.
- You need to install the application for controlling VIERA on your smartphone.

 → [Support > FAQs > Detailed information](#)

For the operations, refer to the support information of the application.

- Depending on the network condition, this function may not be available.
- Depending on the area, this function may not be available. For details, consult your local Panasonic dealer.

Network Link Settings

Sets to control the TV with devices connected to the network.

1. Display the menu with **MENU**.
 2. Select **Network** > **Network Link Settings** and press **OK** to access.
 3. Select one of the following items and press **OK** to access.
[DLNA Server](#) / [Registration Type](#) / [Remote Device List](#)
 4. Set the item and press **OK** to store.
-

DLNA Server

(On / Off)

Enables sharing the TV programme and content of this TV with the network equipment (DLNA Certified VIERA, etc.).

- To use this function with another VIERA, select the name of this TV from the DLNA server list of another VIERA, and then select the content to share. Also read the manual of another VIERA.
- To use this function with your smartphone, you need to install the application for controlling VIERA on your smartphone.

 → [Support](#) > [FAQs](#) > [Detailed information](#)

For the operations, refer to the support information of the application.

- Changing the default configuration may result in higher energy consumption of the product.
 - LED turns to orange in Standby mode when **DLNA Server** is set to **On**.
-

Registration Type

(Auto / Manual)

Selects the type to restrict the access to this TV for each piece of equipment on the home network.

Auto:

All available equipment on the home network is accessible (maximum 16 pieces of equipment).

Manual:

Sets the restrictions for each piece of equipment in [Remote Device List](#).

Remote Device List

Lists the equipment accessible to this TV on the home network.

= Note =

- Depending on the area, this function may not be available. For details, consult your local Panasonic dealer.

TV Anywhere Settings

Settings for watching TV or editing timer programming with the network equipment (smartphone, etc.) from outside the home network.

 → [Functions](#) > [TV Anywhere](#) > [TV Anywhere Settings](#)

File Sharing Settings

File Sharing Server

(On / Off)

Sets to share the files between PC and devices connected to this TV.

 → [Media Player > Using Media Player > Sharing file](#)

Network Device List

Lists the accessible network devices to play back the content in Media Player.

 → [Media Player > Using Media Player > Network device](#)

Mirroring Settings

Settings for the mirroring function

 → [Functions](#) > [Mirroring](#) > [Mirroring Settings](#)

Control4 Settings

Settings for the Control4 function

1. Display the menu with **MENU**.
 2. Select **Network** > **Control4 Settings** and press **OK** to access.
 3. Select **Control4 Discovery / Send Identify** and press **OK** to access.
 4. Set the item and press **OK** to store.
-

Control4 Discovery

(On / Off)

Enables Control4 mode.

Send Identify

Sends identifying message to Control4 controller.

- This function is available when **Control4 Discovery** is set to **On**.
-

= Note =

- For details of the settings and operations, consult your local Control4 dealer.

Software Update

Accesses the specific website to update the TV's software if any updates are available.

1. Display the menu with **MENU**.
2. Select **Network** > **Software Update** and press **OK** to access.
3. Follow the on-screen instructions.
 - A broadband network environment is required to use this function.

New Software Message

Selects whether to give a notification message when new software is found via network or not.

1. Display the menu with **MENU**.
2. Select **Network** > **New Software Message** and press **OK** to access.
3. Select **On / Off** and press **OK** to set.

Photos

Selecting file

Ensure the preparations of the media server, network connections and network settings are completed.

 → Network > DLNA > In-House streaming

 → Network > Network connections

 → Network > Network settings

1. Display Home Screen with **HOME**.
2. Select **Devices** and press **OK** to access.
3. Select the media server and press **OK** to access.
 - To display / hide information of the highlighted media server
 - 1) Display the option menu with **OPTION**.
 - 2) Select **Show Info.** and press **OK** to access.
4. Select the file and press **OK** to access.
 - Depending on the condition of media server, you may need to select the folder before selecting the file.
 - To display / hide information of the highlighted file



= Note =



- Non-playable files are also listed but cannot be selected.

Viewing photo

■ Playback

- To operate Single view
 - ◀ : To the previous photo
 - ▶ : To the next photo
 - ▽ : Stop (return to list)
 - OK : Slideshow
- To display / hide the operation guide
 - i
- To rotate 90°
 - (blue)
- To return to list
 - BACK/RETURN

Using Slideshow

1. Select the file from the thumbnail of photos for the first view.
2. Start Slideshow with  (red) and **OK**.
 - To display / hide the operation guide

 - To pause (return to Single view)
OK
 - To return to list
BACK/RETURN

■ Slideshow Settings

Set up the settings for photo file operations on this TV.

1. Display the option menu with **OPTION**.
2. Select [Slideshow Settings](#) and press **OK** to access.
3. Select one of the following items and press **OK** to access.
[Interval](#) / [Repeat](#) / [Back Ground Music](#)
4. Set the item and press **OK** to store.

[Interval](#)

([Long](#) / [Normal](#) / [Short](#))

Selects slideshow interval.

[Repeat](#)

([On](#) / [Off](#))

Slideshow repeat

[Back Ground Music](#)

([Off](#) / [Type1](#) / [Type2](#) / [Type3](#) / [Type4](#) / [Type5](#))

Selects the background music during Photo mode.

Videos

Selecting file

Ensure the preparations of the media server, network connections and network settings are completed.

 → Network > DLNA > In-House streaming

 → Network > Network connections

 → Network > Network settings

1. Display Home Screen with **HOME**.
2. Select **Devices** and press **OK** to access.
3. Select the media server and press **OK** to access.
 - To display / hide information of the highlighted media server
 - 1) Display the option menu with **OPTION**.
 - 2) Select **Show Info.** and press **OK** to access.
4. Select the file and press **OK** to access.
 - Depending on the condition of media server, you may need to select the folder before selecting the file.
 - To display / hide information of the highlighted file



= Note =

- Non-playable files are also listed but cannot be selected.

Watching video

■ Playback

If you have stopped the last playback halfway, a confirmation screen may be displayed to select whether to start from where you stopped last time or from the beginning.

- To operate playback

 : **Manual skip** (if available)

– Press to skip forward approx. 30 seconds.

 : Rewind

 : Fast forward

 : Stop

 : Pause (displays the time seek bar / slow playback) / Playback



- To jump to the specified time point

1) Display the time seek bar with .

2) While the time seek bar is displayed

Press  /  :

Search approx. 10 seconds

Press and hold  /  :

Search rapidly

3) Jump to the specified time point with .

- To display / hide the operation guide and information banner



- To the previous content

 (red)

- To the next content

 (green)

- To change aspect

1) Display **Aspect Selection** with .

2) Select the mode and press  to set.

Aspect1:

Displays the content in original size.

Aspect2:

Displays the content enlarged without distortion.

- You can also change the mode pressing **ASPECT**. (Press repeatedly until you reach the desired mode.)
- Aspect cannot be changed depending on the content.
- To return to list
BACK/RETURN

Video Setup

Set up the settings for video file operations on this TV.

1. Display the option menu with **OPTION**.
 2. Select **Video Setup** and press **OK** to access.
 3. Select one of the following items and press **OK** to access.
Video Preview / Multi Audio / Monaural Audio / Dual Mono Audio / Repeat / Subtitle Settings
 - Menu items and selectable options vary depending on the content.
 4. Set the item and press **OK** to store.
-

Video Preview

(On / Off)

Sets to start the preview of the title or scene in the thumbnail view.

- Images may not be displayed for an instant in the thumbnail view. Set the preview **Off** to solve this.
-

Multi Audio, Monaural Audio, Dual Mono Audio

Selects for selectable sound tracks (if available).

- It may take several seconds to change the sound.
 - This function is available during playback.
-

Repeat

(On / Off)

Playback repeat within the selected file

Subtitle Settings

Sets the subtitle setting.

- This function is available during playback.

Subtitle:

Display / hide subtitles (if available).

Subtitle Text:

Selects the font type to display subtitles correctly (if available).

Subtitle Text Size:

Selects the font size of subtitles.

Subtitle Text Colour:

Selects the colour of subtitles.

Subtitle Text Position:

Adjusts the position of subtitles on the screen.

Subtitle Text Delay:

Adjusts the delay time for the subtitles.

Audio output settings

You can enjoy the multi-channel sound via an amplifier connected to DIGITAL AUDIO or HDMI2 (ARC function) terminal.

- To confirm or change the current sound status

 → Network > Videos > Video Setup

1. Display the menu with **MENU**.
 2. Select **Sound** > **SPDIF Selection** and press **OK** to access.
 3. Select **Auto** / **PCM** and press **OK** to set.
-

SPDIF Selection

(Auto / PCM)

Selects the initial setting for digital audio output signal from DIGITAL AUDIO and HDMI2 (ARC function) terminals.

- SPDIF is a standard audio transfer file format.

Auto:

Dolby Audio (Dolby Digital, Dolby Digital Plus) and HE-AAC multi-channel are output as Dolby Digital Bitstream. MPEG is output as PCM.

PCM:

Digital output signal is fixed to PCM.

- ARC (Audio Return Channel) is a function of digital audio output using HDMI cable.

= Note =

- During the operation, audio signal is output from DIGITAL AUDIO and HDMI2 (ARC function) terminals. But no video signals are output. To use HDMI2 with ARC function, connect an amplifier that has ARC function and set to use theatre speakers.

 → Functions > VIERA Link "HDAVI Control™"

Music

Selecting file

Ensure the preparations of the media server, network connections and network settings are completed.

 → Network > DLNA > In-House streaming

 → Network > Network connections

 → Network > Network settings

1. Display Home Screen with **HOME**.
2. Select **Devices** and press **OK** to access.
3. Select the media server and press **OK** to access.
 - To display / hide information of the highlighted media server
 - 1) Display the option menu with **OPTION**.
 - 2) Select **Show Info.** and press **OK** to access.
4. Select the file and press **OK** to access.
 - Depending on the condition of media server, you may need to select the folder before selecting the file.
 - To display / hide information of the highlighted file



= Note =

- Non-playable files are also listed but cannot be selected.

Playing music

■ Playback

- To operate playback

◀ : Rewind

▶ : Fast forward

▽ : Stop

OK : Pause (displays the time seek bar) / Playback

- To jump to the specified time point

1) Display the time seek bar with **OK**.

2) While the time seek bar is displayed

Press ◀ / ▶ :

Search approx. 10 seconds

Press and hold ◀ / ▶ :

Search rapidly

3) Jump to the specified time point with **OK**.

- To display / hide the operation guide



- To the previous track

 (red)

- To the next track

 (green)

- To return to list

BACK/RETURN

Music Setup

Set up the settings for music file operations on this TV.

1. Display the option menu with **OPTION**.
2. Select **Music Setup** > **Repeat** with **OK**.
3. Select **Off / Folder / One** and press **OK** to set.

Folder:

Playback repeat within the selected folder

One:

Playback repeat of the selected one file

Supported format

Photo format

■ Supported Photo formats

- JPEG (.jpg, .jpeg)

Sub-sampling:

4:4:4, 4:2:2, 4:2:0

Image resolution (pixel):

8 × 8 to 30 719 × 17 279

- DCF and EXIF standards
 - Progressive JPEG is not supported.
-

= Note =

- Some files may not be played back even if they fulfil these conditions.
- Do not use multi-byte characters or other special codes for file names.
- Connected devices may become unusable with this TV if the file or folder names are changed.

Video format

■ Supported Video formats

- AVCHD (.mts)

Video codec:

H.264

Audio codec:

Dolby Audio (Dolby Digital)

- AVCHD Standard Ver. 2.0 (AVCHD Progressive)
 - The data may not be available if a folder structure on the device is modified.
-

- AVI (.avi)

Video codec:

H.264, MPEG1, MPEG2, MPEG4, VC-1, WMV9

Audio codec:

AAC, ADPCM, Dolby Audio (Dolby Digital, Dolby Digital Plus), HE-AAC, LPCM, MP3, WMA

- MP4 (.f4v, .m4v, .mp4)

Video codec:

H.264, H.265 (HEVC), MPEG1, MPEG2, MPEG4

Audio codec:

AAC, Dolby Audio (Dolby Digital, Dolby Digital Plus), HE-AAC, MP3

- This TV supports this container recorded with Panasonic products. For details, read the manual of the products.
-

- MKV (.mkv)

Video codec:

H.264, H.265 (HEVC), MPEG1, MPEG2, MPEG4

Audio codec:

AAC, Dolby Audio (Dolby Digital, Dolby Digital Plus), HE-AAC, MP3, Vorbis

- ASF (.asf, .wmv)

Video codec:

MPEG4, VC-1, WMV9

Audio codec:

AAC, Dolby Audio (Dolby Digital, Dolby Digital Plus), HE-AAC, LPCM, MP3, WMA

- Copy-protected files cannot be played back.
-

- FLV (.flv)

Video codec:

H.264

Audio codec:

AAC, MP3

- 3GPP (.3gp, .3g2)

Video codec:

H.264, MPEG4

Audio codec:

AAC, HE-AAC

- PS (.mod, .mpg, .mpeg, .vob, .vro)

Video codec:

MPEG1, MPEG2

Audio codec:

Dolby Audio (Dolby Digital), LPCM

- TS (.mts, .m2ts, .tp, .trp, .ts, .tts)

Video codec:

H.264, H.265 (HEVC), MPEG1, MPEG2

Audio codec:

AAC, Dolby Audio (Dolby Digital, Dolby Digital Plus), HE-AAC

- WebM (.webm)

Video codec:

VP9

Audio codec:

Vorbis

■ Supported Subtitles formats

- MicroDVD, SubRip, TMLPlayer (.srt, .sub, .txt)

- The video file and subtitles text file are inside the same folder, and the file names are the same except for the file extensions.
 - If there are more than one subtitles text files inside the same folder, they are displayed in the following order of priority: “.srt”, “.sub”, “.txt”.
-

= Note =

- Some files may not be played back even if they fulfil these conditions.
- Some subtitles or chapter functions may not be available.
- Do not use multi-byte characters or other special codes for file names.
- Connected devices may become unusable with this TV if the file or folder names are changed.
- Supported formats are different in Media Player and media server.

Music format

■ Supported Music formats

- MP3 (.mp3)
-

- AAC / Apple Lossless (.m4a)
 - Copy-protected files cannot be played back.
-

- FLAC (.flac)
-

- WMA (.wma)
 - Copy-protected files cannot be played back.
-

- LPCM (.wav)
-

= Note =

- Some files may not be played back even if they fulfil these conditions.
- Do not use multi-byte characters or other special codes for file names.
- Connected devices may become unusable with this TV if the file or folder names are changed.

Functions

Info Frame

Information

Info Frame is a convenient feature to provide you relevant information of the programme being watched, recommendations, etc. It is displayed on the edge of screen when you need it.

(Example)



- A broadband network environment is required to fully use this function.

= Note =

- Design and specifications are subject to change without notice.

How to use

You can check useful information using Info Frame while watching TV.

1. Press and hold **HOME**.

- Info Frame is displayed on the edge of screen.

(Example)

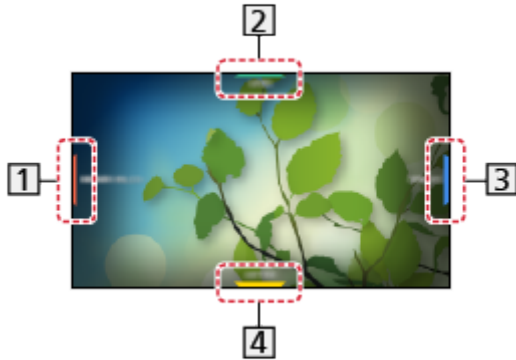

1 Current programme information, etc.

2 Relevant information (weather forecast, etc.)

3 Notification message

4 Recommended content (TV programme, internet content, etc.)

- You can also display Info Frame by pressing and holding **HOME** on Touch Pad Controller.

2. Select one side of Info Frame with **Cursor buttons** or **Red**, **Green**, **Yellow**, **Blue** (coloured buttons) while Info Frame is displayed.



- You can also select by sliding your finger across the Touch Pad Controller.

3. Follow the on-screen instructions.

- To exit Info Frame

BACK/RETURN

= Note =

- Info Frame is displayed for several seconds each time the TV is turned on.

 → [Functions > Info Frame > Settings](#)

Settings

You can set items for Info Frame.

1. Display the menu with **MENU**.
 2. Select **Setup > Display Settings > Info Frame at Power on** and press **OK** to access.
 3. Set the item and press **OK** to store.
-

Info Frame at Power on

(On / Off)

Displays Info Frame when the TV is turned on.

Voice Control

Information

Voice Control function allows you to operate the TV (e.g. selecting a channel), search the content from various features, etc. with your speech.

- A broadband network environment is required to fully use this function. Ensure the network connections and network settings are completed.

 → [Network > Network connections](#)

 → [Network > Network settings](#)

- To use this function with Touch Pad Controller, ensure the pairing is completed.

 → [Functions > Touch Pad Controller > Pairing](#)

How to use

1. Press  on the Touch Pad Controller to display the operation guide.
 - When a confirmation screen is displayed, read carefully and start Voice Control function.

(Example)



2. Say a key word (e.g. Volume up) to the microphone while the operation guide is displayed.

(Example)



- The operation guide turns to blue during processing.
- The operation guide automatically disappears after a certain period of time. Press  again to start the Voice Control function.

- To display voice command list



- To exit Voice Control function



Settings

You can set items for Voice Control function.

1. Display the menu with **MENU**.
 2. Select [Setup](#) > [Voice Control Settings](#) and press **OK** to access.
 3. Select one of the following items and press **OK** to access.
[Speech Detection Level](#) / [Terms of Service](#) / [Instructions for Voice Control](#)
 4. Set the item and press **OK** to store.
-

[Speech Detection Level](#)

([High](#) / [Standard](#))

Adjusts the sensitivity to recognise your speech.

[Terms of Service](#)

Displays the terms of service.

[Instructions for Voice Control](#)

Displays details of Voice Control function in eHELP.

Note

- When you start Voice Control function, sound level of the TV becomes low.
- Voice Control function may not work properly in the following conditions:
 - Not pronouncing words clearly and correctly
 - Speaking too loudly or too quietly.
 - Surrounded by loud background noise.
- Phrases other than Voice Command may not be recognised.
- It is recommended to speak within approx. 15 cm from the microphone when using Touch Pad Controller.
- Design and specifications are subject to change without notice.
- A broadband network environment is required to fully use this function, because this function accesses the speech recognition server with the internet connection. Even if you have the internet environment, this function may not be available depending on the proxy setting. Please connect the internet without proxy settings. (Proxy settings are not required for normal household use. For details of the internet environment, consult your Internet Service Provider (ISP) or telecommunications company.)

Touch Pad Controller

Information

The Touch Pad Controller is designed for convenient and intuitive operation, especially with the Home Screen or internet content.

- Touch Pad Controller can be used exclusively for controlling this TV.
- Register the Touch Pad Controller to this TV with Bluetooth wireless technology before using. The registration starts automatically when you press any buttons (except Standby On / Off switch) after installing batteries. To register again, set [VIERA Touch Pad Controller](#) in the Setup Menu.

 → [Functions > Touch Pad Controller > Pairing](#)

- After registering, you can operate the TV without pointing this controller at the TV (except Standby On / Off switch).
- It is recommended to speak within approx. 15 cm from the microphone of Touch Pad Controller when using the Voice Control function.

Pairing

Perform the registration when Touch Pad Controller is used for the first time.

The registration starts automatically when you press any buttons (except Standby On / Off switch) after installing batteries.

To register again, take following steps.

1. Display the menu with **MENU**.
2. Select **Setup > VIERA Touch Pad Controller > Pairing** and press **OK** to access.
3. Follow the on-screen instructions.

= Note =

- Place Touch Pad Controller within 50 cm from the TV while registration is in progress.
- Only 1 Touch Pad Controller can be registered.

Identifying controls

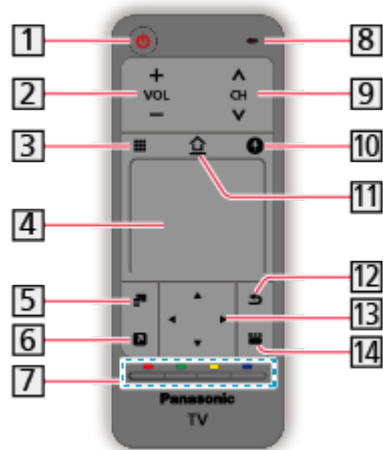

1 Standby On / Off switch

2 Volume Up / Down

3 On-screen remote control

- Press to display the remote control GUI (Graphical User Interface).
- Press again to move the position of GUI. Swipe to select the button.
- Press **12** to exit the on-screen remote control.

4 Touch pad

- For operations, refer to [Operation Guide](#) in the Setup menu.

 → [Functions > Touch Pad Controller > Settings](#)

5 Option menu

- Easy optional setting for viewing, sound, etc.

6 My App

- Assigns your favourite application and starts the application easily only by pressing the button.

 → [Home Screen > Apps > My App](#)

7 Coloured buttons (red-green-yellow-blue)

- Used for the selection, navigation and operation of various functions.

8 Microphone

9 Channel Up / Down

10 Voice Control button

- For details of Voice Control function

 → [Functions > Voice Control](#)

11 HOME

- Displays Home Screen.

12 Return

- Returns to the previous menu / page.

13 Cursor buttons

14 APPS

- Displays [Apps](#).

= Note =

- To use Standby On / Off switch, point the controller directly at the TV's remote control signal receiver because it works with infrared sensors. (You can operate the switch without registration.)

Settings

1. Display the menu with **MENU**.
2. Select **Setup > VIERA Touch Pad Controller** and press **OK** to access.
3. Select one of the following items and press **OK** to access.

[Pairing](#) / [Cursor Sensitivity](#) / [Operation Guide](#)

4. Follow the on-screen instructions.
-

Pairing

Registers Touch Pad Controller (supplied) to this TV.

 → [Functions > Touch Pad Controller > Pairing](#)

Cursor Sensitivity

([Max](#) / [Mid](#) / [Min](#))

Adjusts the sensitivity of the cursor.

Operation Guide

Displays the operation guide of Touch Pad Controller.

TV Anywhere

How to use

You can watch TV and set timer event with the network equipment (smartphone, etc.) from outside the home network.

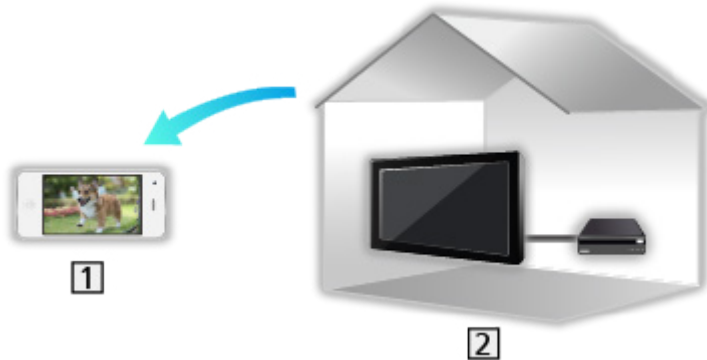

1 Smartphone, etc.

2 TV

- Ensure the network connections and network settings are completed.

 → [Network > Network connections](#)

 → [Network > Network settings](#)

1. Set [TV Anywhere](#) to [On](#).

 → [Functions > TV Anywhere > TV Anywhere Settings](#)

2. Connect the device (smartphone, etc.) to the home network and access to the TV.

- You need to install the application for controlling VIERA on your smartphone.

 → [Support > FAQs > Detailed information](#)

For the operations, refer to the support information of the application.

= Note =

- This function is not available when the TV is turned off with Mains Power On / Off switch.
- Due to network conditions or certain broadcaster restrictions, this function may not be available.

TV Anywhere Settings

1. Display the menu with **MENU**.
 2. Select **Network > TV Anywhere Settings** and press **OK** to access.
 3. Select one of the following items and press **OK** to access.
TV Anywhere / Powered on by Swipe & Share / Device ID / Device Password
 4. Follow the on-screen instructions.
-

TV Anywhere

(On / Off)

Enables watching TV and setting timer event with the network equipment (smartphone, etc.) from outside the home network.

- Changing the default configuration may result in higher energy consumption of the product.
 - LED turns to orange in Standby mode when **TV Anywhere** is set to **On**.
-

Powered on by Swipe & Share

(On / Off)

Enables turning on the TV automatically when the Swipe & Share function is activated from the other devices (smartphone, etc.).

- Set **TV Anywhere** to **On** to use this function.
 - Use the Swipe & Share function to turn on the TV only when you can see the status of the TV.
-

Device ID

Displays the device ID of this TV.

Device Password

Displays the device password of this TV.

Mirroring

How to use

You can watch and display images of other devices (smartphone, etc.) on the TV screen using a mirroring function.



1 Smartphone, etc.

2 TV

1. Display Home Screen with **HOME**.
2. Select **Devices** and press **OK** to access.
3. Select **Mirroring** and press **OK**.
4. Follow the on-screen instructions.
 - Pairing information of the device (smartphone, etc.) is registered once you use this function.

■ Easy Mirroring

You can also start the mirroring function from the other devices (smartphone, etc.) when **Easy Mirroring** is set to **On**.

 → **Functions > Mirroring > Mirroring Settings**

- You cannot use Easy Mirroring function while the TV is set to **Wireless Access Point**.

 → **Network > Network settings > Network Status**

= Note =

- This function is available with the other devices (smartphone, etc.) supporting the mirroring function. For details, refer to the operating instructions of the devices.

Mirroring Settings

You can set items for the mirroring function.

1. Display the menu with **MENU**.
 2. Select **Network > Mirroring Settings** and press **OK**.
 3. Select one of the following items and press **OK** to access.
[Easy Mirroring](#) / [Powered On by Easy Mirroring](#) / [Delete All Pairings](#)
 4. Set the item and press **OK** to store.
-

Easy Mirroring

(On / Off)

Enables starting the mirroring function from the other devices (smartphone, etc.) without operating the TV.

- To deactivate wireless, set [Easy Mirroring](#) to **Off** and confirm the network connection type is set to **Wired**.

 → [Network > Network settings > Network Status](#)

- Not valid when the TV is set to [Wireless Access Point](#)
-

Powered On by Easy Mirroring

(On / Off)

Enables turning on the TV automatically when the mirroring function is activated from the other devices (smartphone, etc.).

- Changing the default configuration may result in higher energy consumption of the product.
 - Use the mirroring function to turn on the TV only when you can see the status of the TV.
 - Register the devices (smartphone, etc.) before using this function.
 - LED turns to orange in Standby mode when [Powered On by Easy Mirroring](#) is set to **On**.
-

Delete All Pairings

Delete the pairing information for all paired devices.

Multi Window

Information

■ Multi Window

Displays two windows at once for viewing the TV programmes or external input (AV / COMPONENT / HDMI) as shown below (example).



- To swap windows
OK
 - Not valid while recording is in progress
- To exit multi window
EXIT

Multi Window

You can select a channel while watching another programme or external input.

1. Display **Apps** with **APPS**.
2. Select **Multi Window** and press **OK** to access.

■ Dual view

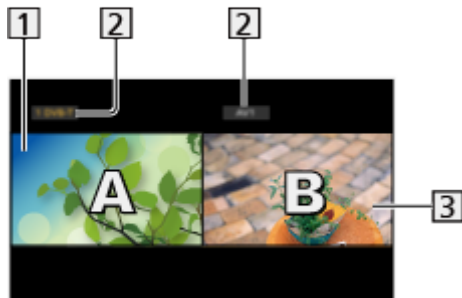

(Example)



1 Main screen

2 TV mode / Input mode / Channel position and name

3 Sub screen

- Press ◀ / ▶ to select the screen to operate.
 -  displays on the screen.
- To select the sound
 - 1) Display the option menu with **OPTION**.
 - 2) Select **Sound Output** and press **OK** to access.
 - 3) Select **Main / Sub** and press **OK** to set.
 -  displays on the screen.
- To confirm or change the current status

OPTION

 - Menu items and selectable options vary between the main screen and sub screen.

 → **Watching > Basic > AV Options**
- To display / hide the operation guide



Note

- This function may not work properly depending on the signal format.
- Ensure that **Dual Tuner Mode** is set to **On** in **Tuning Menu** to display Freesat or Other Sat. / Satellite both in two windows.
- Not valid in Analogue
- Data services are not available in multi window.
- You cannot change the aspect ratio in multi window.
- External input mode can only be displayed either on the main screen or sub screen.
- HDMI is available for the main screen.
- Some signals are reformatted for suitable viewing on your display.
- Playback in fast-forward or in reverse on the sub screen may affect the picture quality on the main screen.

VIERA Link “HDAVI Control™”

Summary of VIERA Link

Enjoy additional HDMI Inter-Operability with Panasonic products which have “HDAVI Control™” function.

VIERA Link (HDAVI Control) connects the TV and the equipment with VIERA Link function, and enables easy control, playback, energy saving, creating home theatre, etc. without complicated settings. Connections to the equipment (DVD Recorder, HD Video Camera, Player theatre, Amplifier, etc.) with HDMI cable allow you to interface them automatically. These features are limited to models incorporating “HDAVI Control” and “VIERA Link”.

- This TV supports “HDAVI Control 5” function.
- Some functions are not available depending on the equipment’s version of HDAVI Control. Confirm the connected equipment’s version of HDAVI Control.
- VIERA Link “HDAVI Control” is a unique function that we have developed and added based on the control functions provided by HDMI which is an industry standard known as HDMI CEC (Consumer Electronics Control). As such, its operation with other manufacturers’ product that supports HDMI CEC cannot be guaranteed.
- VIERA Link features may be available even with other manufacturers’ equipment supporting HDMI CEC.
- Please refer to individual manuals for other manufacturers’ product supporting VIERA Link function.
- About applicable Panasonic product, consult your local Panasonic dealer.

■ VIERA Link (HDMI connection)

- Depending on the model, it may be necessary to remove the terminal cover / cable cover before connecting or disconnecting cables.
- Use a fully wired HDMI compliant cable.
- Connect the equipment supporting VIERA Link to the TV's HDMI terminal via an HDMI cable.

About HDMI cable for connecting Panasonic HD Video Camera or LUMIX Camera, read the manual of the equipment.

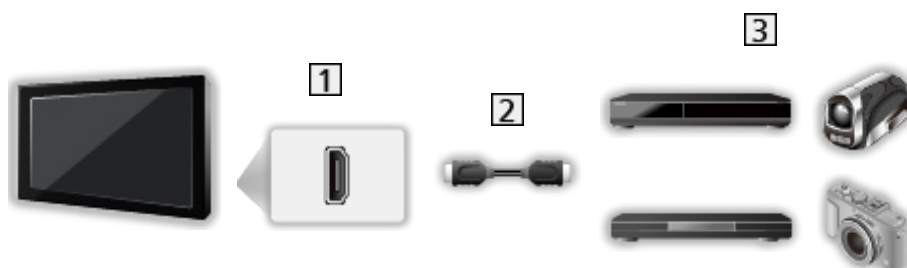

1 HDMI terminal

2 HDMI cable

3 Equipment with VIERA Link function (DVD Recorder / DVD Player / Blu-ray Disc Player / HD Video Camera / LUMIX Camera)

■ Available features (HDMI connection)

DVD Recorder / DVD Player / Blu-ray Disc Player

- Easy playback
- Power on Link
- Power off Link
- Standby Power Save*²
- Intelligent Auto Standby*²
- VIERA Link Control*¹

HD Video Camera / LUMIX Camera

- Easy playback
- Power on Link
- Power off Link
- VIERA Link Control*¹

*1 : For equipment which has "HDAVI Control 2 or later" function.

*2 : For equipment which has "HDAVI Control 4 or later" function.

■ VIERA Link (HDMI and Audio out connections)

- Depending on the model, it may be necessary to remove the terminal cover / cable cover before connecting or disconnecting cables.
- Use a fully wired HDMI compliant cable.
- Connect the equipment supporting VIERA Link to the TV's HDMI terminal via an HDMI cable.
- Use the optical digital audio cable for audio output from the TV.

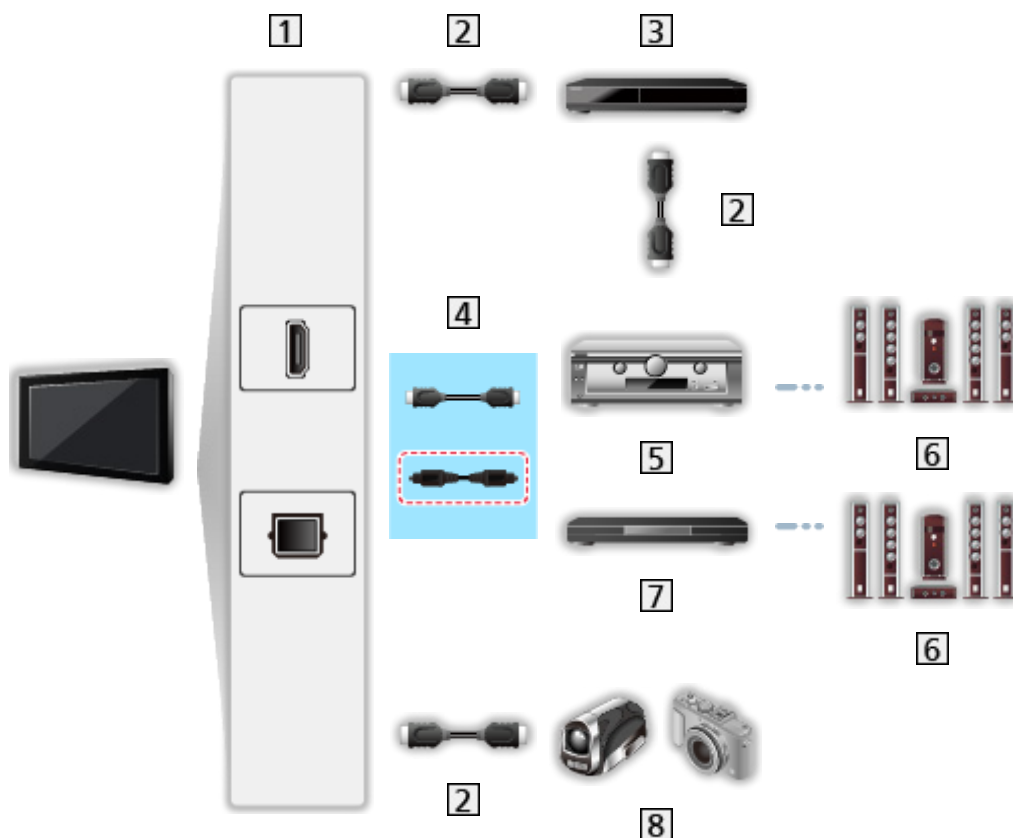

1 HDMI terminal / DIGITAL AUDIO

2 HDMI cable

3 DVD Recorder with VIERA Link function

4 HDMI cable (Optical digital audio cable*)

5 Amplifier with VIERA Link function

6 Speaker system

7 Player theatre / Blu-ray Disc theatre with VIERA Link function

8 HD Video Camera / LUMIX Camera with VIERA Link function

*: If the connected equipment has "HDAVI Control 5" function, you do not have to use this audio cable (Optical digital audio cable). In this case, connect the equipment to the TV's HDMI2 terminal via an HDMI cable.

■ Available features (HDMI and Audio out connections)

Player theatre

- Easy playback*³
 - Power on Link
 - Power off Link
 - Intelligent Auto Standby*^{2*4}
 - VIERA Link Control*¹
 - Speaker Selection
-

Blu-ray Disc theatre

- Easy playback*³
 - Power on Link
 - Power off Link
 - Standby Power Save*²
 - Intelligent Auto Standby*^{2*4}
 - VIERA Link Control*¹
 - Speaker Selection
-

Amplifier

- Power off Link
 - Intelligent Auto Standby*²
 - Speaker Selection
-

*1 : For equipment which has “HDAVI Control 2 or later” function.

*2 : For equipment which has “HDAVI Control 4 or later” function.

*3 : While playing a disc

*4 : Except for watching a disc

■ VIERA Link Control of compatible equipment

The following is the maximum number of compatible equipment that can be controlled by VIERA Link Control. This includes connections to equipment already connected to the TV.

For example, DVD Player connected to Amplifier which is connected to the TV via an HDMI cable.

 → [Functions > VIERA Link "HDAVI Control™" > VIERA Link Control](#)

- Recorder:
Maximum 3
- Player:
Maximum 3 (DVD Player, Blu-ray Disc Player, HD Video Camera, LUMIX Camera, Digital Camera, Player theatre, Blu-ray Disc theatre, etc.)
- Audio system:
Maximum 1 (Player theatre, Blu-ray Disc theatre, Amplifier, etc.)
- Tuner:
Maximum 4 (Set top box, etc.)

Preparations

- Connect the equipment supporting VIERA Link.
- For details of VIERA Link connections
 → [Functions > VIERA Link "HDAVI Control™" > Summary of VIERA Link](#)
- Use a fully wired HDMI compliant cable.
- Set up the connected equipment. Read the manual of the equipment.
- Set [VIERA Link](#) to [On](#) in the Setup Menu.
- Set up the TV. After connection, turn the equipment on and then switch the TV on. Select the HDMI input from [Input Selection](#) with [AV](#) and make sure that an image is displayed correctly. (This setup should be done each time the following conditions occur.)
 - First time operation
 - Adding or reconnecting equipment
 - Changing setup

Easy playback

Automatic input switching - When the connected equipment is operated, the input mode is switched automatically.

Power on Link

Set [Power on Link](#) to [On](#) in [VIERA Link Settings](#) to use this function.

When the connected equipment is operated, the TV is automatically turned on. (Only when the TV is in Standby mode.)

Power off Link

Set [Power off Link](#) to [On](#) in [VIERA Link Settings](#) to use this function.

When the TV is set to Standby mode, the connected equipment is also automatically set to Standby.

- This function will work even if the TV enters Standby mode automatically by auto power standby function.

Standby Power Save

Set [Standby Power Save](#) to [On](#) in [VIERA Link Settings](#) to use this function.

The power consumption of the connected equipment in Standby mode is controlled higher or lower in synchronisation with the TV on / off state to reduce the consumption.

When the TV is set to Standby mode, the connected equipment is automatically set to Standby and the power consumption of the connected equipment is automatically minimised.

When the TV is turned on, the connected equipment is still in Standby mode, but the power consumption is increased to quickly start the connected equipment.

- This function is effective if the connected equipment can change the power consumption in Standby mode and is set to higher consumption.
- This function works when [Power off Link](#) is set to [On](#).

Intelligent Auto Standby

Set **Intelligent Auto Standby** to **On** in **VIERA Link Settings** to use this function.

When the TV is on, non-used connected equipment goes into Standby mode automatically to reduce the power consumption. For example, when the input mode is switched from HDMI or when **Speaker Selection** is changed to **TV** (except for watching a disc).

- This function may not work properly depending on the connected equipment. In this case, set to **Off**.

VIERA Link Control

You can control some functions of the connected equipment with this TV's remote control by pointing at the TV's signal receiver.

1. Display **Apps** with **APPS**.
2. Select **VIERA Link** and press **OK** to access.
3. Select **VIERA Link Control** and press **OK** to access.
4. Select one of the following items and press **OK** to access.

Recorder / Player / Home Cinema / Video Camera / LUMIX / Digital Camera / Other

(The menu of the accessed equipment is displayed. The input mode is changed automatically.)

- The displayed item may vary depending on the connected equipment.
 - **Home Cinema** means Player theatre, Blu-ray Disc theatre or Recorder theatre.
 - **Other** means Tuner set top box.
5. Follow the on-screen instructions to operate the menu of the equipment.
 - Confirm the remote control code is "73".



→ **Watching > External equipment > Operating with TV's remote control**

- To display the operation guide

OPTION

(If other manufacturers' product is accessed, Setup / Contents Selection menu may be displayed.)

- Available TV's remote control buttons depend on the connected equipment.

■ If multiple recorders or players are connected

Each recorder / player is numbered. The number is given from the TV's lower number of HDMI terminal connected to the same type of equipment. For example, when two recorders are connected to HDMI2 and HDMI3, the recorder connected to HDMI2 is displayed as **Recorder1**, and the recorder connected to HDMI3 is displayed as **Recorder2**.

■ If you access non-VIERA Link equipment

The type of the connected equipment is displayed. Although you can access the connected equipment, you cannot operate it. Use the remote control of the connected equipment.

= Note =

- If you cannot operate the equipment, check the settings and the equipment.

 → [Functions > VIERA Link "HDAVI Control™" > Summary of VIERA Link](#)

- Some operations may not be available depending on the equipment. In this case, use the remote control of the connected equipment.
- For details of the operations for the connected equipment, read the manual of the equipment.

Speaker Selection

You can control the theatre speaker with this TV's remote control by pointing at the TV's signal receiver.

1. Display **Apps** with **APPS**.
2. Select **VIERA Link** and press **OK** to access.
3. Select **Speaker Selection** and press **OK** to access.
4. Select **TV / Home Cinema** and press **OK** to set.

TV:

TV speakers are active.

Home Cinema:

The sound is delivered from theatre speakers. Player theatre, Blu-ray Disc theatre or Amplifier will be automatically turned on if it is in Standby mode.

- The sound of TV speakers is mute. When the equipment is turned off, TV speakers will be activated.
- You can use **Volume Up / Down** and **MUTE**.



■ Multi-channel sound

If you want to enjoy the multi-channel sound (e.g. Dolby Audio (Dolby Digital) 5.1ch) via an Amplifier, connect it with an HDMI cable and Optical digital audio cable, and then select **Home Cinema**. If your Amplifier has the "HDAVI Control 5" function, you only need to connect it with an HDMI cable to the TV's HDMI2 terminal.

To enjoy multi-channel sound from DIGA Recorder, connect an HDMI cable from the DIGA Recorder to the Amplifier.

= Note =

- If you cannot operate the equipment, check the settings and the equipment.

 → [Functions > VIERA Link "HDAVI Control™" > Summary of VIERA Link](#)

- Some operations may not be available depending on the equipment.

Note

- These functions may not work properly depending on the connected equipment.
- Image or sound may not be delivered for the first few seconds when the input mode is switched.
- “HDAVI Control 5” is the newest standard for HDAVI Control compatible equipment. This standard is compatible with conventional HDAVI equipment.
- To confirm the HDAVI Control version of this TV



→ [Support](#) > [Help menu](#) > [Using Help menu](#)





Child Lock

Using Child Lock

You can lock specific channels / AV input terminals to restrict access to them. When the locked channel / input is selected, a message appears. Enter the PIN number to watch.

1. Display the menu with **MENU**.
2. Select **Setup** > **Child Lock** and press **OK** to access.
3. Enter the PIN number (4 digits) with **Numeric buttons**.



- Enter the PIN number twice at first setting.
 - Make a note of the PIN number in case you forget it.
4. Select **Child Lock List** and press **OK** to access.
 5. Select the channel / input and press **OK** to lock.
 -  appears when the channel / input is locked.
 - To cancel
 - 1) Select the locked channel / input.
 - 2) Press **OK**.
 - To lock all
 -  (green)
 - To cancel all locks
 -  (yellow)
 - To jump to the head of the next channel / input group
 -  (blue)

■ Show Adult App

Set to **Off** to lock specific applications to restrict access to them (if available).

= Note =

- For internet content

■ Freesat Adult Channels

Select [Hide](#) to hide channels of the adult genre in EPG and banner. All the timer events of the adult genre are cancelled.

= Note =

- For Freesat

■ Player PIN Control

Applies access control for some Digital TV streaming services.

= Note =

- For DVB (UK only)

PIN number

You can change the PIN number.

1. Select [Change PIN](#) and press **OK** to access.
2. Enter a new PIN number twice with **Numeric buttons**.



= Note =

- Setting [Shipping Condition](#) erases the PIN number and all settings.

Parental Rating

To watch the DVB programme that has rating information on the selected age, enter the PIN number (depending on the broadcaster).

1. Select **Parental Rating** and press **OK** to access.
2. Select an age for the restriction of programmes and press **OK** to set.

= Note =

- Setting **Shipping Condition** erases the PIN number and all settings.
- Ireland only

Data Service Application

Using Data Service Application

- Data Service Applications is not effective on MHEG.

You can enjoy Hybrid Broadcast Broadband TV application that may be provided via digital broadcasting as interactive data services.







1. Display the menu with **MENU**.
2. Select **Setup > Data Service Application > Service** and press **OK** to access.
3. Select **Auto Start / Manual Start / Off** for each channel.

Auto Start:

Automatically starts the application.

Manual Start:

Starts the application by pressing  (red).

- To sort channel names in alphabetical order
 (red)
 - To set **Auto Start** for all channels
 (green)
 - To disable the service for all channels
 (yellow)
 - To set **Manual Start** for all channels
 (blue)
4. Press **BACK/RETURN** to store.
 - A notification message will appear when the application is available. Follow the on-screen instructions.
 -  is displayed on the information banner if the programme has Hybrid Broadcast Broadband TV application.
 -  → **Watching > Basic > Freeview Play banner (UK)**
 -  → **Watching > Basic > Information banner**
 - To terminate the running application. (The default application may start immediately.)

EXIT

Privacy Setting

1. Display the menu with **MENU**.
2. Select **Setup > Data Service Application > Privacy Setting** and press **OK** to access.
3. Select **Low / High / Custom** and press **OK** to set.

■ To change the privacy settings manually

You can set up the detailed privacy settings when **Privacy Setting** is set to **Custom**.

Store Cookie

(On / Off)

Enables storing the technical information that a data service application leaves into the TV in order to recognise to use it again.

Delete Cookie

Deletes all of technical information left by a data service application.

Do Not Track Setting

(Mode1 / Mode2 / Mode3)

Sets to notify websites and some applications about tracking your browsing activities.

Mode1:

Notifies websites that you want to be tracked.

Mode2:

Notifies websites that you do not want to be tracked.

Mode3:

Sends no configuration information about tracking.

Allow Unique Device ID

(On / Off)

Sends identifying ID of this TV for the data service application.

Reset Unique Device ID

Resets the identifying ID of this TV.

Note

- Data Service Applications is not effective on MHEG.
- A broadband network environment is required to fully use Hybrid Broadcast Broadband TV application. Ensure the network connections and network settings are completed.

 → Network > Network connections

 → Network > Network settings

- Not all the data services are available depending on the country, area and broadcaster.
- Not valid in multi window mode
- Depending on the connection environment, the internet connection may be slow or may not be successful.
- Operations may vary depending on the broadcaster. Follow the on-screen instructions.
- On-screen instructions may not correspond to the remote control buttons.

Common Interface

Caution

If the encrypted message is displayed on the screen, the correct Common Interface (CI) Module and smart card that are required for this service are not inserted.

■ How to insert CI module and smart card

- Turn the TV off with Mains Power On / Off switch whenever inserting or removing the CI module.
- Depending on the model, it may be necessary to remove the terminal cover / cable cover before inserting or removing the CI module.
- If a smart card and a CI module come as a set, first insert the CI module, then insert the smart card into the CI module.
- Insert or remove the CI module completely in the correct direction as shown.

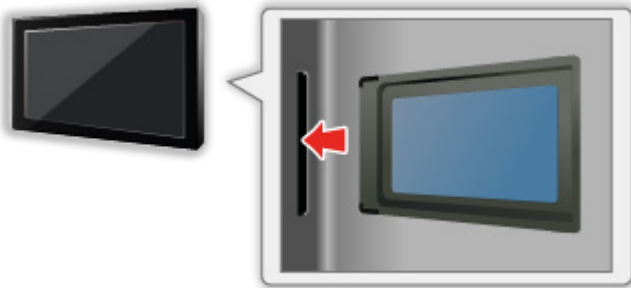

- Remove the CI module from the TV when placing the TV facing upward. This may cause damages to the CI module and CI slot.

= Note =

- There might be some CI modules in the market with older firmware versions that do not work fully interoperable with this new CI+ v1.3 TV. In this case, please contact your content provider.

Using Common Interface

The Common Interface Module menu provides access to software contained in Common Interface (CI) Modules.

- Video and audio signals may not be output depending on the broadcast or service.

■ Insert the CI module (optional)

- Follow the instructions that came with the viewing card to tune in the encrypted channels. If encrypted channels do not appear, perform the below to verify the card is recognised by the TV.
 - For details, read the manual of the CI module, or check with the content provider.
1. Select **DVB** with **TV**.
 2. Display the menu with **MENU**.
 3. Select **Setup** > **System Menu** > **Common Interface** and press **OK** to access.
 4. Press **OK** and follow the on-screen instructions.
 - On-screen instructions may not correspond to the remote control buttons.

Shipping Condition

Shipping Condition

Resets the TV to its original condition (i.e. no channels tuned in).

All settings other than [USB Device Setup](#) are reset (channels, picture, sound settings, etc.).

1. Display the menu with **MENU**.
2. Select [Setup](#) > [System Menu](#) > [Shipping Condition](#) and press **OK** to access.
3. When a confirmation screen is displayed, select [Yes](#) and press **OK** to set.
4. Follow the on-screen instructions.
 - [Auto Setup](#) automatically starts.

= Note =

- To retune TV channels only (e.g. after moving house), set [Auto Setup](#).

 → [Watching > Tuning and editing channels > Auto Setup](#)

Updating the TV Software

Information

A new version of software may be released for download to enhance the performance or operations of the TV.

In DVB, a notification banner will appear when one of the BBC channels is turned to if a new available software is found.

- To install new software, select **Standby / Now** and press **OK** to set.

Standby:

Installs new software in standby condition.

Now:

Installs new software now.

Auto update

You can update new software automatically.

1. Display the menu with **MENU**.
2. Select [Setup](#) > [System Menu](#) > [System Update](#) > [Auto Update Search in Standby](#) and press **OK** to access.
3. Select [On](#) and press **OK** to set.
 - If any software updates are available, a notification message will appear. To install new software, select [Standby / Now](#) and press **OK** to set.

[Standby:](#)

Installs new software in standby condition.

[Now:](#)

Installs new software now.

- If System Update is performed, the software will be updated (TV functions may be changed). If you do not want to do so, set [Auto Update Search in Standby](#) to [Off](#).
- The automatic updating cannot be performed in the following conditions:
 - TV turned off with Mains Power On / Off switch
 - Recording is in progress.

= Note =

- Download may take a few hours.
- During software download and update, DO NOT perform any operations on the TV or switch Off the TV.

Manual update

You can update new software manually.

1. Display the menu with **MENU**.
2. Select **Setup > System Menu > System Update > System Update Search Now** and press **OK** to access.
3. Searches for an update (for several minutes) and displays a corresponding message if any.
4. Download with **OK**.

= Note =

- Download may take a few hours.
- During software download and update, DO NOT perform any operations on the TV or switch Off the TV.

Setting characters

Using Numeric buttons

You can enter characters for free input items using **Numeric buttons**.

Press **Numeric buttons** repeatedly until you reach the desired character.

1 : . @ / 1 ! : # + - * _ () " ' % & ? , ; = \$ [] ~ < > { } | ` ^ \

2 : a b c 2 A B C

3 : d e f 3 D E F

4 : g h i 4 G H I

5 : j k l 5 J K L

6 : m n o 6 M N O

7 : p q r s 7 P Q R S

8 : t u v 8 T U V

9 : w x y z 9 W X Y Z

0 : Space 0

- The character is set automatically if you leave for 1 second.
- You can also set the character pressing **OK** or other **Numeric buttons** less than 1 second.
- The characters may vary depending on the input item.

Bluetooth devices

Bluetooth Setup

You can use Bluetooth keyboards* and mouse* with this TV by setting [Bluetooth Setup](#) in the Setup Menu.

*: HID (Human Interface Device Profile) compliant keyboards / mouse can be used.

1. Display the menu with **MENU**.
 2. Select [Setup](#) > [Bluetooth Setup](#) > [Devices](#) and press **OK** to access.
-

Devices

Searches the available device and displays the status.

- Place the device within 50 cm from the TV while registration is in progress.
- Turn the device on for registering. The setup for registration may be required depending on the device. Read the manual of the device.

Not paired:

The device is not registered. Register the device by following the on-screen instructions to use with this TV.

Connected:

The device is registered and you can use with this TV.

Not connected:

The device is already registered, but not connected to this TV. Check the device is turned on and set within the available range.

- This setup is not designed for Touch Pad Controller supporting Bluetooth wireless technology.

Keyboard

Keyboard

- Keyboards requiring the drivers are not supported.
- To change the language type, set [Keyboard Layout](#).
 - 1) Display the menu with **MENU**.
 - 2) Select [Setup](#) > [System Menu](#) > [Keyboard Layout](#) and press **OK** to access.
 - 3) Select the language and press **OK** to set.
- Characters may not be displayed correctly on the TV screen depending on the connected keyboard or the keyboard layout setting.
- Some of the keys of keyboards may correspond to the operation of the remote control.

Keyboard	Remote Control
↑ / ↓ / ← / →	△ / ▽ / ◀ / ▶
Enter	OK
Backspace	BACK/RETURN
Esc	EXIT
0 - 9 / Character	Numeric buttons
F1	HOME
F2	APPS
F3	MENU
F4	AV
F5 / F6	Channel Down / Up
F7 / F8	Volume Down / Up
F9 / F10 / F11 / F12	Coloured buttons

Settings

Setting menu

How to use

Various menus allow you to make settings for the picture, sound, and other functions.

1. Display the menu with **MENU**.
 - Displayed items vary depending on the input signal.
 2. Select the menu and press **OK** to access.
 3. Select the items and press **OK** to access.
 - Only available items can be selected.
 - You can also access from **eHELP** pressing  (red) at each item (if available).
- You can select from among alternatives with \triangle / ∇ and press **OK** to set.
 - You can adjust using the slide bar with $\triangleleft / \triangleright$ and press **OK** to set.
 - You can go to the next screen with **OK**.
 - You can enter names or numbers freely for some items.
 - 1) Enter characters one by one with **Cursor buttons** and press **OK** to set.



- You can set characters using **Numeric buttons**.



 → [Functions > Setting characters > Using Numeric buttons](#)

- 2) Press **BACK/RETURN** to store.

- To reset the settings
 - To initialise picture or sound settings only, select [Reset to Defaults](#) in the Picture Menu or Sound Menu.
 - To initialise all settings, select [Shipping Condition](#).

 → [Functions > Shipping Condition](#)

- To exit the menu screen

EXIT

- To return to the previous screen

BACK/RETURN

= Note =

- Menu items and selectable options vary depending on the mode (TV mode, Media Player, Network services, etc.).
- Some settings in Picture menu may also affect the menu screen when watching content in 4K format.
- If **Demo Settings** is displayed in the Setup Menu, the TV is in “Shop” viewing environment. To return to “Home” viewing environment, initialise all settings by accessing **Shipping Condition**.

 → **Functions > Shipping Condition**

■ Using control panel buttons

1. Press and hold INPUT/OK/HOLD for MENU button for 3 seconds to display the menu.
2. Select and set with following control panel buttons.
 - Move the cursor / select from a range of options / select the menu item / adjust levels

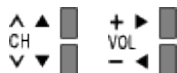

- Access the menu / store settings after adjustments have been made or options have been set with INPUT/OK/HOLD for MENU button

Picture

Viewing Mode

Selects your favourite picture mode for each input.

 → [Watching](#) > [For best picture](#) > [Viewing Mode](#)

Basic settings

[Luminance Level](#), [Contrast](#), [Brightness](#), [Colour](#), [Tint](#), [Sharpness](#)

Adjusts the levels of these options according to your personal preference.

 → [Watching](#) > [For best picture](#) > [Basic settings](#)

Colour Temperature

Sets the overall colour tone of the picture (bluer - redder).

 → [Watching](#) > [For best picture](#) > [Basic settings](#)

Vivid Colour

Automatically adjusts colours to vivid ones.

 → [Watching](#) > [For best picture](#) > [Basic settings](#)

Colour Remaster

Displays the vivid images with the expanded colour gamut.

 → [Watching](#) > [For best picture](#) > [Basic settings](#)

Rec.2020 Colour Remaster

Displays the vivid images with the suitable colour gamut.

 → [Watching](#) > [For best picture](#) > [Basic settings](#)

Reversal Film Effect

Provides the picture effect such as the reversal film for photo content.

 → [Watching](#) > [For best picture](#) > [Basic settings](#)

Resolution Remaster

Enhances picture resolution to make the image sharper.

 → [Watching](#) > [For best picture](#) > [Basic settings](#)

Dynamic Range Remaster

Enhances bright areas of the image closer to the original luminance making improved picture impact.

 → [Watching](#) > [For best picture](#) > [Basic settings](#)

Intelligent Frame Creation

Automatically compensates the picture frame rate and removes juddering movements to make the images smooth.

 → [Watching](#) > [For best picture](#) > [Basic settings](#)

Clear Motion

Makes the blurring image clearer such as when [Game Mode](#) is set, etc.

 → [Watching](#) > [For best picture](#) > [Basic settings](#)

Ambient Sensor

Automatic Brightness Control function

Adjusts picture settings automatically depending on ambient lighting condition.

 → [Watching](#) > [For best picture](#) > [Ambient Sensor](#)

Noise reduction settings

Noise Reduction

Reduces unwanted picture noise.

 → [Watching > For best picture > Noise reduction settings](#)

MPEG Remaster

Reduces flicker noise in contoured parts of a picture and block noise.

 → [Watching > For best picture > Noise reduction settings](#)

Advanced Settings

You can adjust and set up the detailed picture settings.

 → [Watching](#) > [For best picture](#) > [Advanced Settings](#)

Option Settings

Some features are not available on all models. Available menu items are displayed on your TV screen.

Game Mode

Provides suitable images for fast response signals when playing games.

 → Watching > For best picture > Option Settings

Film Cadence Mode

Improves vertical resolution for movie images.

 → Watching > For best picture > Option Settings

1080p Pure Direct

Reproduces the original image quality in detail for 1080p (HDMI) input signal.

 → Watching > For best picture > Option Settings

4K Pure Direct

Reproduces the original image quality in detail for 4K (HDMI) input signal.

 → Watching > For best picture > Option Settings

1080p Pixel by 4pixels

Displays like pixel by pixel to make the image sharper for 1080p signal.

 → Watching > For best picture > Option Settings

HDMI Content Type

Adjusts the picture settings of each HDMI input according to the selected content type.

 → Watching > For best picture > Option Settings

HDMI EOTF Type

Selects the EOTF type for each HDMI input. Set to **Auto** for general use.

 → Watching > For best picture > Option Settings

EOTF Type

Selects the EOTF type of broadcast or video content.

It works correctly only when the signal corresponds the each EOTF type. Set to [Auto](#) for general use.

- Automatically switches to [Auto](#) for broadcast each time another input / channel is selected.

 → [Watching](#) > [For best picture](#) > [Option Settings](#)

HDMI Colorimetry Type

Selects the colourimetry type for each HDMI input.

 → [Watching](#) > [For best picture](#) > [Option Settings](#)

HDMI RGB Range

Adjusts the black level of the image for each HDMI input.

 → [Watching](#) > [For best picture](#) > [Option Settings](#)

HDMI YCbCr Range

Adjusts the black level of the image in the YCbCr signal for each HDMI input.

 → [Watching](#) > [For best picture](#) > [Option Settings](#)

3D-COMB

Makes still or slow moving pictures more vivid.

 → [Watching](#) > [For best picture](#) > [Option Settings](#)

Screen Settings

16:9 Overscan

Selects the screen area displaying the image for 16:9 aspect.

 → [Watching](#) > [For best picture](#) > [Screen Settings](#)

Zoom Adjustments

Adjusts the vertical position and size when aspect is set to [Zoom](#).

 → [Watching](#) > [For best picture](#) > [Screen Settings](#)

Screen Display

Turns the screen off when you select [Off](#).

 → [Watching](#) > [For best picture](#) > [Screen Settings](#)

Pixel Orbiter

Sets the pixel shifting of the image to prevent panel “image retention”.

 → [Watching](#) > [For best picture](#) > [Screen Settings](#)

Panel Maintenance

Turns the screen off and perform the maintenance to prevent the panel “image retention”.

 → [Watching](#) > [For best picture](#) > [Screen Settings](#)

Panel Maintenance Message

Enables to display the regular panel maintenance notification.

 → [Watching](#) > [For best picture](#) > [Screen Settings](#)

Lock Settings

Locks the settings of [Professional1 / 2](#) for each input.

 → [Watching](#) > [For best picture](#) > [Lock Settings](#)

Copy Adjustment

Copies the picture settings of [True Cinema](#), [Custom](#), [Professional1](#) or [Professional2](#) to those of the other input mode or Viewing Mode.

 → [Watching](#) > [For best picture](#) > [Copy Adjustment](#)

Reset to Defaults

Resets the current Picture Viewing Mode to the default settings.

Sound

Mode

Selects your favourite sound mode for each input.

 → [Watching](#) > [For best audio](#) > [Sound mode](#)

Basic settings

Bass

Adjusts level to enhance or minimise lower, deeper sound output.

 → [Watching](#) > [For best audio](#) > [Basic settings](#)

Treble

Adjusts level to enhance or minimise sharper, higher sound output.

 → [Watching](#) > [For best audio](#) > [Basic settings](#)

Equaliser

Adjusts the frequency level to suit your favourite sound quality.

 → [Watching](#) > [For best audio](#) > [Basic settings](#)

Balance

Adjusts volume level of right and left speakers.

 → [Watching](#) > [For best audio](#) > [Basic settings](#)

Surround

Selects surround sound settings.

 → [Watching](#) > [For best audio](#) > [Basic settings](#)

Bass Boost

Enhances the effect of bass sounds.

 → [Watching](#) > [For best audio](#) > [Basic settings](#)

Volume settings

Speaker Selection

Enables controlling the theatre speaker with this TV's remote control by pointing at the TV's signal receiver.

 → [Watching](#) > [For best audio](#) > [Volume settings](#)

TV Speaker Setting

Selects the sound output to adjust volume.

 → [Watching](#) > [For best audio](#) > [Volume settings](#)

Headphone Volume

Adjusts the volume of headphones.

 → [Watching](#) > [For best audio](#) > [Volume settings](#)

Auto Gain Control

Automatically regulates large sound level differences between channels and inputs.

 → [Watching](#) > [For best audio](#) > [Volume settings](#)

Volume Correction

Adjusts the volume of each individual channel or input mode.

 → [Watching](#) > [For best audio](#) > [Volume settings](#)

Clear Sound Adjustment

If the sound from TV speakers is unclear due to installation environment, [On](#) is recommended.

 → [Watching](#) > [For best audio](#) > [Volume settings](#)

Voice Guidance Settings

Voice Guidance

Set to **On** to enable voice guidance of the basic features (on-screen messages, etc.) for visually impaired users.

 → [Watching > For best audio > Voice Guidance Settings](#)

Speed

Selects the readout speed for the voice guidance.

 → [Watching > For best audio > Voice Guidance Settings](#)

Volume

Selects the volume for the voice guidance.

 → [Watching > For best audio > Voice Guidance Settings](#)

User Level

Selects the level of verbosity for the voice guidance.

 → [Watching > For best audio > Voice Guidance Settings](#)

Web Browser

Set to **On** to enable voice guidance of the network content in web browser function.

 → [Watching > For best audio > Voice Guidance Settings](#)

Audio Description

Preferred Audio Type

Narration settings for visually impaired users

 → [Watching](#) > [For best audio](#) > [Audio Description](#)

Volume

Adjusts the volume for Audio Description.

 → [Watching](#) > [For best audio](#) > [Audio Description](#)

Speakers

Set to [Mix](#) to activate the description sound track from TV speakers.

 → [Watching](#) > [For best audio](#) > [Audio Description](#)

Headphones

Set to [Mix](#) to activate the description sound track from headphones.

 → [Watching](#) > [For best audio](#) > [Audio Description](#)

Advanced settings

NICAM

Near Instantaneous Companded Audio Multiplex

Reproduces NICAM stereo sound.

 → [Watching](#) > [For best audio](#) > [Advanced settings](#)

Audio Preference

Selects the initial setting for audio tracks.

 → [Watching](#) > [For best audio](#) > [Advanced settings](#)

SPDIF Selection

Selects the initial setting for digital audio output signal from DIGITAL AUDIO and HDMI2 (ARC function) terminals.

 → [Watching](#) > [For best audio](#) > [Advanced settings](#)

HDMI Audio Format

Selects the audio format for the HDMI input signal.

 → [Watching](#) > [For best audio](#) > [Advanced settings](#)

PCM Optical Level

Adjusts the audio level of PCM output from DIGITAL AUDIO and HDMI2 (ARC function) terminals to equalise with that of the other audio types.

 → [Watching](#) > [For best audio](#) > [Advanced settings](#)

SPDIF Delay

Adjusts the delay time of the sound output from DIGITAL AUDIO and HDMI2 (ARC function) terminals if the sound does not synchronise the image.

 → [Watching](#) > [For best audio](#) > [Advanced settings](#)

HDMI Input

Selects to fit the input signal.

 → [Watching](#) > [For best audio](#) > [Advanced settings](#)

Reset to Defaults

Resets the current Sound Mode to the default settings.

Network

Network Connection

Sets the network setting to use this TV in your network environment.

 → [Network](#) > [Network settings](#) > [Network Connection](#)

Network Status

Displays and checks the network status (MAC Address, current network settings, etc.).

 → [Network](#) > [Network settings](#) > [Network Status](#)

my Home Cloud Settings

Notices

Displays the terms of service.

 → [Network](#) > [Network settings](#) > [my Home Cloud Settings](#)

VIERA Name

Sets your favourite name for this TV.

 → [Network](#) > [Network settings](#) > [VIERA Name](#)

TV Remote App Settings

Sets to control the TV from network equipment (smartphone, etc.).

 → [Network](#) > [Network settings](#) > [TV Remote App Settings](#)

Network Link Settings

Sets to control the TV with devices connected to the network.

 → [Network](#) > [Network settings](#) > [Network Link Settings](#)

TV Anywhere Settings

You can set timer programming with the network equipment (smartphone, etc.) from outside the home network.

 → [Functions](#) > [TV Anywhere](#) > [How to use](#)

File Sharing Settings

File Sharing Server

Sets to share the files between PC and devices connected to this TV.

 → [Media Player > Using Media Player > Sharing file](#)

Network Device List

Lists the accessible network devices to play back the content in Media Player.

 → [Media Player > Using Media Player > Network device](#)

Mirroring Settings

Settings for the mirroring function

 → [Functions](#) > [Mirroring](#) > [Mirroring Settings](#)

Control4 Settings

Settings for the Control4 function

 → [Network](#) > [Network settings](#) > [Control4 Settings](#)

Other settings

Software Update

Checks for available software updates from the Panasonic website.

 → Network > Network settings > Software Update

New Software Message

Selects whether to give a notification message when new software is found via network or not.

 → Network > Network settings > New Software Message

Timer

Off Timer

Sets the duration of time until the TV automatically goes into Standby mode.

 → [Watching](#) > [Basic](#) > [Off Timer](#)

Timer Programming

Sets a timer to record forthcoming programmes.

 → [Recording > Timer Programming > Setting Timer Programming](#)

Time Zone

Adjusts the time data.

 → [Watching](#) > [Basic](#) > [Adjusting time](#)

Auto Standby

Automatically turns the TV to Standby mode for energy saving when no operation is performed for 4 hours.

 → [Watching > Basic > Energy saving functions](#)

No signal Power off

Automatically turns the TV to Standby mode to prevent unnecessary power consumption when no signal is received and no operation is performed for 10 minutes.

 → [Watching > Basic > Energy saving functions](#)

Setup

Eco Navigation

Automatically sets the TV to the most suitable energy-saving mode.

 → [Watching](#) > [Basic](#) > [Energy saving functions](#)

Voice Control Settings

Settings for Voice Control function

 → [Functions](#) > [Voice Control](#) > [Settings](#)

USB Device Setup

Formats the USB HDD or safely removes USB device.

 → [Recording > USB HDD setup > Setting for USB HDD](#)

Recording Setup

Settings for the recording feature of the USB HDD

 → Recording > Recording current programme > One Touch Recording

 → Recording > Recording current programme > Rewind LIVE TV

VIERA Touch Pad Controller

Pairing

Registers Touch Pad Controller (supplied) to this TV.

 → [Functions > Touch Pad Controller > Pairing](#)

Cursor Sensitivity

Adjusts the sensitivity of the cursor.

 → [Functions > Touch Pad Controller > Settings](#)

Operation Guide

Displays the operation guide of Touch Pad Controller.

 → [Functions > Touch Pad Controller > Settings](#)

Bluetooth Setup

Settings for the specific devices supporting Bluetooth wireless technology

 → [Functions](#) > [Bluetooth devices](#) > [Bluetooth Setup](#)

Child Lock

Applies access control for channels or inputs to prevent unwanted access.

 → [Functions](#) > [Child Lock](#) > [Using Child Lock](#)

Tuning Menu

Channel List Editor

Skips unwanted channels or edits channels.

 → [Watching](#) > [Tuning and editing channels](#) > [Channel List Editor](#)

Favourites Editor

Creates a list of favourite channels.

 → [Watching](#) > [Tuning and editing channels](#) > [Favourites Editor](#)

Regional Channel Edit

Replaces your regional channels with available channels from another region.

 → [Watching](#) > [Tuning and editing channels](#) > [Regional Channel Edit](#)

Auto Setup

Automatically searches for receivable channels.

 → [Watching](#) > [Tuning and editing channels](#) > [Auto Setup](#)

Channel Sorting by Region

Automatically sorts tuned channels according to the available region.

 → [Watching](#) > [Tuning and editing channels](#) > [Channel Sorting by Region](#)

Manual Tuning

Searches for channels manually.

 → [Watching](#) > [Tuning and editing channels](#) > [Manual Tuning](#)

Update Channel List

Updates the channel list while keeping your settings.

 → [Watching](#) > [Tuning and editing channels](#) > [Update Channel List](#)

New Channel Message

Selects whether to give a notification message when a new channel is found or not.

 → [Watching](#) > [Tuning and editing channels](#) > [Other settings](#)

Signal Condition

Checks the signal condition.

 → [Watching](#) > [Tuning and editing channels](#) > [Signal Condition](#)

Dual Tuner Mode

Set to **On** to use dual tuner function.

 → [Watching](#) > [Tuning and editing channels](#) > [Auto Setup](#)

Add New Channels

Adds new Other Satellite channels to the channel list.

 → [Watching](#) > [Tuning and editing channels](#) > [Add New Channels](#)

Add TV Signal

Adds the TV mode.

 → [Watching](#) > [Tuning and editing channels](#) > [Other settings](#)

= Note =

- The settings in [Tuning Menu](#) are applicable only for the selected TV mode. The menu name varies depending on the TV mode. ([Freesat Tuning Menu](#) / [DVB Tuning Menu](#) / [Analogue Tuning Menu](#) / [Other Sat. Tuning Menu](#) / [Satellite Tuning Menu](#))

Language

Preferred Multi Audio

Selects the preferred language for digital channel multi audio (depending on the broadcaster).

 → [Watching](#) > [Basic](#) > [Language](#)

Preferred Audio 1 / 2

Selects the first and second preferred language for digital channel multi audio (depending on the broadcaster).

 → [Watching](#) > [Basic](#) > [Language](#)

Preferred Subtitles 1 / 2

Selects the first and second preferred language for digital channel subtitles (depending on the broadcaster).

 → [Watching](#) > [Basic](#) > [Language](#)

Preferred Subtitles

Selects the preferred language for digital channel subtitles (depending on the broadcaster).

 → [Watching](#) > [Basic](#) > [Language](#)

Preferred Teletext

Selects the preferred language for digital channel teletext service (depending on the broadcaster).

 → [Watching](#) > [Basic](#) > [Language](#)

Display Settings

Preferred Subtitle Type

Selects the preferred subtitle type.

 → [Watching](#) > [Basic](#) > [Subtitle](#)

Teletext

Selects analogue teletext display mode.

 → [Watching](#) > [Teletext](#) > [Teletext mode](#)

Teletext Character Set

Selects teletext language font.

 → [Watching](#) > [Teletext](#) > [Teletext Character Set](#)

Input Labels

Accessing the input labels list allows you to change the input name or skip the input if unconnected, improving identification and selection in the [Input Selection](#) banner.

 → [Watching](#) > [External equipment](#) > [Watching external input](#)

Banner Display Timeout

Sets how long the information banner stays on screen.

 → [Watching](#) > [Basic](#) > [Freeview Play banner \(UK\)](#)

 → [Watching](#) > [Basic](#) > [Information banner](#)

Smart Banner

Displays the introduction banner for the internet service.

 → [Watching](#) > [Basic](#) > [Freeview Play banner \(UK\)](#)

 → [Watching](#) > [Basic](#) > [Information banner](#)

Playing Time Display

Set to [On](#) to display a time period of continuous use in Game Mode on the top right of the screen every 30 minutes.

 → [Watching](#) > [External equipment](#) > [Watching external input](#)

Radio Mode

Sets the timer for turning off the screen automatically when a radio channel is selected.

 → [Watching](#) > [Basic](#) > [Energy saving functions](#)

Info Frame at Power on

Displays Info Frame when the TV is turned on.

 → [Functions](#) > [Info Frame](#) > [Settings](#)

Notification

([On](#) / [Off](#))

Displays a notification message.

HDMI Auto Setting

Set to **Mode1** when the image or sound in HDMI input is not played properly.

 → [Watching > 4K resolution > HDMI Auto Setting](#)

HDMI HDR Setting

Set to **On** when the HDR device is connected to the TV.

 → [Watching](#) > [External equipment](#) > [HDMI HDR Setting](#)

VIERA Link Settings

VIERA Link

Sets to use VIERA Link functions.

 → [Functions > VIERA Link "HDAVI Control™" > Preparations](#)

Power on Link

Sets to use Power on Link functions.

 → [Functions > VIERA Link "HDAVI Control™" > Power on Link](#)

Power off Link

Sets to use Power off Link functions.

 → [Functions > VIERA Link "HDAVI Control™" > Power off Link](#)

Standby Power Save

Controls the connected equipment to reduce power consumption in Standby.

 → [Functions > VIERA Link "HDAVI Control™" > Standby Power Save](#)

Intelligent Auto Standby

Makes non-watched or non-used connected equipment go into Standby mode to reduce the power consumption.

 → [Functions > VIERA Link "HDAVI Control™" > Intelligent Auto Standby](#)

Data Service Application

Service

Sets to use Hybrid Broadcast Broadband TV application.

 → [Functions > Data Service Application > Using Data Service Application](#)

Privacy Setting

Settings for the privacy in the interactive data services

 → [Functions > Data Service Application > Privacy Setting](#)

System Menu

Keyboard Layout

Selects the language that your USB or Bluetooth Keyboard supports.

 → [Functions](#) > [Keyboard](#) > [Keyboard](#)

Shipping Condition

Resets all settings to the original condition.

 → [Functions](#) > [Shipping Condition](#) > [Shipping Condition](#)

Common Interface

Sets to watch encrypted channels, etc.

 → [Functions](#) > [Common Interface](#) > [Using Common Interface](#)

System Update

Downloads new software to this TV.

 → [Functions](#) > [Updating the TV Software](#) > [Auto update](#)

Licence Menu

Displays the software licence information.

Other Settings

Power on Channel List

Automatically selects all channels or favourites list in the information banner when the TV is turned on.

 → Watching > Basic > Selecting channel

Power Save

(On / Off)

Reduces brightness of the picture to economise on power consumption.

Support

Help menu

Using Help menu

1. Display the menu with **MENU**.
 2. Select **Help** and press **OK** to access.
 3. Select **About Firefox OS / TV Self Test / System Information / Device Information** and press **OK** to access.
-

[About Firefox OS](#)

Displays the information about Firefox OS.

[TV Self Test](#)

Makes a diagnosis of picture or sound problems.

Follow the on-screen instructions.

[System Information](#)

Displays the system information of this TV.

[Device Information](#)

Displays the device information of this TV.

FAQs

Picture

Before requesting service or assistance, please follow these simple guides to solve the problem. Also makes a diagnosis of picture problem in [TV Self Test](#).

 → [Support > Help menu > Using Help menu](#)

If the problem still persists, please contact your local Panasonic dealer for assistance.

Auto aspect

- Auto aspect is designed to provide you with the best ratio to fill the screen.

 → [Watching > For best picture > Aspect Control Signal](#)

- Press **ASPECT** if you want to change the aspect ratio manually.

 → [Watching > For best picture > Aspect](#)

Black and white picture

- Check that the output of the external equipment matches the input of the TV.
-

Chaotic image, noisy

- Set [Noise Reduction](#) and [MPEG Remaster](#) in the Picture Menu to remove noise.

 → [Watching > For best picture > Noise reduction settings](#)

- Check nearby electrical equipment (car, motorcycle, fluorescent lamp).
-

No image is displayed

- Check the correct input mode is selected.
- Check the setting of [AV \(COMPONENT / VIDEO\)](#) in [Input Selection](#) to match the signal being output by the external equipment.

 → [Watching > External equipment](#)

- Is [Luminance Level](#), [Contrast](#), [Brightness](#) or [Colour](#) in the Picture Menu set to the minimum?

 → [Watching > For best picture > Basic settings](#)

- Check all required cables and connections are firmly in place.

Blurry or distorted image (no sound or low volume)

- Reset channels.

 → [Watching > Tuning and editing channels > Auto Setup](#)

There may be a short black image

- A black image is displayed to avoid picture distortion when an input signal changes.
-

There may be white, red, blue, green and black spots on the screen

- This is a characteristic of the panels and is not a problem. The panel is built with very high precision technology giving you fine picture details. Occasionally, a few non-active pixels may appear on the screen as a fixed point of white, red, green, blue or black. Please note this does not affect the performance of the panel.
-

A white horizontal line appears in Standby mode

- A white horizontal line may appear on the screen for a while to adjust the panel. This is not a malfunction.

Digital TV

Before requesting service or assistance, please follow these simple guides to solve the problem.

If the problem still persists, please contact your local Panasonic dealer for assistance.

Block noise, frozen or disappearing image occurs / Some channels cannot be tuned

- Check the position, direction and connection of the aerial or dish.
- Check [Signal Condition](#). If the level of [Signal Quality](#) is low, the DVB signal is weak. Connecting the aerial to the TV directly may improve signal quality than connecting the aerial through the equipment (Set top box, DVD, etc.).

 → [Watching > Tuning and editing channels > Signal Condition](#)

 → [Watching > Basic > Basic connection](#)

- Weather conditions affect signal reception (heavy rain, snow, etc.), in particular in poor reception areas. Even during good weather, the high pressure can cause poor reception of some channels.
 - Due to the digital reception technologies involved, quality of the digital signals may be relatively low in some cases, despite good reception of analogue channels.
 - Turn the TV off with Mains Power On / Off switch, then turn it on again.
-

[Freesat Auto Setup](#) cannot be done completely

- Check connection and dish alignment. The dish needs to be pointing at Astra2 at 28.2 degrees east, and Eurobird1 at 28.5 degrees East.
 - If the problem persists, consult your freesat registered retailer or contact Freesat (UK) Ltd by visiting www.freesat.co.uk
-



[Faulty dish](#) message appears

- The satellite cable may be short-circuited or there may be connection problems of the cable. Check the cable and connection and then turn the TV off with Mains Power On / Off switch, and turn it on again.
 - If the message persists, consult a dish installer for checking the dish and cable.
-

No programmes shown on [TV Guide](#)

- Check the digital transmitter.
 - Check the aerial connection to the Television set and if there are any current signalling issues in your area.
 - Contact Panasonic Customer Support by visiting www.panasonic.co.uk/freeview
 - Contact the digital services provider to check for any local transmission issues by visiting www.freeview.co.uk
 - Consult an aerial engineer to check the alignment of your aerial.
-

Cannot find a channel you have previously watched

- The channel may broadcast for part of the day.
- Check the channel in the TV Guide.
 → [Watching > TV Guide](#)
- Channel position numbers may be changed by broadcasters.
- Reset channels.
 → [Watching > Tuning and editing channels > Auto Setup](#)

Analogue TV

Before requesting service or assistance, please follow these simple guides to solve the problem.

If the problem still persists, please contact your local Panasonic dealer for assistance.

White spots or shadow image (ghosting) occurs / Some channels cannot be tuned

- Check the position, direction and connection of the aerial.
- Weather conditions affect signal reception (heavy rain, snow, etc.), in particular in poor reception areas. Even during good weather, the high pressure can cause poor reception of some channels.
- Turn the TV off with Mains Power On / Off switch, then turn it on again.
- If the problem persists, consult your local dealer or service provider for the availability of services.





Sound

Before requesting service or assistance, please follow these simple guides to solve the problem. Also makes a diagnosis of sound problem in [TV Self Test](#).

 → [Support](#) > [Help menu](#) > [Using Help menu](#)

If the problem still persists, please contact your local Panasonic dealer for assistance.

No sound is produced

- Is “Sound mute” active? Press **MUTE** to switch sound mute on or off.
 - Is the volume set to the minimum?
 - Check connections and setting of external equipment.
 → [Watching](#) > [External equipment](#)
 - Ensure that [Speaker Selection](#) is set to [TV](#).
 → [Watching](#) > [For best audio](#) > [Volume settings](#)
 → [Functions](#) > [VIERA Link “HDAVI Control™”](#) > [Speaker Selection](#)
 - Ensure that [TV Speaker Setting](#) is set to [TV Speaker](#).
 → [Watching](#) > [For best audio](#) > [Volume settings](#)
 - Check the supplied external speaker is connected to the exclusive speaker terminal of the TV properly. ([EZ1002B series](#))
-

Sound level is low or sound is distorted

- Sound signal reception may be poor.
- Set [NICAM](#) in the Sound Menu to [Off](#). (Analogue)
 → [Watching](#) > [For best audio](#) > [Advanced settings](#)

HDMI

Before requesting service or assistance, please follow these simple guides to solve the problem.

If the problem still persists, please contact your local Panasonic dealer for assistance.

Sound is unusual

- Check the setting of **HDMI Audio Format** in the Sound Menu to match the audio signal from the connected equipment.

 → Watching > For best audio > Advanced settings

- Check the **HDMI Input** setting in the Sound Menu.

 → Watching > For best audio > Advanced settings

- If digital sound connection has a problem, select analogue sound connection.

 → Watching > External equipment > HDMI features

- Set **HDMI Auto Setting** in the Setup Menu to **Mode1**.

 → Watching > 4K resolution > HDMI Auto Setting

Pictures from external equipment are unusual when the equipment is connected via HDMI

- Check the HDMI cable is connected properly.

 → Watching > External equipment > External connection

- Turn the TV and equipment off, then turn them on again.

- Check an input signal from the equipment.

 → Watching > External equipment > Valid input signals

- Use equipment compliant with EIA/CEA-861/861D.

- Set **HDMI Auto Setting** in the Setup Menu to **Mode1**.

 → Watching > 4K resolution > HDMI Auto Setting

- The valid 4K format varies depending on the HDMI terminal.





 → Watching > 4K resolution > Valid 4K format

Network



Before requesting service or assistance, please follow these simple guides to solve the problem.

If the problem still persists, please contact your local Panasonic dealer for assistance.



Cannot connect to the network

- Check the LAN cable or wireless LAN is connected properly.
 → [Network > Network connections](#)
 - Check the connections and settings.
 → [Network > Network connections](#)
 → [Network > Network settings](#)
 - Check the network equipment and network environment.
 - The router may not be set to issue IP address automatically. If the network administrator prefers to allocate an IP address, set an IP address manually.
 → [Network > Network settings](#)
 - The router may be using MAC address filtering (security setting). Confirm the MAC Address of this TV and set the router to use it.
 → [Network > Network settings > Network Status](#)
 - If the problem persists, consult your Internet Service Provider or telecommunications company.
-

Cannot select the file during DLNA operations

- Is media server of the connected equipment prepared?
 → [Network > DLNA > In-House streaming](#)
 - Check applicable data format.
 → [Network > Supported format](#)
 - Check the settings of [Network Link Settings](#).
 → [Network > Network settings > Network Link Settings](#)
-

Cannot operate internet content

- Check the connections and settings.
 -  → Network > Network connections > Internet connection
 -  → Network > Network settings
- The server or connected line may be busy now.

Other

Before requesting service or assistance, please follow these simple guides to solve the problem.

If the problem still persists, please contact your local Panasonic dealer for assistance.

VIERA Link function does not work and an error message appears

- Check the connections.



→ [Functions > VIERA Link "HDAVI Control™" > Summary of VIERA Link](#)

- Turn the connected equipment on and then switch the TV on.



→ [Functions > VIERA Link "HDAVI Control™"](#)

Parts of the TV become hot

- Parts of the TV may become hot. These temperature rises do not pose any problems in terms of performance or quality.
-

Overcurrent error message appears

- The connected USB device may cause this error. Remove the device and turn the TV off with Mains Power On / Off switch, then turn it on again.
 - Check foreign objects are not inside the USB port.
-

An error message appears

- Follow the message's instructions.
 - If the problem persists, contact your local Panasonic dealer or the authorised service centre.
-

Touch Pad Controller does not work or cannot be registered

- Are the batteries installed correctly?
- The batteries may be running low. Replace them with new ones.
- Register again.

 → [Functions > Touch Pad Controller > Settings](#)

- Use Touch Pad Controller within approx. 3.2 m from the TV. (The range may be shortened depending on the obstacle between the TV and the controller, or the surrounding environment.)
-

Voice Control function does not work

- Voice Control function may not work properly depending on the pronunciation, noise and network environment.
- For details of the Voice Control function

 → [Functions > Voice Control](#)

LED does not turn to red in Standby mode

- LED turns to orange in Standby mode in the following conditions:
 - Recording is in progress.
 - [Timer Programming](#) is set.
 - [DLNA Server](#) is set to [On](#).
 - [Powered On by Apps](#) is set to [On](#).
 - [Home Streaming](#) is set to [Always](#).
 - [Powered On by Easy Mirroring](#) is set to [On](#).
 - [TV Anywhere](#) is set to [On](#).
 - LED turns to orange during adjustment of the panel (approx. 10 minutes to maximum 80 minutes). LED turns to orange again in standby mode when the TV is turned on / off before the panel adjustment is completed. (Be sure to turn the TV off with the remote control to adjust the panel.)
-

When pushed with a finger, the display panel moves slightly and makes a noise

- There is a little gap around the panel to prevent damage to the panel. This is not a malfunction.

Detailed information

Support information about the application, optional devices, operation, etc. may be found on the following website.

<http://panasonic.jp/support/global/cs/tv/> (English only)

Maintenance

Care and Cleaning

First, remove the mains plug from the mains socket.

■ Display panel, Cabinet, Pedestal

Regular care:

Gently wipe the surface of the display panel, cabinet, or pedestal by using a soft cloth to remove dirt or fingerprints.

For stubborn dirt:

- (1) First clean the dust from the surface.
- (2) Dampen a soft cloth with clean water or diluted neutral detergent (1 part detergent to 100 parts water).
- (3) Wring out the cloth firmly. (Please note, do not let liquid enter the TV inside as it may lead to product failure.)
- (4) Carefully wipe moisten and wipe away the stubborn dirt.
- (5) Finally, wipe away all the moisture.

= Caution =

- Do not use a hard cloth or rub the surface too hard, otherwise this may cause scratches on the surface.
- Take care not to subject the surfaces to insect repellent, solvent, thinner or other volatile substances. This may degrade surface quality or cause peeling of the paint.
- The surface of the display panel is specially treated and may be easily damaged. Take care not to tap or scratch the surface with your fingernail or other hard objects.
- Do not allow the cabinet and pedestal to make contact with a rubber or PVC substance for a long time. This may degrade surface quality.

■ Speaker (EZ1002B series)

Clean the speaker with a soft, dry cloth.

= Caution =

- When cleaning the speaker, use a fine cloth. Do not use tissues or other materials (towels, etc.) that can fall apart. Small grains may get stuck inside the speaker cover.
- Do not wipe the speaker net with a wet cloth.
- Never use alcohol, paint thinner or benzine to clean this speaker.
- Before using chemically-treated cloth, carefully read the instructions that came with the cloth.

■ Mains plug

- Wipe the mains plug with a dry cloth at regular intervals. Moisture and dust may lead to fire or electrical shock.

