

# Panasonic®

## Basic Operating Instructions

Digital Camera

Model No. **DMC-TZ100/DMC-TZ101**  
**DMC-TZ80/DMC-TZ81**

**LUMIX**



DMC-TZ100/DMC-TZ101



DMC-TZ80/DMC-TZ81

Please read these instructions carefully before using this product, and save this manual for future use.

More detailed operating instructions are available in “Operating Instructions for advanced features (PDF format)”. To read it, download it from the website. (→45)

Web Site: <http://www.panasonic.com>

Model number suffix “EB” denotes UK model.

**EB**

SQT1181-3  
M0116KZ3082

## Dear Customer,

We would like to take this opportunity to thank you for purchasing this Panasonic Digital Camera. Please read these Operating Instructions carefully and keep them handy for future reference. Please note that the actual controls and components, menu items, etc. of your Digital Camera may look somewhat different from those shown in the illustrations in these Operating Instructions.

### Carefully observe copyright laws.

- Recording of pre-recorded tapes or discs or other published or broadcast material for purposes other than your own private use may infringe copyright laws. Even for the purpose of private use, recording of certain material may be restricted.

## Information for Your Safety

### WARNING:

To reduce the risk of fire, electric shock or product damage,

- Do not expose this unit to rain, moisture, dripping or splashing.
- Use only the recommended accessories.
- Do not remove covers.
- Do not repair this unit by yourself. Refer servicing to qualified service personnel.

The socket outlet shall be installed near the equipment and shall be easily accessible.

### ■ Product identification marking

Product	Location
Digital camera	Bottom

## ■ About the AC adaptor (supplied)

### **CAUTION!**

To reduce the risk of fire, electric shock or product damage,

- Do not install or place this unit in a bookcase, built-in cabinet or in another confined space. Ensure this unit is well ventilated.
- The unit is in the standby condition when the AC adaptor is connected. The primary circuit is always “live” as long as the AC adaptor is connected to an electrical outlet.

## ■ About the battery pack

### **CAUTION**

- Danger of explosion if battery is incorrectly replaced. Replace only with the type recommended by the manufacturer.
- When disposing of the batteries, please contact your local authorities or dealer and ask for the correct method of disposal.
- Do not heat or expose to flame.
- Do not leave the battery(ies) in a car exposed to direct sunlight for a long period of time with doors and windows closed.
- Do not expose to low air pressure at high altitudes.
- Do not expose to extremely low air pressure, as this may result in explosions or leakage of flammable liquids and gases.

### **Warning**

Risk of fire, explosion and burns. Do not disassemble, heat above 60 °C or incinerate.

## ■ Cautions for Use

- Use a “High Speed HDMI micro cable” with the HDMI logo. Cables that do not comply with the HDMI standards will not work.  
“High Speed HDMI micro cable” (Type D-Type A plug, up to 2 m (6.6 feet) long)

### **Keep this unit as far away as possible from electromagnetic equipment (such as microwave ovens, TVs, video games etc.).**

- If you use this unit on top of or near a TV, the pictures and/or sound on this unit may be disrupted by electromagnetic wave radiation.
- Do not use this unit near cell phones because doing so may result in noise adversely affecting the pictures and/or sound.
- Recorded data may be damaged, or pictures may be distorted, by strong magnetic fields created by speakers or large motors.
- Electromagnetic wave radiation may adversely affect this unit, disturbing the pictures and/or sound.
- If this unit is adversely affected by electromagnetic equipment and stops functioning properly, turn this unit off and remove the battery or disconnect AC adaptor (supplied)/AC adaptor (DMW-AC10E: optional). Then reinsert the battery or reconnect AC adaptor and turn this unit on.

### **Do not use this unit near radio transmitters or high-voltage lines.**

- If you record near radio transmitters or high-voltage lines, the recorded pictures and/or sound may be adversely affected.

### Declaration of Conformity (DoC) for EU:

Hereby, “Panasonic Entertainment & Communication Co., Ltd.” declares that this product is in compliance with the essential requirements and other relevant provisions of Directive 2014/53/EU.

Customers can download a copy of the original DoC for our RE products from our DoC server:

<https://www.ptc.panasonic.eu/compliance-documents>

Importer for EU: Panasonic Marketing Europe GmbH

Authorized Representative in EU: Panasonic Testing Centre, Winsbergring 15, 22525 Hamburg, Germany

### Declaration of Conformity (DoC) for UK:

Hereby, “Panasonic Entertainment & Communication Co., Ltd.” declares that this product is in compliance with the essential requirements and other relevant provisions of the Radio Equipment Regulations 2017.

Customers can download a copy of the original DoC for our RE products from our DoC server:

<https://www.ptc.panasonic.eu/compliance-documents>

Importer for UK: Panasonic UK, a branch of Panasonic Marketing Europe GmbH  
Maxis 2, Western Road, Bracknell, Berkshire, RG12 1RT

### Wireless transmitter:

Frequency range used: 2412 MHz to 2462 MHz (Central frequency)

Max. output power: 13 dBm (EIRP)

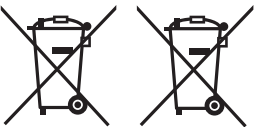

These symbols indicate separate collection of waste electrical and electronic equipment or waste batteries.

More detailed information is contained in “Operating Instructions for advanced features (PDF format)”.

# Contents



■ Information for Your Safety .....	2	<b>Playback</b>	
<b>Preparations</b>			
■ Before use .....	7	■ Viewing your pictures .....	36
■ Standard accessories .....	8	■ [Light Composition] .....	37
■ Names and Functions of Main Parts .....	9	<b>Wi-Fi</b>	
■ Inserting and removing the battery or SD memory card (optional).....	12	■ What you can do with the Wi-Fi® function .....	39
■ Charging the battery .....	13	■ Operating the camera by connecting it to a smartphone .....	40
■ Setting the clock .....	15	<b>Others</b>	
<b>Basics</b>		■ Downloading software .....	43
■ Basic operations .....	16	■ Reading the Operating Instructions (PDF format) .....	45
■ Setting the menu .....	23	■ List of monitor/viewfinder displays .....	47
<b>Recording</b>		■ Menu list.....	50
■ Taking pictures with automatic settings (Intelligent Auto Mode) .....	24	■ Q&A Troubleshooting .....	53
■ Recording 4K photos.....	25	■ Specifications.....	55
■ [Post Focus] .....	28	■ Digital Camera Accessory System .....	61
■ Recording motion pictures .....	31		
■ [4K Live Cropping] .....	34		

In this manual, examples use illustrations and screens of DMC-TZ100/DMC-TZ101 unless otherwise indicated.

## ■ About the symbols in the text

**MENU** Indicates that the menu can be set by pressing [MENU/SET] button.

In this Operating Instructions, steps for setting a menu item are described as follows:

**MENU** →  [Rec] → [Quality] → []

## Before use

### ■ Camera handling

- Keep the camera away from excessive vibration, force, or pressure.
- The camera is not dust resistant, splash resistant, or waterproof.  
Avoid using the camera in places with excessive dust or sand, or where water can come into contact with the camera.
- Do not allow camera to come into contact with pesticides or volatile substances (can cause surface damage or coating to peel).

### ■ Condensation (When the lens, the monitor or the viewfinder is fogged up)





- Condensation may occur when the camera is exposed to sudden changes of temperature or humidity. Avoid these conditions, which may make the lens, the monitor or the viewfinder dirty, cause mould, or damage the camera.
- If condensation does occur, turn off the camera and wait about two hours before using it. Once the camera adjusts to the surrounding temperature, the fogging will clear naturally.

### ■ Caring for your camera

- To clean your camera, remove the battery, the DC coupler (DMW-DCC11: optional) or a card, or disconnect the power plug from the outlet, and wipe with a soft, dry cloth.
- Do not press the monitor with excessive force.
- Do not press the lens with excessive force.
- Do not keep rubber or plastic products in contact with the camera for a long period of time.
- Do not use solvents such as benzine, thinner, alcohol, kitchen detergents, etc., to clean the camera, since it may deteriorate the external case or the coating may peel off.
- Do not leave the camera with the lens facing the sun, as rays of light from the sun may cause it to malfunction.
- Do not extend the supplied cord or cable.
- While the camera is accessing the card (for an operation such as picture writing, reading, deleting, or formatting), do not turn off the camera or remove the battery, card, AC adaptor (supplied)/AC adaptor (DMW-AC10E: optional) or DC coupler (DMW-DCC11: optional).
- The data on the card may be damaged or lost due to electromagnetic waves, static electricity or breakdown of the camera or the card. We recommend storing important data on a PC etc.
- Do not format the card on your PC or other equipment. Format it on the camera only to ensure proper operation.

## Standard accessories

Check that all the accessories are supplied before using the camera. Part numbers are as of January 2016. These may be subject to change.

<input type="checkbox"/> <b>Battery pack</b> DMW-BLG10E <ul style="list-style-type: none"> <li>• Charge the battery before use.</li> <li>• Battery pack is indicated as battery pack or battery in the text.</li> </ul> 	<input type="checkbox"/> <b>Hand strap</b> VFC4297 
<input type="checkbox"/> <b>AC adaptor</b> SAE0012F 	<input type="checkbox"/> <b>USB connection cable</b> K1HY04YY0106 
<input type="checkbox"/> <b>TZ100/TZ101</b> <b>Shoulder strap adaptor</b> (2) SYQ0694 	<ul style="list-style-type: none"> <li>• Use when attaching a shoulder strap (commercially available). For details, refer to "Operating Instructions for advanced features (PDF format)".</li> </ul>

- **Cards are optional.** (SD Memory Card, SDHC Memory Card and SDXC Memory Card are indicated as card in the text.)
  - This unit is compatible with UHS-I UHS Speed Class 3 standard SDHC/SDXC memory cards.
  - The following SD standard-based cards (Panasonic brand recommended) can be used. Operation has been confirmed when using a Panasonic brand card. SD Memory Card (512 MB to 2 GB)/SDHC Memory Card (4 GB to 32 GB)/SDXC Memory Card (48 GB to 128 GB)
  - Depending on recording conditions, the required card differs.
- Consult the dealer or your nearest Service Centre if you lose the supplied accessories. (You can purchase the accessories separately.)
- Please dispose of all packaging appropriately.
- **TZ100/TZ101**  
Keep the shoulder strap adaptors out of reach of children to prevent swallowing.
- The illustrations and screens in this manual may differ from the actual product.



# Names and Functions of Main Parts



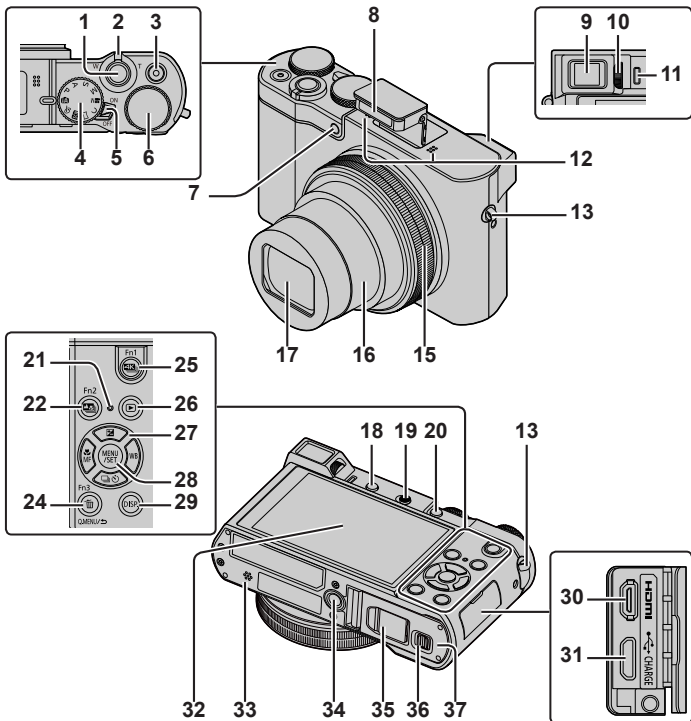

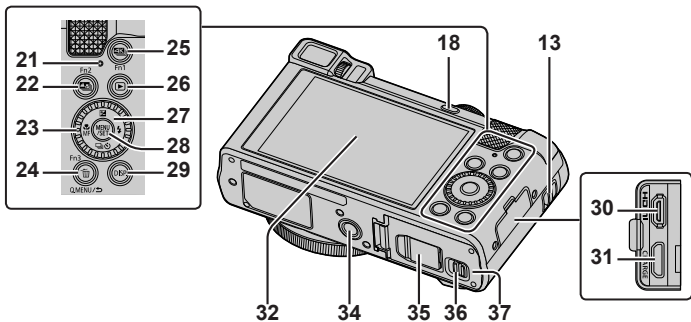
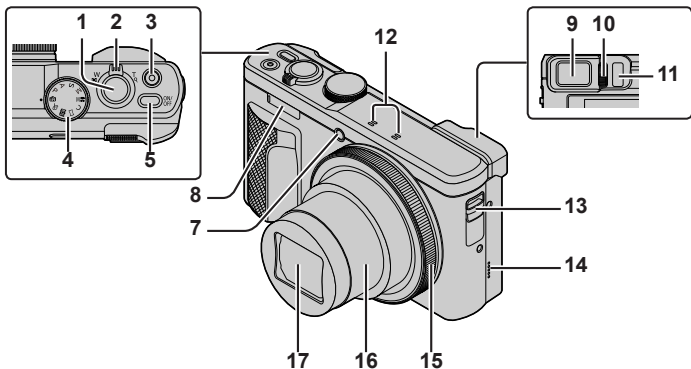

TZ100/TZ101



TZ80/TZ81



- 1 Shutter button (→17)
  - 2 Zoom lever (→16)
  - 3 Motion picture button (→32)
  - 4 Mode dial (→18)
  - 5 **TZ100/TZ101**  
Camera [ON/OFF] switch  
**TZ80/TZ81**  
Camera [ON/OFF] button
  - 6 **TZ100/TZ101**  
Rear dial (→21)
  - 7 Self-timer indicator/AF assist lamp
  - 8 Flash
  - 9 Viewfinder (→20, 47)
  - 10 Diopter adjustment dial
  - 11 Eye sensor (→20)
  - 12 Stereo microphone
  - 13 Strap eyelet
 

- To prevent dropping, be sure to attach the supplied strap and fit it to your wrist.
  - 14 **TZ80/TZ81**  
Speaker
  - 15 Control ring (→21)
  - 16 Lens barrel
  - 17 Lens
  - 18 [LVF] button (→20)/[Fn4] button
  - 19 **TZ100/TZ101**  
Flash open lever
  - 20 **TZ100/TZ101**  
[AF/AE LOCK] button
    - You can take pictures by locking the focus and/or exposure.
  - 21 Charging lamp (→13)/Wi-Fi® connection lamp
  - 22 [] ([Post Focus]) button (→28)/[Fn2] button
  - 23 **TZ80/TZ81**  
Control dial (→21)
  - 24 [] (Cancel) button/  
[] (Delete) button (→36)/  
[Fn3] button
    - You can easily call some of the menu items and set them during recording.
  - 25 [] (4K photo mode) button (→25)/  
[Fn1] button
  - 26 [] (Playback) button (→36)
  - 27 Cursor button (→19)
  - 28 [MENU/SET] button
  - 29 [DISP.] button
    - Use this to change display.
  - 30 [HDMI] socket
  - 31 [CHARGE] socket (→13)
  - 32 Touch screen (→22)/monitor (→47)
  - 33 **TZ100/TZ101**  
Speaker
  - 34 Tripod mount
    - Do not attach this unit to tripods that have screws with a length of 5.5 mm (0.22 inch) or more. Doing so may damage this unit or the unit may not be secured properly on the tripod.
  - 35 DC coupler cover (→61)
  - 36 Release lever (→12)
  - 37 Card/Battery door (→12)
- Always use the supplied AC adaptor or a genuine Panasonic AC adaptor (DMW-AC10E: optional). (→61)  
When using an AC adaptor (DMW-AC10E: optional), ensure that the Panasonic DC coupler (DMW-DCC11: optional) and AC adaptor (DMW-AC10E: optional) are used.
  - [Fn5] to [Fn9] (→19) are touch icons. They are displayed by touching the [] tab on the recording screen.

## Inserting and removing the battery or SD memory card (optional)

Make sure that the camera is turned off.

**1 Slide the release lever (A) to the [OPEN] position and open the card/battery door**

**2 Insert the battery and card, making sure that their orientation is correct**

- Battery: Insert the battery all the way firmly and check that it is locked by lever (B).
- Card: Insert the card all the way firmly until it clicks. Do not touch the terminals on the back of the card.

**3 Close the door**

Slide the release lever to the [LOCK] position.

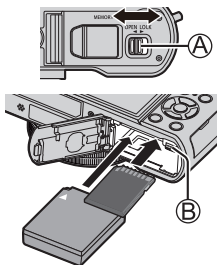

### ■ To remove

**• To remove battery:**

Move lever in direction of arrow.

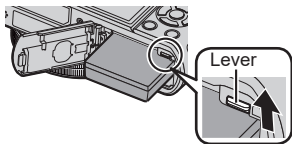

**• To remove card:**

Push the card until it clicks, then pull the card out.

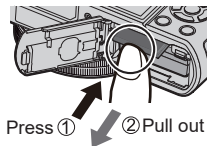

- Always use genuine Panasonic batteries (DMW-BLG10E).
- If you use other batteries, we cannot guarantee the quality of this product.
- Keep the Memory Card out of reach of children to prevent swallowing.
- We recommend using a Panasonic card.

## Charging the battery

- The battery that can be used with this unit is DMW-BLG10E.
- The battery is not charged when the camera is shipped. Charge the battery before use.
- We recommend charging in a location where the ambient temperature is between 10 °C and 30 °C (50 °F to 86 °F).

Make sure that the camera is turned off.

### 1 Insert the battery to this unit, and then connect this unit to the AC adaptor (supplied) (A) or a PC (B)

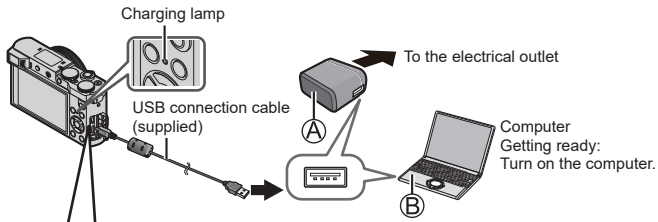

#### [CHARGE] socket

- This terminal is located at the bottom when the camera is in an upright position.

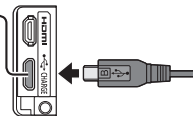

- Always check the direction of the pins and hold the plug straight to insert or remove it. (If the cable is inserted in the wrong direction, the pins could become deformed and cause faulty operation.) Also, do not insert into the wrong socket. Doing so may cause damage to this unit.

### ■ Charging lamp

**On:** Charging in progress

**Off:** Charging stops (After charging stops, disconnect the camera from the electrical outlet or your computer.)

**Flashing:** Charging error (→53)

### ■ Charging time (When using the AC adaptor (supplied))

Approx. 190 min.

- The battery is a rechargeable lithium ion battery. If the temperature is too high or too low, the operating time of the battery will become shorter.
- The battery becomes warm after using and during and after charging. The camera also becomes warm during use. This is not a malfunction.
- **Do not leave any metal items (such as clips) near the contact areas of the power plug or near the batteries.**
- Store the battery in a cool and dry place with a relatively stable temperature. (Recommended temperature: 15 °C to 25 °C (59 °F to 77 °F), Recommended humidity: 40%RH to 60%RH)
- **Do not store the battery for a long time while fully charged.** When storing the battery for a long period of time, we recommend charging it once a year. Remove the battery from the camera and store it again after it has completely discharged.
- Do not use any other USB connection cables except the supplied one.
- Do not use the AC adaptor (supplied) or the USB connection cable (supplied) with other devices.

## Setting the clock

The clock is not set when the camera is shipped.

- 1 Turn the camera on
- 2 Press [MENU/SET]
- 3 Press ◀▶ to select the items (year, month, day, hour, minute), and press ▲▼ to set
- 4 Press [MENU/SET]
- 5 When [The clock setting has been completed.] is displayed, press [MENU/SET]
- 6 When [Please set the home area] is displayed, press [MENU/SET]
- 7 Press ◀▶ to set your home area and press [MENU/SET]

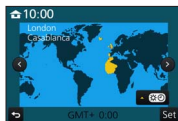
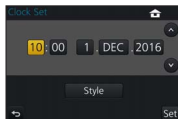

- You can change the clock setting with [Clock Set] in [Setup] menu.

## Basic operations

### Zoom lever (Use zoom)

Capture a wider area (wide-angle)  Enlarge the subject (telephoto)

### ■ Zoom types and use

#### Optical Zoom:

You can zoom in without degrading the picture quality.

**Maximum magnification:** TZ100/TZ101 10x

TZ80/TZ81 30x

#### Extra optical zoom:

This function works when picture sizes with [EX] have been selected in [Picture Size]. Extra optical zoom allows you to zoom in using a higher zoom ratio than optical zoom, without degrading the picture quality.

**Maximum magnification:** TZ100/TZ101 20x\*

TZ80/TZ81 61.2x\*

\* Including the optical zoom ratio. The maximum zoom ratio varies depending on the picture size.

#### [i.Zoom]:

You can use the camera's intelligent resolution technology to increase the zoom ratio up to 2x higher than the original zoom ratio with limited deterioration of picture quality.

#### [Digital Zoom]:

Zoom 4x further than Optical/Extra optical zoom. When [Digital Zoom] is used simultaneously with [i.Zoom], you can only increase the zoom ratio up to 2x. (TZ100/TZ80)

Zoom 2x further than Optical/Extra optical zoom when [i.Zoom] is set to [OFF]. When [i.Zoom] is set to [ON], [Digital Zoom] is cancelled. (TZ101/TZ81)

Note that, with Digital Zoom, enlarging will decrease picture quality.



## Shutter button (Taking pictures)

- Press the  button (▼) to set the drive mode to  ([Single]).

### 1 Press the shutter button halfway (press lightly) to focus on the subject

- The aperture value and shutter speed are displayed. (If the aperture value and shutter speed are shown in red and flashing, you do not have the appropriate exposure, unless you are using the flash.)



#### Focus display

(When focus is aligned: illuminated  
When focus is not aligned: flashing)

Shutter speed  
Aperture value



### 2 Press the shutter button fully (push the button all the way), and take the picture



- Pictures can be taken only when the image is correctly focused as long as the [Focus/Release Priority] is set to [FOCUS].
- Even during menu operation or picture playback, if you press the shutter button halfway, you can instantly set the camera ready for recording.

### ■ Estimated number of recordable pictures

TZ100/TZ101	TZ80/TZ81
720*1	800*2

\*1 (When [Aspect Ratio] is set to [3:2], [Quality] is set to , [Picture Size] is set to [L] (20M), and using a card of 8 GB)

\*2 (When [Aspect Ratio] is set to [4:3], [Quality] is set to , [Picture Size] is set to [L] (18M), and using a card of 8 GB)

## Mode dial (Select the recording mode)

### 1 Set to the desired recording mode

- Rotate the mode dial slowly to select the desired mode.

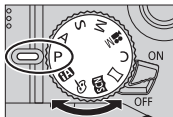

<b>iA</b>	<b>Intelligent Auto Mode (→24)</b> Take pictures with automatic settings.
<b>iA+</b>	<b>Intelligent Auto Plus Mode (→24)</b> Allow you to adjust the brightness (exposure) and colour hue as desired.
<b>P</b>	<b>Program AE Mode</b> Take pictures with automatic shutter speed and aperture value settings.
<b>A</b>	<b>Aperture-Priority AE Mode</b> Determine aperture, then take pictures.
<b>S</b>	<b>Shutter-Priority AE Mode</b> Determine shutter speed, then take pictures.
<b>M</b>	<b>Manual Exposure Mode</b> Determine aperture and shutter speed, then take pictures.
<b>iM</b>	<b>Creative Video Mode</b> Determine aperture and shutter speed, then record motion pictures. • You cannot take still pictures.
<b>C</b>	<b>Custom Mode</b> Take pictures using pre-registered settings.
<b>□</b>	<b>Panorama Shot Mode</b> Take panorama pictures.
<b>SCN</b>	<b>Scene Guide Mode</b> Take pictures that match the scene being recorded.
<b>☞</b>	<b>Creative Control Mode</b> Take pictures by selecting your preferred picture effect.

## Function buttons

- [Fn1] to [Fn4] are buttons on the camera.
- [Fn5] to [Fn9] are touch icons. They are displayed by touching the  tab on the recording screen.
- You can assign frequently-used functions to particular buttons with [Fn Button Set] in [Custom] menu.

## Cursor button

- This button is used to move the cursor on the menu screens and for other functions.
- In this manual, the button that is to be used is indicated by ▲ ▼ ◀ ▶.

You can perform the following operations while recording. (Some items or settings can not be selected depending on the mode or display style the camera is in.)

### (Exposure compensation) (▲)

- Corrects the exposure when there is a backlight or when the subject is too dark or too bright.

#### **TZ100/TZ101**

### [WB] (White balance) (▶)

- Adjusts the colour depending on the light source to ensure natural colour.

#### **TZ80/TZ81**

### (Flash mode) (▶)

- Changes flash mode.

### (Drive mode) (▼)

- [Burst]\*1
  - Records a burst of still pictures while you press the shutter button fully.
- [4K PHOTO]\*1 (→25)
  - Records 4K photo.
- [Auto Bracket]\*1
  - Records pictures with different exposure settings based on the exposure compensation range.
- [Self Timer]\*1

\*1 To cancel drive mode, select  ([Single]) or  ([Off]).

**[MF] (Focus mode) (◀)**

- [AF]
  - Focus is set automatically when the shutter button is pressed halfway.
- [AF👁] ([AF Macro])
  - You can take pictures of a subject as close as 5 cm (0.16 feet)\*<sup>2</sup>/3 cm (0.098 feet)\*<sup>3</sup> from the lens by rotating the zoom lever upmost to Wide (1x).
- [👁] ([Macro Zoom])
  - Use this setting to get close to the subject and then further enlarge when taking the picture. You can take a picture with the digital zoom up to 3x while maintaining the distance to the subject for the extreme Wide position (5 cm (0.16 feet)\*<sup>2</sup>/3 cm (0.098 feet)\*<sup>3</sup>).
- [MF]
  - Manual focus is convenient when you want to lock the focus to take pictures or when it is difficult to adjust focus using auto focus.

\*2 **TZ100/TZ101**

\*3 **TZ80/TZ81**

**[LVF] button**

**1 Press [LVF] button**



\* The eye sensor automatically switches the display to viewfinder when your eye or an object moves close to the viewfinder. When the eye or object moves away from the viewfinder, the camera returns to monitor display.

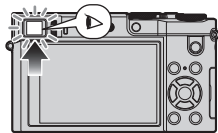

**TZ100/TZ101 Control ring/Rear dial**
**TZ80/TZ81 Control ring/Control dial**

You can perform frequently used operations and settings directly.

Items that can be set vary depending on recording modes. Following are the pre-assigned settings.

Mode dial	Control ring*1	TZ100/TZ101 Rear dial
		TZ80/TZ81 Control dial
[iA]	Step Zoom	—
[P]	Programme Shift	
[A]	Aperture adjustment	
[S]	Shutter speed adjustment	
[M]	Aperture adjustment*2	Shutter speed adjustment*2
[ ] / [ ]	Picture effects change	
[SCN]	Aperture adjustment*3 / Shutter speed adjustment*4	

\*1 When Manual Focus is set, the control ring is assigned to focus adjustment.

\*2 Press ▲ to switch between shutter speed adjustment and aperture adjustment.

\*3 The operation is possible only when the Scene Guide Mode is set to [Appetizing Food].

\*4 The operation is possible only when the Scene Guide Mode is set to [Artistic Nightscape].

- You can change to your preferred settings using [Ring/Dial Set] from the [Custom] menu. For details, refer to “Operating Instructions for advanced features (PDF format)”.

## Touch screen (Touch operations)

Touch screen of this unit is capacitive. Touch the panel directly with your bare finger.

### Touch

To touch and release the touch screen. Be sure to touch the centre of the desired icon.



### Drag

To touch and slide your finger across the touch screen. This can also be used to forward or rewind a picture during playback, etc.



### Pinch (spread/pinch)

On the touch screen, spread (pinch out) your 2 fingers to zoom in, and pinch (pinch in) your 2 fingers to zoom out.



## Setting the menu

You can use the menu to set camera and recording functions, operate playback functions, and perform other operations.

- The setting methods vary depending on the menu item.

- 1 Press [MENU/SET] to bring up the menu
- 2 Press ▲▼ to select the menu item and press [MENU/SET]
- 3 Press ▲▼ to select the setting and press [MENU/SET]



- 4 Press [Q.MENU/↵] button repeatedly until the recording or playback screen reappears

- During recording, the menu screen can also be exited by pressing the shutter button halfway.

### ■ Switching menu type

- ① Press ◀ after performing step 1 above
- ② Press ▲▼ to select a tab such as [🔧]
- ③ Press [MENU/SET]



### ■ Menu types (→50)

- [Rec]
- [Motion Picture]
- [Custom]
- [Setup]
- [Playback]

## Taking pictures with automatic settings

(Intelligent Auto Mode)

**Recording mode:**  

This mode is recommended for those who want to point and shoot as the camera optimises settings to match the subject and recording environment.

### 1 Set mode dial to









- The camera will switch to either the most recently used of Intelligent Auto Mode or Intelligent Auto Plus Mode.

### 2 Point the camera at the subject

- When the camera identifies the optimal scene, the icon for each scene turns blue for 2 seconds and then changes to the normal red indication.



## ■ Switching between Intelligent Auto Plus Mode and Intelligent Auto Mode

- ① Press [MENU/SET]
- ② Press 
- ③ Press   to select the  or  tab
- ④ Use  to select  or  and press [MENU/SET]
  - If [DISP.] button is pressed, the description of the selected mode will be displayed.





## Recording 4K photos

Recording mode: PASM

You can select the desired moment from a burst of 4K photos taken at 30 frames/second and save that moment as a picture of approx. 8 million pixels.

**Record a 4K photo** → **Select and save pictures** → **The picture is complete**

- To record pictures, use a UHS Speed Class 3 card.
- When recording 4K photos, the angle of view becomes narrower.

### 1 Press [] button

- The same operation can be performed by pressing the [] button (▼), using ◀▶ to select a 4K photo icon (() , etc.), and pressing ▲.

### 2 Press ◀▶ to select the recording method and press [MENU/SET]

- The recording method can also be set from [4K PHOTO] in the [Rec] menu.



[4K Burst]

#### For capturing the best shot of a fast-moving subject

Burst recording is performed while the shutter button is pressed and held. The shutter sound will be heard repeatedly.

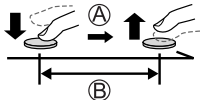

- Audio recording: None

- (A) Press and hold
- (B) Recording is performed

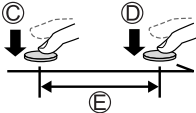

Continuous recording length:

Same as when recording motion pictures with their file size set to [4K] in [MP4] (→33)

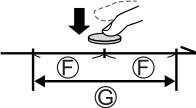
 <b>[4K Burst(S/S)]</b> "S/S" is an abbreviation of "Start/Stop".	<p><b>For capturing unpredictable photo opportunities</b></p> <p>Burst recording starts when the shutter button is pressed and stops when pressed again. Start and stop tones will be heard.</p> <ul style="list-style-type: none"> <li>• Audio recording: Available*</li> </ul> <p>           (C) Start (First)            (D) Stop (Second)            (E) Recording is performed         </p>  <p>Continuous recording length: Same as when recording motion pictures with their file size set to [4K] in [MP4] (→33)</p>
 <b>[4K Pre-Burst]</b>	<p><b>For recording as needed whenever a photo opportunity arises</b></p> <p>Burst recording is performed for approximately 1 second before and after the moment that the shutter button is pressed. The shutter sound will be heard only once.</p> <ul style="list-style-type: none"> <li>• Audio recording: None</li> </ul> <p>           (F) Approximately 1 second            (G) Recording is performed         </p>  <p>Recording length: Approximately 2 seconds</p>

\* Audio is not played back when you perform playback with the camera.

### 3 Record a 4K photo

- When you perform 4K burst photo recording, a 4K burst file will be saved in the MP4 format.
- When [Auto Review] is enabled, the picture selection screen will be displayed automatically.
- When using [Light Composition] (→37), it is recommended to use a tripod or use a smartphone instead of the shutter and do remote recording (→42) to control camera shaking.

- If the surrounding temperature is high, or 4K photos are recorded continuously, or the temperature of the camera rises, [△] may be displayed and recording may be stopped halfway through to protect the camera. Wait until the camera cools down.
- When [4K PRE] ([4K Pre-Burst]) is set, the battery drains faster and the camera temperature rises. Select [4K PRE] ([4K Pre-Burst]) only when recording.

## Selecting pictures from 4K burst file and saving

- The picture will be saved in JPEG format.
  - For details, refer to “Operating Instructions for advanced features (PDF format)”.

## [Post Focus]

**Recording mode:** 

You can record bursts of photos with the same quality as a 4K photo while automatically changing the focus point ([Post Focus] recording). After recording, you can select a point on the screen to save a picture with that point as the focus point.

- To record pictures, use a UHS Speed Class 3 card.
- During recording, the angle of view will be narrower.

### 1 Press button

### 2 Press to select [ON] and press [MENU/SET]

- It can also be set by going to the [Rec] menu and selecting [ON] for [Post Focus].

[Post Focus] icon

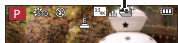

### 3 Determine the composition and press the shutter button halfway

- Auto Focus activates and automatically detects the focus point on the screen.
- If there is no focus point on the screen, the Focus indicator (● (green)) blinks and you cannot record.

**From halfway pressing the shutter button to completion of recording**

- Do not change the distance to subject or the composition.

### 4 Press the shutter button fully to start recording

Recording progress bar



- The focus point changes automatically while recording. When the recording progress bar disappears, recording automatically ends.
- A motion picture will be recorded in MP4 format. (No audio is recorded.)

- If the surrounding temperature is high, or [Post Focus] recording is performed continuously, or the temperature of the camera rises, [△] may be displayed and recording may be stopped halfway through to protect the camera. Wait until the camera cools down.

## Select the focus point and save the picture

### 1 On the playback screen, select the image with the [△] icon and press ▲



- The same operation can be performed by touching [△].

### 2 Select the focus point by touching it

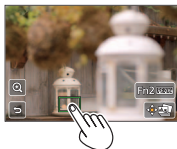

- The picture will be displayed with the focus on the selected point.
- The edge of the screen cannot be selected.
- If there are no pictures with the focus on the selected point, a red frame will be displayed, and pictures cannot be saved.



### 3 Touch [⊞] to save the picture

- The picture will be saved in JPEG format.
- After saving, return to step 2.

## ■ Making fine adjustments to focus



- ① Touch [  ]
  - The picture can be enlarged.
- ② Drag the slide bar to make fine adjustments to focus
  - The same operation can be performed using ◀▶.
- ③ Touch [  ] to save the picture
  - The screen returns to step ①.



## ■ Highlight in-focus portion with colour (Peaking)

- ① Touch [  ]



- Each time the icon is touched, the setting is switched in order of [  ] ([Detect Level]: [LOW]) → [  ] ([Detect Level]: [HIGH]) → [OFF].
- The display colour will be the same as set in [Peaking] under the [Custom] menu.

## Recording motion pictures

Recording mode: **PAS**

You can record full high-definition quality images that comply with the AVCHD standard, as well as motion pictures recorded in MP4. You can also record a 4K motion picture in MP4. Audio is recorded in stereo.

### ■ Setting the format, picture size and recording frame rate

**MENU** → **[Motion Picture]** → **[Rec Format]**

<b>[AVCHD]</b>	This is a data format suitable for playback on high-definition TVs.
<b>[MP4]</b>	This data format is suited for playing back motion pictures on a computer and other such devices.

**MENU** → **[Motion Picture]** → **[Rec Quality]**

#### When [AVCHD] is selected

Item	Picture size	fps	Bit rate (approx.)
<b>[FHD/28M/50p]*1</b>	1920×1080	50p	28 Mbps
<b>[FHD/17M/50i]</b>	1920×1080	50i	17 Mbps
<b>[FHD/24M/25p]</b>	1920×1080	50i	24 Mbps
<b>[FHD/24M/24p]*2</b>	1920×1080	24p	24 Mbps

#### When [MP4] is selected

Item	Picture size	fps	Bit rate (approx.)
<b>[4K/100M/25p]</b>	3840×2160	25p	100 Mbps
<b>[4K/100M/24p]*2</b>	3840×2160	24p	100 Mbps
<b>[FHD/28M/50p]</b>	1920×1080	50p	28 Mbps
<b>[FHD/20M/25p]</b>	1920×1080	25p	20 Mbps
<b>[HD/10M/25p]</b>	1280×720	25p	10 Mbps
<b>[VGA/4M/25p]</b>	640×480	25p	4 Mbps

\*1 AVCHD Progressive

\*2 **TZ100/TZ101**

## 1 Press the motion picture button to start recording

- Recording of motion picture appropriate for each motion picture mode is possible.
- While you are recording motion pictures, the recording status indicator (red) will flash.
- If some information is no longer displayed on the screen, press the [DISP.] button or touch the monitor.
- If you press the shutter button down fully, you can take still pictures while recording motion pictures.
- Immediately release the motion picture button after pressing it.

Recording state indicator



Elapsed recording time

Remaining recording time

## 2 Press the motion picture button again to end recording

- If the surrounding temperature is high, or a motion picture is recorded continuously, [ $\triangle$ ] is displayed and recording may be stopped halfway through to protect the camera. Wait until the camera cools down.
- **With recording in a quiet environment, the sound of aperture, focus and other actions may be recorded in motion pictures. This is not a malfunction.**  
The focus operation during recording of motion pictures can be set to [OFF] in [Continuous AF].
- [AVCHD] motion pictures:  
Recording stops when the continuous recording time exceeds 29 minutes and 59 seconds.
- Motion pictures with their file size set to [FHD], [HD] or [VGA] in [MP4]:  
Recording stops when the continuous recording time exceeds 29 minutes and 59 seconds or the file size exceeds 4 GB.
  - Since the file size becomes larger with [FHD], recording with [FHD] will stop before 29 minutes 59 seconds.



- Motion pictures with their file size set to [4K] in [MP4]:  
Recording stops when the continuous recording time exceeds 15 minutes.  
When you are using an SDHC memory card, you can continue recording without interruption even if the file exceeds 4 GB, but the motion picture file will be recorded and played back in separate files.  
If using an SDXC Memory Card, you can record a motion picture in a single file even if the size is greater than 4 GB.

## Recording 4K motion pictures

Recording mode:   **P** **A** **S** **M**  **C**  **SCN** 

You can record high-resolution 4K motion pictures by setting [Rec Quality] to [4K].

- To record 4K motion pictures, use a UHS Speed Class 3 card.
- When you record 4K motion pictures, the angle of view will be narrower than motion pictures of other sizes.

### ■ To record 4K motion pictures

- ① Select the recording mode (→18)
- ② Set the [Rec Format] in the [Motion Picture] menu to [MP4] (→31)
- ③ Set [Rec Quality] in the [Motion Picture] menu to [4K/100M/25p] or [4K/100M/24p]\* (→31)  
\* **TZ100/TZ101**
- ④ Start recording by pressing the motion picture button
- ⑤ Stop the recording by pressing the motion picture button again

## [4K Live Cropping]

### Recording mode:

You can pan while recording subjects without horizontal shaking of the camera, and you can zoom in and out during motion picture recording without using zoom. During recording, you can crop your video down from the 4K angle of view (3840×2160) to Full High Definition (1920×1080) by capturing the subject at a wide angle of view and setting a crop start frame and crop end frame.

- Hold the camera firmly in place while recording.
- A motion picture will be recorded at [FHD/20M/25p] under [MP4].

Example of panning while recording.



Setting crop frames at 4K angle of view



Screen moves from left to right without moving the camera

**1** Set mode dial to [M]

**2** Set the menu

MENU →  [Motion Picture] → [4K Live Cropping]

**3** Use ▲▼ to set panning or zooming time and press [MENU/SET]

Settings: [40SEC] / [20SEC] / [OFF]

- The angle of view narrows.

## 4 Set the crop start frame



## 5 Set the crop end frame

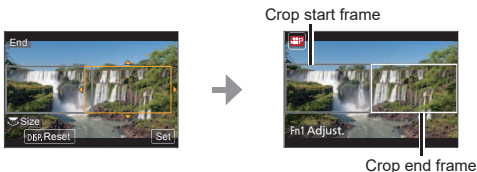

Movement of the image on the screen	Frame size	
	Start frame	End frame
Pan (move right and left)	Same	
Zoom in	Large	Small
Zoom out	Small	Large

### ■ Changing the position and size of a crop frame

Press [Fn1] button.

## 6 Press the motion picture button to start recording

The display switches to the angle of view set in step **4** and the panning or zoom operation is displayed.

- Immediately release the motion picture button after pressing it.
- When the set operating time has elapsed, recording automatically ends.
- Zoom operation is not available.

### ■ To end [4K Live Cropping] recording midway

Press the motion picture button again during recording.

- [4K Live Cropping] recording cannot be performed when [High Speed Video] is set.

## Viewing your pictures

### 1 Press the playback button

- When the camera is switched to the playback screen from the recording screen, the lens barrel is retracted after approx. 15 seconds.

### 2 Press ◀▶ to select a picture to be displayed

- Pictures can also be forwarded or rewound by dragging the screen horizontally (→22).

#### ■ Viewing motion pictures

- Motion pictures are displayed with the motion picture icon ([▶]).

① Press ▲ to start playback

- Touching [▶] in the middle of the screen allows you to play back motion pictures.
- If you press [MENU/SET] during a pause, you can create a picture from a motion picture.



#### ■ Sending pictures to the WEB services

If you press ▼ while a single picture is being displayed, you can send the picture to the WEB service quickly. For details, refer to “Operating Instructions for advanced features (PDF format)”.

#### ■ Deleting pictures

**Deleted pictures cannot be recovered.**

① Press [🗑️] button to delete displayed picture

- The same operation can be performed by touching [🗑️].

② Use ▲ to select [Delete Single] and press [MENU/SET]

#### ■ Ending playback

Press the playback button again or press the motion picture button.

The playback can also be ended by pressing the shutter button halfway.

## [Light Composition]

Select multiple frames from 4K burst files recorded in 4K Photo mode (→25) that you wish to combine. Parts of the image that are brighter than the preceding frame will be superimposed on the preceding frame to combine the frames into one picture.



### 1 Set the menu

**MENU** → **[Playback]** → **[Light Composition]**

### 2 Using ◀▶, select the 4K photo burst files and press **[MENU/SET]**

### 3 Choose the combining method and press **[MENU/SET]**

#### ■ When **[Composite Merging]** is selected

Select the frames you wish to combine, and then camera superimposes brighter parts of the image.

#### ① Select the frames

- Images displayed cannot be enlarged or shrunk or shown as in slide view.
- in touch operation becomes .



② Press [MENU/SET]

The selected frames are remembered, and the display goes to the preview screen.

Use ▲ ▼ to select items and press [MENU/SET] to perform the following operations.

- [Next]: Lets you select more frames for combining. Goes back to step ①.
- [Reselect]: Discards the frame selected immediately before and lets you select a different image.
- [Save]: Ends frame selection.

③ Repeat steps ① - ② to select more frames to combine

- You can select up to 40 frames.

④ Press ▼ to select [Save] and press [MENU/SET]

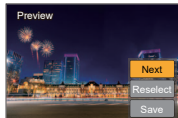

### ■ When [Range Merging] is selected

Select the first and last frames, and the brighter parts of frames within that range will be superimposed.

① Select the frame of the first picture

The selection method is the same as in step ① when selecting [Composite Merging].

② Press [MENU/SET]

The position of the first picture will be remembered.

③ Select the frame of the last picture

④ Press [MENU/SET]

The position of the last picture will be remembered.

## 4 Select [Yes] at the confirmation screen and press [MENU/SET]

The combined picture is displayed.

- **The picture will be saved in JPEG format.**

## What you can do with the Wi-Fi<sup>®</sup> function

### ● **Operating the camera by connecting it to a smartphone**

You can easily set up a direct connection to your smartphone without entering a password.

- Taking pictures via a smartphone (→42)
- Playing back pictures in the camera on a smartphone (→42)
- Saving pictures in the camera to a smartphone
- Sending pictures in the camera to social networking services
- Adding location information to pictures in the camera from a smartphone
- Combining motion pictures recorded with Snap Movie according to your preference on a smartphone

### ● **Displaying still pictures on a TV**

### ● **Wireless printing**

### ● **Sending pictures to AV device**

### ● **Sending pictures to a PC**

### ● **Using WEB services**

- This manual uses the term “smartphone” for both smartphones and tablets unless it is necessary to distinguish between them.
- For details, refer to “Operating Instructions for advanced features (PDF format)”.
- The camera cannot be used to connect to a public wireless LAN connection.

## Operating the camera by connecting it to a smartphone

### Installing the smartphone app “Panasonic Image App”

The “Image App” is an application provided by Panasonic.

<b>Supported OS</b>	Android™: Android 4.0 or later iOS: iOS 7.0 or later
<b>Installation procedure</b>	<ol style="list-style-type: none"> <li>① Connect your device to a network</li> <li>② (Android) Select “Google Play™ Store” (iOS) Select “App Store<sup>SM</sup>”</li> <li>③ Enter “Panasonic Image App” or “LUMIX” to search for the app</li> <li>④ Select “Panasonic Image App” and install it</li> </ol> 

- Use the latest version.
- Supported OS versions as of January 2016. Supported OS versions may be changed without prior notice.
- The service may not be able to be used properly depending on the type of smartphone being used.

For the latest information on the “Image App”, refer to the support site below.

<http://panasonic.jp/support/global/cs/dsc/> (This site is available in English only.)

- When downloading the app on a mobile network, high packet communication fees may be incurred depending on the details of your contract.
- For details about the operating procedure, etc., refer to [Help] in the “Image App” menu.
- If you connect the camera and smartphone over a Wi-Fi connection and run “Image App”, [Help] may not be displayed in the “Image App” menu for some smartphones. In such a case, disconnect the Wi-Fi connection with the camera, connect the camera to a cellular data line such as 3G and LTE, or the Internet to display [Help] in the “Image App” menu.
- Some of the screens and information provided in this document may be different depending on the supported operating system and “Image App” version.



## Connecting to a smartphone

You can easily establish a Wi-Fi connection on this unit without entering a password on your smartphone.

### 1 Select the menu on the camera

**MENU** →  **[Setup]** → **[Wi-Fi]** → **[Wi-Fi Function]** → **[New Connection]**  
→ **[Remote Shooting & View]**

- The information required for directly connecting your smartphone to this unit (SSID) is displayed.
- You can also display the information by pressing the function button that [Wi-Fi] function is assigned. (At the time of purchase, [Wi-Fi] is assigned to [Fn5] touch icon.)



### 2 Turn on the Wi-Fi function in the setting menu of the smartphone

### 3 Select the SSID displayed on the screen of the camera



### 4 On the smartphone, start "Image App"

- When the connection confirmation screen appears on the camera, select [Yes] and press [MENU/SET]. (Only when making a connection for the first time.)

**[Wi-Fi Password]** is set to **[OFF]** at the time of purchase. In **[OFF]** state, a third party can tap into the Wi-Fi transmission and steal transmitted data. Set **[Wi-Fi Password]** to **[ON]**. For details, refer to "Operating Instructions for advanced features (PDF format)".

## ■ Closing the connection

- ① (On the camera) On the recording standby screen, terminate the connection from the menu of the camera

**MENU** →  **[Setup]** → **[Wi-Fi]** → **[Wi-Fi Function]** → **[Yes]**

- ② (On your smartphone) Close “Image App”
  - For details on how to close the application, refer to the operating instructions of your device.

- When recording with [4K Pre-Burst] with the smartphone, terminate the connection only after switching to 4K Burst recording by pressing [Q.MENU/⏏] button on the camera.

## ■ Taking pictures via a smartphone (remote recording)

### 1 Connect to a smartphone (→41)

### 2 Operate the smartphone

- ① Select [
- ② Take pictures
  - The recorded images are saved in the camera.
  - Some settings are not available.



## ■ Playing back pictures in the camera on a smartphone

### 1 Connect to a smartphone (→41)

### 2 Operate the smartphone

- ① Select []
  - When the picture is touched, it is played back at a larger size.



## Downloading software

Still/motion pictures can be copied from the camera to your computer by connecting the two together. If you wish to play back or edit pictures on a PC, download software from the supplier's website and install it on your PC.

- To download the software, your PC must be connected to the Internet.
- It may take time to download the software in some communication environments.

### PHOTOfunSTUDIO 9.8 PE

You can capture still pictures or motion pictures to your PC, or organise captured pictures by categorising by recording date, model name of the digital camera used to record, etc. You can also correct still pictures, edit motion pictures, or write to DVD.

- Check the website below to download/install the software.

The software is available for download until the end of March 2021.

[http://panasonic.jp/support/global/cs/soft/download/d\\_pfs98pe.html](http://panasonic.jp/support/global/cs/soft/download/d_pfs98pe.html)

- **Operating environment**

<b>Supported OS</b>	Windows® 10 (32-bit/64-bit) Windows® 8.1 (32-bit/64-bit) Windows® 8 (32-bit/64-bit) Windows® 7 (32-bit/64-bit) SP1	
<b>CPU</b>	Windows® 10	Pentium® 4 2.8 GHz or higher
	Windows® 8.1	
	Windows® 8	
	Windows® 7	
<b>Display</b>	1024×768 pixels or more (1920×1080 pixels or more recommended)	
<b>RAM</b>	Windows® 10	1 GB or more (32-bit) / 2 GB or more (64-bit)
	Windows® 8.1	
	Windows® 8	
	Windows® 7	
<b>Free hard disk space</b>	450 MB or more for installing software	

- To edit 4K motion pictures, you need the 64-bit versions of Windows 10, Windows 8.1, Windows 8, or Windows 7.
- Refer to the operating instructions of "PHOTOfunSTUDIO" (PDF) for further information about the operating environment.

## **SILKYPIX Developer Studio SE**

This software develops and edits RAW file pictures. Edited pictures can be saved in a file format such as JPEG or TIFF that can be displayed on a PC, etc.

- Check the website below to download/install the software.  
<http://www.isl.co.jp/SILKYPIX/english/p/>
- Supported OS: Windows® 10 / 8.1 / 8 / 7  
Mac® OS X v10.6 - v10.11
- For details on the operating environment and how to use the SILKYPIX Developer Studio SE, refer to the “Help” or the Ichikawa Soft Laboratory’s support website.

## **LoiLoScope 30 day full trial version**

Motion pictures can be edited easily.

- Check the website below to download/install the software.  
<http://loilo.tv/product/20>
- Supported OS: Windows® 10 / 8.1 / 8 / 7
- For more information on how to use LoiLoScope and its operating environment, read the LoiLoScope manual available for download at the website.

## Reading the Operating Instructions (PDF format)

More detailed operating instructions are available in “Operating Instructions for advanced features (PDF format)”. To read it, download it from the website.

### DMC-TZ100

<http://panasonic.jp/support/dsc/oi/index.html?model=DMC-TZ100&dest=EB>

### DMC-TZ101

<http://panasonic.jp/support/dsc/oi/index.html?model=DMC-TZ101&dest=EG>

### DMC-TZ80

<http://panasonic.jp/support/dsc/oi/index.html?model=DMC-TZ80&dest=EB>

### DMC-TZ81

<http://panasonic.jp/support/dsc/oi/index.html?model=DMC-TZ81&dest=EG>

DMC-TZ100



DMC-TZ101



DMC-TZ80



DMC-TZ81



- Click the desired language.

## ■ Confirming URLs and QR codes with the camera

- ① Set the menu

**MENU** →  **[Setup]** → **[Online Manual]**

- ② Use ▲ ▼ to select [URL display] or [QR Code display] and press [MENU/SET]
- The URL or QR code will be displayed on the camera monitor.

- You will need Adobe Reader to browse or print the Operating Instructions (PDF format). You can download and install a version of Adobe Reader that you can use with your OS from the following website. (As of January 2016)  
<http://www.adobe.com/products/acrobat/readstep2.html>

## List of monitor/viewfinder displays

- The following images are examples of when the display screen is set to [ ] (monitor style) in the monitor.



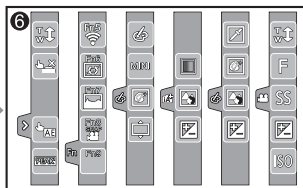
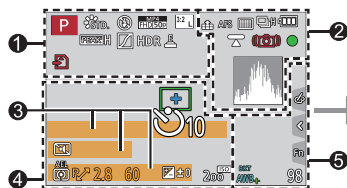























### In recording



1

<b>P</b>	Recording mode (→18)
<b>C 1</b>	Custom Set
<b>STD.</b>	[Photo Style]
<b>Flash</b>	Flash Mode
<b>MP4 FHD/50p</b>	[Rec Format]/ [Rec Quality]
<b>SNAP 4SEC</b>	[Snap Movie]
<b>3:2 L</b>	[Aspect Ratio]/ [Picture Size]
<b>STD.</b>	Image size (Panorama Shot Mode)
<b>Hand icon</b>	Picture effect (Filter) adjustment display
<b>EXPS</b>	Types of picture effects (Filter)
<b>Card icon</b>	Card (displayed only during recording)

<b>XXmXXs</b>	Elapsed recording time*1
<b>Camera icon</b>	Simultaneous recording indicator
<b>LVF/MON/AUTO</b>	Automatic switching between viewfinder and monitor (→20)
<b>PEAK H</b>	[Peaking]
<b>TZ100/TZ101</b>	[Highlight Shadow]
<b>HDR</b>	[HDR]/[iHDR]
<b>TZ100/TZ101</b>	[Multi Exp.]
<b>E</b>	Electronic shutter
<b>Warning icon</b>	Overheat indicator (→27, 29)

<b>2</b>	 [Quality]	<b>3</b>	Name*2
100fps	[High Speed Video]	Travel elapsed days*3	
 [Post Focus] (→28)		Age in years/months*2	
AFS	[AFS/AFF/AFC]/MF	Location*3	
 AF Mode		Current date/time*3	
 [Pull Focus]		Travel destination setting*3: 	
 [Face Recog.]		Exposure meter	
AFL	AF Lock	Zoom (→16)	
 Burst		<b>4</b>	
 [4K PHOTO] (→25)		 AF area	
 [Auto Bracket]		+ Spot metering target	
 [Self Timer]		 [Self Timer]*4	
 Remaining battery		 [Silent Mode]	
AF  Macro recording (→20)		AEL AE Lock	
 [Level Shot]		 [Metering Mode]	
 [Stabilizer]		 Programme Shift	
 Jitter alert		2.8*5 Aperture value	
 Recording state (Flashes red.) (→32)/ Focus (Lights green.) (→17)		60 Shutter speed	
 Focus (Under low illumination)		 ±0 Exposure compensation value	
 Focus (Starlight AF)	TZ100/TZ101	Brightness (exposure)	
 Wi-Fi connection status		Manual Exposure Assist	
 Histogram		200 <sup>ISO</sup> ISO sensitivity	



5

<b>TZ100/TZ101</b>	<b>[Dial Guide]</b>
<b>TZ80/TZ81</b>	<b>[Dial Guide]</b>
BKT AWB	<b>White Balance Bracket</b>
	<b>White Balance Fine Adjustment</b>
	<b>White Balance</b>
	<b>Colouring</b>
<b>98</b>	<b>Number of recordable pictures*6</b>
<b>RXXmXXs</b>	<b>Available recording time*1, *6</b>

6

## Touch tab

	<b>Touch zoom</b>
	<b>Touch Shutter</b>
	<b>[Touch AE]</b>
	<b>[Peaking]</b>

	<b>Function buttons (→19)</b>
	<b>Colouring</b>
	<b>Defocus control function</b>
	<b>Brightness (exposure)</b>
	<b>Type of defocus (Miniature Effect)</b>
	<b>[One Point Color]</b>
	<b>[Sunshine]</b>
	<b>Picture effect (Filter) adjustment display</b>
	<b>Picture effects ON or OFF</b>
	<b>Picture effects (Filter)</b>
	<b>Aperture value</b>
	<b>Shutter speed</b>
	<b>ISO sensitivity</b>

\*1 [m] and [s] indicate “minute” and “second”.

\*2 This is displayed for about 5 seconds when the camera is turned on if the [Profile Setup] setting is set.

\*3 This is displayed for about 5 seconds when the camera is turned on, after setting the clock and after switching from Playback Mode to Recording mode.

\*4 This is displayed during countdown.

\*5 Values given are examples for DMC-TZ100/DMC-TZ101. The values you can set may vary depending on the model.

\*6 It is possible to switch the display between the number of recordable pictures and available recording time with the [Remaining Disp.] setting in the [Custom] menu.

- The information displayed, such as histograms, magnifications, and numeric values, are only for the purpose of reference.

## Menu list

- The [Photo Style], [Filter Settings], [Sensitivity], [AF Mode], [AFS/AFF/AFC], [Metering Mode], **TZ100/TZ101** [Highlight Shadow], [i.Dynamic], [i.Resolution], [Diffraction Compensation], [i.Zoom] and [Digital Zoom] menu items are common for both [Rec] and [Motion Picture] menus. If a setting in one menu is changed, the setting with the same name in other menu will also be changed automatically.

### [Rec]

[Photo Style]
[Filter Settings]
[Aspect Ratio]
[Picture Size]
[Quality]
[Sensitivity]
<b>TZ80/TZ81</b>
[White Balance]
[AF Mode]
[AFS/AFF/AFC]
[Metering Mode]
[Burst Rate]
[4K PHOTO]
[Auto Bracket]
[Self Timer]
<b>TZ100/TZ101</b>
[Highlight Shadow]

[i.Dynamic]
[i.Resolution]
[Post Focus]
[iHandheld Night Shot]
[iHDR]
[HDR]
<b>TZ100/TZ101</b>
[Multi Exp.]
[Time Lapse Shot]
[Stop Motion Animation]
[Panorama Settings]
[Shutter Type]
<b>TZ100/TZ101</b>
[Flash]
<b>TZ80/TZ81</b>
[Flash Adjust.]
[Red-Eye Removal]

[ISO Limit Set]
[ISO Increments]
[Extended ISO]
<b>TZ100/TZ101</b>
[Long Shtr NR]
[Diffraction Compensation]
[i.Zoom]
[Digital Zoom]
<b>TZ100/TZ101</b>
[Color Space]
[Stabilizer]
[Face Recog.]
[Profile Setup]

 [Motion Picture]

[4K Live Cropping]

[Snap Movie]

[Rec Format]

[Rec Quality]

[Exposure Mode]

[High Speed Video]

[Continuous AF]

[Level Shot]

[Flkr Decrease]

[Silent Operation]

[Wind Noise Canceller]

[Zoom Mic]

 [Custom]

[Cust.Set Mem.]

[Silent Mode]

[AF/AE Lock]

[AF/AE Lock Hold]

[Shutter AF]

[Half Press Release]

[Quick AF]

[Eye Sensor AF]

**TZ100/TZ101**

[Pinpoint AF Time]

**TZ100/TZ101**

[Pinpoint AF Display]

[AF Assist Lamp]

[Direct Focus Area]

[Focus/Release Priority]

[AF+MF]

[MF Assist]

[MF Assist Display]

[MF Guide]

[Peaking]

[Histogram]

[Guide Line]

[Highlight]

[Zebra Pattern]

[Monochrome Live View]

**TZ100/TZ101**

[Constant Preview]

[Expo.Meter]

[Dial Guide]

[LVF Disp.Style]

[Monitor Disp. Style]

[Rec Area]

[Remaining Disp.]

[Auto Review]

[Fn Button Set]

[Zoom lever]

[Zoom Resume]

**TZ100/TZ101**

[Q.MENU]

[Ring/Dial Set]

[Eye Sensor]

[Touch Settings]

[Touch Scroll]

[Menu Guide]

## [Setup]

[Online Manual]	[Monitor Luminance]	[Version Disp.]
[Clock Set]	[Economy]	[Exposure Comp. Reset]
[World Time]	[USB Mode]	[Self Timer Auto Off]
[Travel Date]	[TV Connection]	[No.Reset]
[Wi-Fi]	[Menu Resume]	[Reset]
[Beep]	[Menu Background]	[Reset Wi-Fi Settings]
[Live View Mode]	[Menu Information]	[Demo Mode]
[Monitor Display]/ [Viewfinder]	[Language]	[Format]

## [Playback]

[Slide Show]	[Title Edit]	[Rotate]
[Playback Mode]	[Text Stamp]	[Rotate Disp.]
[Location Logging]	[Video Divide]	[Favorite]
<b>TZ100/TZ101</b>	[Time Lapse Video]	[Print Set]
[RAW Processing]	[Stop Motion Video]	[Protect]
[Light Composition]	[Resize]	[Face Rec Edit]
[Clear Retouch]	[Cropping]	[Picture Sort]

## Q&A Troubleshooting

- Performing [Reset] in the [Setup] menu may resolve the issue.
- Further information is provided in the “Operating Instructions for advanced features (PDF format)”. Check it together with the information in this section.

### The charging lamp blinks.

- Charging is being performed in a place with extremely high or low temperature.  
→ **Reconnect the USB connection cable (supplied) and retry charging in a place where ambient temperature is 10 °C to 30 °C (50 °F to 86 °F) (temperature conditions also apply to the battery itself).**
- Charging is not possible if the power supply capacity of the computer is low.

### This unit is turned off automatically.

- [Economy] is activated.
- The linked operation of VIERA Link (HDMI) is enabled.  
→ If you are not using VIERA Link (HDMI), set [VIERA Link] to [OFF].

### Sometimes focus adjustment with auto focus mode is difficult while recording 4K motion pictures.

- This may occur when taking a picture by reducing the auto focus speed in order to adjust the focus at high precision. This is not a malfunction.

### The monitor display momentarily turns off.

- When the monitor display automatically switches between finder and monitor (→20), the action of the eye sensor causes automatic switching of the display to the finder if the finder gets close to the user's eye or an object.

**It cannot connect to the wireless LAN. Radio waves get disconnected.  
Wireless access point is not displayed.**

**General tips for using a Wi-Fi connection**

- Use within the communication range of the wireless LAN network.
- If any device, such as microwave oven, cordless phone, etc., that uses 2.4 GHz frequency are used nearby this unit simultaneously, radio waves may get interrupted.  
→ Use them sufficiently away from the device.
- When the battery indicator is flashing red, the connection with other equipment may not start or the connection may be disrupted. (A message such as [Communication error] is displayed.)
- When this unit is placed on a metal table or shelf, the connection may not be established easily because the camera is affected by radio waves. Use the camera away from metal surfaces.

**About a wireless access point**

- Check if the wireless access point to connect is in operating state.
- The camera may not display or connect to a wireless access point depending on the radio wave condition.  
→ Perform the connection closer to the wireless access point.  
→ Remove the obstacles between this unit and the wireless access point.  
→ Change the direction of this unit.  
→ Move the location or change the angle of the wireless access point.  
→ Perform the [Manual Input].
- It may not display even if the radio waves exist depending on the setting of the wireless access point.
- If the network SSID of the wireless access point is set not to broadcast, it may not be detected.  
→ Enter and set the network SSID. Alternatively, set the network SSID of the wireless access point to broadcast.
- Connection types and security setting methods are different depending on the wireless access point.  
→ Refer to the operating instructions of the wireless access point.
- When the 5 GHz/2.4 GHz switchable wireless access point is connected to other equipment using the 5 GHz band, it cannot be used simultaneously with this camera if it is not compatible.  
→ The use of a wireless access point that can use 5 GHz/2.4 GHz simultaneously is recommended.

## Specifications

### Digital Camera: Information for your safety

<b>Power Source</b>	DC 8.4 V (≒ 8.4 V)
<b>Power Consumption</b>	<p><b>TZ100/TZ101</b>            2.3 W (When recording with monitor)            2.7 W (When recording with viewfinder)            1.5 W (When playing back with monitor)            1.5 W (When playing back with viewfinder)</p>
	<p><b>TZ80/TZ81</b>            2.2 W (When recording with monitor)            2.6 W (When recording with viewfinder)            1.5 W (When playing back with monitor)            1.5 W (When playing back with viewfinder)</p>
<b>Camera effective pixels</b>	<p><b>TZ100/TZ101</b>            20,100,000 pixels</p> <p><b>TZ80/TZ81</b>            18,100,000 pixels</p>
<b>Image sensor</b>	<p><b>TZ100/TZ101</b>            1" MOS sensor,            total pixel number 20,900,000 pixels            Primary colour filter</p> <p><b>TZ80/TZ81</b>            1/2.3" MOS sensor,            total pixel number 18,900,000 pixels            Primary colour filter</p>

<b>Lens</b>	<p><b>TZ100/TZ101</b>  Optical 10x zoom  f=9.1 mm to 91 mm  (35 mm film camera equivalent: 25 mm to 250 mm)  Max. Wide: F2.8 to F8.0  Max. Tele: F5.9 to F8.0</p> <p><b>TZ80/TZ81</b>  Optical 30x zoom  f=4.3 mm to 129 mm  (35 mm film camera equivalent: 24 mm to 720 mm)  Max. Wide: F3.3 to F8.0  Max. Tele: F6.4 to F8.0</p>
<b>Image Stabiliser</b>	Optical method
<b>Focus range</b>	<p><b>TZ100/TZ101</b>  AF:  50 cm (1.6 feet) (Max. Wide)/  70 cm (2.3 feet) (Max. Tele) to ∞  AF Macro/MF/Intelligent Auto/Motion picture:  5 cm (0.16 feet) (Max. Wide)/  70 cm (2.3 feet) (Max. Tele) to ∞</p> <p><b>TZ80/TZ81</b>  AF:  50 cm (1.6 feet) (Max. Wide)/  2 m (6.6 feet) (Max. Tele) to ∞  AF Macro/MF/Intelligent Auto/Motion picture:  3 cm (0.098 feet) (Max. Wide)/  2 m (6.6 feet) (Max. Tele) to ∞</p>
<b>Shutter system</b>	Electronic shutter + Mechanical shutter



<b>Minimum Illumination</b>	<p><b>TZ100/TZ101</b>          Approx. 9 lx (when i-Low light is used, the shutter speed is 1/25th of a second)</p> <p><b>TZ80/TZ81</b>          Approx. 10 lx (when i-Low light is used, the shutter speed is 1/25th of a second)</p>
<b>Shutter speed</b>	<p><b>TZ100/TZ101</b>          Still picture:          T (Time) (Max. approx. 120 seconds),          60 seconds to 1/2000th of a second          (When the mechanical shutter is used),          1 second to 1/16000th of a second          (When the electronic shutter is used)          Motion picture:          1/2 second to 1/16000th of a second          (When [M] is selected in Creative Video Mode, MF),          1/25th of a second to 1/16000th of a second          (Other than the above)</p> <p><b>TZ80/TZ81</b>          Still picture:          60 seconds to 1/2000th of a second          (When the mechanical shutter is used and [Artistic Nightscapes] is selected as the Scene Guide Mode),          4 seconds to 1/2000th of a second          (When the mechanical shutter is used, in cases other than the above),          1 second to 1/16000th of a second          (When the electronic shutter is used)          Motion picture:          1/2 second to 1/16000th of a second          (When [M] is selected in Creative Video Mode, MF),          1/25th of a second to 1/16000th of a second          (Other than the above)</p>

<b>Exposure (AE)</b>	Programme AE (P)/Aperture-priority AE (A)/ Shutter-priority AE (S)/Manual exposure (M)/AUTO Exposure Compensation (1/3 EV steps, -5 EV to +5 EV)
<b>[Metering Mode]</b>	Multiple/Centre weighted/Spot
<b>Monitor</b>	3.0" TFT LCD (3:2) (Approx. 1,040,000 dots) (field of view ratio about 100%) Touch screen
<b>Viewfinder</b>	0.2" Colour LCD Live Viewfinder (4:3) (Approx. 1,160,000 dots equivalent) (field of view ratio about 100%)  <b>TZ100/TZ101</b> [Magnification approx. 1.25x, 0.46x (35 mm film camera equivalent), with 50 mm lens at infinity; -1.0 m <sup>-1</sup> ] (with diopter adjustment -4.0 to +4.0 diopter)  <b>TZ80/TZ81</b> [Magnification approx. 2.59x, 0.46x (35 mm film camera equivalent), with 50 mm lens at infinity; -1.0 m <sup>-1</sup> ] (with diopter adjustment -4.0 to +4.0 diopter)
<b>Flash</b>	<b>TZ100/TZ101</b> Built-in pop up flash <b>TZ80/TZ81</b> Built-in flash AUTO, AUTO/Red-Eye Reduction, Forced ON, Forced ON/Red-Eye Reduction, Slow Sync., Slow Sync./Red-Eye Reduction, Forced OFF
<b>Microphones</b>	Stereo
<b>Speaker</b>	Monaural
<b>Recording media</b>	SD Memory Card/SDHC Memory Card*/ SDXC Memory Card* * UHS-I/UHS Speed Class 3
<b>Recording file format</b>	
<b>Still picture</b>	RAW/JPEG (based on Design rule for Camera File system, based on Exif 2.3 standard/DPOF corresponding)
<b>Motion picture</b>	AVCHD Progressive/AVCHD/MP4

<b>Audio compression format</b>	AVCHD: Dolby® Digital (2 ch) MP4: AAC (2 ch)
<b>Interface</b> <b>Digital</b>	USB 2.0 (High Speed) Data from the PC can not be written to the camera using the USB connection cable.
<b>Terminal</b> <b>[HDMI]</b> <b>[CHARGE]</b>	Micro HDMI Type D USB 2.0 micro-B
<b>Dimensions</b>	<b>TZ100/TZ101</b> Approx. 110.5 mm (W) x 64.5 mm (H) x 44.3 mm (D) [4.35" (W) x 2.54" (H) x 1.74" (D)] (excluding the projection part) <b>TZ80/TZ81</b> Approx. 112.0 mm (W) x 64.0 mm (H) x 38.0 mm (D) [4.41" (W) x 2.52" (H) x 1.50" (D)] (excluding the projection part)
<b>Mass</b>	<b>TZ100/TZ101</b> With card and battery: Approx. 310 g (0.68 lb) Excluding card and battery: Approx. 268 g (0.59 lb) <b>TZ80/TZ81</b> With card and battery: Approx. 282 g (0.62 lb) Excluding card and battery: Approx. 240 g (0.53 lb)
<b>Operating temperature</b>	0 °C to 40 °C (32 °F to 104 °F)
<b>Operating humidity</b>	10%RH to 80%RH

## ■ Wi-Fi

<b>Compliance standard</b>	IEEE 802.11b/g/n (standard wireless LAN protocol)
<b>Frequency range used (central frequency)</b>	2412 MHz to 2462 MHz (1 to 11 ch)
<b>Encryption method</b>	Wi-Fi compliant WPA™/WPA2™
<b>Access method</b>	Infrastructure mode

## ■ AC adaptor

(Panasonic SAE0012F): Information for your safety

<b>Input:</b>	110 V – 240 V ~ 50/60 Hz 0.2 A
<b>Output:</b>	5 V --- 1.0 A

- For more information about the energy efficiency of the product, please visit our website, [www.panasonic.com](http://www.panasonic.com), and enter the model number in the search box.

## ■ Battery Pack (lithium-ion)

(Panasonic DMW-BLG10E): Information for your safety

<b>Voltage/capacity:</b>	7.2 V/1025 mAh
--------------------------	----------------

The symbols on this product (including the accessories) represent the following:

~	AC
---	DC
	Class II equipment (The construction of the product is double-insulated.)

Specifications are subject to change without notice.

## Digital Camera Accessory System

<b>Battery pack</b> DMW-BLG10	The battery pack can be charged from the camera using the AC adaptor (supplied).
<b>AC adaptor</b> DMW-AC10	By using the AC adaptor (DMW-AC10: optional) and DC coupler (DMW-DCC11: optional), you can record and play back without worrying about the remaining battery charge. <ul style="list-style-type: none"> <li>• The AC adaptor (optional) can only be used with the designated Panasonic DC coupler (optional). The AC adaptor (optional) cannot be used by itself.</li> <li>• When using an AC adaptor (optional), use the AC mains lead supplied with the AC adaptor.</li> </ul>
<b>DC coupler</b> DMW-DCC11	

- Part numbers are as of January 2016. These may be subject to change.
- Some optional accessories may not be available in some countries.

### Sales and Support Information

#### Customer Communications Centre

- For customers within the U.K.: 0344 844 3899
- For customers within Ireland: 01 289 8333
- Monday - Friday 9:00am - 5:00pm (Excluding public holidays).
- For further support on your product, please visit our website: [www.panasonic.co.uk](http://www.panasonic.co.uk)

#### Direct Sales at Panasonic U.K.

- Order accessory and consumable items for your product with ease and confidence by phoning our Customer Communications Centre Monday - Friday 9:00am - 5:00pm (Excluding public holidays).
- Or go on line through our Internet Accessory ordering application at [www.pas-europe.com](http://www.pas-europe.com).
- Most major credit and debit cards accepted.
- All enquiries transactions and distribution facilities are provided directly by Panasonic U.K.
- It couldn't be simpler!
- Also available through our Internet is direct shopping for a wide range of finished products. Take a browse on our website for further details.

- SDXC Logo is a trademark of SD-3C, LLC.
- The terms HDMI and HDMI High-Definition Multimedia Interface, and the HDMI Logo are trademarks or registered trademarks of HDMI Licensing, LLC in the United States and other countries.
- HDAVI Control™ is a trademark of Panasonic Holdings Corporation.
- “AVCHD”, “AVCHD Progressive” and the “AVCHD Progressive” logo are trademarks of Panasonic Holdings Corporation and Sony Corporation.
- Manufactured under license from Dolby Laboratories. Dolby and the double-D symbol are trademarks of Dolby Laboratories.
- Pentium is a trademark of Intel Corporation in the U.S. and/or other countries.
- Windows is either registered trademark or trademark of Microsoft Corporation in the United States and/or other countries.
- Mac and Mac OS are trademarks of Apple Inc., registered in the U.S. and other countries.
- iPad, iPhone, iPod, and iPod touch are trademarks of Apple Inc., registered in the U.S. and other countries.
- App Store is a service mark of Apple Inc.
- Android and Google Play are trademarks or registered trademarks of Google Inc.
- The Wi-Fi CERTIFIED™ Logo is a certification mark of Wi-Fi Alliance®.
- The Wi-Fi Protected Setup™ Identifier mark is a certification mark of Wi-Fi Alliance®.
- “Wi-Fi®” and “Wi-Fi Direct®” are registered trademarks of Wi-Fi Alliance®.
- “Wi-Fi Protected Setup™”, “WPA™”, and “WPA2™” are trademarks of Wi-Fi Alliance®.
- DLNA, the DLNA Logo and DLNA CERTIFIED are trademarks, service marks, or certification marks of the Digital Living Network Alliance.
- QR Code is a registered trademark of DENSO WAVE INCORPORATED.
- This product uses “DynaFont” from DynaComware Corporation. DynaFont is a registered trademark of DynaComware Taiwan Inc.
- Other names, company names, and product names mentioned in these instructions are trademarks or registered trademarks of the companies concerned.



Manufactured by:  
Panasonic Entertainment & Communication Co., Ltd.  
1-10-12, Yagumo-higashi-machi, Moriguchi City, Osaka, Japan



Importer for UK:  
Panasonic UK, a branch of Panasonic Marketing Europe GmbH Maxis 2, Western  
Road, Bracknell, Berkshire, RG12 1RT  
Importer for EU:  
Panasonic Marketing Europe GmbH  
Authorized Representative in EU:  
Panasonic Testing Centre  
Winsbergring 15, 22525 Hamburg, Germany

---

Panasonic Entertainment & Communication Co., Ltd.  
Web Site: <http://www.panasonic.com>

© Panasonic Entertainment & Communication Co., Ltd. 2016