

Panasonic®

Operating Instructions and Cookbook Convection/Grill/Microwave Oven

Model No. NN-CT54JW
NN-CT55JW
NN-CT56JB
NN-CT57JM

For domestic use only



INVERTER

Important safety instructions
Please read carefully and keep for future reference

Important Notice

Weight

½ oz	-	15 g
1 oz	-	25 g
2 oz	-	50 g
3 oz	-	75 g
4 oz	-	100 g
5 oz	-	150 g
6 oz	-	175 g
7 oz	-	200 g
8 oz	-	225 g
9 oz	-	250 g
10 oz	-	275 g
11 oz	-	300 g
12 oz	-	350 g
13 oz	-	375 g
14 oz	-	400 g
15 oz	-	425 g
1 lb/16 oz	-	450 g

Capacity

½ tsp	-	3 ml
1 tsp	-	5 ml
1 tbsp	-	15 ml
¼ pt	-	150 ml
½ pt	-	300 ml
¾ pt	-	450 ml
1 pt	-	600 ml
1¾ pt	-	1 litre

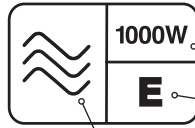

Microwave symbol

The IEC
(60705) power
output (watts)

The heating
category for small
packs of food

Thank you for purchasing a Panasonic Microwave Oven.

Your oven is rated 1000 Watts (IEC). When using other cookbooks remember to adjust cooking times accordingly. The symbol indicates the heating category for your oven when cooking or reheating convenience foods.

Your oven is rated 'E', which is very efficient. It is therefore very important that you refer carefully to the packet instructions on convenience foods.

Some packet instructions only display information for B or D rated ovens. We therefore provide additional guidelines for reheating and cooking on pages **65-81** of this book.

Always check the progress of the food as it cooks or reheats by simply opening the door. After checking the progress of the foods, press **Start** to continue the cooking time.

Failure to follow the instructions given in this Operating Instructions and Cookbook, may affect the recipe result and in some instances may be dangerous.



Customer Communications Centre
0344 844 3899

Selected Spares and Accessories:

Order direct on line at www.panasonic.co.uk or by telephoning the Customer Communications Centre number above.

For Cookery Advice call: 01344 862108
(open Monday to Wednesday 9am - 12pm)

Alternatively visit our web site at www.theideaskitchen.co.uk

Or write to the address below:
Home Appliance Innovation Centre
Panasonic Consumer Electronics U.K.
Willoughby Road
Bracknell
Berks
RG12 8FP

Thank you for purchasing this Panasonic appliance.

Contents

Safety Instructions	4-8	Combination 1. Convection and Microwave	44-45
Important Safety Instructions	9-10	Combination 2. Grill and Microwave	46-47
Disposal of Old Equipment.	10	Multi-stage Cooking	48
Before Using your Oven	11	Using the Timer	49-50
Placement of your Oven	12	Auto Programs	51-54
Care & Cleaning of your Oven	12-13	Junior Menu Programs	55-57
Maintenance of your Oven	14	Auto Cook Programs	58-59
Parts of your Oven.	15-16	Auto/Roast Programs	60-62
Important Information - Read Carefully	17-19	Cooking and Reheating Guidelines	63-64
Microwaving Principles	20	Reheating Charts	65-70
General Guidelines	21-23	Cooking Charts	71-81
Containers to Use	24-25	Recipes	
Cooking Modes	26-27	Increasing and Decreasing Recipes	82
Control Panels.	28	Using Recipes From Other Books.	82
Let's Start to Use your Oven	29	Cooking for One	82
Setting the Clock	30	Soups and Starters	83-84
Operation Guide Setting	30	Fish	85-87
Microwave Cooking and Defrosting	31-32	Meat and Poultry	88-93
Auto Weight Defrost - Chaos Defrost	33-34	Pasta, Rice and Beans	94-95
Defrosting Guidelines	34	Cheese and Egg Dishes	96-97
Defrosting Using Defrost Microwave and Time	35	Vegetables and Vegetarian	98-102
Defrosting Chart Using Defrost Microwave and Time	36	Sauces.	103-104
Using the Quick 30 Function	37	Pastry	105
Using the Add Time Function.	37	Baking	106-107
Grilling	38-39	Desserts	108-111
Convection Cooking	40-41	Preserves	112-113
Combination Cooking	42-43	Junior Recipes	114-116
		Questions and Answers.	117-118
		Technical Specification	119

Safety Instructions

- Important safety instructions. Before operating this oven, please read these instructions carefully and keep for future reference.
- This appliance can be used by children aged from 8 years and above and persons with reduced physical, sensory and mental capabilities or lack of experience and knowledge if they have been given supervision or instruction by a person responsible for their safety concerning the use of the appliance in a safe way and understand the hazards involved. Children shall not play with the appliance. Cleaning and user maintenance shall not be made by children without supervision. Keep the appliance and its cord out of reach of children less than 8 years.
- When this oven is installed, it should be easy to isolate the appliance from the electricity supply by pulling out the plug or operating a circuit breaker.
- If the supply cord is damaged, it must be replaced by the manufacturer or its service agent or a similarly qualified person in order to avoid a hazard.
- Warning! The appliance should be inspected for damage to the door seals and door seal areas and if these areas are damaged the appliance should not be operated until it has been repaired by a service technician trained by the manufacturer.

Safety Instructions

- Warning! Do not attempt to tamper with or make any adjustments or repairs to the door, control panel housing, safety interlock switches or any other part of the oven. Do not remove the outer panel from the oven which gives protection against exposure to microwave energy. Repairs should only be by a qualified service person.
- Warning! Liquids and other foods must not be heated in sealed containers since they are liable to explode.
- Warning! Do not place this oven near an electric or gas cooker range.
- Warning! Only allow children to use the oven without supervision when adequate instructions have been given so that the child is able to use the oven in a safe way and understands the hazards of improper use. Ensure that children do not touch the hot outer casing after operation of the oven.
- This oven is intended for Counter-top use only. It is not intended for built-in use or for use inside a cupboard.

For Countertop use:

- Oven must be placed on a flat, stable surface 85 cm / 33 ½ inch above floor level, with rear of oven placed against a back wall. For proper operation, the oven must have sufficient air flow. i.e. 5 cm /2 inch at one side, the other being open; 15 cm /6 inch clear over the top; 10 cm /4 inch at the rear.
- When heating food in plastic or paper containers, check the oven frequently as these types of containers ignite if overheated.

Safety Instructions

- If smoke is emitted or a fire occurs in the oven, press Stop/Cancel pad and leave the door closed in order to stifle any flames. Disconnect the power cord, or shut off power at fuse or circuit breaker panel.
- This appliance is intended to be used in household applications only.
- Microwave heating of beverages can result in delayed eruptive boiling, therefore care must be taken when handling the container.
- The contents of feeding bottles and baby food jars are to be stirred or shaken. The temperature has to be checked before consumption to avoid burns.
- Do not cook eggs in their shells and whole hard-boiled eggs by **microwave**. Pressure may build up and the eggs may explode, even after the microwave heating has ended.
- The oven should be cleaned regularly and any food deposits removed.
- Clean the inside of the oven, door seals and door seal areas regularly. When food splatters or spilled liquids adhere to the oven walls, door seals and door seal areas wipe off with a damp cloth. Mild detergent may be used if they get very dirty. The use of harsh detergent or abrasive is not recommended.
- **Do not use commercial oven cleaners.**
- When using the **grill, convection** or **combination** mode, some foods may inevitably splatter grease on to the oven walls. If the oven is not cleaned occasionally, it may start to “smoke” during use.

Safety Instructions

- Failure to maintain the oven in a clean condition could lead to deterioration of surfaces that could affect the life of the appliance and possibly result in a hazardous situation.
- A steam cleaner is not to be used for cleaning the appliance.
- Warning! The accessible parts may become hot in grill, convection and combination use. Young children should be kept away. Children should only use the oven under adult supervision due to the temperatures generated.
- Exterior oven surfaces, including air vents on the cabinet and the oven door will get hot during **grill, convection, or combination** functions, take care when opening or closing the door and when inserting or removing food and accessories.
- The oven has a heating element situated in the top of the oven. After using either the **grill, convection** or **combination** functions, the inside surfaces of the oven will be very hot. Care should be taken to avoid touching any of the inside surfaces near the heating element inside the oven. **N.B. After cooking by these functions, the oven accessories will be very hot.**
- This appliance is not intended to be operated by means of an external timer or separate remote-control system.
- In case of electronic failure, oven can only be turned off at wall socket.
- Only use utensils that are suitable for use in microwave ovens.

Safety Instructions

- Do not use harsh, abrasive cleaners or sharp metal scrapers to clean the oven door glass since they can scratch the surface, which may result in shattering of the glass.
- The microwave oven is intended for heating food and beverages only. Take care when heating foods low in moisture, e.g. bread items, chocolate, biscuits and pastries. These can easily burn, dry out or catch on fire if cooked too long. We do not recommend heating foods low in moisture such as popcorn or poppadoms.
- Drying of food, newspapers or clothing and heating of warming pads, slippers, sponges, damp cloths, wheat bags, hot water bottles and similar may lead to risk of injury, ignition or fire.
- The oven lamp must be replaced by a service technician trained by the manufacturer. **Do not** attempt to remove the outer casing from the oven.
- Caution! In order to avoid a hazard due to inadvertent resetting of the thermal cut-out, this appliance must not be supplied through an external switching device, such as a timer, or connected to a circuit that is regularly switched on and off by the utility.



Important Safety Instructions

Read carefully and keep for future reference.

This appliance is supplied with a moulded three pin mains plug for your safety and convenience, which may be marked, and rated, 13 amps.

A 13 amp fuse is fitted according to the type of mains plug fitted.

Should the fuse need to be replaced, please ensure that the replacement fuse has the correct rating for the type of mains plug fitted and that it is approved by ASTA or BSI to BS1362.

Check for the ASTA mark  or the BSI mark  on the body of the fuse.



Warning!

If the fuse cover is detachable, never use the plug with the cover omitted. A replacement fuse cover can be purchased from your local Panasonic Dealer.

How to replace the fuse

Open the fuse compartment with a screwdriver and replace the fuse.

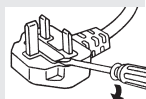

If the fitted moulded plug is unsuitable for the socket outlet in your home then the fuse should be removed and the plug cut off and disposed of safely and an appropriate one fitted. There is a danger of severe electrical shock if the cut off plug is inserted into any 13 amp socket.

If a new plug is to be fitted, please observe the wiring code as shown opposite. If in any doubt, please consult a qualified electrician (For U.K. Models only).



Warning!

This appliance must be earthed.



Important!

**The wires in this mains lead are coloured in accordance with the following code:
Green-and-yellow: Earth.
Blue: Neutral. Brown: Live.**

As the colours of the wire in the mains lead of this appliance may not correspond with the coloured markings identifying the terminals in your plug, proceed as follows:

The wire which is coloured **green-and-yellow** must be connected to the terminal in the plug which is marked with the letter **E** or by the Earth symbol  or coloured **green** or **green-and-yellow**.

The wire which is coloured **blue** must be connected to the terminal in the plug which is marked with the letter **N** or coloured **black**.

The wire which is coloured **brown** must be connected to the terminal in the plug which is marked with the letter **L** or coloured **red**.

When this oven is installed it should be easy to isolate the appliance from the electricity supply by pulling out the plug or operating a circuit breaker.



Voltage & Power

The voltage used must be the same as specified on this microwave oven. Using a higher voltage than that which is specified is dangerous and may result in a fire or other type of accident causing damage.

Important Safety Instructions

Do not immerse cord, plug or oven in water. Keep cord away from heated surfaces. Do not let cord hang over the edge of table or work top. Do not plug your oven in via an extension cable as this can be dangerous. It is important to plug the oven directly into a wall socket.

The back of the appliance heats up during use. Do not allow the cord to be in contact with the back of the appliance or cabinet surface.

Disposal of Old Equipment



Only for European Union and countries with recycling systems

This symbol on the products, packaging, and/or accompanying documents means that used electrical and electronic products must not be mixed with general household waste.

For proper treatment, recovery and recycling of old products, please take them to applicable collection points in accordance with your national legislation.

By disposing of them correctly, you will help to save valuable resources and prevent any potential negative effects on human health and the environment.

For more information about collection and recycling, please contact your local municipality.

Penalties may be applicable for incorrect disposal of this waste, in accordance with national legislation.

Before Using your Oven

Examine your Oven

1. Unpack oven, remove all packing material, and examine the oven for any damage such as dents, broken door latches or cracks in the door. Notify dealer immediately if unit is damaged. Do **not** install if unit is damaged.

Guarantee

2. Your receipt is your guarantee, please keep safely.

Cord

3. If the supply cord of this appliance is damaged, it must be replaced by the manufacturer or it's service agent or a similarly qualified person in order to avoid a hazard.



Note

The appliance should be inspected for damage to the door seals and door seal areas. If these areas are damaged the appliance should not be operated until it has been repaired by a service technician trained by the manufacturer.

4. Before using **grill, convection** or **combination** function for the first time operate the oven without food and accessories (including glass turntable and roller ring) on **Convection** 220 °C for 5 minutes. This will allow the oil that is used for rust protection to be burned off. This is the only time that the oven is operated empty (except when preheating).



Caution! Hot Surfaces

Exterior oven surfaces, including air vents on the cabinet and the oven door will get hot during Combination/Grill/Convection. **Do not operate the oven empty** apart from point 4 above and when preheating. The appliance must not be operated by **microwave** or combination including microwave **without food in the oven**. Operation when empty will damage the appliance.

During use the appliance becomes hot. Care should be taken to avoid touching heating elements inside the oven. The accessible parts may become hot in combination use. Young children less than 8 years of age should be kept away. Children should only use the oven under adult supervision due to the temperatures generated.

Placement of your Oven

This oven is intended for countertop use only. It is not intended for built-in use or for use inside a cupboard. The microwave oven shall not be placed in a cabinet.

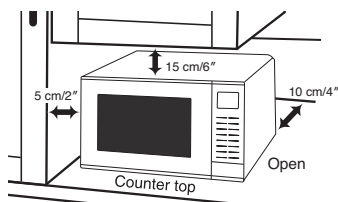

1. Oven must be placed on a flat, stable surface 85 cm / 33 ½ inch above floor level, with rear of oven placed against a back wall. For proper operation, the oven must have sufficient air flow, i.e. 5 cm / 2 inch at one side, the other being open; 15 cm / 6 inch clear over the top; 10 cm / 4 inch at the rear.
2. Do not place the microwave oven on a shelf directly above a gas or electric hob. This may be a safety hazard and the oven may be damaged.
3. Do not block the air vents on the sides and back of the oven. If these openings are blocked during operation the oven may overheat. In this case the oven is protected by a thermal safety device and resumes operation only after cooling down. The oven will remain inoperable with a blank display until it has cooled.
4. This appliance is intended to be used in household applications only.

Care & Cleaning of your Oven



Important

It is essential for the safe operation of the oven that it is kept clean and wiped out after each use. Failure to maintain the oven in a clean condition could lead to deterioration of a surface that could adversely affect the life of the appliance and possibly result in a hazardous situation.

1. **Switch the oven off before cleaning** and unplug at socket if possible.
2. **Keep the inside of the oven, door seals and door seal areas clean.** When food splatters or spilled liquids adhere to oven walls, door seals and door seal areas wipe off with a damp cloth. Mild detergent may be used if they get very dirty. The use of harsh detergent or abrasives is not recommended. Take care when cleaning around the waveguide cover.
3. After using **grill, convection or combination** cooking, the walls of the oven should be cleaned with a soft cloth and soapy water. Particular care should be taken to keep the window area clean especially after cooking by **grill, convection or combination**. Stubborn spots inside the oven can be removed by using a small amount of conventional oven-cleaner sprayed onto a soft damp cloth. Wipe onto problem spots, leave for recommended time and then wipe off. **Do not spray directly inside the oven.**

Care & Cleaning of your Oven

4. After use, the **oven interior** should be wiped out to remove any remaining water in order to reduce the risk of corrosion to the cavity and door. The cavity and door can be damaged by abrasive cleaners and sharp objects so care must be taken to avoid damage caused in this way. If the cavity or door become damaged the lining may begin to corrode. Providing the above precautions are taken regarding the cleaning and care of your oven the life of the cavity and door may be extended.
5. The **outside oven surface** should be cleaned with a damp cloth. To prevent damage to the operating parts inside the oven, water should not be allowed to seep into the ventilation openings.
6. If the **control panel** becomes dirty, clean with a soft, dry cloth. Do not use harsh detergents or abrasives on the control panel. When cleaning the control panel, leave the oven door open to prevent the oven from accidentally turning on. After cleaning press **Stop/Cancel** pad to clear display window.
7. Do not use harsh abrasive cleaners or sharp metal scrapers to clean the **oven door glass** since they can scratch the surface, which may result in shattering of the glass.
8. **Keep air vents clear at all times**
Check that no dust or other material is blocking any of the air vents on the top, bottom or rear of the oven. If air vents become blocked this could cause overheating which would affect the operation of the oven and possibly result in a hazardous situation.
9. **If steam accumulates** inside or around the outside of the oven door, wipe with a soft cloth. This may occur when the microwave oven is operated under high humidity conditions and in no way indicates a malfunction of the unit or microwave leakage.
10. It is occasionally necessary to remove the **glass turntable** for cleaning. Wash the turntable in warm soapy water. Do not place in the dishwasher.
11. The **roller ring and oven cavity floor** should be cleaned regularly to avoid excessive noise. Simply wipe the bottom surface of the oven, particularly the turntable spindle and the area surrounding this, with mild detergent and hot water then dry with a clean cloth. The roller ring may be washed in mild soapy water.

After removing the roller ring from cavity floor for cleaning, be sure to replace it in the proper position.
12. **When grilling or cooking by convection or combination**, some foods may splatter grease onto the oven walls. If the oven is not cleaned to eliminate this grease, it can accumulate and cause the oven to 'smoke' during use. These marks will be more difficult to clean later.
13. A **steam cleaner** is not to be used for cleaning.
14. Users are advised to **avoid any downward pressure** on the microwave door when in the open position. There is a safety risk that the oven will tilt forward.

Maintenance of your Oven

Service

1. **When your oven requires a service** call your local Panasonic engineer (**Customer Communications Centre** on **0344 844 3899** can recommend an engineer).

Door Seals

2. Do not attempt to tamper with or make any adjustments or repairs to door, control panel housing, safety interlock switches or any other part of the oven. Do not remove outer panel from oven. The door seals and door seal areas should always be kept clean – use a damp cloth.

Oven Light

3. The oven lamp must be replaced by a service technician trained by the manufacturer. **Do not** attempt to remove the outer casing from the oven.

Selected Spares and Accessories

4. These may be ordered direct; on line at **www.panasonic.co.uk** or by telephoning the **Customer Communications Centre** on **0344 844 3899**. Most major credit and debit cards accepted. Ensure you quote the correct model number.



Warning!

It is hazardous for anyone other than a competent person to carry out any service or repair operation which involves the removal of a cover which gives protection against exposure to microwave energy.

The appliance should be inspected for damage to the door seals and door seal areas. If these areas are damaged the appliance should not be operated until it has been repaired by a service technician trained by the manufacturer.

Parts of your Oven

1. Do not operate the oven without the roller ring and glass turntable in place.
2. Only use the glass turntable specifically designed for this oven. Do not substitute with any other glass turntable.
3. If glass turntable is hot, allow to cool before cleaning or placing in water.
4. Do not cook directly on glass turntable. Always place food in a microwave safe dish. The only exception to this is when cooking jacket potatoes on microwave only.
5. If food or utensils on the glass turntable touch the oven walls this will cause the turntable to stop moving. It will then automatically rotate in the opposite direction. This is normal. Open oven door, reposition the food and restart.
6. The glass turntable can rotate in either direction. The maximum weight that can be placed on the turntable is 4 Kg (8 lb 14 oz) (this includes total weight of food and dish).
7. While cooking by **microwave** or **combination** the turntable may vibrate. This will not affect cooking performance.
8. The metal accessories provided must **only** be used as directed for **grilling convection** and **combination** cooking. Never use them on **microwave** only. Do not use if operating the oven with less than 200 g (7 oz) of food on a manual **combination** program. **Failure to use accessories correctly could damage your oven.**
9. Arcing may occur if the incorrect weight of food is used, a metal container has been used incorrectly, or the accessories have been damaged. If this occurs, stop the machine immediately. You can continue to cook by **grill or convection only.**
10. Always refer to instructions for correct accessories to use on all programs. The glass turntable and roller ring are the only accessories used for **microwave** cooking. For **convection** and **combination** cooking the enamel tray must **always** be in place on the glass turntable (unless stated).

Parts of your Oven

- 1. Door release**
Press to open the door. When you open the oven door during cooking, the cooking is stopped temporarily without clearing earlier made settings. The cooking is resumed as soon as the door is closed and Start pad pressed.
- 2. See-through oven window**
- 3. Door safety lock system**
- 4. Oven lamp**
- 5. Waveguide cover (do not remove)**
- 6. External oven air vents**
- 7. Control panel**
- 8. Power supply cord**
- 9. Plug**
- 10. Identification plate**
- 11. Glass turntable**
The glass turntable and roller ring are the only accessories used for microwave cooking.
- 12. Roller ring**
(i). The roller ring and oven floor should be cleaned frequently to prevent excessive noise.
(ii). The roller ring must always be used together with the glass turntable for cooking.
- 13. Heating elements**
- 14. Caution label (hot surfaces)**
- 15. Menu label**
- 16. Wire rack**
- 17. Enamel tray**
- 18. Warning label**

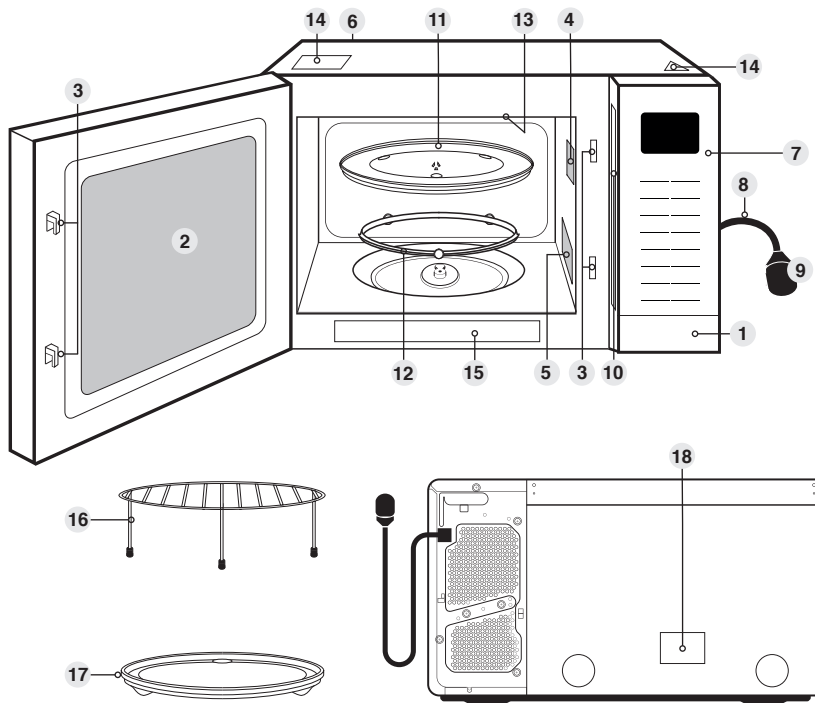

Note

1. The illustration is for reference only.
2. The glass turntable, wire rack and enamel tray are the only accessories with this oven. All other cooking utensils mentioned in this manual must be purchased separately.

Important Information - Read Carefully

Safety

If smoke is emitted or a fire occurs in the oven, press Stop/Cancel pad and leave the door closed in order to stifle any flames. Disconnect the power cord, or shut off power at fuse or circuit breaker panel.

Short Cooking Times

As microwave cooking times are much shorter than other cooking methods it is essential that recommended cooking times are not exceeded without first checking the food.

Cooking times given in the cookbook are approximate. Factors that may affect cooking times are: preferred degree of cooking, starting temperature, altitude, volume, size and shape of foods and utensils used. As you become familiar with the oven, you will be able to adjust these factors.

It is better to initially undercook rather than overcook foods. If food is undercooked, it can always be returned to the oven for further cooking. If food is overcooked, nothing can be done. Always start with minimum cooking times.



Important

If the recommended cooking times are exceeded the food will be spoiled and in extreme circumstances could catch fire and possibly damage the interior of the oven.

Small Quantities of Food

Take care when heating small quantities of food as these can easily burn, dry out or catch fire if cooked too long. Always set short cooking times and check the food frequently.



Note

Never operate the oven without food inside (except when preheating).

Foods Low in Moisture

Take care when heating foods low in moisture, e.g. bread items, chocolate, biscuits and pastries. These can easily burn, dry out or catch on fire if cooked too long. We do not recommend heating foods low in moisture such as popcorn or poppadoms. The microwave oven is intended for heating food and beverages only. Drying of food, newspapers or clothing and heating of warming pads, slippers, sponges, damp cloth, wheat bags, hot water bottles and similar may lead to risk of injury, ignition or fire.

Christmas Pudding

Christmas puddings and other foods high in fats or sugar, e.g. jam, mince pies, must not be over heated. These foods must never be left unattended as with over cooking these foods can ignite.

Boiled Eggs

Eggs in their shell and whole hard boiled eggs should not be heated in microwave ovens since they may explode even after microwave heating has ended.

Foods with Skins

Potatoes, apples, egg yolk, whole vegetables and sausages are examples of food with non porous skins. These must be pierced using a fork before cooking to prevent bursting.

Important Information - Read Carefully



Warning!

Liquids and other foods must not be heated in sealed containers since they are liable to explode.

Liquids

When heating liquids, e.g. soup, sauces and beverages in your microwave oven, overheating the liquid beyond boiling point can occur without evidence of bubbling.

This could result in a sudden boil over of the hot liquid. To prevent this possibility the following steps should be taken:

- a. Avoid using straight-sided containers with narrow necks.
- b. Do not overheat.
- c. Stir the liquid before placing the container in the oven and again halfway through the heating time.
- d. After heating, allow to stand in the oven for a short time, stirring again before carefully removing the container.
- e. Microwave heating of beverages can result in delayed eruptive boiling, therefore care should be taken when handling the container.

Lids

Always remove the lids of jars and containers and takeaway food containers before you microwave them. If you don't then steam and pressure might build up inside and cause an explosion even after the microwave cooking has stopped.

Deep Fat Frying

Do not attempt to deep fat fry in your oven.

Meat Thermometer

Use a meat thermometer to check the degree of cooking of joints and poultry only when meat has been removed from the microwave. If undercooked, return to the oven and cook for a few more minutes at the recommended power level. Do not leave a conventional meat thermometer in the oven when microwaving.

Paper & Plastic

When heating food in plastic or paper containers keep an eye on the oven due to the possibility of ignition. Do not use wire twist-ties with roasting bags as arcing will occur. Do not use recycled paper products, e.g. kitchen roll unless they say they are specifically designed for use in a microwave oven. These products contain impurities which may cause sparks and/or fires when used.

Reheating

It is essential that reheated food is served piping hot. Remove the food from the oven and check that it is piping hot, i.e. steam is being emitted from all parts and any sauce is bubbling. (If you wish you may choose to check the food has reached 75 °C with a food thermometer – but remember do not use this thermometer inside the microwave).

For foods that cannot be stirred, e.g. lasagne, shepherds pie, the centre should be cut with a knife to test it is well heated through. Even if a manufacturer's packet instructions have been followed always check the food is piping hot before serving and if in doubt return your food to the oven for further heating.

Important Information - Read Carefully

Standing Time

Standing time refers to the period at the end of cooking or reheating when food is left before being eaten, i.e. it is a rest time which allows the heat in the food to continue to conduct to the centre, thus eliminating cold spots. See page 21.

Keeping your Oven Clean

It is essential for the safe operation of the oven that it is wiped out regularly. Use warm soapy water, squeeze the cloth out well and use to remove any grease or food from the interior. Pay particular attention to the door seal area and also the areas around the microwave feed guide situated on the right hand side of the cavity wall. The oven should be unplugged when cleaning.

Fan Motor Operation

After using the oven the fan motor may rotate for a few minutes to cool the electric components. This is normal and you can take out food even though the fan motor operates. You can continue using the oven during this time.

Grilling

The oven will only operate on the **grill** function with the door closed.

Babies Bottles and Food Jars

When reheating babies bottles always remove top and teat. Liquid at the top of the bottle will be much hotter than that at the bottom and must be shaken thoroughly before checking the temperature. The lid must also be removed from babies food jars, the contents must also be stirred or shaken before the temperature is checked. This should be carried out before consumption to avoid burns. See page 64.

Arcing

Arcing may occur if a metal container has been used accidentally or if the incorrect weight of food is used or the accessories have been damaged. Arcing is when blue flashes of light are seen in the microwave oven. If this occurs, stop the machine immediately. If the oven is left unattended and this continues it can damage the machine. You can continue to cook by **grill or convection only**.

Maximum Weight on Turntable

The maximum weight that can be placed on the turntable is 4 kg (8 lb 14 oz) (this includes total weight of food and dish).

Utensils/Containers

Before use check that utensils / containers are suitable for use in microwave ovens. See pages 24-25.

Storage of Accessories

Do not store any objects other than oven accessories inside the oven in case it is accidentally turned on.



Do not operate the oven empty (except when preheating and when burning off the oil, see point 4 on page 11). The appliance must not be operated by microwave or combination without food in the oven. Operation when empty will damage the appliance.

Microwaving Principles

Microwave energy has been used in this country to cook and reheat food since early experiments with radar in World War II. Microwaves are present in the atmosphere all the time, both naturally and from manmade sources.

Manmade sources include radar, radio, television, telecommunication links and mobile phones.

How Microwaves Cook Food

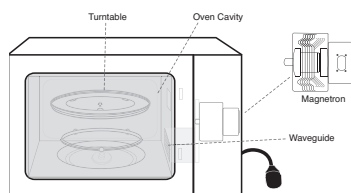

Reflection

The microwaves bounce off the metal walls and the metal door screen.

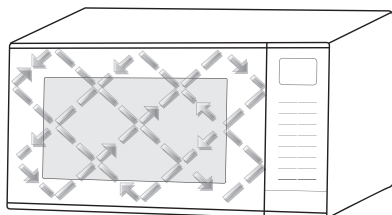

In a microwave oven, electricity is converted into microwaves by the **magnetron**.

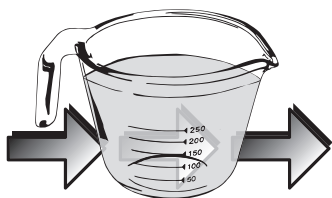

Transmission

Then they pass through the cooking containers to be absorbed by the water molecules in the food, all foods contain water to a more or lesser extent.

The microwaves cause the water molecules to vibrate which causes **friction**, i.e. **heat**. This heat then cooks the food. Microwaves are also attracted to fat and sugar particles, and foods high in these will cook more quickly. Microwaves can only penetrate to a depth of 4-5 cm (1½-2 inch) and as heat spreads through the food by conduction, just as in a traditional oven, the food cooks from the outside inwards.



Note

The dish used to cook or reheat the food will get warm during cooking, as the heat conducts from the food. Even in microwaving, oven gloves are required!

Microwaves cannot pass through metal and therefore metal cooking utensils can never be used in a microwave, for cooking on microwave only.

Foods Not Suitable for Cooking by Microwave Only

Yorkshire puddings, souffles, double crust pastry pies. This is because these foods rely on dry external heat to cook correctly, do not attempt to cook by microwave. Foods that require deep fat frying cannot be cooked either.

Standing Time

When a microwave oven is switched off, the food will continue to cook by conduction – **not by microwave energy**. Hence **standing time** is very important in microwaving, particularly for dense foods i.e. meat, cakes and reheated meals (Refer to page 21).



Boiled Eggs

Do not boil eggs in your microwave. Raw eggs boiled in their shells can explode and cause serious injury.

General Guidelines

Standing Time

Dense foods e.g. meat, jacket potatoes and cakes, require a **standing time** (inside or outside of the oven) after cooking, to allow heat to finish conducting through the food.

■ Jacket Potatoes

After being cooked in microwave only, remove and wrap in aluminium foil to stand. It is not necessary to stand jacket potatoes cooked in **combination** mode. Stand for 15 minutes.

■ Fish

Stand for 2-3 minutes.

■ Egg Dishes

Stand for 1-2 minutes.

■ Precooked Convenience Food

Stand for 1-2 minutes.

■ Meat Joints

Stand 15 minutes wrapped in aluminium foil.

■ Plated Meals

Stand for 2-3 minutes.

■ Vegetables

Boiled potatoes benefit from standing for 1-2 minutes, however most other types of vegetables can be served immediately.

■ Defrosting

It is essential to allow standing time to complete the process. This can vary from 5 minutes e.g. raspberries, to up to 1 hour for a joint of meat. See pages 34-35.

If food is not cooked after **standing time**, return to oven and cook for additional time.



Piercing

The skin or membrane on some foods will cause steam to build up during cooking. These foods must be pierced or a strip of skin should be peeled off before cooking to allow the steam to escape. Eggs, potatoes, apples, sausages etc. will all need to be pierced before cooking. **Do not attempt to boil eggs in their shells.**



Moisture Content

Many fresh foods e.g. vegetables and fruit, vary in their moisture content throughout the season. Jacket potatoes are a particular example of this. For this reason cooking times may have to be adjusted throughout the year. Dry ingredients e.g. rice, pasta, can dry out further during storage and cooking times may differ from freshly purchased ingredients.

General Guidelines



Cling Film

Cling film helps keep the food moist and the trapped steam assists in speeding up cooking times. Cling film should be pierced before cooking, to allow excess steam to escape. Always take care when removing cling film from a dish as the build-up of steam will be very hot. Always purchase cling film that states on the packet "suitable for microwave cooking" and use as a covering only. Do not line dishes with cling film. Do not cover foods when cooking by **grill, convection** or **combination**.

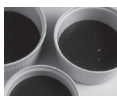

Dish Size

Follow the dish sizes given in the recipes, as these affect the cooking and reheating times. A quantity of food spread in a bigger dish cooks and reheats more quickly.



Quantity

Small quantities cook faster than large quantities, also small meals will reheat more quickly than large portions.



Spacing

Foods cook more quickly and evenly if spaced apart. **Never** pile foods on top of each other.



Shape

Even shapes cook evenly. Food cooks better by microwave when in a round container rather than square.

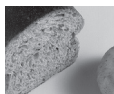

Density

Porous airy foods heat more quickly than dense heavy foods.



Covering

Cover foods with microwave cling film or a self-fitting lid. Cover fish, vegetables, casseroles, soups. Do not cover cakes, sauces, jacket potatoes, pastry items. Please refer to cooking charts and recipes for more information.



Arranging

Individual foods e.g. chicken portions or chops, should be placed on a dish with the thicker parts to the outside.



Ingredients

Foods containing fat, sugar or salt heat up very quickly. The filling may be much hotter than the pastry. Take care when eating. **Do not** overheat even if the pastry does not appear to be very hot.

General Guidelines



Starting Temperature

The colder the food, the longer it takes to heat up. Food from a fridge takes longer to reheat than food at room temperature. Food temperature should be between 5-8 °C before cooking.



Turning and Stirring

Some foods require stirring during cooking. Meat and poultry should be turned after half the cooking time.



Liquids

All liquids must be stirred **before, during** and **after heating**. Water especially must be stirred before and during heating, to avoid eruption. Do not heat liquids that have previously been boiled. **Do not overheat.**



Checking Food

It is essential that food is checked during and after a recommended cooking time, even if an **auto program** has been used (just as you would check food cooked in a conventional oven). Return the food to the oven for further cooking if necessary.



Cleaning

As microwaves work on food particles, keep your oven clean at all times. Stubborn spots of food can be removed by using a branded oven cleaner, sprayed onto a soft cloth. Always wipe the oven dry after cleaning. Avoid any plastic parts and door area. Customers should not spray directly into the cavity.

Containers to Use



Choosing the correct container is a very important factor in deciding the success or failure of your cooking.

Testing Dishes for Suitability for Microwave Cooking Only

When unsure that a cooking container is suitable for use in your microwave, check by the following test:

1. Fill a microwave safe measuring jug with 300 ml ($\frac{1}{2}$ pt) cold water.
2. Place it on the turntable alongside the dish to be tested. If the dish you are testing is a large dish, then stand the measuring jug on top of the empty dish.

3. Heat on **High** microwave for 1 minute.

Result

If the dish is suitable for microwaving, it will remain cool, whilst the water in the jug will begin to feel warm. If the testing dish feels warm, do not use as it is absorbing microwave energy.



Note

This test does not apply to plastic or metal based containers e.g. Le Creuset® style dishes, which should not be used as they are cast iron covered with enamel.

Quick Check Guide to Cooking Utensils



Oven Glass

Everyday glass that is heat resistant e.g. Pyrex®, is ideal for microwave, convection or combination cooking. Do not use for grilling on the wire rack. Do not use delicate glass or lead crystal which may crack or arc.



China and Ceramic

Everyday glazed china, porcelain or ceramic plates, bowls, mugs and cups can be used if they are heat resistant. Fine bone china should only be used for reheating for short periods. Do not use dishes with a metal rim or pattern. Do not use jugs or mugs with glued handles, since the glue can melt. If dishes are heat resistant they may be used on **convection** and **combination** but not directly under the grill.



Pottery, Earthenware, Stoneware

If completely glazed, these dishes are suitable. Do not use if partially glazed or unglazed, since they are able to absorb water which in turn absorbs microwave energy, making the container very hot and slows down the cooking of food.



Foil/Metal Containers

Never attempt to cook in foil or metal containers on microwave only as the microwaves cannot pass through and the food will not heat evenly, it may also damage your oven. Foil and metal containers can be used on **grill** or **convection** functions and may be used with care during certain **combination** cooking as long as they are not damaged or dented.

Containers to Use



Plastic

Many plastic containers are designed for microwave use, but do not use for cooking foods high in sugar or fat or for foods that require long cooking times e.g. brown rice. Only use Tupperware® containers if they are designed for microwave use.



Do not use Melamine. Never cook in margarine cartons or yoghurt pots, as these will melt with the heat from the food. If heatproof they can be used for combination cooking. **Do not use under the grill.**



Paper

Plain white absorbent kitchen paper (kitchen towel) can only be used for microwave cooking e.g. covering bacon to prevent splattering.

Only use for short cooking times. Never re-use a piece of kitchen towel. Always use a fresh piece of paper for each dish.

Avoid kitchen paper containing manmade fibres.

If you are using branded recycled kitchen towel, check first that it is recommended for microwave use. Do not use waxed or plastic coated cups or plates as the finish may melt.

Greaseproof paper can be used to line the base of dishes and to cover when blind baking pastry cases. White paper plates can be used for **short reheating times**, on microwave only.



Wicker, Wood, Straw Baskets

Dishes will crack and could ignite. Do not use wooden dishes in your microwave. **Do not use on any cooking mode.**



Cling Film

Microwave cling film can only be used for covering food that is reheated by microwave. It is also useful for covering food to be cooked, but care should be taken to avoid the film being in direct contact with the food e.g. Do not line dishes with cling film. **Do not use on any other cooking mode.**



Roasting Bags

Roasting bags are useful when slit up one side to tent a joint, for roasting by power and time. Do not use the metal twists supplied, when using microwave or combination.





Aluminium Foil

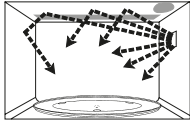
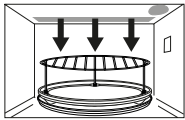

Small amounts of smooth aluminium foil can be used to **shield** joints of meat during defrosting and cooking by microwave, as the microwaves cannot pass through the foil, this prevents the parts shielded from overcooking or overdefrosting. Take care that the foil does not touch the sides or roof of the oven, as this may cause arcing and damage your oven. Aluminium foil can be used for convection cooking.

Cooking Modes

The diagrams shown below are examples of the accessories. It may vary depending on recipe/dish used. Further information can be found in the Cookbook.

Cooking modes	Uses	Accessories to use	Containers
<p>Microwave</p> 	<ul style="list-style-type: none"> Defrosting Reheating Melting: butter, chocolate, cheese. Cooking fish, vegetables, fruits, eggs. Preparing: stewed fruits, jam, sauces, custards, choux, pastry, caramel, meat, fish. Baking cakes without colour. <p>No Preheating</p>	-	<p>Use your own Pyrex[®] dishes, plates or bowls, directly on the glass turntable.</p> <p>No metal.</p>
<p>Grill</p> 	<ul style="list-style-type: none"> Grilling of meat or fish. Toast grilling. Colouring of gratin dishes or meringue pies. <p>No preheating</p>	Wire rack on enamel tray	<p>Use your own Pyrex[®] dishes, heatproof plates or bowls, directly on the wire rack on enamel tray on glass turntable.</p>
<p>Convection</p> 	<ul style="list-style-type: none"> Baking of small items with short cooking times: puff pastry, cookies, roll cakes. Special baking: bread rolls or brioches, sponge cakes. Baking of pizzas and tarts. <p>Preheating advised</p>	Enamel tray	<p>Heatproof, metal tin can be used on enamel tray. Do not place dishes directly on glass turntable.</p>

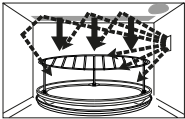
Cooking Modes

Cooking modes	Uses	Accessories to use	Containers
<p>Grill + microwave</p> 	<ul style="list-style-type: none"> • Cooking lasagne, meat, potatoes or vegetable gratins. <p>No Preheating</p>	<p>Wire rack on enamel tray</p>	<p>Microwaveable and heatproof dishes placed directly on wire rack on enamel tray on, glass turntable.</p> <p>No metal.</p>
<p>Convection + microwave</p> 	<ul style="list-style-type: none"> • Baking cakes • Puff pastry tarts <p>Preheating if necessary</p>	<p>Enamel tray</p>	<p>Microwaveable and heatproof dishes can be used on the enamel tray.</p> <p>Do not place dishes directly on glass turntable.</p> <p>No metal.</p>

Control Panels

NN-CT54JW, NN-CT55JW,
NN-CT56JB, NN-CT57JM *

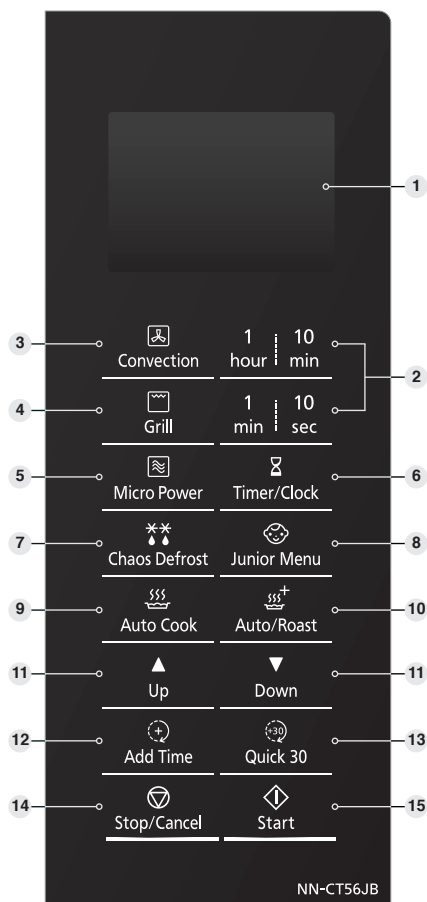

- 1 Display window
- 2 Time pads
- 3 Convection pad (pages 40-41)
- 4 Grill pad (pages 38-39)
- 5 Micro Power pad (pages 31-32)
- 6 Timer/Clock pad (pages 30, 49-50)
- 7 Auto weight defrost-Chaos Defrost programs (pages 33-34)
- 8 Junior Menu programs (pages 55-57)
- 9 Auto Cook programs (pages 58-59)
- 10 Auto/Roast programs (pages 60-62)
- 11 Up and Down pads
- 12 Add Time pad (page 37)
- 13 Quick 30 pad (page 37)
- 14 Stop/Cancel pad:
Before cooking:
One press clears your instructions
During cooking: one press temporarily stops the cooking program. Another press cancels all your instructions and the time of day will appear in the display.
- 15 Start pad

Press to start operating the oven. If during cooking the door is opened or Stop/Cancel is pressed once, Start has to be pressed again to continue cooking.

This oven is equipped with an energy saving function.

* The design of your control panel may vary from the panel displayed, but the words on the pads will be the same.



Beep Sound

A beep sounds when a pad is pressed. If this beep does not sound, the setting is incorrect. When the oven changes from one function to another, two beeps sound. After completion of cooking, five beeps sound.



Note

When in stand-by mode the brightness of the display will be reduced. The oven will enter stand-by mode, when first plugged in and immediately after the last operation has completed.

If an operation is set and Start pad is not pressed, after 6 minutes the oven will automatically cancel the operation. The display will revert back to clock mode.

Let's Start to Use Your Oven

NN-CT54JW, NN-CT55JW,
NN-CT56JB, NN-CT57JM *

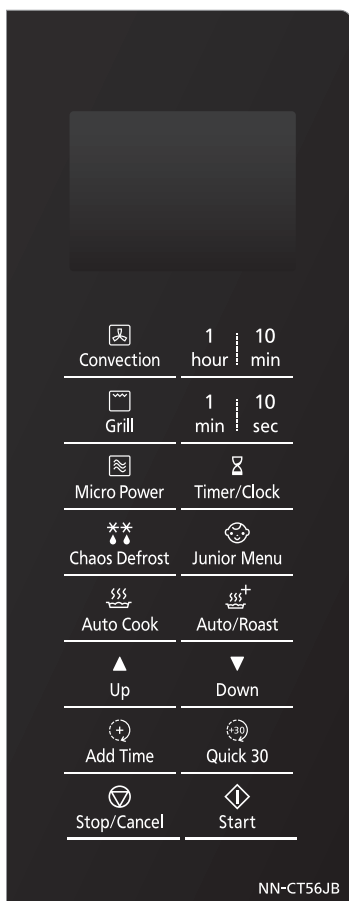

* The design of your control panel may vary from the panel displayed, but the words on the pads will be the same.

1 Plug in

Plug into a 13 amp fused electrical socket. You will be reminded to read your operating instructions.

2 Lb/oz Conversion

Default weight is grams. To select weight in pounds and ounces, after first plug in, press Start pad once. Press again to change to grams.

3 Press Timer/Clock pad Twice to Set Clock

Set clock as a 24 hr clock.
(See page 30).

4 Press Convection pad

 will appear in the display window with the oven temperature. This procedure is to burn off the oil used for rust protection in the oven. Press Convection pad until 220 °C appears in the display window. Remove all accessories from the oven.

5 Press Time pads

Press 1 min pad until 5 minutes is displayed in the window.

6 Press Start

The time will be displayed in the window and count down. The oven will beep at the end of the program. The oven is now ready to use. Caution: heating elements and oven will be hot.

7 Demonstration Mode

This is to enable you to experiment setting various programs. (The letter D will always appear in the display window. This is to confirm that there is no microwave power produced and it is safe to use the oven without any food). To select this mode press the Micro Power pad once and then Stop/Cancel 4 times. "DEMO MODE PRESS ANY KEY" will appear. To cancel press the Micro Power pad once and then Stop/Cancel 4 times.

8 Child Lock

To operate the child lock facility press the Start pad three times, this will make the oven controls inoperable, however, the door can be opened.  will appear in the display and none of the controls will operate. To clear child lock facility press Stop/Cancel three times. To activate or cancel child lock, Start or Stop/Cancel must be pressed 3 times within a 10 second period. Child Lock can be set when a colon or the time of day is displayed.

Setting the Clock

Example of how to set 11:25am.

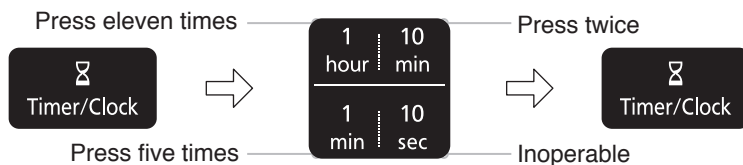

Press Timer/Clock twice
“SET TIME” will appear in the display window, and the colon starts to blink.

Press time pads
Enter time of day by pressing time pads. e.g. 11:25am (24 hr clock). 10 sec pad is inoperable.

Press Timer/Clock
The colon stops blinking. Time of day is now locked into the display.



Note

1. To reset time of day, repeat step 1 through to step 3, as above.
2. The clock will keep the time of day as long as the oven is plugged in and electricity is supplied.
3. This is a 24 hour clock, i.e. 2pm = 14:00 not 2:00.

Operation Guide Setting

To assist you in programming your oven, the following operation will appear in the display window. When you become familiar with your oven, the operation guide can be turned off.

To turn off:

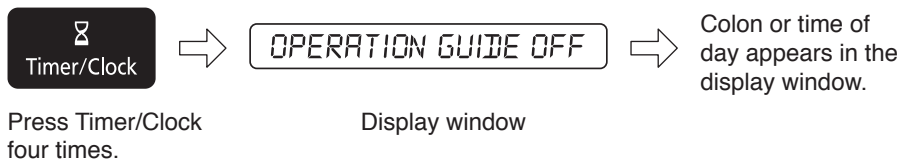



Microwave Cooking and Defrosting

There are six different microwave power levels available.

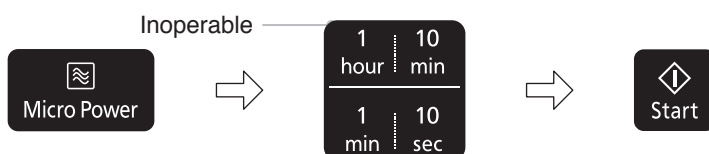
Press	Level	Wattage
Once	High	1000 W
Twice	Defrost	270 W
3 Times	Medium	600 W
4 Times	Low	440 W
5 Times	Simmer	300 W
6 Times	Warm	100 W



Press Micro Power

Press this pad until the power you require appears in the display window. The microwave symbol  will also appear. When you select Defrost,  will also appear.

Set time

Select cooking time. Your oven can be programmed for up to 99 minutes 50 seconds on Medium, Low, Simmer, Defrost and Warm microwave. High microwave can be programmed for 30 minutes. The 1 hour pad is inoperable.

Press Start

The cooking program will start and the time in the display will count down.

Note

1. Maximum time that can be set on **High** microwave is 30 minutes.
2. On all power levels, except **High** microwave, the maximum time that can be set is 99 minutes, 50 seconds. The 1 hour pad is inoperable.
3. You can increase the cooking time during cooking if required. Time can be increased in 1 minute increments, up to 10 minutes. Press 'Add time' pad once, then press '1 min' pad to a maximum of 10 minutes. After selecting 'Add Time' function, time should be added within a 5 second period. Cooking time can not be decreased during cooking.

Microwave Cooking and Defrosting



Note

4. For manual defrosting times, please refer to defrost chart on page 36.
5. For multi-stage cooking refer to page 48.
6. Stand time can be programmed after microwave power and time setting. Refer to using the timer on pages 49-50.

Accessory to Use

When using your oven on **microwave** only, the glass turntable provided must always be in position. **Do not** attempt to use microwave only with any metal accessory in the oven.

Do not place food directly onto the turntable except in the case of jacket potatoes cooked by **microwave** only.

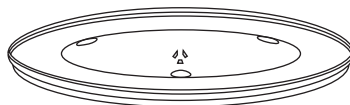

Foods reheated or cooked by **microwave** only are normally covered with a lid or cling film, unless otherwise stated.



Auto Weight Defrost - Chaos Defrost

With this feature you can defrost frozen foods according to the weight. Select the category and set the weight of the food. The weight can be programmed in grams or pounds and ounces. The weight starts from the minimum weight for each category.



Select the desired program by pressing pad once, twice or three times. The microwave  and defrost  symbol will also appear.

Enter the weight by pressing the up and down pads. The “up” pad will start with the minimum weight for each food. Default weight is grams. To change weight to pounds and ounces refer to page 29.

Press Start

Program	Weight Range	Suitable Food
1. Bread	100 g - 900 g (4 oz - 2 lb)	Bread and rolls. Turn at beep. Standing time 10-15 minutes.
2. Mince/ chops	200 g - 1200 g (7 oz - 2 lb 10 oz)	Small pieces of meat, minced meat, chicken portions, steaks, chops. Turn at beeps and shield. Standing time 15-30 minutes.
3. Meat Joints	400 g - 2000 g (14 oz - 4 lb 7 oz)	Whole chicken, meat joints. Turn at beeps and shield. Standing time of at least 1 hour.

This feature allows you to defrost minced meat, chops, chicken portions, meat joints and bread.

The **Chaos Defrost** pad should be pressed to select the correct category and then enter in the weight of the food in grams or pounds and ounces using the up and down pads.

Foods should be placed in a suitable dish, whole chickens and joints of meat should be on an upturned saucer or on a micro-safe rack. Chops, chicken portions and slices of bread should be placed in a single layer. It is not necessary to cover the foods. The **Chaos** Theory principle is used in Auto Weight defrost programs to give you a quick and more even defrost. The **Chaos** system uses a random sequence of pulsing microwave energy which speeds up the defrosting process. During the program the oven will beep to remind you to check the food. **It is essential that you turn and stir the food frequently and shield if necessary** (See pages 34-35). On hearing the first beep you should **turn** and **shield** (if possible). On the second beep you should turn the food or break it up.

Auto Weight Defrost - Chaos Defrost

1st Beep
Turn



1st Beep
Or shield

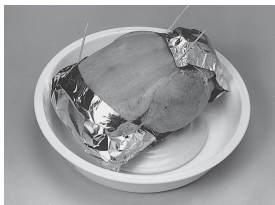

2nd Beep
Turn or break up



Category 1 Bread

The Bread Program is suitable for defrosting small items e.g. rolls, buns and slices of bread which are required for immediate use. Small items may feel warm immediately after defrosting. Loaves can also be defrosted on this program but these will require standing time to allow the centre to thaw out. Standing time can be shortened if slices are separated and buns and loaves cut in half. Items should be turned halfway during defrosting. **This program is not suitable for cream cakes or desserts** e.g. cheesecake.

Category 2 Mince / chops (mince/chops/chicken portions)

It is necessary for mince to be broken up frequently during defrosting and this is best carried out in a large shallow dish. Chops and chicken portions should be arranged in a single layer and turned frequently.

Category 3 Meat joints/whole chickens

Meat joints and chickens will require shielding during defrosting especially if they are particularly fatty pieces. This is to prevent over defrosting on the outside edges. Smooth foil secured with cocktail sticks should be used. **Do not allow the foil to touch the walls of the oven.** Back fat of joints, legs, wings and breast bones need shielding. Standing time of at least 1 hour should be allowed (rolled joints may require longer) before cooking to ensure the centre is fully defrosted.

Defrosting Guidelines

For Best Results:

1. Place foods in a suitable container. Meat joints and chickens should be placed on an upturned saucer or on a plastic rack if you have one.
2. Check food during defrosting, as foods vary in their defrosting speed.
3. It is not necessary to cover the food.
4. Always turn or stir the food especially when the oven "beeps". Shield if necessary (see point 6).
5. Minced meat/chops/chicken portions should be broken up or separated as soon as possible and placed in a single layer.
6. Shielding prevents food cooking. It is essential when defrosting chickens and joints of meat. The outside thaws out first, so protect wings/breast and fat with smooth pieces of aluminium foil secured with cocktail sticks.
7. Allow standing time so that the centre of the food thaws out. (Minimum of 1 hour for joints of meat and whole chickens).

Defrosting Using Defrost Microwave and Time

By selecting the **Defrost** microwave level from the Micro Power pad, and setting a time, you can defrost food in your microwave. The biggest challenge is getting the inside defrosted before the outside starts to cook.

For this reason a defrost program alternates between a defrost microwave power and a standing time. The name for this type of defrost is

cyclic and during the standing stages there is not any microwave power in the oven, although the light will remain on and the turntable will turn. The automatic stand times ensure a more even defrost but it is still necessary to allow for standing time before use. Place foods in a suitable container. Meat joints and chickens should be placed on an upturned saucer.



Separate chops and small items e.g. bread slices where possible.

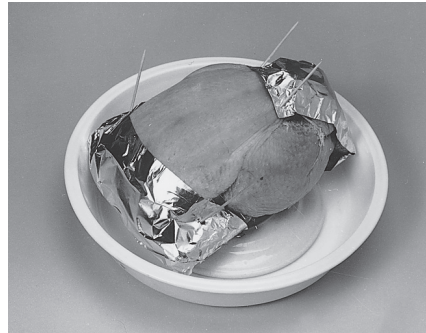

Chickens and joints of meat will require shielding during defrosting.



Turn dense foods and meat 2 or 3 times during defrosting.



Break up small items e.g. minced meat, frequently during defrosting.

Defrosting Chart Using Defrost Microwave and Time

Select **Defrost** microwave. The times given below are a guideline only. Always check the progress of the food by opening the oven door and then re-starting. For larger quantities adjust times accordingly. Food should not be covered during defrosting.

Food	Defrosting Time	Method	Standing Time
Meat			
Beef/Lamb/Pork joint 450 g (1 lb)	16-18 mins	Place in a suitable dish or on an upturned saucer or use a microwave safe rack. Turn 3-4 times. Shield.	60 mins
Minced beef 450 g (1 lb)	12 mins	Place in a suitable dish. Break up and turn 3-4 times.	15 mins
Chops 450 g (1 lb)	12-14 mins	Place in a suitable dish in a single layer. Turn twice. Shield if necessary.	15 mins
Sausages 450 g (1 lb)	13 mins	Place in a suitable dish in a single layer. Turn twice. Shield if necessary.	15 mins
Bacon rashers 450 g (1 lb)	7-9 mins	Place in a suitable dish. Turn and separate twice. Shield if necessary.	10 mins
Stewing steak 450 g (1 lb)	13 mins	Place in a suitable dish. Break up frequently.	15 mins
Whole chicken 450 g (1 lb)	13-15 mins	Place in a suitable dish on an upturned saucer or use a microwave safe rack. Turn 3-4 times. Shield.	60 mins
Chicken portions 450 g (1 lb)	11-13 mins	Place in a suitable dish in a single layer. Turn twice. Shield if necessary.	30 mins
Fish			
Whole 450 g (1 lb)	11-13 mins	Place in a suitable dish. Turn twice. Shield.	15 mins
Fillets/Steak 450 g (1 lb)	10-12 mins	Place in a suitable dish. Turn twice, separate and shield if necessary.	15 mins
Prawns 450 g (1 lb)	8-10 mins	Place in a suitable dish. Stir twice during defrosting.	15 mins
General			
Bread sliced 400 g (14 oz)	6 mins	Place on a plate. Separate and rearrange during defrosting.	10 mins
Slice of bread 30 g (1 oz)	40 secs - 50 secs	Place on a plate.	1-2 mins
Pastry 500 g (1 lb)	6 mins 30 secs	Place on a plate. Turn halfway.	15-30 mins
Soft fruit 450 g (1 lb)	10-11 mins	Place in a suitable dish. Stir twice during defrosting	15 mins

Using the Quick 30 Function

This function allows you to quickly set cooking time in 30 second increments.



Press **Quick 30** to set the desired cooking time (up to 5 minutes). Each press is 30 seconds. Time appears in the display. Power level is pre-set at **High** microwave.

Press Start
The cooking will start and the time in the display will count down. At the end of cooking, five beeps will sound.

Note

1. This function is only available for Micro Power. If desired, you can use other microwave power levels. Select desired power level before pressing **Quick 30**.
2. After setting the time by **Quick 30**, you can not use the time pads.
3. This function will not operate for 1 minute after manual cooking because of 'Add Time' function.
4. If you wish to operate within 1 minute, pressing Stop/Cancel will allow the operation.

Using the Add Time Function

This feature allows you to add cooking time at the end of previous cooking.

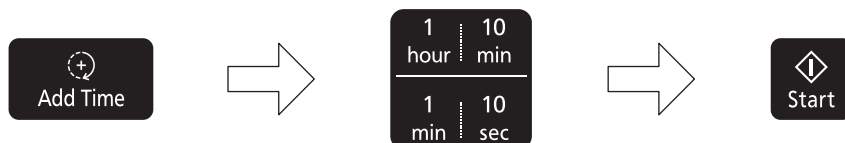

After cooking, press Add Time pad

Press time pads to add extra cooking time.

Maximum cooking time: Micro Power: High microwave up to 30 minutes; other microwave powers up to 99 minutes 50 seconds; Grill: 99 minutes 50 seconds; Convection, Combination and timer: 9 hours 59 minutes.

Press Start
Time will be added. The time in the display window will count down.

Note

1. This function is only available for Micro Power, Grill, Convection, Combination and Timer functions and it is not available for Auto programs.
2. The Add Time function will not operate after 1 minute cooking.
3. The Add Time function can be used after the multi-stage cooking and during cooking.
4. The power level is the same as the last stage.

Grilling

The Quartz Grill system on the oven gives fast efficient cooking for a wide variety of foods e.g. chops, sausages, steak, toast, oven chips etc.

Do not preheat the grill before use.

The enamel tray must be on the glass turntable when using.

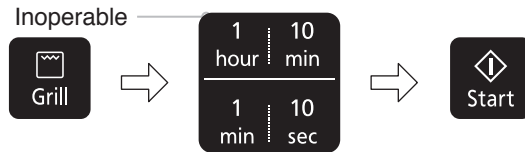

Press	Power Level	Wattage
Once	Grill 1 (High)	1300 W
Twice	Grill 2 (Medium)	950 W
3 Times	Grill 3 (Low)	700 W

Select Grill power

Press once for Grill 1 (High), twice for Grill 2 (Medium) or three times for Grill 3 (Low). The grill symbol  will also appear.

Press Time pads to enter cooking time.

Maximum time is 99 minutes 50 seconds, 1 hour pad is inoperable.

Press Start

The cooking program will start and the time in the display will count down.



Note

1. The Grill will only operate with the oven door closed, and there is no microwave power on the **grill** only program.
2. You can increase the cooking time during cooking if required. Time can be increased in 1 minute increments, up to 10 minutes. Press 'Add time' pad once, then press '1 min' pad to a maximum of 10 minutes. After selecting 'Add Time' function, time should be added within a 5 second period. Cooking time can not be decreased during cooking.

Grilling Times

When using the grill to cook foods, the cooking times will be similar to traditional grilling. Most foods will require turning halfway through the cooking time (see section on oven accessories page 39).

The Grill has three variable settings, Grill 1 (High), Grill 2 (Medium) and Grill 3 (Low). Grill 1 will be the hottest.



Caution!

The **accessories** and surrounding oven will get very hot. Use oven gloves.

Grilling

Oven Accessories to Use

When grilling foods the glass turntable should be in position, with the enamel tray and the wire rack on top.

Place food on wire rack on the enamel tray on the turntable. The wire rack will allow fat to drip through into the enamel tray to reduce excess splatter and smoke when grilling steaks, chops and other fatty foods.

Most foods require turning halfway during cooking. When turning food, open oven door and **carefully** remove the enamel tray and wire rack by holding the accessories firmly. Use oven gloves when removing accessories as they will be very hot, and so will the roof and walls of the oven.

After turning, return food to the oven, close door and press **Start**. The oven will continue to count down the remaining cooking time. It is quite safe to open the oven door at any time to check the progress of the food as it is grilling.

If grilling fish or small items, place the enamel tray on top of the wire rack.



Guidelines

1. There is no microwave power on the **Grill** only program.
2. Use the accessories provided, as explained.
3. The Grill will only operate with the oven door closed.
4. Most meat items e.g. bacon, sausages, chops can be cooked on the hottest setting - **Grill 1**. This setting is also suitable for toasting bread, muffins and teacakes etc.
5. **Grill 2** and **Grill 3** are used for more delicate foods or those that require a longer grill time e.g. fish or chicken portions.
6. **Do not preheat the grill.**
7. **Never cover the food when grilling.**
8. **Always use oven gloves when removing the food and accessories after grilling as the oven and accessories will be very hot.**
9. After grilling it is important that the grill accessories are removed for cleaning before reuse and that the oven walls and floor are wiped with a cloth squeezed in hot soapy water to remove any grease. **Do not put accessories in dish washer.**

Convection Cooking

Your microwave oven can be used in convection mode which incorporates a heating element with a fan. For best results always place food in a preheated oven. The enamel tray must be on the glass turntable when preheating.

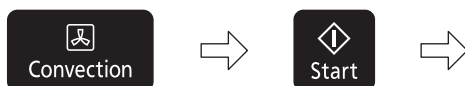

Press to select oven temperature. There is a choice of convection temperatures 40 °C and 100 °C - 220 °C.

For quick selection of the most commonly used cooking temperatures, the oven starts at 150 °C and then for each press the temperature will count up in 10 °C stages to 220 °C, then to, 40 °C, 100 °C, 110 °C etc. The convection symbol  will also appear.

Press Start to preheat

A "P" will appear in the display window. When the oven is preheated the oven will beep and the "P" will flash. Then open the door and place the food inside.*

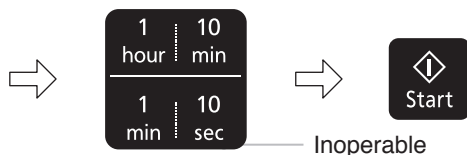

(Skip this step when preheating is not required)



Press time pads to enter cooking time

Maximum cooking time is 9 hours, 59 minutes. The 10 sec pad is inoperable.

Press Start

Note: Check that only the convection symbol  is still in the display. If the microwave symbol  is displayed this is incorrect and the program should be cancelled. Reselect the convection setting.

Note

- * Open the door using the door release pad, because if the Stop/Cancel pad is pressed the program may be cancelled.
- The oven will maintain the selected temperature for approximately 30 minutes. If no food has been placed inside the oven, then it will automatically cancel the cooking program "OPEN DOOR" will appear in the display window. If no cooking time is set, oven will revert to time of day after 6 minutes.
- You can increase the cooking time during cooking if required. Time can be increased in 1 minute increments, up to 10 minutes. Press 'Add time' pad once, then press '1 min' pad to a maximum of 10 minutes. After selecting 'Add Time' function, time should be added within a 5 second period. Cooking time can not be decreased during cooking.

Convection Cooking



Note

4. After pressing Start, the selected temperature can be recalled and changed. Press convection pad once to indicate the temperature in the display window. While the temperature is recalled in the display window, you can change the temperature by pressing Convection pad.
5. The oven cannot preheat to 40 °C.



Caution!

The accessories and the surrounding oven will get very hot. Use oven gloves.

Oven Accessories to Use

When using the Convection oven the glass turntable should be in position and must have the enamel tray placed on top.

The food is then placed onto the enamel tray. Follow your individual recipe guidelines.

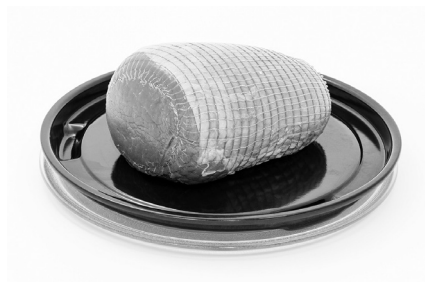

Roasting meat: glass turntable, enamel tray.



Baking: glass turntable, enamel tray.

When using the oven as a **convection** oven, there is **no microwave power**, i.e. the oven is operating as a conventional oven and you can use all your standard metal baking tins and ovenware.

It is not recommended to cook on more than one level when using the **convection** oven. When cooking 2 trays of buns etc, cook in two batches.

Combination Cooking

Your oven has two methods of cooking by Combination.

1. Convection and Microwave (with and without preheat)
2. Grill and Microwave (preheat is not possible)

Combination cooking is ideal for many foods. The microwave power cooks them quickly, whilst the convection or grill gives the traditional browning and crispness.

All this happens simultaneously resulting in most foods being cooked in $\frac{1}{2}$ - $\frac{2}{3}$ of the conventional cooking time.

There is no need to preheat on **combination** programs, **except when cooking pastry**.

It is possible to use smooth seamed metal tins and foil containers on **combination** but they must be placed directly onto the enamel tray on the glass turntable. They must not be placed directly onto the wire rack, or arcing will occur.

If you experience arcing, which is when you see blue sparks or hear crackling noises, the metal container is unsuitable or you have insufficient food in the oven. You should stop the program immediately and change the container or re-program to **convection** only.

To cook successfully by **combination** you should always use a minimum of 200 g (7 oz) food. Small quantities should be cooked by Convection, or Grill.

Preheat if necessary (convection and microwave combination only)

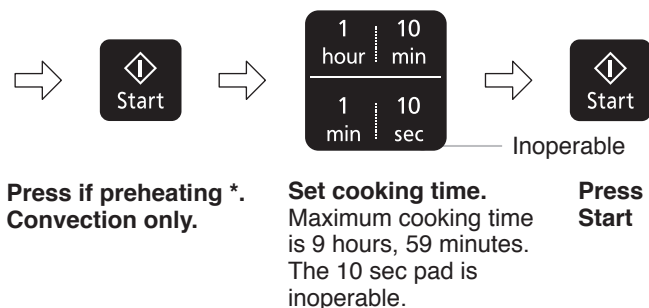
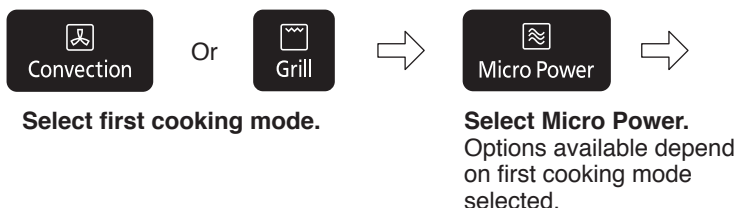

Combination Cooking



Caution!

Take care to use oven gloves when removing dishes from the oven - especially when turning or stirring foods as the oven walls and roof will be very hot.



* Note

1. When placing food in the oven after preheating, just open the door using the door release pad, because if **Stop/Cancel** pad is pressed the program may be cancelled.
2. You can increase the cooking time during cooking if required. Time can be increased in 1 minute increments, up to 10 minutes. Press 'Add time' pad once, then press '1 min' pad to a maximum of 10 minutes. After selecting 'Add Time' function, time should be added within a 5 second period. Cooking time can not be decreased during cooking.
3. After pressing Start, the selected temperature can be recalled and changed. Press convection pad once to indicate the temperature in the display window. While the temperature is recalled in the display window, you can change the temperature by pressing Convection pad.

Containers to Use

Do not use plastic **microwave** containers on Combination programs (unless suitable for combination cooking). Dishes must be able to withstand the heat of the top grill. Do not put dishes on wire rack directly under the grill, place on enamel tray on glass turntable.

Oven Accessories

When using any Combination cooking program the glass turntable should be in position and must have the enamel tray placed on top, unless otherwise stated.

Combination 1. Convection and Microwave

This is the most popular combination mode combining Convection heat with Micro Power. Casseroles, meat joints, jacket potatoes and pastries are very successful using this combination. Unsuitable foods are those which contain whisked eggs, meringues, rich fruit cakes, biscuits and yorkshire puddings.

It is not necessary to preheat on combination except when cooking pastry dishes. For pastry dishes preheat oven to 210 °C on Convection so that the oven is hot, and then select the desired combination program or follow recipe guidelines.



Press to select oven temperature. The oven starts at 150 °C, and then for each press the temperature will count up in 10 °C stages to 220 °C, then to 100 °C, 110 °C etc. 40 °C is not available in combination mode.

Press Micro Power pad to select microwave setting. **High & Defrost** are not available.

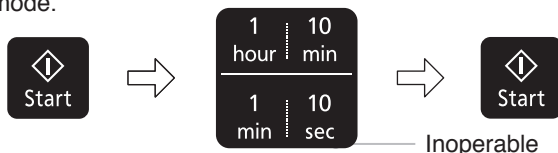

Press if preheating.

Press to enter required cooking time.
Maximum cooking time is 9 hours, 59 minutes.
10 sec pad is inoperable.

Press Start

Oven Accessories to Use

When using Combination cooking the glass turntable should be in position and must have the enamel tray on top, unless otherwise stated.



Items of food can be placed onto the wire rack on the enamel tray on the glass turntable. Heatproof dishes of food should be placed directly onto the enamel tray on the glass turntable.







Joints and portions of meat should be placed on an upturned saucer on the enamel tray on the glass turntable. Alternatively they can be placed in a heatproof dish on the enamel tray on the glass turntable.



Recipes using foil or metal containers e.g. cakes and pastries should be placed directly onto the enamel tray on glass turntable.

Combination 1. Convection and Microwave

The chart below gives suggestions for Combination programs. For cooking times refer to cooking charts or a similar recipe in the book. It is not possible to use **High** or **Defrost** microwave power in this mode.

Oven temperature	Microwave Power	Use	Oven accessories to use
220 °C	Warm	Nuggets, sausage rolls, apple pie, bread and butter pudding.	 Or 
220 °C	Simmer	Quiche, frozen garlic baguette, part baked rolls, meat pies, cottage pie, fish pie.	
190 °C	Simmer	Whole chicken / turkey	
180 °C	Simmer	Joints lamb	
170 °C	Simmer	Joints beef	
170 °C	Low	Joints pork	
160 °C	Warm	Casseroles	



Note

1. Food is usually cooked **uncovered**.
2. After cooking it is important that the accessories are removed for cleaning before re-use and that the oven walls and floor are wiped with a cloth squeezed in hot soapy water to remove any grease. **Do not put accessories in the dishwasher.**
3. Foods should always be cooked until browned and piping hot.



Caution!

Always use oven gloves when removing dishes from the oven - Especially when turning or stirring foods, as the accessories and surrounding oven will get very hot.

Combination 2. Grill and Microwave

This combination mode is suitable for foods which are normally grilled and for reheating small savoury items.

Do not use this program with less than 200 g (7 oz) of food.

It is not necessary to preheat when using this combination mode and food should always be cooked uncovered.

The grill will glow on and off during cooking - this is normal.

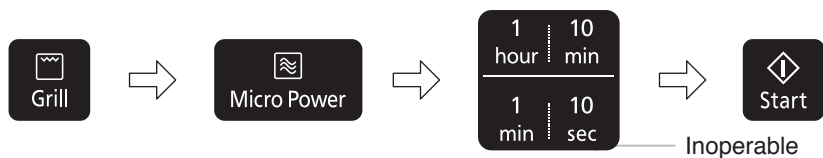

Select Grill power.
Press once for Grill 1 (High), twice for Grill 2 (Medium) or three times for Grill 3 (Low).

Select Micro Power. Keep pressing this pad until the power you require appears in the display window. High and Defrost are not available.

Press to enter required cooking time.
Maximum cooking time is 9 hours, 59 minutes.
10 sec pad is inoperable.

Press Start

Combination 2. Grill and Microwave

Oven Accessories to Use

When using Combination cooking the glass turntable should be in position and must have the enamel tray on top, unless otherwise stated.



Food should be placed directly onto the wire rack on the enamel tray. This is then placed on the glass turntable.



When cooking fish or small items, food can be placed directly on the enamel tray on top of the wire rack.

Guidelines

1. Food is usually cooked **uncovered**.
2. To turn food just press the door release pad, remove the enamel tray and wire rack, turn the food, return to the oven, close the door and press **Start** pad. The oven will continue to countdown the remaining cooking time.
3. After Grilling it is important that the Grill accessories are removed for cleaning before reuse and that the oven walls and floor are wiped with a cloth squeezed in hot soapy water to remove any grease. **Do not put accessories in the dishwasher.**

For advice on cooking times refer to cooking charts and recipes in this book. Foods should always be cooked until browned and piping hot.



Caution!

Always use oven gloves when removing dishes from the oven - especially when turning or stirring foods, as the accessories and surrounding oven will get very hot.

Containers to Use

Do not use plastic **microwave** containers on Combination programs (unless suitable for combination cooking). Dishes must be able to withstand the heat of the top grill. Do not put dishes on wire rack directly under the grill, use the enamel tray.

Multi-stage Cooking

2 or 3 Stage Cooking

Example:

To cook on Medium microwave for 2 minutes, cook on 180 °C for 15 minutes and cook on Grill 1 for 10 minutes.

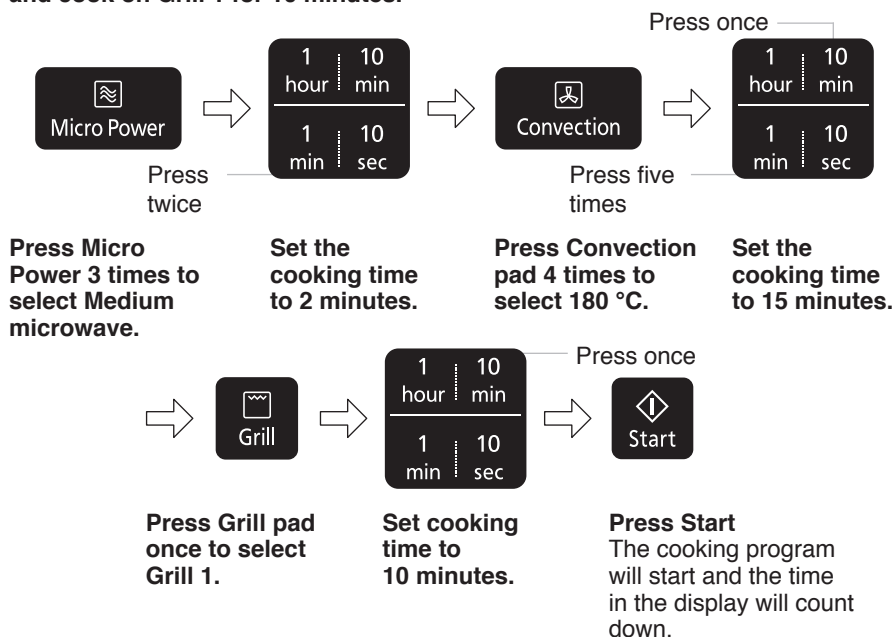

Note

1. For 3 stage cooking, enter another cooking program before pressing Start.
2. During cooking, one press on Stop/Cancel stops the operation. You can re-start it by pressing Start. A second press of Stop/Cancel will cancel the selected program.
3. Whilst not operating, one press of Stop/Cancel cancels the selected program.
4. Auto programs and preheating cannot be used with multi-stage cooking.
5. Delay/stand feature can be used with multi-stage cooking.

Using the Timer

The timer can be used either before or after a cooking program. This feature can be used to set a standing time after cooking or to delay the start of your cooking.

1. To Set a Standing Time:

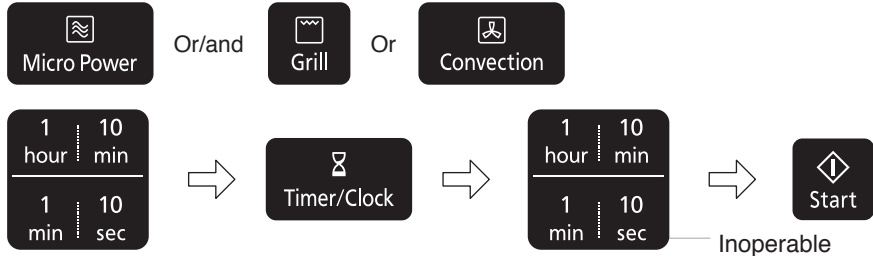

Set the desired cooking program, by selecting power level and time required.

Press Timer/Clock

Set desired standing time (max 9 hours 59 minutes) (10 sec pad is inoperable). An "H" will appear in the display to denote hours.

Press Start
Cooking program will commence after which the standing time will count down.



Note

1. Three stage cooking can be programmed including standing time.
2. If the oven door is opened during the standing time or minute timer, the time in the display window will continue to count down.
3. This feature may also be used as a minute timer. In this case press Timer/Clock, set time and press Start.
4. Standing time cannot be programmed after an auto program and preheating.
5. If the programmed stand time exceeds one hour, the time will count down in units of minutes. If less than one hour, the time will count down in units of seconds.

2. To Set a Kitchen Timer



Press Timer/Clock

Set desired kitchen time (max 9 hours 59 minutes) (10 sec pad is inoperable). An "H" will appear in the display to denote hours.

Press Start
Time will count down.

Using the Timer

3. To Set a Delay Start:

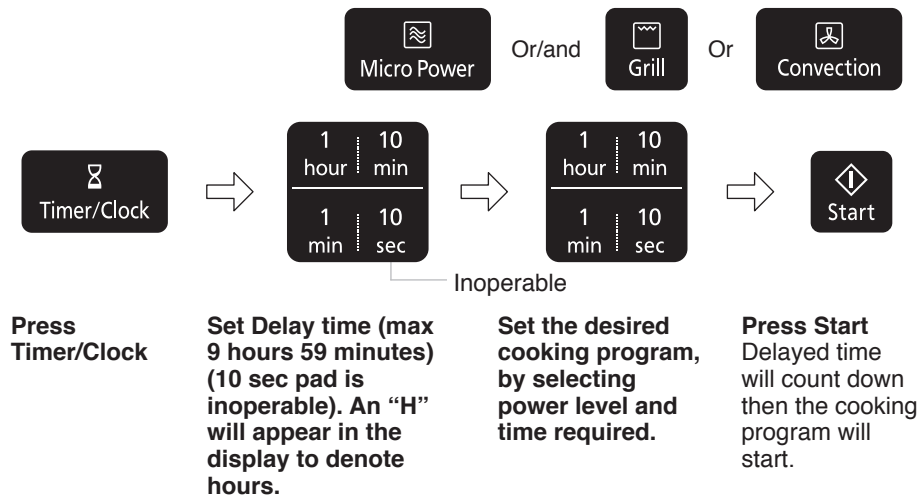

Note

1. Three stage cooking can be programmed including delay start cooking.
2. If the programmed delay time exceeds one hour, the time will count down in units of minutes. If less than one hour, the time will count down in units of seconds.
3. Delay start cannot be programmed before an auto program and preheating.
4. If the oven door is opened during the delay time, the time in the display window will continue to count down.

Auto Programs



This feature allows you to cook or reheat 26 foods by setting the weight only. The oven determines the Microwave power level and/or Convection and/or Combination setting, then the cooking time automatically. Select the category of food and then just enter the weight. The weight can be entered in grams or pounds and ounces.

Auto Programs with Preheating

It is necessary to preheat the oven for Junior Menu programs 7 (chilled breaded products), 8 (frozen breaded products), 9 (fresh vegetable fries), 10 (frozen vegetable fries); Auto/Roast programs 21 (frozen pizza), 22 (frozen potato products), 23 (fish and chips), 24 (chicken).



Select the desired program by pressing the appropriate pad. Refer to pages 56-57 and 60-61.

Press the Start to preheat the oven. Preheat with enamel tray on glass turntable.



After preheating, beeps sound and 'P' will flash in the display. Then open the door and place the food in the oven and set weight using up and down pads. The default weight is in grams. To change to lb and oz's refer to page 29. Take care when handling the hot enamel tray.

Press Start

Auto Programs

It is not necessary to preheat the oven for the remaining auto programs.

Operate as below:

Auto Programs Without Preheating



Select the desired Auto Weight program, by pressing the appropriate pad. Refer to pages 55-62.



Enter the weight by pressing the up and down pads. Default weight is g. To change to lb and oz's refer to page 29. To quickly select the weight, hold weight selection pads. For auto program flapjacks, please skip this step.

Press Start

When you select an automatic program symbols will appear in the display to show the cooking mode that will be used and the accessories that are needed, in addition to the glass turntable. These are what they mean:



Note

The auto weight programs are designed to take the guesswork out of cooking or reheating your food. They must **only** be used for the foods described.

1. Only cook foods within the weight ranges described (see pages 53-54).
2. Only use the accessories as indicated on pages 55-62.
3. Junior programs 4-5 and all Auto Cook programs use Microwave power only. Junior programs 6-11 and Auto/Roast programs 20-24 use a combination of Microwave and Convection or Grill. Auto/Roast programs 25-29 use Convection.
4. **Do not** cover food unless stated, when using a Combination or Convection program, it will prevent the food browning. The heat will also melt any plastic covering.
5. Most foods benefit from a **standing** time after cooking on an auto program, to allow heat to continue conducting to the centre.
6. To allow for some variations that occur in food, check that food is thoroughly cooked and piping hot before serving.
7. Always weigh the food rather than relying on the package weight information.

Auto Programs

Minimum/Maximum Weights for Auto Weight Programs



Junior Menu

Program	Minimum weight	Maximum weight
4. Purée vegetables	100 g (4 oz)	400 g (14 oz)
5. Purée fruits	100 g (4 oz)	400 g (14 oz)
6. Junior pasta bake	200 g (7 oz)	600 g (1 lb 5 oz)
7. Chilled breaded products	100 g (4 oz)	500 g (1 lb 2 oz)
8. Frozen breaded products	100 g (4 oz)	500 g (1 lb 2 oz)
9. Fresh vegetable fries	100 g (4 oz)	500 g (1 lb 2 oz)
10. Frozen vegetable fries	100 g (4 oz)	500 g (1 lb 2 oz)
11. Flapjacks	N/A	N/A



Auto Cook

Program	Minimum weight	Maximum weight
12. Reheat curry	300 g (11 oz)	800 g (1 lb 10 oz)
13. Reheat Chinese style	300 g (11 oz)	450 g (1 lb)
14. Reheat pasta	300 g (11 oz)	1600 g (3 lb 9 oz)
15. Reheat casserole	300 g (11 oz)	900 g (2 lb)
16. Fresh vegetables	100 g (4 oz)	800 g (1 lb 10 oz)
17. Fresh fish	200 g (7 oz)	800 g (1 lb 10 oz)
18. Porridge with milk	50 g (2 oz)	200 g (7 oz)
19. Porridge with water	50 g (2 oz)	200 g (7 oz)

Auto Programs





Minimum/Maximum Weights for Auto Weight Programs



Program	Minimum weight	Maximum weight
20. Jacket potatoes	200 g (7 oz)	1500 g (3 lb 5 oz)
21. Frozen pizza	130 g (5 oz)	450 g (1 lb)
22. Frozen potato products	200 g (7 oz)	500 g (1 lb 2 oz)
23. Fish and chips	200 g (7 oz)	500 g (1 lb 2 oz)
24. Chicken	900 g (2 lb)	2000 g (4 lb 7 oz)
25. Beef-rare	500 g (1 lb 2 oz)	2000 g (4 lb 7 oz)
26. Beef-medium	500 g (1 lb 2 oz)	2000 g (4 lb 7 oz)
27. Beef-well done	500 g (1 lb 2 oz)	2000 g (4 lb 7 oz)
28. Lamb-medium	1000 g (2 lb 3 oz)	2000 g (4 lb 7 oz)
29. Lamb-well done	1000 g (2 lb 3 oz)	2000 g (4 lb 7 oz)













Junior Menu Programs

The Junior Menu offers a range of programs catering for babies, toddlers and older children - great for time saving and convenience. The fruit and vegetable purées are ideal first foods for weaning babies. Homemade purées taste like real food and cost less than jars or packets. Extra portions can be frozen in ice cube trays, then defrosted and reheated. Healthy vegetable fries and pasta bakes are perfect for smaller tummies. A healthier flapjack is perfect for lunch box snacks.

Program	Weight	Accessory	Instructions
<p>4. Purée vegetables</p> <p> Junior Menu</p> <p>1 Press</p> <p></p>	<p>100 g - 400 g (4 oz - 14 oz)</p>	-	<p>This program is suitable for cooking parsnips, potatoes, butternut squash, carrots, sweet potato and swede. The cooked vegetables are then puréed and suitable when weaning babies. Peel and chop the vegetables into even sized pieces. Place in a Pyrex® dish. Add the following quantities of water:</p> <p>100 g - 150 g vegetables 75 ml water. 155 g - 300 g vegetables 100 ml water. 305 g - 400 g vegetables 150 ml water.</p> <p>Cover with lid. Press the Junior Menu pad once. Enter the weight of the vegetables. Press Start. Stir halfway during cooking. After cooking allow to stand for 10 minutes. Purée the vegetables with the cooking liquid using a blender. If necessary adjust the consistency with a little water to thin or baby rice to thicken. Check the temperature before feeding.</p>
<p>5. Purée fruits</p> <p> Junior Menu</p> <p>2 Presses</p> <p></p>	<p>100 g - 400 g (4 oz - 14 oz)</p>	-	<p>This program is suitable for cooking apples, pears, peaches, papaya and mango. The cooked fruit is then puréed and suitable when weaning babies. Peel and chop the fruit into even sized pieces. Place in a Pyrex® dish. Add the following quantities of water:</p> <p>100 g -150 g fruit 75 ml water. 155 g - 300 g fruit 100 ml water. 305 g - 400 g fruit 150 ml water.</p> <p>Cover with lid. Press the Junior Menu pad twice. Enter the weight of the fruit. Press Start. Stir halfway during cooking. After cooking allow to stand for 10 minutes. Purée the fruit with the cooking liquid using a blender. If necessary adjust the consistency with a little water to thin or baby rice to thicken. Check the temperature before feeding.</p>

 = Microwave

Junior Menu Programs

Program	Weight	Accessory	Instructions																
<p>6. Junior pasta bake</p>  <p>Junior Menu</p> <p>3 Presses</p>  + 	<p>200 g (7 oz) 400 g (14 oz) 600 g (1 lb 5 oz)</p>	-	<p>For cooking fresh pasta bake using fresh pasta (penne, spaghetti, fusilli), cheese or tomato based sauce and grated mild Cheddar cheese. Use a suitable square, shallow Pyrex® container. Use the following quantities:</p> <table border="1"> <thead> <tr> <th></th> <th>200 g</th> <th>400 g</th> <th>600 g</th> </tr> </thead> <tbody> <tr> <td>Pasta</td> <td>70 g</td> <td>150 g</td> <td>250 g</td> </tr> <tr> <td>Sauce</td> <td>115 g</td> <td>220 g</td> <td>300 g</td> </tr> <tr> <td>Cheese</td> <td>15 g</td> <td>30 g</td> <td>50 g</td> </tr> </tbody> </table> <p>Other ingredients may be added such as ham, tuna and sweetcorn. In this case substitute some of the sauce for the chosen added ingredients. Press Junior Menu three times. Enter the weight - 200 g, 400 g or 600 g. Press Start.</p>		200 g	400 g	600 g	Pasta	70 g	150 g	250 g	Sauce	115 g	220 g	300 g	Cheese	15 g	30 g	50 g
	200 g	400 g	600 g																
Pasta	70 g	150 g	250 g																
Sauce	115 g	220 g	300 g																
Cheese	15 g	30 g	50 g																
<p>7. Chilled breaded products</p>  <p>Junior Menu</p> <p>4 Presses</p>   + 	<p>100 g - 500 g (4 oz - 1 lb 2 oz)</p>		<p>For preparing chilled breaded products such as breaded chicken strips, fish goujons, popcorn chicken, chicken bites or breaded chicken fillets. Press Junior Menu four times. Press the Start pad to preheat the oven. After preheating, beeps sound and 'P' will flash in the display. Remove all packaging and place the chilled breaded products on the enamel tray on the wire rack. Enter weight of food and press Start. Turn halfway during cooking.</p>																
<p>8. Frozen breaded products</p>  <p>Junior Menu</p> <p>5 Presses</p>   + 	<p>100 g - 500 g (4 oz - 1 lb 2 oz)</p>		<p>For preparing frozen breaded products such as frozen popcorn chicken, frozen chicken nuggets, frozen turkey drummers, frozen fish fingers, frozen scampi. Press Junior Menu five times. Press the Start to preheat the oven. After preheating, beeps sound and 'P' will flash in the display. Remove all packaging and place the frozen breaded products on the enamel tray on the wire rack. Enter weight of food and press Start. Turn halfway during cooking.</p>																















 = Microwave

 = Grill

 = Convection

 = Preheating is required

Junior Menu Programs

Program	Weight	Accessory	Instructions
9. Fresh vegetable fries  Junior Menu 6 Presses   + 	100 g - 500 g (4 oz - 1 lb 2 oz)		For preparing fresh vegetable fries such as sweet potato, white potato, carrots, parsnips and courgettes. Peel and cut the vegetables into baton shapes. Toss in a tablespoon of vegetable oil. Press Junior Menu six times. Press the Start pad to preheat the oven. After preheating, beeps sound and 'P' will flash in the display. Place the vegetables on the enamel tray on the wire rack. Enter weight of food and press Start. Turn halfway.
10. Frozen vegetable fries  Junior Menu 7 Presses   + 	100 g - 500 g (4 oz - 1 lb 2 oz)		For preparing frozen pre-purchased vegetable fries such as sweet potato, carrots and parsnips. Press Junior Menu seven times. Press the Start pad to preheat the oven. After preheating, beeps sound and 'P' will flash in the display. Remove all packaging and place the frozen vegetable fries on the enamel tray on the wire rack. Enter weight of food and press start. Turn halfway.
11. Flapjacks  Junior Menu 8 Presses  + 	-		Prepare the flapjacks as detailed in the recipe below. Place the Pyrex® dish on the enamel tray. Press Junior Menu eight times. Press Start.
ingredients For 8 servings 150 g (5 oz) dates, chopped 100 g (4 oz) low-fat spread 3 tbsp (45 ml) honey 50 g (2 oz) apricots, chopped 3 tbsp (45 ml) mixed seeds 150 g (5 oz) oats Dish: Large Pyrex® mixing bowl Square Pyrex® dish 18 cm x 18 cm (7 x 7 inch)		<ol style="list-style-type: none"> Place the chopped dates, low fat margarine and honey in a Pyrex® mixing bowl. Put the bowl onto the glass turntable and cook on Medium microwave for 3-4 minutes. Add the remaining ingredients to the date mixture. Stir well until all combined. Grease the square Pyrex® dish and line with baking paper. Spoon the mixture into the dish and press down firmly with a metal spoon. 	









 = Microwave

 = Grill

 = Convection

 = Preheating is required

Auto Cook Programs









Program	Weight	Accessory	Instructions
12. Reheat curry  Auto Cook 1 Press 	300 g - 800 g (11 oz - 1 lb 10 oz)	-	This program is for reheating a chilled curry convenience meal that can be stirred *. Foods must be in a suitable microwaveable container and have the film pierced. Place on glass turntable, press the Auto Cook pad once. Enter the weight then press Start. Stir halfway. Allow to stand for 1 minute. Ensure that the food is piping hot. Stir the food before serving.
13. Reheat Chinese style  Auto Cook 2 Presses 	300 g - 450 g (11 oz - 1 lb)	-	This program is for reheating a chilled Chinese style convenience meal *. Foods must be in a suitable microwaveable container and have the film pierced. Press the Auto Cook pad twice. Enter the weight. Press Start. Stir halfway. Allow to stand for 1 minute. Ensure food is piping hot. Stir again before serving.
14. Reheat pasta  Auto Cook 3 Presses 	300 g - 1600 g (11 oz - 3 lb 9 oz)	-	This program is for reheating a chilled pasta convenience meal that can be stirred *. Foods must be in a suitable microwaveable container and have the film pierced. Place on turntable, press the Auto Cook pad three times. Enter the weight then press Start. Stir halfway. Allow to stand for 1 minute. Ensure that the food is piping hot. Stir the food before serving.
15. Reheat casserole  Auto Cook 4 Presses 	300 g - 900 g (11 oz - 2 lb)	-	This program is for reheating a chilled casserole convenience meal *. Foods must be in a suitable microwaveable container and have the film pierced. Press the Auto Cook pad four times. Enter the weight. Press Start. Stir halfway. Allow to stand for 1 minute. Ensure food is piping hot. Stir again before serving.



* Note















These programs are not suitable for foods that cannot be stirred e.g. lasagne / shepherds pie.

Auto Cook Programs

Program	Weight	Accessory	Instructions
16. Fresh vegetables  Auto Cook 5 Presses 	100 g - 800 g (4 oz - 1 lb 10 oz)	-	To cook fresh vegetables. Place prepared vegetables into a shallow container on turntable. Add 15 ml (1 tbsp) of water per 100 g vegetables. Cover with pierced cling film or lid. Press the Auto Cook pad five times. Enter the weight. Press Start. Stir halfway.
17. Fresh fish  Auto Cook 6 Presses 	200 g - 800 g (7 oz - 1 lb 10 oz)	-	To cook fresh fish. Shield the thinner portions. Place in a shallow container on glass turntable. Add 15-45 ml (1-3 tbsp) water. Cover with pierced cling film or lid. Press the Auto Cook pad six times. Enter the weight. Press Start.
18. Porridge with milk  Auto Cook 7 Presses 	50 g - 200 g (2 oz - 7 oz)	-	This program is suitable for cooking porridge using plain oats. Use back of pack instructions for quantity of oats to milk. Use whole or semi-skimmed milk. This program is not suitable for making porridge with water or skimmed milk. Use a large round bowl. Do not cover. Place on the glass turntable. Press the Auto Cook pad seven times. Enter the weight of oats used. Press Start. Stir at beeps. Allow to stand for 2 minutes. Stir before serving.
19. Porridge with water  Auto Cook 8 Presses 	50 g - 200 g (2 oz - 7 oz)	-	This program is suitable for cooking porridge using plain oats. Use back of pack instructions for quantity of oats to water. This program is not suitable for making porridge with milk. Use a large round bowl. Do not cover. Place on the glass turntable. Press the Auto Cook pad eight times. Enter the weight of oats used. Press Start. Stir at beeps. Allow to stand for 2 minutes. Stir before serving.

 = Microwave

Auto/Roast Programs

Program	Weight	Accessory	Instructions
<p>20. Jacket potatoes</p>  <p>Auto/Roast</p> <p>1 Press</p>  + 	<p>200 g - 1500 g (7 oz - 3 lb 5 oz)</p>		<p>To cook jacket potatoes with a crisper drier skin. Choose medium sized potatoes 200 g - 250 g (7 oz - 9 oz), for best results. Wash and dry potatoes and prick with a fork several times. Place on enamel tray on glass turntable. Press the Auto/Roast pad once. Enter total weight of potatoes, then press Start.</p>
<p>21. Frozen pizza</p>  <p>Auto/Roast</p> <p>2 Presses</p>   + 	<p>130 g - 450 g (5 oz - 1 lb)</p>		<p>For reheating and browning frozen, purchased pizza. Press the Auto/Roast pad twice. Press the Start pad to preheat the oven. After preheating, beeps sound and 'P' will flash in the display. Remove all packaging and place pizza on wire rack on enamel tray on glass turntable. Enter weight and press Start.</p>
<p>22. Frozen potato products</p>  <p>Auto/Roast</p> <p>3 Presses</p>   + 	<p>200 g - 500 g (7 oz - 1 lb 2 oz)</p>		<p>To cook frozen potato products, e.g. hash browns, croquettes, etc., that are suitable for grilling. Press the Auto/Roast pad three times. Press the Start pad to preheat the oven. After preheating, beeps sound and 'P' will flash in the display. Spread potato products out on enamel tray on wire rack on glass turntable. Enter the weight. Press Start. Turn during cooking. For best results cook in a single layer. Note: Potato products vary considerably. We suggest checking a few minutes before the end of cooking to assess levels of browning.</p>











 = Microwave

 = Grill

 = Convection

 = Preheating is required

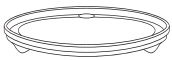
Auto/Roast Programs

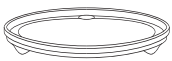
Program	Weight	Accessory	Instructions
23. Fish and chips  Auto/Roast 4 Presses   + 	200 g - 500 g (7 oz - 1 lb 2 oz)		This program is suitable for pre-purchased frozen battered or breaded fish and pre-purchased frozen oven chips. This program is suitable for 1 portion of fish and chips. The fish must weigh between 100 g - 250 g and the chips must weigh between 100 g - 300 g. Press the Auto/Roast pad four times. Press the Start pad to preheat the oven. After preheating, beeps sound and 'P' will flash in the display. Spread the fish and chips out on the enamel tray on wire rack on glass turntable. Enter the weight of the fish and chips. Press Start. Turn fish and chips at the beeps. For best results cook in a single layer.
24. Chicken  Auto/Roast 5 Presses   + 	900 g - 2000 g (2 lb - 4 lb 7 oz)		To cook whole fresh unstuffed chickens. Cook stuffing separately. Press Auto/Roast pad five times. Press the Start pad to preheat the oven. After preheating, beeps sound and 'P' will flash in the display. Place chicken on enamel tray and place on glass turntable. Enter in the weight of the chicken, then press Start. Start cooking breast side down and turn $\frac{2}{3}$ total time, a beep will sound to turn, taking care with hot juices. Stand for 5 minutes.
25. Beef rare  Auto/Roast 6 Presses 	500 g - 2000 g (1 lb 2 oz - 4 lb 7 oz)		For cooking rare fresh roast beef (top side, rump or silverside). Place on enamel tray on the glass turntable. Press the Auto/Roast pad six times, enter the weight of the food and press Start. After cooking stand for 10 to 20 minutes.











 = Microwave

 = Grill

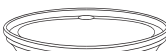
 = Convection

 = Preheating is required

Auto/Roast Programs

Program	Weight	Accessory	Instructions
26. Beef medium  Auto/Roast 7 Presses 	500 g - 2000 g (1 lb 2 oz - 4 lb 7 oz)		For cooking medium fresh roast beef (top side, rump or silverside). Place on enamel tray on the glass turntable. Press the Auto/Roast pad seven times, enter the weight of the food and press Start. After cooking stand for 10 to 20 minutes.
27. Beef well done  Auto/Roast 8 Presses 	500 g - 2000 g (1 lb 2 oz - 4 lb 7 oz)		For cooking well done fresh roast beef (top side, rump or silverside). Place on enamel tray on the glass turntable. Press the Auto/Roast pad eight times, enter the weight of the food and press Start. After cooking stand for 10 to 20 minutes.
28. Lamb medium  Auto/Roast 9 Presses 	1000 g - 2000 g (2 lb 3 oz - 4 lb 7 oz)		For cooking medium fresh roast leg of lamb with bone. Place on enamel tray on the glass turntable. Press the Auto/Roast pad nine times, enter the weight of the food and press Start. After cooking stand for 10 to 20 minutes.
29. Lamb well done  Auto/Roast 10 Presses 	1000 g - 2000 g (2 lb 3 oz - 4 lb 7 oz)		For cooking well done fresh roast leg of lamb with bone. Place on enamel tray on the glass turntable. Press the Auto/Roast pad ten times, enter the weight of the food and press Start. After cooking stand for 10 to 20 minutes.

 = Microwave

 = Grill

 = Convection

 = Preheating is required

Cooking and Reheating Guidelines

Most foods reheat very quickly in your oven by **High** microwave. Meals can be brought back to serving temperature in just minutes and will taste freshly cooked. Always check food is piping hot and return to oven if necessary.

As a general rule, always cover wet foods, e.g. soups, casseroles and plated meals.

Do not cover dry foods e.g. bread rolls, mince pies, sausage rolls etc.

The charts on pages 65-81 show you the best way to cook or reheat your favourite foods. The best method depends on the type of food you are cooking or reheating.

Remember to stir or turn food wherever possible during cooking or reheating. This ensures even cooking or reheating on the outside and in the centre.

When is Food Reheated?

Food that has been reheated or cooked should be served piping hot i.e. steam should be visibly emitted from all parts. As long as good hygiene practices have been followed during the preparation and storage of the food, then cooking or reheating presents no safety risks.

Foods that cannot be stirred should be cut with a knife to test that they are adequately heated throughout. Even if a manufacturer's instructions or the times in the cookbook have been followed, it is still important to check the food is heated thoroughly. If in doubt, always return to the oven for further reheating. If you cannot find the equivalent food in the chart then choose a similar type and size listed and adjust the cooking time if necessary.

Plated Meals

Everyone's appetite varies and reheat times depend on meal contents. Dense items e.g. mashed potato, should be spread out well. If a lot of gravy is added, extra time may be required. Place denser items to the outside of the plate. An average plated meal will take 4-5 minutes on **High** microwave to reheat. Do not stack meals.

Canned Foods

Remove foods from can and place in a suitable dish before heating.

Soups

Place soup in a bowl. Stir before heating and at least once during reheat time and again at the end.

Casseroles

Stir halfway through and again at the end of heating.

Cooking and Reheating Guidelines



Mince Pies

Remember even if the pastry is cold to the touch, the filling will be piping hot and will warm the pastry through. Take care not to overheat otherwise burning can occur due to the high fat and sugar content of the filling. Check the temperature of the filling before consuming to avoid burning your mouth.

Christmas Puddings and Liquids

Take great care when reheating these items.

Do not leave unattended.
Do not add extra alcohol.

Babies Bottles

Milk or formula **must** be shaken thoroughly before heating and again at the end and tested carefully before feeding a baby. For 7-8 fl. oz. of milk from fridge temperature, remove top and teat. Heat on High microwave for 25-30 seconds. **Check carefully.**

For 3 fl. oz. of milk from fridge temperature, remove top and teat. Heat on High microwave for 10-15 seconds. **Check carefully.**

Liquid at the top of bottle will be much hotter than at the bottom. The bottle must be shaken thoroughly and tested before use.

We do not recommend that you use your microwave to sterilise babies' bottles. If you have a special microwave steriliser we urge extreme caution, due to the low quantity of water involved. It is vital to follow the manufacturers instructions implicitly.

Reheating Charts

The times given in the charts below are a guideline only, and will vary depending on starting temperature, dish size etc.

Heating Category

Your oven is heating Category E.
The information on this label will assist you in using new instructions on food packs to enable you to program the best heating time in your oven.

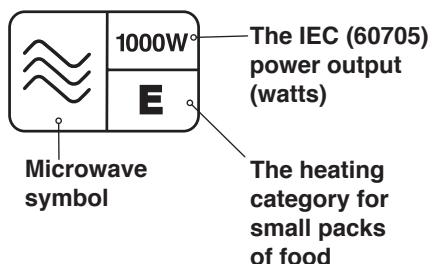

Food	Weight/ Quantity	Power Level	Time to Select (approx)	Instructions/Guidelines
Bread – Precooked – Fresh – N.B. Breads reheated by microwave will have a soft base.				
Croissants	1	High	15-20 secs	Place on micro-safe plate on turntable. Do not cover.
		or Grill 1	2-3 mins	Place on heatproof plate on turntable. Do not cover.
	4	High	30-40 secs	Place on micro-safe plate on turntable. Do not cover.
		or Grill 1	3-5 mins	Place on heatproof plate on turntable. Do not cover
Rolls	1	High	15-20 secs	Place on micro-safe plate on turntable. Do not cover.
		or Grill 1	3-4 mins	Place on heatproof plate on turntable. Do not cover.
	4	High	30-40 secs	Place on micro-safe plate on turntable. Do not cover.
		or Grill 1	3-4 mins	Place on heatproof plate on turntable. Do not cover.
Canned beans, pasta				
Baked beans	220 g	High	2 mins	Place in a micro-safe bowl on turntable. Cover.
	415 g	High	3 mins	
Baked beans & sausages/ burgers	415 g	High	3-4 mins	



Note

Always check that food is piping hot after reheating in the microwave. If unsure return to oven. Foods will still require a stand time, especially if they cannot be stirred. The denser the food the longer the stand time.

Reheating Charts

Food	Weight/ Quantity	Power Level	Time to Select (approx)	Instructions/Guidelines
Canned beans, pasta				
Ravioli in sauce	200 g	High	2 mins 30 secs	Place in a micro-safe bowl on turntable. Cover.
	400 g	High	3-4 mins	
Spaghetti in tomato sauce	200 g	High	1 min 30 secs - 2 mins	
Canned meat				
Hot dogs (drained)	400 g	High	2-3 mins	Place in a micro-safe bowl on turntable. Cover.
Stewed steak	400 g	High	3-4 mins	
Canned soups				
Cream of mushroom	400 g	High	3-4 mins	Place in a micro-safe bowl on turntable. Cover. Stir halfway.
Minestrone	400 g	High	2 mins 30 secs	
Canned puddings				
Custard	400 g	High	2 mins	Place in a micro-safe bowl on turntable. Cover. Stir halfway.
Sponge pudding	400 g	High	2 mins 30 secs	Place in a micro-safe bowl on turntable. Cover.
Canned vegetables - Drain where appropriate				
Carrots, whole	300 g	High	2 mins	Place in a micro-safe bowl on turntable. Cover. Stir halfway.
Peas, mushy	300 g	High	2 mins	
Peas, garden	290 g	High	2 mins - 2 mins 30 secs	Place in a micro-safe bowl on turntable. Cover.
Potatoes new	567 g	High	4 mins	
Sweetcorn	198 g	High	1 min 30 secs	Place in a micro-safe bowl on turntable. Cover. Stir halfway.
	325 g	High	2-3 mins	
Tomatoes, whole	400 g	High	3 mins 30 secs	Place in a micro-safe bowl on turntable. Cover.



Note

Always check that food is piping hot after reheating in the microwave. If unsure return to oven. Foods will still require a stand time, especially if they cannot be stirred. The denser the food the longer the stand time.

Reheating Charts

Food	Weight/ Quantity	Power Level	Time to Select (approx)	Instructions/Guidelines
Christmas puddings – do not leave unattended as overheating can cause the food to ignite				
Mini	100 g	High	30 secs	Place in a micro-safe dish on turntable. Cover.
Small	454 g	High	2 mins	
Medium	907 g	High	3 mins	
Large	1.1 kg	High	3 mins 30 secs	
Drinks – Coffee - at room temperature				
1 mug	235 ml	High	1 min 30 secs-2 mins	Place in a micro-safe mug on turntable.
2 mugs	470 ml	High	2 mins 30 secs	
Drinks – Milk - from the fridge				
1 mug	235 ml	Medium	2 mins- 2 mins 30 secs	Place in a micro-safe mug or jug on turntable.
1 jug	600 ml	Medium	4-5 mins	
Homemade meat dishes				
Casserole for 2	700 g	High	6-8 mins	Place in a micro-safe dish on turntable. Cover. Stir halfway.
Casserole for 4	1 kg	High	10-15 mins	
Bolognese sauce	250 g	High	3 mins	
	1 kg	High	8 mins	
Pastry products – precooked – N.B. Pastries reheated by microwave will have a soft base. For combination cooking, if pie comes in foil container place directly onto enamel tray.				
Cornish pastie	140 g (1)	High	1-2 mins	Place in micro-safe dish on turntable. Do not cover.
		or Combi 200 °C + Warm	7-9 mins	Place on wire rack on enamel tray on turntable. Do not cover.
	300 g (2)	High	2-3 mins	Place in micro-safe dish on turntable. Do not cover.
		or Combi 200 °C + Warm	8-10 mins	Place on wire rack on enamel tray on turntable. Do not cover.



Note

Always check that food is piping hot after reheating in the microwave. If unsure return to oven. Foods will still require a stand time, especially if they cannot be stirred. The denser the food the longer the stand time.

Reheating Charts

Food	Weight/ Quantity	Power Level	Time to Select (approx)	Instructions/Guidelines
Pastry products – precooked – N.B. Pastries reheated by microwave will have a soft base. If pie comes in foil container place directly onto enamel tray.				
Meat pies	300 g (2)	Combi 200 °C + Simmer	6-7 mins	Place on enamel tray on turntable
Steak and kidney Shortcrust pie	210 g (1)	Combi 200 °C + Warm	12 mins	
Quiche	400 g (1)	High	3-4 mins	Place in micro-safe dish on turntable. Do not cover.
		or Combi 220 °C + Simmer	7-8 mins	Place on wire rack on enamel tray on turntable. Do not cover.
Sausage roll	330 g (2)	Combi 220 °C + Warm	9-10 mins	Do not cover.
Xmas mince pies	110 g (2)	High	10-20 secs	Place in micro-safe dish on turntable. Do not cover.
Plated meals – homemade – chilled				
Child size	1	High	2-3 mins	Place on a micro-safe plate on turntable. Cover.
Adult size	1	High	4-5 mins	
Puddings and desserts- Transfer puddings to a micro-safe/heatproof dish				
Apple pie (chilled)	700 g	High	3-4 mins	Place in micro-safe dish on turntable. Do not cover.
		or Combi 220 °C + Warm	13-14 mins	Place on enamel tray on turntable. Do not cover.
Apple and blackcurrant pies (room temperature)	x 6	Convection 220°C	6-7 mins	Place in foil cases on wire rack on enamel tray on turntable. Do not cover.
Bread and butter pudding (chilled)	500 g	High	3-4 mins	Place on turntable. Do not cover.
		or 220 °C + Warm	15-17 mins	Place on enamel tray on turntable. Do not cover.
Custard (chilled)	300 ml	High	2 mins- 2 mins 30 secs	Place in large jug. Stir during reheating.



Note

Always check that food is piping hot after reheating in the microwave. If unsure return to oven. Foods will still require a stand time, especially if they cannot be stirred. The denser the food the longer the stand time.

Reheating Charts

Food	Weight/ Quantity	Power Level	Time to Select (approx)	Instructions/Guidelines
Puddings and desserts – Transfer puddings to a micro-safe/heatproof dish				
Fruit crumble (chilled)	500 g	High	2 mins- 2 mins 30 secs	Place on turntable. Do not cover.
		or Combi 220 °C + Warm	10-15 mins	Place on enamel tray on turntable. Do not cover.
Jam roly poly (chilled)	480 g	High	2-4 mins	Place on turntable. Do not cover.
Purchased convenience foods – chilled N.B. Transfer food from foil container to a similar sized micro-safe/heatproof dish.				
Breaded mushrooms	300 g	Convection: 220 °C	13-15 mins	Place on enamel tray on wire rack on turntable.
Cottage pie	400 g	High	4-5 mins	Place on turntable. Uncovered.
		or Combi 220 °C + Simmer	13-15 mins	Place on enamel tray on turntable. Do not cover.
Lasagne	400 g	Medium	5-7 mins	Place on turntable. Uncovered.
		or Combi 200 °C + Low	11-13 mins	Place on enamel tray on turntable. Do not cover.
Onion bhajis, pakora & felafeel	360 g (12)	Convection: 220 °C	10-12 mins	Place on enamel tray on wire rack on turntable. Turn halfway.
Spring rolls or samosas	240 g	Convection: 220 °C	13-15 mins	Place on wire rack on enamel tray on turntable. Turn halfway.
Potato wedges	385 g	Convection: 220 °C	10-15 mins	Place on enamel tray on wire rack on turntable. Turn halfway.
Vegetable bake	450 g	High	6-8 mins	Place on turntable.
		or Combi 200 °C + Simmer	12-14 mins	Place on enamel tray on turntable. Do not cover.



Note

Always check that food is piping hot after reheating in the microwave. If unsure return to oven. Foods will still require a stand time, especially if they cannot be stirred. The denser the food the longer the stand time.

Reheating Charts

Food	Weight/ Quantity	Power Level	Time to Select (approx)	Instructions/Guidelines
Purchased convenience foods – frozen – N.B. Transfer food from foil container to a similar sized micro-safe/heatproof dish. Plastic dishes designed for microwave and conventional ovens may be used with care.				
Golden drummers	340 g (6)	Grill 1	16-18 mins	Place on enamel tray on wire rack on turntable. Turn halfway.
Lasagne	400 g	Defrost then High	8 mins 8-9 mins	Place on turntable.
		or Combi 220 °C + Simmer	18-20 mins	Place on enamel tray on turntable.
Breaded onion rings	250 g	Grill 1	10-12 mins	Place on enamel tray on wire rack on turntable. Turn halfway.
Fish pie	340 g	High	7-8 mins	Place on turntable.
		or Combi 220 °C + Simmer	15-17 mins	Place on enamel tray on turntable.
Shepherd's pie	400 g	Defrost then High	10 mins 6-8 mins	Place on turntable.
		or Combi 220 °C + Simmer	20-22 mins	Place on enamel tray on turntable.



Note

Always check that food is piping hot after reheating in the microwave. If unsure return to oven. Foods will still require a stand time, especially if they cannot be stirred. The denser the food the longer the stand time.

Cooking Charts

Food	Weight/ Quantity	Power Level	Time to Select (approx)	Instructions/Guidelines
Bread – Frozen				
Part-baked rolls	200 g (4)	Combi 220° C + Simmer	8-12 mins	Place on enamel tray on turntable.
Part-baked garlic baguette	170 g (1)	Combi 220° C + Simmer	8-10 mins	
Bacon – from raw				
Rashers	300 g (8)	High	4-6 mins or 1 min per rasher	Place on micro-safe rack or plate on turntable and cover with kitchen towel to minimise splatter.
		or Grill 1	11-13 mins	Place on enamel tray on wire rack on turntable. Turn halfway.
Steaks	250 g (2)	High	4-5 mins	Place on micro-safe rack or plate on turntable. Cover.
		or Grill 1	28-30 mins	Place on wire rack on enamel tray on turntable. Turn halfway.
Beans & pulses – should be pre-soaked (except lentils)				
Black eyed beans	225 g	High then Simmer	10 mins 25-30 mins	Use 600 ml (1 pt) boiling water in a large bowl. Cover.
Chick peas	225 g	High then Simmer	10 mins 40 mins	
Lentils	225 g	Medium	10-15 mins	
Red kidney beans	225 g	High then Simmer	15 mins 35-40 mins	
Beef - Joints from raw – Caution: Hot fat! Remove dish with care. For Guidelines see Meat chapter page 88.				
Topside, Forerib, Sirloin	-	Combi: 170 °C + Simmer	14-16 min per 450 g	Place on an upturned saucer on enamel tray on turntable. Turn halfway.
Mince	450 g	High then Medium	10 mins 15 mins	Place in micro-safe dish with stock and seasonings on turntable. Stir halfway. Cover.



Note

Always check that food is piping hot after reheating in the microwave. If unsure return to oven. Foods will still require a stand time, especially if they cannot be stirred. The denser the food the longer the stand time.

Cooking Charts

Food	Weight/ Quantity	Power Level	Time to Select (approx)	Instructions/Guidelines
Beef - Joints from raw – Caution: Hot fat! Remove dish with care. For Guidelines see Meat chapter page 88.				
Rump/ sirloin	380 g (2)	Medium	3-5 mins	Place on micro-safe rack or plate on turntable. Cover.
		or Grill 1	12-14 mins	Place on wire rack on enamel tray on turntable. Turn halfway.
Stewing steak	450 g - 675 g	High then Simmer	10 mins 60 mins	Place in micro-safe dish with stock and vegetables on turntable. Stir halfway. Cover.
		or Combi: 160 °C + Warm	1 hr-1 hr 40 mins	Place in casserole dish with stock and vegetables with lid on enamel tray on turntable. Stir halfway.
Beefburgers – Fresh from raw – Caution: Hot fat! Remove oven accessories with care.				
-	226 g (2)	High	3-4 mins	Place on micro-safe rack or plate on turntable. Cover.
		or Grill 1	18-20 mins	Place on wire rack on enamel tray on turntable. Turn halfway.
Beefburgers – Frozen from raw – Caution: Hot fat! Remove oven accessories with care.				
-	227 g (4)	High	5-7 mins	Place on micro-safe rack or plate on turntable. Cover.
		or Grill 1	12-16 mins	Place on wire rack on enamel tray on turntable. Turn halfway.
Chicken from raw – Caution: Hot Fat! Remove oven accessories with care. For Guidelines see meat chapter page 88.				
Breasts, boneless	600 g (4)	Medium	12-14 mins	Place on micro-safe rack or plate on turntable. Cover.
		or Grill 1 + Simmer	16-18 mins	Place on wire rack on enamel tray on turntable. Turn halfway.
Drumsticks	800 g (8)	Medium	12-14 mins	Place on micro-safe rack or plate on turntable. Cover.
		or Convection 220 °C	25-30 mins	Place on wire rack on enamel tray on turntable. Turn halfway.



Note

Always check that food is piping hot after reheating in the microwave. If unsure return to oven. Foods will still require a stand time, especially if they cannot be stirred. The denser the food the longer the stand time.

Cooking Charts

Food	Weight/ Quantity	Power Level	Time to Select (approx)	Instructions/Guidelines
Chicken from raw – Caution: Hot Fat! Remove oven accessories with care. For Guidelines see meat chapter page 88.				
Kiev (fresh)	300 g (2)	Convection 220 °C + Warm	14-16 mins	Place on wire rack on enamel tray on turntable.
	600 g (4)		16-18 mins	
Nuggets (frozen)	500 g	Combi: 220 °C + Warm	15-20 mins	Place on enamel tray on wire rack on turntable.
		or Grill 1	15-20 mins	Place on enamel tray on wire rack on turntable. Turn halfway.
Nuggets (fresh)	360 g	Combi: 220 °C + Warm	12-14 mins	Place on enamel tray on wire rack on turntable.
Chicken legs	1 kg (4)	Medium	15-18 mins	Place on micro-safe rack or plate on turntable. Cover.
		or Combi: 220 °C + Simmer	25-35 mins	Place on wire rack on enamel tray on turntable.
Whole	-	Medium	9-11 mins per 450 g	Place in micro-safe dish on turntable. Cover.
		or Combi: 190 °C + Simmer	14-16 mins per 450 g	Place on upturned saucer on enamel tray on turntable. Start cooking breast side down. Turn halfway. Do not cover.
Eggs – Poached				
Water	45 ml	High	40 secs	<ul style="list-style-type: none"> Place water in a small bowl and heat for 1st cooking time. Add medium egg (size 3). Pierce yolk and white. Cover. Cook for 2nd cooking time. Then leave to stand for 1 minute.
Egg	1	Medium	40 secs	
Water	90 ml	High	1 min	
Eggs	2	Medium	1 min	
Water	135 ml	High	1 min 30 secs	
Eggs	3	Medium	1 min 10 secs	
Water	180 ml	High	2 mins	
Eggs	4	Medium	1 min 30 secs	



Note

Always check that food is piping hot after reheating in the microwave. If unsure return to oven. Foods will still require a stand time, especially if they cannot be stirred. The denser the food the longer the stand time.

Cooking Charts

Food	Weight/ Quantity	Power Level	Time to Select (approx)	Instructions/Guidelines
Eggs – Scrambled				
Egg	1	High	30 secs	<ul style="list-style-type: none"> • Add 1 tbsp of milk for each egg used. • Beat eggs, milk and knob of butter together. • Cook for 1st cooking time then stir. • Cook for 2nd cooking time then stand for 1 minute.
		High	20 secs	
Eggs	2	High	50 secs	
		High	30 secs	
Eggs	3	High	1 min 20 secs	
		High	30 secs	
Fish – Fresh from raw – For Guidelines see Fish Chapter page 85.				
Breaded fillets	235 g (2)	Grill 1	10-15 mins	Place on enamel tray on wire rack on turntable. Turn halfway.
Cakes	280 g (2)	Grill 1 + Warm	12-14 mins	Place on enamel tray on wire rack on turntable. Turn halfway.
Fillets	260 g (2)	High	3-4 mins	Place in micro-safe dish. Add 30 ml of liquid. Cover.
		or Grill 1	12-14 mins	Place on enamel tray on wire rack on turntable. Turn halfway.
Steaks	220 g (2)	High	3-4 mins	Place in micro-safe dish. Add 30 ml of liquid. Cover.
		or Grill 2	12-16 mins	Place on enamel tray on wire rack on turntable. Turn halfway.
Whole	260 g (1)	High	3-4 mins	Place in micro-safe dish. Add 30 ml of liquid. Cover.
		or Grill 2	16 mins	Place on enamel tray on wire rack on turntable. Turn halfway.
Fish - Frozen from raw - For Guidelines see Fish chapter page 85.				
Breaded fillets	260 g (2)	Grill 1 + Warm	15-17 mins	Place on enamel tray on wire rack on turntable. Turn halfway.
		or Combi: 200 °C + Warm	14-16 mins	
Cakes	400 g (4)	Grill 1	18-22 mins	Place on enamel tray on wire rack on turntable. Turn halfway.
Fish fingers	230 g (8)	High	3-4 mins	Place on micro-safe dish. Do not cover.
		or Grill 1	12-14 mins	Place on enamel tray on wire rack on turntable. Turn halfway.



Note

Always check that food is piping hot after reheating in the microwave. If unsure return to oven. Foods will still require a stand time, especially if they cannot be stirred. The denser the food the longer the stand time.

Cooking Charts

Food	Weight/ Quantity	Power Level	Time to Select (approx)	Instructions/Guidelines
Fish - Frozen from raw - For Guidelines see Fish chapter page 85.				
Haddock fillets	300 g (3)	High	4-5 mins	Place in micro-safe dish. Add 30 ml of liquid. Cover.
		or Grill 1	15-20 mins	Place on enamel tray on wire rack on turntable. Turn halfway.
Scampi	300 g	Grill 1	15 mins	Place on enamel tray on wire rack on turntable. Turn halfway.
		or Combi: 220 °C + Simmer	9-10 mins	
Whole	500 g (2)	High	12-15 mins	Place in micro-safe dish. Add 30 ml of liquid. Cover.
Steaks	220 g (2)	High	4-6 mins	Place in micro-safe dish. Add 30 ml of liquid. Cover.
Boil in the bag	150 g- 170 g	Defrost then stand then Medium	4 mins 2 mins 4-5 mins	Place bag sauce side down on a plate. Slash top.
Fruit – Peel, slice, chop into even sized pieces. Place in shallow heatproof dish on turntable.				
Apples – poached	450 g	High	6-7 mins	Add 300 ml (½ pt) of water. Only half fill dish. Cover.
Apples – stewed	450 g	High	5-6 mins	Only half fill dish. Cover.
Peaches – poached	450 g	High	5-6 mins	Add 300 ml (½ pt) of water. Only half fill dish. Cover.
Pears – poached	450 g	High	6-7 mins	
Plums – poached	450 g	High	4-6 mins	
Plums – stewed	450 g	High	3-4 mins	Add 30 ml (2 tbsp) of water. Only half fill dish. Cover.
Rhubarb – stewed	450 g	High	4-6 mins	Only half fill dish. Cover.



Note

Always check that food is piping hot after reheating in the microwave. If unsure return to oven. Foods will still require a stand time, especially if they cannot be stirred. The denser the food the longer the stand time.

Cooking Charts

Food	Weight/ Quantity	Power Level	Time to Select (approx)	Instructions/Guidelines
Lamb – from raw – Caution: Hot Fat! Remove accessory with care. For Guidelines see Meat chapter page 88.				
Chops, cutlets	300 g (4)	Medium	4-6 mins	Place in micro-safe dish or rack on turntable. Cover.
		or Grill 1	14-16 mins	Place on wire rack on enamel tray on turntable. Turn halfway.
Chops, loin	500 g (4)	Medium	5-7 mins	Place in micro-safe dish or rack on turntable. Cover.
		or Grill 1	22-24 mins	Place on wire rack on enamel tray on turntable. Turn halfway.
Joints	-	Combi: 180 °C + Simmer	12-15 mins per 450 g	Place on enamel tray on turntable. Turn halfway.
Stewing lamb	450 g	High then Low	10 mins 40 mins	Place in micro-safe dish with stock and vegetables on turntable. Stir halfway. Cover.
		or Combi: 160 °C + Warm	1 hr	Place in casserole dish, add stock and vegetables, cover with lid on enamel tray on turntable. Stir halfway.
Casseroling lamb i.e. diced shoulder	450 g	High then Low	10 mins 60 mins	Place in micro-safe dish on turntable. Stir halfway. Cover.
		or Combi: 160 °C + Warm	1 hr	Place in casserole dish with lid on enamel tray on turntable. Stir halfway.
Pasta - Place in a large 3 litre (6 pt) microwave safe bowl.				
Twists	225 g	High	8-10 mins	Use 1 litre (1 ¾ pt) boiling water. Add 15 ml oil. Cover. Stir halfway.
Macaroni	225 g	High	10-12 mins	
Spaghetti / tagliatelle	225 g	High	8-10 mins	Use 1 ½ litres (2 ½ pts) boiling water. Add 15 ml oil. Cover. Stir halfway.
Pasta shells - i.e. conchiglie	225 g	High	10-12 mins	



Note

Always check that food is piping hot after reheating in the microwave. If unsure return to oven. Foods will still require a stand time, especially if they cannot be stirred. The denser the food the longer the stand time.

Cooking Charts

Food	Weight/ Quantity	Power Level	Time to Select (approx)	Instructions/Guidelines
Pastry – uncooked				
Shortcrust flan case	23 cm (9 inch)	High	3-4 mins	Prick base of pastry and chill well. Lay piece of kitchen towel in base. Place on turntable.
		or Combi: 220 °C + Simmer	7-8 mins	Prick base of pastry and chill well. Do not cover. Place on enamel tray on turntable.
All butter croissants	350 g (6)	Convection: Preheat 200 °C then 200 °C	8-10 mins	Place on baking sheet on enamel tray on turntable.
Pizza – fresh chilled – N.B. Remove all packaging. Pizzas will have a soft base if cooked by microwave only.				
Deep pan, ham	410 g	High	4-6 mins	Place on micro-safe plate on turntable. Do not cover.
		or Convection: 220 °C	8-12 mins	Place directly on wire rack on enamel tray on turntable. Do not cover.
Thin and crispy	300 g	Combi: 220 °C + Warm	6-8 mins	Place on wire rack on enamel tray on turntable. Do not cover.
		or Convection: 220 °C	8 mins	
Pizza - frozen - N.B. remove all packaging.				
French bread	250 g (2)	Combi: 220 °C + Simmer	7-8 mins	Place on wire rack on enamel tray on turntable. Do not cover.
Pepperoni	340 g	Combi: 220 °C + Simmer	8-10 mins	Place on wire rack on enamel tray on turntable. Do not cover.
Pork – from raw – Caution: Hot Fat! Remove oven accessories with care. For Guidelines see Meat Chapter page 88.				
Chops	425 g (5)	Grill 1	20-25 mins	Place on wire rack on enamel tray on turntable. Turn halfway.



Note

Always check that food is piping hot after reheating in the microwave. If unsure return to oven. Foods will still require a stand time, especially if they cannot be stirred. The denser the food the longer the stand time.

Cooking Charts

Food	Weight/ Quantity	Power Level	Time to Select (approx)	Instructions/Guidelines
Pork – from raw – Caution: Hot Fat! Remove oven accessories with care. For Guidelines see Meat Chapter page 88.				
Joints	-	Medium	13-14 mins per 450 g	Place on upturned saucer in micro-safe dish on turntable. Turn joint over halfway during cooking. Drain off fat during cooking.
		or Combi 170 °C + Low	16-18 mins per 450 g	Place on enamel tray. Turn halfway.
Gammon covered with water	-	High then Medium	15 mins 25-30 mins per 450 g	Place in large casserole dish with lid and cover with water.
Tenderloin, whole	-	Combi: 190 °C + Warm	25-30 mins per 450 g	Place on upturned saucer on enamel tray on turntable.
Porridge – N.B: Use a large bowl.				
1 serving	½ cup of oats	Medium	3-3 mins 30 secs	Add 1 cup of water or milk. Stir halfway.
2 servings	1 cup of oats	High	4-5 mins	Add 2 cups of water or milk. Stir halfway.
4 servings	2 cups of oats	High	8-9 mins	Add 4 cups of water or milk. Stir halfway.
Potato products part cooked – frozen				
Croquettes	300 g	Grill 1 + Simmer	11-13 mins	Place on enamel tray on wire rack on turntable. Turn halfway.
Hash browns	300 g (7)	Grill 1	12-15 mins	Place on enamel tray on wire rack on turntable. Turn halfway.
Oven chips & associated products	300 g	Grill 1	10-12 mins	Place on enamel tray on wire rack on turntable. Turn halfway.
	450 g	or Combi: Grill 1 + Medium	8-9 mins	Place on enamel tray on wire rack on turntable. Turn halfway.



Note

Always check that food is piping hot after reheating in the microwave. If unsure return to oven. Foods will still require a stand time, especially if they cannot be stirred. The denser the food the longer the stand time.

Cooking Charts

Food	Weight/ Quantity	Power Level	Time to Select (approx)	Instructions/Guidelines
Rice - Place in a large 3 litre (6 pt) microwave safe bowl				
Basmati	250 g	Medium	13-16 mins	Use 600 ml (1 pt) cold water. Cover. Stir halfway.
Easycook white	250 g	High	16-17 mins	
Easycook brown	250 g	High	20-24 mins	
Long grain white	250 g	Medium	14-18 mins	
Brown basmati	250 g	Medium	20-25 mins	
Milk pudding – Use large bowl, cover. Stir halfway.				
Flaked rice	50 g	Simmer	35-45 mins	Add 600 ml (1 pt) milk and 30 ml sugar.
Pudding rice	50 g	High then Simmer	5 mins 40 mins	Add 450 ml (1 pt) milk and 30 ml sugar.
Sausages from raw – caution: Hot Fat! Remove oven accessories with care. For guidelines see Meat Chapter page 88.				
Thick	454 g (8)	Grill 1	17-18 mins	Place on wire rack on enamel tray on turntable. Turn halfway.
Turkey from raw- Caution: Hot fat! Remove oven accessories with care. For guidelines see Meat Chapter page 88.				
Turkey, crown	-	Combi: 190 °C + Simmer	13-15 mins per 450 g	Place on enamel tray on turntable. Turn halfway.
Fresh vegetables – place in shallow micro-safe dish				
Asparagus	450 g	High	5-8 mins	Add 90 ml (6 tbsp) water. Cover.
Broad beans	450 g	High	5-6 mins	
Runner beans	450 g	High	7-8 mins	
Beetroot	450 g	Medium	12-15 mins	
Broccoli	450 g	High	6-8 mins	
Brussel sprouts	450 g	High	8-9 mins	
Cabbage - sliced	450 g	High	7-9 mins	
Carrots - sliced	450 g	High	6-8 mins	
Cauliflower - florets	450 g	High	10-12 mins	



Note

Always check that food is piping hot after reheating in the microwave. If unsure return to oven. Foods will still require a stand time, especially if they cannot be stirred. The denser the food the longer the stand time.

Cooking Charts

Food	Weight/ Quantity	Power Level	Time to Select (approx)	Instructions/ Guidelines
Fresh vegetables – place in shallow micro-safe dish				
Courgettes	450 g	High	5 mins	Add 90 ml (6 tbsp) water. Cover.
Corn on the cob	450 g	High	6-7 mins	
Leeks - sliced	450 g	High	7-8 mins	
Mushrooms	450 g	High	5 mins	
Parsnips - sliced	450 g	High	5-6 mins	
Peas	450 g	High	4-6 mins	
Potatoes - boiled	450 g	High	7-9 mins	
Potatoes, par-boiled	450 g	High	5-6 mins	
Potatoes - jacket (225 g)	1	High	5 mins	Wash and prick skins several times. Place directly on glass turntable if cooking by microwave. If cooked by combination place directly on enamel tray on turntable. Allow to stand for 5 minutes. Or use Auto program jacket potatoes.
		or Combi: 220 °C + Simmer	15 mins	
	2	High	8 mins	
		or Combi: 220 °C + Simmer	20 mins	
	4	High	13 mins	
		or Combi: 220 °C + Simmer	25 mins	
6	High	18-20 mins		
	or Combi: 220 °C + Simmer	30 mins		
Spinach	450 g	High	6 mins	Add 90 ml (6 tbsp) water. Cover.
Swede - cubed	450 g	High	8-12 mins	



Note

Always check that food is piping hot after reheating in the microwave. If unsure return to oven. Foods will still require a stand time, especially if they cannot be stirred. The denser the food the longer the stand time.

Cooking Charts

Food	Weight/ Quantity	Power Level	Time to Select (approx)	Instructions/ Guidelines
Frozen vegetables - place in shallow micro-safe dish.				
Beans - broad	450 g	High	8 mins	Add 30 ml (2 tbsp) water. Cover.
Beans - green	450 g	High	8-9 mins	
Broccoli	450 g	High	8-9 mins	
Brussels sprouts	450 g	High	9-10 mins	
Cabbage - shredded	450 g	High	6-7 mins	Add 30 ml (2 tbsp) water. Cover.
Carrots - sliced	450 g	High	8 mins	
Cauliflower	450 g	High	9-10 mins	
Peas	450 g	High	6-7 mins	
Spinach - nuggets	450 g	High	8-9 mins	
Sweetcorn	450 g	High	7 mins	
Miscellaneous				
Frozen yorkshire puddings	370 g	Convection: Preheat 220 °C then 220 °C	15-20 mins	Place directly onto enamel tray.



Note

Always check that food is piping hot after reheating in the microwave. If unsure return to oven. Foods will still require a stand time, especially if they cannot be stirred. The denser the food the longer the stand time.

Increasing and Decreasing Recipes

Increasing Recipes

- To increase a recipe from 4-6 servings, increase each ingredient listed by half. To double the quantity, simply double every ingredient listed.
- Do not forget that large quantities will require a larger dish. Make sure that it is deep enough to prevent the recipe from boiling over during cooking.
- Cover as directed in the recipe. Stir or rearrange foods as recommended.
- Increase the stand times by 5 minutes per 450 g.
- Always check the recipe during cooking.
- When increasing the ingredients to 6 servings, add an extra one third of the original cooking time, i.e. 30 minutes on **Medium** microwave for 4 servings will become 40 minutes on **Medium** microwave for 6 servings.

- When doubling a recipe from 4-8, add on half the original cooking time, i.e. 30 minutes on **Medium** microwave for 4 servings will become 45 minutes on **Medium** microwave for 8 servings.

Decreasing Recipes

- To decrease a recipe from 4 servings to 2 servings, halve the ingredients listed.
- Choose a dish that is proportionally smaller than the one recommended in the recipe, however make sure it is deep enough to stop food boiling over.
- Allow half to two-thirds of the original cooking time, i.e. 30 minutes on **Medium** microwave for 4 servings will become 15-20 minutes on **Medium** microwave for 2 servings.

Using Recipes from Other Books

The best way to convert a family favourite dish is to find a similar recipe in a cookery book to give you a guide to the correct method and timings to use.

When using other cookbooks, the 1000 W output power of your oven must be allowed for. Use the same power level suggested e.g. **High** or **Medium** microwave and select the same cooking

time suggested, however check the progress of the food during cooking and adjust the time if necessary.

Cooking for One

- For one serving quarter all ingredients listed.
- Choose a dish that is proportionally smaller than the one recommended in the recipe.
- Use the same cooking power recommended in the original recipe.
- Start by cooking for one quarter of the recommended cooking time, although extra time in most cases will be required.
- Always check the food during cooking.
- There is not a great saving for reduced quantities of soups, casseroles, stews and rice, as a minimum time is required to tenderise meats and blend flavours.
- When cooking for one it often makes sense to cook for two and plate up both meals. Freeze one meal for a later date.

Carrot and Orange Soup

ingredients

Serves 4

25 g (1 oz) butter
1 medium onion,
coarsely chopped
700 g (1 ½ lb) carrots,
thickly sliced
1 litre (1 ¾ pt) vegetable stock
½ orange, grated zest
90 ml (6 tbsp) orange juice
60 ml (4 tbsp) crème fraîche
salt and pepper
15 ml (1 tbsp) fresh ch-,
chopped

Dish: 1 x 3 litre (6 pt) Pyrex®
casserole dish

Accessory: none

1. Place the butter and onion into casserole dish. Cover and cook on **High** microwave for 3-4 minutes or until soft.
2. Add the carrots. Cover and cook on **High** microwave for 8-10 minutes or until the vegetables are softened. Stir halfway.
3. Add stock and orange zest. Cover and cook on **High** microwave for 5 minutes then **Low** microwave for 15 minutes or until the carrots are soft.
4. Place into a liquidiser and purée until smooth.
5. Return purée to the bowl and add orange juice. Stir in the crème fraîche and season to taste. Cover and cook on **Medium** microwave for 3-4 minutes or until piping hot.
6. Garnish with fresh chives.

Sweet Potato Soup

ingredients

Serves 4

15 ml (1 tbsp) olive oil
1 medium onion,
coarsely chopped
2 clove of garlic, crushed
700 g (1 ½ lb) sweet
potatoes, peeled and chopped
1 large red pepper,
deseeded and chopped
725 ml (1 ¼ pt)
vegetable stock
150 ml (¼ pt) coconut milk
salt and pepper

Dish: 1 x 3 litre (6 pt) Pyrex®
casserole dish with lid

Accessory: none

1. Place the oil, onion and garlic into casserole dish, cover. Cook on **Medium** microwave for 3 minutes or until soft.
2. Add the sweet potato and pepper and cook on **Medium** microwave for 5 minutes. Add stock, cover and cook on **Medium** microwave for 15 minutes, or until the potatoes are soft, stirring halfway.
3. Cool. Place in a liquidiser and purée until smooth. Stir in the coconut milk and season to taste.
4. Cover and cook on **Medium** microwave for 3 minutes or until piping hot.

Goat's Cheese & Basil Ciabatta

ingredients

Serves 4

2 ciabatta rolls
1 clove of garlic, halved
1 beef tomato, sliced
100 g (4 oz) goats cheese
8 black olives, stoned and quartered
15 ml (1 tbsp) olive oil
fresh basil, chopped
pepper

Dish: none

Accessory: Enamel tray and wire
rack

1. Halve the rolls and place on the wire rack on enamel tray. Cook on **Grill 1** for 3-4 minutes or until lightly toasted. Rub each half with the garlic.
2. Top each half with the sliced tomato, crumble over the goats cheese and top with olives. Drizzle with olive oil and place on the wire rack on the enamel tray. Cook on **Grill 1** for 5-7 minutes or until the cheese is golden and bubbling.
3. Sprinkle with basil and season with pepper. Serve immediately.

Onion and Feta Cheese Tartlets

ingredients

Serves 6

250 g (9 oz) ready made puff pastry
 30 ml (2 tbsp) olive oil
 300 g (11 oz) onions,
 peeled and sliced
 25 g (1 oz) pine nuts
 100 g (4 oz) feta cheese, crumbled
 50 g (2 oz) pitted black olives,
 roughly chopped
 50 g (2 oz) sun-dried tomatoes
 (in oil or rehydrated),
 roughly chopped
 15 g (½ oz) capers
 salt and pepper
 fresh oregano sprigs to garnish

Dish: 1 x 3 litre (6 pt) Pyrex®
 casserole dish with lid,
 1 x 32 x 23 cm (12 ½ x 9 inch)
 greased baking sheet

Accessory: Enamel tray

1. Roll out the puff pastry and cut into 6 circles each 7 ½ cm (3 inch) in diameter. Chill pastry for 30 minutes.
2. Put oil and onions into casserole dish, cover and cook on **High** microwave for 10-13 minutes or until slightly browned. Cool for 5 minutes.
3. Preheat oven on **Convection** 200 °C with enamel tray.
4. Stir nuts, cheese, olives, sun-dried tomatoes and capers into onion mixture. Season well.
5. Place pastry circles on the baking sheet and prick with a fork.
6. Divide the onion mixture among the pastry circles.
7. Cook on **Convection** 220 °C for 10-15 minutes.
8. Garnish with fresh oregano sprigs.

Minestrone Soup

ingredients

Serves 6

30 ml (2 tbsp) olive oil
 1 carrot, finely diced
 1 celery stick, finely diced
 1 red onion, finely diced
 1 garlic clove, crushed
 400 g (14 fl. oz) canned chopped
 tomatoes
 15 ml (1 tbsp) tomato purée
 900 ml (1 ½ pt) vegetable stock
 100 g (4 oz) green cabbage,
 finely shredded
 6 basil leaves, roughly chopped
 50 g (2 oz) small pasta shapes
 400 g (14 oz) canned baked beans
 salt and pepper
 Parmesan

Dish: 1 x large Pyrex® casserole
 dish with lid

Accessory: none

1. Place the olive oil, carrot, celery, onion and garlic into large casserole dish, cover with a lid and cook on **High** microwave for 5 minutes.
2. Add the tomatoes, tomato purée and stock and cook on **High** microwave for 5 minutes then **Simmer** microwave for 15 minutes.
3. Stir in the cabbage, basil, pasta, baked beans and seasoning and cook on **Simmer** microwave for 35 minutes. Serve sprinkled with Parmesan

Quinoa Tabbouleh with Mint

ingredients

Serves 6-8

300 g (11 oz) quinoa
 2 courgettes, finely chopped
 300 g (11 oz) frozen peas
 1 bunch mint, chopped
 100 ml (3 ½ fl. oz) olive oil
 2 lemons, juiced
 salt and pepper

Dish: 1 x large Pyrex® bowl,
 1 x medium Pyrex® bowl,
 1 x small Pyrex® bowl

Accessory: none

1. Place the quinoa and 600 ml (1 pt) of salted hot water in a large bowl, cover and cook on **High** microwave for 5 minutes then **Simmer** microwave for 15 minutes. Drain and leave to cool.
2. Place the courgettes and peas in a medium bowl with 30 ml (2 tbsp) cold water and cook on **High** microwave for approx. 6-7 minutes. Drain well.
3. Mix the mint, olive oil and lemon juice in a small bowl. Add this mixture to the quinoa, courgette and peas. Season and leave to rest for several hours before serving.

Fish

Fish cooks very well by microwave as it stays moist and the lingering fish smells left in conventional ovens are avoided.

When is Fish Cooked?

Fish is cooked when it flakes easily and becomes opaque.

For fish with a strong odour, eliminate the smell after cooking by placing 600 ml (1 pt) of boiling water and 1 sliced lemon in a large bowl, cook on **Simmer** microwave for 20 minutes. Wipe out oven with a dry cloth.



Whole Fish

If cooking 2 whole fish together, they should be arranged head to tail for even cooking.

Large whole fish must have the tail and head shielded halfway through cooking with smooth pieces of tin foil secured with cocktail sticks.



Arranging

Thin fillets of fish i.e. plaice, should be rolled up prior to cooking to avoid overcooking on the thinner outside edge and tail.

Fish steaks should be arranged in a circle, thicker part to the outside. Cover with cling film or lid.



Liquid

Fresh fish should always be sprinkled with 30 ml (2 tbsp) of lemon juice, white wine or water.

When cooking frozen fish, add liquid as above for even cooking.

Do not sprinkle salt onto fish before cooking as this may make the fish dry.

Noise

During cooking, popping sounds may be heard. This is due to moisture trapped between the flesh, particularly with oily fish such as salmon and mackerel. This can be minimised when cooking if the skin and flesh is pierced several times with a cocktail stick.

Tuna Fish Cakes

ingredients

Serves 4

350 g (12 oz) potatoes, peeled
25 g (1 oz) butter
1 small onion, chopped
200 g (7 oz) canned tuna, drained
1 egg, hard boiled, chopped
30 ml (2 tbsp) fresh parsley, chopped
10 ml (2 tsp) lemon juice
salt and pepper
1 egg, beaten
100 g (4 oz) breadcrumbs

Dish: 1 x large Pyrex®
casserole dish

1 x large Pyrex® bowl

Accessory: Enamel tray + wire rack

1. Cook potatoes with 45 ml (3 tbsp) water, covered on **High** microwave for 6-8 minutes or until cooked. Drain.
2. Place butter and onion in a bowl, cover and cook on **High** microwave for 4 minutes or until soft. Add potatoes and mash.
3. Stir in tuna, hard boiled egg, parsley and lemon juice, season well.
4. Shape into 8 cakes and coat in beaten egg and breadcrumbs.
5. Place on enamel tray on wire rack and cook on **Combination: Convection 220 °C + Warm** microwave for 15-25 minutes or until brown, turning halfway.

Special Occasion Fish Pie

ingredients

Serves 4

450 g (1 lb) white fish
50 g (2 oz) butter
50 g (2 oz) flour
450 ml (¾ pt) milk
300 ml (½ pt) white wine
450 g (1 lb) mixed seafood
6 gherkins, diced
15 ml (1 tbsp) fresh parsley, chopped
10 ml (2 tsp) dill, chopped
salt and pepper
450 g (1 lb) potatoes, peeled
15 ml (1 tbsp) capers
50 g (2 oz) butter, melted
50 g (2 oz) Cheddar cheese, grated

Dish: 1 x large Pyrex® gratin dish

Accessory: Enamel tray

1. Place the white fish with 30 ml (2 tbsp) water in a shallow dish. Cover and cook on **High** microwave for 4-5 minutes or on **auto program fresh fish** (see page 59). Drain, skin, bone and flake.
2. Make the sauce by melting the butter in a large jug on **Medium** microwave for 1 minute. Add the flour and stir well. Mix in the milk and wine and cook on **High** microwave for 4-5 minutes. Stir halfway. Mix in the fish, mixed seafood, gherkins and herbs. Season and pour into the dish.
3. Grate the potatoes and mix in the capers, melted butter and grated cheese. Place lightly on the fish sauce without pressing firmly to keep the grated form. Place on enamel tray and cook on **Combination: Convection 220 °C + Simmer** microwave for 35-40 minutes or until piping hot and golden.

Salmon and Vegetable Mornay

ingredients

Serves 4

100 g (4 oz) broccoli
100 g (4 oz) cauliflower
1 medium red pepper, deseeded and diced
198 g (7 oz) canned salmon, drained
25 g (1 oz) butter
30 ml (2 tbsp) plain flour
300 ml (½ pt) milk
50 g (2 oz) Cheddar cheese, grated
150 ml (¼ pt) cream, optional
salt and pepper
15 g (½ oz) butter
75 g (3 oz) fresh white breadcrumbs
15 ml (1 tbsp) fresh parsley, chopped
pinch of paprika

Dish: 1 x 20 x 25 cm (8 x 10 inch)
Pyrex® dish

1 x large Pyrex® jug

1 x small Pyrex® bowl

Accessory: Enamel tray

1. Break broccoli and cauliflower into florets, add red pepper and 30 ml (2 tbsp) water. Cover and cook on **High** microwave for 5-6 minutes or until soft. Drain.
2. Flake salmon and mix with vegetables.
3. Melt butter in jug on **High** microwave for approx. 20-30 seconds. Stir in flour then milk. Cook on **High** microwave for 2 minutes or until mixture boils and thickens; stir halfway. Stir in cheese, cream and seasoning. Pour cheese sauce over vegetables and salmon.
4. Melt extra butter in a small bowl on **High** microwave for approx 15-20 seconds. Stir in breadcrumbs, parsley and paprika. Sprinkle over vegetable mixture.
5. Place on enamel tray and cook on **Combination: 220 °C + Low** microwave for 10-12 minutes or until golden brown.

Bouillabaisse

ingredients

Serves 6

225 g (8 oz) tomatoes
 125 ml (4 fl. oz) olive oil
 30 ml (2 tbsp) tomato purée
 2 onions, chopped
 1 large leek, sliced
 4 garlic cloves, crushed
 1.2 ltr (2 pt) fish stock
 salt and black pepper
 150 ml (¼ pt) dry white wine
 4 sprig thyme
 small piece orange peel
 4 strands saffron
 5 ml (1 tsp) chilli sauce
 450 g (1 lb) cod, haddock or coley
 450 g (1 lb) mixed seafood
 4 large fresh prawns
 bunch dill, chopped, to garnish

Dish: 1 x 3 litre (6 pt) Pyrex®
 casserole dish

Accessory: none

1. Skin the tomatoes and cut into four pieces, removing the cores. Place the oil and tomato purée in a large bowl, heat on **High** microwave for 1 minute and mix well. Add the onions and leek, cook on **High** microwave for 3-4 minutes or until soft.
2. Add the garlic, tomatoes, stock, seasoning, wine, thyme, orange peel, saffron and chilli sauce. Heat on **High** microwave for 3-4 minutes. Skin the fish, cut into chunks and add to the tomato liquid. Cook on **High** microwave for 3-4 minutes or until the fish is cooked. Add the mixed seafood and prawns and heat again for 2-3 minutes on **High** microwave or until hot, taking care not to overcook the fish.
3. Serve garnished with dill.

Thai Trout

ingredients

Serves 2

2 trout fillets,
 approx 150 g (5 oz) each
 2 cloves of garlic, finely chopped
 1-2 small red chilli, finely chopped
 1 lime, zest and juice
 4 spring onions, finely chopped
 30 ml (2 tbsp) light soy sauce

Dish: 1 x Pyrex® shallow dish

Accessory: none

1. Place fish fillets into a shallow dish, sprinkle the remaining ingredients on the top of the fish. Cover and cook on **Medium** microwave for 4-5 minutes, or until the fish is cooked through.

Cod and Leek Bake

ingredients

Serves 6

800 g (1 lb 12 oz) cod, fillets
 2 large leeks, finely sliced
 300 ml (½ pt) single cream
 500 g (1 lb 2 oz) potatoes, quartered
 50 g (2 oz) Cheddar cheese, grated
 salt and pepper

Dish: 1 x shallow dish,
 1 x 27 cm (10 ½ inch) Pyrex®
 casserole dish with lid

1 x large Pyrex® dish
 1 x 27 cm (10 ½ inch) round dish
Accessory: Enamel tray

1. Place the cod in a shallow dish, add 45 ml (3 tbsp) water. Cover and cook on **High** microwave for 5-6 minutes. Drain the cod and break into pieces, taking care to remove all the bones and the skin
2. Place leeks in a casserole dish, cover and cook on **High** microwave for 10 minutes. Mix together the fish pieces, leeks, cream, cheese, salt and pepper
3. Place the potatoes in a large dish, cover and cook on **High** microwave for 9-10 minutes. Place the potatoes in a round buttered dish, cover with the fish, leeks and cheese mixture.
4. Preheat the oven with the enamel tray on **Convection** 200 °C. Place the dish in the oven and cook on **Convection** 200 °C + **Low** microwave for 10-15 minutes, until it is golden brown on top.

Meat and Poultry

Guidelines

Defrosted Joints

If the meat has previously been frozen, ensure it is properly thawed before cooking by microwave. Defrosted joints of meat must be allowed to **Stand** for a minimum of 1 hour before cooking to ensure the centre is fully defrosted.

Fat

Large amounts of fat absorb microwave energy and can cause the meat next to it to overcook. Always choose joints that aren't excessively fatty.



Standing Time

Meat and poultry require a minimum of 15 minutes **standing time** wrapped in aluminium foil after cooking by microwave. Roast meat is always easier to carve after **standing** and the meat will continue to cook during the **stand time**.

Bone

Bone tips on legs of lamb and crown roasts may need shielding when cooked by microwave, to prevent overcooking.

Turning

Joints and poultry should be turned over halfway through cooking.

Shielding

Large joints may need shielding with pieces of smooth aluminium foil after half the cooking time to avoid overcooking on the outside edges. Turkeys and large chickens should have their breast meat, legs and wings protected. Secure foil with cocktail sticks and do not allow foil to touch the walls of the oven.

How to Roast a Joint by Combination

Place the joint on enamel tray and place on glass turntable.

Meat and Poultry

How to Roast a Joint by Microwave

To roast basic joints of meat place the joint onto the rack of a microwave roasting set and cover with a dome lid. Alternatively use a large, shallow dish and place the joint on an upturned saucer and cover with cling film.



Roasting Bags

Roasting bags are useful when split up one side to tent a joint for roasting by power and time.

Do not use the metal twists supplied.

Tips

Braised and stewed meat cooked in a microwave has a slightly firm texture and therefore it is essential to purchase good quality meats.

When cooking a casserole, place a saucer or small upturned plate over the meat to keep it submerged in the juices.

How to Cook Small Cuts of Meat by Microwave

Some cuts of meat can be cooked successfully by microwave although due to their short cooking times and no heat source, they will not crisp and brown.

They should always be cooked on a microwave safe rack to lift them out of their juices.

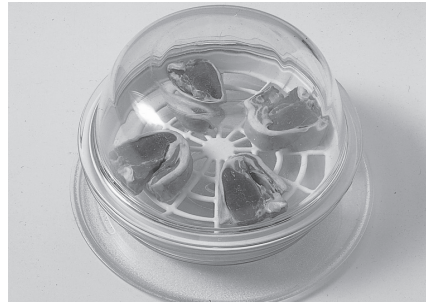

Crispy Bacon

Place on a microwave safe rack (optional extra obtainable from cookware shops). Cover with a plain piece of kitchen towel to minimise splatter. Cook on **High** microwave for approx. 1 minute per rasher, or until desired crispness is achieved.

Coq au Vin

ingredients

Serves 4

1.2 kg (2 ½ lb) chicken portions, approx. 4
 5 ml (1 tsp) mixed herbs
 salt and pepper
 100 g (4 oz) streaky bacon
 100 g (4 oz) button mushrooms
 1 clove of garlic, crushed
 450 g (1 lb) whole shallots
 30 ml (2 tbsp) brandy
 300 ml (½ pt) red wine
 300 ml (½ pt) chicken stock
 15 ml (1 tbsp) cornflour

Dish: 1 x large Pyrex®
 casserole dish with lid
Accessory: Enamel tray

1. Place all ingredients, apart from the cornflour, in casserole dish and cover.
2. Place on enamel tray and cook on **Combination: Convection** 160 °C + **Warm** microwave for 1 hour 10 minutes or until cooked through. Stir halfway during cooking.
3. Remove skin from chicken pieces and skim off any excess fat. Thicken using a little cornflour mixed with water. Serve sprinkled with chopped parsley.

Chicken Satay

ingredients

Serves 4-6

4 chicken breast fillets, skinned and chopped into small chunks
 100 g (4 oz) creamed coconut
 45 ml (3 tbsp) lemon juice
 30 ml (2 tbsp) soy sauce
 30 ml (2 tbsp) vegetable oil
 2 garlic cloves, crushed
 5 ml (1 tsp) ground turmeric
 5 ml (1 tsp) five-spice powder
 5 ml (1 tsp) coriander seeds
 5 ml (1 tsp) cumin seeds
 90 ml (6 tbsp) peanut butter
 large pinch chilli powder

Dish: 1 x small mixing bowl,
 8 x wooden skewers
Accessory: Enamel tray + wire rack

1. Place chicken, 50 g (2 oz) creamed coconut, 30 ml (2 tbsp) lemon juice and 15 ml (1 tbsp) soy sauce into a blender or food processor. Add the oil, garlic, turmeric, five spice, coriander and cumin and blend until smooth.
2. Pour over the chicken. Cover and marinate in the fridge for 2-3 hours or overnight.
3. For the serving sauce: Pour 50 g (2 oz) of creamed coconut into a large jug. Add the peanut butter, 15 ml (1 tbsp) of the lemon juice, 15 ml (1 tbsp) of the soy sauce, the chilli powder and 80 ml (5 tbsp) water. Cook on **High** microwave for 3-4 minutes or until the sauce boils and thickens, stirring frequently. Turn into a serving bowl.
4. Thread the chicken onto wooden skewers. Place on wire rack on enamel tray and cook on **Combination: Convection** 220 °C + **Warm** microwave for 26-30 minutes or until cooked through, turning occasionally. Serve hot with sauce for dipping.

Barbeque Spare Ribs

ingredients

Serves 4

675 g (1 ½ lb) pork ribs
 30 ml (2 tbsp) white wine vinegar,
Sauce:
 45 ml (3 tbsp) tomato sauce
 45 ml (3 tbsp) soy sauce
 45 ml (3 tbsp) honey
 5 ml (1 tsp) dry mustard powder
 45 ml (3 tbsp) plum jam

Dish: 1 x large Pyrex®
 casserole dish with lid
 1 x Pyrex® bowl
 1 x Pyrex® shallow dish
Accessory: Enamel tray

1. Place ribs into large casserole dish, cover with water and add the vinegar.
2. Cover and cook on **High** microwave for 6-8 minutes then **Simmer** microwave for 20 minutes. Drain.
3. Combine all sauce ingredients together in a Pyrex® bowl and heat on **Medium** microwave for 2 minutes. Mix thoroughly.
4. Toss ribs in sauce. Arrange on the base of shallow dish on the enamel tray and cook on **Combination: Convection** 190 °C + **Simmer** microwave for 15-20 minutes or until ribs are dark brown and crispy.

Casserole Pork with Herby Dumplings

ingredients

Serves 4

30 ml (2 tbsp) oil
 1 medium onion, chopped
 1 green pepper, deseeded and chopped
 225 g (8 oz) carrots, sliced
 450 g (1 lb) lean pork, cubed
 30 ml (2 tbsp) seasoned flour
 5 ml (1 tsp) ground bay leaves
 5 ml (1 tsp) dried sage
 salt and pepper
 300 ml (½ pt) dry cider
Dumplings:
 175 g (6 oz) self raising flour
 75 g (3 oz) suet
 pinch of salt
 5 ml (1 tsp) mustard powder
 15 ml (1 tbsp) fresh parsley, chopped
 150 ml (¼ pt) cold water

Dish: 1 x large Pyrex®
 casserole dish with lid
Accessory: Enamel tray

1. Place oil, onion, green pepper and carrots in casserole dish, cover and cook on **High** microwave for 5 minutes or until soft.
2. Toss pork in seasoned flour and add to onion mixture. Stir in all other ingredients, cover, place on enamel tray and cook on **Combination: Convection 160 °C + Warm** microwave for 1 hour or until pork is tender.
3. Whilst cooking make the dumplings by combining the flour, suet, salt, mustard and parsley. Add the water to make a stiff dough. Shape dough into 8 round dumplings.
4. When pork is cooked, uncover and place dumplings around the edge of dish. Cook uncovered on the enamel tray on **Combination: Convection 160 °C + Warm** microwave for 15 minutes or until dumplings are cooked through.

Toad in the Hole

ingredients

Serves 4

150 g (5 oz) plain flour
 3 ml (½ tsp) salt
 2 eggs
 300 ml (½ pt) milk and water
 25 g (1 oz) oil
 450 g (1 lb) sausages

Dish: 1 x mixing bowl,
 1 x 25 x 18 cm (10 x 7 inch) oblong
 rectangular tin
Accessory: Enamel tray

1. Preheat oven with enamel tray on **Convection 220 °C**.
2. Sift flour and salt in a bowl. Add eggs and half the liquid. Beat until smooth. Gradually stir in remaining liquid.
3. Put oil in tin with sausages on enamel tray. Cook on **Convection 220 °C** for 15 minutes.
4. Pour in the batter and cook for 15-20 minutes on **Convection 220 °C** or until the batter is well risen and golden brown.

Creamy Chicken Gratin

ingredients

Serves 4

350 g (12 oz) leeks,
 trimmed and sliced
 25 g (1 oz) butter
 30 ml (2 tbsp) plain flour
 300 ml (½ pt) milk
 225 g (8 oz) cooked chicken, chopped
 100 g (4 oz) ham, chopped
 175 g (6 oz) Gruyere cheese, grated
 4 frozen garlic bread slices

Dish: 1 x large Pyrex® bowl
 1 x 26 cm (10 ½ inch) gratin dish
Accessory: Enamel tray

1. Slice the leeks and place in a large bowl with the butter. Cover and soften on **High** microwave for 3-4 minutes or until softened.
2. Add the flour and mix well. Stir in the milk and heat, uncovered on **High** microwave for 4-5 minutes or until thickened. Stir halfway. Add the chicken, ham and cheese then season and mix well.
3. Pour into the gratin dish and top with the garlic bread slices. Place on enamel tray and cook on **Combination: Convection 220 °C + Low** microwave for 10-15 minutes or until piping hot and golden.

Belgian Beef Casserole

ingredients

Serves 4

675 g (1 ½ lb) braising steak, cubed
 3 large onions, thinly sliced
 1 clove of garlic, crushed
 30 ml (2 tbsp) seasoned flour
 15 ml (1 tbsp) brown sugar
 300 ml (½ pt) hot beef stock
 300 ml (½ pt) light ale
 15 ml (1 tbsp) wine vinegar
 5 ml (1 tsp) mixed herbs
 2 bay leaves

Topping:

15 ml (1 tbsp) french mustard
 60 ml (4 tbsp) butter, softened
 1 clove of garlic, crushed
 8 x 2.5 cm (1 inch)
 french bread, sliced

Dish: 1 x large Pyrex®
 casserole dish with lid
 1 x mixing bowl

Accessory: Enamel tray

1. Combine all the casserole ingredients in dish. Cover with lid and cook on enamel tray on **Combination: Convection** 160 °C + **Warm** microwave for 1 hour, or until meat is tender. Remove bay leaves.
2. *For topping*, blend mustard, butter and garlic in a mixing bowl. Spread over one side of each bread slice.
2. Uncover casserole and arrange bread on top. Return to oven and cook uncovered on **Combination: Convection** 160 °C + **Warm** microwave for a further 10 minutes. The casserole is ready when the bread slices are crisp and golden.

Savoury Mince

ingredients

Serves 4

1 onion, diced
 1 clove of garlic, crushed
 15 ml (1 tbsp) oil
 400 g (14 oz) canned chopped tomatoes
 15 ml (1 tbsp) tomato purée
 5 ml (1 tsp) mixed herbs
 450 g (1 lb) mince
 salt and pepper

Dish: 1 x large Pyrex®
 casserole dish with lid

Accessory: none

1. Place onion, garlic and oil in casserole dish, cover and cook on **High** microwave for 2 minutes or until soft.
2. Place all other ingredients in casserole dish. Stir well.
3. Cover and cook on **High** microwave for 10 minutes then **Medium** microwave for 15-20 minutes or until cooked.

Variation: Chilli con carne

Add 400 g (14 oz) canned red kidney beans drained, 5-10 ml (1-2 tsp) chilli powder, 1 diced green pepper to the ingredients above.

Shepherd's Pie

ingredients

Serves 4

1 medium onion, chopped
 2 carrots, chopped
 25 g (1 oz) butter
 350 g (12 oz) lamb or beef mince
 300 ml (½ pt) hot lamb or beef stock
 3 ml (½ tsp) Worcestershire sauce
 5 ml (1 tsp) tomato purée
 15 ml (1 tbsp) cornflour
 salt and pepper
 675 g (1 ½ lb) potatoes, cubed
 135 ml (9 tbsp) water
 30 ml (2 tbsp) milk
 25 g (1 oz) cheese

Dish: 1 x medium Pyrex®
 casserole dish with lid
 1 x large Pyrex® casserole dish
 with lid
 1 x square Pyrex® dish 22 x 22 cm
 (8 ½ inch x 8 ½ inch)

Accessory: Enamel tray

1. Place onion, carrots and butter in medium casserole dish. Cover and cook on **High** microwave for 3-5 minutes or until soft.
2. Add mince to vegetables and mix well. Mix together stock, Worcestershire sauce and tomato purée, pour over mince and season to taste. Cook on **High** microwave for 5 minutes. Add cornflour, cook on **High** microwave for 5-7 minutes or until thickened. Transfer to square Pyrex® dish.
3. Cook potatoes with water in large casserole dish, covered on **High** microwave for 7-8 minutes. Drain and mash well with the milk and spread on top of the meat, using a fork to make a pattern on top.
4. Sprinkle with cheese, place on enamel tray and cook on **Combination: Convection** 190 °C + **Warm** microwave for approx. 15-20 minutes or until top is crisp and golden.

Lasagne

ingredients

Serves 4

2 x quantities of white sauce
(refer to page 103)
5 ml (1 tsp) mustard
100 g (4 oz) grated cheese
salt and pepper
1 quantity of savoury mince
(refer to page 92)
12 sheets pre-cooked lasagne
60 ml (4 tbsp) Parmesan cheese

Dish: 1 x large Pyrex®
rectangular dish

Accessory: Enamel tray

1. Add mustard, cheese and seasoning to the hot white sauce.
2. Cover the base of the dish with a layer of cheese sauce, then a layer of lasagne, followed by a layer of hot meat mixture. Continue with a layer of lasagne then meat, ending with a layer of cheese sauce.
3. Sprinkle Parmesan cheese over the top, place on enamel tray and cook on **Combination: Convection** 190 °C + **Simmer** microwave for 15-20 minutes or until the pasta is tender and the top is crispy and golden brown.

Hungarian Goulash

ingredients

Serves 4

600 g (1 ¼ lb) braising steak, cubed
45 ml (3 tbsp) seasoned flour
600 ml (1 pt) hot beef stock
45 ml (3 tbsp) tomato purée
30 ml (2 tbsp) paprika
5 ml (1 tsp) sugar
60 ml (4 tbsp) soured cream

Dish: 1 x large Pyrex®
casserole dish with lid

Accessory: Enamel tray

1. Toss meat in the flour. Combine all ingredients except the soured cream in casserole dish, cover.
2. Place on enamel tray and cook on **Combination: Convection** 160 °C + **Warm** microwave for 1 hour 15 minutes, or until the meat is tender.
3. Remove from oven and immediately stir in the soured cream. Serve with ribbon noodles.

Moussaka

ingredients

Serves 4

30 ml (2 tbsp) olive oil
2 cloves of crushed garlic
1 medium onion, chopped
1 aubergine, sliced
400 g (14 oz) canned chopped tomatoes
350 g (12 oz) lamb mince
30 ml (2 tbsp) tomato purée
salt and pepper

Topping:

2 eggs
150 ml (¼ pt) single cream
100 g (4 oz) cheese, grated
25 g (1 oz) Parmesan cheese, grated

Dish: 1 x 20 cm (8 inch) shallow dish

Accessory: Enamel tray

1. Place oil, garlic, onion and aubergine in dish. Cover and cook on **High** microwave for 2 minutes or until softened.
2. Add tomatoes and lamb mince and purée and cook re-covered on **High** microwave for 7 minutes. Season and mix well.
3. Whisk eggs, cream and cheese together and pour over lamb. Sprinkle with Parmesan cheese, place on enamel tray and cook on **Combination: Convection** 190 °C + **Simmer** microwave for 15-20 minutes or until topping is puffed and golden.

Kedgeree

ingredients

Serves 4

175 g (6 oz) easy cook brown rice
 450 ml (¾ pt) hot chicken stock
 450 g (1 lb) smoked haddock
 30 ml (2 tbsp) lemon, juiced
 1 medium onion, chopped
 15 ml (1 tbsp) oil
 150 ml (¼ pt) soured cream
 15 ml (1 tbsp) curry paste
 100 g (4 oz) frozen peas
 30 ml (2 tbsp) parsley, chopped
 2 boiled eggs,
 chopped into small chunks

Dish: 1 x large Pyrex®
 casserole dish with lid
 1 x Pyrex® shallow dish
 1 x small Pyrex® dish

Accessory: none

1. Place the rice and chicken stock in casserole dish, cover and cook on **High** microwave for 15-20 minutes or until tender.
2. Place the fish in a shallow dish, sprinkle with lemon juice, cover and cook on **High** microwave for 5-6 minutes or until cooked. Skin and flake.
3. Place onion and oil in a small dish, cover and cook on **High** microwave for 3-4 minutes or until softened.
4. Combine the soured cream with curry paste. Mix into rice then stir in flaked fish, onion, peas, parsley, eggs and seasoning. Cover and cook on **High** microwave for 5 minutes or until piping hot.

Wild Mushroom and Basil Risotto

ingredients

Serves 4

40 g (1 ½ oz) dried cep mushrooms
 50 g (2 oz) butter
 1 clove of garlic, finely chopped
 1 small onion, finely chopped
 freshly ground black pepper
 250 g (9 oz) arborio rice
 300 ml (½ pt) hot vegetable stock
 12 basil leaves, torn

Dish: 1 x Pyrex® shallow dish
 1 x large casserole dish with lid

Accessory: none

1. In shallow dish, soak mushrooms in 300 ml (½ pt) warm water.
2. Place the butter, garlic and onion in a large casserole dish, cover and cook on **High** microwave for 3 minutes, or until softened. Season with freshly ground black pepper.
3. Stir the rice into the butter mixture and add the hot stock and soaking liquid from the mushrooms. Cover and cook for a further 5 minutes on **High** microwave.
4. Stir the mushrooms into the rice mixture. Cover and cook for a further 5 minutes on **High** microwave.
5. Stir and add the basil. Continue to cook for the final 5 minutes on **High** microwave. Leave to stand for approx. 10 minutes and then stir with a fork.

Vegetable and Chick Pea Casserole

ingredients

Serves 4

1 medium onion, chopped
 10 ml (2 tsp) vegetable oil
 2 medium courgettes, thickly sliced
 1 red pepper, deseeded and chopped
 2 medium carrots, peeled and sliced
 1 small cauliflower, divided into florets
 100 g (4 oz) dried apricots, halved
 2 cloves of garlic, crushed
 425 g (15 oz) canned chick peas,
 drained
 3 ml (½ tsp) ground turmeric
 3 ml (½ tsp) ground coriander
 3 ml (½ tsp) ground cumin
 5 ml (1 tsp) paprika
 2.5 cm (1 inch) piece fresh root ginger,
 peeled and finely chopped
 salt and pepper
 450 ml (¾ pt) hot vegetable stock
 parsley, chopped

Dish: 1 x large casserole dish with lid
 1 x Pyrex® shallow dish

Accessory: none

1. Place the onion and oil in a large casserole dish. Cover and cook on **High** microwave for 3 minutes or until starting to soften.
2. Add the prepared vegetables, apricots, garlic, chick peas and stir in the spices, salt, pepper and stock.
3. Cover and cook on **High** microwave for 20-25 minutes or until vegetables are soft. Stir two or three times during cooking. Serve with couscous or rice and garnish with parsley.

N.B.

To prepare couscous: Place 300 ml (½ pt) vegetable stock in a shallow dish and 1.2 ml (¼ tsp) turmeric. Cook on **High** microwave for 4 minutes or until boiling. Add 175 g (6 oz) couscous and allow to stand for 5 minutes. Fluff up with a fork before serving.

Tagliatelle Toscana

ingredients

Serves 4

400 g (14 oz) fresh tagliatelle
 1 large onion, chopped
 1 clove of garlic, crushed
 15 ml (1 tbsp) olive oil
 1 large aubergine, cubed
 400 g (14 oz) canned chopped tomatoes
 5 ml (1 tsp) basil
 15 ml (1 tbsp) tomato purée
 15 g (½ oz) butter
 salt and pepper
 8-10 black olives, stoned
 100 g (4 oz) mozzarella, diced
 30 ml (2 tbsp) Parmesan cheese, grated

Dish: 2 x large Pyrex®
 casserole dish with lid
Accessory: Enamel tray

1. Cook the pasta in casserole dish with 600 ml (1 pt) boiling water, covered, on **High** microwave for 4 minutes or until tender. Drain.
2. Place onion, garlic and oil in a casserole dish, cover and cook on **High** microwave for 2 minutes or until soft. Add the aubergine, chopped tomatoes, basil, tomato purée, butter, seasoning and olives. Cover and cook on **High** microwave for 6-8 minutes.
3. Mix the drained pasta with the mozzarella. Place in a casserole dish. Pour the sauce over the top. Sprinkle with Parmesan. Place on enamel tray and cook on **Combination: Convection** 220 °C + **Warm** microwave for 6-8 minutes or until golden brown and piping hot.

Roast Vegetable and Pasta Gratin

ingredients

Serves 4

1 aubergine, diced
 2 leeks, sliced
 1 red pepper, chopped
 1 green pepper, chopped
 1 onion, chopped
 1 clove of garlic, crushed
 45 ml (3 tbsp) olive oil
 225 g (8 oz) pasta shapes
 225 g (8 oz) fresh spinach
White sauce:
 40 g (1 ½ oz) butter
 40 g (1 ½ oz) flour
 600 ml (1 pt) milk
 15 ml (1 tbsp) mustard
 50 g (2 oz) Cheddar cheese, grated
 150 g (5 oz) Boursin® cheese
 salt and pepper

Dish: 1 x small roasting dish
 1 x large casserole dish with lid
 1 x large Pyrex® shallow dish
Accessory: Enamel tray

1. Preheat oven with enamel tray on **Convection** 220 °C. Chop all the vegetables except spinach into bite sized pieces and put in roasting dish with the oil. Cook on **Convection** 220 °C 25-30 minutes.
2. Cook the pasta shapes in a casserole dish with 450 ml (¾ pt) boiling water on **High** microwave for 5-6 minutes or until soft. Drain. Wash the spinach and tear into small pieces.
3. Make the white sauce as per instructions on page 103, add the mustard, Cheddar, Boursin® cheese and stir thoroughly until smooth. Season well.
4. Mix the pasta, spinach and roast vegetables with the sauce and place in a large shallow dish. Sprinkle the top with cheese.
5. Cook on enamel tray on **Combination: Convection** 220 °C + **Low** microwave for 10-15 minutes or until golden brown.

Lentil Biryani

ingredients

Serves 4-6

15 ml (1 tbsp) oil
 1 large onion, sliced
 5 ml (1 tsp) ginger root, grated
 1 clove of garlic, crushed
 3 ml (½ tsp) turmeric
 5 ml (1 tsp) chilli powder
 10 ml (2 tsp) curry powder
 150 ml (¼ pt) natural yoghurt
 100 g (4 oz) mushrooms, sliced
 2 tomatoes, peeled and chopped
 100 g (4 oz) canned green lentils
 300 ml (½ pt) hot water
 50 g (2 oz) cashew nuts
 450 g (1 lb) cooked basmati rice
Garnish:
 1 hard boiled egg, sliced
 coriander leaves

Dish: 1 x large Pyrex® casserole dish with lid
Accessory: none

1. Place the oil and onion in a large casserole dish. Cover and cook on **High** microwave for 3 minutes or until softened.
2. Add the ginger, garlic, turmeric, chilli and curry powder. Cover and cook on **High** microwave for 2 minutes.
3. Add the yoghurt, mushrooms, tomatoes, lentils and water. Cover and cook on **High** microwave for 30-35 minutes or until the lentils are tender and the liquid has evaporated.
4. Add the cooked rice and cashew nuts to the lentil mixture and mix thoroughly. Reheat on **High** microwave if necessary. Garnish and serve.

Stuffed Croissants

ingredients

Makes 8

100 g (4 oz) Cheddar cheese, grated
 100 g (4 oz) smoked ham, diced
 1 tomato, deseeded and chopped
 60 ml (4 tbsp) sour cream
 15 ml (1 tbsp) mayonnaise
 10 ml (2 tsp) wholegrain mustard
 pepper
 8 croissants

Dish: 1 x medium Pyrex® mixing bowl

Accessory: Enamel tray + wire rack

1. Combine all the filling ingredients in mixing bowl.
2. Slice in back of each croissant and fill with mixture.
3. Place 4 croissants on enamel tray on wire rack and cook on **Combination: Grill 1 + Simmer** microwave for 5-6 minutes. Repeat with the remaining 4 croissants.

Muffin Pizzas

ingredients

Serves 4

150 ml (¼ pt) Passata
 100 g (4 oz) garlic sausage, cubed
 1 clove of garlic, crushed
 1 small onion, diced
 4 large muffins, halved
 100 g (4 oz) cheese, grated
 50 g (2 oz) canned anchovy fillets
 black olive garnish

Dish: 1 x Pyrex® mixing bowl

Accessory: Enamel tray + wire rack

1. Place Passata, sausage, garlic and onion in a bowl and mix well.
2. Arrange muffin halves, 4 at a time on wire rack on enamel tray and toast on **Grill 1** for 4-6 minutes or until browned.
3. Spread muffins with the mixture. Top with cheese, anchovies and olives.
4. Cook on **Combination: Grill 1 + Warm** microwave for 4-6 minutes or until cheese has melted and is beginning to brown.

Cheese, Onion and Olive Scones

ingredients

Serves 4

1 medium onion, finely chopped
 15 ml (1 tbsp) olive oil
 175 g (6 oz) self-raising flour
 3 ml (½ tsp) salt
 3 ml (½ tsp) mustard powder
 3 ml (½ tsp) cayenne pepper
 salt and pepper
 25 g (1 oz) butter
 40 g (1 ½ oz) strong Cheddar cheese, grated
 40 g (1 ½ oz) Parmesan cheese
 25 g (1 oz) black olives, stoned and chopped
 1 egg, beaten
 45 ml (3 tbsp) milk
 1 egg for glazing

Dish: 1 x small Pyrex® bowl

1 x Pyrex® mixing bowl
 small baking sheet

Accessory: Enamel tray

1. Place onion and oil in a bowl. Cover and cook on **High** microwave for 3 minutes or until softened. Drain.
2. Preheat oven on **Convection 200 °C** with enamel tray.
3. Sift together the flour, salt, mustard and cayenne with seasoning. Rub in the butter.
4. Mix in onion, cheeses and olives. Beat egg and milk together. Pour into flour mixture and bring to a soft dough.
5. On a floured surface roll out dough to approx. 2 cm (¾ inch) thick. Cut out rounds using a 6 cm (2 ½ inch) pastry cutter and brush with beaten egg.
6. Place the dough rounds on a lightly greased baking sheet. Place on the enamel tray and cook on **Convection 200 °C** for 16-20 minutes or until cooked and golden brown.

Brie and Cranberry Crostini

ingredients

Serves 4

1 small baguette, cut into 8 slices
60 ml (4 tbsp) cranberry sauce
175 g (6 oz) brie, sliced
sesame seeds

Dish: none

Accessory: Enamel tray + wire rack

1. Place the slices of baguette on the wire rack on enamel tray and cook on **Grill 1** for 2-3 minutes or until lightly toasted.
2. Turn the slices over and spread each slice with cranberry sauce.
3. Top with a slice of brie and sprinkle with sesame seeds.
4. Cook on wire rack on enamel tray on **Combination: Grill 1 + Simmer** microwave for 3-4 minutes or until cheese has started to melt and sesame seeds turn golden.

Croque Monsieur

ingredients

Serves 2

4 slices bread, buttered
5 ml (1 tsp) dijon mustard
2 slices smoked ham
100 g (4 oz) sliced cheese

Dish: none

Accessory: Enamel tray + wire rack

1. Place the bread, buttered side up on wire rack on enamel tray and cook on **Grill 1** for approx. 3-4 minutes or until browning.
2. On 2 slices of the bread, spread the untoasted sides with mustard and top with ham and cheese. Cover with the other slices, browned side up.
3. Place back on the wire rack on enamel tray and cook on **Combination: Grill 1 + Simmer** microwave for 1-2 minutes or until the cheese has melted.

Macaroni Cheese

ingredients

Serves 4

175 g (6 oz) quick cooking macaroni
175 g (6 oz) butter
1 small onion, finely chopped
100 g (4 oz) bacon, chopped
40 g (1 ½ oz) flour
600 ml (1 pt) milk
salt and pepper
5 ml (1 tsp) french mustard
150 g (5 oz) red cheese, grated
30 ml (2 tbsp) fresh brown breadcrumbs

Dish: 1 x large Pyrex®
casserole dish

1 x large Pyrex® jug
1 x large shallow Pyrex® dish

Accessory: Enamel tray

1. Cook macaroni in large casserole dish in 450 ml (¾ pt) boiling water. Cover and cook on **High** microwave for 5-6 minutes or until soft. Drain.
2. Place butter, onion and bacon in a jug. Cover. Cook on **High** microwave for 5 minutes or until onion is soft. Stir halfway through cooking.
3. Stir in flour and cook for 30 seconds on **High** microwave.
4. Gradually add milk, stir well and season. Cook on **High** microwave for 5-6 minutes or until sauce is thick and bubbling. Stir twice during cooking.
5. Add mustard and 100 g (4 oz) grated cheese. Place the macaroni in a large shallow dish. Add sauce and mix well. Sprinkle with breadcrumbs and remaining cheese.
6. Place on enamel tray and cook on **Combination: Convection 220 °C + Low** microwave for 10-12 minutes or until cheese starts to melt.

Vegetables and Vegetarian



- Root vegetables. i.e. carrots, swede, should be cut into slices, strips or cubes.
- Do not mix fresh and frozen vegetables as the cooking times may be different.



- Cabbage should be shredded and cooked by High microwave. Approx. 500 g for 12-14 minutes with 75 ml (5 tbsp) water.
- Fresh vegetables require 15 ml (1 tbsp) of water per 100 g vegetables. Cover with pierced cling film or lid and stir halfway.



- If cooking potatoes with other vegetables, only cook with other **root** vegetables.
- Never add salt to vegetables before microwaving. Remember the flavour of microwaved vegetables is much better than boiled.



- Always cook vegetables in a dish that is a suitable size. Use flat dishes not basins. Always cover with microwave cling film or a lid.

Vegetables and Vegetarian



- Certain vegetables i.e. broccoli and asparagus, should be arranged so that the tips are in the centre of the dish as these require less cooking.



- Whole cauliflower should be cooked upside down on **Medium** microwave for 10 minutes. approx. with 90 ml (6 tbsp) water.

Jacket Potatoes

Varieties of potatoes vary in their suitability for cooking by microwave. We recommend Maris Piper for consistently good results. The cooking times given may need adjustment for other varieties. The ideal size of potato to be cooked by microwave is 200 g - 250 g (7-9 oz).

Before Cooking

Wash potatoes and prick skins several times. Spread around edge of turntable.

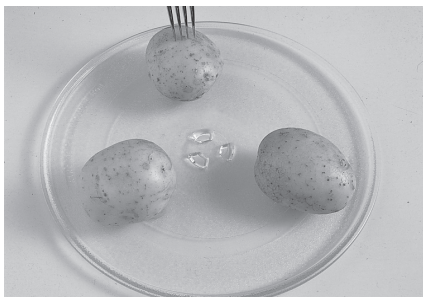

After Cooking

Remove from oven and wrap in aluminium foil to retain the heat. Leave to stand for 5 minutes.

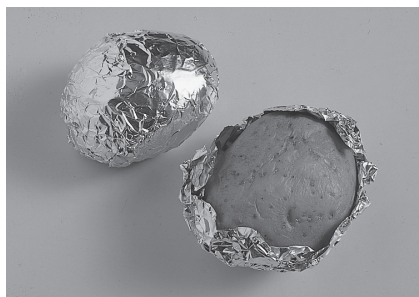

Vegetable Chilli

ingredients

Serves 4

15 ml (1 tbsp) olive oil
 1 onion, finely chopped
 1 green pepper, deseeded, chopped
 1 chilli, chopped
 2 carrots, diced
 5 ml (1 tsp) chilli powder
 3 ml (½ tsp) cumin
 175 g (6 oz) bulgar wheat
 400 g (14 oz) canned chopped tomatoes
 30 ml (2 tbsp) tomato purée
 400 g (14 oz) canned red kidney beans, drained
 450 ml (¾ pt) water

Dish: 1 x large Pyrex® casserole dish with lid

Accessory: none

1. Place oil, onion, pepper, chilli and carrots in a large casserole, cover and cook on **High** microwave for 4-5 minutes or until softened.
2. Add chilli powder and cumin. Stir in bulgar wheat, chopped tomatoes, tomato purée, red kidney beans and water. Cover and cook on **High** microwave for 10-15 minutes.

Leek and Potato Gratin

ingredients

Serves 4

450 g (1 lb) leeks deseeded, thinly sliced
 450 g (1 lb) potatoes, thinly sliced
 150 g (5 oz) blue cheese
 225 g (8 oz) Greek yoghurt
 75 ml (5 tbsp) double cream
 50 g (2 oz) brown breadcrumbs
 salt and pepper

Dish: 1 x large Pyrex® bowl

1 x small mixing bowl

1 x 25 cm (10 inch) Pyrex® flan dish

Accessory: Enamel tray

1. Place the vegetables in large bowl. Add 90 ml (6 tbsp) of water, cover and cook on **High** microwave for 10-12 minutes or until the vegetables are softened.
2. Crumble or finely chop the cheese into a bowl and gradually blend in the yoghurt and the double cream.
3. Drain the vegetables and arrange in a flan dish. Season and pour over the blue cheese cream mixture. Sprinkle with breadcrumbs, place on enamel tray and cook on **Combination: Convection** 220 °C + **Low** microwave for 10-12 minutes or until golden brown.

Roast Vegetable Parcels

ingredients

Serves 4

450 g (1 lb) mixed vegetable e.g. sweet potato, red pepper, leeks, aubergine, courgettes, onion, chopped
 1 clove of garlic, crushed
 30 ml (2 tbsp) olive oil
 200 g (7 oz) canned chopped tomatoes
 10 ml (2 tsp) tomato purée
 25 g (1 oz) pine nuts
 50 g (2 oz) Gruyère cheese, grated
 100 g (4 oz) Boursin® cheese
 15 ml (1 tbsp) single cream
 225 g (8 oz) ready made puff pastry
 1 egg for glazing

Dish: 1 x large mixing bowl

1 x large Pyrex® bowl

1 x small mixing bowl

Accessory: Enamel tray

1. Preheat oven **Convection** 220 °C with enamel tray. Chop vegetables into 2 ½ cm (1 inch) chunks.
2. Add garlic and oil, mix thoroughly with mixed vegetables. Place onto enamel tray.
3. Cook on **Convection** 220 °C for 20-25 minutes until vegetables are browned and al dente.
4. Place the chopped tomatoes and purée in a heatproof bowl uncovered and cook on **High** microwave for 5 minutes then **Medium** microwave for 5 minutes or until mixture is reduced in volume and thickened.
5. Mix the tomato sauce with the cooked vegetables and pine nuts.
6. Mix together the Gruyère cheese, Boursin® and single cream.
7. Roll out pastry until it measures approx 40 cm (16 inch) square. Divide into 4 equal squares.
8. Place ¼ of the vegetable mixture in the centre of the square and top with ¼ of the cheese mixture.
9. Bring the corners of the pastry to the centre, pressing the edges together. Seal with water. Glaze with beaten egg.
10. Cook in a preheated oven on **Convection** 220 °C for 15-20 minutes or until golden and cooked through.

Vegetable Lasagne

ingredients

Serves 4-6

1 large onion, chopped
25 g (1 oz) butter
1 clove of garlic, crushed
225 g (8 oz) carrots, diced
225 g (8 oz) leeks, chopped
225 g (8 oz) courgettes, diced
1 green pepper, chopped
150 ml (¼ pt) hot vegetable stock
salt and pepper
300 ml (½ pint) prepared tomato sauce
175 g (6 oz) fresh lasagne sheets
225 g (8 oz) Mozzarella cheese

Dish: 1 x large Pyrex® casserole dish with lid

1 x Pyrex® rectangular dish

Accessory: Enamel tray

1. Place onion and butter in a casserole dish, cover and cook on **High** microwave for 3 minutes. Add vegetables and stock, cover and cook on **High** microwave for 8-10 minutes or until vegetables are soft, drain. Season to taste.
2. Cover base of rectangular dish with a thin layer of tomato sauce, then a layer of lasagne on top followed by a layer of vegetable mixture. Thinly slice 175 g (6 oz) of the cheese and layer on top of vegetables. Continue layering until ingredients are all used ending with a tomato sauce layer.
3. Grate remaining cheese and arrange over top. Cook on enamel tray on **Combination: Convection** 190 °C + **Simmer** microwave for 20-25 minutes or until the pasta is cooked.

Goat's Cheese Tart with Roasted Vegetables

ingredients

Serves 4

100 g (4 oz) butter
225 g (8 oz) plain flour
50 g (2 oz) Parmesan cheese, grated finely
1 red pepper, diced into 4 cm (1 ½ inch) pieces
1 yellow pepper, diced into 4 cm (1 ½ inch) pieces
2 medium courgettes, sliced
100 g (4 oz) aubergine, diced into 4 cm (1 ½ inch) pieces
15 ml (1 tbsp) olive oil
100 g (4 oz) soft goat's cheese
3 eggs, beaten
75 ml (5 tbsp) crème fraîche or double cream
15 ml (1 tbsp) fresh parsley, chopped
salt and pepper

Dish: 1 x large mixing bowl

1 x 23 cm (9 inch) flan dish

1 x Jug

Accessory: Enamel tray

1. Preheat the oven on **Convection** 200 °C.
2. Rub the butter into the flour until the mixture resembles fine breadcrumbs. Stir in the parmesan, add 2-3 tbsps (30-45 ml) cold water and mix to a firm dough.
3. Roll out and line the flan dish. Prick the base with a fork and allow to rest for 15 minutes.
4. Cover the pastry with greaseproof, add baking beans and cook on enamel tray on **Convection** 200 °C for 10 minutes. Remove the paper and beans and cook for a further 5 minutes or until cooked. Allow to cool.
5. Place the prepared vegetables on enamel tray and drizzle with olive oil. Cook on **Combination: Grill 1 + Simmer** microwave for 10-12 minutes or until lightly browned. Turn halfway during cooking.
6. Place the vegetables in the flan case and dot teaspoons of the goat's cheese around the vegetables.
7. Beat together the eggs and creme fraiche until smooth, add the parsley and seasoning. Pour carefully over the filling.
8. Place on enamel tray and cook on **Combination: Convection** 190 °C + **Warm** microwave for 20-23 minutes or until set and lightly browned.

Roast Potatoes

ingredients

Serves 4

450 g (1 lb) potatoes,
25 g (1 oz) butter
30 ml (2 tbsp) oil

Dish: none

Accessory: Enamel tray

1. Peel and cut potatoes into quarters. Par boil and drain (see page 80).
2. Place potatoes, oil and butter on enamel tray.
3. Cook on **Combination: Convection** 220 °C + **Warm** microwave for 25 minutes turning and basting potatoes during cooking, or until crisp and brown.

Stuffed Peppers

ingredients

Serves 6

3 red peppers
3 yellow peppers
1 bunch spring onions, thinly sliced
30 ml (2 tbsp) olive oil
50 g (2 oz) pine nuts
2 cloves of garlic, crushed
100 g (4 oz) long grain rice
300 ml (½ pint) hot vegetable stock
100 g (4 oz) cherry tomatoes, halved
100 g (4 oz) mozzarella, diced
100 g (4 oz) gorgonzola or any blue cheese, diced
1 handful parsley, finely shredded
1 handful basil, finely shredded

Dish: 1 x large Pyrex® casserole dish
1 x large Pyrex® rectangular dish
Accessory: Enamel tray

1. Slice the tops off the peppers and put to one side. Remove the seeds and rinse out.
2. Place the spring onions, oil, garlic and pine nuts into in a casserole dish and stir together. Cook on **High** microwave for 2 minutes.
3. Add rice and hot stock. Cover and cook on **High** microwave for 10 minutes.
4. Allow to cool slightly and then stir in the cherry tomatoes, mozzarella, gorgonzola, parsley and basil. Season well.
5. Spoon the stuffing into the peppers and arrange them closely together in the rectangular dish.
6. Place on enamel tray and cook on **Combination: Convection** 220 °C + **Simmer** microwave for 10 minutes.
7. Place tops back on peppers and cook on **Combination: Grill 1 + Simmer** microwave for a further 8-10 minutes.

Cauliflower Cheese

ingredients

Serves 4

1 cauliflower
90 ml (6 tbsp) water
25 g (1 oz) butter
25 g (1 oz) flour
3 ml (½ tsp) french mustard
300 ml (½ pt) milk
salt and pepper
Topping:
75 g (3 oz) red cheese, grated
15 ml (1 tbsp) brown breadcrumbs

Dish: 1 x large Pyrex® casserole dish with lid
1 x Pyrex® jug
1 x medium Pyrex® gratin dish
Accessory: Enamel tray

1. Place cauliflower florets in a bowl. Add water. Cover and cook on **Medium** microwave for 10 minutes or until tender. Drain.
2. Melt butter on **High** microwave for 30-50 seconds in a Pyrex® jug. Stir in flour and mustard. Cook for a further 30 seconds. Add milk gradually. Stir well and season.
3. Cook on **High** microwave for 2-3 minutes or until sauce is thick and bubbling. Stir once halfway during cooking. Stir in 60 g (4 tbsp) grated cheese.
4. Place cauliflower in gratin dish and pour over sauce. Top with remaining cheese and breadcrumbs.
5. Place on enamel tray and cook on **Combination: Convection** 220 °C + **Warm** microwave for 15-17 minutes or until golden brown.

Spicy Potatoes

ingredients

Serves 4

350 g (12 oz) potatoes
45 ml (3 tbsp) natural yoghurt
10 ml (2 tsp) mango chutney
3 ml (½ tsp) cumin
3 ml (½ tsp) coriander
3 ml (½ tsp) turmeric
3 ml (½ tsp) garam marsala
10 ml (2 tsp) fresh coriander
pinch chilli powder
15 g (½ oz) sultanas
salt and pepper

Dish: 1 x 1.5 litre (2 pt) Pyrex® casserole dish with lid
1 x Pyrex® mixing bowl
Accessory: none

1. Cut the potatoes into large cubes and place in a large bowl with 6 tbsp (90 ml) water. Cover and cook on **High** microwave for 6-8 minutes or until soft. Drain and set aside.
2. Mix the remaining ingredients together. Add the potatoes and mix well. Serve either hot or cold.

Sauces

Container Size

Always use a container or jug at least twice the capacity of the sauce, to avoid boiling over.

Covering

Do not cover sauces when cooking.



Caution!

Sauces/gravy should be thoroughly stirred before, during and after cooking, to avoid any eruptions and to result in a smooth sauce.

Reheating

Sauces can be made in advance and reheated by microwave. Reheat on **High** microwave and stir halfway.

Wooden Spoons

Do not leave wooden spoons in the sauce when cooking. The wood may dry out and burn. **Never leave** metal spoons in the sauce.

White Sauce

ingredients

30 g (1 oz) butter, room temperature
30 g (1 oz) flour
600 ml (1 pt) whole milk
Variations:
parsley, onion, cheese
15 ml lemon juice

Dish: 1 x 1 litre (1 ¾ pt) Pyrex® jug

Accessory: none

1. Melt butter in jug on **High** microwave for 20-40 seconds.
2. Stir in the flour to make a roux.
3. Add the milk gradually stirring continuously until well combined.
4. Cook for 2 minutes on **High** microwave. Stir and cook for a further 3 minutes. Sauce should be smooth and glossy and coat the back of a spoon.

Variations of White Sauce:

Parsley

Stir 60 ml (4 tbsp) chopped parsley and 15 ml (1 tbsp) lemon juice into sauce halfway through cooking time.

Onion

Cook 1 small onion in the butter for 30 seconds on **High** microwave before adding the flour and milk.

Cheese

Stir in 75 g (3 oz) grated cheese at the end of cooking time.

Custard

ingredients

30 ml (2 tbsp) custard powder
15 ml (1 tbsp) sugar
600 ml (1 pt) whole milk

Dish: 1 x 1 litre (1 ¾ pt) Pyrex® jug

Accessory: none

1. Mix together the custard powder, sugar and a little milk to form a smooth paste.
2. Blend in the remaining milk, whisking well.
3. Cook on **High** microwave for 4-6 minutes. Whisk well halfway through cooking time and again at the end.

Hollandaise Sauce

ingredients

3 egg yolks
30 ml (2 tbsp) white wine vinegar
100 g (4 oz) unsalted butter,
chilled and cubed
pepper

Dish: 1 x 1 litre (1 ¼ pt) Pyrex® jug

Accessory: none

1. Place egg yolks and vinegar in a jug. Beat well.
2. Drop cubes of butter on top. Cook on **High** microwave for 20 seconds.
3. Whisk. Cook on **High** microwave for 10 seconds.
4. Whisk again and cook on **High** microwave for 10 seconds. Repeat in 10 second stages until sauce is thick and creamy.
5. Season and serve immediately with salmon steaks or asparagus spears.

N.B. This sauce must not boil or eggs will curdle.

Chocolate Sauce

ingredients

25 g (1 oz) butter
75 g (3 oz) caster sugar
75 g (3 oz) soft brown sugar
50 g (2 oz) cocoa powder
3 ml (½ tsp) vanilla essence
300 ml (½ pt) milk

Dish: 1 x 1 litre (1 ¼ pt) Pyrex® jug

Accessory: none

1. Melt butter in a Pyrex® jug on **High** microwave for 30-50 seconds.
2. Stir in sugars, cocoa powder and vanilla essence.
3. Gradually add milk, stirring well.
4. Cook on **High** microwave for 2 minutes. Stir well. Repeat this again three more times or until you achieve a smooth and glossy consistency that coats the back of a spoon.

Pepper Sauce

ingredients

1 onion, chopped
40 g (1 ½ oz) butter
30 g (1 oz) flour
2 stock cubes
15 ml (1 tbsp) tarragon vinegar
10 ml (2 tsp) white pepper
15 ml (1 tbsp) cognac
200 ml (½ pt) crème fraîche

Dish: 1 x large Pyrex® bowl

Accessory: none

1. Cook the onion in the bowl with butter for 2-3 minutes on **High** microwave.
2. Add flours, mix, cook again for 1 minute on **High** microwave and add 400 ml (2/3 pt) of hot water, 2 stock cubes, vinegar and white pepper. Cook uncovered at **High** microwave for 3 minutes.
3. Remove from the oven and add cognac and crème fraîche. Mix well.

Roquefort Sauce

ingredients

50 g (2 oz) Roquefort cheese
200 ml (½ pt) single cream
30 ml (2 tbsp) cornflour
salt and pepper

Dish: 1 x 500 ml Pyrex® bowl

Accessory: none

1. Cut the Roquefort into pieces, place in a bowl and melt using **Medium** microwave for 1 minute 30 seconds.
2. Add the cream and cornflour mixed with 15 ml (1 tbsp) water. Cook on **High** microwave for 3-3 minutes 30 seconds, whisk halfway through the cooking time. Check the seasoning before serving.

Suetcrust Pastry

ingredients

225 g (8 oz) self-raising flour
3 ml (½ tsp) salt
100 g (4 oz) shredded suet
105 ml (7 tbsp) cold water

Dish: 1 x large Pyrex® mixing bowl

Accessory: none

1. In Pyrex® mixing bowl, mix together flour, salt and suet.
2. Add water and mix to a soft dough. Knead lightly until smooth.

Baked Jam Roly Poly Pudding

ingredients

Serves 4

1 quantity of suet pastry (as above)
75 ml (5 tbsp) seedless
raspberry jam
milk to glaze

Dish: 1 x 1 kg (2 lb) Pyrex® loaf
dish

Accessory: Enamel tray

1. Roll out pastry to approx. 23 x 32 cm (9 x 13 inch).
2. Spread the jam over the pastry leaving 1 cm (½ inch) border all round. Brush the edges with milk and roll the pastry up evenly, starting at one short side and sealing the edges.
3. Brush top with milk and place in loaf dish. Preheat oven with enamel tray on **Convection** 210 °C. Cook on **Combination: Convection** 220 °C + **Simmer** microwave for 15-18 minutes or until golden.

Apple Strudel

ingredients

Serves 4

600 g (1 lb 5 oz) granny smiths
apples, peeled, cored and sliced
½ lemon, juiced
50 g (2 oz) golden caster sugar
50 g (2 oz) walnuts, roughly chopped
50 g (2 oz) sultanas
5 ml (1 tsp) ground cinnamon
50 g (2 oz) ground almonds
6 sheets filo pastry
50 g (2 oz) butter, melted
icing sugar to serve

Dish: 1 x Pyrex® mixing bowl
baking sheet

Accessory: Enamel tray

1. Preheat the oven on **Convection** 180 °C with enamel tray.
2. Put the apples and lemon juice into a bowl and toss together.
3. Add the sugar, walnuts, sultanas, cinnamon and almonds and mix together.
4. Take three sheets of filo pastry and brush with melted butter. Place each one with the shortest edge towards you. Overlap the 2nd sheet onto the 1st sheet by 5-6 cm (2-2 ½ inch) along the long edge and repeat with the 3rd sheet overlapping the second.
5. Place three more sheets of filo on top, in the same way as in step 4.
6. Spread the apple filling along the front edge of the filo pastry just 2.5 cm (1 inch) from the edge and 2.5 cm (1 inch) from each side.
7. Fold the sides in over the filling and brush with butter. Roll up from the long front edge buttering the final long edge to seal the strudel.
8. Place on baking sheet, seam-side down. Brush with melted butter.
9. Cook on **Convection** 180 °C for 30-35 minutes. Dust with icing sugar to serve.

Baking Guidelines

Covering

For traditional cakes, with long cooking times, baked on convection mode only, it is necessary to cover the top of the tin with foil 10-15 mins. after the start of baking. This is not applicable to any of the recipes in this section.

Dish Size/Shape

Always use the exact dish size stated in the following recipes, otherwise cooking times and results will be affected.

Mixing/Beating

Cakes cooked by microwave need to be well mixed, but not over beaten. Generally it is unnecessary to cream butter and sugar

or beat eggs in an electric mixer or food processor. Do not attempt to cook whisked/fatless sponges, or any cakes containing whisked egg white.

Eggs

The following recipes have been tested using medium eggs. Using a different size of egg may affect cooking times.

Combination Cooking

Do not use spring form tins, use smooth, and preferably seamless metal cake tins.

Carrot Cake

ingredients

2 eggs, beaten
150 ml (¼ pt) vegetable oil
150 g (5 oz) self raising wholemeal flour
100 g (4 oz) soft light brown sugar
10 ml (2 tsp) cinnamon
75 g (3 oz) raisins
100 g (4 oz) carrots, grated

Icing:

50 g (2 oz) cream cheese
50 g (2 oz) butter
100 g (4 oz) icing sugar
10 ml (2 tsp) lemon, juiced
50 g (2 oz) walnuts, chopped

Dish: 1 x large mixing bowl
1 x 18 cm (7 inch) soufflé dish lined with greaseproof paper
1 x medium mixing bowl
Accessory: Enamel tray

1. Mix eggs and oil together.
2. Combine flour, sugar, cinnamon, raisins and carrots in a mixing bowl and pour egg mix into flour and stir well.
3. Pour into dish and cook on the enamel tray on **Combination: Grill 3 + Low** microwave for 8 minutes.
4. *For the icing:* beat cream cheese and butter together and gradually add icing sugar and lemon juice. Decorate the cake with icing and sprinkle with walnuts.

Ginger Cake

ingredients

100 g (4 oz) butter
100 g (4 oz) golden syrup
100 g (4 oz) black treacle
75 g (3 oz) soft brown sugar
100 g (4 oz) self raising flour
100 g (4 oz) plain flour
5 ml (1 tsp) mixed spice
10 ml (2 tsp) ground ginger
5 ml (1 tsp) bicarbonate of soda
pinch salt
150 ml (¼ pt) milk
2 eggs, beaten

Dish: 1 x small Pyrex® bowl
1 x large mixing bowl
1 x 20 cm (8 inch) square Pyrex® dish
Accessory: none

1. Place butter, syrup, treacle and sugar in a bowl and heat on **High** microwave for 1-2 minutes or until fat has melted
2. Place flour, spices, bicarbonate of soda and salt in a large bowl. Stir in treacle mixture and mix well. Stir in milk and eggs and beat until smooth.
3. Pour into square dish and cook on **Medium** microwave for 8-9 minutes or until set around the edges. The cake will appear slightly wet in the centre, but will continue cooking as it cools.

Chocolate and Almond Cake

ingredients

100 g (4 oz) butter
 100 g (4 oz) caster sugar
 2 eggs, lightly beaten
 100 g (4 oz) self raising flour
 50 g (2 oz) cocoa powder
 50 g (2 oz) ground almonds
 100 ml (3 ½ fl. oz) whole milk
 60 ml (4 tbsp) golden syrup

Topping:

50 g (2 oz) butter
 25 g (1 oz) cocoa powder, sifted
 200 g (7 oz) icing sugar
 5 ml (1 tsp) milk

Dish: 1 x 20 cm (8 inch) Pyrex® soufflé dish, greased and lined
 2 x large Pyrex® mixing bowls

Accessory: none

1. Cream together butter and sugar. Gradually add egg. Add flour, cocoa powder, ground almond, milk then syrup.
2. Pour into a Pyrex® dish. Cook on **Medium** microwave for 8 minutes.
3. Cream butter until soft and gradually add cocoa powder and icing sugar. Lastly adding milk as required.

Fruit Cake

ingredients

175 g (6 oz) butter
 175 g (6 oz) dark brown sugar
 1 lemon, grated
 3 eggs, beaten
 225 g (8 oz) plain flour
 10 ml (2 tsp) ground spice
 225 g (8 oz) raisins
 225 g (8 oz) sultanas
 50 g (2 oz) glace cherries
 50 g (2 oz) chopped mixed nuts
 15 ml (1 tbsp) treacle
 45 ml (3 tbsp) brandy

Dish: 1 x Pyrex® mixing bowl
 1 x 20 cm (8 inch) soufflé dish
 greased and lined

Accessory: none

1. Cream butter and sugar until light and fluffy. Mix in the lemon rind. Beat in the eggs
2. Fold in the flour, spice and the rest of the ingredients. Spoon mixture into soufflé dish
3. Cook on **Low** microwave for 20 minutes.

Pineapple, Cinnamon and Raisin Muffins

ingredients

Makes 12

100 g (4 oz) self raising flour
 100 g (4 oz) wholemeal self-raising flour
 3.75 ml (¾ tsp) bicarbonate of soda
 pinch salt
 5 ml (1 tsp) ground cinnamon
 150 ml (¼ pt) sunflower oil
 2 eggs
 75 g (3 oz) golden caster sugar
 125 g (4 ½ oz) carrots, grated
 225 g (8 oz) canned pineapple chunks, crushed
 100 g (4 oz) raisins

Dish: 2 x medium Pyrex® bowls
 2 x 6 hole muffin tin
 12 muffin cases

Accessory: Enamel tray

1. Preheat the oven on **Convection** 180 °C with enamel tray.
2. Sieve the flours, bicarbonate of soda, salt and cinnamon into a bowl.
3. In a separate bowl, beat together the oil, eggs and sugar. Add the grated carrot, crushed pineapple and raisins.
4. Pour the oil mixture into the flour mixture and stir together until just blended.
5. Put the mixture into the individual muffin tins lined with muffin cases, cook on enamel tray in two separate batches on **Convection** 180 °C for 20-25 minutes per batch.

Chocolate Saucy Pudding with Toffee Sauce

ingredients

75 g (3 oz) plain chocolate
 30 ml (2 tbsp) milk
 175 g (6 oz) margarine
 175 g (6 oz) light muscovado sugar
 2 eggs
 150 g (5 oz) fresh white breadcrumbs
 30 ml (2 tbsp) cocoa powder
Sauce:
 225 g (8 oz) vanilla flavoured toffees
 150 ml (¼ pt) milk
 15 g (½ oz) butter

Dish: 1 x 1.2 litre (2 pt) pudding basin
 1 x small Pyrex® bowl
 1 x large mixing bowl
 1 large Pyrex® jug
Accessory: none

1. Line the base of a 1.2 litre (2 pt) pudding basin with a circle of greaseproof paper.
2. Melt the chocolate with the milk in a small Pyrex® bowl on **Medium** microwave for 2-3 minutes and mix until smooth.
3. Mix the margarine and sugar together, add the cooled chocolate and eggs.
4. Add the breadcrumbs and cocoa powder and mix well. Fill the basin with the mixture and cook on **High** microwave for 6-7 minutes or until cooked. Leave to stand for 5 minutes before turning out.
5. Meanwhile, prepare the sauce by combining all ingredients in a large jug and cook on **High** microwave for 2-3 minutes or until smooth. Stir vigorously and pour over the pudding.

Plum and Oat Layer

ingredients

Makes 8 slices
 100 g (4 oz) butter or margarine
 50 g (2 oz) light brown sugar
 30 ml (2 tbsp) golden syrup
 225 g (8 oz) rolled oats
 450 g (1 lb) plums, stoned and thinly sliced
 5 ml (1 tsp) ground cinnamon

Dish: 1 x large Pyrex® bowl
 1 x 20 cm (8 inch) ceramic flan dish
Accessory: Enamel tray

1. Place the butter, sugar and syrup in a bowl. Cook on **High** microwave for 1-2 minutes or until melted. Stir in the rolled oats.
2. Spread half the oat mixture into the dish. Arrange the plums over the top in overlapping rows and sprinkle with cinnamon.
3. Sprinkle the remaining oat mixture over the plums and gently press down.
4. Cook on enamel tray on **Combination: Convection 220 °C + Low** microwave for 8-10 minutes or until the mixture is firm and golden brown.
5. Cut into slices while hot, then allow to cool in the dish.

Steamed Suet Sponge Pudding

ingredients

Serves 4
 150 g (5 oz) self-raising flour
 pinch salt
 50 g (2 oz) caster sugar
 50 g (2 oz) suet
 1 egg
 150 ml (¼ pt) milk
 30 ml (2 tbsp) jam or golden syrup
Optional:
 10 ml (2 tsp) sultanas, optional

Dish: 1 x Pyrex® mixing bowl
 1 x 1 litre (1 ¾ pt) Pyrex® pudding basin
Accessory: none

1. In a mixing bowl, sift together the flour and salt. Stir in sugar and suet. Add the sultanas if desired.
2. Make a well in the centre and add beaten egg and milk. Mix to a soft dropping consistency.
3. Put the jam in the base of the greased pudding basin and pour pudding mixture over. Cook on **High** microwave for 5-5 minutes and 30 seconds or until firm.

Bread and Butter Pudding

ingredients

Serves 4

6 slices bread, buttered and cut in half diagonally
75 g (3 oz) mixed dried fruit
450 ml (¾ pt) milk
3 eggs
25 g (1 oz) caster sugar
3 ml (½ tsp) nutmeg

Dish: 1 x Pyrex® dish 20 x 25 cm (8 x 10 inch) greased
1 x large Pyrex® bowl
1 x mixing bowl

Accessory: Enamel tray

1. Arrange the bread and fruit in the prepared dish.
2. Warm the milk for 3 minutes on **Medium** microwave but do not allow to boil.
3. Beat together the eggs and sugar, add the milk, stirring well.
4. Pour the mixture over the bread, sprinkle with nutmeg and leave to stand for 15 minutes. Cook on enamel tray on **Combination: Convection** 190 °C + **Simmer** microwave for 20-25 minutes or until set and browned.

Christmas Pudding

ingredients

Serves 6-8

1 cooking apple, peeled and grated
1 carrot, peeled and grated
1 orange, juice and grated rind
400 g (14 oz) mixed dried fruit
45 ml (3 tbsp) brandy
15 ml (1 tbsp) black treacle
50 g (2 oz) self-raising flour
pinch salt
15 ml (1 tbsp) cocoa
5 ml (1 tsp) mixed spice
3 ml (½ tsp) nutmeg
100 g (4 oz) shredded suet
150 g (5 oz) fresh breadcrumbs
50 g (2 oz) mixed peel
50 g (2 oz) flaked almonds
2 eggs, beaten

Dish: 1 x large Pyrex® bowl
1 x 1.3 litre (2 ½ pt) Pyrex®
pudding basin lightly greased

Accessory: none

1. Place apple and carrot in a large bowl. Cover and cook on **High** microwave for 5 minutes. Beat well to make a thick purée.
2. Stir in juice, rind and mixed fruit. Cook on **High** microwave for 2 minutes. Stir in brandy and treacle. Stand for 5 minutes. Beat in rest of ingredients.
3. Press into a lightly greased pudding basin. Cover with greaseproof paper and cook on **High** microwave for 4 minutes. Stand for 5 minutes. Cook on **High** microwave for another 2 minutes or until just firm.

N.B. One of the advantages of using your microwave to make this traditional pudding is that it can be made the week before Christmas and stored in a cool dry place. Do not attempt to make the pudding earlier than this, since the flavour will not improve with keeping, unlike a traditionally steamed pudding.

Baked Apples

ingredients

Serves 4

4 medium sized apples
30 ml (2 tbsp) caster sugar
25-50 g (1-2 oz) mixed dried fruit
25 g (1 oz) butter

Dish: 1 x Pyrex® mixing bowl,
1 x 20 cm (8 inch) Pyrex®
shallow dish

Accessory: none

1. Core the apples and score the skin around the middle.
2. Mix together the sugar and fruit and fill the centres of the apples.
3. Dot the top with butter. Stand the apples in a shallow dish and cook on **High** microwave for 5 minutes 30 seconds - 7 minutes. Stand for 5 minutes before serving.

N.B. The apples will look quite green when removed from the oven, but they should feel slightly soft when tested with a sharp knife. During the standing time, the colour will become dull and the apples will be tender. The apples will overcook very easily, so take care to undercook slightly. For 1 baked apple cook for 2-3 minutes. For 2 baked apples cook for 3-5 minutes.

Chocolate Brownies

ingredients

Serves 9

125 g (4 ½ oz) butter
 200 g (7 oz) dark chocolate
 (72 % cocoa solids)
 175 g (6 oz) soft brown muscovado
 2 eggs, beaten
 sugar
 a few drops vanilla essence
 50 g (2 oz) plain flour
 5 ml (1 tsp) baking powder

Dish: 1 x small Pyrex® bowl
 1 x Pyrex® mixing bowl
 23 cm (9 inch) Pyrex® square dish
Accessory: Enamel tray

1. Melt the butter with 50 g (2 oz) of the chocolate in a small bowl on **Medium** microwave for 2 minutes.
2. Put the eggs, sugar and vanilla essence in a bowl, then sift in the flour and baking powder.
3. Stir in the melted chocolate and butter mixture and mix well.
4. Chop the remaining chocolate into rough chunks and stir into the brownie mixture.
5. Spoon into the dish, spread evenly and cook on enamel tray, **Combination: Convection** 220 °C + **Simmer** microwave for 9-12 minutes or until firm.

Fruit Scones

ingredients

Serves 10

225 g (8 oz) self-raising flour
 pinch salt
 5 ml (1 tsp) baking powder
 50 g (2 oz) butter
 25 g (1 oz) caster sugar
 50 g (2 oz) sultanas
 100 ml (2 ½ fl. oz) whole milk
 1 egg for glazing

Dish: 1 x Pyrex® mixing bowl
 1 x small baking sheet
Accessory: Enamel tray

1. Preheat oven on **Convection** 210 °C with enamel tray.
2. Sift the flour, salt and baking powder together. Rub in fat until the mixture resembles fine breadcrumbs. Add sugar and sultanas.
3. Make a well in the centre and stir in enough milk to form a soft dough.
4. Knead lightly. Pat out to 2 cm (¾ inch) thick and cut into 10 rounds with a 5 cm (2 inch) cutter. Place on baking sheet, brush with beaten egg and cook on **Convection** 210 °C for 10-15 minutes or until well risen and golden brown.

Red Fruit Compote

ingredients

Serves 4

225 g (8 oz) plums, halved
 225 g (8 oz) cherries, stoned
 225 g (8 oz) blueberries
 225 g (8 oz) strawberries, halved
 225 g (8 oz) raspberries, halved
 50 g (2 oz) golden caster sugar

Dish: 1 x large Pyrex® shallow dish
Accessory: none

1. Place the plums, cherries and blueberries in a shallow dish. Cook on **Low** microwave for 10 minutes.
2. Stir in the strawberries and cook on **Low** microwave for a further 5-6 minutes.
3. Stir the raspberries and sugar into the hot fruit and allow to cool before serving.

Streusel Topped Fruit Muffins

ingredients

Makes 12

Streusel topping:

50 g (2 oz) butter
75 g (3 oz) plain flour
30 ml (2 tbsp) granulated sugar
15 ml (1 tbsp) ground mixed spice

Muffins:

225 g (8 oz) plain flour
10 ml (2 tsp) baking powder
150 g (5 oz) caster sugar
2.5 ml (½ tsp) salt
½ lemon, grated zest
175 g (6 oz) fresh or frozen berries, raspberries or blueberries
75 g (3 oz) butter
110 ml (6 fl. oz) buttermilk
1 egg, lightly beaten
2.5 ml (½ tsp) vanilla essence

Dish: 1 x small Pyrex® bowl,
1 x large mixing bowl,
1 x large Pyrex® bowl,
2 x 6 hole muffin tin,
12 paper muffin cases

Accessory: Enamel tray

1. Preheat oven on **Convection** 180 °C with enamel tray.
2. Melt the butter on **Medium** microwave for 1 minute. Combine the streusel topping ingredients to make a soft dough and reserve. Chill.
3. Sift together the flour, baking powder, sugar and salt. Add the lemon rind and the fruit.
4. Melt the butter on **High** microwave for 30 second - 1 minute mix in the buttermilk, egg and vanilla essence. Lightly stir in the flour mixture and divide between 12 muffin cases.
5. Crumble small amounts of streusel topping over each muffin and cook in two batches on **Convection** 180 °C for 22 minutes, until browned and well risen.

Rice Pudding

ingredients

Serves 4

100 g (4 oz) short grain rice
1 litre (1 ¾ pt) whole milk
75 g (3 oz) caster sugar
small piece cinnamon stick
1 vanilla pod, split lengthways

Dish: 1 x large Pyrex® casserole dish with lid

Accessory: none

1. Place the rice, milk and sugar into the bowl. Add the cinnamon stick and vanilla pod. Do not cover.
2. Bring to the boil by heating on **High** microwave for 11-12 minutes on the base of the oven, paying close attention to ensure that the milk does not boil over.
3. Cook covered with a lid on **Simmer** microwave for 1 hour. Remove the cinnamon stick and vanilla pod. Leave to cool, serve hot or cold.

Apple Crumble

ingredients

Serves 4-6

700 g (1 lb 9 oz) cooking apples, peeled, cored and roughly chopped
2.5 ml (½ tsp) ground cinnamon
75 g (3 oz) ground almonds
75 g (3 oz) caster sugar
75 g (3 oz) butter
75 g (3 oz) plain flour
40 g (1 ½ oz) brown sugar

Dish: 1 x 24 cm (9 ½ inch) rectangular dish

1 x Pyrex® mixing bowl

Accessory: Enamel tray + wire rack

1. Place the apples in the dish with brown sugar and cinnamon and cook on **High** microwave for 6-9 minutes, uncovered, stirring halfway through the cooking time. Leave to cool.
2. In a bowl mix ground almonds, butter, flour and caster sugar, until you obtain a mixture that looks like breadcrumbs. Spread this mixture over the pre-cooked apples.
3. Place the dish on the wire rack on enamel tray and cook on **Combination: Convection** 180 °C + **Simmer** microwave for 5-7 minutes, or until golden.

Preserves

Sterilizing Jars

Jam jars can be sterilized by microwave ready for your jams. Half fill with water and heat them on **High** microwave until water boils (approx. 3 minutes. for 2 jars). Empty and drain upside down on kitchen paper. The jars should be warm when filled with jam.

If you wish to cook larger quantities than given in the recipes below, revert to the traditional hob method, using a traditional recipe.

Dish Size

Always use a very large Pyrex® bowl. **Do not** attempt to use jam pans or saucepans in your microwave.

Do not leave jams unattended during cooking because of the high sugar content.

Covering

Do not cover preserves whilst cooking, apart from if recommended in the recipe.

We do not recommend that you use your microwave to sterilise babies' bottles.

(See details on page 64)

Do not seal preserving jars in your microwave.

Setting Point

To determine whether setting point is reached, place a couple of drops of jam or marmalade on a cold saucer (put one in the fridge whilst making the jam). Leave to cool. The jam should wrinkle on the surface when your finger pushes across the top.

Soft Fruit Jam

ingredients

Makes approx. 675 g (1 ½ lbs)

450 g (1 lb) soft fruit, washed
450 g (1 lb) caster sugar
30 ml (2 tbsp) lemon, juiced
5 ml (1 tsp) butter

Dish: 1 x large Pyrex® bowl

Accessory: none

1. Place all ingredients in a large bowl and stir. Cook on **High** microwave for 5 minutes (10-15 minutes if using frozen fruit), stirring frequently. Continue to cook in one minute intervals until sugar has dissolved.
2. Wash down any sugar crystals from around the bowl.
3. Bring mixture to the boil and continue to cook until setting point is reached – approx. 10-20 minutes. Test regularly for setting point.

Lemon Curd

ingredients

Makes approx. 900 g (2 lb)

4 lemons, juice and grated rind
450 g (1 lb) caster sugar
4 eggs, beaten
100 g (4 oz) butter

Dish: 1 x large Pyrex® bowl

Accessory: none

1. Place all ingredients in bowl. Mix well.
2. Cook on **High** microwave for 1 minute. Stir. Continue to cook in 1 minute stages until mixture starts to thicken, then cook for 30 seconds at a time until mixture coats back of spoon. (The eggs will curdle if overcooked).
3. The mixture will thicken on cooling. Pot into warm jars. Cover with a circle of waxed paper and a jam pot cover.

Orange Marmalade

ingredients

**Makes approx. 675-900 g
(1 ½ - 2 lbs)**

450 g (1 lb) seville oranges
1 lemon
900 ml (1 ½ pt) water
450 g (1 lb) sugar
knob of butter

Dish: 2 x large Pyrex® bowl
Accessory: none

1. Grate oranges and lemon ensuring all the pith is left on the fruit. Set the rind aside.
2. Peel the fruit and put it in a food processor and chop until the pips are broken.
3. Place the chopped mixture in a large bowl and pour over boiling water. Cover with pierced cling film and cook on **High** microwave for 10 minutes.
4. Strain the mixture through a sieve into another large bowl pressing the pulp well until all the juice is extracted. Discard the pulp.
5. Stir the shredded rind into the hot juice and cook uncovered on **High** microwave for 10 minutes until rind is tender, stirring occasionally. Stir in the sugar until dissolved.
6. Cook on **High** microwave for 8 minutes covered with pierced cling film. Stir in the butter and cook uncovered until setting point is reached, approx. 18-20 minutes.
7. Leave to stand for 10 minutes then pour into warmed sterilized jars.

N.B Do not double this recipe as it will boil over.

Plum Jam

ingredients

Makes approx. 1.5 kg (3 lb 5 oz)

675 g (1 lb 8 oz) plums or damsons,
halved, stoned
200 ml (¼ pt) cold water
675 g (1 lb 8 oz) jam sugar
30 ml (2 tbsp) lemon juice
5 ml (1 tsp) butter

Dish: 1 x large Pyrex® mixing bowl
Accessory: none

1. Place plums in a large Pyrex® bowl with water.
2. Cook on **Medium** microwave for 10 minutes or until fruit is soft.
3. Add the remaining ingredients, stir and cook on **High** microwave for 5 minutes stirring frequently.
4. Wash down any sugar crystals from around the bowl.
5. Bring mixture to the boil on **High** microwave, approx. 4-5 minutes.
6. Continue to cook on **High** microwave until setting point is reached approx. 20-25 minutes. Test regularly for setting point.

Junior Menu

This section of recipes are aimed at toddlers and children or may be shared with the whole family. Ideal recipes when little ones are independently feeding themselves, introducing different flavours and textures of food.

Tomato Soup

ingredients

Serves 4

30 ml (2 tbsp) olive oil
 1 onion, chopped
 1 garlic clove, crushed
 200 g (7 oz) carrots, peeled and chopped
 400 g (14 oz) canned chopped tomatoes
 200 ml (1/5 pt) passata
 400 ml (2/5 pt) vegetable stock
 1 bay leaf
 1 sprig of fresh thyme
 100 ml (4 fl. oz) single cream, optional
 salt and pepper

Dish: 1 x large Pyrex® casserole dish with lid

Accessory: none

1. Place the oil, onion, garlic and carrots in a large casserole dish, cover and cook on **High** microwave for 5 minutes.
2. Stir in the tomatoes, passata, stock, bay leaf and thyme and cook covered on **High** microwave for 10 minutes then **Simmer** microwave for 30 minutes.
3. Remove the bay leaf and thyme, add the cream (if desired) and seasoning, blend in a food processor until smooth.

Frittatta

ingredients

25 g (1 oz) butter
 25 g (1 oz) ham, chopped
 25 g (1 oz) green pepper, finely chopped
 1 spring onion, sliced
 4 eggs, beaten
 50 g (2 oz) Cheddar cheese, grated

Dish: 1 x 24 cm (9 1/2 inch) flan dish

Accessory: none

1. Place the butter in the flan dish. Melt on **Medium** microwave for 1 minute.
2. Add the ham, green pepper and spring onions. Cook on **High** microwave 1-2 minutes.
3. Pour the beaten egg over the top, sprinkle with the cheese.
4. Cook on **High** microwave for 2 minutes. Leave to stand for 2 minutes before serving

Quesadillas

ingredients

2 flour tortillas
 50 g (2 oz) Cheddar cheese, grated
 25 g (1 oz) cooked ham, chopped
 1 spring onion, sliced

Dish: 1 x dinner plate

Accessory: none

1. Place a tortilla on the plate, place the cheese, ham and onion onto the tortilla. Place the other tortilla on top.
2. Cover with a piece of kitchen roll cook on **High** microwave for 1-2 minutes.

Individual Fish Pies

ingredients

Serves 6

375 g (13 oz) white potatoes, peeled and chopped
 50 g (2 oz) butter
 25 ml (1½ tbsp) milk
 25 g (1 oz) onion, chopped into small chunks
 15 g (1 tbsp) flour
 75 g (3 fl. oz) milk
 50 g (2 fl. oz) fish stock
 125 g (4½ oz) white fish fillet, skinned and cut into bite sized pieces
 125 g (4½ oz) salmon fillet, skinned and cut into bite sized pieces
 5 g (1 tsp) fresh parsley, chopped
 25 g (1 oz) frozen peas
 50 g (2 oz) grated cheese, plus extra for topping

Dish: 2 x medium Pyrex® casserole dish with lid
 6 x 8 cm (3 inch) ramekin dishes

Accessory: Enamel tray

1. Place the potatoes into a casserole dish, add 3 tbsp (45 ml) water, cover and cook on **High** microwave for 7-9 minutes.
2. Drain the potatoes, add half the butter and milk and mash together, leave to one side.
3. Place the remaining butter in a casserole dish with the onion, cover and cook on **High** microwave for 3 minutes.
4. Mix the flour into the butter and onion. Cook on **High** microwave for 30 seconds. Gradually stir in the milk and then the stock. Cook on **High** microwave for 3 minutes.
5. Add the fish and parsley. Cook on **Medium** microwave for 3 minutes. Stir in the peas and grated cheese.
6. Divide the fish pie mixture between 6 x 8 cm (3 inch) ramekin dishes, top with mashed potato and sprinkle with cheese.
7. Cook the pies on enamel tray on **Combination: Grill 1 + Medium** microwave for 10-15 minutes or until the cheese is melted and bubbling.

Teryaki Salmon

ingredients

Serves 2-4

200 g (7 oz) salmon fillets, skinned and cut into bite sized pieces
 1 cm piece fresh ginger, grated
 15 ml (1 tbsp) clear honey
 20 ml (1½ tbsp) soy sauce
 15 ml (1 tbsp) sesame seeds

Dish: 1 x 23 (9 inch) shallow Pyrex® square dish

1 x small Pyrex® mixing bowl
 4 bamboo kebab skewers

Accessory: Enamel tray + wire rack

1. Thread the salmon onto the wooden skewers, place into a shallow dish.
2. Place all the remaining ingredients, except the sesame seeds into a bowl and pour over the salmon, turn the skewers to coat all sides in the sauce.
3. Place the dish onto the wire rack on the enamel tray and cook on **Grill 1** for 12 minutes. Turn the skewers during cooking.
4. Sprinkle the salmon with the sesame seeds once cooked.

Spaghetti Bolognese

ingredients

Serves 6

15 ml (1 tbsp) olive oil
 ½ onion, chopped
 1 small celery, finely diced
 1 small courgette, finely diced
 1 small carrot, finely diced
 1 small apple, grated finely
 1 clove of garlic, crushed
 225 g (8 oz) lean beef mince
 200 g (7 oz) passata
 15 g (1 tbsp) tomato purée
 175 g (6 fl. oz) beef or vegetable stock

Dish: 1 x large Pyrex® casserole dish with lid

Accessory: none

1. Place the oil, vegetables, apple and garlic into the casserole dish, cover and cook on **High** microwave for 5 minutes, add the mince, stir and cook on **High** microwave for another 5 minutes.
2. Add the passata, purée and stock to the dish. Mix well and cook on **High** microwave for 10 minutes then **Simmer** microwave for a further 10 minutes.
3. Purée if necessary to suit the age of the child.

Stuffed Sweet Potatoes

ingredients

Serves 2-4

4 rashers streaky bacon
4 sweet potatoes each
200-250 g (7 oz - 9 oz)
15 ml (1 tbsp) olive oil
60 ml (4 tbsp) Crème fraiche
3 spring onions, finely sliced
250 g (9 oz) Cheddar cheese, grated

Dish: 1 x microwavable plate
1 x mixing bowl

Accessory: Enamel tray + wire rack

1. Place the bacon on a microwavable plate, cover with kitchen roll and cook on **High** microwave for 2 minutes. Leave to one side.
2. Cook the sweet potatoes on the **auto program jacket potatoes** (see page 60). Leave them to cool.
3. Slice the sweet potatoes in half lengthways, scoop out the flesh and place into a bowl, add the crème fraiche, spring onions and half the cheese to the bowl, mix together well.
4. Spoon the filling back into the potato halves. Chop the bacon and place some on top, followed by the remaining cheese.
5. Place the potato halves onto the wire rack on the enamel tray and cook on **Grill 1** for 3-6 minutes or until golden brown.

Granola

ingredients

Serves 6-8

175 g (6 oz) oats
120 g (4 ½ oz) soft brown sugar
1.25 ml (¼ tsp) salt
50 g (2 oz) sunflower seeds
25 g (1 oz) desiccated coconut
30 g (2 tbsp) sunflower oil
60 g (4 tbsp) maple syrup
25 g (1 oz) dried cranberries
25 g (1 oz) raisins
25 g (1 oz) dried apricots, finely chopped

Dish: 1 x medium mixing bowl
Accessory: Enamel tray

1. Preheat the oven on **Convection** 150 °C with the enamel tray.
2. Mix together the oats, sugar, salt, sunflower seeds and coconut. Mix the oil and maple syrup together and stir thoroughly into the oat mixture.
3. Carefully grease the enamel tray and spread the oat mixture evenly across the tray.
4. Cook on **Convection** 150 °C for 40-45 minutes, stirring every 10 minutes.
5. Pour the cooked mixture into a bowl and stir in the cranberries, raisins and apricots.

Serving suggestion:

Ideal for breakfast with milk, on its own as a snack or layered with yoghurt, honey and fruit.

Individual Pear, Apple and Raspberry Crumbles

ingredients

Serves 8

Topping:

100 g (4 oz) butter,
chilled and cubed
150 g (5 oz) plain flour
75 g (3 oz) golden caster sugar
pinch salt
50 g (2 oz) oats

Fruit:

1 apple, peeled and finely chopped
1 pear, peeled and finely chopped
125 g (4 ½ oz) raspberries
30 ml (1 tbsp) caster sugar

Dish: 2 x medium mixing bowl,
8 x 8 cm (3 inch) ramekins

Accessory: Enamel tray

1. Make the crumble topping by rubbing the butter into the flour until it resembles fine breadcrumbs. Mix the golden caster sugar, salt and oats into the crumble topping.
2. Mix the apple, pear and raspberries with the caster sugar and divide equally between the ramekin dishes and top with the crumble mixture.
3. Place the ramekins onto the enamel tray and cook on **Combination: 180 °C + Simmer** microwave for 15-20 minutes.

Questions and Answers

Q: Why won't my oven turn on?

A: When the oven does not turn on, check the following:

1. Is the oven plugged in securely? Remove the plug from the outlet, wait 10 seconds and reinsert.
2. Check the circuit breaker and the fuse. Reset the circuit breaker or replace the fuse if it is tripped or blown.
3. If the circuit breaker or fuse is all right, plug another appliance into the outlet. If the other appliance works, there probably is a problem with the oven. If the other appliance does not work, there probably is a problem with the outlet.

If it seems that there is a problem with the oven, contact an authorised Service Center.

Q: My microwave oven causes interference with my TV. Is this normal?

A: Some radio, TV, Wi-Fi, cordless telephone, baby monitor, bluetooth or other wireless equipment interference might occur when you cook with the microwave oven. This interference is similar to the interference caused by small appliances such as mixers, vacuums, blow dryers, etc. It does not indicate a problem with your oven.

Q: The oven won't accept my program. Why?

A: The oven is designed not to accept an incorrect program. For example, the oven will not accept a fourth stage of cooking.

Q: Sometimes warm air comes from the oven vents. Why?

A: The heat given off from the food whilst cooking warms the air in the oven cavity. This warmed air is carried out of the oven by the air flow pattern in the oven. There are no microwaves in the air. The oven vents should never be blocked during cooking.

Q: Can I use a conventional oven thermometer in the oven?

A: Only when you are using **Grill and Convection** cooking mode. The metal in some thermometers may cause arcing in your oven and should not be used on **microwave** and **Combination** cooking functions.

Q: There are humming and clicking noises from my oven when I cook by **Combination**. What is causing these noises?

A: The noises occur as the oven automatically switches from **microwave** power to **Convection/Grill** to create the combination setting. This is normal.

Questions and Answers

- Q: My oven has an odour and generates smoke when using the **Convection, Combination** and **Grill** function. Why?
- A: After repeated use, it is recommended to clean the oven and then run the oven without food, glass turntable, and roller ring on grill for 5 minutes. This will burn off any food, residue or oil which may cause an odour and/or smoking.
- Q: The oven stops cooking by microwave and 'H97' or 'H98' appears in the display. Why?
- A: This display indicates a problem with the microwave generation system. Please contact an authorised Service Centre.
- Q: The fan continues to rotate after cooking. Why?
- A: After using the oven, the fan motor may rotate to cool the electrical components. This is normal and you can continue using the oven at this time.
- Q: "DEMO MODE PRESS ANY KEY" or "D" appears in the display and the oven does not cook. Why?
- A: The oven has been programmed in **demo mode**. This mode is designed for retail store display. Deactivate this mode by pressing Micro Power once and Stop/Cancel 4 times.
- Q: Can I check the pre-set oven temperature while cooking or preheating by **Convection**?
- A: Yes. Press **Convection** pad and the oven temperature will appear in the display window for 2 seconds.
- Q: The operation guide has disappeared on my display, I can only see numbers. Why?
- A: The operation guide was turned off by pressing Timer/Clock 4 times. When colon or time of day is displayed, press Timer/Clock 4 times to turn the operation guide back on.

Technical Specification

Manufacturer	Panasonic	
Model	NN-CT54JW, NN-CT55JW, NN-CT56JB, NN-CT57JM	
Power Supply	230-240 V 50 Hz	
Operating Frequency:	2450 MHz	
Input Power:	Maximum	2380 W
	Microwave	1090 W
	Grill	1370 W
	Convection	1390 W
Output Power:	Microwave	1000 W (IEC-60705)
	Grill	1300 W
	Convection	1300 W
External Dimensions W x D x H (mm)	520 (W) x 395 (D) x 310 (H)	
Interior Dimensions W x D x H (mm)	359 (W) x 352 (D) x 217 (H)	
Uncrated Weight (approx. without accessories)	13.8 kg	
Noise	50 dB	

Weight and Dimensions shown are approximate.

This product is an equipment that fulfills the European standard for EMC disturbances

(EMC = Electromagnetic Compatibility) EN 55011. According to this standard this product is an equipment of group 2, class B and is within required limits. Group 2 means that radio-frequency energy is intentionally generated in the form of electromagnetic radiation for purpose of warming or cooking food. Class B means that this product may be used in normal household areas.

Manufactured by: Panasonic Appliances Microwave Oven (Shanghai) Co., Ltd.

888, 898 Longdong Road. Pudong, Shanghai, 201203, China.

Imported by: Panasonic Marketing Europe GmbH

REP. EU: Panasonic Testing Centre
Winsbergring 15, 22525 Hamburg, Germany



Visit Panasonic's **The Ideas Kitchen** website for Microwave advice, recipes, cooking tips and offers:

www.theideaskitchen.co.uk



learn



cook



share

PHONE OUR CUSTOMER COMMUNICATIONS CENTRE

0344 844 3899

For service or spares.

Or order spares direct on line at
www.panasonic.co.uk

Panasonic Corporation
<http://www.panasonic.com>

© Panasonic Corporation 2018

F0003BG70BP
PA0118-0
Printed in P.R.C.