

# Panasonic®

## Operating Instructions Blu-ray Disc™ Recorder Model No. **DMR-BWT740**

**DIGA**  
Blu-ray



Thank you for purchasing this product.

Please read these instructions carefully before using this product, and save this manual for future use.

- **This Blu-ray Disc Recorder is for viewing and recording free to view channels only. It does not receive pay TV or encrypted channels.**

### Software (Firmware) Update



Blu-ray Disc technology and broadcast services continue to add new features. As they evolve, firmware updates may be required to support the latest features. Panasonic strives to continually update firmware as new technology is released. It's very important you install the latest updates to maintain proper operation of your unit.

For details, refer to "Software (Firmware) Update" (⇒ 93) or <http://panasonic.jp/support/global/cs/> (This site is in English only.)

Model number suffix "EB" denotes UK model.

EB

SQT0139

# Safety precautions

## WARNING

### Unit

- To reduce the risk of fire, electric shock or product damage,
  - Do not expose this unit to rain, moisture, dripping or splashing.
  - Do not place objects filled with liquids, such as vases, on this unit.
  - Use only the recommended accessories.
  - Do not remove covers.
  - Do not repair this unit by yourself. Refer servicing to qualified service personnel.
  - Do not let metal objects fall inside this unit.
  - Do not place heavy items on this unit.

### AC mains lead

- To reduce the risk of fire, electric shock or product damage,
  - Ensure that the power supply voltage corresponds to the voltage printed on this unit.
  - Insert the mains plug fully into the socket outlet.
  - Do not pull, bend, or place heavy items on the lead.
  - Do not handle the plug with wet hands.
  - Hold onto the mains plug body when disconnecting the plug.
  - Do not use a damaged mains plug or socket outlet.
- The mains plug is the disconnecting device. Install this unit so that the mains plug can be unplugged from the socket outlet immediately.

### Small object

- Keep the Memory Card out of reach of children to prevent swallowing.

## CAUTION

### Unit

- This unit utilizes a laser. Use of controls or adjustments or performance of procedures other than those specified herein may result in hazardous radiation exposure.

- Do not place sources of naked flames, such as lighted candles, on this unit.
- This unit may receive radio interference caused by mobile telephones during use. If such interference occurs, please increase separation between this unit and the mobile telephone.
- This unit is intended for use in moderate climates.

### Placement

- Place this unit on an even surface.
- To reduce the risk of fire, electric shock or product damage,
  - Do not install or place this unit in a bookcase, built-in cabinet or in another confined space. Ensure this unit is well ventilated.
  - Do not obstruct this unit's ventilation openings with newspapers, tablecloths, curtains, and similar items.
  - Do not expose this unit to direct sunlight, high temperatures, high humidity, and excessive vibration.

### Batteries

- Danger of explosion if battery is incorrectly replaced. Replace only with the type recommended by the manufacturer.
- Mishandling of batteries can cause electrolyte leakage and may cause a fire.
  - Do not mix old and new batteries or different types at the same time.
  - Do not heat or expose to flame.
  - Do not leave the battery(ies) in a car exposed to direct sunlight for a long period of time with doors and windows closed.
  - Do not take apart or short circuit.
  - Do not recharge alkaline or manganese batteries.
  - Do not use batteries if the covering has been peeled off.
  - Remove batteries if you do not intend to use the remote control for a long period of time. Store in a cool, dark place.
- When disposing of the batteries, please contact your local authorities or dealer and ask for the correct method of disposal.



# Caution for AC Mains Lead

## (For the AC mains plug of three pins)

For your safety, please read the following text carefully.

This appliance is supplied with a moulded three pin mains plug for your safety and convenience. A 5-ampere fuse is fitted in this plug.

Should the fuse need to be replaced please ensure that the replacement fuse has a rating of 5-ampere and that it is approved by ASTA or BSI to BS1362.

Check for the ASTA mark  or the BSI mark  on the body of the fuse.

If the plug contains a removable fuse cover you must ensure that it is refitted when the fuse is replaced.

If you lose the fuse cover the plug must not be used until a replacement cover is obtained. A replacement fuse cover can be purchased from your local dealer.

### Before use

Remove the connector cover.

### How to replace the fuse

The location of the fuse differ according to the type of AC mains plug (figures A and B). Confirm the AC mains plug fitted and follow the instructions below.

Illustrations may differ from actual AC mains plug.

1. Open the fuse cover with a screwdriver.

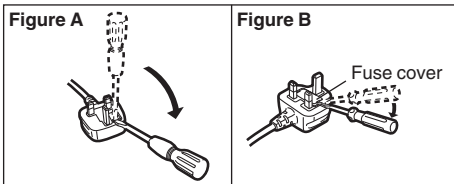

2. Replace the fuse and close or attach the fuse cover.

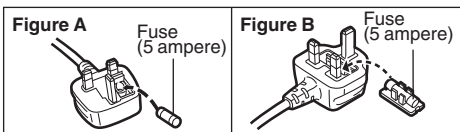

# Supplied accessories

Please check and identify the supplied accessories.

(Product numbers are correct as of April 2014. These may be subject to change.)

- Remote control** (N2QAYB000985): 1 pc.
  - Batteries for remote control:** 2 pcs.
  - AC mains lead** (K2CT2YY00098): 1 pc.
  - RF coaxial cable** (K1TWACC00003): 1 pc.
- Do not use AC mains lead with other equipment.

### Indemnity concerning recorded content

Panasonic does not accept any responsibility for damages directly or indirectly due to any type of problems that result in loss of recording or edited content (data), and does not guarantee any content if recording or editing does not work properly. Likewise, the above also applies in a case where any type of repair is made to the unit (including any other non-HDD related component).

### Restriction on use of unauthorized copied content

This unit adopts the following technology for copyright protection.

#### Cinavia Notice

This product uses Cinavia technology to limit the use of unauthorized copies of some commercially-produced film and videos and their soundtracks. When a prohibited use of an unauthorized copy is detected, a message will be displayed and playback or copying will be interrupted. More information about Cinavia technology is provided at the Cinavia Online Consumer Information Center at <http://www.cinavia.com>. To request additional information about Cinavia by mail, send a postcard with your mailing address to: Cinavia Consumer Information Center, P.O. Box 86851, San Diego, CA, 92138, USA.

# Table of contents

Safety precautions . . . . .	2
Caution for AC Mains Lead . . . . .	3
Supplied accessories . . . . .	3
<b>Getting started</b>	
HDD and media information . . . . .	6
- Recordable/playable contents . . . . .	6
- Recording mode . . . . .	8
- Notes . . . . .	9
Unit care . . . . .	11
Control reference guide . . . . .	12
Connection . . . . .	14
- Basic connections . . . . .	14
- Amplifier/receiver connections . . . . .	15
- Network connection . . . . .	17
Settings . . . . .	18
- TV operation buttons . . . . .	18
- Easy Setting . . . . .	19
- Easy Network Setting . . . . .	21
FUNCTION MENU screen . . . . .	23
<b>Watching broadcasts</b>	
Watching broadcasts . . . . .	24
- Using Channel List . . . . .	24
- Using TV Guide system . . . . .	25
- Using channel information . . . . .	25
- Operations while watching broadcast . . . . .	26
- REWIND LIVE TV/PAUSE LIVE TV . . . . .	27
<b>Recording</b>	
Recording TV programmes . . . . .	28
- Operation during Recording . . . . .	29
Timer recording . . . . .	30
- Various functions with Freeview . . . . .	31
- Manually programming timer recording . . . . .	32
- Timer recording options . . . . .	33
- Timer recording from channel information . . . . .	33
- Remote recording from outside . . . . .	34
- Notes on timer recording . . . . .	34
- To confirm and edit a timer programme . . . . .	35
<b>Playing back video</b>	
Playing titles on the HDD . . . . .	36
- DIRECT NAVIGATOR screen . . . . .	36
Playing titles on the media . . . . .	39
- Notes for BD-Live discs . . . . .	40
Operation during play . . . . .	41
- General operations . . . . .	41
- 3D video playback . . . . .	43
<b>Editing video</b>	
Deleting/Editing recorded titles . . . . .	44
- Deleting . . . . .	44
- Editing . . . . .	44
<b>Copying video</b>	
Copying titles . . . . .	48
- Copying from media other than HDD with DIRECT NAVIGATOR . . . . .	50
- Copying titles with copying list . . . . .	50
- Notes for copying . . . . .	53
- Copying a finalised disc . . . . .	54
- Copying Title Playing . . . . .	55
- Copying HD Video (AVCHD) to the DVD-R in High Definition . . . . .	55
<b>Photo and Music</b>	
Playing photos . . . . .	56
- Photo Menu screen . . . . .	56
- Photo play option . . . . .	57
- Slideshow settings . . . . .	57
Editing photos . . . . .	58
Copying photos . . . . .	59
- Selecting and copying the photos . . . . .	59
- Copying automatically . . . . .	59
Playing music . . . . .	60
- Copying music (MP3) to HDD . . . . .	60
- Playing music recorded on HDD . . . . .	61
- Operations during music play . . . . .	62
Editing music/playlist . . . . .	63
<b>Network</b>	
Smart Home Networking (DLNA) . . . . .	64
- Using this unit as Server . . . . .	64
- Using this unit as Client . . . . .	65
- Using this unit as Media Renderer . . . . .	66
- Using Miracast™ . . . . .	66
- Using Smart Home Networking (DLNA) with Wi-Fi Direct™ . . . . .	67
Enjoying Network Service . . . . .	68
<b>With Other Equipment</b>	
Recording from external equipment . . . . .	69
Copying the HD Video (AVCHD) . . . . .	70
Registering the external HDD (USB HDD) . . . . .	71
- Connecting the USB HDD . . . . .	71
- Disconnecting the USB HDD . . . . .	71
- Registering the USB HDD . . . . .	72

## Convenient functions

VIERA Link functions . . . . .	73
Playback menu . . . . .	74
Basic Settings . . . . .	76
- Common procedures . . . . .	76
- Tuning . . . . .	78
- HDD / Disc / USB HDD . . . . .	80
- Picture . . . . .	82
- Sound . . . . .	82
- Display . . . . .	83
- Connection . . . . .	83
- Network . . . . .	84
- Others . . . . .	86
Other operations . . . . .	89
- Media management . . . . .	89
- Entering text . . . . .	91
- Switching the aspect ratio of the screen . . . . .	92
- HOLD function . . . . .	92
Software (Firmware) Update . . . . .	93

## Troubleshooting

Troubleshooting guide . . . . .	94
- General operation . . . . .	94
- Displays . . . . .	95
- TV screen and video . . . . .	95
- Sound . . . . .	97
- Recording, timer recording and copying . . . . .	97
- Play . . . . .	98
- Edit . . . . .	99
- Photo . . . . .	99
- USB . . . . .	100
- TV Guide . . . . .	100
- Broadcast . . . . .	100
- VIERA Link . . . . .	100
- Network . . . . .	101
- Reset . . . . .	101
- Messages on the unit's display . . . . .	102
- When you experience problems with Easy Network Setting . . . . .	103

## Reference

Specifications . . . . .	104
- Language code list . . . . .	109
Licenses . . . . .	110
Index . . . . .	112

### About descriptions in these operating instructions

- Pages to be referred to are indicated as "⇒ ○○".

## Getting started

## Watching broadcasts

## Recording

## Playing back video

## Editing video

## Copying video

## Photo and Music

## Network

## With Other Equipment

## Convenient functions

## Troubleshooting









## Reference

# HDD and media information













For more details, refer also to the specifications. (⇒ 104)

## Recordable/playable contents

(-: Impossible)

Media type	Standard symbol	Recordable contents	Playable contents
<b>Built-in hard disk drive (HDD)*1</b>		<b>HDD</b>	<ul style="list-style-type: none"> <li>• Video</li> <li>• AVCHD/AVCHD 3D</li> <li>• JPEG</li> <li>• MPO (3D photo)</li> <li>• MP3</li> </ul>
<b>External hard disk drive (USB HDD)*1 (⇒ 9)</b>		<b>USB HDD</b>	<ul style="list-style-type: none"> <li>• Video*2</li> <li>• AVCHD/AVCHD 3D*3,4</li> <li>• MP4</li> <li>• Xvid</li> <li>• JPEG</li> <li>• MPO (3D photo)</li> <li>• MP3</li> <li>• MPEG2</li> <li>• MKV</li> </ul>
<b>BD-Video</b>		<b>BD-V</b>	<ul style="list-style-type: none"> <li>• Video</li> </ul>
<b>BD-RE*1</b>		<b>BD-RE</b>	<ul style="list-style-type: none"> <li>• Video</li> <li>• AVCHD/AVCHD 3D</li> <li>• JPEG</li> <li>• MPO (3D photo)</li> </ul>
<b>BD-R</b>		<b>BD-R</b>	<ul style="list-style-type: none"> <li>• Video</li> <li>• AVCHD/AVCHD 3D*3</li> </ul>
<b>DVD-Video*5</b>		<b>DVD-V</b>	<ul style="list-style-type: none"> <li>• Video</li> </ul>
<b>DVD-RAM*1</b>		<b>RAM</b>	<ul style="list-style-type: none"> <li>• Video</li> <li>• JPEG</li> <li>• MPO (3D photo)</li> </ul>
<b>DVD-R</b> <b>DVD-R DL</b>		<b>DVD-R</b>	<ul style="list-style-type: none"> <li>• Video</li> <li>• AVCHD*3</li> </ul>
 			<ul style="list-style-type: none"> <li>• Xvid</li> <li>• JPEG</li> <li>• MPO (3D photo)</li> <li>• MP3</li> <li>• MKV</li> </ul>

(-: Impossible)

Media type	Standard symbol	Recordable contents	Playable contents
<b>DVD-RW</b> <sup>※1</sup> 		 • Video	
<b>+R/+R DL</b>		–	• AVCHD <sup>※3</sup>
<b>+RW</b> <sup>※1</sup>		 • Video	–
<b>Audio CD (CD-DA)</b> 		 –	• Music
<b>CD</b> (including CD-R/RW)		–	• Xvid • JPEG • MPO (3D photo) • MP3
<b>SD Cards</b> <sup>※1</sup> 		 • JPEG • MPO (3D photo)	• AVCHD/AVCHD 3D <sup>※3, 4</sup> • MP4 • MPO (3D photo) • JPEG
<b>USB memory</b>		 –	• AVCHD/AVCHD 3D <sup>※3, 4</sup> • MP4 • Xvid • JPEG • MPO (3D photo) • MP3

**Playable contents as DLNA client**

Refer to "Playable contents". (⇒ 65)

- ※1 Rewritable media
- ※2 It cannot be recorded directly. (Only compatible with copying from the built-in HDD)
- ※3 Recorded with AVCHD format compatible devices (Panasonic video camera, etc.). It may not be able to play back, add, or edit depending on the device.
- ※4 It cannot be played back directly from the USB HDD or USB memory. Playback is possible by copying to the built-in HDD. (⇒ 70)
- ※5 Includes finalised DVD-R, DVD-R DL, DVD-RW, +R and +R DL.



-  This unit cannot record to 8X Speed +RW disc.
- The producer of the disc can control how discs are played. So you may not always be able to control play as described in these operating instructions. Read the disc's instructions carefully.
- With certain recording states and folder structures, the play order may differ or playback may not be possible.

## HDD and media information

## About extension of files

MP4:	“.MP4”	“.mp4”	“.MOV”	“.mov”		
MPEG2:	“.MPG”	“.mpg”	“.MPEG”	“.mpeg”	“.M2TS”	“.m2ts”
	“.MTS”	“.mts”	“.TS”	“.ts”		
Xvid:	“.AVI”	“.avi”				
Subtitle text files:	“.SRT”	“.srt”	“.SUB”	“.sub”	“.TXT”	“.txt”
MKV:	“.MKV”	“.mkv”				
Subtitle text files:	“.SRT”	“.srt”	“.SSA”	“.ssa”	“.ASS”	“.ass”
	“.SUB”	“.sub”	“.TXT”	“.txt”		
JPEG:	“.JPG”	“.jpg”				
MPO:	“.MPO”	“.mpo”				
MP3:	“.MP3”	“.mp3”				



- The video file and subtitle text files are inside the same folder, and the file names are the same except for the file extensions.
- Some files may not be played back even if they have these extensions.

## Recording mode

Recording Mode	DR	HG/HX/HE/HL/HM	XP/SP/LP/EP/FR
<b>Feature</b>	Programmes can be recorded in a nearly perfect broadcasted state.	Recording can be done with reduced recording volume in HD quality.	Recording can be done with reduced recording volume in SD quality.
<b>Quality</b>	Quality as the broadcast	High definition* <sup>1</sup>	Standard definition
<b>Recordable media</b>			
<b>Multiple audio</b>	Record all multiple audio	Record only one audio* <sup>2</sup>	
<b>Audio Description</b>	Can be recorded	Can be recorded* <sup>2</sup>	
<b>Subtitles</b>	Can be recorded	Can be recorded (only one subtitle)* <sup>3</sup>	
<b>Surround audio</b>	Surround audio as the broadcast	Surround audio produced by conversion of broadcast audio format	Stereo audio

\*<sup>1</sup> The SD quality programme can not be converted to HD quality.

\*<sup>2</sup> You cannot select during play whether it activates or deactivates.

\*<sup>3</sup> You cannot select during play whether it appears or disappears.

## Approximate recording times

Refer to “Recording modes and approximate recording times”. (⇒ 108)

## • FR (Flexible Recording Mode)

The unit automatically selects the best possible recording rate between XP mode and EP mode.



## Notes

### Notes for an External HDD (USB HDD)

You can use an external HDD in the following two ways. (A single HDD cannot handle those two ways simultaneously.)

#### • For recorded titles

Moving titles in the built-in HDD to a USB HDD to save the capacity of the built-in HDD.

- The USB HDD must first be registered on this unit. (⇒ 71)

#### • For data files

Playing back MP4, JPEG, MP3, etc. (data files) in a USB HDD with this unit.

- The USB HDD must be formatted in FAT12, FAT16, FAT32 and NTFS file system.
- The USB HDD over 2 TB is not usable.



- This unit supports USB 2.0 High Speed.
- Although this unit can use USB 3.0 devices as USB 2.0 devices, in certain cases USB 3.0 devices cannot be used due to differing connector shape, larger current ratings, etc. (Use of USB 2.0 devices is recommended.)
- This unit does not recognize USB HDDs other than those in which the size of one sector is 512-bytes or 4096-bytes. (For details, consult the dealer of your USB HDD.)
- This unit does not guarantee connection with all USB devices.

### Notes for the disc

#### • Region management information

The unit can play back BD-Video/DVD-Video discs of the following regions codes, including "ALL":

e.g.,

BD-Video



DVD-Video



#### • Disc recorded on another device

- It may be necessary to finalize the disc, create Top Menu or close the session on the equipment used for recording to play on this unit.
- **[DVD-RW]** Recorded in DVD Video Recording (DVD-VR) format
  - This unit can play back and copy to HDD.
  - This unit does not support editing or recording.
  - It is possible to record and edit with DVD-Video (DVD-V) format by formatting discs with this unit.
- Recording may not be possible to discs which were used for recording on other equipment.

#### • Play on other players

- **[BD-RE]** **[BD-R]** When these discs cannot be played back on other Blu-ray Disc players, etc. (e.g., title recorded with HE-AAC audio format), convert the recording mode to play them back. (⇒ 46, File Conversion)
- **[DVD-R]** **[DVD-RW]** **[+R]** Finalisation is needed. (⇒ 91)
- **[+RW]** If the disc failed to play on other equipment, we recommend you create a Top Menu (⇒ 90).
- **[DVD-R]** The disc created in AVCHD format can only be played back on AVCHD compatible equipment.

#### • Regarding 8 cm Disc

This unit cannot record or edit the 8 cm disc. Only playback or copy to the HDD is possible.

#### • Discs that cannot be played

- DVD-RAM that cannot be removed from their cartridges
- 2.6 and 5.2 GB DVD-RAM, 12 cm
- DVD-Audio
- HD DVD
- Super Video CD, Super Audio CD, Video CD
- CD-ROM, Photo CD, PD, etc.



- Operation and sound quality of CDs that do not conform to CD-DA specifications (copy control CDs, etc.) cannot be guaranteed.

## HDD and media information

### Notes for the SD cards

- **Compatible SD card**
  - SD Memory Card  
(from 8 MB to 2 GB, FAT12 and FAT16 formats)
  - SDHC Memory Card  
(from 4 GB to 32 GB, FAT32 format)
  - SDXC Memory Card  
(48 GB, 64 GB, exFAT format)

- **Using miniSD card or microSD card**

Mini-type and micro-type cards can also be used, but must be used with adaptor cards (optional).

### To format an SD card

Refer to “Format Disc/Format Card”. (⇒ 90)



- Usable memory is slightly less than the card capacity.
- If the SD card is formatted on other equipment, the time necessary for recording may be longer or the card may not be able to be used on this unit. In these cases, format the card on this unit.
- SDHC Memory Cards and SDXC Memory Cards can be used in equipment that is compatible with the appropriate cards. (SDHC Memory Cards can also be used in equipment compatible with SDXC Memory Cards)

### Notes for the USB memories

USB memories support FAT12, FAT16, FAT32 and NTFS file systems.



- The USB memory over 2 TB is not usable.
- This unit supports USB 2.0 High Speed.
- This unit does not guarantee connection with all USB devices.

### Media handling

- Do not touch the recorded surface of the discs or the terminal surface of the SD cards.



- If there is dirt or condensation on the disc, wipe with a damp cloth and then wipe dry.



- Do not attach labels or stickers to discs.
- Do not use disc cleaning sprays, benzene, thinner, static electricity prevention liquids or any other solvent.
- Do not use ballpoint pens or other hard writing implements, when writing on the label side of the disc.
- Do not drop, stack, or impact discs.
- Do not place objects on discs.
- Do not use the following discs:
  - Discs with exposed adhesive from removed stickers or labels (rental discs, etc.).
  - Discs that are badly warped or cracked.
  - Irregularly shaped discs.

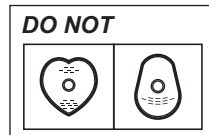

- Do not expose the terminals of the SD card to water, garbage or other strange things.
- Do not place in the following areas:
  - In hot places, such as under the direct sunlight.
  - In very dusty or humid areas.
  - Locations susceptible to significant difference in temperature (condensation can occur).
  - Where static electricity or electromagnetic waves occur.

# Unit care

## HDD/USB HDD handling care

- **The HDD is a high precision device**  
The HDD is a high precision recording instrument and is easily susceptible to damage. Therefore, be careful of the following points while the unit is turned on, especially during operation, otherwise the HDD and the recorded content may be damaged:
  - Do not subject the unit to any vibration and shock.
  - Do not remove the AC mains lead from the household mains socket.
- **The HDD is a temporary storage device**
  - The HDD is not an everlasting storage device. It is recommended to save the recorded content on a disc or to keep the original data or CDs that they were copied from.
  - If you notice a problem with the HDD such as repetitive strange sounds, immediately save (backup) all content and request service. If you continue using the HDD with a problem, the unit or the recorded content will be damaged.
- **If the HDD or USB HDD is damaged, the recorded content cannot be recovered.**

## Setup precautions

- **Place the unit on a surface that is flat and not subject to vibration or impact.**
- **Do not place on anything that generates heat like a Set Top Box, etc.**
- **Place in an area where condensation does not occur. Conditions where condensation may occur**
  - When there is an extreme change in temperature (e.g., when subjected to an air conditioner or when cooled air directly impacts the unit).
  - When there is high humidity or a lot of steam in the room.

In the above situation, **without turning the unit on**, let the unit adjust to the room temperature and wait 2–3 hours until condensation is gone.
- **The unit may breakdown if cigarette smoke or bug spray/vapour, etc. gets inside the unit.**

## When moving the unit

Before moving the unit, ensure the disc tray is empty.

- 1 Switch the unit to standby mode. (Wait until "BYE" disappears from the display.)
- 2 Remove the AC mains lead from the household mains socket.
- 3 Move only after the unit has come to a complete stop (approx. 3 minutes) in order to avoid subjecting to vibration and shock. (Even after the unit is switched to standby mode, the HDD continues operating for a short time.)

## Cleaning

- **This unit**
  - Wipe with a soft, dry cloth.
  - Never use alcohol, paint thinner or benzine to clean this unit.
  - Before using chemically treated cloth, carefully read the instructions that came with the cloth.
- **This unit's lens**  
Use the **Lens cleaner** (optional) to clean the unit's lens.

Lens cleaner: RP-CL720AE

- This lens cleaner may not be available for sale in all countries, e.g. not available in Germany, please consult your Panasonic dealer for advice.

## When requesting this unit for repair

The registration of the USB HDD may be cancelled in the process of repairing this unit. You can use the USB HDD again by re-registering, but all recorded content already on the USB HDD will be lost. In such cases, the recorded content (data) cannot be recovered.

## To dispose or transfer this unit

This unit may contain private information. Before disposing of or transferring this unit, perform the following to delete the data, including personal or secret information:

- Format HDD (⇒ 76, 81)
- Perform "Shipping Condition" (⇒ 76, 88)

# Control reference guide

Instructions for operations are generally described using the remote control.

## Remote control

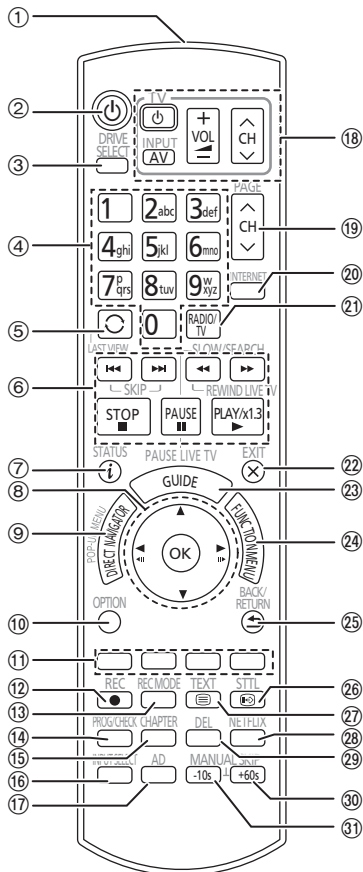

- ① Transmit the remote control signal
  - Point it at remote control signal sensor on this unit. (⇒ 13)
- ② Switch the unit from on to standby mode or vice versa
- ③ Select drive (HDD, BD, SD or USB)
- ④ Select channels and title numbers, etc./Enter numbers or characters
- ⑤ Switch to the previously watched channel (⇒ 24)
- ⑥ Basic operations for recording and play, REWIND LIVE TV/PAUSE LIVE TV (⇒ 27)
- ⑦ Show Information (⇒ 25, 37, 41)
- ⑧ Selection/OK, Frame-by-frame (⇒ 41)

- ⑨ Show DIRECT NAVIGATOR, Top Menu, Pop-up Menu (⇒ 36)
- ⑩ Show OPTION menu (⇒ 44, 58, 63)
- ⑪ Colour buttons (Use in accordance with instruction on the screen.)
- ⑫ Start recording (⇒ 28, 69)
- ⑬ Select a conversion mode/recording mode (⇒ 28, 69)
- ⑭ Show the Timer Recording screen (⇒ 32)
- ⑮ Create chapter (⇒ 42)
- ⑯ Input select (⇒ 24, 69)
- ⑰ Listen to Audio Description (⇒ 26, 42)
- ⑱ TV operation buttons (⇒ 18)
- ⑲ Channel select (⇒ 24)/Change pages in the DIRECT NAVIGATOR screen etc.
- ⑳ Show the Network Service screen (⇒ 68)
- ㉑ Switching to the radio channel list (⇒ 24)
- ㉒ Exit the menu screen
- ㉓ Show the TV Guide screen (⇒ 25)
- ㉔ Show the FUNCTION MENU screen (⇒ 23)
- ㉕ Return to previous screen
- ㉖ Show subtitles (⇒ 26, 42)
- ㉗ Show Digital teletext (⇒ 26)
- ㉘ Show NETFLIX screen (⇒ 68)
- ㉙ To delete unwanted recorded titles, timer programmes, photos or music (⇒ 44)
- ㉚ Skip approx. 1 minute forward (⇒ 42)
- ㉛ Skip approx. 10 seconds backward (⇒ 42)

## Insert batteries

Insert so the poles (+ and -) match those in the remote control.

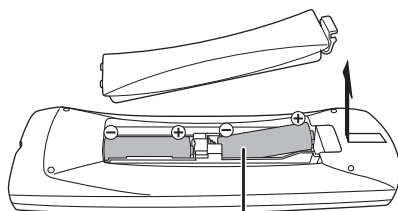

R6/LR6, AA  
(Alkaline or manganese batteries)

## Main unit

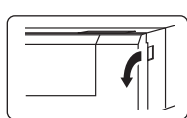
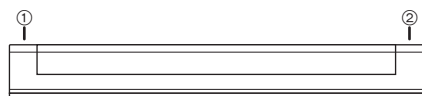

Pull to flip down the front panel.

- ① **Standby/on switch (⏻/⏻)**  
Press to switch the unit from on to standby mode or vice versa. In standby mode, the unit is still consuming a small amount of power.
- ② Open/close disc tray

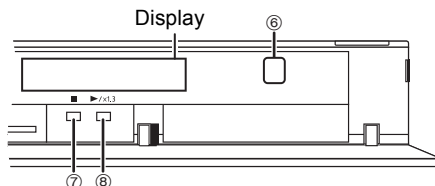

- ⑥ Remote control signal sensor
  - Angle: Approx. 20° up and down, 30° left and right
  - Distance: Within approx. 7 m in front of the unit
- ⑦ Stop
- ⑧ Start play

## Display

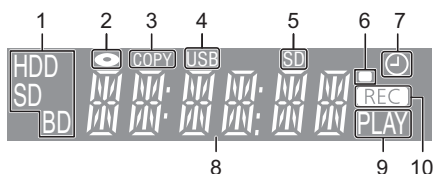

- ③ Disc tray
  - ④ USB port
  - ⑤ SD card slot
    - When removing the SD card, press on the centre of the card and pull it straight out.
-  While writing to/reading from the media, do not switch the unit to standby mode or remove the media. Such action may result in loss of the media contents.
- When inserting the media, ensure that it is facing the right way up.
- 1 Drive (HDD, BD or SD) indicator
  - 2 Disc indicator
  - 3 Copying indicator
  - 4 USB port indicator
  - 5 SD card slot indicator
  - 6 Remote control signal indicator
  - 7 Timer recording indicator
    - This indicator lights up when the timer recording standby is activated.
  - 8 Main display section indicator
    - Current time
    - Playback counter
    - Various messages (⇒ 102)
  - 9 Playback indicator
  - 10 Recording indicator
    - The indicator will light up while recording.
    - The indicator will blink while recording is paused and before timer recording starts.

# Connection

## Basic connections

**3D programmes can be played back when this unit is connected to a 3D compatible TV.**

- Before connection, turn off all equipment and read the appropriate operating instructions.

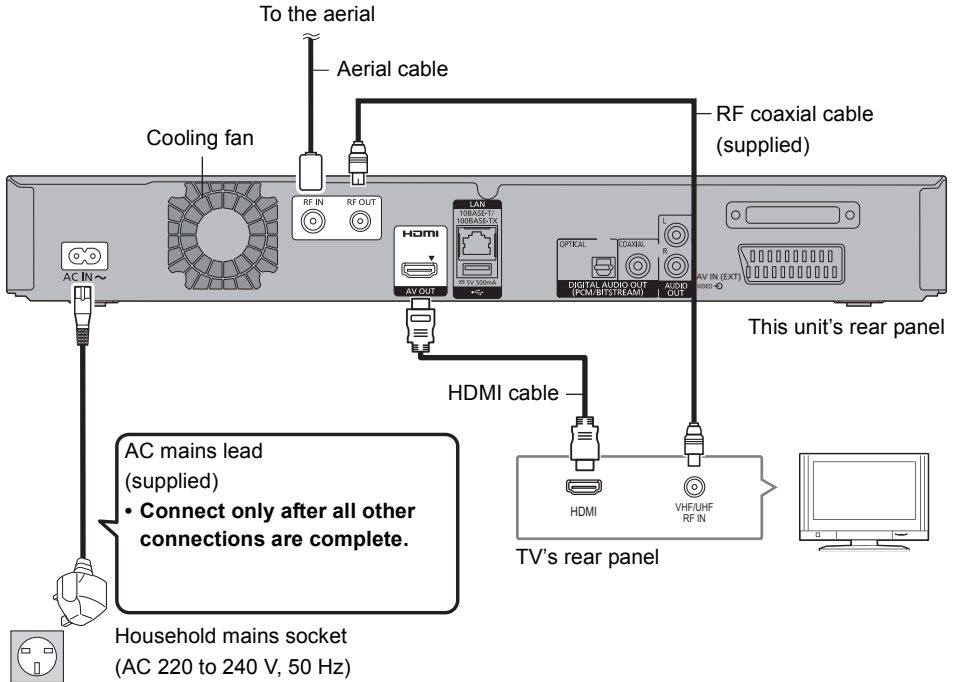

### To connect and register the USB HDD (optional)

Refer to "Registering the external HDD (USB HDD)". (⇒ 71)

### About HDMI cable

Use the High Speed HDMI cables. Non-HDMI-compliant cables cannot be utilized.

It is recommended that you use Panasonic's HDMI cable.

When outputting 1080p signal or 24p(4K) signal, please use HDMI Cables 5.0 meters or less.

### When the unit is not to be used for a long time

To save power, unplug it from the household mains socket. This unit consumes a small amount of power, even when the unit is in standby mode.

**[approx. 0.2 W ("Quick Start" is not activated and "RF OUT ( Aerial Signal )" is set to "Off")]**



- This unit cannot connect the TV that does not have the HDMI terminal.
- Keep the RF coaxial cables as far away as possible from other cables.
- Do not roll up the RF coaxial cables.
- The HDMI connection supports VIERA Link "HDAVI Control" (⇒ 73).
- You cannot connect this unit to DVI devices that are incompatible with HDCP.  
Depending on the device, images may not display properly or at all when connecting with a DVI/HDMI switching cable. (Audio cannot be output.)
- If you are connecting to a TV that is only compatible with 2 channel audio output, audio with 3 channels or more will be down mixed and output as 2 channels, even if connecting with an HDMI cable. (Some discs cannot be down mixed.)

### Connect the Set Top Box or video equipment

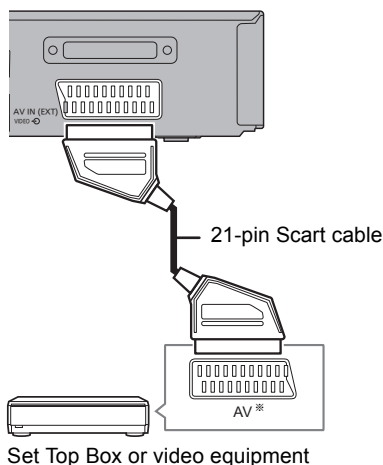

- \* A 21-pin Adaptor is required for AUDIO/VIDEO terminal.

## Amplifier/receiver connections

### HDMI terminal

**3D programmes can be played back when this unit is connected to a 3D compatible amplifier/receiver and a 3D compatible TV.**

- You will not be able to view 3D programmes with this connection if your amplifier/receiver is not 3D compatible.

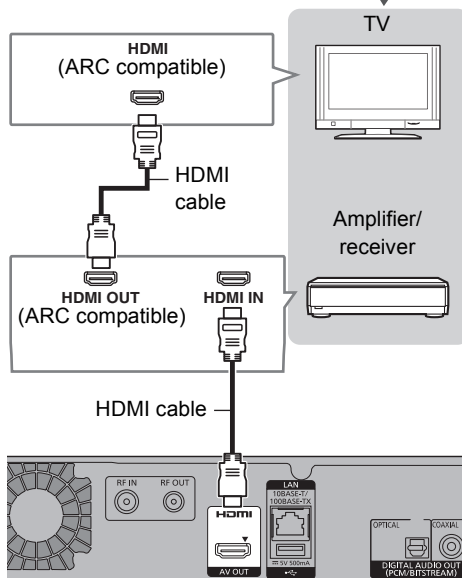

- VIERA Link function is possible by connecting to a TV or amplifier/receiver compatible with VIERA Link.
- When using a TV or an amplifier/receiver that does not display "ARC compatible" on the HDMI terminal, it is necessary to connect the TV and the amplifier/receiver with a digital audio cable to enjoy the TV audio on the amplifier/receiver.

## Connection

### ■ Amplifier/receiver not compatible with 3D

3D programmes can be played back when this unit is connected to a 3D compatible TV.

- This connection only supports up to 5.1ch.

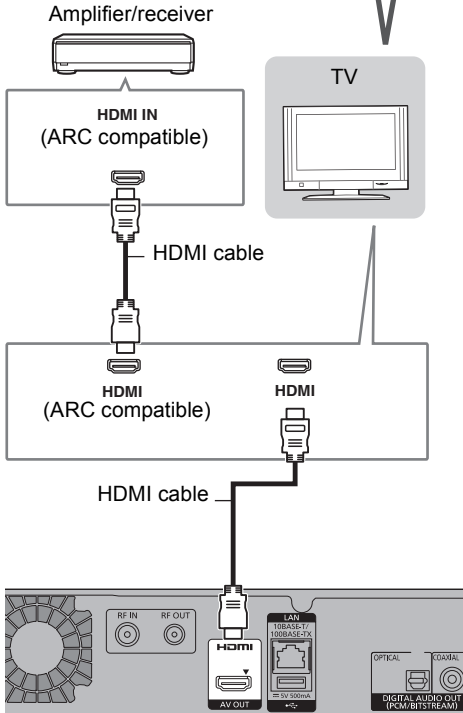

- VIERA Link function is possible by connecting to a TV or amplifier/receiver compatible with VIERA Link.
- When using a TV or an amplifier/receiver that does not display "ARC compatible" on the HDMI terminal, it is necessary to connect the TV and the amplifier/receiver with a digital audio cable to enjoy the TV audio on the amplifier/receiver.

### DIGITAL AUDIO OUT terminal

#### ■ Using Optical digital audio cable

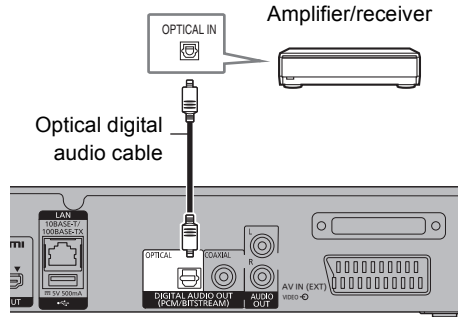

#### ■ Using Coaxial cable

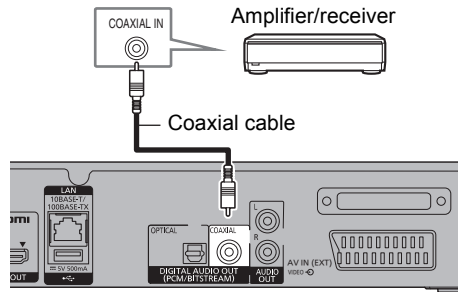

- When you do not want the audio to be output from the TV, set "HDMI Audio Output" to "Off" (⇒ 76, 84).

### AUDIO OUT terminal

- Connect to terminals of the same colour.

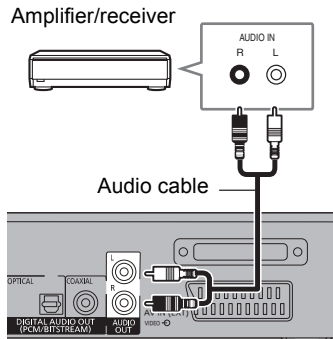



## Network connection

When this unit is connected to the network, you can enjoy network functions (DLNA function, Network Service, Remote Recording, etc.).

For details about connection method, refer to the instructions supplied with the connected equipment.

After you make the Wireless LAN/LAN cable connection, the network setting is needed. (⇒ 21, Easy Network Setting)

### ■ Precautions of Wireless LAN connection

The following limits are in place regarding the usage of this unit. You must be aware of these limits before using this unit.

Panasonic will in no way be responsible for any incidental damage which may arise due to a failure to obey these limits, or to any condition of use or disuse of this unit.

- **Data transmitted and received over radio waves may be intercepted and monitored.**
- **This unit contains delicate electronic components.**

Please use this unit in the manner in which it was intended and follow the following points:

- Do not expose this unit to high temperatures or direct sunlight.
- Do not bend, or subject this unit to strong impacts.
- Keep this unit away from moisture.
- Do not disassemble or alter this unit in any way.

## Wireless LAN connection

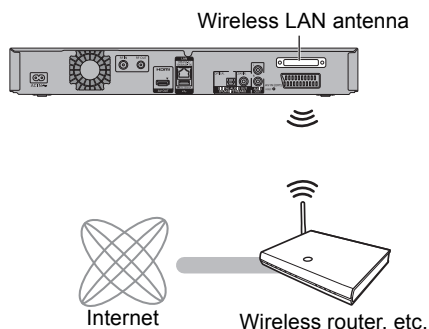

- For up-to-date compatibility information on your Wireless router refer to <http://panasonic.jp/support/global/cs/> (This site is in English only.)
- The unit is not compatible with public wireless LAN services.
- Do not cover the wireless LAN antenna with a cable, etc. This will deteriorate the radio wave reception of this unit.

## LAN cable connection

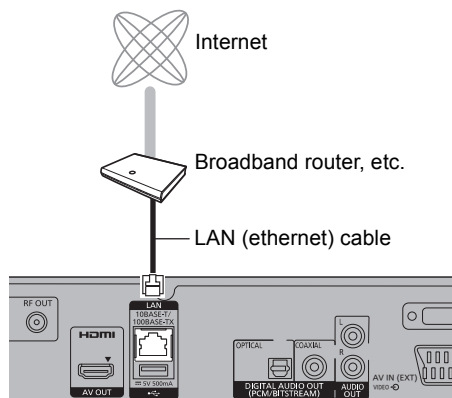

- Use category 5 or above straight LAN cables (STP) when connecting to peripheral devices.
- Inserting any cable other than a LAN cable in the LAN terminal can damage the unit.

# Settings

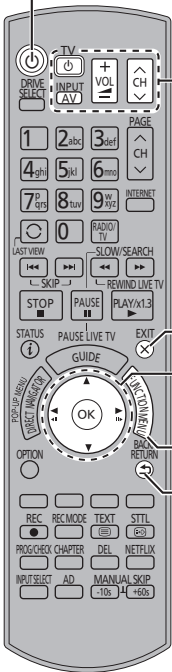
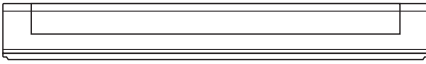

TV operation buttons  
(⇒ right)

To exit the screen

Select and enter buttons

FUNCTION MENU (⇒ 23)

To return to the previous screen

## TV operation buttons

The TV can be operated from the TV operation buttons of the remote control.

- Perform the setting if you cannot operate the TV with the TV operation buttons.

**While pressing [TV , enter the code with the number buttons.**

## Manufacturer and Code No.

Brand	Code	Brand	Code
Panasonic	01/02/03/04	NEC	36
AIWA	35	NOBLEX	33
AKAI	27/30	NOKIA	25/26/27/60/61
BEKO	05/71/72/73/74	NORDMENDE	10
BENQ	58/59	OLEVIA	45
BRANDT	10/15	ONWA	30/39/70
BUSH	05	ORION	05
CENTREX	66	PEONY	49/69
CURTIS	05	PHILCO	41/48/64
DAEWOO	64/65	PHILIPS	05/06/46
DESMET	05	PHONOLA	05
DUAL	05	PIONEER	37/38
ELEMIS	05	PROVIEW	52
FERGUSON	10/34	PYE	05
FINLUX	61	RADIOLA	05
FISHER	21	SABA	10
FUJITSU	53	SALORA	26
FUNAI	63/67	SAMSUNG	32/42/43/65/68
GOLDSTAR	05/50/51	SANSUI	05
GOODMANS	05	SANYO	21/54/55/56
GRADIENTE	36	SCHNEIDER	05/29/30
GRUNDIG	09	SEG	05/69/75/76/77/78
HITACHI	05/22/23/40/41	SELECO	05/25
IRRADIO	30	SHARP	18
ITT	25	SIEMENS	09
JVC	17/30/39/70	SINUDYNE	05
KDS	52	SONY	08
KOLIN	45	TCL	31/33/66/67/69
KONKA	62	TELEFUNKEN	10/11/12/13/14
LG	05/50/51	TEVION	52
MAG	52	THOMSON	10/15/44
METZ	05/28/79	TOSHIBA	16/57
MITSUBISHI	05/19/20/47	WHITE WESTINGHOUSE	05
MIVAR	24	YAMAHA	18/41



- If your TV brand has more than one code listed, select the one that allows correct operation.
- If the brand of your TV is not listed or the code number is invalid for your TV, this remote control is not compatible with your TV.

## Easy Setting

- 1 Turn on the TV, then select the appropriate AV input to suit the connections to this unit.
- 2 Press [⏻] on the remote control or [⏻/I] on this unit.
  - The Easy Setting will start at the initial power on.

Auto Setup starts.

(This operation may take some time.)

e.g.,

DVB Auto Setup			
Progress		CH 21	68
This will take about 3 minutes.			
CH	Channel Name	Type	Quality
35	○○○○	Free TV	10
35	○○○○	Free TV	10
Free TV: 2	Pay TV: 0	Radio: 0	Data: 0
Searching			
Actual number of channels may differ due to channel duplication.			
RETURN			

- 3 Clock will be set automatically.  
If the clock setting screen appears, set the time manually (⇒ 87, Clock).
  - If the region selection screen appears, select repeatedly until you reach the available region.

## 4 Enter the PIN.

This PIN will be used only for the Owner ID-Data Entry screen.

You now have the opportunity to enter your details and help the police to crack crime.  
See Instruction Book.

Owner ID

Please enter new PIN

PIN

=  PIN entry

- 1 Press the number buttons to enter 4-digit PIN.
- 2 Repeat step 1 to confirm.
  - Make a note of PIN in case you forget it. The PIN number cannot be reset.
  - Steps 4 – 6 will be skipped in the Easy Setting after “Shipping Condition” (⇒ 88) is performed. (⇒ go to step 7 on page 20)

- 5 Set the Owner ID-Data Entry (“NAME”, “HOUSE NO” and “POSTCODE”).  
e.g.,

Owner ID-Data Entry

PIN	0000
NAME	
HOUSE NO	
POSTCODE	

- 1 Select the item, then press [OK].
- 2 Select the character, then press [OK].  
Repeat this step.
- 3 Press [BACK/RETURN ⊖].
- 4 Repeat steps 1-3 to enter all data.
- 5 Press [BACK/RETURN ⊖] to exit from the Owner ID-Data Entry screen.

## Settings

### 6 Enter the new PIN for parental control.

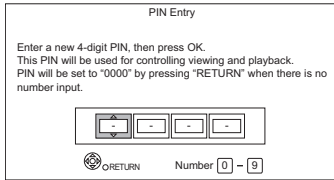

- The default PIN is "0000".
- 1 Enter the new 4-digit PIN with the number buttons.
    - **Make a note of the PIN you have decided on in case you forget it.**
  - 2 Press [OK].
- 7** Set "Quick Start" to "On", "Off" or "Timer Setting for Quick Start", then press [OK]. For details, refer to "Quick Start". (⇒ 86)

When "Easy Setting has been completed." appears, Easy Setting is complete.

- Select "Yes" to set network settings.
- Select "No" to finish the Easy Setting.

#### To stop partway

Press [BACK/RETURN ⊖].

#### To restart setup

- 1 Press [FUNCTION MENU]. (⇒ 18)
- 2 Select "Basic Settings" in "Setup", then press [OK].
- 3 Select "Auto Setup" in "Tuning", then press [OK].
- 4 Select "Yes", then press [OK].

#### To display the Owner ID information on TV

- 1 While the unit is on, press and hold [OK], the yellow button and the blue button on the remote control at the same time for more than 5 seconds.
  - "00 RET" is displayed on the unit's display.
- 2 Repeatedly press [▶] (right) on the remote control until "01 OID" is displayed on the unit's display.
- 3 Press [OK] on the remote control.
  - The PIN is not displayed.

#### To change PIN for parental control

Refer to "PIN Entry". (⇒ 88)

#### To change the region for Channel Sorting

Refer to "Channel Sorting by Region". (⇒ 79)



- If tuning is cancelled partway through, it may not be possible to receive the channels. Restart setup again.

## Easy Network Setting

- 1 Select "Wired" or "Wireless", then press [OK].

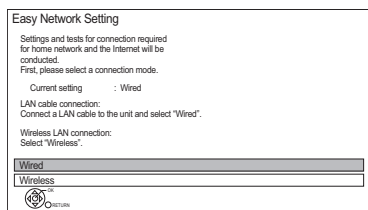

- 2 Follow the on-screen instructions and make the following confirmation and settings.

### "Wired" connection:

- Home Network Connection Check
- Home Network function
- Remote Recording function
- Internet Connection Test

### "Wireless" connection:

- Before beginning wireless connection setup obtain your Network name (SSID). An SSID (Service Set IDentification) is a name used by wireless LAN to identify a particular network. Transmission is possible if the SSID matches for both devices.
- Wireless Settings
- Home Network Connection Check
- Home Network function
- Remote Recording function
- Internet Connection Test

- 3 When "Easy Network Setting is finished." appears Press [OK].

## Connection method to wireless access point

### Search for wireless network:

- 1 Select "Search for wireless network", then press [OK].
- 2 The available wireless networks will be displayed. Select your network name and press [OK].
  - If your Network name is not displayed search again by pressing the red button on the remote control.
  - Stealth SSID will not be displayed. Enter manually by using "Wireless Settings". (⇒ 76, 84)
  - If your wireless network is encrypted, Encryption Key Input Screen will be displayed. Input the encryption key of your network.
- 3 Select "Set", then press [OK].

### WPS (PUSH button):

If your Wireless router supports WPS (PUSH button), you can easily perform the settings by pressing WPS button on it.

WPS (Wi-Fi Protected Setup™) is a standard that facilitates settings relating to the connection and security of wireless LAN devices.

- 1 Select "WPS (PUSH button)", then press [OK].
- 2 Press WPS button or corresponding button of Wireless router until the lamp starts flashing.

e.g.,

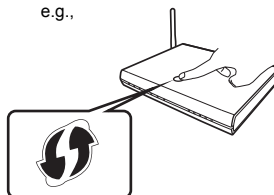

- Wi-Fi Protected Setup™-compatible Wireless router may have the mark.
  - For details, refer to the operating instruction of Wireless router.
- 3 Press [OK].

## Settings

### When you experience problems

Refer to "When you experience problems with Easy Network Setting". (⇒ 103)

### To restart Easy Network Setting

- 1 Press [FUNCTION MENU]. (⇒ 18)
- 2 Select "Basic Settings" in "Setup", then press [OK].
- 3 Select "Easy Network Setting" in "Network", then press [OK].

### To redo settings individually

If "Easy Network Setting" did not work properly or when you change the settings individually, perform the following steps:

- 1 Press [FUNCTION MENU]. (⇒ 18)
- 2 Select "Basic Settings" in "Setup", then press [OK].
- 3 Select "Network Settings" in "Network", then press [OK].
- 4 Refer to "Network Settings". (⇒ 84)

### Check security before using Home Network function

If you set "Home Network function" to "On", all connected devices on the same network can access this unit. Ensure that the router for your home network has adequate security system to prevent unauthorized access.



- Refer to the operating instructions of the hub or router.
- If you set "Home Network function" or "Remote Recording function" to "On", the setting for "Quick Start" is fixed to "On".
- Do not use this unit to connect to any wireless network for which you do not have usage rights. During automatic searches in a wireless network environment, wireless networks (SSID) for which you do not have usage rights may be displayed; however, using these networks may be regarded as illegal access.
- After performing network settings on this unit, the settings (encryption level, etc.) of the Wireless router might change. When you have trouble getting online on your PC, perform the network settings on your PC in accordance with the settings of Wireless router.
- Please be aware that connecting to a network without encryption may result in the content of the communication being illegitimately viewed by a third party, or the leaking of data such as personal or secret information.

# FUNCTION MENU screen

You can easily access the desired functions, such as playback, timer recording, the unit's settings etc. via the FUNCTION MENU.

**1** Press [FUNCTION MENU].

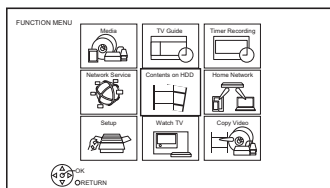

**2** Select the item, then press [OK].

e.g.,

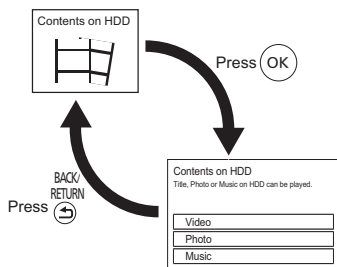

## FUNCTION MENU list

- **Media**
  - Disc
  - SD Card
  - USB device
  - USB HDD
- **TV Guide (⇒ 25)**
- **Timer Recording (⇒ 32)**
- **Network Service (⇒ 68)**
- **Contents on HDD**
  - Video (⇒ 36)
  - Photo (⇒ 56)
  - Music (⇒ 60)
- **Home Network**
  - Miracast (⇒ 66)
  - DLNA Client (⇒ 65)
  - Media Renderer (⇒ 66)
  - Wi-Fi Direct (⇒ 67)
- **Setup**
  - Basic Settings (⇒ 76)
    - You can change the unit's settings of Tuning, Sound, Display, Connection, Network etc.
  - Remote Recording (⇒ 34)
  - Wallpaper
    - Personalize a background of the FUNCTION MENU.
    - To select from among "Photo", register photo in advance. (⇒ 57)
  - BD-Video Data Management (⇒ 40)
- **Watch TV (⇒ 24)**
- **Copy Video**
  - Copy Menu (⇒ 50)
  - Copy Video (AVCHD) to DVD-R (⇒ 55)

# Watching broadcasts

Instructions for operations are generally described using the remote control. (⇒ 12)

**1** Press [INPUT SELECT] and select “TV”, then press [OK].

**2** Press [CH ^ v] to select the channel.

- You can also select the channel by the following operations.
  - Using number buttons
  - Using Channel List (⇒ right)
  - Using TV Guide system (⇒ 25)
  - Using channel information (⇒ 25)

**To switch to the channel you have previously watched**

Press [LAST VIEW 

- This function will work only for the channels you have watched for more than 10 seconds.

**To switch to the radio channels or to the all channels**

Press [RADIO/TV].



- When you are watching the 3D programme, subtitles and TV Guide, etc., may not display correctly depending on the settings. (⇒ 43, 3D Type, Signal Format)

## If this unit request a PIN

If you have locked channels (⇒ 79, Child Lock List), you may be asked to enter the PIN. In that case, enter the 4-digit PIN with the number buttons by following the on-screen instructions.

- PIN can be changed via “PIN Entry”. (⇒ 88)

## Using Channel List

You can select from the list of channel names.

**1** Press [OK].

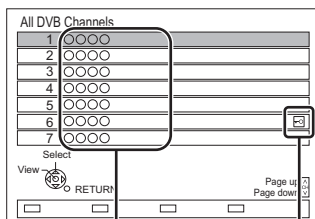

Channel names

Encrypted channel

**2** Select the channel, then press [OK].

## To edit the channel list

Refer to “Channel List”. (⇒ 78)



- Encrypted channels cannot be watched.



## Using TV Guide system

- 1 Press [GUIDE].  
TV Guide screen appears.

Preview		TUE 01/01/2014 8:05		Category: All DVB Channels	
	8:00 - 9:45	SKINJ workman		①	
TUE 01/01	8:30	8:30	9:00	9:30	10:00 10:30
1	OOOO	SKINJ workman	House dog	Penguin	Will
2	OOOO	Kitten	House dog		
3	OOOO	Vacation	Hunting		
4	OOOO	Pampas grass	News	Top run	
5	OOOO	News	Com Shopping	Area 51	
6	OOOO	Venus		Moon	
7	OOOO	Construction		Hippopotamus	
8	OOOO	Guest river	Mr. Otter	Drudge	

OK     RETURN     Information     Page Up [▲]     Page Down [▼]  
 Timer Rec.     +24 hours     Category

- 2 Select the programme, then press [OK].
- 3 Select "View", then press [OK].

### Page up/down

Press [CH ▲ ▼].

### To view a programme list for another day

Press the green button (Previous) or the yellow button (Next).

### To see programme information

Press [STATUS ①].

### To retrieve the programme data for the area where data have not been acquired

Select the area, then press [STATUS ①].

- Some broadcasters may not send the programme data. You cannot retrieve the data from them.

### To set a timer Recording using the TV Guide System

Refer to "Timer recording". (⇒ 30)



- Selection of channel is made easy by creating a Favourite of the channels you watch often. (⇒ 78, Favourites Edit)
- If you make access to Rovi Guide via Network Service, you can use an additional TV Guide which can search programmes by keywords and can display the detailed information, etc. (current as of April, 2014). (⇒ 68)

## Using channel information

While watching a programme  
Press [STATUS ①].

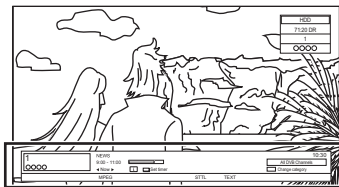

Channel information appears.

e.g.,

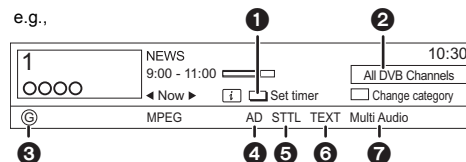

- 1 Set timer (⇒ 33)
- 2 Current Category
- 3 Programme with Guidance information for parental control (⇒ 80, Child Lock)
- 4 Audio Description
- 5 Subtitle
- 6 Digital teletext
- 7 Multiple audio

### To show detailed information

Press [STATUS ①] again.

### To hide the information screen

Press [EXIT ⊗].

### To change Category

Press the blue button.

### • To register your favourite channels

- 1 Press [OPTION].
- 2 Select "Digital TV Menu", then press [OK].
- 3 Select "Favourites Edit", then press [OK].
- 4 Refer to "Favourites Edit". (⇒ 78)

### To switch between the current programme and the next programme

Press [◀, ▶].

### To switch to another channel

Press [▲, ▼], then press [OK].

## Watching broadcasts

### Operations while watching broadcast

#### To show subtitle

When "STTL" appears in channel information (⇒ 25)

Press [STTL .

- Press again to hide subtitle.

#### Switching audio



When "Multi Audio" appears in channel information (⇒ 25)

- 1 Press [OPTION].
- 2 Select "Multi Audio" in "Digital TV Menu", then press [OK].
- 3 Select the desired audio.
  - Press [EXIT 

#### To listen to the Audio Description

Audio Description adds an additional soundtrack to describe events on screen (narration) and aids understanding and enjoyment, particularly for visually-impaired viewers.

When "AD" appears in channel information (⇒ 25)





- 1 Press [AD].
- 2 Select "Audio Description" and set to "Automatic".
- 3 Select "Volume", then adjust the volume with [, ].



- Audio Description may not be available depending on the type of audio format.
- When "Dolby D / Dolby D + / Dolby TrueHD", "MPEG" or "HE-AAC" is set to "Bitstream", the Audio Description may not work. Set them to "PCM" (⇒ 82, Digital Audio Output).
- You can also set "Audio Description" active in the Setup menu. (⇒ 79)

#### To show Digital teletext (MHEG)

When "TEXT" appears in channel information (⇒ 25)

- 1 Press [TEXT .
- 2 Use [, , , , number buttons or colour buttons, etc. according to on-screen instructions.



- Some functions of Digital teletext are deactivated during recording.
- "Freeview Players" applies access control for some MHEG services. If you have locked viewing of Digital teletext (MHEG) (⇒ 79, Freeview Players), PIN is required to start viewing.

#### Aspect

You can switch the screen mode.

Refer to "Switching the aspect ratio of the screen". (⇒ 92)

## REWIND LIVE TV/PAUSE LIVE TV

This unit temporarily saves a live TV programme you are watching with this unit's tuner on HDD.

### REWIND LIVE TV

You can rewind live TV programme to the point where temporary save has started (up to 1.5 hours).

- REWIND LIVE TV does not work when watching a programme via external input.

### PAUSE LIVE TV

You can pause live TV programme and restart watching from the paused position.

- While watching TV  
**REWIND LIVE TV:**  
 Press [SLOW/SEARCH ◀◀] to rewind.  
**PAUSE LIVE TV:**  
 Press [PAUSE ||] to pause.
  - The maximum amount of the temporary save is 1.5 hours.
- When you want to resume:  
 Press [PLAY/× 1.3 ▶].
  - You can perform search or Quick View, etc.
  - If temporary save stops (⇒ right), playback will be performed by that point.

### Display information

While pausing or rewinding a broadcast:  
 Press [STATUS ⓘ].

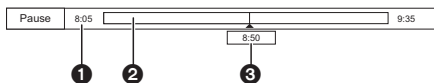

- Press [STATUS ⓘ] again.

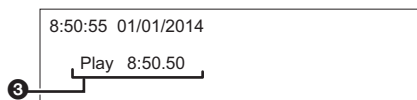

While pausing a programme via external input:  
 Press [STATUS ⓘ] twice.

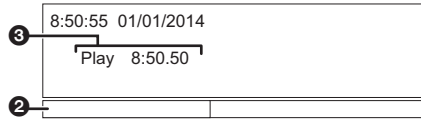

- The time that you can rewind the live programme.
- The amount of time temporarily saved on HDD.
- The time of the current playback position.

### To stop REWIND LIVE TV or PAUSE LIVE TV

- Press [STOP ■].
- Select "Yes", then press [OK].

### To hide the display information

Press [EXIT ⊗].



- The unit cannot rewind and play more than 1.5 hours prior to the current time.
- Temporary save stops in the following cases:
  - When switching to other channels or other screen
  - When recording of the watching programme is started
  - When two programmes simultaneous recording is started
  - When performing PAUSE LIVE TV or REWIND LIVE TV for more than 8 hours (This may vary depending on the HDD free space.)
- These functions do not work in the following cases:
  - When the clock is not set
  - While recording two programmes simultaneously
  - While copying
  - While watching a programme being recorded
  - When a radio programme is selected
  - REWIND LIVE TV:  
When "REWIND LIVE TV" is set to "Off" (⇒ 81)
  - PAUSE LIVE TV:  
When a timer recording via external input is started while watching a programme via external input
- PAUSE LIVE TV:  
 You can operate this unit with the TV remote control by using VIERA Link (⇒ 73).  
 Refer to the TV operating instructions.

# Recording TV programmes



- This operation will only record to built-in HDD.
- This unit can record two programmes being broadcasted at the same time.

## 1 Select the channel to record.

## 2 Press [REC MODE] and select the conversion mode, then press [OK].

- This unit will record the programmes in DR mode once, and then automatically convert to the selected recording mode while this unit is in standby.
- Recording mode (⇒ 8)

Conversion Mode Setting		
HDD Remain: ○ h ○ m (DR)	Data Size	
Off (DR)		
High Definition	HG	Large ↑ ↓ Small
	HX	
	HE	
	HL	
	HM	
Standard Definition	XP	Large ↑ ↓ Small
	SP	
	LP	
	EP	

RETURN

- The conversion mode set here is used as an initial value for the next recording.

## 3 Press [REC ●].

Recording starts.

## 4 Select "Automatic Stop", then press [OK].

### • One touch recording (OTR)

Recording stops automatically when the programme ends.

REC1/OTR	
○○○○ 8:00 - 8:45	Vacation
Automatic Stop (Guide Link) at 8:45	
Recording Time	30 min
Continuous recording	

- You can also select "Recording Time" or "Continuous recording". (⇒ right)

## To set the recording time

- 1 Select "Recording Time" or "Continuous recording" in step 4 (⇒ left).

### Recording Time:

You can set the length of recording time from 30 minutes to 4 hours.

- You can select the recording time with [◀, ▶].

### Continuous recording:

The recording is continued until you press [STOP ■].

- 2 Press [OK].

## To convert the recording mode after recording in DR mode

Refer to "File Conversion". (⇒ 44, 46)

## To confirm whether the conversion is completed

Refer to "To confirm whether the conversion is completed". (⇒ 47)

## To cancel a conversion

Refer to "To cancel a "During standby" conversion". (⇒ 47)



- One recording will terminate when simultaneous recording is being done and timer recording starts.
- Digital teletext will not be recorded.
- Following contents or media cannot be played back while recording.
  - Xvid and MKV file
  - photo
  - USB HDD (For data files, ⇒ 9) and USB memory
- Copying cannot be performed while recording.
- When "Automatic Standby after OTR" is set to "On" (⇒ 86), this unit is turned to standby mode if this unit is not operated for approximately 5 minutes after completing "Automatic Stop" or "Recording Time".
- The title before conversion (the title recorded in DR mode) will be deleted once the conversion is completed.
- Conversion will take about the same time as the recorded duration.
- When the HDD does not have enough remaining space, conversion will not start.
- Conversion is stopped when this unit is turned on. Conversion will start from the beginning again once the unit is switched to standby mode.
- The conversion will not start if the timer recording is scheduled within the time required for the conversion.
- When converted, audio content and subtitle will be converted with the same settings as at the start of recording.

## Operation during Recording

### To check the recording programme

Press [STATUS .

e.g., While recording two programmes simultaneously

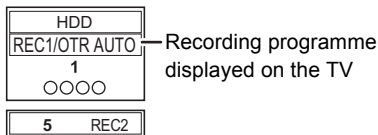

Recording programme not displayed on the TV

### To stop recording

Press [STOP .

#### When recording one programme:

If the following screen appears

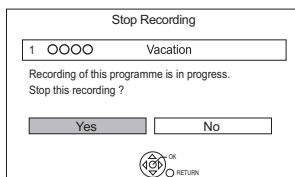

Select "Yes", then press [OK].

#### When recording two programmes:

If the following screen appears

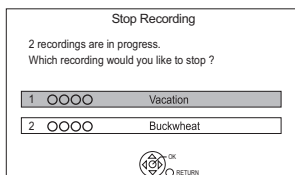

1 Select the programme, then press [OK].

2 Select "Yes", then press [OK].

### To pause recording

After displaying the recording programme, press [PAUSE .

- Press again to restart recording.  
(A title is not split into separate titles.)



- Timer recording programme cannot be paused.

### To record two programmes simultaneously

While recording, perform steps 1–4 on page 28.



- Channel or input can only be switched between the recording programmes.

### Simultaneous rec and play

You can play the recording title from the beginning or the titles previously recorded to the HDD.

1 Press [DIRECT NAVIGATOR].

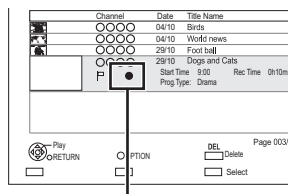

"●" is displayed on the recording programme.

2 Select the title, then press [OK].

# Timer recording



- This operation will only record to built-in HDD.
- This unit can record two programmes being broadcasted at the same time.

## Preparation

If you want to change the recording mode:  
Press [REC MODE] and select the recording mode, then press [OK].

### 1 Press [GUIDE].

TV Guide screen appears.

Preview		TUE 01/01/2014 8:05		Category: All DVB Channels	
8:00 - 9:45	SKILL workman				
1 ○○○○	SKILL workman		Penguin		
2 ○○○○	Waters	House dog		WIB	
3 ○○○○	Vacation	Hunting			
4 ○○○○	Pampas grass		News	Top run	
5 ○○○○	News	Com Shopping		Area 9T	
6 ○○○○	News		Moon		
7 ○○○○	Construction		Hippopotamus		
8 ○○○○	Great river	Mr. Otter		Dodge	

OK  RETURN  Information  Page Use  Page Down

Timer Rec.  +24 hours  Category

### 2 Select the programme, then press the red button.

The timer icon “⊕” (red) is displayed.

- If on-screen instructions are displayed, follow them.

## To use TV Guide system

Refer to “Using TV Guide system”. (⇒ 25)

## Confirm the number of active timer recording in standby mode

Press [STATUS ⊕] in standby mode.

When there are active timer recording, “1 REC” or “2 REC” displayed on the unit’s display.

## To select the programmes of a specific category

- 1 On the TV Guide screen:  
Press the blue button.
- 2 Select the item, then press [OK].
  - To return to the previous TV Guide list  
Select “All DVB Channels”.

## To edit the timer recording on the TV Guide screen

- 1 Select the programme to edit, then press the red button.
- 2 Select “Timer Rec Edit”, then press [OK].
- 3 Go to step 3 on page 32, “Manually programming timer recording”.
  - Some options cannot be changed when “Guide Link” is effective. (⇒ 31, 33)

## To cancel a timer recording on the TV Guide screen

- 1 Select the programme to cancel, then press the red button.
- 2 Select “Timer Rec Cancel”, then press [OK].  
 (“⊕” disappears)

## If the screen for selecting single or series timer recording appears

Select “Single Timer Rec.” or “Series Timer Rec.” (⇒ 31), then press [OK].

## If “Programme Selection” screen appears

Depending on the signal sent from the broadcaster, both High Definition picture programme and Standard Definition picture programme exist.

Select the programme, then press [OK].

Channel		Schedule	Contents
○○○	MON 02/01 23:00 - 0:00	3/6 Comedy-drama series about housemates who are actually aware.	
⊕○○○	TUE 03/01 23:00 - 0:00	3/6 Comedy-drama series about housemates who are actually aware...	

OK  RETURN

## If “Overlapped Timer Recording” screen appears

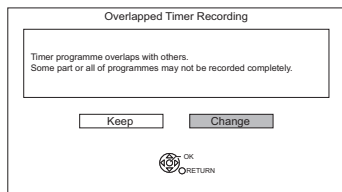

You can eliminate the overlapping or may change with repeat event for the duplicated programme.

- 1 Select “Change”, then press [OK].
- 2 Follow the on-screen instructions.

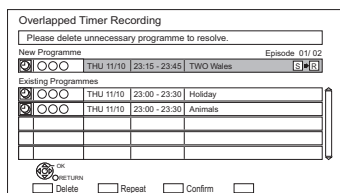

- Red: Delete programme  
 Green: Record Repeat programme  
 Yellow: Exit  
 (Overlapping is not resolved)

## Operation during Recording

Refer to “Operation during Recording”. (⇒ 29)



- This unit has several functions that enable timer recordings to be controlled by the signal sent from the broadcaster. (⇒ right) If the signal is not sent correctly, the recording may lack the beginning or the ending part of the programmes.
- Category may not be assigned correctly depending on the programme information.
- Some broadcasters may not send programme information. When programme information is not displayed correctly, use manual timer recording. (⇒ 32)
- The receipt of the TV Guide data via Set Top Box is not possible.
- When timer recording from the external equipment, use manual timer recording. (⇒ 32)
- Titles recorded using “Series Timer Rec.” are bundled and displayed as a “group” in the DIRECT NAVIGATOR screen (⇒ 36).
- If the unit cannot record the selected programme, the unit will record the repeat programme if it is available. However, this unit will not record the repeat programme, if any part of the selected programme is recorded.
- The series recording will be cancelled if there has been no episode of the series for 13 weeks.

## Various functions with Freeview

### Guide Link

The recording's start and stop times can be controlled by the broadcaster, e.g. delayed start.

- This is indicated by “Guide Link” in the Timer Recording screen (⇒ 33).
- The “Guide Link” function may not work if you manually change the start time or the stop time over 10 minutes.

### Series Timer Recording

You can record all the episodes of a series by setting just one timer recording.

- To check the schedule of the series

On the Selection Screen (⇒ 32, Recording recommended programme, step 1): Press the blue button.

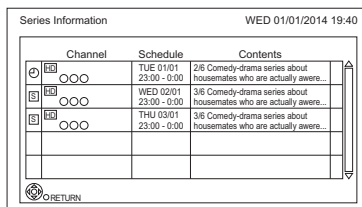

- ⊖ Programme for which you set the timer recording
- [S] The episode to be recorded
- [R] Repeat programme
- [HD] High definition programme

### Split Programme

You can record a programme separated into two or more parts by some other programmes, e.g. news.

When setting timer from the 1st split programme, other parts of the programme will be automatically set and indicated by the timer icon on the TV Guide.

- This is indicated by “Split” in the Timer Recording screen (⇒ 33).

## Timer recording

### Recording recommended programme (Recommendation Booking)

You can record a programme that the broadcaster recommends.

- On the TV Guide screen:  
Select the programme, then press [OK].

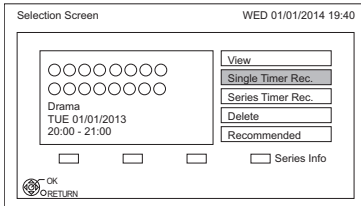

- Select "Recommended", then press [OK].

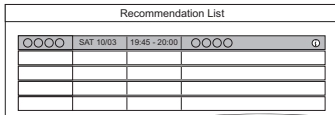

- Select the programme, then press [OK].
  - If the screen for selecting single or series timer recording, or "Programme Selection" screen appears, refer to page 30.
- Press [OK].
 

The timer icon (red) is displayed on the Recommendation List.

  - To exit from the screen  
Press [EXIT ⊗].

### To cancel the timer recording on the Recommendation List

- Select the programme with the timer icon (red), then press [OK].
- Select "Yes", then press [OK].  
(The timer icon disappears.)



- "Recommended" cannot be selected if there is no recommended programme.

### Manually programming timer recording

- Press [PROG/CHECK].

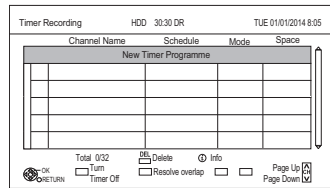

- Select "New Timer Programme", then press [OK].
- Select the items and change the items.  
(⇒ 33, Timer recording options)
- Press [OK].  
The timer programme is stored.

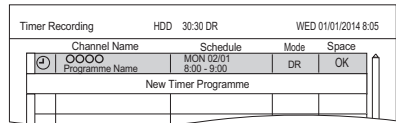

### To confirm and edit the timer programme

Refer to "To confirm and edit a timer programme".  
(⇒ 35)

### Operation during Recording

Refer to "Operation during Recording". (⇒ 29)



- When recording from the external equipment, "Mode" (recording mode) is XP, SP, LP, EP or FR.



## Timer recording options

Select the items (Channel, Day/Date, etc.) and change the settings.

e.g.,

Channel	Day/Date	Start	Stop	Mode	Conv.	Subtitles
1	TUE 01/01	8:00	9:00	DR	OFF	OFF

Title Name:  Vocation:

RETURN  AV  Date or Weekly?

### Channel

- You can select Category/AV with the red button.

### Day/Date

- You can select "Date" or "Weekly" by pressing the green button.
- Auto Renewal Recording**  
(Only daily/weekly/series timer recording)  
The unit will record the new programme over the old one.  
Press the yellow button.  
"Renew : ON" is displayed.

### Start/Stop

- Press and hold [**▲**, **▼**] to alter in 15-minute increments.

### Mode/Conv.

Refer to step 2. (⇒ 28)

### Subtitles

You can choose whether or not to record the subtitle at conversion.

(Only when item other than "OFF" is selected in "Conv.")

### Title Name

- Select "Title Name", then press [OK].
- Refer to "Entering text". (⇒ 91)

## Timer recording from channel information

You can make timer recording of the current or next programme.

- While watching a programme  
Press [STATUS ].

e.g.,

1 NEWS 10:30

9:00 - 11:00 All DVB Channels

Now Set timer Change category

MPEG STTL TEXT

- Display the channel information of a programme to record.
  - Switch the programme with [**◀**, **▶**].
  - Switch the channel with [**▲**, **▼**].
- Press the yellow button.
- Go to step 3 on page 32, "Manually programming timer recording".
  - Some options cannot be changed when "Guide Link" is effective. (⇒ 31, Guide Link)

## Timer recording

### Remote recording from outside

You can set a recording from a smartphone or a PC, etc. away from home. (You must register to a service to use this function.)

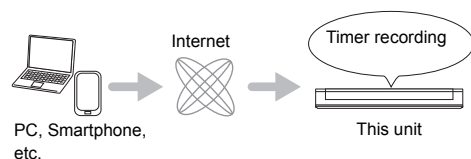

For details, please check the following website.  
<http://panasonic.jp/support/global/cs/>  
 (This site is in English only.)

### Preparation

- Network connection (⇒ 17, 21)
- Remote Recording Function Settings (⇒ 76, 85)



- This unit will always be connected to the Internet when this function is activated.
- Please note that a regular maintenance or unexpected trouble may interrupt the service, and that the service content may be changed or revoked and operation menu screens may be changed with or without a prior notice.

### Notes on timer recording

- You can enter up to 32 programmes within a month in advance. (Each daily, weekly or series programme is counted as one programme.)
- When the programme recorded in DR mode is converted, the audio content and subtitle language will be selected according to the following settings:
  - "Multi Audio" and "Audio Description" of "Preferred Multi Audio" (⇒ 79)
  - "Subtitles" of "Preferred Subtitles" (⇒ 79)
  - Audio for HG / HX / HE / HL / HM Recording (⇒ 82)
- Even if you switch the unit to standby mode during the timer recording, the recording is continued.
- When you programme successive timer recordings to start, about last 1 minute of earlier programme will not be recorded.
- Timer recording will not start while:
  - copying a title in high speed mode [with finalising or creating Top Menu (**+RW**)]
  - copying a title in normal speed mode
  - converting a title in "File Conversion" (Only when "Now" is selected)
  - copying HD Video (AVCHD) from USB device or SD card
  - copying photos/music
  - formatting
  - finalising/creating Top Menu
- When "Pure Sound mode" is activated, timer recording does not start during playback of BD-Video, DVD-Video or music CD. (⇒ 80)

## To confirm and edit a timer programme

### 1 Press [PROG/CHECK].

e.g.,

Timer Recording		HDD	30:30 DR	TUE 01/01/2014 8:05
Channel Name	Schedule	Mode	Space	OK
Work news	TUE 08/01 11:00 - 11:45	DR	OK	
Football	TUE 08/01 10:00 - 11:50	DR →HG	OK	
Sport	TUE 08/01 11:30 - 1:00	DR	OK	1
Dogs and cats	TUE 01/01 8:30 - 10:45	DR	OK	
New Timer Programme				
Total 3/32				
OK	Turn Off	Delete	Info	Page Up
RETURN	Resolve overlap	OK	Page Down	OK

### 2 Select the programme, then perform the operations.

#### To deactivate a timer programme

Press the red button.

- The timer icon “⊖” will change from red to grey.
- Press the red button again to activate timer recording standby. (The timer icon “⊖” will change to red.)

#### To delete a timer programme

Press [DEL].

#### To edit a timer programme

- 1 Press [OK].
- 2 Change the timer recording options.
  - Refer to “Timer recording options”. (⇒ 33)
- 3 Press [OK].

#### To show programme information

Press [STATUS ⊕].

#### To exit the timer recording list

Press [EXIT ⊗].



- “No Data” is displayed on a series recording item if there will be no episode of the series for the next 8 days. We recommend you delete the “No Data” item after you confirm the last episode of the series is recorded.

## Screen icons

- ⊖ Red: Timer recording standby is activated. Grey: Timer recording standby is deactivated.

### Currently recording programme



A part or all of the programme will not be recorded since the programme is overlapping.

- Programme overlapping can be resolved with repeat programme if available. Select the programme, then press the green button.

(⇒ 31, If “Overlapped Timer Recording” screen appears)



- This function is not available for the timer programmes that were set manually.



The HDD is full.



Copy-protected programme  
It was not recorded.



The recording of the programme was not completed because of some reason.



Auto Renewal Recording is set. (⇒ 33)



Guide Link (⇒ 31)



Split Programme (⇒ 31)



Series Timer Recording (⇒ 31)



Displayed if the recording can fit in the remaining space





Daily or weekly timer programme is set.

(Date)



- It may not be possible to record because:
- there is not enough space left.
  - the number of possible titles has reached its maximum. (⇒ 106)
  - programmes are deactivated, etc.

# Playing titles on the HDD



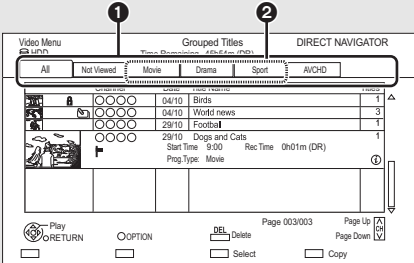

\* "For recorded titles (⇒ 9)" only

- 1** Press [FUNCTION MENU].
- 2** Select "Video" in "Contents on HDD", then press [OK].  
e.g.,

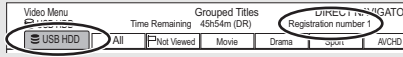

- 1** Tab (⇒ 37)
- 2** Programme type
  - **USB HDD** When connecting registered USB HDD, "USB HDD" tab and registration number appears. Select "USB HDD" tab.  
e.g.,



- 3** Select the title, then press [OK].  
Playback starts.





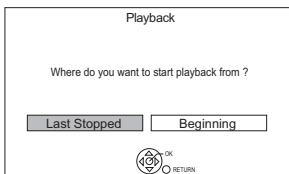









## Resume play function

If the following screen appears, select the point to start playback.



## DIRECT NAVIGATOR screen

### Screen icons

-  Currently recording programme
-  Protected title
-  Title was not recorded due to recording protection
-  Title cannot be played  
(When data is damaged etc.)
-  Grouped titles
-  Title has not yet been played
-  Title is recorded using a different encoding system from that of the unit.
-  Change the "TV System" (⇒ 76, 83).
-  Radio programme
-  3D contents
  - This icon will not display even with 3D programmes when a broadcast programme is recorded.
-  Recorded in 1080/50p contents
-  Recorded in 1080/60p contents
-  This icon is displayed with the following titles when "Child Lock" is set to "On". (⇒ 80)
  - Title with Guidance information
  - Title restricted by Child Lock List (⇒ 79)
  - PIN is required to play.
-  Title has been recorded in Series timer recording.
-  Title has been recorded in Series timer recording and has not yet been played.



Titles cannot be copied to the disc in high definition quality mode (DR, HG, HX, HE, HL, HM) any more.



Titles can be copied to the disc in high definition quality mode (DR, HG, HX, HE, HL, HM) once.



Recording did not complete as the timer recording has started.



Title cannot be played from DLNA client not compatible with DTCP-IP (⇒ 64)

## Tab

Titles will be categorised automatically. You can quickly find the recorded titles by selecting the tab.

### To select the tab

Press [◀, ▶].

### To change the displayed programme type tab

- 1 Select the programme type, then press the green button.
- 2 Select the item, then press [OK].

## Showing Information

Select the title, then press [STATUS ⓘ].

## Switching the appearance

- 1 Press [OPTION].
- 2 Select "Grouped Titles" or "All Titles", then press [OK].

### Grouped Titles:

Two or more titles recorded in the daily/weekly/series timer recording mode are bundled and displayed as one item.

### All Titles:

Displays all titles.

## Playing back grouped titles

- 1 On the Grouped Titles screen: Select the item marked with .
- 2 **When playing all titles:** Press [PLAY/× 1.3 ▶].

### When playing the individual title:

Press [OK] and select the title, then press [OK].

## Playing titles on the HDD

### Editing the grouped titles

- 1 Select the title or the group, then press the yellow button.
  - A check mark is displayed. Repeat this step.
    - Press the yellow button again to cancel.
    - If you perform "Remove", select the title in the group.
- 2 Press [OPTION].
- 3 Select the item, then press [OK].
 

**Create Group:**  
Selected titles are bundled to form a group. Select "Create", then press [OK].

**Release Grouping:**  
All the titles in the group are released. Select "Release", then press [OK].

**Remove:**  
Selected titles are removed from the group. Select "Remove", then press [OK].

### Changing the group name

- 1 Select the group, then press [OPTION].
- 2 Select "Edit", then press [OK].
- 3 Select "Enter Title Name", then press [OK].
- 4 Refer to "Entering text". (⇒ 91)

### Playback from Chapter View

#### Regarding chapters

You can divide a title into multiple chapters. Each section between the division points (Chapter Marks) becomes a chapter.

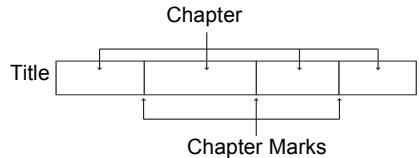

#### • Chapter Creation

This unit can create chapters automatically while recording broadcasting. (⇒ 81)

- 1 Select the title, then press [OPTION].
- 2 Select "Chapter View", then press [OK].  
e.g., **HDD**

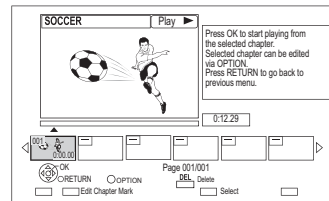

- 3 Select the chapter, then press [OK].

#### To edit the chapter in Chapter View

Refer to "Editing chapters". (⇒ 47)

# Playing titles on the media



\* "For data files (⇒ 9)" only

- 1 Insert the media.**  
Depending on the type of the media, play starts from the specified position, or the screen appears.
  - AVCHD: If the menu screen is not displayed  
Press [PLAY/× 1.3 ▶].
- 2** When the DIRECT NAVIGATOR screen or menu screen etc., appears:  
**Select the item or title, then press [OK].**
  - Repeat this step if necessary.
 Playback starts.

## To play back the playlist created on other equipment

- 1 Press [FUNCTION MENU].
- 2 Select "Disc" in "Media", then press [OK].
- 3 Select "Playlists", then press [OK].
- 4 Select the playlist, then press [OK].



- **BD-V** You cannot play back while recording from external equipment. Also, playback stops when the timer recording starts from external equipment.
- Some files may not be played back, depending on the video resolution and frame rate condition.

## Menu screen

Selecting screen for each operation is displayed when the media is inserted, and you can access the operation screen easily.

e.g., **USB**

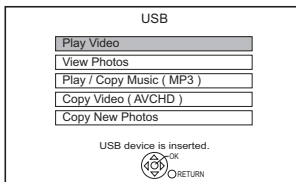

- Display items differ depending on what is recorded in each media.

## If the menu screen is not displayed, display it by performing the following operation.

- 1 While stopped  
Press [FUNCTION MENU].
- 2 Select "Media", then press [OK].
- 3 Select the media, then press [OK].

## Video list screen

e.g.,

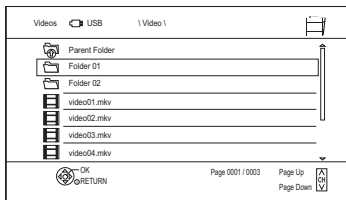

### Screen icons:



Folder



Titles



Move to the parent folder

## Playing titles on the media

### DIRECT NAVIGATOR screen

e.g.,

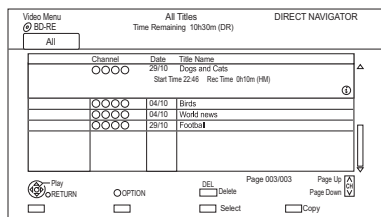

#### Showing Information

Select the title, then press [STATUS ①].

#### Playback from Chapter View

- 1 Select the title, then press [OPTION].
- 2 Select "Chapter View", then press [OK].
- 3 Select the chapter, then press [OK].

• Regarding chapters

Refer to "Regarding chapters". (⇒ 38)

### Video Menu ( AVCHD ) screen

**SD**

e.g.,

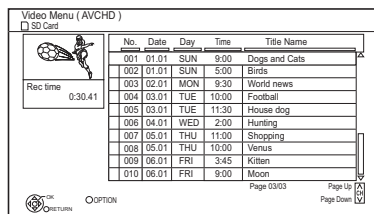

#### Showing Information

- 1 Select the title, then press [OPTION].
- 2 Select "Information", then press [OK].

#### About screen icons

Refer to "Screen icons". (⇒ 36)

### Notes for BD-Live discs

#### BD-V

BD-Live allows you to enjoy more functions such as subtitles, exclusive images and online games by connecting this unit to the Internet.

#### Preparation

- 1 Perform network connection and settings. (⇒ 17, 21)
- 2 Insert a disc.

**For the playback method, refer to the instructions for the disc.**

#### Delete BD-Video data

If you no longer need BD-Live data recorded on the built-in HDD, you can delete data with the following operation.

- 1 Press [FUNCTION MENU].
- 2 Select "BD-Video Data Management" in "Setup", then press [OK].
- 3 Select "Delete BD-Video data", then press [OK].
- 4 Select "Yes", then press [OK].
- 5 Select "Start", then press [OK].
- 6 Press [OK].



- The usable functions and the operating method may vary with each disc, please refer to the instructions on the disc.
- You can restrict Internet access when BD-Live functions are used (⇒ 76, 80, BD-Live).
- When "Pure Sound mode" is set to "On", this unit cannot use BD-Live functions. (⇒ 80)



# Operation during play

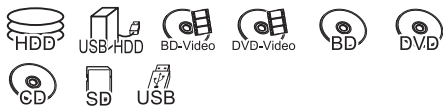

- Depending on the media and the type of file, some operations may not be possible.
- Depending on the media, it may take time for the menu screen, pictures, sound, etc. to start.
- Discs continue to rotate while menus are displayed. Press [STOP ■] when you have finished playback to protect the unit's motor, your TV screen, etc.

## General operations

### Status messages

Press [STATUS Ⓢ] twice.

e.g.,

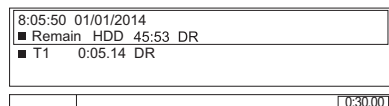

### Stop

Press [STOP ■].

### Resume play function

Press [PLAY/× 1.3 ▶] to restart from the stopped position.



- **Discs:** Only previous stopped position is memorized. The position may be cleared if the tray is opened or the unit is switched to standby mode.

### Quick View

Press and hold [PLAY/× 1.3 ▶].

- Press again to return to normal speed.



- **Xvid, MKV, MP4 and MPEG2:** Quick View is not effective.
- Quick View is not effective when playing back the DVD-RW disc.
- Quick View may not work when recording in XP or FR mode.

### Search

Press [SLOW/SEARCH ◀◀] or [SLOW/SEARCH ▶▶].

- Press [PLAY/× 1.3 ▶] to restart play.



- The speed increases up to 5 steps.  
(+R) (+RW): Up to 3 steps)
- **Xvid, MKV, MP4 and MPEG2:** Audio is not heard during all levels search.

### Pause

Press [PAUSE ⏸].

- Press [PLAY/× 1.3 ▶] to restart play.

### Slow-motion

While paused, press [SLOW/SEARCH ◀◀] or [SLOW/SEARCH ▶▶].

- Press [PLAY/× 1.3 ▶] to restart play.



- The speed increases up to 5 steps.
- **Xvid, MKV, MP4 and MPEG2:** Slow-motion is not effective.
- **BD-V, AVCHD (DVD-R SD):** Forward direction [SLOW/SEARCH ▶▶] only.

### Frame-by-frame

While paused, press [◀] (◀◀) or [▶] (▶▶).

- Each press shows the next frame.
- Press and hold to change in succession forward or backward.
- Press [PLAY/× 1.3 ▶] to restart play.



- **Xvid, MKV, MP4 and MPEG2:** Frame-by-frame is not effective.
- **BD-V, AVCHD (DVD-R SD):** Forward direction [▶] (▶▶) only.

## Operation during play

### Manual Skip

#### Skip forward 1 minute:

Press [MANUAL SKIP +60s].

#### Skip backward 10 seconds:

Press [MANUAL SKIP -10s].



- **Xvid and MKV:** Manual Skip is not effective.

### To display menu

**HDD** **DVD-V**

- 1 Press [OPTION].
- 2 Select "Playback Menu", then press [OK].
- 3 Select "Top Menu", "Pop-up Menu" or "Menu", then press [OK].

### Skipping the title or chapter

Press [SKIP ◀◀] or [SKIP ▶▶].



- **HDD** **USB HDD** (For recorded titles, ⇨ 9): It will not skip the title. But the title in the grouped titles will be skipped. (⇨ 37)

### To create Chapter Marks

**HDD** **USB HDD** (For recorded titles, ⇨ 9)

**BD-RE** **BD-R** **RAM**

During the playback or pause  
Press [CHAPTER].

### To delete the Chapter Mark

**HDD** **USB HDD** (For recorded titles, ⇨ 9)

**BD-RE** **BD-R** **RAM**

- 1 While paused  
Press [SKIP ◀◀] or [SKIP ▶▶] and skip to the location you want to delete.
- 2 Press [CHAPTER].
- 3 Select "Yes", then press [OK].

### Changing audio

Select the desired audio with "Multi Audio" in the Basic Operation menu (⇨ 74).

### Switching subtitles

**HDD** **USB HDD** (For recorded titles, ⇨ 9)

**BD-RE** **BD-R**:

- 1 Press [STTL ].
  - 2 Press [OK].
  - 3 Select "On" or "Off", then press [OK].
- If you want to switch the subtitle language, select it in the Basic Operation menu (⇨ 74).

**BD-V** **DVD-V**, **Xvid and MKV**:

Display with "Subtitle Settings" in the Basic Operation menu (⇨ 74).

### Listening to the Audio Description

**HDD** **USB HDD** (For recorded titles, ⇨ 9)

**BD-RE** **BD-R**

- 1 Press [AD].
- 2 Select "Audio Description" and set to "Automatic".
- 3 Select "Volume", then adjust the volume with [◀, ▶].



- When "Dolby D / Dolby D + / Dolby TrueHD", "MPEG" or "HE-AAC" is set to "Bitstream", the Audio Description may not work. Set them to "PCM" (⇨ 82, Digital Audio Output).
- You can also set "Audio Description" active in the Setup menu. (⇨ 79)

### Aspect

You can switch the screen mode.

Refer to "Switching the aspect ratio of the screen". (⇨ 92)

## 3D video playback

### Preparation

Connect 3D compatible TV to this unit. (⇒ 14)

- Perform the necessary preparations for the TV.

### Play back following the instructions displayed on the screen.

### Preparatory 3D settings

Perform the following settings as necessary.

#### 3D BD-Video Playback

It is also possible to play back 3D discs in 2D (conventional video). (⇒ 76, 80)

#### 3D Type

If 3D video cannot be played back in 3D, you may be able to play it in 3D by changing the setting. (⇒ 76, 83)

#### 3D AVCHD Output

If 2D AVCHD video is recognised as 3D video and cannot be played back correctly, you may be able to play it by changing the setting. (⇒ 76, 83)

#### 3D Playback Message

Hide the 3D viewing warning screen. (⇒ 76, 83)

### 3D settings during playback

Change this setting when the screen is not correctly displayed for 3D compatible programmes.

- 1 Press [OPTION].
- 2 Select "Playback Settings" in "Playback Menu", then press [OK].
- 3 Select "3D Settings", then press [OK].
- 4 Select the item, then press [OK].

### Signal Format

- Original:  
Keep original picture format.
- Side by side:  
3D picture format comprising of left and right screens.
- 2D to 3D:  
Converts 2D pictures to 3D effect while playing.

### 3D Picture Mode

- Normal:  
Normal 3D effects.
- Soft:  
Soft 3D effects.
  - This function cannot be enabled when "Signal Format" is set to "2D to 3D".
- Manual:  
3D effects set manually (⇒ below)

### Manual Settings

(To change the setting, set "3D Picture Mode" to "Manual".)

#### Distance

Set the amount of depth perception.

#### Screen Type

Selects how the screen appears during 3D playback (flat or round).

#### Frame Width

Set the amount of feathering at the edge of screen.

#### Frame Colour

Set the colour of feathering at the edge of screen.

### Graphic Display Level

Adjust the 3D position for the playback menu or message screen etc. (⇒ 75)



- Depending on the contents, displayed items are different.
- This unit only guarantees the playback of the Frame Sequential and the Side-by-Side (Half) programme types.
- Please refrain from viewing 3D images if you do not feel well or are experiencing visual fatigue.  
In the event that you experience dizziness, nausea, or other discomfort while viewing 3D images, discontinue use and rest your eyes.
- Depending on the connected TV, the video being played back might switch to 2D video due to changes in resolution etc. Check the 3D setting on the TV.
- 3D video might not output the way it is set in "HDMI Video Format" (⇒ 83) and "24p Output" (⇒ 84).
- It may display as Side-by-Side when playback of the 3D video is started.

# Deleting/Editing recorded titles

Once deleted, divided or partially deleted, recorded content cannot be restored to its original state. Make certain before proceeding.



\* "For recorded titles (⇒ 9)" only



- If the disc is protected, release the protection. (⇒ 89, Disc Protection)
- Depending on the media and the type of file, some operations may not be possible.
- PIN is required to edit the titles with **G** in some functions. (⇒ 36)

## Deleting

- 1 On the DIRECT NAVIGATOR screen: Select the title.

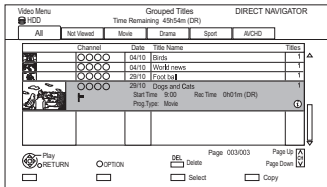

- 2 Press [DEL].
- 3 Select "Delete", then press [OK].

### Multiple deleting

Select the title, then press the yellow button in step 1.

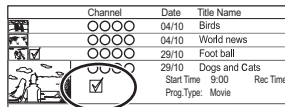

- A check mark is displayed. Repeat this step.
- Press the yellow button again to cancel.

### Deleting during play

- 1 Press [DEL] while playing.
- 2 Select "Delete", then press [OK].

### Available disc space after deleting

- **HDD** **USB HDD** **BD-RE** **RAM**

The space deleted becomes available for recording.

- **BD-R** **DVD-R** **+R**

Available space does not increase even after the contents are deleted.

- **DVD-RW** **+RW**

Available recording space increases only when the last recorded title is deleted.



- Even after deletion is completed, it may take time until the updated available space is displayed.

## Editing

- 1 On the DIRECT NAVIGATOR screen: Select the title.
- 2 Press [OPTION].
- 3 Select the item, then press [OK].  
e.g.,

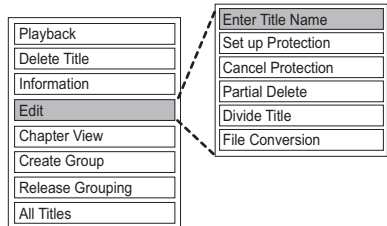

- "Edit" has several functions.

### Multiple editing

Select the title, then press the yellow button in step 1.

- A check mark is displayed. Repeat this step.
- Press the yellow button again to cancel.

## Deleting

- 1 Select "Delete Title", then press [OK].
- 2 Select "Delete", then press [OK].



## Entering title name

- 1 Select "Enter Title Name" in "Edit", then press [OK].
- 2 Refer to "Entering text". (⇒ 91)

## Setting protection

**HDD** **USB HDD** **BD-RE** **BD-R** **RAM** **+R** **+RW**

Protection setting prevents the title from accidental deletion.

All	Not Viewed	Movie	Drama
	○○○○	04/10	Birds
	○○○○	04/10	World news
	○○○○	29/10	Football
	○○○○	29/10	Dogs and Cats
		Start Time 9:00	Rec.T
		Prog.Type: Movie	

- 1 Select "Set up Protection" or "Cancel Protection" in "Edit", then press [OK].
  - 2 Select "Yes", then press [OK].
-  appears when setting the protection.

## Partial deleting

**HDD** **USB HDD** **BD-RE** **BD-R** **RAM**

- 1 Select "Partial Delete" in "Edit", then press [OK].
- 2 Press [OK] at the start point and end point to delete.
  - You can find the desired point by using play, search, etc. (⇒ 41)
- 3 Select "Continue", then press [OK].
  - Select "Next", then press [OK] to delete other sections. Up to 20 sections can be set. (⇒ go to step 2)
- 4 Select "Delete", then press [OK].
  - Chapter Mark is generated in the scene that was partially deleted.
- 5 Press [BACK/RETURN ⊖].

## Dividing title

**HDD** **USB HDD** **BD-RE** **BD-R** **RAM**

- 1 Select "Divide Title" in "Edit", then press [OK].
- 2 Press [OK] at the point to divide the title.
  - You can find the desired point by using play, search, etc. (⇒ 41)
- 3 Select "Continue", then press [OK].
- 4 Select "Divide", then press [OK].

### To confirm the division point

After performing step 2.

Select "Preview", then press [OK].

- The unit plays 10 seconds before and after the division point.

### To change the division point

After performing step 2.

Restart play and select "Divide", then press [OK] at the division point.



- **HDD** **USB HDD** Divided titles will become a group of titles.

## Deleting/Editing recorded titles

### File Conversion

**HDD** **USB HDD**

File Conversion is a function to convert the recording mode of the title in DR mode and AVCHD contents. The size of the converted title will be small regularly. It will take about the same time as the recorded duration.

- 1 Select "File Conversion" in "Edit", then press [OK].

e.g.,

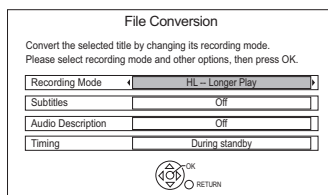

- 2 Set the conversion options, then press [OK].

#### Recording Mode (⇒ 8):

- **USB HDD** You cannot select XP, SP, LP and EP mode.

#### Subtitles:

##### • Automatic

Subtitles will be recorded if they are included in the title, and will not be recorded if they are not included.

##### • Off

Subtitle will not be recorded.

#### Audio Description:

##### • Automatic

Audio Description will be recorded if they are included in the title, and will not be recorded if they are not included.

##### • Off

Audio Description will not be recorded.

#### Timing:

##### • Now

Conversion begins immediately after step 4.

- Timer recording will not be performed during conversion.

##### • During standby

Conversion will be performed after the unit is switched to standby mode.

- 3 Select the item, then press [OK].



#### Convert & Delete:

The original title will be deleted to save HDD capacity after conversion.

#### Convert Only:

The original title remains after conversion.

- When converting to HG, HX, HE, HL or HM mode, if the selected title is indicated with

 or , you cannot select "Convert Only". (⇒ 37)

- 4 "Now" conversion:

Select "Start", then press [OK].

#### "During standby" conversion:

Press [OK].

Conversion will be performed after the unit is switched to standby mode.

"COPY" or "CONV" on the unit's display remains lighted during conversion.

### To cancel a “Now” conversion

Press and hold [BACK/RETURN ⊖] for more than 3 seconds.

### To confirm whether the conversion is completed

Press [DIRECT NAVIGATOR].

e.g.,

Channel	Date	Title Name	Titles
○○○○	04/10	Birds	1
○○○○	04/10	World news	1
○○○○	29/10	Football	1
○○○○	29/10	Dogs and Cats	1
	Start Time 9:00	Rec Tit 1h00m (DR→HL)	
	Prog.Type: Movie		

When “○○ → ○○ (Recording mode for conversion)” is displayed, the conversion has not finished.

### To cancel a “During standby” conversion

After performing steps 1–3 (⇒ 44, Editing)

- 1 Select “File Conversion” in “Edit”, then press [OK].
- 2 Select “Yes”, then press [OK].



- To use “File Conversion”, the HDD needs enough storage capacity.
- The size of converted title might increase depending on the title.
- File Conversion is stopped when this unit is turned on during performing “During standby” conversion. Conversion will start from the beginning again once the unit is switched to standby mode.
- When converted, the audio content and subtitle language will be selected according to the following settings:
  - “Multi Audio” of “Preferred Multi Audio” (⇒ 79)
  - “Subtitles” of “Preferred Subtitles” (⇒ 79)
  - Audio for HG / HX / HE / HL / HM Recording (⇒ 82)
- When converted, 3D information may not be retained.
- In titles with the Auto Renewal Recording function (⇒ 33) set, a programme may be unintentionally converted while in “During standby”.

## Editing chapters

**HDD** **USB HDD** **BD-RE** **BD-R** **RAM**

- 1 Select “Chapter View”, then press [OK].
- 2 Perform the editing operations.

### Edit Chapter Mark:

Select the point where you want to start a new chapter while viewing the title.

- 1 Press the green button.
- 2 Press [OK] at the point you want to divide.
  - Repeat this step.
- 3 Press [BACK/RETURN ⊖] to go to Chapter View screen.

### To delete the chapter:

- 1 Select the chapter, then press [DEL].

#### Multiple editing

Select the chapter, then press the yellow button.

A check mark is displayed. Repeat this step.

- Press the yellow button again to cancel.
- 2 Select “Delete”, then press [OK].

### To combine chapters (Delete chapter mark):

- 1 Select the chapter, then press [OPTION].
- 2 Select “Combine Chapters”, then press [OK].
- 3 Select “Combine”, then press [OK].
 

The selected chapter is combined to the next chapter.

## Playback from Chapter View

Refer to “Playback from Chapter View”. (⇒ 38)



- The maximum number of chapters: (Depends on the state of recording.)
  - HDD** **USB HDD**: Approx. 1000 per title
  - BD-RE** **BD-R** **RAM**: Approx. 1000 per disc
- **HDD** **USB HDD** When the title has the maximum number of chapters, you cannot perform the Resume play function (⇒ 36) with the title.

# Copying titles

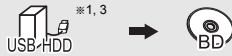

- \*1 "For recorded titles (⇒ 9)" only
- \*2 The title in the source media will be deleted.
- \*3 The recording mode cannot be changed.

- 1** Insert or connect the media.
- 2** Press [FUNCTION MENU].
- 3** Select "Video" in "Contents on HDD", then press [OK].
- 4** Select the title, then press the yellow button.  
A check mark is displayed. Repeat this step.

Channel	Date	Title Name
	○○○○	04/10 Birds
	○○○○	04/10 World news
	○○○○	29/10 Foot ball
	○○○○	29/10 Dogs and Cats
	Start Time	9:00 Rec Time
	Prog.Type	Movie

- Press the yellow button again to cancel.

- 5** Press the blue button.
- 6** Set the copy direction, then press [OK].
- 7** Select "Yes", then press [OK].
  - If you select "No", you can change the selection. (⇒ 49, To change the selection)

## 8 Set other settings, then press [OK].

e.g.,

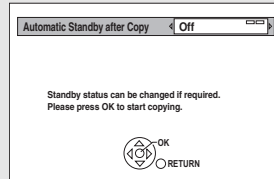

(⇒ 49, Setting the copying options)

## 9 Select "Yes", then press [OK].

### To register the external HDD (USB HDD)

Refer to "Registering the USB HDD". (⇒ 72)

### To copy HD Video (AVCHD) to the DVD-R in High Definition

Refer to "Copying HD Video (AVCHD) to the DVD-R in High Definition". (⇒ 55)

### Release the disc protection

Refer to "Disc Protection". (⇒ 89)



- If you wish to choose the audio language, select the language from "Multi Audio" of "Preferred Multi Audio" before copying (⇒ 79).
- Simultaneous operation is not possible while copying with finalising or creating Top Menu. However, the titles on the HDD can be played back while high speed copying without finalising or creating Top Menu.



## To change the selection

- 1 Select "No", then press [OK] in step 7 (⇒ 48).  
e.g., **HDD** → **BD-RE**

The order of copying

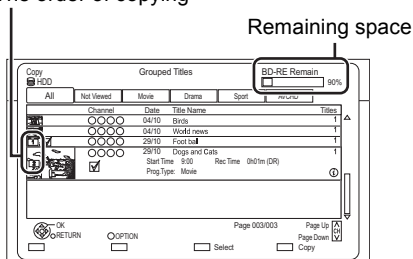

## 2 To change the selected titles:

Select the title, then press the yellow button.  
Repeat this step to select titles.

To change the picture quality:

**HDD** → **BD-RE** **BD-R** **RAM** **DVD-R** **DVD-RW**  
**+R** **+RW**

- 1 Select the title, then press [OPTION].
  - 2 Select "Conversion Select", then press [OK].
  - 3 Select the picture quality, then press [OK].  
Repeat steps if necessary.
- 3 Press the blue button.
  - 4 Go to step 7. (⇒ 48)

## Screen icons



Titles that will be copied to the disc  
in normal speed



Titles that cannot be copied



Titles that will be moved to the disc

- The title in the source media will be deleted.

## About screen icons on the DIRECT NAVIGATOR

Refer to "Screen icons". (⇒ 36)

## Setting the copying options

- 1 Select the item in step 8 (⇒ 48).
- 2 Press [◀, ▶] to change the settings.

### • Automatic Standby after Copy

**On:**

This unit is turned to standby mode when it is not operated for approximately 5 minutes after completing copy.

### • Subtitles

**Automatic:**

Subtitles will be recorded if they are included in the title.



- If you wish to choose the subtitle, select the language from "Subtitles" of "Preferred Subtitles" before copying (⇒ 79).

### • Audio Description

**Automatic:**

Audio Description will be recorded if they are included in the title, and will not be recorded if they are not included.

### • Finalise

**On:**

**DVD-R** **DVD-RW** **+R** The discs become play-only and you can also play them on other DVD equipment.

### • Create Top Menu

**On:**

**+RW** You can play the disc on other DVD equipment.



- You can perform "Finalise" (⇒ 91) or "Create Top Menu" (⇒ 90) later.

## Copying titles

### Copying from media other than HDD with DIRECT NAVIGATOR

**BD-RE** **BD-R** **RAM** **+RW** → **HDD**

- 1** Insert a disc.  
The menu screen appears. (⇒ 39)
- 2** Select “Play Video”, then press [OK].
- 3** Select the title, then press the yellow button.  
A check mark is displayed. Repeat this step.

Channel	Date	Title Name
○○○○	04/10	Birds
○○○○	04/10	World news
☑○○○	29/10	Foot ball
○○○○	29/10	Dogs and Cats
○○○○	Start Time 0:00	Rec Time 0h30m

- 4** Press the blue button.

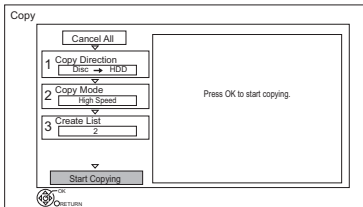

- To change the detailed settings for copy, refer to “Copying titles with copying list”. (⇒ right)

- 5** Select “Start Copying”, then press [OK].
- 6** Select “Yes”, then press [OK].

### Copying titles with copying list

**HDD** ↔ **USB HDD** ※1, 2, 3

**HDD** → **BD-RE** **BD-R** **RAM** **DVD-R**  
**DVD-RW** **+R** **+RW**

**USB HDD** ※1, 3 → **BD-RE** **BD-R**

**BD-RE** **BD-R** → **HDD**  
**RAM** **+RW**

- ※1 “For recorded titles (⇒ 9)” only
- ※2 The title in the source media will be deleted.
- ※3 The recording mode cannot be changed.

- 1** **HDD** ↔ **USB HDD**:  
1 Press [FUNCTION MENU].  
2 Select “Copy Menu” in “Copy Video”, then press [OK].

**Except “HDD ↔ USB HDD”:**

- 1 Insert a disc.  
The menu screen appears. (⇒ 39)
- 2 Select “Copy”, then press [OK].

- 2** Set the copy direction.  
1 Select “Copy Direction”, then press [▶] (right).  
2 Set “Source” and “Destination”.  
3 Press [◀].

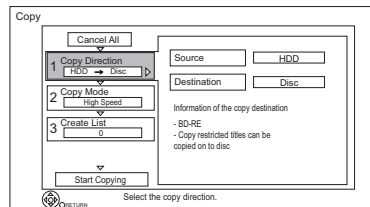

- 3** Set the recording mode (⇒ 8).  
1 Select “Copy Mode”, then press [▶] (right).  
2 Set “Recording Mode”.  
3 Press [◀].

## 4 Register titles for copy.

- 1 Select "Create List", then press **[▶]** (right).
- 2 Select "New item", then press **[OK]**.
- 3 Select the title, then press the yellow button.

Repeat this step to select titles.

e.g., **[HDD]**

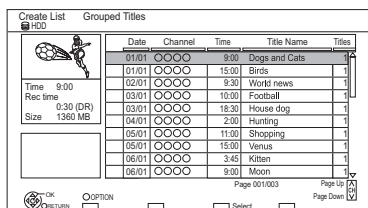

### • To change the appearance of the list or show information of the title

- 1 Press **[OPTION]**.
- 2 Select the item, then press **[OK]**.



- The titles will be copied in the order of the copying list. If you want to specify the order, edit the copying list after the titles are selected. (⇒ 52, Editing the copying list)

4 Press **[OK]**.

5 Press **[◀]**.

Data size of each registered title

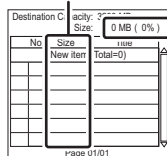

### Size:

Data size recorded to the copy destination

## 5 Make other settings.

- 1 Select "Other Settings", then press **[▶]** (right).

e.g.,

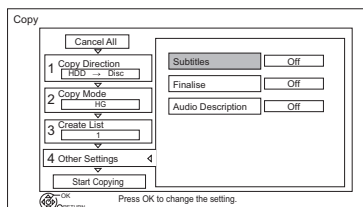

- This screen does not appear depending on the copying mode. (⇒ go to step 6)

- 2 Select the copying option, then press **[OK]**. (⇒ 49, Setting the copying options)
- 3 Select the item, then press **[OK]**.
- 4 Press **[◀]**.

## 6 Select "Start Copying", then press **[OK]**.

## 7 Select "Yes", then press **[OK]**.

### To cancel all registered copying settings and lists

After performing step 1

- 1 Select "Cancel All", then press **[OK]**.
- 2 Select "Yes", then press **[OK]**.



- If you wish to choose the audio language, select the language from "Multi Audio" of "Preferred Multi Audio" before copying (⇒ 79).
- Titles in the grouped titles and other titles cannot be registered simultaneously.

## Copying titles

### Editing the copying list

- 1 Select the title after step 4-4 (⇒ 51).

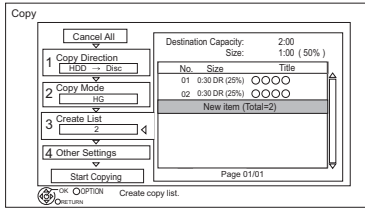

- 2 Press [OPTION].
- 3 Select the item, then press [OK].

#### Delete All:

All titles that you registered to copy are deleted.

Select "Yes", then press [OK].

#### Add:

Add new items to the copying list.

- 1 Select the titles with the yellow button.
- 2 Press [OK].

#### Delete:

Selected titles are deleted.

- Select the title, then press the yellow button before step 2.
  - Repeat this step to select titles.
- Select "Yes", then press [OK].

#### Move:

Change the order of items on the copying list.

- Select the title to move before step 2.
- Select the destination, then press [OK].



- When copying at normal speed, the total data size will change according to the recording mode.
- The total data size shown may be larger than the sum of the data sizes for each registered item.

### Screen icons



Titles that cannot be copied in high speed mode



Titles that cannot be copied



Titles that will be moved to the disc

- The title in the source media will be deleted.



Title contains photos

- Photos cannot be copied.



**(NTSC)** Title recorded using a different encoding system from that of the unit.



**(PAL)** Titles displaying these marks cannot be selected.

### About other screen icons























Refer to "Screen icons". (⇒ 36)

## Notes for copying

### Notes for high speed copy

High Speed Copying is the process of copying a title to disc in high speed while maintaining the original record mode and recording length. If any conversion is required during the copy process, the copying will be done at normal speed.

- The following recording mode and media combinations support high speed copying.

Original title's recording mode	Media
DR	 ↔ 
HG	 ↔ 
HX	 ↔ 
HE	 ↔ 
HL	 → 
HM	 → 
XP	 → 
SP	 ↔ 
LP	 ↔ 
EP	 * → 
FR	 * → 

\* DVD-RAM only

- Converting the recording mode will result in a normal speed copy.
- High speed copy is possible only when there is enough recording capacity on the destination media.



- It is impossible to copy at high speed in the following cases:

- HDD** → **BD-RE** **BD-R** :
  - Copying radio programmes
- HDD** → **DVD-R** **DVD-RW** **+R** **+RW** :
  - Titles that contain many deleted segments
- HDD** → **+R** **+RW** :
  - Titles recorded in "EP" mode and "FR (recordings 5 hours or longer)" mode
  - Titles recorded in 16:9 aspect
- HDD** → **DVD-R** **DVD-RW** :
  - Titles recorded via AV input in 16:9 aspect using "EP" mode or "FR (recordings 5 hours or longer)" mode

### Notes for normal speed copy

- DVD-R** **DVD-RW** **+R** **+RW** You cannot copy to the disc in the following cases.
  - When there is not enough free space on the HDD.
  - When the number of titles recorded to the HDD and the number of titles to be copied to the disc is greater than 999 in total.
- Copying will continue up to the point cancelled.
  - DVD-R** **DVD-RW** **+R** **+RW** If copy is cancelled during the step while temporarily copying to the HDD, then nothing will be copied.
  - BD-R** **DVD-R** **DVD-RW** **+R** **+RW** Even if the title was not copied to the disc, the amount of remaining writable disc space becomes less.
- When copying title recorded in 1080/50p or 1080/60p, it cannot copy in progressive.

### Notes for copying

You cannot copy the following titles.

- USB HDD** Protected titles
- USB HDD** HD Video (AVCHD)
- RAM** Radio programme

### Notes for copying 3D programmes

- It may not display correctly in 3D when a copied 3D programme is played back. In such a case, change the "Signal Format" during the playback of the title. (⇒ 43)
- 3D information may not be copied.
- If you want to copy 3D AVCHD video to the disc in 3D, use BD-R or BD-RE and copying speed must be high speed.

## Copying titles

### About maintaining the chapter mark

- The position of the chapter might shift slightly.
- Maximum number of chapters on the disc is limited.
  - **BD-RE** **BD-R** **RAM** **DVD-R** **DVD-RW** :  
Approx. 1000
  - **+R** **+RW** : Approx. 254  
(Depends on the state of recording.)

### About copy-restricted programmes

The recorded titles indicated with “” icon can be copied to the disc in high definition quality mode (Original Picture Quality, HG, HX, HE, HL or HM) once.

After completing copy, the titles on the HDD cannot be copied to the disc anymore in high definition quality mode and the icon is changed to “”.

The titles copied to the discs cannot be copied again.

### Copying a finalised disc

**DVD-V** → **HDD**

While playing a disc, the content being played is copied to the HDD according to the set time.

- 1 Press [FUNCTION MENU].
- 2 Select “Copy Menu” in “Copy Video”, then press [OK].
- 3 Set “Copy Mode”.
  - 1 Select “Copy Mode”, then press [▶] (right).
  - 2 Press [OK], then select the recording mode (XP/SP/LP/EP).
  - 3 Press [◀].

- 4 Set “Copy Time”.
  - 1 Select “Copy Time”, then press [▶] (right).
  - 2 Select “Time Setting”, then press [OK].
  - 3 Select “On” or “Off”.
 

**On:**  
Set the copying time.

    - Set a few minutes longer than the source title, in order to include the operation time before play begins.

**Off:**  
Copying all the content on the disc.
- 4 Press [◀].

- 5 Select “Start Copying”, then press [OK].

- 6 Select “Yes”, then press [OK].
  - When the Top Menu is displayed: Select the title you want to start copying, then press [OK].

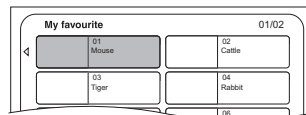

After the last title on the disc has finished playing the Top Menu is recorded until the set time is reached.

### To stop copying

Press [STOP ■].

- You can also press and hold [BACK/RETURN Ⓞ] for 3 seconds.
- If stopped partway, copying will be up to that point.



- Operations and on-screen displays during copy are also recorded.
- Almost all DVD-Video on sale have been treated to prevent illegal copying, and cannot be copied.
- If play does not begin automatically press [PLAY/×1.3 ▶] to start.

## Copying Title Playing

**HDD** → **BD-RE** **BD-R** **RAM** **DVD-R** **DVD-RW** **+R**  
**+RW**

- 1** Play back the title to copy.
  - Multiple audio and subtitle displayed during playback will be copied.
    - Select the multiple audio with "Multi Audio" in the Basic Operation menu (⇒ 74)
    - Select the subtitles with "Subtitle Language" in the Basic Operation menu. (⇒ 74)
- 2** Press [OPTION].
- 3** Select "Copy Title Playing", then press [OK].
- 4** Select "Start", then press [OK].  
Copying will start from the beginning of the title regardless of the playing position.

### To stop copying

Press and hold [BACK/RETURN ⊖] for 3 seconds.



- You can record to or play HDD while high speed copying. Press [OK] to exit the screen display.
- Press [STATUS ⓘ] to confirm the current progress.

### • Speed and recording mode when copying

The high speed copy is performed if available. Refer to "Notes for copying". (⇒ 53)



- **BD-RE** **BD-R** When copying the titles in DR, HG, HX, HE, HL or HM modes and the copy destination does not have enough space, one from HG, HX, HE, HL or HM modes will be selected to match the available space.
- **RAM** **DVD-R** **DVD-RW** **+R** **+RW** When copying the titles in DR, HG, HX, HE, HL or HM modes, copy will be performed at normal speed in FR mode.
- When copying the titles in XP, SP, LP, EP or FR modes and the copy destination does not have enough space, copy will be performed at normal speed in FR mode.

## Copying HD Video (AVCHD) to the DVD-R in High Definition

You can copy HD Video (AVCHD) recorded on HDD to a DVD-R in High Definition quality.

**HDD** → **DVD-R**

- 1** Insert an unformatted DVD-R or DVD-R DL. The menu screen appears. (⇒ 39)
- 2** Select "Copy Video (AVCHD) to Disc", then press [OK].
- 3** Go to step 4 on page 51, "Copying titles with copying list".

### To copy HD Video (AVCHD) from other equipment

Refer to "Copying the HD Video (AVCHD)". (⇒ 70)



- This function can only be used for unformatted disc.
- When a disc is named, formatting will be automatically performed. Therefore, do not name a disc before this operation. (⇒ 89, Disc Name)
- Discs will be automatically finalised after copy.
- The following HD Videos (AVCHD) cannot be copied to the disc in high definition.
  - Exceeding 18 Mbps
  - 1080/50p or 1080/60p
  - Without the AVCHD information (video recorded with certain non-Panasonic equipment, video copied to the HDD after copying it to BD-R or BD-RE once, etc.)
- 3D video may not be copied correctly.

# Playing photos



\*1 "For data files (⇒ 9)" only (JPEG, MPO)

\*2 **BD-RE** only

\*3 **RAM** **DVD-R** only

- In order to play back 3D photo (MPO), this unit should be connected to a Full HD 3D compatible TV.

## 1 **HDD**:

- 1 Press **[FUNCTION MENU]**.
- 2 Select "Photo" in "Contents on HDD", then press **[OK]**.

Except **HDD**:

- 1 Insert or connect the media.  
The menu screen appears. (⇒ 39)
- 2 Select "View Photos", then press **[OK]**.

## 2 Select the folder, then press **[OK]**.

e.g., **HDD**

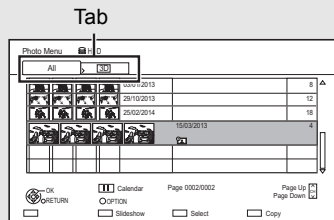

- **To select the tab**  
Press **[◀, ▶]**.
- **Start Slideshow**  
Refer to "Slideshow settings". (⇒ 57)
- **HDD Switching to the Calendar screen**  
Press **[PAUSE ■■]**.

## 3 Select the photo, then press **[OK]**.

- Press **[◀, ▶]** to display the previous or next photo.

## To exit the Calendar screen

Press **[PAUSE ■■]**.



- When there are many files and/or folders, some files may not be displayed or not be playable. (⇒ 106)

## Photo Menu screen

e.g., **HDD**

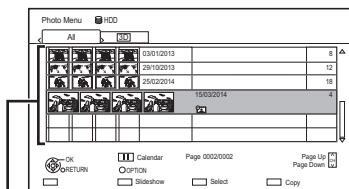

## Folder

- Photos imported to the HDD (⇒ 59) are managed using folders.  
Folders and photos can be edited by pressing **[OPTION]**. (⇒ 58)

## Screen icons

### 3D (Tab)

3D photos (MPO) are automatically sorted. Select from this tab to play back in 3D. (It will play back in 2D when selected from other tabs.)



Photo protected



New photo which is stored and not viewed



## Photo play option

- 1 While displaying a photo:  
Press [OPTION].
- 2 Select the item, then press [OK].

### Aspect

You can switch the screen mode. (⇒ 92)

### Graphic Display Level

You can change the 3D position of the screen display, etc., during the 3D photo playback.

### Photo Menu

#### • Start Slideshow

You can start a slideshow.

#### • Rotate RIGHT/Rotate LEFT

e.g.,



- The information of the rotated photos will not be stored depending on the media.
  - This function is not available during the 3D photo playback.
- **Information**  
Information (shooting date etc.) is shown.
  - **Wallpaper**  
A photo being played back is registered as wallpaper on the FUNCTION MENU screen. (⇒ 23)

## Slideshow settings

- 1 On the Photo Menu screen:  
Press the green button.

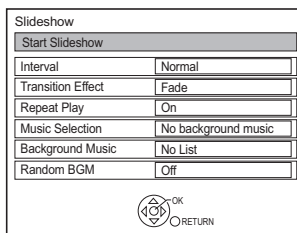

- 2 Select the item, then press [OK].

### Start Slideshow

You can start a slideshow.

### Interval

You can set up the time until the next photo is to display.

### Transition Effect\*

Effect for the next photo to display can be set.

### Repeat Play

You can set up to play back repeatedly.

### Music Selection\*

You can select background music on (either from HDD or USB) or off.

### Background Music\*

You can select background music from HDD (My Favourites or Playlists) or USB (Folder).

### Random BGM\*

You can play back the BGM (Background Music) in random order.

\* This function is not available during the 3D photo playback.

### To pause the Slideshow

Press [PAUSE ■■].

- Press [PAUSE ■■] again to restart.

### To stop the Slideshow

Press [BACK/RETURN ⊖].

# Editing photos

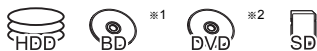

#1 **BD-RE** only

#2 **RAM** only

**1** On the Photo Menu screen:

e.g., **HDD**

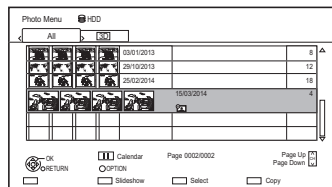

## To edit the folder:

Select the folder.

## To edit the photo:

1 Select the folder, then press [OK].

2 Select the photo to edit.

## • To select multiple folders or photos

Press the yellow button when selecting the folder or photo.

A check mark is displayed. Repeat this step.

- Press the yellow button again to cancel.

**2** Press [OPTION].

- Selectable items will change depending on the media and the type of file.

**3** Select the item, then press [OK].

## Enter Folder Name

Refer to “Entering text”. (⇒ 91)

## Combine Folders

**HDD**

Select “Yes”, then press [OK].

## Delete Folder

Select “Yes”, then press [OK].

## Move Photos

**HDD**

Select “Move to new folder” or “Move to another folder”, then press [OK].

- If “Move to another folder” is selected, set a destination folder.

## Delete Photos

Select “Yes”, then press [OK].

## Set up Protection

**BD-RE** **RAM** **SD**

Select “Yes”, then press [OK].

appears when the protection is set.

- Even if the protection is set, the photo may be deleted by another unit.

## Cancel Protection

**BD-RE** **RAM** **SD**

Select “Yes”, then press [OK].

## Photos for Music

**HDD**

Select “Yes”, then press [OK].

# Copying photos



\*1 “For data files (⇒ 9)” only (JPEG, MPO)

\*2 **BD-RE** only

\*3 **RAM** **DVD-R** only

## Selecting and copying the photos

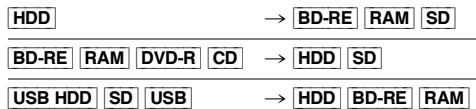

- 1 On the Photo Menu screen:  
**To copy the folder:**  
Select the folder, then press the blue button.

### To copy the photo:

- 1 Select the folder, then press [OK].
- 2 Select the photos to copy, then press the blue button.

### • To select multiple folders or photos

Press the yellow button when selecting the folder or photo.

A check mark is displayed. Repeat this step.

- Press the yellow button again to cancel.

- 2 Select the copying destination, then press [OK].
- 3 Select “Yes”, then press [OK].  
Copying starts.

### To stop copying

Press and hold [BACK/RETURN ⊖] for 3 seconds.



- The name of the copied photos will be changed.
- If the number of files/folders to be copied exceeds the maximum (⇒ 106), copying will stop partway through.

## Copying automatically



Newly added photos will automatically be copied to the HDD.

- 1 Insert the media.  
The menu screen appears. (⇒ 39)
- 2 Select “Copy New Photos”, then press [OK].  
e.g., **SD**

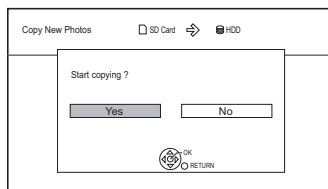

- 3 Select “Yes”, then press [OK].  
Copying starts.
- 4 Once the copy is completed, select “Yes” or “No”, then press [OK].

### To stop copying

Press and hold [BACK/RETURN ⊖] for 3 seconds.



- Photos without shooting date will be categorised using the creation date.
- If the space on the destination drive runs out or the number of files/folders to be copied exceeds the maximum (⇒ 106), copying will stop partway through.
- The name of the copied photos will be changed.

# Playing music



※1 "For data files (⇒ 9)" only (MP3)  
 ※2 **DVD-R** only

**Music CD:**  
**Insert the disc.**  
 Playback will automatically start.

**MP3:**

- 1 Insert or connect the media.**  
 The menu screen appears. (⇒ 39)
  - **DVD-R** **CD** Playback will automatically start if only MP3 is recorded.
- 2 Select "Play / Copy Music ( MP3 )", then press [OK].**  
 Playback will start.
  - Using the tree screen to find a folder
    - 1 Press [OPTION].
    - 2 Select "Select Folder", then press [OK].
    - 3 Select the folder, then press [OK].

## Copying music (MP3) to HDD

**USB HDD** **DVD-R** **CD** **USB** → **HDD**  
 After performing steps 1–2 (⇒ left)

- 1** Press the blue button.
- 2** Select "Copy", then press [OK].

### To stop copying

Press and hold [BACK/RETURN] for 3 seconds.

- While copying, no other operations can be performed. Timer recordings will not proceed.
- All tracks in the folder will be copied.
- Tracks recorded to HDD in one operation will be regarded as one album.

### To play other music (track)

Select the item, then press [OK].

e.g., **CD** (MP3)

Music Menu		Track List	
Ⓢ CD ( MP3 )		○○○○	
No.	Track Name	○○○○	
0001		○○○○	
0002		○○○○	
0003		○○○○	
0004		○○○○	
0005		○○○○	

- The track/artist name will be displayed if the information is contained in ID3 tag of the MP3 file.
- If there is a large amount of photo data etc. within a MP3 file, play may not be possible.

## Playing music recorded on HDD

### HDD

- 1 Press [FUNCTION MENU].
- 2 Select "Music" in "Contents on HDD", then press [OK].

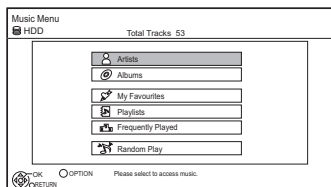

- 3 Select the item, then press [OK].

### Artists

- 1 Press [◀, ▶] to select the initial of the artist.
- 2 Select the name of the artist, then press [OK].
- 3 Select the album, then press [OK].
- 4 Select the track, then press [OK].

### Albums

- 1 Press [◀, ▶] to select the initial of the album.
- 2 Select the album, then press [OK].
- 3 Select the track, then press [OK].

### My Favourites

Tracks registered in "My Favourites".

Select the track, then press [OK].

- Registering a track to the "My Favourites".  
(Up to 99 tracks)

While the track list screen is displayed:  
Select the track, then press the green button.

### Playlists

- 1 Select the playlist, then press [OK].
- 2 Select the track, then press [OK].

### Frequently Played

Tracks most often played recently (up to 30 tracks).

Select the track, then press [OK].

### Random Play

Random playback of all tracks.

Playback starts.

## Showing Track Information

On the track list screen:

- 1 Select the track, then press [OPTION].
- 2 Select "Information", then press [OK].

## Playing music

### Operations during music play

HDD USB HDD DVD-R CD USB

#### Stop

Press [STOP ■].

#### Pause

Press [PAUSE ■■].

- Press [PLAY/× 1.3 ▶] to restart play.

#### Search

Press [SLOW/SEARCH ◀◀] or [SLOW/SEARCH ▶▶].

- Press [PLAY/× 1.3 ▶] to restart play.

#### Skip

Press [SKIP ◀◀] or [SKIP ▶▶].

#### Repeat Play/Random

Refer to “Repeat Play” or “Random” in Basic Operation menu (⇒ 74).

#### Sound Effects

Refer to “Sound Effects” in Sound Settings menu (⇒ 75).

### Displaying photos (Screen Saver)

Photos can be displayed during music playback.

While playing the music

Press the red button.

- To select the photos to display
  - The original photo stored in the HDD by default or a folder registered with “Photos for Music” (⇒ 58) can be selected.
  - (3D photos in the folder are played back in 2D.)

- 1 While screen saver is displayed  
Press [OPTION].
- 2 Select “Setting for Screen Saver”, then press [OK].
- 3 Select the item, then press [OK].  
e.g.,

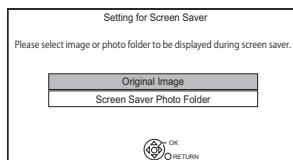

#### To end the screen saver

Press [BACK/RETURN ⏪].

#### To play music continuously even if the Power off link works

Refer to “Playing music continuously even after turning off power to the TV”. (⇒ 73)

# Editing music/playlist



- 1** On the Music Menu screen:  
Press [OPTION].  
e.g.,

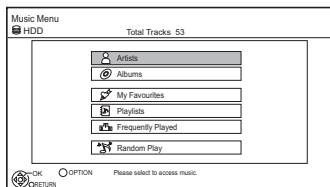

- 2** Select the item, then press [OK].  
e.g., while selecting an Album

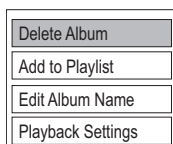

- Editing operations will change depending on the screen.

## Delete All Tracks

- 1 If the confirmation screen appears:  
Select "Yes", then press [OK].
- 2 Select "Delete", then press [OK].

## Delete Album

Select "Delete", then press [OK].

## Delete

Select "Delete", then press [OK].

## Edit Album Name/Edit Track Name/Edit Artist Name/Edit Playlist Name

Refer to "Entering text" on page 91.

## Remove All Tracks

- Select "Remove", then press [OK].
- Tracks themselves are not deleted from the HDD.

## Clear My Favourites/Clear Frequently Played

- Select "Clear", then press [OK].
- Tracks themselves are not deleted from the HDD.

## Remove

- Select "Remove", then press [OK].
- Tracks themselves are not deleted from the HDD.

## Add to Playlist

You can register your favourite albums and tracks into 10 preset playlists.

Select the playlist, then press [OK].

- New playlist cannot be added.
- Up to 999 tracks can be registered to each playlist.

# Smart Home Networking (DLNA)

Smart Home Networking (DLNA) allows you to watch the contents and broadcasts on Server equipment connected on the same network from Client equipment.

This unit can be used both as Server and Client. Additionally, if used as Client, this unit can also be used as Media Renderer, which can be controlled by a Smartphone, etc.

## Preparation

- Network connection (⇒ 17, 21)
- Perform Home Network settings of the DLNA compatible equipment.

For more details, refer to the following website and the operating instructions for each item of equipment.

<http://panasonic.jp/support/global/cs/>  
(This site is in English only.)



- Some video or broadcasts cannot be enjoyed depending on the DLNA (Client) compatible equipment, the condition of this unit, or the file type.
- Ensure that the router for your home network has adequate security system to prevent unauthorized access.
- If using slow network connection, the video may not be displayed correctly. A high-speed home network with a speed of at least 20 Mbps is recommended. (⇒ 101)

## Using this unit as Server

You can watch broadcasts received by this unit (Multiroom TV Streaming), videos and photos saved on HDD of this unit on DLNA (Client) compatible equipment.

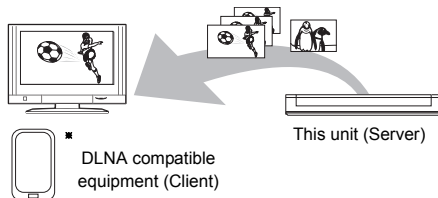

For details regarding the connection and operation of equipment connected via a network, refer to their respective operating instructions.

\* DLNA function compatible software should be installed.

## Preparation

- When DLNA (Server) Function is deactivated, make the settings. (⇒ 76, 85, Home Network Settings)

- 1 Operate the playback equipment (Client) to display the list of contents on this unit.
  - Refer to their respective operating instructions.
- 2 Select the item, then press [OK].



- The titles with access restriction (e.g., copy restriction) signals sent from broadcasters are not available for this function.
- You cannot play back music from the playback equipment (Client).
- If video frames are dropped, change the following settings.
  - Conversion Setting for DLNA (⇒ 76, 86)
  - Resolution Setting for DLNA (⇒ 76, 86)
- The DLNA compatible device that is to be connected to the unit should be connected to the same hub or broadband router as the unit.
- Files not on the HDD cannot be played back.
- Playing back 3D video recorded on this unit may not work properly.
- 3D photos copied to this unit cannot be played back in 3D.
- Editing is not possible.



## Using this unit as Client

You can share videos, photos and music stored in the DLNA Certified media server (such as a PC with Windows 7 installed etc.).

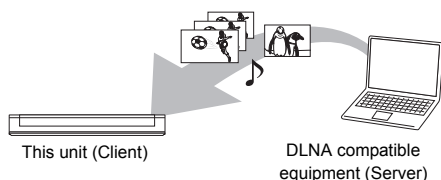

- 1** Press [FUNCTION MENU].
- 2** Select "DLNA Client" in "Home Network", then press [OK].  
A list of equipment connected via the network is displayed.
  - This list can be updated by pressing the red button.
- 3** Select the equipment, then press [OK].
- 4** Select the item, then press [OK].
  - Menu structure will be different depending on the equipment. Select the contents by repeating the operation.
  - Convenient functions can be used by pressing [OPTION] depending on the contents.
  - **Control Panel**  
Control Panel is displayed once the playback starts.  
Operation can be performed with [▲, ▼, ◀, ▶], [OK] and [EXIT ⊗].
    - Press [OK] if the Control Panel is not displayed.
    - (While paying video or photo) Press [BACK/RETURN ⊙] to hide the Control Panel.



- You may not be able to use the Control Panel even if you use the Panasonic DLNA compatible equipment.
- If you want to display the playback menu while playing back a video on the Panasonic DLNA compatible equipment, press [AUDIO].
- Depending on the contents and the connected equipment, playback may not be possible.
- Playlist of Windows Media® Player can play back only the contents that are stored in the libraries.

- While playing back the 3D programme, you cannot set 3D settings. (⇒ 43)
- Items displayed in grey on the display cannot be played back by this unit.
- Depending on the performance of the connected PC, video frames may be dropped during playback, or video may not be played back at all.

## Playable contents

When this unit works as a DLNA client, following contents are playable.

### Video

Container	Video codec	Audio codec	Example of file extension
Recorded programmes (XP/SP/LP/EP/FR) <sup>※1</sup>	MPEG2	Dolby® Digital Linear PCM	.mpg .mpeg
Recorded programmes (DR/HG/HX/HE/HL/HM) <sup>※1</sup>	MPEG2 H.264	MPEG HE-AAC Dolby® Digital	.m2ts .ts
AVCHD <sup>※1</sup>	H.264	Dolby® Digital	.mts
MP4	H.264	AAC	.mp4
MPEG2	MPEG2	Dolby® Digital Linear PCM	.mpg .mpeg
Xvid	H.264	MP3 Dolby® Digital	.avi
MKV	H.264	AAC-LC MP3 Dolby® Digital PCM Vorbis FLAC	.mkv

### Photo

Format	Example of file extension
JPEG	.jpg
MPO <sup>※1,2</sup>	.mpo

### Audio

Audio codec	Example of file extension
MP3	.mp3
WAV	.wav
AAC	.m4a
WMA	.wma
FLAC	.flac
Linear PCM	—

<sup>※1</sup> Only when the server is another Panasonic Blu-ray Disc Recorder, etc.

<sup>※2</sup> 2D playback only.

- Depending on the server, the contents other than stated above can be played back.

## Smart Home Networking (DLNA)

### Using this unit as Media Renderer

This unit will work as Media Renderer, which allows you to play back the contents on DLNA Server by operating a Digital Media Controller (a smartphone, etc.).

#### Possible applications:

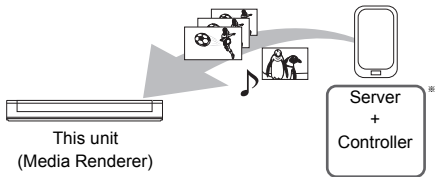
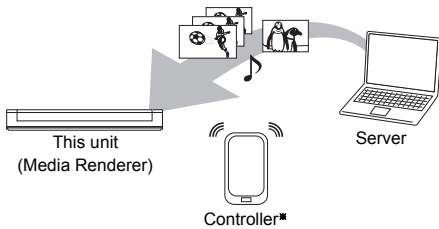

\* Digital Media Controller compatible software should be installed.

Following steps are necessary to use this unit as Media Renderer.

- 1** Press [FUNCTION MENU].
- 2** Select "Media Renderer" in "Home Network", then press [OK].
- 3** Operate the Digital Media Controller compatible equipment.

#### To exit from Home Network ( Media Renderer ) screen

Press [BACK/RETURN ⊙].



- Depending on the contents and the connected equipment, playback may not be possible.
- Items displayed in grey on the display cannot be played back by this unit.
- This unit can be played back via connected equipment only when controlled using Digital Media Controller.
- Depending on the performance of the connected PC, video frames may be dropped during playback, or video may not be played back at all. (⇒ 101)

### Using Miracast™

You can enjoy the content you are viewing on a Miracast-compatible smartphone, etc. on the big screen of your TV.

- Compatible with Android™ device, ver. 4.2 and above and Miracast certified.
- For information on whether the smartphone, etc. supports Miracast, contact the manufacturer of the device.

Miracast compatible equipment

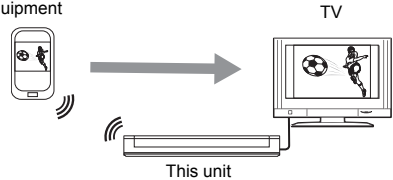

- 1** Press [FUNCTION MENU].
- 2** Select "Miracast" in "Home Network", then press [OK].
- 3** Operate the Miracast compatible equipment.

#### To exit from Miracast

Press [EXIT ⊗].

## Using Smart Home Networking (DLNA) with Wi-Fi Direct™

Wi-Fi Direct is a standard that enables wireless LAN devices to communicate each other directly without a wireless broadband router.

This unit can be connected wirelessly and directly to other DLNA compatible equipment on a temporary basis, regardless of the network connection and settings of this unit.

Connecting temporarily

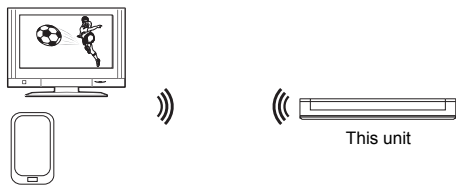

Wi-Fi Direct compatible equipment

- 1** Press [FUNCTION MENU].
- 2** Select “Wi-Fi Direct” in “Home Network”, then press [OK].
- 3** Select the item, then press [OK].
  - Set up the device to be connected so that a Wi-Fi Direct connection can be made. For details, refer to the operating instructions for the device to be connected.
- 4** Select the device to be connected, then press [OK].
  - If the device you want to connect to is not displayed, switch the connection method by pressing the yellow button.
- 5** **When selected “DLNA Client”:**  
Go to step 3 on page 65.
 

**When selected “DLNA Server”:**  
Operate the playback equipment (Client).

**When selected “Media Renderer”:**  
Operate the Digital Media Controller.

## When no devices are found

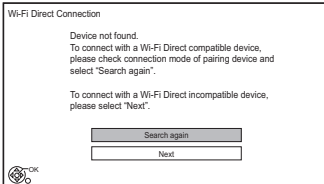

If the corresponding device is not found even after the search is run again, select “Next” and change the connection method.

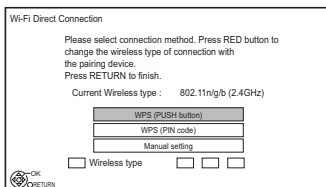

Select the connection method according to the device to be connected.

# Enjoying Network Service

Network Service allows you to access some specific websites supported by Panasonic, and enjoy Internet contents such as photos, videos, etc. from Network Service home screen.

e.g.,

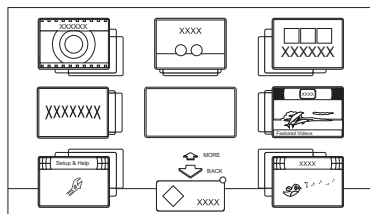

Network Service home screen

- Images are for illustration purpose, contents may change without notice.

## Preparation

- Network connection (⇒ 17, 21)

- 1 Press [INTERNET].
  - The message is displayed. Please read it carefully and then press [OK].
  - NETFLIX can be accessed directly by pressing [NETFLIX] button.
- 2 Select the item, then press [OK].
  - Operable buttons:  
[▲, ▼, ◀, ▶], [OK], [BACK/RETURN ⊖], colour buttons and number buttons.



- Some features of websites may not be available on this unit's web browser.
- In the following cases, settings are possible using "Network Service Settings" (⇒ 76, 85)
  - When restricting the use of Network Service.
  - When the audio is distorted.
- If using slow Internet connection, the video may not be displayed correctly. A high-speed Internet service with a speed of at least 6 Mbps is recommended.
- Be sure to update the software (firmware) when a software (firmware) update notice is displayed on the screen. If the software (firmware) is not updated, you will not be able to use the Network Service function.
- The services through Network Service are operated by their respective service providers, and service may be discontinued either temporarily or permanently without notice. Therefore, Panasonic will make no warranty for the content or the continuity of the services.
- All features of websites or content of the service may not be available.
- Some contents may be inappropriate for some viewers.
- Some contents of Network Service may only be available for specific countries and may be presented in specific languages.
- If timer recording starts, Network Service will stop.

## To exit

Press [EXIT ⊗].

# Recording from external equipment



Recording mode: XP, SP, LP, EP

## Preparation

Connect the Set Top Box or video equipment (⇒ 15)

- 1** Press [INPUT SELECT] and select “AV”, then press [OK].
- 2** Press [REC MODE] to select the recording mode.
- 3** Select the channel on the Set Top Box or start play on the video equipment.
- 4** Press [REC ●].  
Recording starts.
- 5** Set the time to record. (⇒ 28)

REC1/OTR	
Input AV	
Automatic Stop (Guide Link)	
Recording Time	◀ 30 min ▶
Continuous recording	

## To stop recording

Press [STOP ■].

## Manually programming timer recording from external equipment

Refer to “Manually programming timer recording” (⇒ 32).



- Following contents or media cannot be played back while recording from external equipment.
  - BD-Video
  - Xvid, MKV and AVCHD file
  - photo
  - SD card
  - USB HDD (For data files, ⇒ 9) and USB memory

# Copying the HD Video (AVCHD)



video camera, etc.

\* "For data files (⇒ 9)" only

e.g., Connecting to the Panasonic video camera

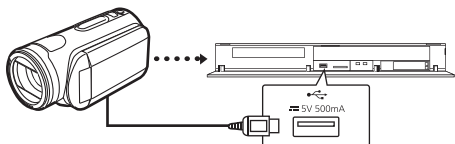

**USB connection cable**  
(optional)

- 1 Connect the video camera or insert the media.
  - Make the video camera ready for data transfer.

The menu screen appears. (⇒ 39)

- 2 Select "Copy Video ( AVCHD )", then press [OK].
- 3 When copying from an SD card or video equipment: Select "Copy to HDD" or "Copy to Blu-ray Disc", then press [OK].

- 4 Select the title, then press the yellow button. A check mark is displayed. Repeat this step.

e.g., **[SD]**

Copy Video ( AVCHD )		Destination Capacity	
<input type="checkbox"/> SD	<input checked="" type="checkbox"/> HDD		Size
Time	Rec time	No.	Channel
9:00		<input checked="" type="checkbox"/> 00	AVCHD
		<input type="checkbox"/> 01	AVCHD
0:30		<input type="checkbox"/> 003	AVCHD
Size 200 MB		<input type="checkbox"/> 004	AVCHD
		<input type="checkbox"/> --	

- Press the yellow button again to cancel. (All the recordings on the same date become a title.)

- 5 Press [OK].
- 6 Select "Start", then press [OK]. It will automatically format the unformatted disc, such as a new disc.
  - It may take time for the copying to start.

## To stop copying

Press and hold [BACK/RETURN] for 3 seconds.

## To copy to the DVD-R in High Definition

Refer to "Copying HD Video (AVCHD) to the DVD-R in High Definition". (⇒ 55)



- The original file must be in the AVCHD standard.
- If you connect a Panasonic product with a USB connection cable, setup screen may be displayed on the connected equipment. For details, refer to the instructions for the connected equipment.
- An AVCHD title with 100 or more scenes will be divided into titles every 99th scene and copied.

## Screen icons

- [N] (NTSC)** Title recorded using a different encoding system from that of the unit.
- [P] (PAL)**
  - Titles displaying these marks cannot be selected.

# Registering the external HDD (USB HDD)



\* “For recorded titles (⇒ 9)” only

If you intend to move recorded titles to a USB HDD, the USB HDD must be registered to this unit first.

## Limitation information

- A USB HDD with a capacity of less than 160 GB cannot be used.
- Registering of a USB HDD will format the USB HDD and all the content already recorded will be deleted.
- Up to eight USB HDDs can be registered on this unit.
- Registered USB HDDs cannot be used with devices other than this unit.

## Regarding the external HDD (USB HDD)

### Please use a confirmed USB HDD.

For the latest information on confirmed USB HDDs, please check the following website.

<http://panasonic.jp/support/global/cs/>

- Certain non-confirmed USB HDDs cannot be used with this unit.
- If a problem occurs with the USB HDD, please contact the manufacturer of the device.

## Connecting the USB HDD

Connect this unit with optional USB HDD.

e.g.,

This unit's rear panel

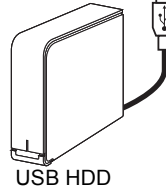
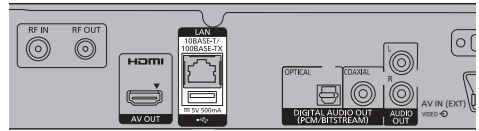

- Only one USB HDD (For recorded titles, ⇒ 9) can be connected at the same time.
- Do not connect additional HDDs using a USB hub.
- For details about connection method, refer to the instructions supplied with the USB HDD.

## Disconnecting the USB HDD

Please use the following procedure to disconnect. Disconnecting without following this procedure may result in the loss of recorded content from the USB HDD or the internal HDD.

- 1 Press [FUNCTION MENU].
- 2 Select “Basic Settings” in “Setup”, then press [OK].
- 3 Select “Settings for USB HDD” in “HDD / Disc / USB HDD”, then press [OK].
- 4 Select “USB HDD Disconnection”, then press [OK].
- 5 Select “Yes”, then press [OK].
- 6 Disconnect the USB HDD from this unit.

## Registering the external HDD (USB HDD)

### Registering the USB HDD

- If the registering screen appears when connecting the USB HDD, go to step 5.

- 1** Press [FUNCTION MENU].
- 2** Select "Basic Settings" in "Setup", then press [OK].
- 3** Select "Settings for USB HDD" in "HDD / Disc / USB HDD", then press [OK].
- 4** Select "USB HDD Registration", then press [OK].
- 5** Select "Yes", then press [OK].
  - If you have already registered eight USB HDDs, it will be necessary to delete one or more of them before registering a new USB HDD.  
The message screen appears:
    - 1 Select "Yes", then press [OK].
    - 2 Select the USB HDD to cancel, then press [OK].  
The confirmation screen appears.
      - 3 Select "Yes", then press [OK].
- 6** When the registering is complete, message screen appears.  
Press [OK].
- 7** The confirmation screen appears.  
Press [OK].

### To cancel all USB HDD registrations

Refer to "Cancellation of all USB HDD Registrations". (⇒ 81)



- If you register a USB HDD, all the content already recorded on the USB HDD will be deleted.
- It is not possible to play back the content on the USB HDD whose registration has been cancelled.
- You can check the registration number of the USB HDD on the DIRECT NAVIGATOR. (⇒ 36)



# VIERA Link functions

## What is VIERA Link “HDAVI Control”?

VIERA Link “HDAVI Control” is a convenient function which will link the operations of this unit and a Panasonic TV (VIERA) or an amplifier/receiver. You can use this function by connecting the equipment with the HDMI cable. See the operating instructions for connected equipment.

### Automatic input switching/ Power on link

When the following operations are performed, the input channel of the TV will be automatically switched and the screen of this unit will be displayed. Additionally when the TV is off, the TV will automatically turn on.

- When play starts on this unit
- When an action that uses DIRECT NAVIGATOR etc, is performed

### Power off link

When you set the TV to standby mode, this unit is also automatically set to standby mode.

- Power off link function does not work when recording, copying etc.

### Playing music continuously even after turning off power to the TV

The following operations make it possible to keep the power of the unit on and to play music continuously.

When the unit is directly connected to an amplifier/receiver.

- 1 While playing music  
Press [OPTION].
  - 2 Select “TV Power Off”, then press [OK].
- Sound may be discontinued for several seconds when the power to the TV is turned off.
  - This function is available with the TV that supports “HDAVI Control 2” or later.

### PAUSE LIVE TV

You can operate this unit with the TV remote control.

Refer to “PAUSE LIVE TV”. (⇒ 27)

- This function is available with the TV that supports “HDAVI Control 3” or later.

### Direct TV Recording

This function allows you to immediately start recording the programme that you are viewing on the TV.

Refer to the TV operating instructions for operation.

- This function is available with the TV that supports “HDAVI Control 3” or later.

### Easy control only with Panasonic TV's remote control

You can operate this unit using the TV remote control.

Refer to the operating instructions of the TV about the buttons that you can use.

- This function is available with the TV that supports “HDAVI Control 2” or later.



- This unit supports “HDAVI Control 5” function. “HDAVI Control 5” is the standard for Panasonic's HDAVI Control compatible equipment. This standard is compatible with Panasonic's conventional HDAVI equipment. Please refer to individual manuals for other manufacturers' equipment supporting VIERA Link function.
- VIERA Link “HDAVI Control”, based on the control functions provided by HDMI which is an industry standard known as HDMI CEC (Consumer Electronics Control), is a unique function that we have developed and added. As such, its operation with other manufacturers' equipment that supports HDMI CEC cannot be guaranteed.
- These functions may not work normally depending on the equipment condition.
- Use the remote control supplied with this unit if you cannot operate this unit using buttons on the TV remote control.
- The operation of this unit may be interrupted when you press certain buttons on the TV remote control.

# Playback menu

A variety of operations and settings such as changing the subtitles and audio languages can be performed during playback of video or music. Also, picture and sound quality can be set to your personal taste.

- 1 Press [OPTION].
- 2 Select "Playback Settings" in "Playback Menu" or select "Playback Settings", then press [OK].

e.g.,

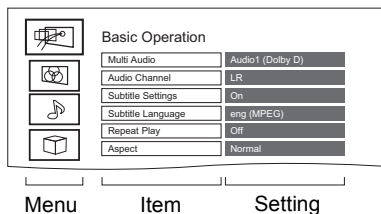

- 3 Select the menu, then press [OK].
- 4 Select the item, then press [OK].
- 5 Change the setting.

Depending on the condition of the unit (playing, stopped, etc.) and media contents, there may be some items which cannot be selected or for which the effects do not work properly.

## To clear the Playback menu

Press [BACK/RETURN ⊖] until the Playback menu disappears.

## Basic Operation

### Soundtrack\*

Show or change the soundtrack.

### Multi Audio

Switch in the case of multiple audio.

### Audio Channel

Change audio (LR/L/R) during playback.

### Subtitle Settings\*

Turn the subtitle on/off, and change the language depending on the media.

#### Subtitle Settings

#### Subtitle Style

#### Subtitle Position

#### Subtitle Luminance

Select the subtitle style recorded on the disc.

### Subtitle Language

Select the subtitle language in the case of multiple languages.

### Angle\*

Change the number to select an angle.

### Repeat Play

Select the item which you want to repeat.

### Random

Select whether to play random or not.

### Video

The original video recording method (MPEG-4 AVC etc.) appears.

### Primary Video

The original video recording method appears.

### Secondary Video

#### Video

Select on/off of images.

The original video recording method appears.

#### Soundtrack

Select on/off of audio and the language.

### Aspect (⇒ 92)

### Reception

The radio wave status during the playback of Smart Home Networking (DLNA) is displayed. (Only when a wireless connection is used)

\* With some discs, you may only be able to make changes using the menus on the disc.

## Picture Settings

### Picture Type

Select the picture quality mode.

### Sharpness Adjustment

Adjusts the sharpness of images. The greater the value is, the sharper images will be.

### Noise Reduction

Reduces unnecessary noise in videos. The greater the value is, the less noise will appear.

### Luminance / Colour Adjustment

Adjusts the contrast, brightness, white gamma, black gamma, colour saturation and hue.

### Bandwidth Limitation

Adjusts the bandwidth limitations.

### Progressive

Select the method of conversion for progressive output to suit the type of title being played.

- **Auto**

Automatically detects the film and video content, and appropriately converts it.

- **Video**

Select this setting when the content is distorted if "Auto" is selected.

- **Film**

Select this if the edges of the film content appear jagged or rough when "Auto" is selected. However, if the video content is distorted as shown in the illustration to the right, then select "Auto".

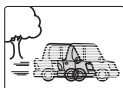

### Reset to Default Picture Settings

Restores the default settings of the Picture Settings menu.

## Sound Settings

### Sound Effects

- This function is effective when "Digital Audio Output" is set to "PCM". (⇒ 82)

- ↳ **Re-master 1/Re-master 2**

Sound becomes more natural by adding higher frequency signals not recorded on the track.

- ↳ **Dialogue Enhancer**

The volume of the centre channel is raised to make dialogue easier to hear.

## 3D Settings

- ↳ **Signal Format (⇒ 43)**

- ↳ **3D Picture Mode (⇒ 43)**

- ↳ **Manual Settings (⇒ 43)**

- ↳ **Graphic Display Level**

You can change the 3D position of the playback settings display, etc., during the 3D playback.

## Language

ENG	English	JPN	Japanese	ARA	Arabic
FRA	French	CHI	Chinese	HIN	Hindi
DEU	German	KOR	Korean	PER	Persian
ITA	Italian	MAL	Malay	IND	Indonesian
ESP	Spanish	VIE	Vietnamese	MRI	Maori
NLD	Dutch	THA	Thai	BUL	Bulgarian
SVE	Swedish	POL	Polish	RUM	Romanian
NOR	Norwegian	CES	Czech	GRE	Greek
DAN	Danish	SLK	Slovak	TUR	Turkish
POR	Portuguese	HUN	Hungarian	*	Others
RUS	Russian	FIN	Finnish		



- The menu is not displayed when playing photos.

# Basic Settings

You can change the unit's settings of Tuning, Sound, Display, Connection, Network etc. in the menu.

## Common procedures

- 1 Press [FUNCTION MENU].
- 2 Select "Basic Settings" in "Setup", then press [OK].

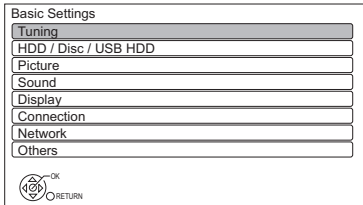

- 3 Select the menu, then press [OK].
- 4 Select the item, then make the setting. (⇒ right)
  - Follow the instructions on the screen if further operations are necessary.
  - Depending on the connection or the status of this unit some items cannot be selected or changed.

### To return to the previous screen

Press [BACK/RETURN ⊖].

## Menu list

The locations of the setting items are as follows. For details on each setting item, please refer to the following pages.

### Tuning

- Favourites Edit (⇒ 78)
- Channel List (⇒ 78)
- Auto Setup (⇒ 79)
- Channel Sorting by Region (⇒ 79)
- Manual Tuning (⇒ 79)
- Update Channel List (⇒ 79)
- Signal Condition (⇒ 79)
- New Channel Message (⇒ 79)
- Child Lock (⇒ 79)
  - Child Lock List (⇒ 79)
  - Freeview Players (⇒ 79)
- Preferred Multi Audio (⇒ 79)
  - Multi Audio (⇒ 79)
  - Audio Description (⇒ 79)
- Preferred Subtitles (⇒ 79)
  - Subtitles (⇒ 79)

### HDD / Disc / USB HDD

- Settings for Playback (⇒ 80)
  - 3D BD-Video Playback (⇒ 80)
  - Soundtrack (⇒ 80)
  - Subtitles (⇒ 80)
  - Menu (⇒ 80)
  - BD-Live (⇒ 80)
  - BD-Video Parental Control (⇒ 80)
  - DVD-Video Parental Control (⇒ 80)
  - Child Lock (⇒ 80)
  - Pure Sound mode (⇒ 80)
- Settings for Recording (⇒ 81)
  - REWIND LIVE TV (⇒ 81)
  - Aspect for Recording (⇒ 81)
  - Chapter Creation (⇒ 81)
  - Disc Speed for High Speed Copy (⇒ 81)
- HDD Management (⇒ 81)
  - Delete all titles (⇒ 81)
  - Delete all photos (⇒ 81)
  - Format HDD (⇒ 81)
- Settings for USB HDD (⇒ 81)
  - USB HDD Registration (⇒ 81)
  - USB HDD Disconnection (⇒ 81)
  - USB HDD Management (⇒ 81)
    - Delete all titles (⇒ 81)
    - Format USB HDD (⇒ 81)
  - Cancellation of all USB HDD Registrations (⇒ 81)

**Picture**

- └ Still Mode (⇒ 82)

**Sound**

- └ Dynamic Range Compression (⇒ 82)
- └ Downmix (⇒ 82)
- └ Bilingual Audio Selection (⇒ 82)
- └ Digital Audio Output (⇒ 82)
  - └ PCM Down Conversion (⇒ 82)
  - └ Dolby D / Dolby D + / Dolby TrueHD (⇒ 82)
  - └ DTS / DTS-HD (⇒ 82)
  - └ MPEG (⇒ 82)
  - └ HE-AAC (⇒ 82)
  - └ BD-Video Secondary Audio (⇒ 82)
- └ Audio Delay (⇒ 82)
- └ Audio for HG / HX / HE / HL / HM Recording (⇒ 82)

**Display**

- └ On-Screen Information (⇒ 83)
- └ Unit's Display (⇒ 83)
- └ Screen Saver (⇒ 83)

**Connection**

- └ 3D Settings (⇒ 83)
  - └ 3D Type (⇒ 83)
  - └ 3D AVCHD Output (⇒ 83)
  - └ 3D Playback Message (⇒ 83)
- └ TV Aspect (⇒ 83)
- └ Aspect for 4:3 Video (⇒ 83)
- └ TV System (⇒ 83)
- └ HDMI Connection (⇒ 83)
  - └ HDMI Video Format (⇒ 83)
  - └ 24p Output (⇒ 84)
  - └ Deep Colour Output (⇒ 84)
  - └ HDMI Audio Output (⇒ 84)
  - └ 7.1ch Audio Reformatting (⇒ 84)
  - └ Contents Type Flag (⇒ 84)
  - └ VIERA Link (⇒ 84)

**Network**

- └ Easy Network Setting (⇒ 84)
- └ Network Settings (⇒ 84)
  - └ LAN Connection Mode (⇒ 84)
  - └ Wireless Settings (⇒ 84)
    - └ Connection Setting (⇒ 84)
    - └ Double Speed Mode Setting ( 2.4GHz ) (⇒ 84)
  - └ IP Address / DNS Settings (⇒ 85)
  - └ Proxy Server Settings (⇒ 85)
  - └ Network Service Settings (⇒ 85)
    - └ Second Screen Browsing (⇒ 85)
    - └ Lock (⇒ 85)
    - └ Automatic Volume Control (⇒ 85)
  - └ Remote Recording Function Settings (⇒ 85)
    - └ Remote Recording function (⇒ 85)
    - └ Device ID (⇒ 85)
    - └ Initialize Device Password (⇒ 85)
  - └ Home Network Settings (⇒ 85)
    - └ Home Network function (⇒ 85)
    - └ Setting device name (⇒ 86)
    - └ Conversion Setting for DLNA (⇒ 86)
    - └ Resolution Setting for DLNA (⇒ 86)
    - └ Registration type for remote devices (⇒ 86)
    - └ Remote device list (⇒ 86)

**Others**

- └ Standby Settings (⇒ 86)
  - └ Quick Start (⇒ 86)
  - └ Automatic Standby (⇒ 86)
  - └ Automatic Standby after OTR (⇒ 86)
  - └ Automatic Standby after Copy (⇒ 87)
  - └ RF OUT ( Aerial Signal ) (⇒ 87)
  - └ Power Save for Network Standby (⇒ 87)
- └ Remote Control (⇒ 87)
- └ Clock (⇒ 87)
- └ Owner ID (⇒ 88)
- └ PIN Entry (⇒ 88)
- └ System Update (⇒ 88)
  - └ Software Update in Standby (⇒ 88)
  - └ Software Update Now ( Broadcast ) (⇒ 88)
  - └ Software Update Now ( Internet ) (⇒ 88)
  - └ Software Licence (⇒ 88)
- └ System Information (⇒ 88)
- └ Initialize (⇒ 88)
  - └ Shipping Condition (⇒ 88)
  - └ Default Settings (⇒ 88)

## Basic Settings

### Tuning

#### Favourites Edit

You can create four favourites of channels for making viewing and recording easier.

#### After editing as follows, save the Favourites.

Press [BACK/RETURN Ⓞ], then press [OK].

- To select the other Favourites list:  
Press the green button.
- To add channels to the Favourites list:  
Select the channel in the "All DVB Channels" column, then press [OK]. Repeat this step.
  - Yellow: Add all the available channels to the Favourites. (This function is available only when there are no channels in the "Favourites".)
- To change the order of the channels list:
  - 1 Select the channel in the "Favourites" column to move, then press the green button.
  - 2 Select the new position, then press the green button.

- To delete channels:  
Select the channel in the "Favourites" column, then press [OK].
  - Yellow: Delete all channels.
- To change the name of the Favourites list:
  - 1 Press the red button in the "Favourites" column.
  - 2 Press [▲, ▼, ◀, ▶] to select a character, then press [OK].  
Repeat this step to enter other characters.
    - Red: Delete a character.
    - Blue: Delete all characters.
  - 3 Press [BACK/RETURN Ⓞ].

#### Channel List

You can edit the channel list.

- To hide unwanted channels
  - 1 Select the channel.
  - 2 Press [OK].  
The check mark is removed.
    - Yellow: Reveal all channels.
- To change the channel number assignment
  - 1 Select the channel to change, then press the green button.
  - 2 Enter the channel number to reassign with the number buttons.
  - 3 Press [OK].
- To set the channel manually
  - 1 Press the red button.
  - 2 Refer to "Manual Tuning". (⇒ 79)

## Auto Setup

You can restart the Auto Setup. (⇒ 19)

PIN is required when you have locked channels.  
(⇒ right, Child Lock List)

Select "Yes", then press [OK].



- The timer recording programmes are cancelled.
- If you perform "Channel Sorting by Region" (⇒ below), you can sort the channel list best suited to your region after Auto tuning is finished.

## Channel Sorting by Region

If you want to sort the channel list best suited to your region, follow the on-screen instructions to select the region you live in.

Normally, you should select "Best signal quality (All Regions)".

## Manual Tuning

You can add new channels manually.

- 1 Press [▲, ▼] to select the frequency.
  - Adjust the frequency by checking the signal strength and signal quality displays.
- 2 Press [OK] to start scan.
  - The set channel is displayed in the table.

## Update Channel List

You can update the channel list to the latest one.

## Signal Condition

You can check the quality and strength of signals.  
Press [CH ^ v] to select the channel.



- The channels you can receive are affected by weather conditions, seasons, time (day/night), region, length of the cable that is connected to the aerial, etc.
- When the signal is too strong (red bar), reduce the signal amplification at your aerial. (For details, consult your dealer.)

## New Channel Message

Set whether to obtain the information automatically when a new DVB channel is added.

## Child Lock

- PIN is required to change. (⇒ 24)

### Child Lock List

You can restrict the viewing of channels.  
You can lock each channel or AV input.

- 1 Select the channel or AV input to lock.
- 2 Press [OK].

 is displayed.

- Press [OK] again to cancel.
- Green: Lock all channels.
- Yellow: Unlock all channels.

### Freeview Players

You can restrict the viewing of Digital teletext (MHEG) unsuitable to children.

## Preferred Multi Audio

### Multi Audio

Select the language for multi broadcast.

If the selected language is not available, the original language will be selected.

### Audio Description

(When Audio Description is available in the programme)

When "Automatic" is selected, Audio Description will be set as default while watching.



- When "Dolby D / Dolby D + / Dolby TrueHD", "MPEG" or "HE-AAC" is set to "Bitstream", the Audio Description may not work. Set them to "PCM" (⇒ 82, Digital Audio Output).

## Preferred Subtitles

### Subtitles

Choose the subtitle language for broadcast. If the selected language is not available, then the original language will be selected.

## Basic Settings

### HDD / Disc / USB HDD

#### Settings for Playback

##### 3D BD-Video Playback

Select the playback method of 3D compatible video software.

##### Soundtrack

Select the audio language.

- If "Original" is selected, the original language of each disc will be selected.
- Enter a code with the number buttons when you select "Other \*\*\*\*".  
(⇒ 109, Language code list)

##### Subtitles

Select the language for subtitle.

- If "Automatic" is selected and the language selected for "Soundtrack" is not available, subtitles of that language will automatically appear if available on that disc.
- Enter a code with the number buttons when you select "Other \*\*\*\*".  
(⇒ 109, Language code list)

##### Menu

Select the language for disc menus.

- Enter a code with the number buttons when you select "Other \*\*\*\*".  
(⇒ 109, Language code list)

##### BD-Live

You can restrict Internet access when BD-Live functions are used.

- If "On ( Limit )" is selected, Internet access is permitted only for BD-Live contents which have content owner certificates.

##### BD-Video Parental Control

Set an age limit of BD-Video play.

- PIN is required to change. (⇒ 24)

##### DVD-Video Parental Control

Set a rating level to limit DVD-Video play.

- PIN is required to change. (⇒ 24)

##### Child Lock

You can restrict playback of the following titles:

- Titles that are recorded with guidance information
- Titles restricted by Child Lock List (⇒ 79)  
(Titles with **G** icon in DIRECT NAVIGATOR, etc.)
- PIN is required to change. (⇒ 24)

##### Pure Sound mode

You can enjoy movies or music in an environment more suitable for viewing by stopping the rotation of the HDD when playing back commercial BD-Videos, DVD-Videos or music CDs.

- If "On" is selected, timer recording does not start during playback BD-Video, DVD-Video or music CD.



## Settings for Recording

---

### REWIND LIVE TV

Turn on/off the REWIND LIVE TV function.

- When “Automatic Standby” is set to “Off” (⇒ 86), “On” cannot be selected.

### Aspect for Recording

Sets the aspect ratio when recording or copying except in DR mode.

- “HG”, “HX”, “HE”, “HL” or “HM” mode:  
If “Automatic” is selected, the title will be recorded with the original aspect ratio.
- “XP”, “SP”, “LP” or “FR (recordings less than 5 hours)” mode:  
If “Automatic” is selected, the title will be recorded with the original aspect ratio at the time when recording started (including when recording started at a commercial, etc.).
- “EP” or “FR (recordings 5 hours or longer)” mode:  
If “Automatic” is selected, aspect is fixed to 4:3.
- In the following cases, the programme will be recorded with the original aspect ratio.
  - **[BD-RE]** **[BD-R]** When the recording mode is set to “XP”, “SP”, “LP”, “EP” or “FR”
- In the following cases, aspect is fixed to 4:3.
  - When recording to a +R, +R DL and +RW.

### Chapter Creation

Set the Chapter Creation method.

- Even if “Automatic” is selected, depending on the programme to be recorded, the chapter may not be created correctly.

### Disc Speed for High Speed Copy

Select the speed of high-speed copying.

If “Normal ( Silent )” is selected, the time required for copying will be longer.

## HDD Management

---

Press and hold [OK] for 3 seconds to show the following settings.

### Delete all titles

Delete all titles (video) on the built-in HDD.

- Delete does not work if one or more titles are protected.

### Delete all photos

Delete all photos on the built-in HDD.

### Format HDD

**Formatting deletes all contents on the built-in HDD, and they cannot be restored. Check carefully before proceeding.**

## Settings for USB HDD

---

### USB HDD Registration

Register the USB HDD. (⇒ 72)

### USB HDD Disconnection

This function puts the USB HDD in a state in which it can be safely disconnected. (⇒ 71)

### USB HDD Management

Press and hold [OK] for 3 seconds to show the following settings.

### Delete all titles

Delete all titles on the USB HDD.

- Delete does not work if one or more titles are protected.

### Format USB HDD

**Formatting deletes all contents, and they cannot be restored. Check carefully before proceeding.**

### Cancellation of all USB HDD Registrations

This function cancels the registrations of all the USB HDDs registered on this unit.

Only do this if you are going to dispose of this unit.



- Before operation, perform “USB HDD Disconnection” (⇒ above) and remove the USB HDD.
- It is not possible to play back the content from a USB HDD whose registration has been cancelled.

## Basic Settings

### Picture

#### Still Mode

Select the type of picture shown when you pause play.

- **Field:**  
Select if jittering occurs when “Automatic” is selected. (The picture is coarser.)
- **Frame:**  
Select if small text or fine patterns cannot be seen clearly when “Automatic” is selected. (The picture is clearer and finer.)

### Sound

#### Dynamic Range Compression

To lower the dynamic range for playback (e.g., at night).

- This does not work depending on broadcasts and recorded titles.

#### Downmix

Select the downmix system of multi-channel to 2-channels sound.

- Select “Surround encoded”, when the connected equipment supports the virtual surround function.
- There is no effect on “Bitstream” via HDMI AV OUT and DIGITAL AUDIO OUT terminal.
- The audio will be output in “Stereo” in the following cases.
  - AVCHD playback
  - **BD-V** : Playback of clicking sound on the menu and audio with secondary video in picture-in-picture mode.

#### Bilingual Audio Selection

Select whether to record the audio type (“M1” or “M2”) when:

- File Conversion (⇒ 46)
- Copying to a DVD-R, DVD-RW, +R and +RW.

### Digital Audio Output

#### PCM Down Conversion

Select how to output audio with a sampling frequency of 96 kHz.

- **On:**  
Signals are converted to 48 kHz.  
(Choose when the connected equipment cannot process signals with a sampling frequency of 96 kHz.)
- **Off:**  
Signals are output as 96 kHz.
  - The signals will be converted to 48 kHz regardless of the setting in the following cases.
    - The signals have a sampling frequency of over 96 kHz.
    - The disc has copy protection.
    - “BD-Video Secondary Audio” is set to “On”. (**BD-V**) (⇒ below)

#### Dolby D / Dolby D + / Dolby TrueHD

#### DTS / DTS-HD

#### MPEG

#### HE-AAC

Select the audio signal to output.

- Select “PCM” when the connected equipment cannot decode the respective audio format.
- Not making the proper settings may result in noise.

#### BD-Video Secondary Audio

Turn on/off the clicking sound on the menu and audio with secondary video.

#### Audio Delay

Mis-sync between the video and audio is corrected by delaying the audio output.

#### Audio for HG / HX / HE / HL / HM Recording

If the programme has multi channel audio, priority is given to what you select.

- This setting will give effect in the following cases.
  - Timer recording (⇒ 30)
  - File Conversion (⇒ 46)
  - Normal speed copy in HG, HX, HE, HL or HM mode from a title recorded in DR mode. (⇒ 50, 53)

## Display

### On-Screen Information

Select the time until the channel information screen (⇒ 25) disappears automatically.

### Unit's Display

Changes the brightness of the unit's display.

- If "Automatic" is selected, the display turns dark during play and disappears when the unit is in standby mode. While using this mode, the standby power consumption can be reduced.
- When "Quick Start" is set to "Off" or "Timer Setting for Quick Start" (⇒ 86), the setting for this function is fixed to "Automatic".

### Screen Saver

This is to prevent burn-in on the screen.

## Connection

### 3D Settings

#### 3D Type

If 3D video cannot be played back in 3D, you may be able to play it in 3D by changing the setting.

- Change the settings for 3D on the TV also when "Side by side" is selected.

#### 3D AVCHD Output

If 2D AVCHD video is recognised as 3D video and cannot be played back correctly, you may be able to play it by changing the setting.

#### 3D Playback Message

Set to display or hide the 3D viewing warning screen.

### TV Aspect

Set to match the type of TV connected.

- 16:9:
- 4:3:

Side picture is trimmed for 16:9 picture.



The pictures may be shown in the letterbox style depending on the content.

- Letterbox:  
Black bands appear for 16:9 picture.



### Aspect for 4:3 Video

To play a 4:3 title, set how to show pictures on a 16:9 TV.

- 4:3:  
Picture output expands left or right.
- 16:9:  
Picture is output as original aspect with side panels.

### TV System

Set in accordance with the TV System for the connected TV.

### HDMI Connection

#### HDMI Video Format

You can only select items compatible with the connected equipment.

- If "Automatic" is selected, the output resolution best suited to the connected TV (1080p, 1080i, 720p or 576p/480p) is automatically selected.
- To enjoy High Quality Video up-converted to 1080p, you need to connect the unit to 1080p compatible HDTV. If this unit is connected to an HDTV through other equipment, it must also be 1080p compatible.

## Basic Settings

### 24p Output

When playing BD-Video recorded in 24 frames, this unit displays each frame at 1/24 second intervals—the same interval originally shot with the film movie.

- To use this function, you need to fulfill the following conditions.
  - “HDMI Video Format” set to “Automatic.” (⇒ 83)
  - Connect 24p compatible TV. (When connect 24p/4K compatible TV, video images are output in 24p/4K.)



- When BD-Video images other than 24p are played, images are output at 60p.
- This unit can not output 4K image when playing back in 3D.

### Deep Colour Output

This setting is for selecting whether to use Deep Colour output when a TV that supports Deep Colour is connected.

### HDMI Audio Output

Select “Off” when connected to an amplifier/receiver with a DIGITAL AUDIO OUT terminal.

### 7.1ch Audio Reformatting

#### BD-V

Surround sound with 6.1 ch or less is automatically expanded and played back at 7.1 ch.

- If “Off” is selected, sound is played over the original number of channels. (Note that in the case of 6.1 ch audio, playback will be at 5.1 ch)

Audio reformatting is enabled in the following cases:

- When you have selected “PCM” in “Digital Audio Output”. (⇒ 82)
- When the audio is Dolby Digital, Dolby Digital Plus, Dolby TrueHD or LPCM.

### Contents Type Flag

If “Automatic” is selected, the optimal method of playback depending on the TV (e.g. cinema) will automatically be selected (only when the TV supports Contents Type Flag).

### VIERA Link

Select “Off” when you do not want to use “HDAVI Control”.

## Network

### Easy Network Setting

Press [OK] to start Easy Network Setting. (⇒ 21)

### Network Settings

#### LAN Connection Mode

Select the LAN connection method.

#### Wireless Settings

This allows to set and check the connection settings of the Wireless router.

#### Connection Setting

The Wireless router connection wizard will be displayed.

#### Double Speed Mode Setting ( 2.4GHz )

When a 2.4 GHz wireless format is used, this setting sets the connection speed.

- If you connect using the “Double Speed Mode (40MHz)”, 2 channels use the same frequency band, and there is consequently a greater risk of reception interference. This can cause the connection speed to drop or the connection to become unstable.

## IP Address / DNS Settings

Check the connection of the network or set the IP address and DNS.

- To set the IP address and DNS
  - 1 Set "IP Address Auto-assignment" and "DNS-IP Auto-assignment" to "Off".
  - 2 Select the item, then press [OK] to show the respective setting.
- When the router's DHCP server function is not activated, check the numbers of other connected devices such as personal computers, then assign a number different from those of other devices for the "IP Address" and assign the same number for "Subnet Mask" and "Gateway Address".

## Proxy Server Settings

Check and set the connection to the Proxy server.

- Press [OK] to show the respective setting.

## Network Service Settings

### Second Screen Browsing

When this function is set to "On", you can enjoy the content you are viewing on a network service application of smartphone, etc. with the home network on the big screen of your TV.

### Lock

You can restrict using Network Service.

- PIN is required to change. (⇒ 24)

### Automatic Volume Control

Volume is adjusted automatically to the standard volume while using Network Service.

- Depending on contents, this function will not work.
- Select "Off" when the audio is warped.

## Remote Recording Function Settings

You must register to a service to use this function.

For details please check the following website.

<http://panasonic.jp/support/global/cs/>

(This site is in English only.)

### Remote Recording function

When you set a recording from a smartphone or a PC, etc. away from home, set this function to "On".

### Device ID

This is the device ID and device password required for registering to and using a service.

### Initialize Device Password

The device password for this unit is initialized.

- When you initialize the device password, you will not be able to use Remote Recording function. To use the Remote Recording function again, you must re-register to the service.

## Home Network Settings

You can set the DLNA (Server) function. (⇒ 64)

### Home Network function

You can switch between enable/disable of the DLNA (Server) and DMR (Media Renderer) function.

- If "On" is selected, the setting for "Quick Start" is fixed to "On". (⇒ 86)
- If "Off" is selected, the setting for "Remote Recording function" is fixed to "Off". (⇒ above)
- This cannot be set to "On" if the connection with the wireless broadband router is not encrypted in the wireless connection.

## Basic Settings

### Setting device name

It is also possible to change the name of this unit on the network.

- Select from a preset list  
Select the preset name, then press [OK].
- Create name  
Enter the name.  
Refer to "Entering text". (⇒ 91)

### Conversion Setting for DLNA

- On:  
When playing back on DLNA (Client) compatible equipment, this setting reduces the chance of break-ups and freezing of an image by lowering the image quality.



- When this is set to "On", switching the channel or starting playback will take longer.

### Resolution Setting for DLNA

When "Conversion Setting for DLNA" is set to "On", select the image quality.

### Registration type for remote devices

- Automatic:  
All connected devices on the same network can access this unit.
- Manual:  
Only registered devices can access this unit.

### Remote device list

- To register equipment manually
  - 1 Select the device name or the MAC Address for the device you want to register, then press [OK].
  - 2 Select "Yes", then press [OK].
- To deregister equipment
  - 1 Select the registered equipment, then press [OK].
  - 2 Select "Yes", then press [OK].



- This function cannot be enabled when "Automatic" is selected in "Registration type for remote devices". (⇒ above)
- The maximum number of equipment that can be registered is 16.

## Others

### Standby Settings

#### Quick Start

- On:  
It is possible to start quickly from standby mode.
- Off:  
Power consumption in standby mode is minimized. (⇒ 104)  
However, startup time from standby mode will be longer.
- Timer Setting for Quick Start:  
"Quick Start" is activated when the set time comes.



- When "Home Network function" (⇒ 85) or "Remote Recording function" (⇒ 85) is set to "On", the setting for this function is fixed to "On".
- If "Off" or "Timer Setting for Quick Start" is selected, the setting for "Unit's Display" is fixed to "Automatic". (⇒ 83)

#### Automatic Standby

Set the time to turn the unit to standby mode automatically.

When the unit is not operating, the unit will be turned to standby mode once the set time has passed.

- When "REWIND LIVE TV" is set to "On" (⇒ 81), "Off" cannot be selected.

#### Automatic Standby after OTR

- On:  
This unit is turned to standby mode when it is not operated for approximately 5 minutes after completing "Automatic Stop" or "Recording Time" (⇒ 28).

### Automatic Standby after Copy

---

- On:

This unit is turned to standby mode when it is not operated for approximately 5 minutes after completing copy (⇒ 50, Copying from media other than HDD with DIRECT NAVIGATOR, Copying titles with copying list).

### RF OUT ( Aerial Signal )

---

Set whether to output the broadcasting signal from RF OUT or not while in standby mode (When "Quick Start" is not activated).

- If "On" is selected, the aerial signal is output from this unit.

### Power Save for Network Standby

---

You can minimize power consumption in standby mode even when the "Quick Start" function is activated. (⇒ 104)



- When this is set to "On", startup time when operating [GUIDE] and [DIRECT NAVIGATOR] from standby mode will be longer.

### Remote Control

---

Change the remote control code on the main unit and the remote control if you place other Panasonic products close together.

- Use "BD 1", the factory set code, under normal circumstances.
  - 1 Select the code, then press [OK].
  - 2 While pressing [OK], press and hold the number button ([1] to [6]) for more than 5 seconds.
  - 3 Press and hold [OK] for more than 5 seconds.
  - 4 Press [OK].

### Clock

---

If the time is not set correctly, use the settings listed in the method below.

- Automatic
 

This unit usually obtains time and date information from digital broadcasts.
- Time Zone
 

When the time is not correct, set "Time Zone". (GMT - 6 to + 6)
- Manual Setting
  - 1 Select "Off" of "Automatic", then press [OK].
  - 2 Select the item you want to change.
  - 3 Change the setting.
  - 4 Press [OK] when you have finished the settings.

## Basic Settings

### Owner ID

In order to prevent another person from using this unit if it is stolen, you can set a PIN and input your personal information (NAME, HOUSE NO, POSTCODE).

**Once the PIN has been set, you cannot return to the factory preset. Make sure not to forget this.**

### PIN Entry

You can set/change the PIN for parental control.

- 1 Enter your 4-digit PIN with the number buttons.
  - 2 Enter the new 4-digit PIN with the number buttons.
    - **Make a note of PIN in case you forget it.**
- e.g.,

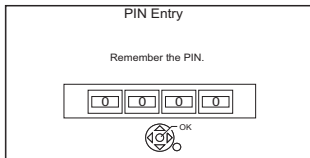

- 3 Press [OK].

## System Update

### Software Update in Standby

When you set this unit to standby mode, software (firmware) updates (⇒ 93) are downloaded automatically at the time you have specified.

### Software Update Now ( Broadcast )

Refer to "Software (Firmware) Update".  
(⇒ 93)

### Software Update Now ( Internet )

Refer to "Software (Firmware) Update".  
(⇒ 93)

### Software Licence

Information about the software licence is displayed.

## System Information

Display Software (firmware) version, HDAVI Control version, Wireless Module version (When using wireless connection only), and terminal ID (ESN) of this unit.

## Initialize

### Shipping Condition

All the settings except for some settings return to the factory preset.

- The timer recording programmes are also cancelled.
- The device password is also initialized.  
(⇒ 85)

### Default Settings

All the settings other than the tuning settings, clock settings, disc language settings, parental control settings, remote control code, device password, etc. return to the factory presets.



# Other operations

## Media management

**BD-RE** **BD-R** **RAM** **DVD-R** **DVD-RW** **+R** **+RW**  
**SD**

- 1 Press [FUNCTION MENU].
- 2 Select "Media", then press [OK].
- 3 Select the media, then press [OK].
- 4 Select the management item, then press [OK].
  - Selectable items will change depending on the selected item and inserted media.

### Disc Name

**BD-RE** **BD-R** **RAM** **DVD-R** **DVD-RW** **+R** **+RW**

This function is to name a disc.  
 Refer to "Entering text". (⇒ 91)

- The disc name is displayed in the Blu-ray Disc Management/DVD Management window.
- **DVD-R** **DVD-RW** **+R** With a finalised disc, the name is displayed on the Top Menu.
- **+RW** The disc name is displayed only if you play the disc on other equipment after creating Top Menu.



- Do not perform this operation before copying HD Video (AVCHD) to DVD-R or DVD-R DL. (⇒ 55)

## Disc Protection

**BD-RE** **BD-R** **RAM**

Select "Yes", then press [OK].  
 e.g.,

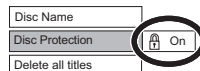

- To release the protection  
 Repeat the same steps.
  - The screen icon will be switched to "Off".

## Delete all titles

**BD-RE** **BD-R** **RAM**

- 1 Select "Yes", then press [OK].
- 2 Select "Start", then press [OK].



- Photo data (JPEG/MPO) or computer data cannot be deleted.

## Other operations

### Create Top Menu

**+RW**

You can create Top Menu for displaying on other equipment.

Make selections from “Top Menu” and “Auto-Play Select” before creating Top Menu.

- 1 Select “Yes”, then press [OK].
- 2 Select “Start”, then press [OK].
- 3 Press [OK].



- You cannot use the Top Menu for playing on this unit.
- The created menu is deleted when you record or edit the disc.

### Format Disc/Format Card

**BD-RE** **RAM** **DVD-RW** **+RW** **SD**

**BD-R** **+R** (New disc only)

**Formatting deletes all contents (including computer data), and they cannot be restored. Check carefully before proceeding.**

- 1 Select “Yes”, then press [OK].
- 2 Select “Start”, then press [OK].
- 3 Press [OK].

### **RAM** To stop formatting

Press [BACK/RETURN ⊖].

- You can cancel formatting if it takes more than 2 minutes. The disc must be reformatted if you do this.



- The contents are deleted when you format a disc or card even if you have set protection.
- **RAM** Formatting normally takes a few minutes; however, it may take up to a maximum of 70 minutes.
- **Do not disconnect the AC mains lead while formatting.** This can render the disc or the card unusable.
- When a disc or card has been formatted using this unit, it may not be possible to use it on any other equipment.
- It will become DVD Video format when a DVD-RW recorded in DVD Video Recording format is formatted with this unit.

### Top Menu

**DVD-R** **DVD-RW** **+R** **+RW**

You can select the background for DVD-Video Top Menu.

Select the background, then press [OK].

### Auto-Play Select

**DVD-R** **DVD-RW** **+R** **+RW**

You can select whether to show the Top Menu after finalising or creating Top Menu.

Select “Top Menu” or “Title 1”, then press [OK].

#### **Top Menu:**

The Top Menu appears first.

#### **Title 1:**

The disc content is played without displaying the Top Menu.

## Finalise

**DVD-R** **DVD-RW** **+R** (You can play the disc on compatible DVD players by finalising it on the unit.)

**BD-R** (Finalising BD-R prevents accidental recording or editing.)

- 1 Select "Yes", then press [OK].
- 2 Select "Start", then press [OK].
- 3 Press [OK].

## After finalising

- **BD-R** **DVD-R** **+R** The disc becomes play-only and you can no longer record or edit.
- **DVD-RW** You can record and edit the disc after formatting.



- You cannot cancel finalising.
- Finalising takes up to 15 minutes (Up to 60 minutes in case of DVD-R DL and +R DL).
- **Do not disconnect the AC mains lead while finalising.** This can render the disc unusable.
- Depending on the disc, it may take longer than displayed on the confirmation screen (approximately four times longer).
- You cannot finalise discs recorded on other manufacturer's equipment.
- **DVD-R** **DVD-RW** **+R** If you finalise discs recorded on Panasonic equipment other than this unit, the background selected as "Top Menu" may not be displayed.
- Discs finalised on this unit may not be playable on other players due to the condition of the recording.

## Entering text

### Preparation

- Show the "Enter Title Name" screen, etc.

- 1 Select a character, then press [OK]. Repeat this step to enter other characters.

e.g.,

Name field: shows the text you have entered

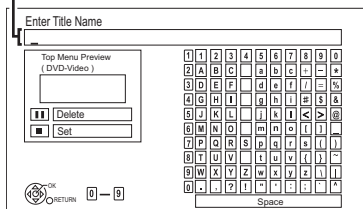

- To delete a character: Select the character in the name field, then press [PAUSE ■].

- To enter characters with number buttons: e.g., entering the letter "R"

- 1 Press [7] to move to the seventh row.
- 2 Press [7] twice to highlight "R".
- 3 Press [OK].

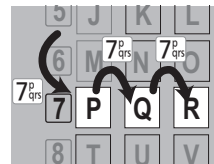

- 2 Press [STOP ■] (Set). "Writing..." appears then the screen returns to the previous screen and so on.

### To end partway

Press [BACK/RETURN ⊖]. (Text is not added.)



- The maximum number of characters depends on the media.
- If a name is long, parts of it may not be shown in some screens.

## Other operations

### Switching the aspect ratio of the screen

When the image does not match the screen size of the TV, you can enlarge the image to fill the screen.

- 1 Press [OPTION].
- 2 Select "Playback Settings" in "Playback Menu", then press [OK].
- 3 Select "Aspect" in "Basic Operation", then press [OK].
- 4 Select the item, then press [OK].

#### Normal:

Normal output

#### Side cut:

The black bars on the right and left sides of the 16:9 image disappear and the image is enlarged.

#### Zoom:

The black bars on the top and bottom sides of the 4:3 image disappear and the image is enlarged.

### HOLD function

The HOLD function deactivates all buttons on the unit and remote control.

Press and hold [OK] and [BACK/RETURN ⊖] simultaneously until "X HOLD" appears on the unit's display.

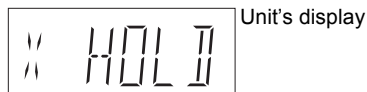

#### To cancel the HOLD function

Press and hold [OK] and [BACK/RETURN ⊖] simultaneously until "X HOLD" disappears.



- This function does not work when watching 3D programme and playing back 3D title or 3D photo.
- It may also be adjusted using the screen mode of the TV etc.
- The screen mode is switched to "Normal" in the following situations:
  - when you change the channel
  - when you start or end the playback of a title
  - when you switch the unit on or to standby mode.
- **BD-V** **DVD-V** "Side cut" does not have any effect.
- When "TV Aspect" (⇒ 83) is set to "Pan & Scan" or "Letterbox", the "Zoom" effect is disabled.

# Software (Firmware) Update

**You cannot operate the unit until the update is complete. Don't remove the AC mains lead during the update. Removing the AC mains lead while the update is in progress may damage the unit.**

**If a software (firmware) update is available, a notification is displayed.**

New software version has been found.  
The software will be updated automatically after this unit is switched to standby.  
Do not disconnect the AC mains lead.

Software of this unit can be updated automatically by the following methods at the specified time.  
(Default setting is 3 a.m. ⇒ 88, Software Update in Standby)

- From broadcasts
  - From Internet\*
- To update the software (Firmware) immediately, use the following function:
    - Software Update Now ( Broadcast ):  
Software of this unit will be updated from broadcasts if update information is detected.
    - Software Update Now ( Internet )\*:  
Software of this unit will be updated from Internet if update information is detected.
- \* Network connection and setting are required.  
(⇒ 17, 21)

Update of the software (firmware) will start when the unit is turned to standby mode.

## The unit's display during the update

e.g.,

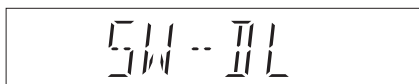

- When "FINISH" is displayed, update of the software (firmware) has completed.



- It may take up to a few hours until the update is completed depending on the network or broadcast environment.
- The timer recording always takes preference over the software (Firmware) download; if the timer recording is scheduled to start, the downloading will be performed at the next opportunity.
- You can also download the latest software (firmware) from the following website.  
<http://panasonic.jp/support/global/cs/>

# Troubleshooting guide

Before requesting service, make the following checks. If the problem still persists, consult your dealer for instructions.

Updating to the latest software (firmware) may solve the problem. (⇒ 93)

## The followings do not indicate a problem with this unit:

- Regular disc rotating sounds or HDD rotating sounds.
- Poor reception due to atmospheric conditions.
- Image disturbance during search.
- Image disturbance when replacing 3D discs.
- Interruptions in reception due to periodic broadcasting breaks.
- When you switch the unit on or to standby mode, there may be an unexpected sound.

## General operation

### The unit does not work.

- Check the connections. (⇒ 14)
- One of the unit's safety devices may have been activated.

Reset the unit as follows:

- 1 Press [⏻/|] on the main unit to switch the unit to standby.
  - If the unit does not switch to standby, press [⏻/|] on the main unit for about 3 seconds. The unit is forcibly switched to standby. Alternatively, disconnect the AC mains lead, wait one minute, then reconnect it.
- 2 Press [⏻/|] on the main unit to switch it on. If the unit still cannot be operated, consult the dealer.

### Cannot eject a disc.

- 1 While the unit is in standby mode, press and hold [OK], the yellow button and the blue button at the same time for more than 5 seconds.
  - "00 RET" is displayed on the unit's display.
- 2 Repeatedly press [▶] (right) until "06 FTO" is displayed on the unit's display.
- 3 Press [OK].

### The unit is switched to standby mode automatically.

- VIERA Link has worked. (⇒ 73, Power off link)

### The remote control does not work.

- The remote control and main unit are using different codes. Change the code on the remote control.



Unit's display

Press and hold [OK] and the indicated number button at the same time for more than 5 seconds. (⇒ 87)

- Software (firmware) is updating when "UPD □/□" is displaying on the unit's display. Wait until the update is completed. (⇒ 93)
- The HOLD function is activated. (⇒ 92)

### Startup is slow.

- Startup takes time in the following situations:
  - A disc is inserted.
  - The clock is not set.
  - Immediately after a power failure or the AC mains lead is connected.
  - When a BD-J application is executing.
  - When the "Quick Start" is not activated. (⇒ 86)
- Startup of this unit may be slower depending on the TV settings.

## Displays

### "0:00" is flashing on the unit's display.

- Set the clock. (⇒ 76, 87)

### The clock does not display on the unit when switched to standby.

- The clock does not display when "Unit's Display" is set to "Automatic". (⇒ 83)

## TV screen and video

### Screen size is wrong.

- Check the "TV Aspect" or "Aspect for 4:3 Video". (⇒ 83)
- Adjust the aspect ratio setting on TV.
- Adjust the aspect ratio setting on this unit. (⇒ 92)
- If you connect to 4:3 TV, set "HDMI Video Format" to "576p/480p". (⇒ 76, 83)
- Check "Aspect for Recording" before recording or file conversion. (⇒ 76, 81)

### The black screen appears on the TV.

- This phenomenon may occur, depending on the TV setting, when "Quick Start" is activated. Depending on the TV, this phenomenon may be prevented by reconnecting to a different HDMI input terminal.

### TV reception is not displayed.

- Broadcast signals are not output from this unit's RF OUT terminal. Select "On" in "RF OUT ( Aerial Signal )". (⇒ 76, 87)

### Picture does not appear with the HD quality although HD setting was made.

- The pictures are output with 576p/480p depending on the title.

### The screen changes automatically.

- If "Screen Saver" is set to "On", the screen saver function will be activated when there is no operation for 5 minutes or more. (⇒ 83)

### There is a lot of image lag when playing video.

- Set to "0" all items in the "Noise Reduction". (⇒ 75)
- Set "Audio Delay". (⇒ 76, 82)

## Troubleshooting guide

### The images do not appear on the TV.

#### The picture is distorted during play, or video will not play correctly.

- Check the connections. (⇒ 14)
- Check the settings of the connected TV, etc.
- An incorrect resolution is selected in “HDMI Video Format”. Reset the setting as follows:
  - 1 While the unit is on, press and hold [OK], the yellow button and the blue button at the same time for more than 5 seconds.
    - “00 RET” is displayed on the unit’s display.
  - 2 Repeatedly press [▶] (right) until “04 PRG” is displayed on the unit’s display.
  - 3 Press and hold [OK] for at least 3 seconds. Set the item again. (⇒ 76, 83)
    - When Dolby Digital Plus, Dolby TrueHD, and DTS-HD® audio are not output properly, select “Yes” in “Default Settings” and make proper settings. (⇒ 76, 88)
- The unit’s TV System is different from that of the disc. Change the TV System. (⇒ 83, TV System)
- Picture may not be seen when more than 4 devices are connected with HDMI cables. Reduce the number of connected devices.
- The picture may be distorted or a black screen may appear between scenes recorded with different aspect ratios.
- Set “Deep Colour Output” (⇒ 76, 84) or “Contents Type Flag” (⇒ 76, 84) to “Off”.

### 3D video is not output correctly.

- 3D video may be output correctly by changing the following settings:
  - “3D Type” of “3D Settings” (⇒ 76, 83)
  - “Signal Format” (⇒ 43, 3D settings during playback)
- Check the settings of the connected TV.
- When a non-3D compatible amplifier/receiver is connected between this unit and a TV, 3D video is not output. (⇒ 16)
- When the amplifier/receiver which is connected between this unit and a TV is off, 3D video is not output. (⇒ 15)
- 3D discs may not be played back correctly due to the settings of the TV.
- When “HDMI Audio Output” is set to “Off”, 3D video may not be output correctly. (⇒ 84)

---

### The same video is displayed in each left and right half of the screen.

- This is a 3D programme of the Side-by-Side type. Change the setting as follows if connecting with a 3D compatible TV:
  - 1 Press [OPTION].
  - 2 Select “Playback Settings” in “Playback Menu”, then press [OK].
  - 3 Select “3D Settings”, then press [OK].
  - 4 Select “Side by side” in “Signal Format”, then press [OK].



## Sound

### No sound.

#### Distorted sound.

- Check the connections. (⇒ 14)
- Check the settings of the connected TV, etc.
- Select the audio with “Multi Audio”. (⇒ 26, 42)
- To output audio from a device connected with an HDMI cable, set “HDMI Audio Output” to “On”. (⇒ 76, 84)

### Cannot change audio channel.

- You cannot change the audio channel if “Digital Audio Output” is set to “Bitstream” (⇒ 82)

## Recording, timer recording and copying

### Cannot record.

#### Cannot copy.

- Some broadcasts are copyright protected.
- You cannot record to the disc by pressing the [REC ●] or timer recording.
- The disc is protected. (⇒ 89)
- **DVD-R** **DVD-RW** **+R** **+RW** Since it will copy to HDD temporarily, copying is not possible if there is insufficient available capacity on the HDD.
- **DVD-R** **DVD-RW** **+R** **+RW** Copying or editing may not be possible on these discs after ejecting and loading the disc or switching the unit on or to standby mode for approximately 30 times after being copied to.
- This unit cannot record/copy NTSC signals to discs that already have PAL signal recordings.

### Timer recording does not work properly.

- Failed timer recordings are displayed in grey with  on the Timer Recording screen. (⇒ 35)  
When you programme a timer recording, check the screen icons. If “!” is displayed, this timer programme may not be recorded because:
  - there is not enough space left.
  - the number of possible titles has reached its maximum.
  - programmes are deactivated, etc.
- Because the actual broadcast time may be different from the time displayed on the TV Guide, we recommend you set the start time earlier and the end time later by some minutes, up to a maximum of 10 minutes.

### The timer recording programmed via Network Service does not work properly.

- Timer recording programmed via Network Service will be recorded with the same conditions as those of manual timer recording, and some functions such as “Guide Link” (⇒ 31) does not work.

## Troubleshooting guide

### Auto Renewal Recording does not work properly.

- The programme will not be overwritten in the following cases:
  - the programme is protected
  - any programme is being played back or copied
  - a screen such as DIRECT NAVIGATOR is displayed

Instead, the programme will be saved as a separate programme and that will be overwritten.

### A part or whole of a recorded title has been lost.

- If there is a power failure or the AC mains lead is disconnected from the household mains socket while recording or editing, the title may be lost or the HDD may become unusable. We cannot offer any guarantee regarding lost programmes.

### An unusually loud sound is coming from the rotating disc.

- If you want copy to perform more quietly, select "Normal ( Silent )" in "Disc Speed for High Speed Copy". (⇒ 76, 81)

### The time recorded on the disc and the available time shown do not add up.

- **DVD-R** **+R** If you record or edit many times, the remaining capacity is reduced and then recording or editing may be disabled.
- Available disc space display may be different from actual.

## Play

### Cannot play back.

- The disc is dirty. (⇒ 10)
- The disc is scratched or marked.
- The disc may not be able to play back if it was not finalized or a Top Menu was not created on the equipment used for recording.

### Audio and video momentarily pause.

- DVD-R DL and +R DL discs have two writable layers on one side. Video and audio may momentarily cut out when the unit is switching layers.

### BD-Video or DVD-Video is not played.

- Ensure the disc is for the correct BD-Video region code or DVD-Video region number, and is not defective.

### You have forgotten your rating PIN number for parental control.

- The PIN number for parental control and the rating level return to the factory preset. The default PIN number is "0000".
  - 1 While the unit is on, press and hold [OK], the yellow button and the blue button at the same time for more than 5 seconds.
    - "00 RET" is displayed on the unit's display.
  - 2 Repeatedly press [▶] (right) until "03 VL" is displayed on the unit's display.
  - 3 Press [OK].
    - "INIT" is displayed on the unit's display.

**Image for the Quick View is not smooth.**

- Image may not be played back smoothly in case of high definition titles.

**Cannot play the disc on other players.**

- Refer to "Play on other players". (⇒ 9)

**Edit****The available recording time does not increase even after deleting titles on the disc.**

- **BD-R** **DVD-R** **+R** Available space on the disc does not increase even after deleting titles.
- **DVD-RW** **+RW** Available space on the disc increases when you delete the last title.

**Cannot edit.**

- You may not be able to edit on the HDD if there is no available space. Delete any unwanted titles to create empty space. (⇒ 44)

**Cannot create a video playlist.**

- Creation or editing of playlists cannot be done on this unit.

**Photo****The contents of the SD card cannot be read.**

- Remove the card from the slot and then insert again. If this does not solve the problem, switch the unit to standby mode and turn it on again.

**Copying, deleting and setting protection takes a long time.**

- When there are a lot of folders and files, it may sometimes take a long time.

**Photos do not play back normally.**

- The images that were edited on the PC, such as Progressive JPEG, etc., may not play back. (⇒ 106)

## Troubleshooting guide

### USB

**This unit does not recognize the USB device correctly.**

- If inserted during playback the USB device may not be recognized by this unit.  
Disconnect and reconnect the USB device. If it still does not recognize the connection, switch the unit to standby mode and turn it on again.
- USB devices connected using a USB extension cable other than a dedicated one or a USB hub may not be recognized by this unit.
- This unit does not recognize USB HDDs other than those in which the size of one sector is 512-bytes or 4096-bytes. (For details, consult the dealer of your USB HDD.)

### TV Guide

**The TV Guide information is not displayed properly.**

- Set the clock correctly. (⇒ 76, 87, Clock)
- Some broadcast may not send programme information.
- There was a programme change, or TV Guide information from a broadcast station was possibly not correctly transmitted.
- If signal quality is bad, the TV Guide system may not be able to receive any data.

### Broadcast

**Picture regularly breaks up on some channels.**

- Adjust the reception with "Manual Tuning". (⇒ 76, 79)

**Picture very infrequently breaks up on some or all channels.**

- Electrical atmospheric interference caused by bad weather may cause pictures to break up and audio to mute or distort momentarily.

### VIERA Link

**VIERA Link does not work.**

- Some functions may not work depending on the version of "HDAVI Control" of the connected TV, etc. This unit supports "HDAVI Control 5" functions.
- Check the settings of the connected TV, etc.
- If the connection for the equipment connected with HDMI was changed, or if there was a power failure or the plug was removed from the household mains socket, "HDAVI Control" may not work.  
In this case, change TV (VIERA) setting for "HDAVI Control" again.
- This unit does not support "ONE TOUCH PLAY" function of the Panasonic AV Control Receiver.

## Network

### You cannot access this unit from DLNA compatible equipment on the network.

- Check the network connection and the network settings. (⇒ 17, 21)
- It may not be possible to connect depending on the types of the equipment or the status of the equipment.

### When using this unit as a server, video frames are dropped.

- Change the following settings:
  - Conversion Setting for DLNA (⇒ 76, 86)
  - Resolution Setting for DLNA (⇒ 76, 86)

### You cannot play contents properly from DLNA compatible equipment on the network.

- There may be some video that cannot be played back on DLNA compatible equipment depending on the equipment.
- Following titles may not be played back:
  - A title with access restriction
  - A title with incompatible format
- Playback via DLNA compatible equipment may not be performed when this unit is in the following conditions:
  - While playing back a BD-Video
  - While simultaneously performing High speed copy and recording
  - While displaying the Basic Settings menu
  - While executing functions using a network, such as Network Service
- You cannot play back simultaneously from two or more items of DLNA compatible equipment.
- If the DLNA compatible equipment is not capable of outputting HE-AAC audio format, etc., sound may not be played back.
- When "Automatic" is set for "Audio Description" (⇒ 26, 79), some parts of Home Network function cannot be used.  
Set "Audio Description" to "Off".

### When using Wireless LAN connection, video from the DLNA Certified media server is not played back or video frames are dropped during playback.

- Use 802.11n (2.4 GHz) Wireless router.  
Simultaneous use with a microwave, cordless telephone etc. at 2.4 GHz may result in connection interruptions or other problems.
- On the "Wireless Settings" screen (⇒ 84), the continuous lighting of at least four "Reception" indicators is the target for a stable connection. If three or fewer indicators are lit or the connection is being interrupted, change the position or angle of your Wireless router. If there is no improvement, connect to a wired network and perform the "Easy Network Setting" (⇒ 21, 84) again.

## Reset

### To return all the settings to the factory preset

- Perform "Shipping Condition" or "Default Settings". (⇒ 76, 88)

## Troubleshooting guide

### Messages on the unit's display

The following messages or service numbers appear on the unit's display when something unusual is detected.

#### BD □

("□" stands for a number.)

The remote control and main unit are using different codes. Change the code on the remote control. (⇒ 95)

#### CONV

Selected titles in the USB HDD are being converted. Do not disconnect the USB HDD from this unit.

#### GUIDE

TV Guide data is being downloaded.

#### HARD ERR

If there is no change after switching the unit to standby mode and turning it on, consult the dealer.

#### NoERAS

You cannot delete items on this disc. The disc may be damaged.

#### NoREAD

- The disc is dirty. (⇒ 10) The unit cannot record, play, or edit.
- The lens cleaner has finished cleaning.  
Press [**▲** OPEN/CLOSE] on the main unit to eject the disc.

#### NoWRIT

You cannot write to this disc. The disc may be damaged. Use a new disc.

#### PLEASE WAIT

- Displayed when the unit is started and is switched to standby mode.
- There was a power failure or the AC plug was disconnected while the unit was on. The unit is carrying out its recovery process. Wait until the message disappears.

#### PROG FULL

There are already 32 timer programmes. Delete unnecessary timer programmes. (⇒ 35)

#### REMOVE

The USB device is drawing too much power. Remove the USB device.

#### START

Update of the software (firmware) is started. You cannot operate the unit until the update is complete. (⇒ 93)

#### SW-DL

Software (firmware) is downloading. Download will stop when the unit is turned on, or the timer recording starts. (⇒ 93)

### UNSUPPORT

The media is not supported.

#### UPD □/□

("□" stands for a number.)

The software (firmware) is being updated. You cannot operate the unit until the update is complete. (⇒ 93)

#### U59

The unit is hot. The unit switches to standby for safety reasons. Wait for about 30 minutes until the message disappears. Install or place this unit with good ventilation.

#### U61

(When a disc is not inserted) A malfunction has occurred. The unit is trying to restore to the normal operation. Once the message disappears you can use the unit again. If it remains displayed, consult the dealer.

#### U76

HDMI cannot be output because it is connected to a model that does not support copyright protection.

#### U77

Due to the current disc not having authorised copyright information, video output is not performed.

#### U88

(When a disc is inserted) There was something unusual detected with the disc or the unit. The unit is trying to restore to the normal operation. Once the message disappears you can use the unit again. If it remains displayed, consult the dealer.

#### U99

The unit fails to operate properly. Press [**⏻**/I] on the main unit to switch the unit to standby mode. Now press [**⏻**/I] on the main unit again to turn the unit on.

#### X HOLD

The HOLD function is activated. (⇒ 92)

#### H□□ or F□□

("□" stands for a number.)

There is something unusual. (The service number displayed after H and F depends on the unit's condition.)

Reset the unit as follows:

- 1 Disconnect the plug from the household mains socket, wait a few seconds, then reconnect it.
  - 2 Press [**⏻**/I] to turn the power on. (The unit may be fixed.)
- Request service from the dealer. Inform the dealer of the service number when requesting service.

## When you experience problems with Easy Network Setting

If there is any problem, the following message is displayed on the screen.

### Wireless Settings

Display	Check the following
A conflict with other devices occurred.	<ul style="list-style-type: none"> <li>• Please wait a few moments, and then try again.</li> </ul>
A time out error occurred.	<ul style="list-style-type: none"> <li>• Setting of the Wireless router for MAC Address etc.</li> <li>• The signal may be weak.</li> <li>• The SSID and the encryption key of the Wireless router.</li> <li>• Please wait a few moments, and then try again.</li> </ul>
An authentication error or a time out error occurred.	
A device error occurred.	<ul style="list-style-type: none"> <li>• If the problem is not solved, consult your dealer.</li> </ul>

### Easy Network Setting ( Home Network Connection Check )

Display	Check the following
1. LAN cable connection or Wireless setting: "Fail" 2. IP address setting: "Fail" 3. Connection to gateway: "Fail"	<ul style="list-style-type: none"> <li>• Connection of the LAN cables (⇒ 17)</li> <li>• Settings of the hub and router</li> </ul>
1. LAN cable connection or Wireless setting: "Pass" 2. IP address setting: "Fail" 3. Connection to gateway: "Fail"	
1. LAN cable connection or Wireless setting: "Pass" 2. IP address setting: "Pass" 3. Connection to gateway: "Fail"	
1. LAN cable connection or Wireless setting: "Pass" 2. IP address setting: "Home network available" 3. Connection to gateway: "Fail"	<ul style="list-style-type: none"> <li>• Connection and settings of the hub and router</li> <li>• Settings of "IP Address / DNS Settings" (⇒ 76, 85)</li> </ul>
1. LAN cable connection or Wireless setting: "Pass" 2. IP address setting: "Home network available" 3. Connection to gateway: "Fail"	
1. LAN cable connection or Wireless setting: "Pass" 2. IP address setting: "Home network available" 3. Connection to gateway: "Fail"	

### Easy Network Setting ( Internet Connection Test )

Display	Check the following
Cannot find the server. (B019)	<ul style="list-style-type: none"> <li>• "Primary DNS" and "Secondary DNS" settings of "IP Address / DNS Settings" (⇒ 76, 85)</li> </ul>
No connection could be made to the server. (B020)	<ul style="list-style-type: none"> <li>• The server may be busy or the service may have been suspended. Please wait a few moments, and then try again.</li> <li>• Settings of "Proxy Server Settings" (⇒ 76, 85) and the router.</li> </ul>

# Specifications

Specifications are subject to change without notice.

## ■ General

Dimensions: 430 mm (W)  
59 mm (H)  
(excluding the projecting parts)  
238 mm (D)  
(including the projecting parts)  
256 mm (D)

Mass: Approx. 3.3 kg

Power supply: AC 220 V to 240 V, 50 Hz

Power consumption: Approx. 32 W

“Quick Start” is activated and “Power Save for Network Standby” is set to “Off”

Approx. 8 W

“Quick Start” is activated and “Power Save for Network Standby” is set to “On”

Approx. 6 W

“Quick Start” is not activated and

“RF OUT ( Aerial Signal )” is set to “Off”

Approx. 0.2 W

Operating temperature: 5 °C to 40 °C

Operating humidity range: 10 % to 80 % RH  
(no condensation)

## ■ TV system

Tuner System: DVB-T/T2

Country: UK

Channel Coverage: UHF 21~68

## ■ Recording system

DR mode: Partial TS

HG, HX, HE, HL, HM mode:

MPEG-4 AVC/H.264, Dolby Digital

XP, SP, LP, EP mode:

MPEG-2 (Hybrid VBR), Dolby Digital

## ■ Video/Audio terminals

AV input (21 pin): 1 pc.

Analogue Video input (PAL/NTSC):  
1 Vp-p (75 Ω)

Analogue Audio input (L/R)  
Standard: 0.5 Vrms

Full scale: 2.0 Vrms at 1 kHz (> 10 kHz)

Analogue audio L/R output (pin jack): 1 pc.

Analogue Audio output (L/R):  
Standard: 0.5 Vrms

Full scale: 2.0 Vrms at 1 kHz (< 1 kHz)

Digital audio output (optical): 1 pc.

PCM, Dolby Digital, DTS®, MPEG

Digital audio output (coaxial): 1 pc.

PCM, Dolby Digital, DTS®, MPEG

## ■ HDMI terminal

HDMI output (19 pin type A): 1 pc.

Output format:  
PCM, MPEG, Dolby Digital,

Dolby Digital Plus, Dolby TrueHD,

DTS®, DTS-HD High Resolution Audio™,

DTS-HD Master Audio™

• This unit supports “HDAVI Control 5”  
function.

## ■ Internal HDD capacity

1 TB

## ■ Other terminals

USB Port (Type A): 2 pcs.

SD Card Slot: 1 pc.

LAN (Ethernet) Port: 1 pc.

10BASE-T/100BASE-TX

## ■ Wireless LAN

Standard compliance: IEEE802.11a/b/g/n

Frequency range: 2.4 GHz/5 GHz band

Security\*:

WPA™/WPA2™

(Encryption type: TKIP/AES,

Authentication type: PSK)

WEP (64 bit/128 bit)

\* This unit supports WPA and WPA2  
encryption.



## ■ Recordable discs

BD-RE (SL/DL):	1-2X SPEED (Ver. 2.1)
BD-R (SL/DL):	1-2X SPEED (Ver. 1.1), 1-4X SPEED (Ver. 1.2), 1-6X SPEED (Ver. 1.3), 1-2X SPEED LTH type (Ver. 1.2), 1-6X SPEED LTH type (Ver. 1.3)
DVD-RAM:	2X SPEED (Ver. 2.0), 2-3X SPEED (Ver. 2.1), 2-5X SPEED (Ver. 2.2)
DVD-R (SL):	1X SPEED (Ver. 2.0), 1-4X SPEED (Ver. 2.0), 1-8X SPEED (Ver. 2.0), 1-16X SPEED (Ver. 2.1)
DVD-R (DL):	2-4X SPEED (Ver. 3.0), 2-8X SPEED (Ver. 3.0)
DVD-RW:	1X SPEED (Ver. 1.1), 1-2X SPEED (Ver. 1.1), 2-4X SPEED (Ver. 1.2), 2-6X SPEED (Ver. 1.2)
+R (SL):	2.4X SPEED (Ver. 1.0), 2.4-4X SPEED (Ver. 1.1), 2.4-8X SPEED (Ver. 1.2), 2.4-16X SPEED (Ver. 1.3)
+R (DL):	2.4X SPEED (Ver. 1.0), 2.4-8X SPEED (Ver. 1.1)
+RW:	2.4X SPEED (Ver. 1.1), 2.4-4X SPEED (Ver. 1.2)

## ■ Optical pick-up

System with 2 lenses, 3 integration units  
(405 nm wavelength for BDs,  
661 nm wavelength for DVDs,  
783 nm wavelength for CDs)

## ■ LASER specification

Class 1 LASER Product	
Wave length:	405 nm (BDs) 661 nm (DVDs) 783 nm (CDs)
Laser power:	

No hazardous radiation is emitted with  
the safety protection

## ■ Recording system

BD-RE (SL/DL):	Blu-ray Disc Rewritable Format
BD-R (SL/DL):	Blu-ray Disc Recordable Format
DVD-RAM:	DVD Video Recording format
DVD-R (SL/DL):	DVD-Video format, AVCHD format
DVD-RW:	DVD-Video format
+R (SL/DL), +RW	

## ■ Copying speed from HDD to BD-R in High Speed Copy

HDD (HM, 1 hour) → 6X Speed BD-R	
Copying speed:	60x
Required time:	Approx. 1 min.

- The above rate in the list indicates the shortest time and fastest speed required for copying one-hour title from HDD to the disc by High-Speed copying.
- The required amount of time and speed may vary depending on the conditions such as the area where information is written or unique feature on the disc.

## ■ Region code

DVD:	#2
BD:	Region B

## ■ Playable discs

BD-Video (Blu-ray 3D, BD-Live)	
BD-ROM Version 2.4	
DVD-Video:	DVD-Video format
CD-DA (Audio CD)	
BD-RE:	Ver. 2.1, JPEG*1, MPO*1
BD-RE DL:	Ver. 2.1, JPEG*1, MPO*1
BD-R:	Ver. 1.3, LTH type Ver. 1.3, Xvid*1, MKV*1
BD-R DL:	Ver. 1.3, Xvid*1, MKV*1
DVD-RAM:	DVD Video Recording format, AVCHD format, JPEG*2, MPO*2
DVD-R:	DVD-Video format*3, AVCHD format*3, JPEG*2, MPO*2, MP3*2, Xvid*2, MKV*2
DVD-R DL:	DVD-Video format*3, AVCHD format*3, JPEG*2, MPO*2, MP3*2, Xvid*2, MKV*2
DVD-RW:	DVD-Video format*3, DVD Video Recording format, AVCHD format*3
+R:	Video*3, AVCHD format*3
+R DL:	Video*3, AVCHD format*3
+RW:	Video*3, AVCHD format*3
CD-R/CD-RW:	CD-DA, JPEG*2, MPO*2, MP3*2, Xvid*2, MKV*2

\*1 BD disc needs to be based on UDF format.

\*2 DVD/CD discs need to be based on UDF or ISO9660 format.

\*3 Finalising is necessary.

## Specifications

### ■ SD Card

Compatible media:	SD Memory Card*
Format:	
SD Card:	only FAT12, FAT16
SDHC Card:	only FAT32
SDXC Card:	only exFAT
Data that can be played:	JPEG, MPO, AVCHD format, MPEG2, MP4

\* Includes SDHC/SDXC cards.

Includes mini type cards (need a miniSD™ adaptor).

Includes micro type cards (need a microSD™ adaptor).

### ■ USB device

USB standard:	USB2.0 High Speed
Format:	FAT12, FAT16, FAT32, NTFS
Data that can be played:	MP3, JPEG, MPO, Xvid, MKV, MP4, MPEG2

### Audio information

The audio output differs depending on which terminals are connected to the amplifier/receiver, and the setting on this unit. (⇒ 82, Digital Audio Output)

- The number of channels listed is the maximum possible number of output channels when connected to amplifier/receiver compatible with the respective audio format.

Terminal	Digital Audio Output	
	Bitstream	PCM
HDMI AV OUT	Output using original audio*1	BD-Video: 7.1ch PCM*1, 2
		DVD-Video: 5.1ch PCM
DIGITAL AUDIO OUT	Dolby Digital/ DTS Digital Surround™	Down-mixed 2ch PCM

\*1 When "BD-Video Secondary Audio" is set to "On", the audio will be output as Dolby Digital, DTS Digital Surround™ or 5.1ch PCM.

\*2 The audio output is amplified from 5.1ch or 6.1ch to 7.1ch depending on the DTS, Inc. specifications.

### Maximum numbers of titles that can be recorded

HDD	999 titles (When continuously recording for long durations, titles are automatically divided every 8 hours.)
BD-RE, BD-R	200 titles on one disc.
DVD-RAM, DVD-R, DVD-RW	99 titles on one disc.
+R, +RW	49 titles on one disc.

### Information for the files other than recorded programmes

#### ■ JPEG/MPO

Playable media: HDD, BD-RE (SL/DL), DVD-RAM, DVD-R, DVD-R DL, CD-R, CD-RW, SD Card, USB device

Compatible pixels:

Between 34×34 and 8192×8192 pixels  
(Sub sampling is 4:2:2 or 4:2:0)

Files: JPEG conforming DCF  
(Design rule for Camera File system)  
MPO conforming MPF  
(Multi Picture Format)

Maximum numbers of folders and files:

Media	Maximum folders	Maximum files
HDD	–	20000
BD-RE	500	10000
DVD-RAM	500	10000
DVD-R	500	10000
CD-R, CD-RW	500	10000
SD Card	500	10000
USB device	500	10000

- This unit is not compatible with Motion JPEG or Progressive JPEG.

### ■ MP3

Playable media: HDD, DVD-R, DVD-R DL, CD-R, CD-RW, USB device

Compression rate: 32 kbps to 320 kbps

Sampling rate: 16 kHz, 22.05 kHz, 24 kHz, 32 kHz, 44.1 kHz, 48 kHz

Maximum numbers of folders and files:

Media	Maximum folders	Maximum files
HDD	–	40000
DVD-R	300	3000
CD-R, CD-RW	300	3000
USB device	300	3000

### ■ MKV

Playable media: BD-R (SL/DL), DVD-R, DVD-R DL, CD-R, CD-RW, USB device

MPEG-4 AVC (H.264) profile is up to High Profile, Level 4.

AAC-LC, MP3, Dolby Digital audio, DTS®, PCM, Vorbis and FLAC can be decoded.

Maximum number of folders: 300 folders (including the root folder)

Maximum number of files: 200 files

### ■ MP4

Playable media: SD Card, USB device

MPEG-4 AVC/H.264:

Up to High Profile, Level 4.2

Video resolution: Up to 1920×1080

MPEG-4 AAC-LC

Sampling rate: 8 kHz to 48 kHz

Number of audio channel: 1 or 2

### ■ HD-Video (High Definition)

Playable media: SD Card, USB device

Codec: MPEG-4 AVC/H.264

File Format: AVCHD format conforming

## Specifications

### Recording modes and approximate recording times

Depending on the content being recorded, the recording time may become shorter than indicated.

#### ■ DR mode

Recording Mode	HDD (1 TB)	BD-RE, BD-R	
		Single Layer (25 GB)	Dual Layer (50 GB)
DR (HD quality)	259 hours	6 hours 30 min.	13 hours
DR (SD quality)	518 hours	13 hours	26 hours

#### • Recording time of DR mode may vary depending on the bit rate of broadcasting:

- High Definition (HD) quality: estimated bit rate is 8 Mbps
- Standard Definition (SD) quality: estimated bit rate is 4 Mbps

#### • Regarding recording time remaining:

Remaining time in the DR mode is calculated with a bit rate of 8 Mbps. But the bit rate differs depending on the broadcast, so the displayed remaining time might be different from the actual remaining time.

#### ■ HG, HX, HE, HL, HM modes

Recording Mode	HDD (1 TB)	BD-RE, BD-R	
		Single Layer (25 GB)	Dual Layer (50 GB)
HG	157 hours	4 hours	8 hours
HX	235 hours	6 hours	12 hours
HE	353 hours	9 hours	18 hours
HL	472 hours	12 hours	24 hours
HM	684 hours	17 hours 30 min.	35 hours

#### ■ XP, SP, LP, EP modes

Recording Mode	HDD (1 TB)	BD-RE, BD-R	
		Single Layer (25 GB)	Dual Layer (50 GB)
XP	215 hours	5 hours 15 min.	10 hours 30 min.
SP	431 hours	10 hours 30 min.	21 hours
LP	862 hours	21 hours	42 hours
EP	1724 hours	42 hours	84 hours

Recording Mode	DVD-RAM	
	Single-sided (4.7 GB)	Double-sided (9.4 GB)
XP	1 hour	2 hours
SP	2 hours	4 hours
LP	4 hours	8 hours
EP	8 hours	16 hours

Recording Mode	DVD-R, DVD-RW, +R, +RW (4.7 GB)	DVD-R DL, +R DL (8.5 GB)
XP	1 hour	1 hour 45 min.
SP	2 hours	3 hours 35 min.
LP	4 hours	7 hours 10 min.
EP	8 hours	14 hours 20 min.



#### • Regarding recording time remaining:

This unit records using a VBR (Variable bit rate) data compression system to vary recorded data segments to match video data segments which may cause differences in the displayed amount of time and space remaining for recording.

## Language code list

Abkhazian:	6566	Lingala:	7678
Afar:	6565	Lithuanian:	7684
Afrikaans:	6570	Macedonian:	7775
Albanian:	8381	Malagasy:	7771
Amharic:	6577	Malay:	7783
Arabic:	6582	Malayalam:	7776
Armenian:	7289	Maltese:	7784
Assamese:	6583	Maori:	7773
Aymara:	6589	Marathi:	7782
Azerbaijani:	6590	Moldavian:	7779
Bashkir:	6665	Mongolian:	7778
Basque:	6985	Nauru:	7865
Bengali; Bangla:	6678	Nepali:	7869
Bhutani:	6890	Norwegian:	7879
Bihari:	6672	Oriya:	7982
Breton:	6682	Pashto, Pushto:	8083
Bulgarian:	6671	Persian:	7065
Burmese:	7789	Polish:	8076
Byelorussian:	6669	Portuguese:	8084
Cambodian:	7577	Punjabi:	8065
Catalan:	6765	Quechua:	8185
Chinese:	9072	Rhaeto-Romance:	8277
Corsican:	6779	Romanian:	8279
Croatian:	7282	Russian:	8285
Czech:	6783	Samoan:	8377
Danish:	6865	Sanskrit:	8365
Dutch:	7876	Scots Gaelic:	7168
English:	6978	Serbian:	8382
Esperanto:	6979	Serbo-Croatian:	8372
Estonian:	6984	Shona:	8378
Faroese:	7079	Sindhi:	8368
Fiji:	7074	Singhalese:	8373
Finnish:	7073	Slovak:	8375
French:	7082	Slovenian:	8376
Frisian:	7089	Somali:	8379
Galician:	7176	Spanish:	6983
Georgian:	7565	Sundanese:	8385
German:	6869	Swahili:	8387
Greek:	6976	Swedish:	8386
Greenlandic:	7576	Tagalog:	8476
Guarani:	7178	Tajik:	8471
Gujarati:	7185	Tamil:	8465
Hausa:	7265	Tatar:	8484
Hebrew:	7387	Telugu:	8469
Hindi:	7273	Thai:	8472
Hungarian:	7285	Tibetan:	6679
Icelandic:	7383	Tigrinya:	8473
Indonesian:	7378	Tonga:	8479
Interlingua:	7365	Turkish:	8482
Irish:	7165	Turkmen:	8475
Italian:	7384	Twi:	8487
Japanese:	7465	Ukrainian:	8575
Javanese:	7487	Urdu:	8582
Kannada:	7578	Uzbek:	8590
Kashmiri:	7583	Vietnamese:	8673
Kazakh:	7575	Volapük:	8679
Kirghiz:	7589	Welsh:	6789
Korean:	7579	Wolof:	8779
Kurdish:	7585	Xhosa:	8872
Laotian:	7679	Yiddish:	7473
Latin:	7665	Yoruba:	8979
Latvian, Lettish:	7686	Zulu:	9085

# Licenses

<p>"AVCHD", "AVCHD 3D", "AVCHD Progressive" and "AVCHD 3D/Progressive" are trademarks of Panasonic Corporation and Sony Corporation.</p>	
<p>Copyright 2004-2014 Verance Corporation. Cinavia™ is a Verance Corporation trademark. Protected by U.S. Patent 7,369,677 and worldwide patents issued and pending under license from Verance Corporation. All rights reserved.</p>	
<p>DLNA, the DLNA Logo and DLNA CERTIFIED are trademarks, service marks, or certification marks of the Digital Living Network Alliance.</p>	
<p>DVB and the DVB logos are trademarks of the DVB Project.</p>	
<p>Manufactured under license from Dolby Laboratories. Dolby and the double-D symbol are trademarks of Dolby Laboratories.</p>	
<p>For DTS patents, see <a href="http://patents.dts.com">http://patents.dts.com</a>. Manufactured under license from DTS Licensing Limited. DTS, DTS-HD, the Symbol, &amp; DTS and the Symbol together are registered trademarks, and DTS-HD Master Audio   Essential is a trademark of DTS, Inc. © DTS, Inc. All Rights Reserved.</p>	
<p>"DVD Logo" is a trademark of DVD Format/Logo Licensing Corporation.</p>	
<p>MPEG Layer-3 audio coding technology licensed from Fraunhofer IIS and Thomson.</p>	
<p>This product is licensed under the AVC patent portfolio license and VC-1 patent portfolio license for the personal and non-commercial use of a consumer to (i) encode video in compliance with the AVC Standard and VC-1 Standard ("AVC/VC-1 Video") and/or (ii) decode AVC/VC-1 Video that was encoded by a consumer engaged in a personal and non-commercial activity and/or was obtained from a video provider licensed to provide AVC/VC-1 Video. No license is granted or shall be implied for any other use. Additional information may be obtained from MPEG LA, LLC. See <a href="http://www.mpegla.com">http://www.mpegla.com</a>.</p>	
<p>SDXC Logo is a trademark of SD-3C, LLC.</p>	
<p>The Wi-Fi CERTIFIED Logo is a certification mark of the Wi-Fi Alliance. The Wi-Fi Protected Setup Mark is a mark of the Wi-Fi Alliance.</p>	
<p>"Wi-Fi", "Wi-Fi Protected Setup", "Wi-Fi Direct", "Miracast", "WPA" and "WPA2" are marks or registered marks of the Wi-Fi Alliance.</p>	
<p>HDAVI Control™ is a trademark of Panasonic Corporation.</p>	
<p>HDMI, the HDMI Logo, and High-Definition Multimedia Interface are trademarks or registered trademarks of HDMI Licensing LLC in the United States and other countries.</p>	
<p>Java is a registered trademark of Oracle and/or its affiliates.</p>	
<p>Windows is a trademark or a registered trademark of Microsoft Corporation in the United States and other countries.</p>	
<p>The Freeview service is subject to coverage. An aerial upgrade may be required. The FREEVIEW, FREEVIEW+, FREEVIEW HD and FREEVIEW+ HD words and logos are trade marks of DTV Services LTD. © DTV Services Ltd 2002, 2008.</p>	
<p>Android is a trademark of Google Inc.</p>	

Rovi and Rovi Guide are trademarks of Rovi Corporation and/or its subsidiaries.

The Rovi Guide system is manufactured under license from Rovi Corporation and/or its subsidiaries.

The Rovi Guide system is protected by patents and patent applications filed in the US, Europe, and other countries including one or more of the United States patents 6,396,546; 5,940,073; 6,239,794 issued to Rovi Corporation and/or its subsidiaries.



Rovi Corporation and/or its subsidiaries and related affiliates are not in any way liable for the accuracy or availability of the program schedule information or other data in the Rovi Guide system and cannot guarantee service availability in your area. In no event shall Rovi Corporation and/or its related affiliates be liable for any damages in connection with the accuracy or availability of the program schedule information or other data in the Rovi Guide system.

This product incorporates the following software:

- (1) the software developed independently by or for Panasonic Corporation,
- (2) the software owned by third party and licensed to Panasonic Corporation,
- (3) the software licensed under the GNU General Public License, Version 2.0 (GPL V2.0),
- (4) the software licensed under the GNU LESSER General Public License, Version 2.1 (LGPL V2.1), and/or
- (5) open source software other than the software licensed under the GPL V2.0 and/or LGPL V2.1.

The software categorized as (3) - (5) are distributed in the hope that it will be useful, but WITHOUT ANY WARRANTY, without even the implied warranty of MERCHANTABILITY or FITNESS FOR A PARTICULAR PURPOSE. Please refer to the detailed terms and conditions thereof shown in the Basic Settings menu.

At least three (3) years from delivery of this product, Panasonic will give to any third party who contacts us at the contact information provided below, for a charge no more than our cost of physically performing source code distribution, a complete machine-readable copy of the corresponding source code covered under GPL V2.0, LGPL V2.1 or the other licenses with the obligation to do so, as well as the respective copyright notice thereof.

Contact Information: [oss-cd-request@gg.jp.panasonic.com](mailto:oss-cd-request@gg.jp.panasonic.com)

The source code and the copyright notice are also available for free in our website below.  
<http://panasonic.net/avc/oss/>

MS/PlayReady/Final Product Labeling

This product contains technology subject to certain intellectual property rights of Microsoft. Use or distribution of this technology outside of this product is prohibited without the appropriate license(s) from Microsoft.

MS/PlayReady/End User Notices

Content owners use Microsoft PlayReady™ content access technology to protect their intellectual property, including copyrighted content. This device uses PlayReady technology to access PlayReady-protected content and/or WMDRM-protected content. If the device fails to properly enforce restrictions on content usage, content owners may require Microsoft to revoke the device's ability to consume PlayReady-protected content.

Revocation should not affect unprotected content or content protected by other content access technologies. Content owners may require you to upgrade PlayReady to access their content. If you decline an upgrade, you will not be able to access content that requires the upgrade.

Vorbis, FLAC, WPA Supplicant

The software licenses are displayed when "Software Licence" in the Basic Settings menu is selected. (⇒ 88)

# Index

- A**
- Aspect ..... 83, 92
  - Audio ..... 26, 42, 106
  - Audio Description ..... 26, 42, 79
  - Auto Setup ..... 19, 79
  - AVCHD ..... 36, 39, 55, 70
- B**
- Basic Settings ..... 76
  - BD-Video ..... 39
    - BD-Live ..... 40, 80
    - 3D ..... 43
- C**
- Channel information ..... 25
  - Channel List ..... 24, 78
  - Chapter ..... 38, 42, 47, 81
  - Child Lock ..... 79, 80
    - BD-Video Parental Control ..... 80
    - DVD-Video Parental Control ..... 80
    - HOLD function ..... 92
  - Clock ..... 87
  - Connection ..... 14
    - Network ..... 17
  - Copy ..... 48
    - HD Video (AVCHD) ..... 70
- D**
- Delete
    - Music ..... 63
    - Photo ..... 58
    - Video ..... 44
  - Delete BD-Video data ..... 40
  - Digital text (MHEG) ..... 26
  - Disc
    - Finalise ..... 91
    - Format ..... 90
    - Media information ..... 6
    - Protection ..... 89
  - DVD-Video ..... 39
- E**
- Easy setting ..... 19
  - Entering text ..... 91
- F**
- Favourites ..... 78
  - Finalise ..... 91
  - Format
    - Disc ..... 90
    - HDD ..... 81
    - SD Card ..... 90
    - USB HDD ..... 81
  - Freeview ..... 31
  - FUNCTION MENU ..... 23
- H**
- HDAVI Control ..... 73, 84
  - HDD
    - Format ..... 81
    - Media information ..... 6
- L**
- Language code list ..... 109
- M**
- Manual Tuning ..... 79
  - Media Renderer ..... 66
  - Menu screen ..... 39
  - Miracast™ ..... 66
  - MKV ..... 39
  - Multiroom TV Streaming ..... 64
  - Music ..... 60
- N**
- Network
    - BD-Live ..... 40
    - Connection ..... 17
    - Easy Network Setting ..... 21, 84
    - Miracast™ ..... 66
    - Network Service ..... 68
    - Smart Home Networking (DLNA) ..... 64, 85
    - Wi-Fi Direct™ ..... 67
- P**
- PAUSE LIVE TV ..... 27
  - Photo ..... 56
  - PIN ..... 24
  - Playback menu ..... 74
  - Protection
    - Disc ..... 89
    - Photo ..... 58
    - Video ..... 45
  - Pure Sound Mode ..... 80



<b>Q</b>	
<b>Quick Start</b>	<b>86</b>
<b>R</b>	
<b>Recording</b>	<b>28</b>
From external equipment	69
Recording mode	108
Timer recording	30
<b>Recording mode</b>	<b>108</b>
<b>Remote control</b>	<b>12</b>
HOLD function	92
Remote control code	87
TV operation	18
<b>Remote Recording</b>	<b>34</b>
<b>Reset</b>	<b>88, 98, 101</b>
<b>REWIND LIVE TV</b>	<b>27, 81</b>
<b>S</b>	
<b>SD Card</b>	
Format	90
Media information	6, 10
miniSD / microSD	10
<b>Setting</b>	
Auto Setup	19, 79
Easy setting	19
<b>Slideshow</b>	<b>56, 62</b>
<b>Smart Home Networking (DLNA)</b>	
Client	65
Media Renderer	66
Server	64, 85
<b>Software (Firmware) Update</b>	<b>93</b>
<b>T</b>	
<b>Timer recording</b>	<b>30</b>
<b>Top Menu</b>	
Create Top Menu	90
<b>Troubleshooting guide</b>	<b>94</b>
Easy Network Setting	103
Messages	102
<b>Tuning</b>	
Channel List	78
Channel Sorting by Region	79
Child Lock	79
Manual Tuning	79
Signal condition	79
<b>TV Guide</b>	
Operation	25
Timer recording	30
<b>TV System</b>	<b>83</b>
<b>U</b>	
<b>USB HDD</b>	
Cancellation of all USB HDD Registrations	81
Disconnection	71, 81
Format	81
Media information	6, 9
Registration	71, 81
<b>USB memories</b>	
Media information	6, 10
<b>V</b>	
<b>Video</b>	
AVCHD	36, 39
BD-Video	39
Copy	48
Delete	44
DIRECT NAVIGATOR	36
Playback	36, 39
Playlist created on other equipment	39
Protection	45
Recording	28
Xvid	39
3D	43
<b>VIERA Link</b>	<b>73, 84</b>
<b>W</b>	
<b>Wi-Fi Direct™</b>	<b>67</b>
<b>X</b>	
<b>Xvid</b>	<b>39</b>
<b>3D</b>	<b>43</b>

The recording and playback of content on this or any other device may require permission from the owner of the copyright or other such rights in that content. Panasonic has no authority to and does not grant you that permission and explicitly disclaims any right, ability or intention to obtain such permission on your behalf. It is your responsibility to ensure that your use of this or any other device complies with applicable copyright legislation in your country. Please refer to that legislation for more information on the relevant laws and regulations involved or contact the owner of the rights in the content you wish to record or playback.

**Disposal of Old Equipment and Batteries**

**Only for European Union and countries with recycling systems**



These symbols on the products, packaging, and/or accompanying documents mean that used electrical and electronic products and batteries must not be mixed with general household waste.

For proper treatment, recovery and recycling of old products and used batteries, please take them to applicable collection points in accordance with your national legislation.

By disposing of them correctly, you will help to save valuable resources and prevent any potential negative effects on human health and the environment.

For more information about collection and recycling, please contact your local municipality.

Penalties may be applicable for incorrect disposal of this waste, in accordance with national legislation.



**Note for the battery symbol (bottom symbol):**

This symbol might be used in combination with a chemical symbol. In this case it complies with the requirement set by the Directive for the chemical involved.

**Personal information handling**

To provide functions and services of this unit, a device ID, device password and usage history information are stored and managed securely in an appropriate security environment of Panasonic. Please note that usage history and other information may be collected for purposes such as improving products and services in such a way that individuals cannot be identified.

CE 1731 ⚠

### Declaration of Conformity (DoC)

Hereby, "Panasonic Corporation" declares that this product is in compliance with the essential requirements and other relevant provisions of Directive 1999/5/EC.

Customers can download a copy of the original DoC to our R&TTE products from our DoC server:

<http://www.doc.panasonic.de>

Contact to Authorised Representative:

Panasonic Marketing Europe GmbH,  
Panasonic Testing Centre, Winsbergring 15,  
22525 Hamburg, Germany

This product is intended to be used in the following countries.

Austria, Belgium, Bulgaria, Cyprus, Czech Republic, Denmark, Finland, France, Germany, Greece, Hungary, Ireland, Italy, Iceland, Liechtenstein, Luxembourg, Malta, Netherlands, Norway, Poland, Portugal, Romania, Slovakia, Slovenia, Spain, Sweden, United Kingdom, Switzerland

This product is intended for general consumer. (Category 3)

The WLAN feature of this product shall exclusively be used inside buildings.

This product on purpose to connect to access point of 2.4 GHz or 5 GHz WLAN.



(Back of product)

<b>DANGER</b>	VISIBLE AND INVISIBLE LASER RADIATION WHEN OPEN. AVOID DIRECT EXPOSURE TO BEAM.	FDA21 CFR/CLASS IIIb
<b>CAUTION</b>	CLASS 3B VISIBLE AND INVISIBLE LASER RADIATION WHEN OPEN. AVOID EXPOSURE TO THE BEAM.	IEC60825-1/CLASS 3B
<b>ATTENTION</b>	RAYONNEMENT LASER VISIBLE ET INVISIBLE, CLASSE 3B. EN CAS D'OUVERTURE, ÉVITER UNE EXPOSITION AU FAISCEAU.	
<b>FORSIGTIG</b>	SYNLIG OG USYNLIG LASERSTRÅLING KLASSE 3B. NÅR LÅGET ER ÅBENT, UNDGÅ AT BLIVE UDSAT FOR STRÅLEN.	
<b>VARO</b>	AVATTAESSA OLET ALTTIINA LUOKAN 3B NÄKYVÄÄ JA NÄKYMÄTÖNTÄ LASERSTRÄLYÄ. VÄRÖ ALTISTUMISTA SÄTEELLE.	
<b>WARNING</b>	KLASS 3B SYNLIG OCH OSYNLIG LASERSTRÅLNING NÄR DENNA DEL ÄR ÖPPNAD. UNDVIK EXPONERING FÖR STRÅLEN.	
<b>VORSICHT</b>	SICHTBARE UND UNSICHTBARE LASERSTRAHLUNG KLASSE 3B. WENN ABDECKUNG GEÖFFNET, NICHT DEM STRAHL AUSSETZEN.	
<b>注意</b>	打开时有可见及不可见激光辐射。避免光束照射。	
<b>注意</b>	ここを開くとクラス3Bの可視及び不可視レーザー放射が出る。ビームの目又は皮膚への照射は危険! 用たり続けたりしないこと。	VQLZQ40

(Inside of product)

## Sales and Support Information

### Customer Communications Centre

- For customers within the UK: 0844 844 3899
- For customers within Ireland: 01 289 8333
- Monday - Friday 9:00 am - 5:00 pm (Excluding public holidays).
- For further support on your product, please visit our website: [www.panasonic.co.uk](http://www.panasonic.co.uk)

### Direct Sales at Panasonic UK

- Order accessory and consumable items for your product with ease and confidence by phoning our Customer Communications Centre Monday - Friday 9:00 am - 5:00 pm (Excluding public holidays).
- Or go on line through our Internet Accessory ordering application at [www.pas-europe.com](http://www.pas-europe.com).
- Most major credit and debit cards accepted.
- All enquiries transactions and distribution facilities are provided directly by Panasonic UK.
- It couldn't be simpler!
- Also available through our Internet is direct shopping for a wide range of finished products. Take a browse on our website for further details.

To get the most up to date service from Freeview it is important for Freeview customers to retune from time to time.

### **How do I re-tune my Freeview Box?**

The below instructions are a quick reference. If you have any problems, check your instruction manual or ask a friend or family member to show you how. Alternatively, go to your local electrical retailer, contact your manufacturer or visit [freeview.co.uk/retune](http://freeview.co.uk/retune)

Re-tuning only takes a few minutes, just follow the steps below:

- 1 Press [FUNCTION MENU].
- 2 Select "Basic Settings" in "Setup", then press [OK].
- 3 Select "Auto Setup" in "Tuning", then press [OK].
- 4 Select "Yes", then press [OK].

Please note: most digital TV recorders will keep your original recording safer running a re-tune but you will need to reset any future recordings.

For detailed information on re-tuning your receiver please refer to page 79 of this instruction book

Manufactured by: Panasonic Corporation  
Kadoma, Osaka, Japan  
Importer for Europe: Panasonic Marketing Europe GmbH  
Panasonic Testing Centre  
Winsbergring 15, 22525 Hamburg, Germany



Panasonic Corporation  
Web Site: <http://panasonic.net>

En  
SQT0139  
F0414MDO

