

Panasonic®

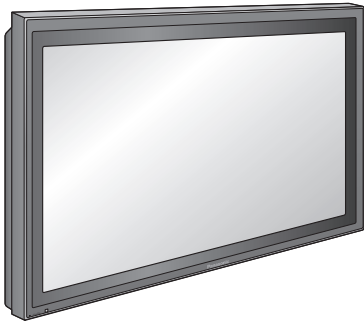

Operating Instructions Progressive Wide Plasma Display

Model No. **TH-42PS10BK**
TH-42PS10BS

High Definition Plasma Display

Model No. **TH-42PH10BK**
TH-42PH10BS
TH-50PH10BK
TH-50PH10BS
TH-58PH10BK



The illustration shown is an image.

Please read these instructions before operating your set
and retain them for future reference.

English



TQB0E0413-1

Dear Panasonic Customer

Welcome to the Panasonic family of customers. We hope that you will have many years of enjoyment from your new Plasma Display.

To obtain maximum benefit from your set, please read these Instructions before making any adjustments, and retain them for future reference.

Retain your purchase receipt also, and note down the model number and serial number of your set in the space provided on the rear cover of these instructions.

Visit our Panasonic Web Site <http://panasonic.net>

Table of Contents

Important Safety Notice	3	Reduces screen image retention.....	30
Safety Precautions	4	Side Panel Adjustment	31
Accessories	7	Reduces power consumption	32
Accessories Supply	7	Customizing the Input labels	32
Remote Control Batteries	7	Setup for MULTI DISPLAY	33
Connections	8	(For TH-42PS10BK/S)	
PC Input Terminals connection	9	How to Setup MULTI DISPLAY	33
SERIAL Terminals connection	10	How to set the display location number	
AV connection		for each Plasma Display	34
(for TH-42PH10BK/S, TH-50PH10BK/S, TH-58PH10BK) ..	11	(For TH-42PH10BK/S, TH-50PH10BK/S, TH-58PH10BK)	
Power On / Off	12	How to Setup MULTI DISPLAY	35
Initial selections	13	How to set the display location number	
Selecting the input signal	13	for each Plasma Display	35
Selecting the On-Screen Menu Language	13	F (Seam hides video) Setting	37
Basic Controls	14	ID Remote Control Function	37
On-Screen Menu Displays	16	Setup for Input Signals	38
ASPECT Controls	18	Component / RGB-in select.....	38
Adjusting Pos. / Size	19	3D Y/C Filter	38
MULTI PIP	20	Colour system / Panasonic Auto	39
Advanced PIP	21	Cinema reality / P-NR.....	39
Picture Adjustments	22	Sync	40
Advanced settings	23	H-Freq. (kHz) / V-Freq. (Hz)	40
Sound Adjustment	25	Options Adjustments	41
Mute	25	Weekly Command Timer	
Digital Zoom	26	(for TH-42PH10BK/S, TH-50PH10BK/S, TH-58PH10BK) ..	48
PRESENT TIME Setup / Set up TIMER	27	Shipping condition	50
PRESENT TIME Setup.....	27	Troubleshooting	51
Set up TIMER	28	VIDEO/PC input signals	52
Screensaver (For preventing image retention)....	29	Command list of Weekly Command Timer	53
Setup of Screensaver Time	30	Specifications	54

Trademark Credits

- VGA is a trademark of International Business Machines Corporation.
 - Macintosh is a registered trademark of Apple Computer, USA.
 - S-VGA is a registered trademark of the video Electronics Standard Association.
- Even if no special notation has been made of company or product trademarks, these trademarks have been fully respected.

Note:

Do not allow a still picture to be displayed for an extended period, as this can cause a permanent image retention to remain on the Plasma Display.

Examples of still pictures include logos, video games, computer images, teletext and images displayed in 4:3 mode.

Important Safety Notice

WARNING

- 1) To prevent damage which may result in fire or shock hazard, do not expose this appliance to dripping or splashing.
Do not place containers with water (flower vase, cups, cosmetics, etc.) above the set. (including on shelves above, etc.)
No naked flame sources, such as lighted candles, should be placed on / above the set.
- 2) To prevent electric shock, do not remove cover. No user serviceable parts inside. Refer servicing to qualified service personnel.
- 3) Do not remove the earthing pin on the power plug. This apparatus is equipped with a three pin earthing-type power plug. This plug will only fit an earthing-type power outlet. This is a safety feature. If you are unable to insert the plug into the outlet, contact an electrician.
Do not defeat the purpose of the earthing plug.
- 4) To prevent electric shock, ensure the earthing pin on the AC cord power plug is securely connected.

CAUTION

This appliance is intended for use in environments which are relatively free of electromagnetic fields. Using this appliance near sources of strong electromagnetic fields or where electrical noise may overlap with the input signals could cause the picture and sound to wobble or cause interference such as noise to appear. To avoid the possibility of harm to this appliance, keep it away from sources of strong electromagnetic fields.

IMPORTANT: THE MOULDED PLUG

FOR YOUR SAFETY, PLEASE READ THE FOLLOWING TEXT CAREFULLY.

This appliance is supplied with a moulded three pin mains plug for your safety and convenience. A 5 amp fuse is fitted in this plug. Shall the fuse need to be replaced, please ensure that the replacement fuse has a rating of 5 amps and that it is approved by ASTA or BSI to BS1362.

Check for the ASTA mark  or the BSI mark  on the body of the fuse.

If the plug contains a removable fuse cover, you must ensure that it is refitted when the fuse is replaced.

If you lose the fuse cover the plug must not be used until a replacement cover is obtained.

A replacement fuse cover can be purchased from your local Panasonic Dealer.

If the fitted moulded plug is unsuitable for the socket outlet in your home, then the fuse shall be removed and the plug cut off and disposed of safely. There is a danger of severe electrical shock if the cut off plug is inserted into any 13 amp socket.

If a new plug is to be fitted, please observe the wiring code as shown below.

If in any doubt, please consult a qualified electrician.

WARNING : — THIS APPARATUS MUST BE EARTHED.

IMPORTANT : —The wires in this mains lead are coloured in accordance with the following code: —

Green-and-Yellow : Earth

Blue: Neutral Brown: Live

As the colours of the wire in the mains lead of this appliance may not correspond with the coloured markings identifying the terminals in your plug, proceed as follows.

The wire which is coloured GREEN-AND-YELLOW must be connected to the terminal in the plug which is marked with the letter E or by the Earth symbol  or coloured GREEN or GREEN-AND-YELLOW.

The wire which is coloured BLUE must be connected to the terminal in the plug which is marked with the letter N or coloured BLACK.

The wire which is coloured BROWN must be connected to the terminal in the plug which is marked with the letter L or coloured RED.

How to replace the fuse. Open the fuse compartment with a screwdriver and replace the fuse.

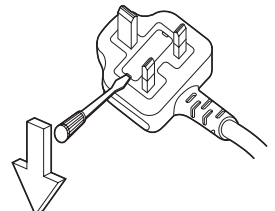

Safety Precautions

WARNING

■ Setup

This Plasma Display is for use only with the following optional accessories. Use with any other type of optional accessories may cause instability which could result in the possibility of injury.

(All of the following accessories are manufactured by Matsushita Electric Industrial Co., Ltd.)

- Speakers TY-SP42P8W-K (TH-42PS10BK, TH-42PH10BK),
TY-SP42P8W-S (TH-42PS10BS, TH-42PH10BS),
TY-SP50P8W-K (TH-50PH10BK),
TY-SP50P8W-S (TH-50PH10BS),
TY-SP58P10WK (TH-58PH10BK)
- Pedestal TY-ST07-K (TH-42PS10BK, TH-42PH10BK, TH-50PH10BK),
TY-ST07-S (TH-42PS10BS, TH-42PH10BS, TH-50PH10BS),
TY-ST08-K (TH-42PS10BK, TH-42PH10BK, TH-50PH10BK),
TY-ST08-S (TH-42PS10BS, TH-42PH10BS, TH-50PH10BS),
TY-ST58-K (TH-58PH10BK)
- Mobile stand TY-ST42PF3 (TH-42PS10BK/S, TH-42PH10BK/S, TH-50PH10BK/S),
TY-ST58PF10
- Wall-hanging bracket (vertical) TY-WK42PV7
- Wall-hanging bracket (angled) TY-WK42PR7
- Wall-hanging bracket (drawer type) TY-WK42DR1 (TH-42PS10BK/S, TH-42PH10BK/S, TH-50PH10BK/S)
- Ceiling-hanging bracket TY-CE42PS7 (TH-42PS10BK/S, TH-42PH10BK/S, TH-50PH10BK/S)
- BNC Component Video Terminal Board TY-42TM6A
- BNC Composite Video Terminal Board TY-42TM6B
- BNC Dual Video Terminal Board TY-FB9BD
- SCART Terminal Board TY-FB8SC
- RCA Component Video Terminal Board TY-42TM6Z
- RCA Composite Video Terminal Board TY-42TM6V
- RGB (Digital) Terminal Board TY-42TM6D
- RGB Active Through Terminal Board TY-42TM6G
- PC Input Terminal Board TY-42TM6P
- Composite / Component Video Terminal Board . TY-42TM6Y
- SDI Terminal Board TY-FB7SD
- HD-SDI Terminal Board TY-FB9HD
- HDMI Terminal Board TY-FB8HM
- Ir Through Terminal Board TY-FB9RT
- Wireless Presentation Board TY-FB10WPE (TH-42PH10BK/S, TH-50PH10BK/S, TH-58PH10BK)
- AV Terminal Box TY-TB10AV
- Touch Panel TY-TP42P8-S (TH-42PS10BK/S, TH-42PH10BK/S),
TY-TP50P8-S (TH-50PH10BK/S), TY-TP50P10S (TH-50PH10BK/S),
TY-TP42P10S (TH-42PS10BK/S, TH-42PH10BK/S),
TY-TP58P10S (TH-58PH10BK)
- Anti glare filter TY-AR50P9W (TH-50PH10BK/S),
TY-AR42P9W (TH-42PS10BK/S, TH-42PH10BK/S),
TY-AR58P10W (TH-58PH10BK)

Always be sure to ask a qualified technician to carry out set-up.

Small parts can present choking hazard if accidentally swallowed. Keep small parts away from young children. Discard unneeded small parts and other objects, including packaging materials and plastic bags/sheets to prevent them from being played with by young children, creating the potential risk of suffocation.

Do not place the Plasma Display on sloped or unstable surfaces.

- The Plasma Display may fall off or tip over.

Do not place any objects on top of the Plasma Display.

- If water is spilled onto the Plasma Display or foreign objects get inside it, a short-circuit may occur which could result in fire or electric shock. If any foreign objects get inside the Plasma Display, please consult your local Panasonic dealer.

Transport only in upright position!

- Transporting the unit with its display panel facing upright or downward may cause damage to the internal circuitry.

Ventilation should not be impeded by covering the ventilation openings with items such as newspapers, table cloths and curtains.

For sufficient ventilation;

If using the pedestal (optional accessory) for the Plasma Display, leave a space of at least 10 cm at the top, left and right, at least 6 cm at the bottom, and at least 7 cm at the rear. If using some other setting-up method, leave a space of at least 10 cm at the top, bottom, left and right, and at least 7 cm at the rear.

■ When using the Plasma Display

The Plasma Display is designed to operate on 220 - 240 V AC, 50/60 Hz.

Do not cover the ventilation holes.

- Doing so may cause the Plasma Display to overheat, which can cause fire or damage to the Plasma Display.

Do not stick any foreign objects into the Plasma Display.

- Do not insert any metal or flammable objects into the ventilations holes or drop them onto the Plasma Display, as doing so can cause fire or electric shock.

Do not remove the cover or modify it in any way.

- High voltages which can cause severe electric shocks are present inside the Plasma Display. For any inspection, adjustment and repair work, please contact your local Panasonic dealer.

Ensure that the mains plug is easily accessible.

An apparatus with CLASS I construction shall be connected to a mains socket outlet with a protective earthing connection.

Do not use any power supply cord other than that provided with this unit.

- Doing so may cause fire or electric shocks.

Securely insert the power supply plug as far as it will go.

- If the plug is not fully inserted, heat may be generated which could cause fire. If the plug is damaged or the wall socket is loose, they shall not be used.

Do not handle the power supply plug with wet hands.

- Doing so may cause electric shocks.

Do not do anything that may damage the power cable. When disconnecting the power cable, pull on the plug body, not the cable.

- Do not damage the cable, make any modifications to it, place heavy objects on top of it, heat it, place it near any hot objects, twist it, bend it excessively or pull it. To do so may cause fire and electric shock. If the power cable is damaged, have it repaired at your local Panasonic dealer.

If the Plasma Display is not going to be used for any prolonged length of time, unplug the power supply plug from the wall outlet.

■ If problems occur during use

If a problem occurs (such as no picture or no sound), or if smoke or an abnormal odour starts to come out from the Plasma Display, immediately unplug the power supply plug from the wall outlet.

- If you continue to use the Plasma Display in this condition, fire or electric shock could result. After checking that the smoke has stopped, contact your local Panasonic dealer so that the necessary repairs can be made. Repairing the Plasma Display yourself is extremely dangerous, and shall never be done.

If water or foreign objects get inside the Plasma Display, if the Plasma Display is dropped, or if the cabinet becomes damages, disconnect the power supply plug immediately.

- A short circuit may occur, which could cause fire. Contact your local Panasonic dealer for any repairs that need to be made.

Safety Precautions

CAUTION

■ When using the Plasma Display

Do not bring your hands, face or objects close to the ventilation holes of the Plasma Display.

- Heated air comes out from the ventilation holes at the top of Plasma Display will be hot. Do not bring your hands or face, or objects which cannot withstand heat, close to this port, otherwise burns or deformation could result.

Be sure to disconnect all cables before moving the Plasma Display.

- If the Plasma Display is moved while some of the cables are still connected, the cables may become damaged, and fire or electric shock could result.

Disconnect the power supply plug from the wall socket as a safety precaution before carrying out any cleaning.

- Electric shocks can result if this is not done.

Clean the power cable regularly to prevent it becoming dusty.

- If dust built up on the power cord plug, the resultant humidity can damage the insulation, which could result in fire. Pull the power cord plug out from the wall outlet and wipe the mains lead with a dry cloth.

This Plasma Display radiates infrared rays, therefore it may affect other infrared communication equipment. Install your infrared sensor in a place away from direct or reflected light from your Plasma Display.

Cleaning and maintenance

The front of the display panel has been specially treated. Wipe the panel surface gently using only a cleaning cloth or a soft, lint-free cloth.

- If the surface is particularly dirty, wipe with a soft, lint-free cloth which has been soaked in pure water or water in which neutral detergent has been diluted 100 times, and then wipe it evenly with a dry cloth of the same type until the surface is dry.
- Do not scratch or hit the surface of the panel with fingernails or other hard objects, otherwise the surface may become damaged. Furthermore, avoid contact with volatile substances such as insect sprays, solvents and thinner, otherwise the quality of the surface may be adversely affected.

If the cabinet becomes dirty, wipe it with a soft, dry cloth.

- If the cabinet is particularly dirty, soak the cloth in water to which a small amount of neutral detergent has been added and then wring the cloth dry. Use this cloth to wipe the cabinet, and then wipe it dry with a dry cloth.
- Do not allow any detergent to come into direct contact with the surface of the Plasma Display. If water droplets get inside the unit, operating problems may result.
- Avoid contact with volatile substances such as insect sprays, solvents and thinner, otherwise the quality of the cabinet surface may be adversely affected or the coating may peel off. Furthermore, do not leave it for long periods in contact with articles made from rubber or PVC.

Accessories

Accessories Supply

Check that you have the accessories and items shown



Operating Instruction book

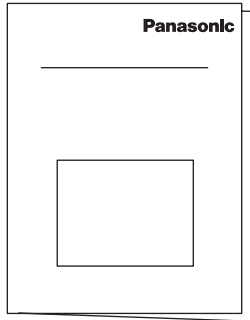

Remote Control Transmitter
EUR7636090R



Batteries for the Remote Control Transmitter
(2 × R6 (UM3) Size)

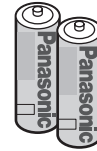

Power supply cord

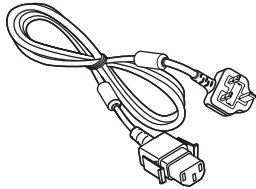

Fixing bands × 2

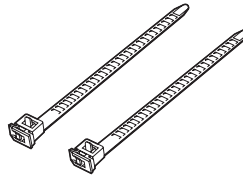

Remote Control Batteries

Requires two R6 batteries.

1. Pull and hold the hook, then open the battery cover.

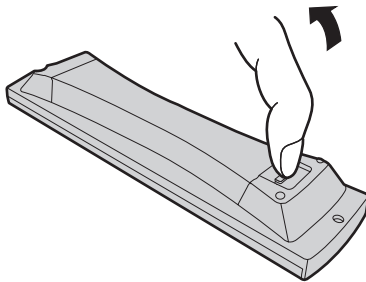

2. Insert batteries - note correct polarity (+ and -).

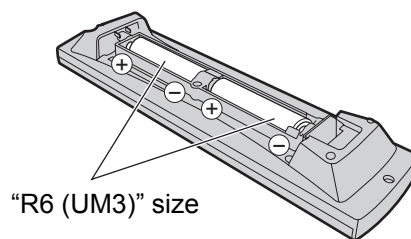

3. Replace the cover.

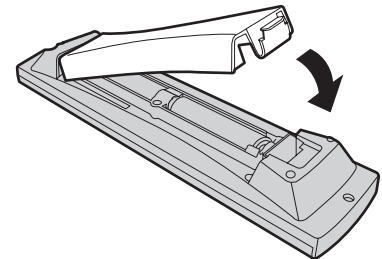

Helpful Hint:

For frequent remote control users, replace old batteries with Alkaline batteries for longer life.

⚠ Precaution on battery use

Incorrect installation can cause battery leakage and corrosion that will damage the remote control transmitter. Disposal of batteries should be in an environment-friendly manner.

Observe the following precaution:

1. Batteries shall always be replaced as a pair. Always use new batteries when replacing the old set.
2. Do not combine a used battery with a new one.
3. Do not mix battery types (example: "Zinc Carbon" with "Alkaline").
4. Do not attempt to charge, short-circuit, disassemble, heat or burn used batteries.
5. Battery replacement is necessary when remote control acts sporadically or stops operating the Plasma Display set.

Connections

When connecting the speakers, be sure to use only the optional accessory speakers. Refer to the speaker's Installation Manual for details on speaker installation. (Example: TH-42PH10BK)

Speakers (Optional accessories)

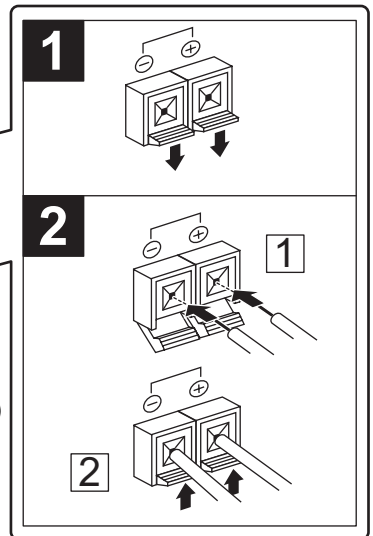
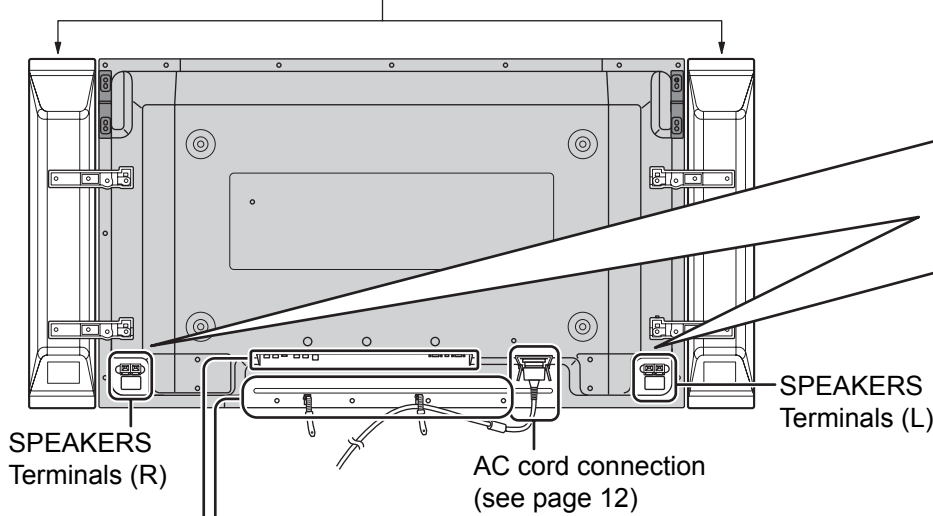

- AC cord fixing

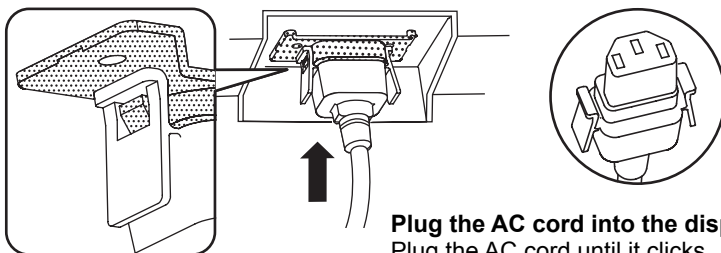

Note:
Make sure that the AC cord is locked on both the left and right sides.

Plug the AC cord into the display unit.
Plug the AC cord until it clicks.

Unplug the AC cord

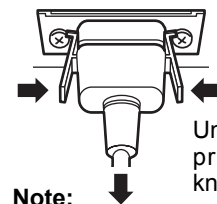

Unplug the AC cord pressing the two knobs.

Note:
When disconnecting the AC cord, be absolutely sure to disconnect the AC cord plug at the socket outlet first.

- Cable fixing bands

Secure any excess cables with bands as required.

Pass the attached cable fixing band through the clip as shown in the figure.

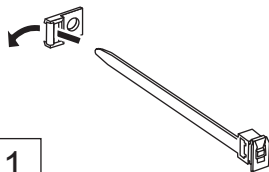

To secure cables connected to Terminals, wrap the cable fixing band around them then pass the pointed end through the locking block, as shown in the figure. **While ensuring there is sufficient slack in cables to minimize stress (especially in the power cord), firmly bind all cables with the supplied fixing band.**

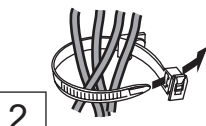

To tighten:

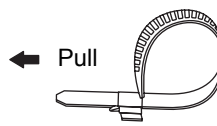

To loosen:

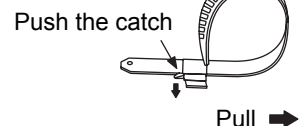

Dual Video Terminals (equivalent of BNC Dual Video Terminal Board (TY-FB9BD)) (see page 11)

Optional Terminal Board Insert Slot (covered)

From EXTERNAL monitor terminal on Computer (see page 9)

From SERIAL Terminal on Computer (see page 10)

Notes:

- On TH-42PH10BK/S, TH-50PH10BK/S and TH-58PH10BK, Terminal board is installed in SLOT 1 at factory shipment.
- On TH-42PS10BK/S, SLOT 1-3 are all empty at factory shipment.

PC Input Terminals connection

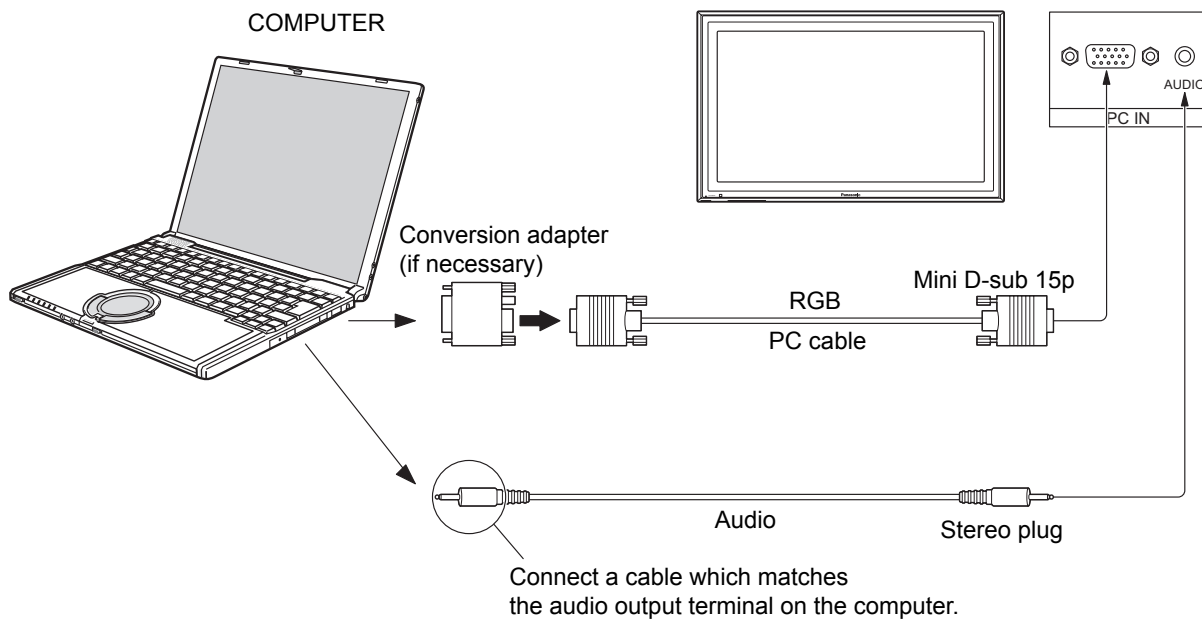

Notes:

- Due to space limitations, occasionally you may have trouble connecting Mini D-sub 15P cable with ferrite core to PC input Terminal.
- Computer signals which can be input are those with a horizontal scanning frequency of 15 to 110 kHz and vertical scanning frequency of 48 to 120 Hz. (However, the image will not be displayed properly if the signals exceed 1,200 lines.)
- The display resolution is a maximum of 640 × 480 dots (TH-42PS10BK/S), 768 × 768 dots (TH-42PH10BK/S), 1,024 × 768 dots (TH-50PH10BK/S, TH-58PH10BK) when the aspect mode is set to “4:3”, and 852 × 480 dots (TH-42PS10BK/S), 1,024 × 768 dots (TH-42PH10BK/S), 1,366 × 768 dots (TH-50PH10BK/S, TH-58PH10BK) when the aspect mode is set to “16:9”. If the display resolution exceeds these maximums, it may not be possible to show fine detail with sufficient clarity.
- The PC input terminals are DDC2B-compatible. If the computer being connected is not DDC2B-compatible, you will need to make setting changes to the computer at the time of connection.
- Some PC models cannot be connected to the set.
- There is no need to use an adapter for computers with DOS/V compatible Mini D-sub 15P terminal.
- The computer shown in the illustration is for example purposes only.
- Additional equipment and cables shown are not supplied with this set.
- Do not set the horizontal and vertical scanning frequencies for PC signals which are above or below the specified frequency range.
- Component Input is possible with the pin 1, 2, 3 of the Mini D-sub 15P Connector.
- Change the “Component/RGB-in select” setting in the “Setup” menu to “Component” (when Component connection) or “RGB” (when RGB signal connection). (see page 38)
- To use sync input VBS signals, use the connector which incorporates a 75-ohm termination resistance and which is available on the market, for the connection of the HD connector where the VBS signals are to be input.

Signal Names for Mini D-sub 15P Connector

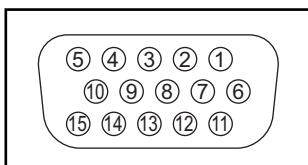

Pin Layout for PC Input Terminal

Pin No.	Signal Name	Pin No.	Signal Name	Pin No.	Signal Name
①	R (P _R /C _R)	⑥	GND (Ground)	⑪	NC (not connected)
②	G (Y)	⑦	GND (Ground)	⑫	SDA
③	B (P _B /C _B)	⑧	GND (Ground)	⑬	HD/SYNC
④	NC (not connected)	⑨	NC (not connected)	⑭	VD
⑤	GND (Ground)	⑩	GND (Ground)	⑮	SCL

SERIAL Terminals connection

The SERIAL terminal is used when the Plasma Display is controlled by a computer.

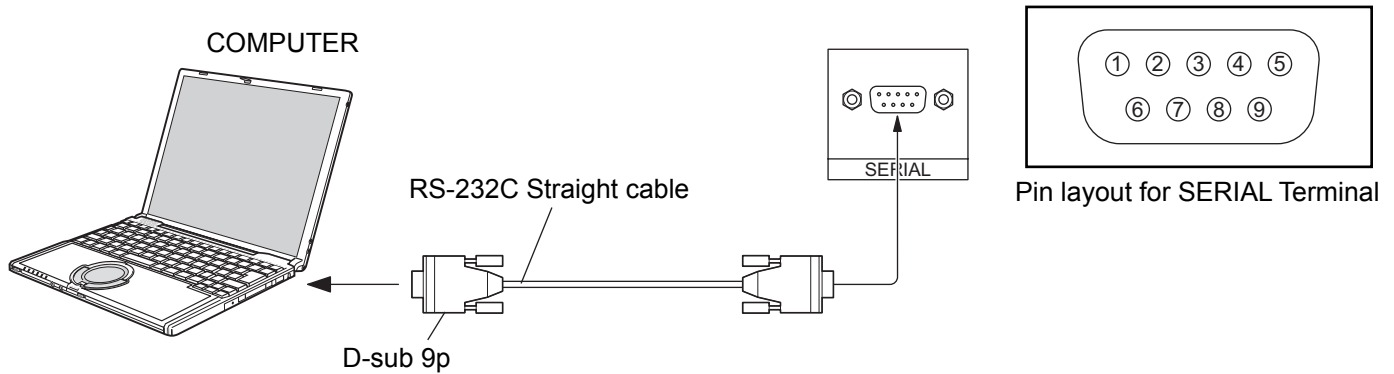

Notes:

- Use the RS-232C cable to connect the computer to the Plasma Display.
- The computer shown is for example purposes only.
- Additional equipment and cables shown are not supplied with this set.

The SERIAL terminal conforms to the RS-232C interface specification, so that the Plasma Display can be controlled by a computer which is connected to this terminal.

The computer will require software which allows the sending and receiving of control data which satisfies the conditions given below. Use a computer application such as programming language software. Refer to the documentation for the computer application for details.

Communication parameters

Signal level	RS-232C compliant
Synchronization method	Asynchronous
Baud rate	9600 bps
Parity	None
Character length	8 bits
Stop bit	1 bit
Flow control	-

RS-232C Conversion cable	
D-sub 9-pin female	Details
②	R X D
③	T X D
⑤	GND
④ • ⑥	Non use
⑦ ⑧	Shorted
① • ⑨	NC

Basic format for control data

The transmission of control data from the computer starts with a STX signal, followed by the command, the parameters, and lastly an ETX signal in that order. If there are no parameters, then the parameter signal does not need to be sent.

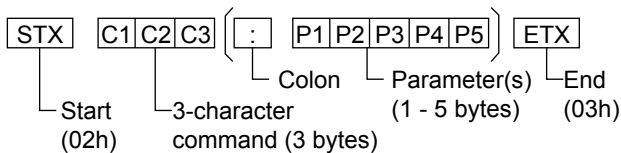

Notes:

- If multiple commands are transmitted, be sure to wait for the response for the first command to come from this unit before sending the next command.
- If an incorrect command is sent by mistake, this unit will send an "ER401" command back to the computer.
- SL1A, SL1B, SL2A and SL2B of Command IMS are available only when a dual input terminal board is attached.

Command

Command	Parameter	Control details
PON	None	Power ON
POF	None	Power OFF
AVL	**	Volume 00 - 63
AMT	0	Audio MUTE OFF
	1	Audio MUTE ON
IMS	None	Input select (toggle)
	SL1	Slot1 input
	SL2	Slot2 input
	SL3	Slot3 input
	PC1	PC input
	SL1A	Slot1 input (INPUT1A)
	SL1B	Slot1 input (INPUT1B)
	SL2A	Slot2 input (INPUT2A)
DAM	None	Screen mode select (toggle)
	NORM	NORMAL (4 : 3)
	ZOOM	ZOOM
	FULL	FULL
	JUST	JUST
	SELF	Panasonic AUTO

With the power off, this display responds to PON command only.

AV connection (for TH-42PH10BK/S, TH-50PH10BK/S, TH-58PH10BK)

This unit has a terminal board equivalent to BNC Dual Video Terminal Board (TY-FB9BD) as standard equipment.

Example of input signal source

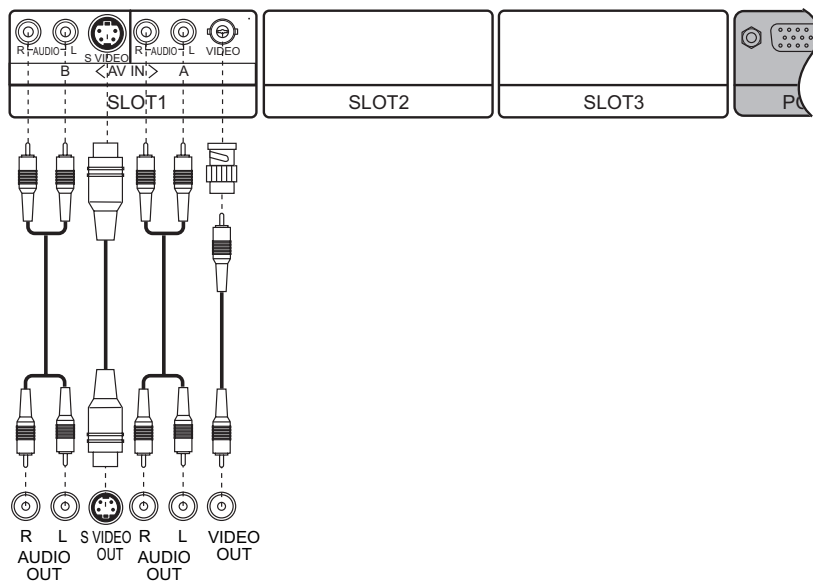
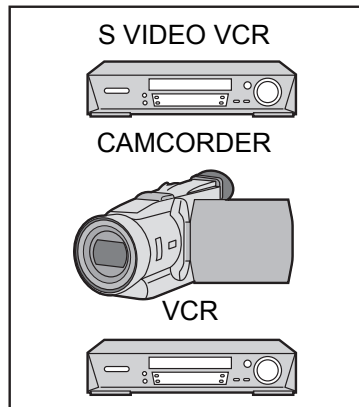

Note:

Additional equipment, cables and adapter plugs shown are not supplied with this set.

Power On / Off

Connecting the AC cord plug to the Plasma Display.

Fix the AC cord plug securely to the Plasma Display with the clamber. (see page 8)

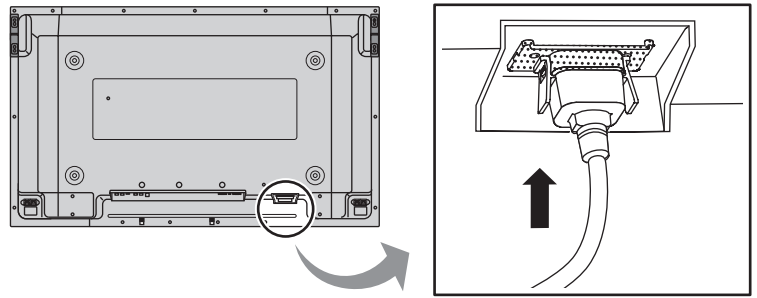

Connecting the plug to the Wall Outlet

Notes:

- Main plug types vary between countries. The power plug shown at right may, therefore, not be the type fitted to your set.
- When disconnecting the AC cord, be absolutely sure to disconnect the AC cord plug at the socket outlet first.

Press the Power switch on the Plasma Display to turn the set on: Power-On.

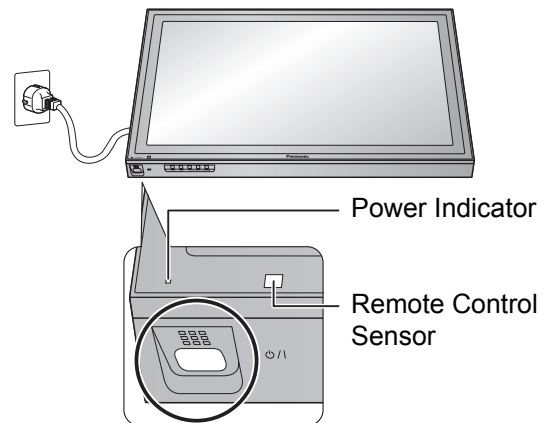

Power Indicator: Green

Example: The screen below is displayed for a while after the Plasma Display is turned on (setting condition is an example).

When the Power is turned on for the first time, the Language selection screen is displayed.

From the second time on, language selection can be done from the setup menu. (see page 13)

Select the desired language using the ▲ or ▼ button and press the ACTION (■) button.

Note:

Set with the remote control. Buttons on the main unit are unavailable for this setting.



From the second time on, the below screen is displayed for a while (setting condition is an example).

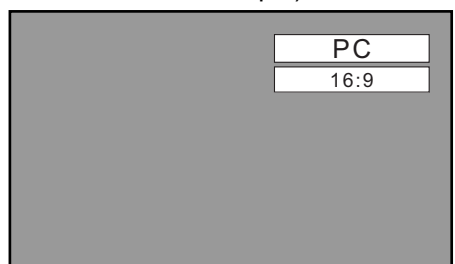

Press the OFF button on the remote control to turn the Plasma Display off.

Power Indicator: Red (standby)



Press the ON button on the remote control to turn the Plasma Display on.

Power Indicator: Green

Turn the power to the Plasma Display off by pressing the ⏻/⏺ switch on the unit, when the Plasma Display is on or in standby mode.

Note:

During operation of the power management function, the power indicator turns orange in the power off state.

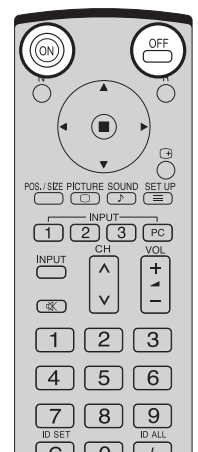

Initial selections

Selecting the input signal

Select the input signals to be connected by installing the optional Terminal Boards.



Press to select the input signal to be played back from the equipment which has been connected to the Plasma Display.

Input signals will change as follow:

- TH-42PS10BK/S

→ INPUT1 → INPUT2 → INPUT3 → PC

- TH-42PH10BK/S, TH-50PH10BK/S, TH-58PH10BK

→ INPUT1A → INPUT1B → INPUT2 → INPUT3 → PC

SLOT1 is for dual input so that you can select INPUT1A or INPUT1B for INPUT1.

INPUT1A : VIDEO signal terminal in SLOT1

INPUT1B : S-VIDEO signal terminal in SLOT1

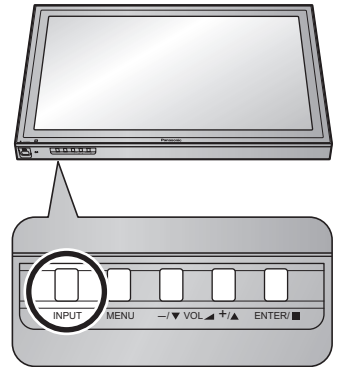
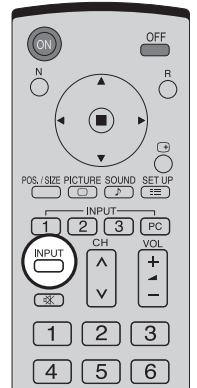

Notes:

- Selecting is also possible by pressing the INPUT button on the unit.
- Input terminal will not be selected if the terminal board is not installed into the SLOT.
- Select to match the signals from the source connected to the component/RGB input terminals. (see page 38)
- In 2 screen display, the same input mode cannot be selected for the main picture and sub picture.

Selecting the On-Screen Menu Language



Press to display the Setup menu.

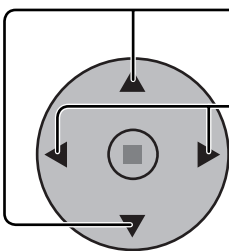

Press to select the OSD Language.

Press to select your preferred language.

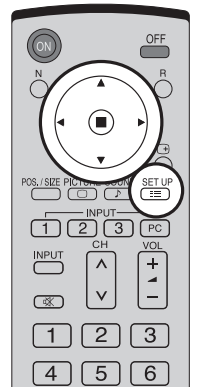

■ Selectable languages

- English(UK)
- Deutsch
- Français
- Italiano
- Español
- ENGLISH(US)
- 中文.....(Chinese)
- 日本語.....(Japanese)

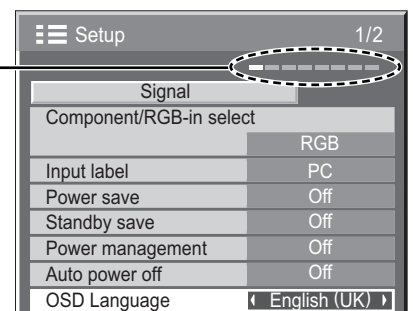

Basic Controls

Remote control sensor

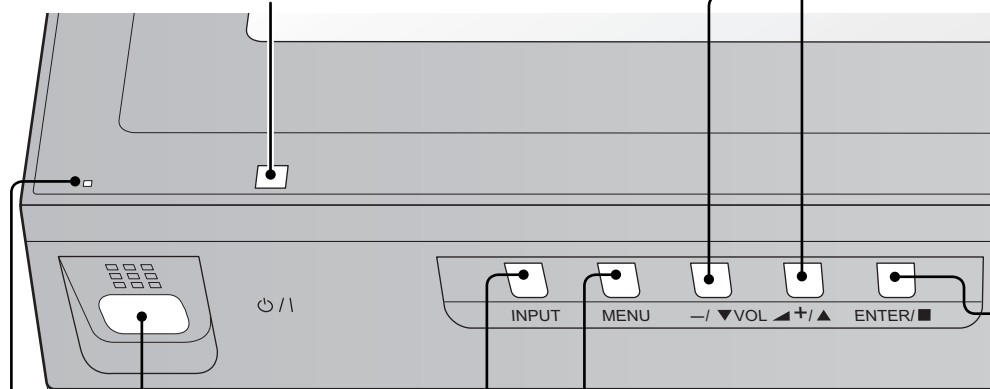

Volume Adjustment

Volume Up “+” Down “-”
When the menu screen is displayed:
“+”: press to move the cursor up
“-”: press to move the cursor down
(see page 16)

Enter / Aspect button
(see page 16, 18)

Main Power On / Off Switch

Power Indicator

- The Power Indicator will light.
- Power-OFF Indicator not illuminated (The unit will still consume some power as long as the power cord is still inserted into the wall outlet.)
 - Standby..... Red
 - Power-ON Green
 - DPMS..... Orange (With PC input signal and during operation of PC's screensaver.)

MENU Screen ON / OFF

Each time the MENU button is pressed, the menu screen will switch. (see page 16)

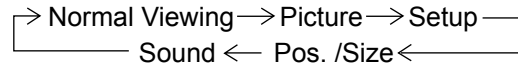

INPUT button

(INPUT1, INPUT2, INPUT3 and PC selection)
(see page 13)

N button (see page 19, 22, 23, 24, 25)

POS. / SIZE button (see page 19)

PICTURE button (see page 22)

INPUT button

(INPUT1, INPUT2, INPUT3 and PC selection)

Press to select INPUT1, INPUT2, INPUT3 and PC input SLOTS sequentially. (see page 13)

Sound mute On / Off (see page 25)

Numeric buttons (see page 37)

ASPECT button

Press to adjust the aspect. (see page 18)

SURROUND button

The surround setting switches on and off each time the SURROUND button is pressed.

The benefits of surround sound are enormous. You can be completely enveloped in sound; just as if you were at a concert hall or cinema.

Note:

The surround settings are memorized separately for each Sound Mode (Normal, Dynamic, Clear).

On ← → Off

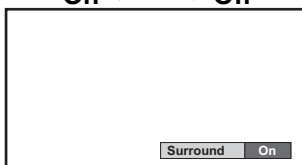

MULTI Window buttons (see page 20)

Standby (ON / OFF) button

The Plasma Display must first be plugged into the wall outlet and turned on at the power switch (see page 12). Press ON to turn the Plasma Display On, from Standby mode. Press OFF to turn the Plasma Display Off to Standby mode.

POSITION buttons

ACTION button

Press to make selections.

SOUND button

(see page 25)

R button (see page 17)

Press the R button to return to previous menu screen.

Status button

Press the "Status" button to display the current system status.

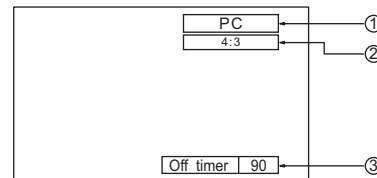

- ① Input label
- ② Aspect mode (see page 18)
- ③ Off timer

The off timer indicator is displayed only when the off timer has been set.

SET UP button (see page 16, 17)

DIRECT INPUT buttons

Press the INPUT "1", "2", "3" or "PC" input mode selection button to select the input mode.

This button is used to switch directly to INPUT mode.

These buttons can only display the slot which is installed. If you press the button whose slot is not installed, it automatically displays the current input signal.

When a dual input terminal board is attached, A or B is displayed depending on the selected input signal. (Ex. INPUT1A, INPUT1B)

Notes:

- For TH-42PH10BK/S, TH-50PH10BK/S and TH-58PH10BK, press to switch the input mode between INPUT1A and INPUT1B.
- Image retention (image lag) may occur on the plasma display panel when a still picture is kept on the panel for an extended period. The function that darkens the screen slightly is activated to prevent image retention (see page 51), this function is not the perfect solution to image retention.

Channel Adjustment

This button cannot be used for this model.

Volume Adjustment

Press the Volume Up "+" or Down "-" button to increase or decrease the sound volume level.

OFF TIMER button

The Plasma Display can be preset to switch to stand-by after a fixed period. The setting changes to 30 minutes, 60 minutes, 90 minutes and 0 minutes (off timer cancelled) each time the button is pressed.

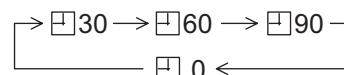

When three minutes remain, "OFF TIMER 3" will flash. The off timer is cancelled if a power interruption occurs.

Remote ID lock (see page 37)

Digital Zoom (see page 26)

Press to access Digital Zoom.



This displays an enlargement of the designated part of the displayed image.

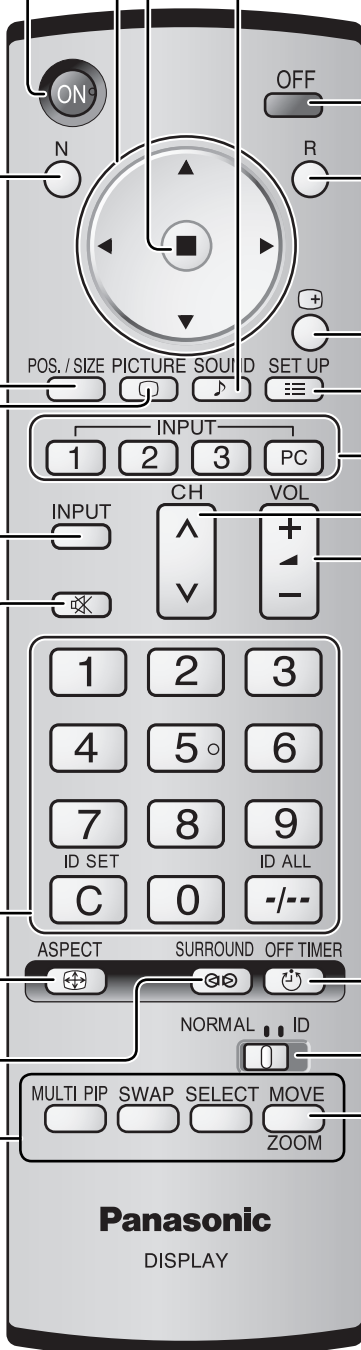

Panasonic
DISPLAY

On-Screen Menu Displays

To Picture adjust menu
(see page 22)

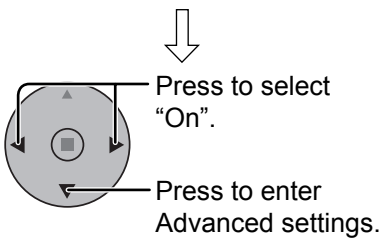
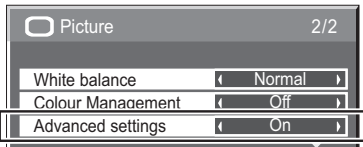
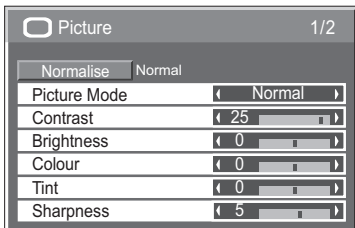

To Advanced settings
(see page 22, 23)

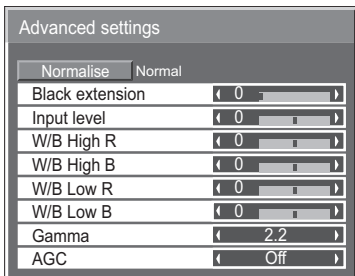

To Pos./Size adjust menu
(see page 19)

During "AV(S Video)",
"Component" and "Digital" input
signal.

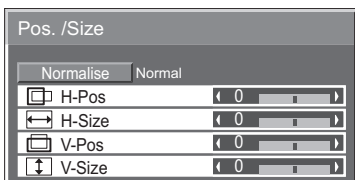

During "RGB / PC" input signal.

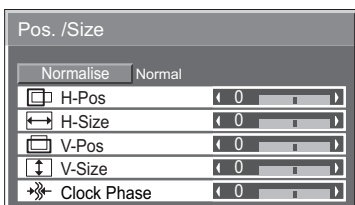

The MENU button on the unit can also
be pressed.

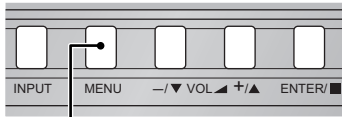

Each time the MENU button is pressed,
the menu screen will switch.

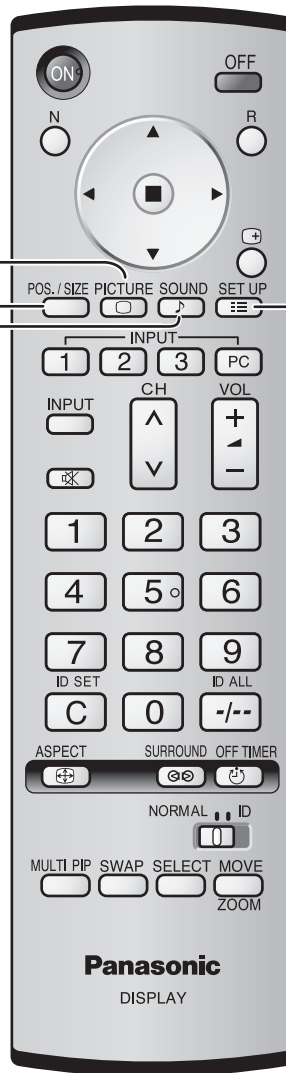
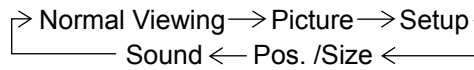

To Sound adjust menu
(see page 25)

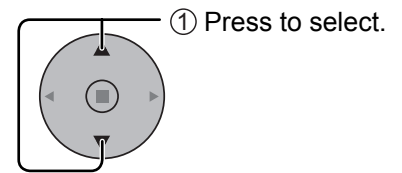
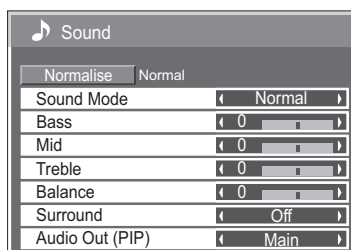

[from the unit]

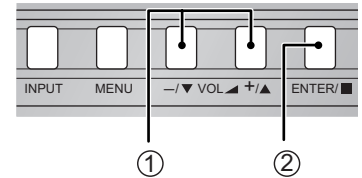

① Press to select.
② Press to access each adjust
screen.

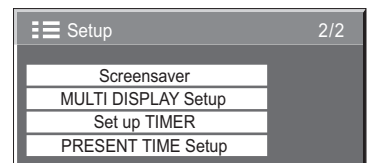
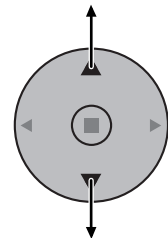
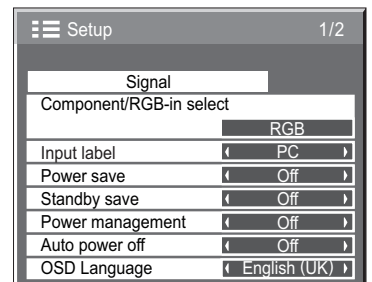

On-Screen Menu Displays

Note:

Menu that cannot be adjusted is grayout. Adjustable menu changes depending on signal, input and menu setting.

② Press to access each adjust screen.

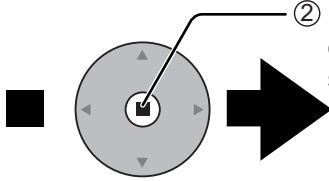

[from the unit]

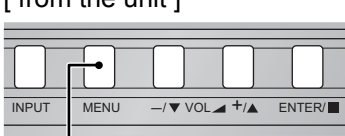

Press to return to next menu screen.

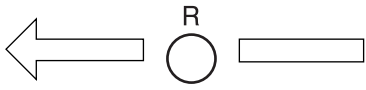

Press the R button to return to previous menu screen.

To Signal screen for AV
(S Video) (see page 38, 39)

Signal [AV]	
3D Y/C Filter (NTSC)	On
Colour system	Auto
Cinema reality	Off
Panasonic Auto (4 : 3)	4 : 3
P-NR	Off

To Signal screen for Component
(see page 39)

Signal [Component]	
Cinema reality	Off
P-NR	Off

To Signal screen for RGB
(see page 39, 40)

Signal [RGB]	
Sync	Auto
Cinema reality	Off
P-NR	Off
H-Freq.	33.8 kHz
V-Freq.	60.0 Hz

To Signal screen for Digital
(see page 39, 40)

Signal [Digital]	
Cinema reality	Off
P-NR	Off
H-Freq.	33.8 kHz
V-Freq.	60.0 Hz

Note: "Signal" setup menu displays different setting condition for each input signals. (see page 13)

To setup Screensaver
(see page 29-31)

Screensaver	
PRESENT TIME	15:00
Start	
Function	White bar scroll
Mode	Time Designation
Start Time	6:15
Finish Time	12:30
Side panel	High
Wobbling	Off
Peak limit	Off

Press to select Start Time / Finish Time
(When Time Designation is selected).
Press to select Periodic Time / Operating Time
(When Interval is selected).

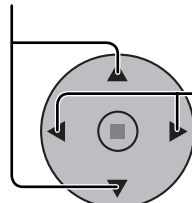

Press to Setup.



Press the R button to return to "Setup" menu.

Screensaver	
PRESENT TIME	15:00
Start	
Function	White bar scroll
Mode	Time Designation
Start Time	6:15
Finish Time	12:30
Side panel	High
Wobbling	Off
Peak limit	Off

Screensaver	
PRESENT TIME	15:00
Start	
Function	White bar scroll
Mode	Interval
Periodic Time	12:00
Operating Time	3:00
Side panel	High
Wobbling	Off
Peak limit	Off

To setup Multidisplay screen
(see page 33)

MULTI DISPLAY Setup	
MULTI DISPLAY Setup	Off
Ratio	2 x 2
Location	A1

To Set up Timer selection
screen (see page 27, 28)

Set up TIMER	
PRESENT TIME	10:00
POWER ON Function	Off
POWER ON Time	0:00
POWER OFF Function	Off
POWER OFF Time	0:00

Press to select POWER ON
Time / POWER OFF Time.

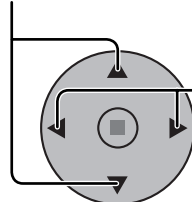

Press to Set up
POWER ON Time /
POWER OFF Time.

Set up TIMER	
PRESENT TIME	10:00
POWER ON Function	Off
POWER ON Time	12:00
POWER OFF Function	Off
POWER OFF Time	18:00

To PRESENT TIME Setup
(see page 27)

PRESENT TIME Setup	
PRESENT TIME	MON 99:99
Set	
DAY	MON
PRESENT TIME	99:99

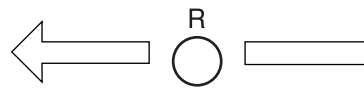

Press the R button to return
to "Setup" menu.

Set up TIMER	
PRESENT TIME	10:00
POWER ON Function	On
POWER ON Time	12:00
POWER OFF Function	On
POWER OFF Time	18:00

ASPECT Controls

The Plasma Display will allow you to enjoy viewing the picture at its maximum size, including wide screen cinema format picture.

ASPECT



Press repeatedly to move through the aspect options:

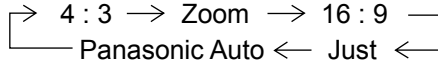

Note:

When selecting an input slot that attaches BNC Dual Video Terminal Board (TY-FB9BD), Panasonic Auto cannot be selected.

[from the unit]



The aspect mode changes each time the ENTER button is pressed.

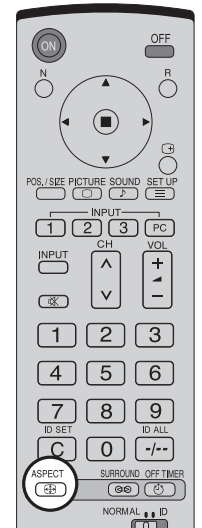

[During MULTI PIP Operations]

- Picture and Picture, Picture in Picture : Aspect switching is not possible.
- Others : Aspect switching is not possible.

Notes:



- For PC signal input, the mode switches between "4:3", "Zoom" and "16:9" only.
- For a 1125 (1080) / 60i · 50i · 24p · 25p · 30p · 24sF, 1250 (1080) / 50i, 750 (720) / 60p · 50p signal input, the mode is set to "16:9" mode, and switching is not possible.
- Panasonic Auto can be selected only during Video signal input.
- The aspect mode is memorized separately for each input terminal.

Mode	Picture	Explanation
4 : 3		4:3 will display a 4:3 picture at its standard 4:3 size.
Zoom		Zoom mode magnifies the central section of the picture.
16 : 9		16:9 will display the picture at its maximum size but with slight elongation.
Just		Just mode will display a 4:3 picture at its maximum size but with aspect correction applied to the center of the screen so that elongation is only apparent at the left and right edges of the screen. The size of the picture will depend on the original signal.
Panasonic Auto	<p>For an elongated image Image is expanded</p> <p>Changes in accordance with the Panasonic Auto mode setting (see page 39).</p> <p>For a 4:3 image</p>	<p>The display will automatically become enlarged (depending on the picture source), allowing you to view the picture at its maximum size.</p> <p>Notes:</p> <ul style="list-style-type: none"> • Panasonic Auto mode is designed to automatically adjust the aspect ratio to handle a mix of 16:9 and 4:3 program material. Certain 4:3 program material, such as stock market data screens, may occasionally cause the image size to change unexpectedly. When viewing such programs, it is recommended that the ASPECT be set to 4:3. • If adjusting the Picture V-Pos/V-Size in Panasonic Auto with 16:9 mode, the adjustment is not memorized. When exiting the mode, the screen will return to a former adjustment. • Panasonic Auto can not be selected while BNC Dual Video Terminal Board (TY-FB9BD) is installed.

Note:

Do not allow the picture to be displayed in 4:3 mode for an extended period, as this can cause a permanent image retention to remain on the Plasma Display Panel.

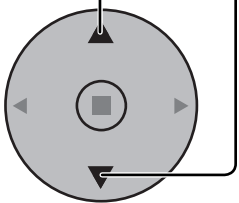
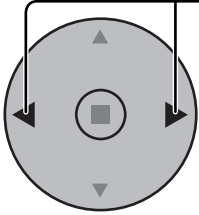
Adjusting Pos. / Size

- 1  Press to display the Pos. /Size menu.
- 2  Press to select H-Pos / H-Size / V-Pos / V-Size / Clock Phase.
- 3  Press to adjust Pos. / Size.
- 4  Press to exit from adjust mode.

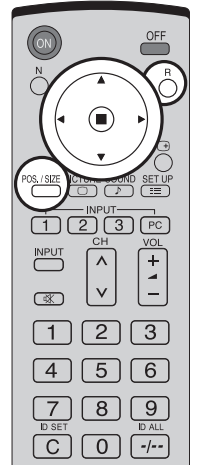

During "AV(S Video)", "Component" and "Digital" input signal.

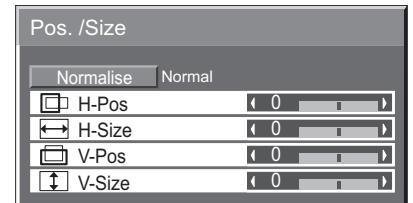

During "RGB / PC" input signal.

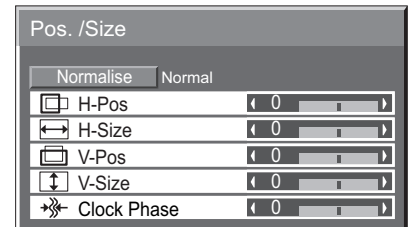

Notes:

- Adjustment details are memorized separately for different input signal formats (Adjustments for component signals are memorized for 525 (480) / 60i · 60p, 625 (575) / 50i · 50p, 1125 (1080) / 60i · 50i · 24p · 25p · 30p · 24sF, 1250 (1080) / 50i, 750 (720) / 60p · 50p each, and RGB/PC/Digital signals are memorized for each frequency.)
- If a "Cue" or "Rew" signal from a VCR or DVD player is received, the picture position will shift up or down. This picture position movement cannot be controlled by the Picture Pos./Size function.
- If adjusting the Picture V-Pos/V-Size in Panasonic Auto with 16:9 mode, the adjustment is not memorized. When exiting the mode, the screen will return to a former adjustment.

H-Pos Adjust the horizontal position.

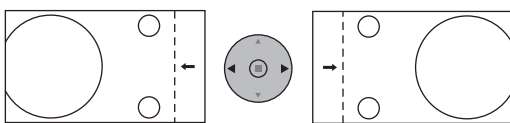

H-Size Adjust the horizontal size.

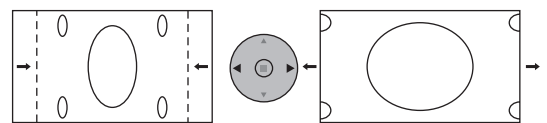

V-Pos Adjust the vertical position.

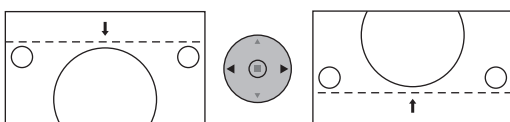

V-Size Adjust the vertical size.

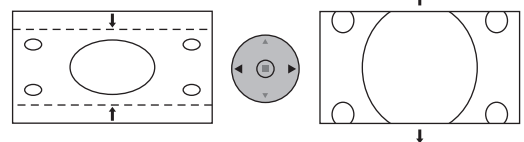

Clock Phase
(RGB/PC in mode)

Eliminate the flickering and distortion.

Helpful Hint (/ Normalisation)

While the Pos. / Size display is active, if either the N button on the remote control is pressed at any time or the ACTION (■) button is pressed during "Normalise", then all adjustment values are returned to the factory settings.

MULTI PIP

MULTI PIP



Press repeatedly.
Each time pressing this button main picture and sub picture will be displayed as follows below.

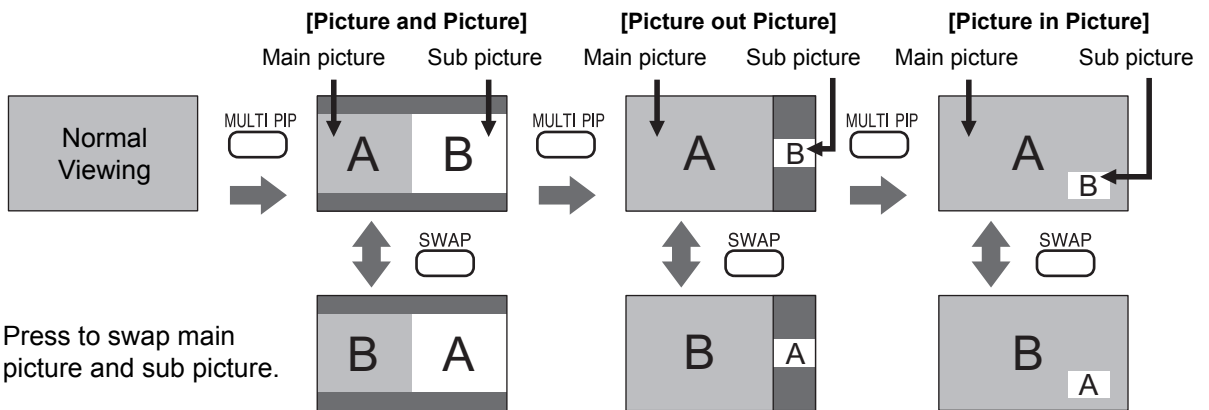
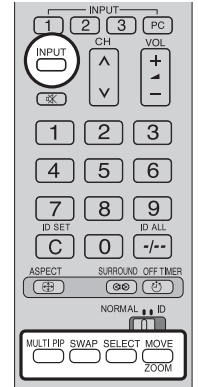

Press to swap main picture and sub picture.



Press to select the input mode.
Under main Picture and sub picture display, select the picture which you would like to change input modes.

Notes:

- The sub picture sound is heard while a sub picture operation is underway.
- The sub picture operation automatically returns to the main picture operation if a sub picture operation has not been performed for about 5 seconds or if any of the remote control buttons is pressed (except **INPUT** button).



Press to change input signal.

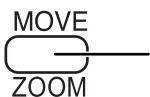

Press to move the sub picture.
Each time the location of the sub picture will be moved.

Notes:

- This button is effective only in the picture in picture.
- The sub picture may be hidden by the on screen display, depending on its position.

[Example]

Main picture label is bright Sub picture label is bright

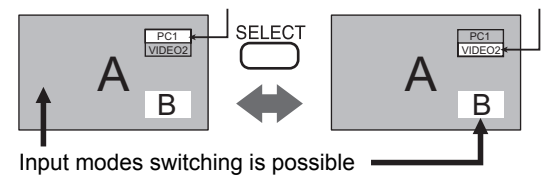

Main picture label is changed Sub picture label is changed

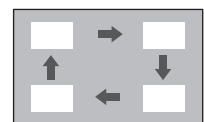
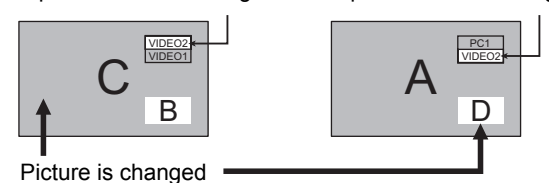



Notes:

- If "Input lock" in Options menu is set to other than "Off", MULTI PIP function isn't available.
- Sound output is from the picture which is selected in Audio Out (PIP) (See page 25).
- In 2 screen display, the same input mode cannot be selected for the main picture and sub picture.
- The main picture and sub picture are processed by different circuits, resulting in a slight difference in the clarity of the pictures. There may also be a difference in the picture quality of the sub picture depending on the type of signals displayed on the main picture and depending on the 2-picture display mode.
- Due to the small dimensions of the sub pictures, these sub pictures cannot be shown in detail.
- Computer screen picture is displayed in a simplified format, and it may not be possible to discern details on them satisfactorily.
- Following combinations of two analog signals cannot be displayed simultaneously;
Component - Component, Component - PC (RGB), PC (RGB) - Component, PC (RGB) - PC (RGB)

Advanced PIP

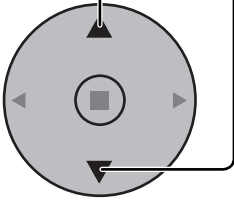
1  Press to display the Setup menu.

2  Press to select "OSD Language".

3  Press and hold until the Options menu is displayed.

4  Press to select Advanced PIP.

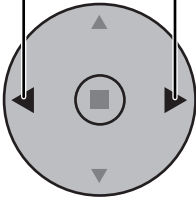
5  Press to adjust the menu.
 Off : Sets normal two screen display mode (see page 20).
 On : Sets Advanced PIP mode.

6  Press to exit from Options menu.

(When Advanced PIP is On)

7  Press repeatedly.
 Each time pressing this button main picture and sub picture will be displayed as above.

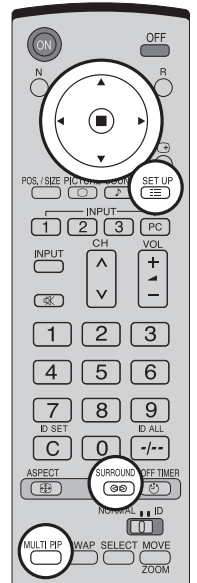





TH-42PS10BK/S

Options 1/3	
Off-timer function	Enable
Onscreen display	On
Initial INPUT	Off
Initial VOL level	Off 0
Maximum VOL level	Off 0
INPUT lock	Off
Studio W/B	Off
Advanced PIP	Off
Display size	Off

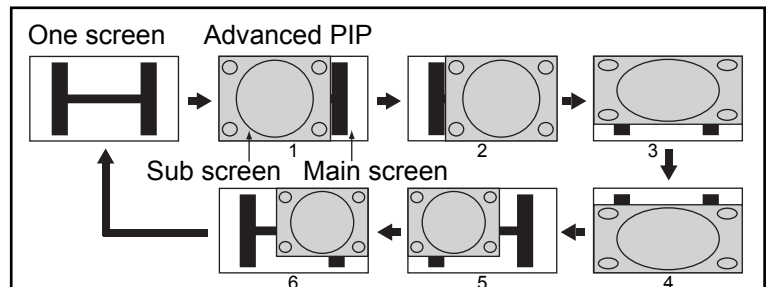
TH-42PH10BK/S, TH-50PH10BK/S, TH-58PH10BK

Options 1/3	
Weekly Command Timer	
Onscreen display	On
Initial INPUT	Off
Initial VOL level	Off 0
Maximum VOL level	Off 0
INPUT lock	Off
Button lock	Off
Remocon User level	Off
Advanced PIP	Off



Note: To use , , ,  buttons for the screen operations, follow the procedures in the previous page.

Notes:

- Advanced PIP corresponding signal

Sub screen	Main screen
NTSC, PAL, SECAM (tuner, video) 525i, 525p, 625i, 625p, 750/60p, 750/50p, 1125/60i, 1125/50i, 1250/50i (Component Video, RGB, DVI, SDI, HDMI)	640x480@60Hz, 852x480@60Hz, 1024x768@60Hz, 1366x768@60Hz (RGB, DVI, HDMI) 1280x768@60Hz (DVI)

- If "Input lock" in Options menu is set to other than "Off", MULTI PIP function isn't available.
- Sound output is from the picture which is selected in Audio Out (PIP) (See page 25).
- In 2 screen display, the same input mode cannot be selected for the main picture and sub picture.
- The main picture and sub picture are processed by different circuits, resulting in a slight difference in the clarity of the pictures. There may also be a difference in the picture quality of the sub picture depending on the type of signals displayed on the main picture and depending on the 2-picture display mode.
- Due to the small dimensions of the sub pictures, these sub pictures cannot be shown in detail.
- Computer screen picture is displayed in a simplified format, and it may not be possible to discern details on them satisfactorily.
- Following combinations of two analog signals cannot be displayed simultaneously;
Component - Component, Component - PC (RGB), PC (RGB) - Component, PC (RGB) - PC (RGB)
- Refer to each board's operating instruction for DVI, SDI, HDMI's corresponding signals.

Picture Adjustments

1  Press to display the Picture menu.

2 Select to adjust each item.

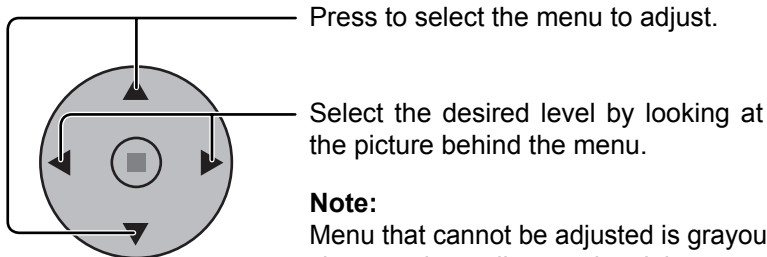

Note:
Menu that cannot be adjusted is grayout. Adjustable menu changes depending on signal, input and menu setting.

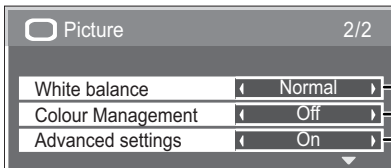
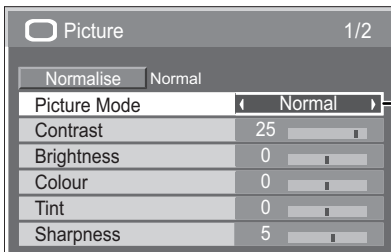
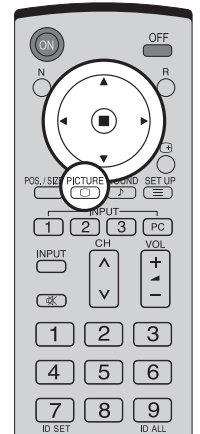

Advanced settings On
Enables fine picture adjustment at a professional level.

For TH-42PS10BK/S : see page 23
For TH-42PH10BK/S,
TH-50PH10BK/S,
TH-58PH10BK : see page 24

Advanced settings Off
Displays images with settings of the Picture menu.

Press “◀” or “▶” button to switch between modes.

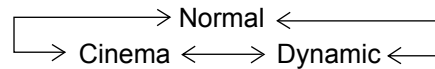

Normal

For viewing in standard (evening lighting) environments. This menu selects the normal levels of Brightness and Contrast.

Dynamic

For viewing in brighter environments. This menu selects higher than normal levels of Brightness and Contrast.

Cinema

Ideal for movies.

Note:

If you would like to change the picture and colour of the selected Picture menu to something else, adjust using the items in the Picture menu. (see next page)

Press “◀” or “▶” button to switch between modes.

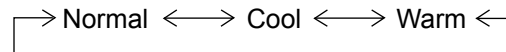

Colour Management On

Enables vivid colour adjustment automatically.

Helpful Hint ( / Normalise Normalisation)

While the “Picture” menu is displayed, if either the N button on the remote control is pressed at any time or the ACTION () button is pressed during “Normalise”, then all adjustment values are returned to the factory settings.

Item	Effect	Adjustments
Contrast	◀ Less ▶ More	Selects the proper brightness and density for the room.
Brightness	◀ Darker ▶ Brighter	Adjusts for easier viewing of dark pictures such as night scenes and black hair.
Colour	◀ Less ▶ More	Adjusts colour saturation.
Tint	◀ Reddish ▶ Greenish	Adjusts for nice skin colour.
Sharpness	◀ Less ▶ More	Adjusts picture sharpness.

Notes:

- “Colour” and “Tint” settings cannot be adjusted for “RGB/PC” and “Digital” input signal.
- You can change the level of each function (Contrast, Brightness, Colour, Tint, Sharpness) for each Picture Mode.
- The setting details for normal, dynamic and cinema respectively are memorized separately for each input terminal.
- The “Tint” setting can be adjusted for NTSC signal only during “AV (S Video)” input signal.
- In Contrast, there is not a noticeable change even when contrast is increased with a bright picture or reduced with a dark picture.

Advanced settings

(For TH-42PS10BK/S)

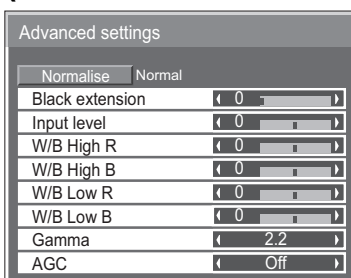

Item	Effect	Details
Black extension	◀ Less ▶ More	Adjusts the dark shades of the image in gradation.
Input level	◀ Less ▶ More	Adjustment of parts which are extremely bright and hard to see. (This cannot be adjusted when the input signal is Digital.)
W/B High R	◀ Less ▶ More	Adjusts the white balance for light red areas.
W/B High B	◀ Less ▶ More	Adjusts the white balance for light blue areas.
W/B Low R	◀ Less ▶ More	Adjusts the white balance for dark red areas.
W/B Low B	◀ Less ▶ More	Adjusts the white balance for dark blue areas.
Gamma	◀ Down ▶ Up	S Curve ← 2.0 ← 2.2 ← 2.5
AGC	◀ Off ▶ On	Increases the brightness of dark signal automatically.

Notes:

- Carry out “W/B” adjustment as follows.
 1. Adjust the white balance of the bright sections using the “W/B High R” and “W/B High B” settings.
 2. Adjust the white balance of the dark sections using the “W/B Low R” and “W/B Low B” settings.
 3. Repeat steps 1 and 2 to adjust.
 Steps 1 and 2 affect each other’s settings, so repeat each step in turn to make the adjustment.
- The adjustment values are memorized separately for each input terminal.
- The adjustment range values should be used as an adjustment reference.

Helpful Hint ( / **Normalise Normalisation)**

On the remote control unit, while the “Advanced settings” menu is displayed, if either the N button is pressed at any time or the ACTION () button is pressed during “Normalise”, then all adjustment values are returned to the factory settings.

Picture Adjustments

(For TH-42PH10BK/S, TH-50PH10BK/S, TH-58PH10BK)

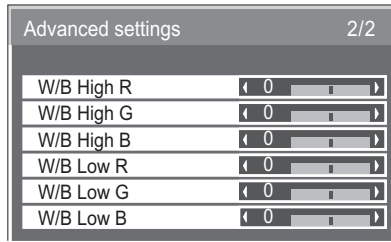
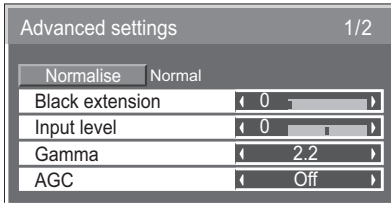

Item	Effect	Details
Black extension	◀ Less ▶ More	Adjusts the dark shades of the image in gradation.
Input level	◀ Less ▶ More	Adjustment of parts which are extremely bright and hard to see. (This cannot be adjusted when the input signal is Digital.)
Gamma	◀ Down ▶ Up	S Curve ←→ 2.0 ←→ 2.2 ←→ 2.5
AGC	◀ Off ▶ On	Increases the brightness of dark signal automatically.
W/B High R	◀ Less ▶ More	Adjusts the white balance for light red areas.
W/B High G	◀ Less ▶ More	Adjusts the white balance for light green areas.
W/B High B	◀ Less ▶ More	Adjusts the white balance for light blue areas.
W/B Low R	◀ Less ▶ More	Adjusts the white balance for dark red areas.
W/B Low G	◀ Less ▶ More	Adjusts the white balance for dark green areas.
W/B Low B	◀ Less ▶ More	Adjusts the white balance for dark blue areas.

Notes:

- Carry out “W/B” adjustment as follows.
 1. Adjust the white balance of the bright sections using the “W/B High R”, “W/B High G” and “W/B High B” settings.
 2. Adjust the white balance of the dark sections using the “W/B Low R”, “W/B Low G” and “W/B Low B” settings.
 3. Repeat steps 1 and 2 to adjust.
 Steps 1 and 2 affect each other’s settings, so repeat each step in turn to make the adjustment.
- The adjustment values are memorized separately for each input terminal.
- The adjustment range values should be used as an adjustment reference.

Helpful Hint ( /  **Normalisation)**

On the remote control unit, while the “Advanced settings” menu is displayed, if either the N button is pressed at any time or the ACTION (■) button is pressed during “Normalise”, then all adjustment values are returned to the factory settings.

Sound Adjustment

1  Press to display the Sound menu.

2 Select to adjust each item.

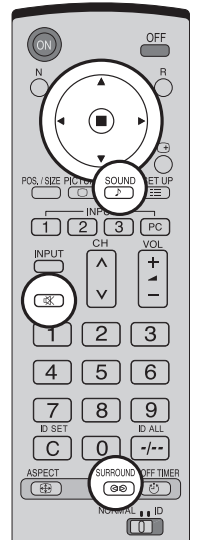
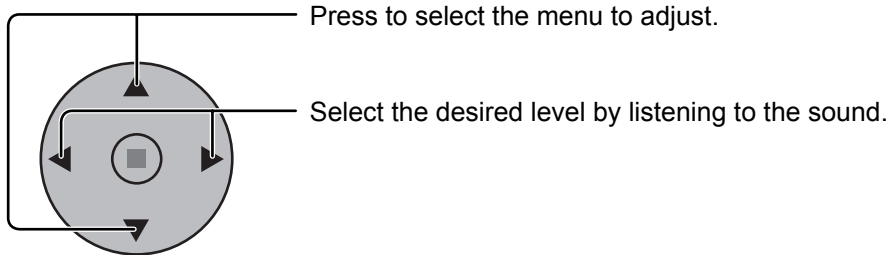

Bass
Adjusts low pitch sounds

Mid
Adjusts normal sounds

Treble
Adjusts high pitch sounds

Balance
Adjusts left and right volumes

Surround
Select On or Off

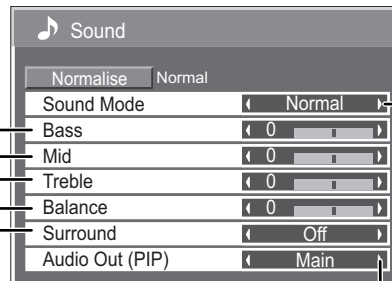

Normal Emits the original sound.

↕

Dynamic Accentuates sharp sound.

↕

Clear Attenuates human voice.

Main Selects main picture sound.

↕

Sub Selects PIP frame sound.

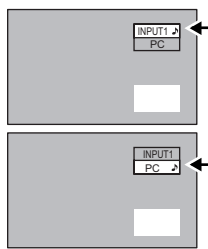

(When main picture sound is chosen.)

(When PIP frame sound is chosen.)

Musical note  is displayed on right side of the audio output screen label.

Notes:

- Press the SURROUND button to directly turn the surround effect On and Off. (see page 14)
- Bass, Mid, Treble and Surround settings are memorized separately for each Sound Mode.

Helpful Hint (/ **Normalise** **Normalisation**)

While the "Sound" menu is displayed, if either the N button on the remote control is pressed at any time or the ACTION () button is pressed during "Normalise", then all adjustment values are returned to the factory settings.

Mute

Useful when answering the phone or receiving unexpected visitors.

 Press to mute the sound.
Press again to reactivate sound. Sound is also reactivated when power is turned off or volume level is changed.

Digital Zoom

This displays an enlargement of the designated part of the displayed image.

1 Display the operation guide.

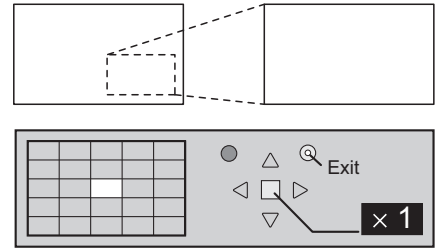
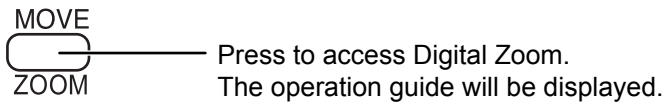

During Digital Zoom, only the following buttons can be operated.

[Remote control]

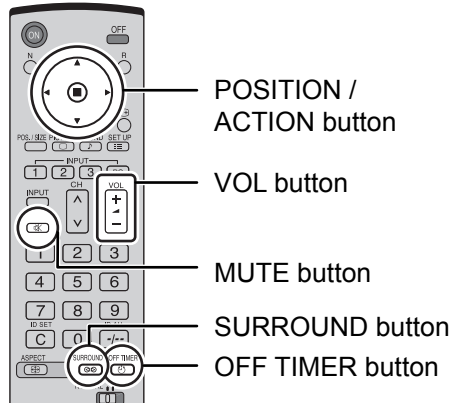

[Unit]

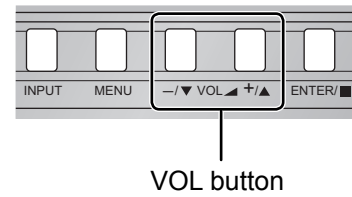

2 Select the area of the image to be enlarged.

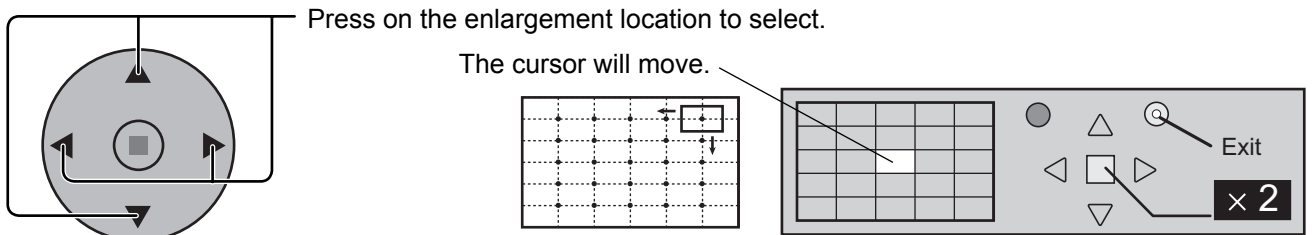

3 Select the magnification required for the enlarged display.

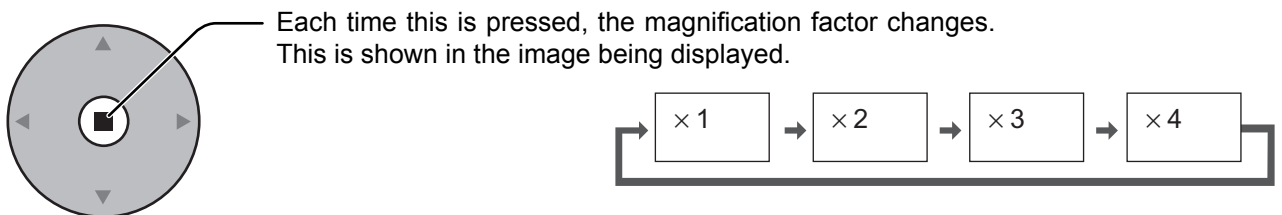

4 Return to normal display (quit Digital Zoom).

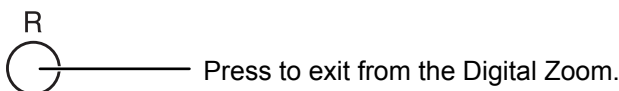

Notes:

- When power goes OFF (including "Off Timer" operation), Digital Zoom terminates.
- The Digital Zoom function cannot be selected while in the following operation state:
"Multi-viewer" (Picture in Picture, Picture out Picture, Picture and Picture) operation. (see page 20)
- While Digital Zoom is in operation, "Adjusting Pos. / Size" cannot be used.

PRESENT TIME Setup / Set up TIMER

The timer can switch the Plasma Display On or Off.

Before attempting Timer Set, confirm the PRESENT TIME and adjust if necessary. Then set POWER ON Time / POWER OFF Time.

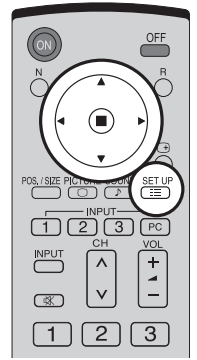

1  Press to display the Setup menu.

2 Press to select Set up TIMER or PRESENT TIME Setup.

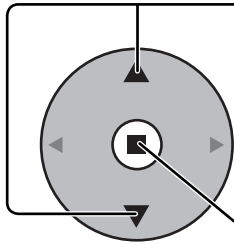

Press to display the Set up TIMER screen or PRESENT TIME Setup screen.

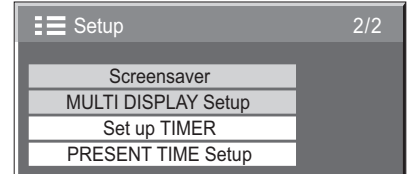
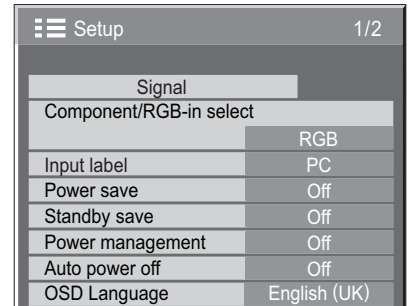

PRESENT TIME Setup

(For TH-42PS10BK/S)

Display the PRESENT TIME Setup screen.

To setup PRESENT TIME, follow the procedure described below.

1 Press to select PRESENT TIME.

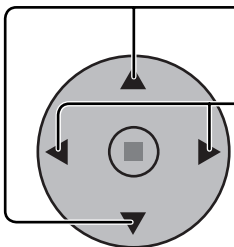

Press to setup PRESENT TIME.

▶ button: Forward

◀ button: Back

Notes:

- Pressing “◀” or “▶” button once changes PRESENT TIME 1minute.
- Pressing “◀” or “▶” button continuously changes PRESENT TIME by 15 minutes.

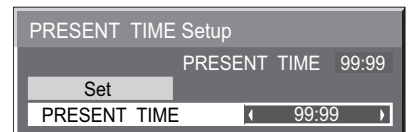

2 Press to select Set.

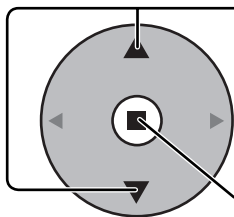

Press to store PRESENT TIME Setup.

Note:

Set cannot be selected unless PRESENT TIME is set.

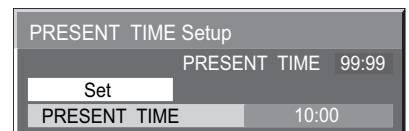

3  Press to exit from PRESENT TIME Setup.

PRESENT TIME Setup / Set up TIMER

(For TH-42PH10BK/S, TH-50PH10BK/S, TH-58PH10BK)

Display the PRESENT TIME Setup screen.

To setup DAY and PRESENT TIME, follow the procedure described below.

1

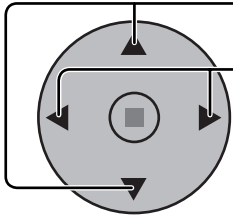

Press to select DAY or PRESENT TIME.

Press to setup DAY or PRESENT TIME.

▶ button: Forward

◀ button: Back

Notes:

- Pressing “◀” or “▶” button once changes PRESENT TIME 1minute.
- Pressing “◀” or “▶” button continuously changes PRESENT TIME by 15 minutes.

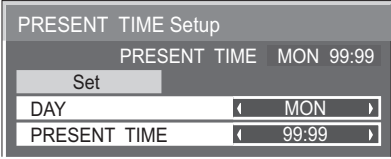

2

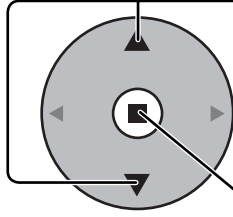

Press to select Set.

Press to store PRESENT TIME Setup.

Notes:

- Set cannot be selected unless PRESENT TIME is set.
- Unless setting the present time other than “99:99”, DAY setting is invalid.

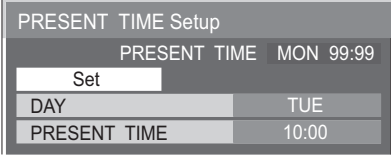

3



Press to exit from PRESENT TIME Setup.

Set up TIMER

Display the Set up TIMER screen.

1

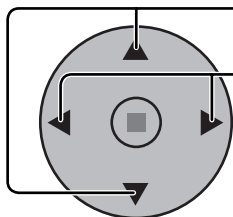

Press to select POWER ON Time / POWER OFF Time.

Press to setup POWER ON Time / POWER OFF Time.

▶ button: Forward

◀ button: Back

Notes:

- Pressing “◀” or “▶” button once changes POWER ON Time / POWER OFF Time 1minute.
- Pressing “◀” or “▶” button continuously changes POWER ON Time / POWER OFF Time by 15 minutes.

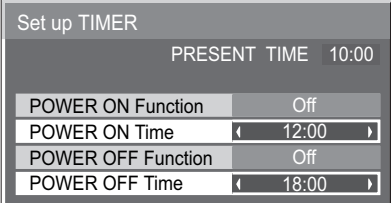

2

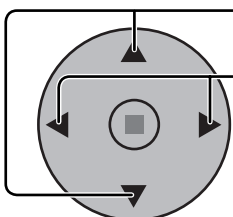

Press to select POWER ON Function/POWER OFF Function.

Press to select On.

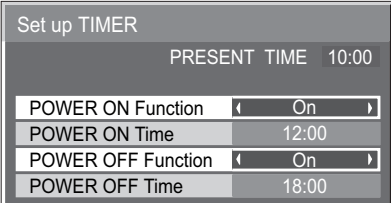

3



Press twice to exit from Setup.

Note:
Timer function will not work unless “PRESENT TIME” is set.

Screensaver (For preventing image retention)

Do not display a still picture, especially in 4:3 mode, for any length of time.
If the display must remain on, a Screensaver should be used.

1  Press to display the Setup menu.

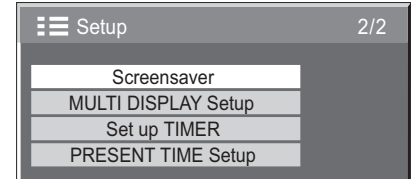

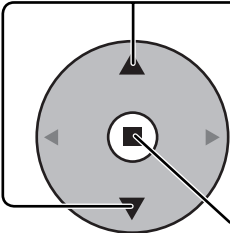
2  Press to select Screensaver.
Press to display Screensaver screen.

3 Reversal / Scroll selection

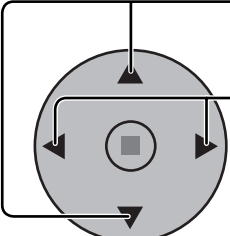
 Press to select Function.
Press to select the desired function.
White bar scroll \longleftrightarrow Image Reversal

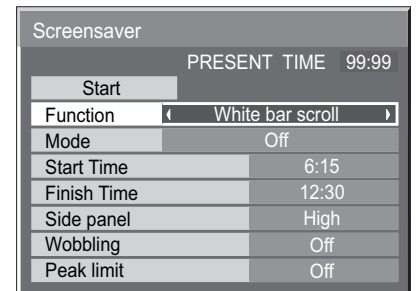

White bar scroll : The white bar will scroll from left to right.

Image Reversal : Negative image will be displayed on the screen.

4 Mode selection

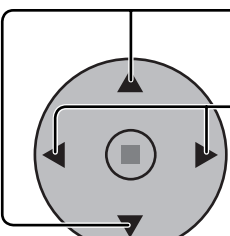
 Press to select Mode.
Press to select each mode items.

Off \updownarrow Interval \updownarrow Time Designation \updownarrow On

Interval : Operates when Periodic Time and Operating Time are setup and those times arrive.
Time Designation : Operates when Start Time and Finish Time are setup and those times arrive.
On : Operates when Start is selected and the ACTION (■) button is pressed.

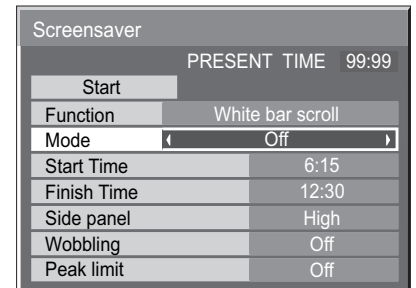

5 Start setting

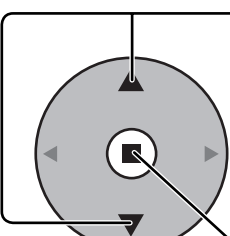
 When the Mode is set to On, press to select Start.
Press to start Screensaver.

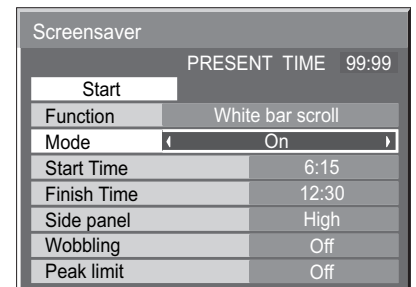

The menu screen will disappear and the Screensaver will be activated. **To stop the Screensaver under On, press the R button.**

Screensaver (For preventing image retention)

Setup of Screensaver Time

After selecting Time Designation or Interval, the relevant Time Setup will become available for selection and the Operating Time may be set. (Time cannot be set when "Mode" is "On" or "Off".)

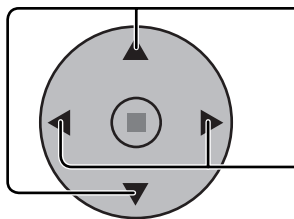
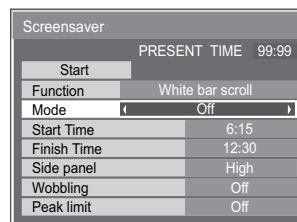
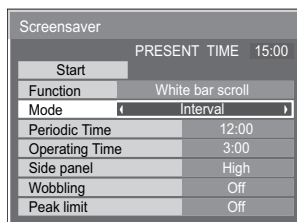
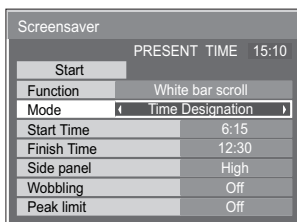

Press to select Start Time / Finish Time (When Time Designation is selected).
 Press to select Periodic Time / Operating Time (When Interval is selected).

Press to setup.
 ▶ button: Forward
 ◀ button: Back

Notes:

- Pressing "◀" or "▶" button once changes the Time 1 minute. [However, switching occurs every 15 minutes when Periodic Time is selected.]
- Pressing "◀" or "▶" button continuously changes the Time by 15 minutes.

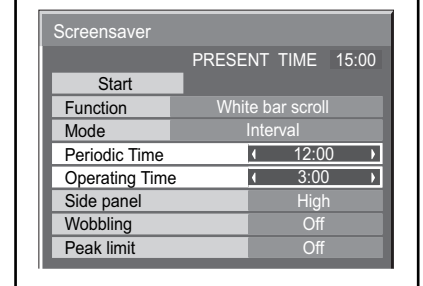
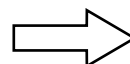
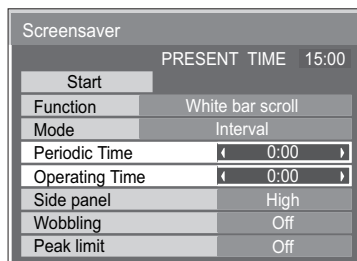
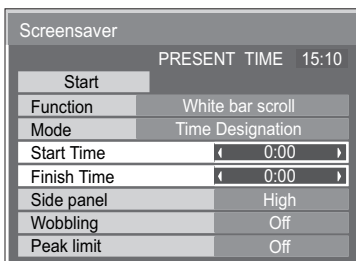
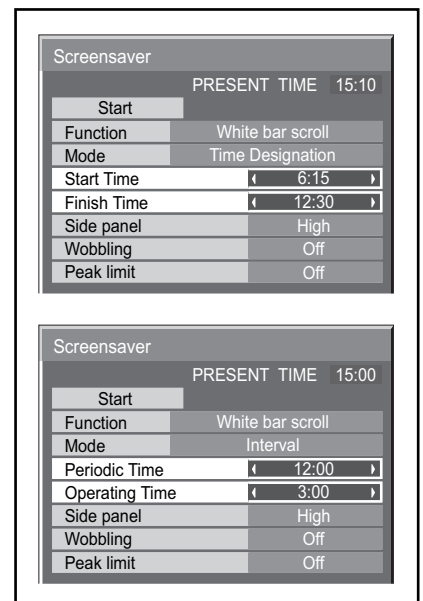

Note: Timer function will not work unless "PRESENT TIME" is set.

Reduces screen image retention

These functions prevent the occurrence of an "image retention" on the display when turned ON.

Wobbling: Automatically shifts the display image (therefore unnoticeable to the eye) to prevent image retention of sharper contour of image.

On1: Shifts the image every 30 seconds.

On2: Shifts the image at a dot level pitch depending on screen-detection.

Peak limit: Suppresses image contrast (peak brightness).

Note: When a still picture is viewed for an extended time, the screen may become slightly darker. (see page 51)

1 Press to display the Setup menu.

2 Press to select "Screensaver".
 Press to display Screensaver menu.

3 Press to select "Wobbling" or "Peak limit".
 Press to select "On1", "On2" or "Off" (Wobbling).
 "On" or "Off" (Peak limit).

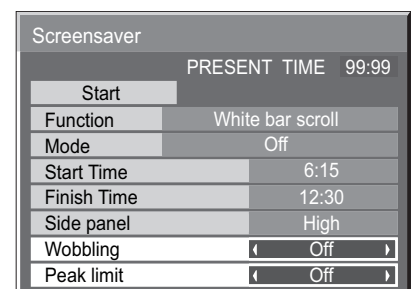
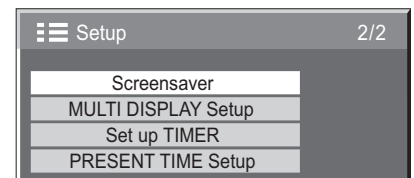

Side Panel Adjustment

Do not display a picture in 4:3 mode for an extended period, as this can cause an image retention to remain on the side panels either side of the display field. To reduce the risk of such an image retention, illuminate the side panels.

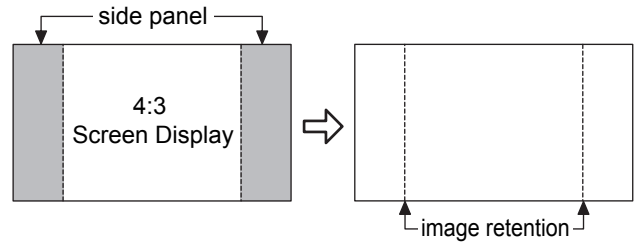

This function may be applicable to the non-picture area.

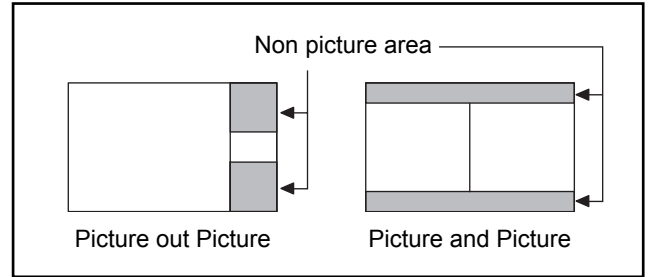

Display the Screensaver screen.
(Refer to the previous page, operation guide steps 1 and 2)

1

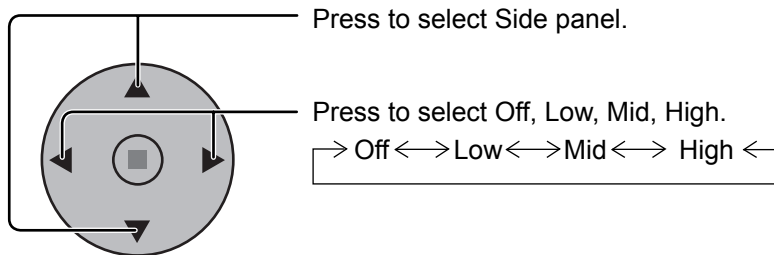

Screensaver	
	PRESENT TIME 99:99
Start	----
Function	White bar scroll
Mode	Off
Start Time	6:15
Finish Time	12:30
Side panel	High
Wobbling	Off
Peak limit	Off

2

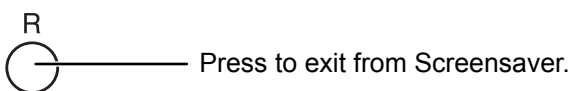

Notes:

- To reduce the occurrence of image retention, set the Side panel to High.
- The side panels may flash (alternate black / white) depending on the picture being shown on the screen. Using Cinema mode will reduce such flashing.

Reduces power consumption

- Power save: When this function is turned On, luminous level of the Plasma Display is suppressed, so power consumption is reduced.
- Standby save: When this function is turned On, power consumption of the microcomputer is reduced during power supply standby (see page 12, 14-15), so standby power of the set is reduced.
- Power management: The unit power supply is turned On or Off depending on whether or not there is a signal during PC input mode. This function is enabled when it is turned On. (Only during input from PC (Mini D-sub) terminal)
- Auto power off: Equipment power supply is turned Off when there is no signal. When this is set to On, the power supply of the unit goes Off 10 minutes after the input signals stop. This function is effective for input signals except input from PC (Mini D-sub) terminal.

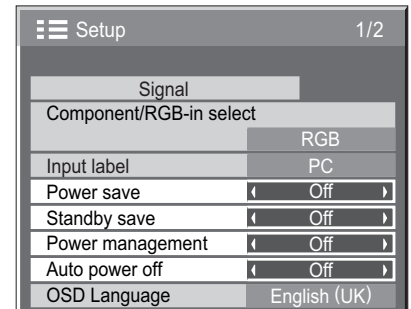
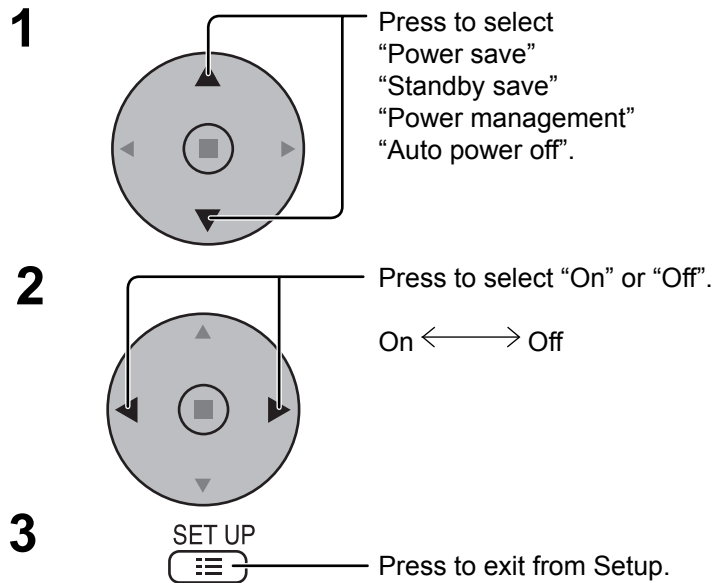

Note:
 “Power management” and “Auto power off” are effective during normal viewing (one picture screen) only.

Customizing the Input labels

This function can change the label of the Input signal to be displayed. Select the input signal which you would like to change its label before customizing the Input labels. (see page 13,15)

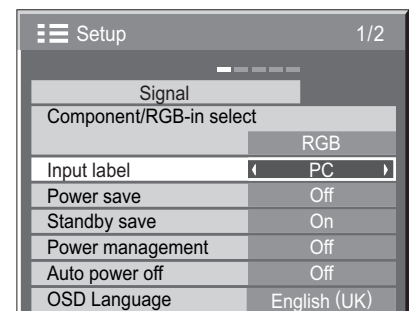
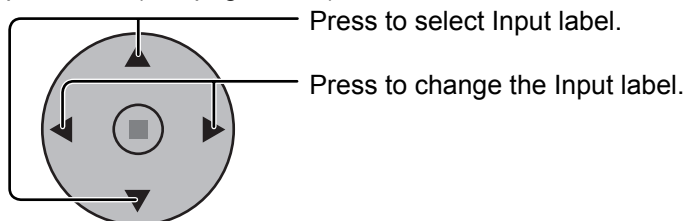

Note:
 While selecting an Input signal through Optional Terminal Board connected to Slot1, Slot2 and Slot3, the Input label will depend on each Optional Terminal Board.

Input labels for Slot1, Slot2, Slot3 and Mini D-sub:

[Slot1 Input] INPUT1 / VIDEO1 / COMPONENT1 / RGB1 / DIGITAL1 / PC1 / DVD1 / CATV1 / VCR1 / STB1

[Slot2 Input] INPUT2 / VIDEO2 / COMPONENT2 / RGB2 / DIGITAL2 / PC2 / DVD2 / CATV2 / VCR2 / STB2

[Slot3 Input] INPUT3 / VIDEO3 / COMPONENT3 / RGB3 / PC3 / DVD3 / CATV3 / VCR3 / STB3

[PC (Mini D-sub) input] PC / COMPONENT / RGB / DVD / STB

When BNC Dual Video Terminal Board (TY-FB9BD) is used, an “A” or “B” is added at the end of each input label, depending on the input selected (see below).

Addition sign	“A”	“B”
Selected Input	Composite	S VIDEO

Setup for MULTI DISPLAY

(For TH-42PS10BK/S)

By lining up Plasma Displays in groups of 4, 9 or 16 as illustrated below, an enlarged picture may be displayed across all screens.

For this mode of operation, each plasma display has to be set up with a Display number to determine its location.

group of 4 (2 × 2 (F))



group of 9 (3 × 3 (F))



group of 16 (4 × 4 (F))



Two options are selectable for MULTI DISPLAY (see next page).

How to Setup MULTI DISPLAY

- 1**  Press to display the Setup menu.

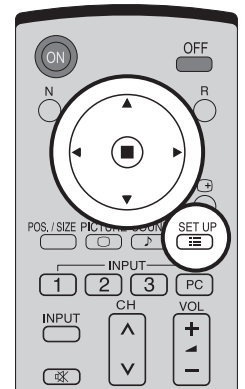

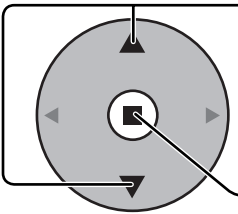
- 2**  Press to select the MULTI DISPLAY Setup.
Press to display the "MULTI DISPLAY Setup" menu.

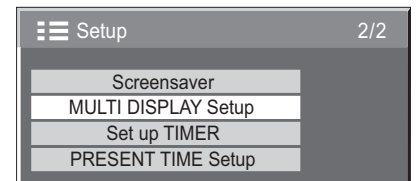

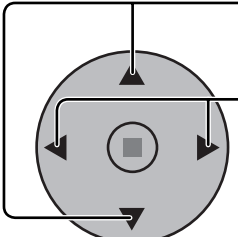
- 3**  Press to select the MULTI DISPLAY Setup.
Press to select "On" or "Off".

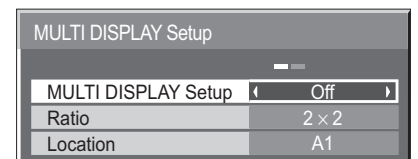

How to set the display location number for each Plasma Display

4

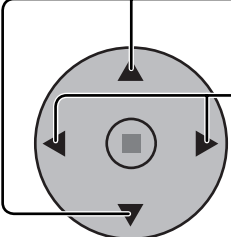

Press to select Ratio (2nd step).

Press to select "2 x 2", "2 x 2 F", "3 x 3", "3 x 3F", "4 x 4", "4 x 4F".

MULTI DISPLAY Setup	
MULTI DISPLAY Setup	Off
Ratio	2 x 2
Location	A1

5

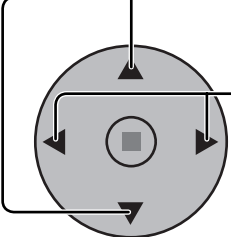

Press to select Location.

Press to select the required arrangement number.
(A1-D4 : Refer to the following)

MULTI DISPLAY Setup	
MULTI DISPLAY Setup	Off
Ratio	2 x 2
Location	A1

Display Number locations for each arrangement

(2 x 2 (F))		(3 x 3 (F))			(4 x 4 (F))			
A1	A2	A1	A2	A3	A1	A2	A3	A4
B1	B2	B1	B2	B3	B1	B2	B3	B4
		C1	C2	C3	C1	C2	C3	C4
					D1	D2	D3	D4

6



Press twice to exit from Setup.

(For TH-42PH10BK/S, TH-50PH10BK/S, TH-58PH10BK)

By lining up Plasma Displays in groups, for example, as illustrated below, an enlarged picture may be displayed across all screens. For this mode of operation, each plasma display has to be set up with a Display number to determine its location.

(Example)

group of 4 (2 × 2)

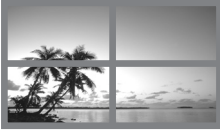

group of 9 (3 × 3)



group of 16 (4 × 4)



(see page 36 for more displays lineups.)

How to Setup MULTI DISPLAY

1



Press to display the Setup menu.

2

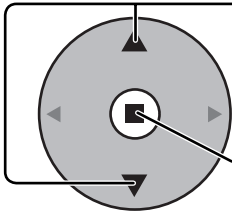

Press to select the MULTI DISPLAY Setup.

Press to display the "MULTI DISPLAY Setup" menu.

3

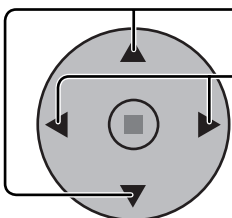

Press to select the MULTI DISPLAY Setup.

Press to select "On" or "Off".

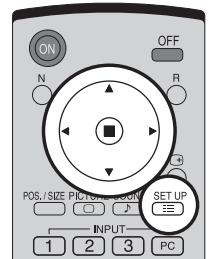

Setup	2/2
Screensaver	
MULTI DISPLAY Setup	
Set up TIMER	
PRESENT TIME Setup	

MULTI DISPLAY Setup	
MULTI DISPLAY Setup	Off
Horizontal Scale	x 2
Vertical Scale	x 2
Seam hides video	Off
Location	A1
Power On Screen Delay	On

How to set the display location number for each Plasma Display

4

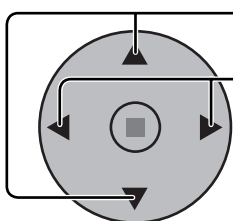

Press to select Horizontal Scale.

Press to select "x 1", "x 2", "x 3", "x 4".

5

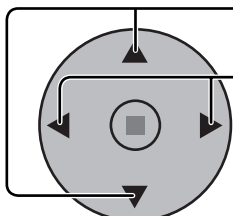

Press to select Vertical Scale.

Press to select "x 1", "x 2", "x 3", "x 4".

MULTI DISPLAY Setup	
MULTI DISPLAY Setup	Off
Horizontal Scale	x 2
Vertical Scale	x 2
Seam hides video	Off
Location	A1
Power On Screen Delay	On

MULTI DISPLAY Setup	
MULTI DISPLAY Setup	Off
Horizontal Scale	x 2
Vertical Scale	x 2
SEAM HIDES VIDEO	Off
Location	A1
Power On Screen Delay	On

Setup for MULTI DISPLAY

6

Press to select Seam hides video.

Press to select "Off", "On".

MULTI DISPLAY Setup	
MULTI DISPLAY Setup	Off
Horizontal Scale	× 2
Vertical Scale	× 2
Seam hides video	Off
Location	A1
Power On Screen Delay	On

7

Press to select Location.

Press to select the required arrangement number. (A1-D4 : Refer to the following)

MULTI DISPLAY Setup	
MULTI DISPLAY Setup	Off
Horizontal Scale	× 2
Vertical Scale	× 2
Seam hides video	Off
Location	A1
Power On Screen Delay	On

Display Number locations for each arrangement.
(Examples)

(2 × 1)		(2 × 3)		(4 × 2)				(4 × 4)			
A1	A2	A1	A2	A1	A2	A3	A4	A1	A2	A3	A4
		B1	B2	B1	B2	B3	B4	B1	B2	B3	B4
		C1	C2					C1	C2	C3	C4
								D1	D2	D3	D4

8 Power On Screen Delay

Turning the power on for the multiple displays system, each display is turned on with a time lag to reduce the power load.

Press to select Power On Screen Delay.

Press to select Off or On.

Off: All the display turns on simultaneously.
On: Each display turns on in the order of Location.
Delay time=Location (difference from A1) × 1 sec.
Example) Case of B2 in 4 × 2 → A1, A2, A3, A4, B1, B2 → 5 sec.

MULTI DISPLAY Setup	
MULTI DISPLAY Setup	ON
Horizontal Scale	× 2
Vertical Scale	× 2
Seam hides video	Off
Location	A1
Power On Screen Delay	On



Notes:

- This setting is valid when MULTI DISPLAY Setup is On.
- During this function is working, the power indicator is blinking green.
- This function also works when the power recovers from failure or after plugging off and in again the power cord. If unplugging and plugging the power cord while the unit is in standby mode and the power is being supplied to the board, each unit has time delay to start supplying the power to the attached board according to Location, and the power indicator lights up red first and it turns orange when the power starts being supplied to the board.

9









Press twice to exit from Setup.

F (Seam hides video) Setting

Model No.	Reference	To hide joints between displays.  Suitable for moving image display.	To show joints between displays.  Suitable for still image display.
TH-42PS10BK/S	Step 4, Page 34	(2 × 2, 3 × 3, 4 × 4)	(2 × 2F, 3 × 3F, 4 × 4F)
TH-42/50PH10BK/S, TH-58PH10BK	Step 6, Page 36	On	Off

ID Remote Control Function

You can set the remote control ID when you want to use this remote control on one of several different displays.

- 1 Switch  to  on the right side.
- 2 Press the  button on the remote control.
- 3 Press one of , ,  for the tens digit setting.
- 4 Press one of , ,  for the units digit setting.

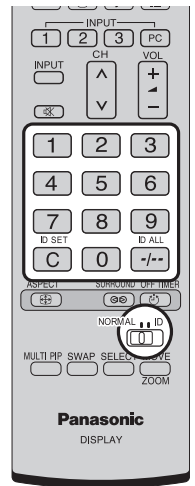





Notes:

- The numbers in 2, 3 and 4 should be set up quickly.
- Adjustable ID number range is 0 - 99.
- If a number button is pressed more than two times, the first two numbers become the ID number for the remote control.

ID remote control button operation

The operation is the same as normal remote control except for the  button.

ID Cancellation

Press  button on remote control. (This has the same effect as pressing the , ,  buttons at the same time.)

Notes:

- Set the Remote ID "On" to operate the ID remote control.
If Remote ID is set to "On", you can use the remote control without identical ID number during option menu display. (see page 43, 46)
- The ID remote control cannot be used when ID select is set to anything other than 0, and the remote control ID is not the same as the ID select number (see page 43, 46).

Setup for Input Signals

Component / RGB-in select

Select to match the signals from the source connected to the Component / RGB input terminals.

Y, P_B, P_R signals ⇔ "Component"

R, G, B, HD, VD signals ⇔ "RGB"

1  Press to display the Setup menu.

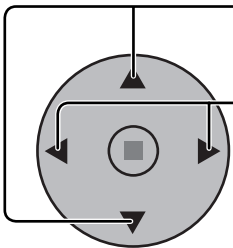
2  Press to select the "Component / RGB-in select".
Press to select the desired input signal.
Component ← → RGB

3  Press to exit from adjust mode.

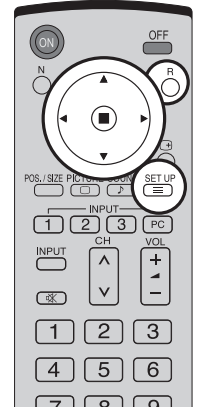

Setup 1/2	
Signal	Component/RGB-in select
	RGB
Input label	PC
Power save	Off
Standby save	Off
Power management	Off
Auto power off	Off
OSD Language	English (UK)

Note:

Selection may not be possible, depending on which optional board is installed.

3D Y/C Filter – For NTSC AV images

Select "Signal" from the "Setup" menu during AV(S Video) input signal. ("Signal [AV]" menu is displayed.)

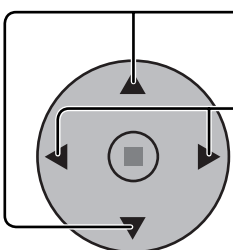
1  Press to select the "3D Y/C Filter (NTSC)"
Press to set On / Off.

2  Press to exit from adjust mode.

Setup 1/2	
Signal	Component/RGB-in select
	RGB
Input label	PC
Power save	Off
Standby save	Off
Power management	Off
Auto power off	Off
OSD Language	English (UK)

↓ Press ACTION (■) button

Signal [AV]	
3D Y/C Filter (NTSC)	On
Colour system	Auto
Cinema reality	Off
Panasonic Auto (4 : 3)	4 : 3
P-NR	Off

Note:

When On, this setting only affects NTSC input signals.

Colour system / Panasonic Auto

Select Signal from the "Setup" menu during AV(S Video) input signal. ("Signal [AV]" menu is displayed.)

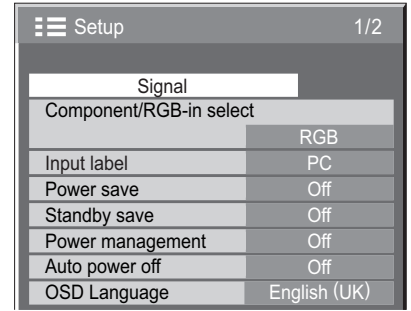
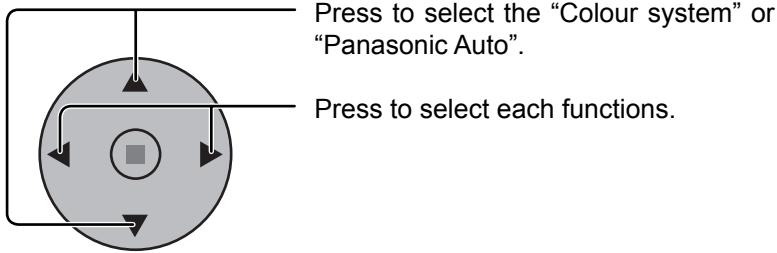

Press ACTION (■) button

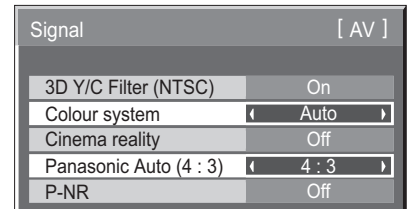

If the picture image becomes unstable:

With the system set on Auto, under conditions of low level or noisy input signals the image may in rare cases become unstable. Should this occur, set the system to match the format of the input signal.

Mode	Function
Colour system	Set the colour system to match the input signal. When selecting "AUTO", the colour system is automatically selected from NTSC/PAL/SECAM, however, M.NTSC signal is not displayed properly depending on the attached terminal board. To display M.NTSC signal, select "M.NTSC" in Colour system. <div style="text-align: center;"> → Auto ↔ PAL ↔ SECAM ↔ M.NTSC ↔ NTSC ← </div>
Panasonic Auto (4 : 3)	Set to "4 : 3" to view 4:3 images in an unchanged format when Panasonic Auto is selected. If you would like to view 4:3 images in Just format, set to "Just".

Note:

Panasonic Auto does not function when BNC Dual Video Terminal Board (TY-FB9BD) is used.

Cinema reality / P-NR

Cinema reality:

When on, the display attempts to reproduce a more natural interpretation of sources such as movie pictures, which are recorded at 24 frames per second.

If the picture is not stable, turn the setting to off.

Note:

When On, this setting only affects the following signal input:

- NTSC / PAL signal input during "AV(S Video)" input signal.
- 525i(480i) 625i(575i), 1125(1080) / 60i signal input during "Component" input signal.

P-NR:

Automatically reduces unwanted picture noise.

Note:

P-NR cannot be adjusted while a PC signal is being applied.

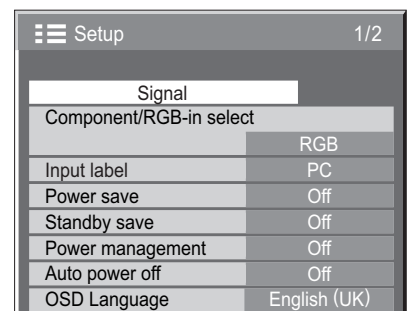

Press ACTION (■) button

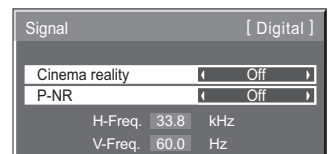
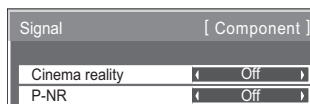
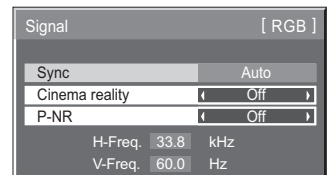
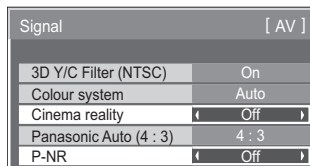
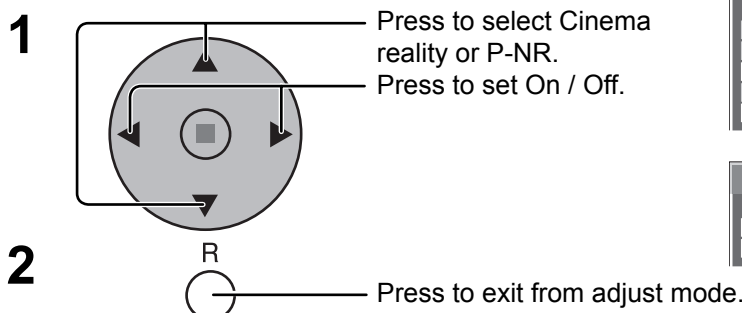

Sync

Select Signal from the “Setup” menu during RGB input signal.

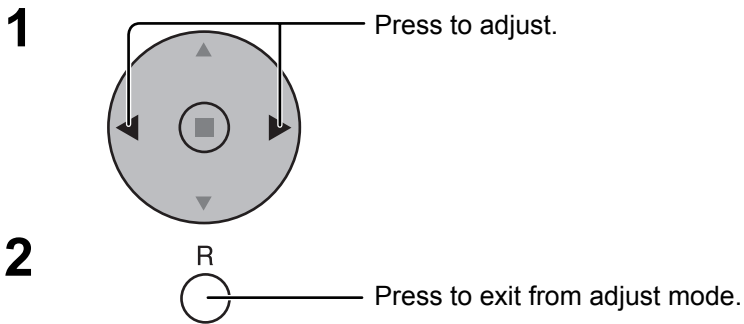

Setting RGB sync signal:

Confirm that the input is set to RGB input (this setting is valid only for RGB input signal).

- Auto: The H and V sync or synchronized signal are automatically selected. If both input, it is selected the H and V sync.
- on G: Uses a synchronized signal on the Video G signal, which is input from the G connector.
- VBS: Uses a synchronized signal of Composite Sync input, which is input from the HD connector.

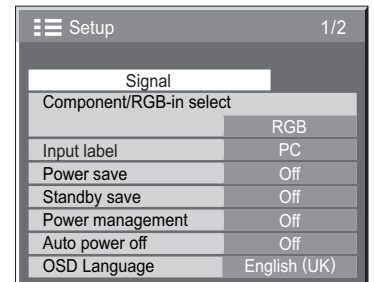

↓ Press ACTION (■) button

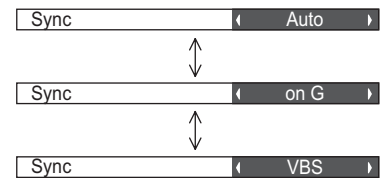
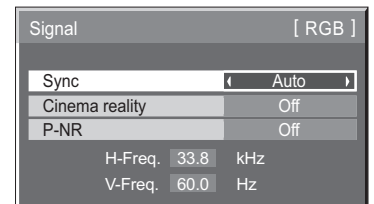

H-Freq. (kHz) / V-Freq. (Hz)

Displays the H (Horizontal) / V (Vertical) frequencies.

This display is valid only for RGB / PC and Digital input signal.



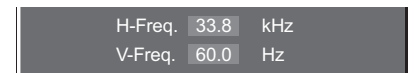

Display range:

- Horizontal 15 - 110 kHz
- Vertical 48 - 120 Hz

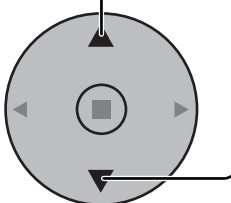

Options Adjustments

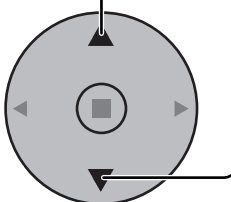
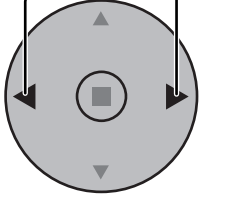
(For TH-42PS10BK/S)

- 1  Press to display the Setup menu.
- 2  Press to select "OSD Language".
- 3  Press and hold until the Options menu is displayed.
- 4  Press to select your preferred menu.
- 5  Press to adjust the menu.
- 6  Press to exit from Options menu.

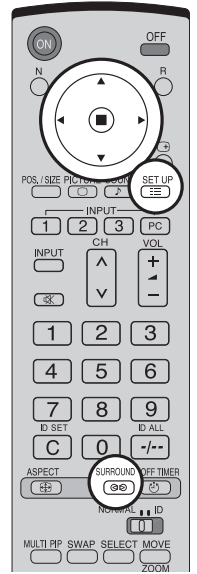





Options		1/3
Off-timer function	Enable	▶
Onscreen display	On	▶
Initial INPUT	Off	▶
Initial VOL level	Off	0
Maximum VOL level	Off	0
INPUT lock	Off	
Studio W/B	Off	
Advanced PIP	Off	
Display size	Off	

Item	Effect	Adjustments
Off-timer function	◀ Enable ▶ Disable	Enable: Enables the "Off-timer function". Disable: Disables the "Off-timer function". Note: When "Disable" is set, the Off-timer is cancelled.
Onscreen display	◀ On ▶ Off	On: Displays all the following on screen. • Power on display • Input signal switch display • No signal display • Mute and the remaining time of off-timer after  was pressed. Off: Hides all the items above from view.
Initial INPUT	◀ ▶	Off ↔ PC ↔ INPUT1 ↔ INPUT2 ↔ INPUT3 Adjusts the input signal when the unit is turned on. Notes: • Only the adjusted signal is displayed. (see page 13). • Signal can be displayed when the Terminal board is installed. • This menu is available only when "INPUT lock" is "Off". • When a dual input terminal board is attached, A or B is displayed depending on the selected input signal. (Ex. INPUT1A, INPUT1B)



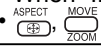











Options Adjustments

Options		1/3
Off-timer function	Enable	
Onscreen display	On	
Initial INPUT	Off	
Initial VOL level	Off 0	▶
Maximum VOL level	Off 0	▶
INPUT lock	Off	▶
Studio W/B	Off	▶
Advanced PIP	Off	▶
Display size	Off	▶

Item	Effect	Adjustments
Initial VOL level	◀ Off ▶ On	<p>Press  button to adjust the volume when the unit is turned on.</p> <p>Off ↔ On Off: Sets normal volume. On: Sets your preferred volume.</p> <p>Notes:</p> <ul style="list-style-type: none"> When "Maximum VOL level" is "On", the volume can only be adjusted between 0 and your maximum range. You can hear the changed volume regardless of your volume setting before opening the options menu if you adjust the volume when "Initial VOL level" is "On" and cursor is on the menu.
Maximum VOL level	◀ Off ▶ On	<p>Press  button to adjust the maximum volume.</p> <p>Off ↔ On Off: Sets auto maximum volume. On: Sets your preferred maximum volume.</p> <p>Notes:</p> <ul style="list-style-type: none"> If the "Maximum VOL level" is set lower than the "Initial VOL level", the "Initial VOL level" automatically becomes the same as the "Maximum VOL level". The volume display can go up to 63 regardless of the settings. You can hear the changed volume regardless of your volume setting before opening the options menu if you adjust the volume when "Maximum VOL level" is "On" and cursor is on the menu.
INPUT lock	◀ ▶	<p>Off ↔ PC ↔ INPUT1 ↔ INPUT2 ↔ INPUT3 Locks the input switch operation.</p> <p>Notes:</p> <ul style="list-style-type: none"> Only the adjusted signal is displayed (see page 13). Signal can be displayed when the Terminal board is installed. Input switch can be used when this is set to "Off". In two screen display mode, if anything other than "Off" is set, the value will be fixed as the value input in the single screen display mode. When a dual input terminal board is attached, A or B is displayed depending on the selected input signal. (Ex. INPUT1A, INPUT1B)
Studio W/B	◀ Off ▶ On	<p>Off: Nullify all the settings adjusted. On: Sets the colour temperature for TV studio.</p> <p>Note: Valid only when the low is set as colour temperature on screen adjustment.</p>
Advanced PIP	◀ Off ▶ On	<p>Off: Sets normal two screen display mode (see page 20). On: Sets Advanced PIP mode (see page 21).</p> <p>Notes:</p> <ul style="list-style-type: none"> When "INPUT lock" is "On", you cannot use all the two screen display functions.  buttons are unavailable during Advanced PIP mode operation.
Display size	◀ Off ▶ On	<p>Adjusts the image display size on screen.</p> <p>Off: Sets the normal image display size on screen. On: Sets the image display size approximately 95 % of the normal image display.</p> <div style="display: flex; justify-content: space-around; align-items: center;"> <div style="text-align: center;"> <p>Off</p>  </div> <div style="text-align: center;"> <p>On</p>  </div> </div> <p>Notes:</p> <ul style="list-style-type: none"> This setting is valid only when the input signals are as follows; 525i, 525p, 625i, 625p, 750/60p, 750/50p, 1125/60i, 1125/50i, 1125/24sF, 1125/25p, 1125/24p, 1125/30p, 1250/50i (Component Video, RGB, DVI, SDI, HDMI) This setting is invalid when two screen display, digital zoom or Multi screen is selected. When "Display size" is set to "On", Pos. /Size adjustment cannot be used. Refer to each board's operating instruction for DVI, SDI, HDMI's corresponding signals.

Options Adjustments

Options		2/3
Button lock	◀	Off ▶
Remocon User level	◀	Off ▶
ID select	◀	0 ▶
Remote ID	◀	Off ▶
Serial ID	◀	Off ▶



Item	Effect	Adjustments
Button lock	◀ ▶	<p>Off ↔ MENU&ENTER ↔ On</p> <p>Off: All the buttons at the bottom of the main unit can be used.</p> <p>MENU & ENTER:</p> <p>Locks  and  buttons on bottom face of main unit.</p> <p>On: Locks all the button on bottom face of main unit.</p>
Remocon User level	◀ ▶	<p>Off ↔ User1 ↔ User2 ↔ User3</p> <p>Off: You can use all of the buttons on the remote control.</p> <p>User1: You can only use , , , , , , , , ,  buttons on the remote control.</p> <p>User2: You can only use ,  buttons on the remote control.</p> <p>User3: Locks all the buttons on remote control.</p>
ID select	◀ ▶	<p>Sets panel ID number when panel is used in “Remote ID” or “Serial ID”.</p> <p>Set value range: 0 - 100</p> <p>(Standard value: 0)</p>
Remote ID	◀ Off ▶ On	<p>Off: Disables ID remote control functions. You can use normal remote control operations.</p> <p>On: Enable ID remote control functions.</p>
Serial ID	◀ Off ▶ On	<p>Sets the panel ID Control.</p> <p>Off: Disables external control by the ID.</p> <p>On: Enables the external control by the ID.</p>

Options		3/3
Slot power	◀	Off ▶
V. Installation	◀	Off ▶
Rotate	◀	Off ▶
Serial Slot Select	◀	Slot1 ▶

Item	Effect	Adjustments
Slot Power	◀ ▶	<p>Off ↔ Auto ↔ On</p> <p>Off: Power is not transmitted to the slot power.</p> <p>Auto: Power is transmitted to the slot power only when main power is on.</p> <p>On: Power is transmitted to the slot power when main power is on or in the standby state.</p> <p>Note: In some cases, power is transmitted to the slot power when main power is on or in the standby state regardless of the slot power setting.</p>
V.Installation	◀ Off ▶ On	<p>Off: Sets fan to the horizontal installation mode.</p> <p>On: Sets fan to the vertical installation mode.</p> <p>Notes:</p> <ul style="list-style-type: none"> • This functions when display is turned on. • Vertical installation is available without this mode setting. • Turn up the power switch for the upward direction when you set Display vertically.
Rotate	◀ Off ▶ On	<p>Off: Does not rotate the image.</p> <p>On: Rotates the image 180 degrees.</p>
Serial Slot Select	◀ ▶	<p>Slot1 ↔ Slot2 ↔ Slot3</p> <p>Selects the slot which communicates serial.</p> <p>Note: The setting of an external command can be set only from the fixed serial terminal (see page 10).</p>





Normalization

When both main unit buttons and remote control are disabled due to the “Button lock”, “Remocon User level” or “Remote ID” adjustments, set all the values “Off” so that all the buttons are enabled again.

Press the  button on main unit together with  button on the remote control and hold for more than 5 seconds. The “SHIPPING” menu is displayed and the lock is released when it disappears.

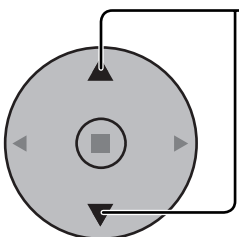
Options Adjustments

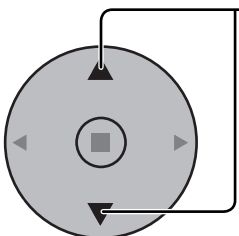
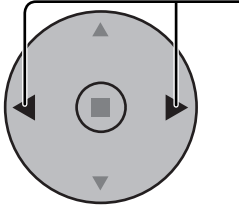



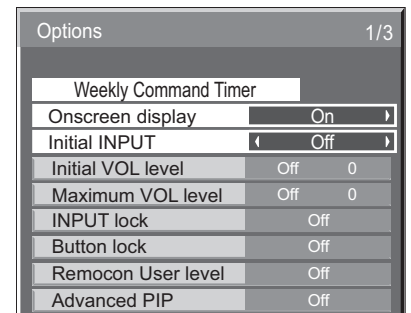
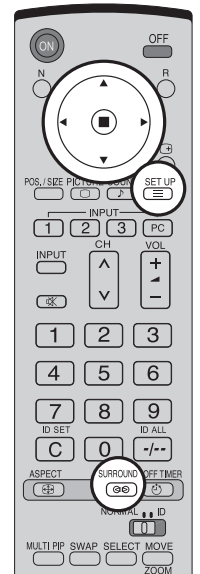



























(For TH-42PH10BK/S, TH-50PH10BK/S, TH-58PH10BK)

- 1  Press to display the Setup menu.
- 2  Press to select "OSD Language".
- 3  Press and hold until the Options menu is displayed.
- 4  Press to select your preferred menu.
- 5  Press to adjust the menu.
- 6  Press to exit from Options menu.





Item	Effect	Adjustments
Weekly Command Timer	—	Sets Weekly Command Timer. (see page 48)
Onscreen display	◀ On ▶ Off	On: Displays all the following on screen. <ul style="list-style-type: none"> • Power on display • Input signal switch display • No signal display • Mute and the remaining time of off-timer after  was pressed. Off: Hides all the items above from view.
Initial INPUT	◀ ▶	Off ↔ PC ↔ INPUT1 ↔ INPUT2 ↔ INPUT3 Adjusts the input signal when the unit is turned on. Notes: <ul style="list-style-type: none"> • Only the adjusted signal is displayed. (see page 13). • Signal can be displayed when the Terminal board is installed. • This menu is available only when "INPUT lock" is "Off". • When a dual input terminal board is attached, A or B is displayed depending on the selected input signal. (Ex. INPUT1A, INPUT1B)

Options		1/3
Weekly Command Timer		
Onscreen display		On
Initial INPUT		Off
Initial VOL level	Off	0
Maximum VOL level	Off	0
INPUT lock	Off	
Button lock	Off	
Remocon User level	Off	
Advanced PIP	Off	

Item	Effect	Adjustments
Initial VOL level	◀ Off ▶ On	<p>Press  button to adjust the volume when the unit is turned on.</p> <p>Off ↔ On Off: Sets normal volume. On: Sets your preferred volume.</p> <p>Notes:</p> <ul style="list-style-type: none"> • When "Maximum VOL level" is "On", the volume can only be adjusted between 0 and your maximum range. • You can hear the changed volume regardless of your volume setting before opening the options menu if you adjust the volume when "Initial VOL level" is "On" and cursor is on the menu.
Maximum VOL level	◀ Off ▶ On	<p>Press  button to adjust the maximum volume.</p> <p>Off ↔ On Off: Sets auto maximum volume. On: Sets your preferred maximum volume.</p> <p>Notes:</p> <ul style="list-style-type: none"> • If the "Maximum VOL level" is set lower than the "Initial VOL level", the "Initial VOL level" automatically becomes the same as the "Maximum VOL level". • The volume display can go up to 63 regardless of the settings. • You can hear the changed volume regardless of your volume setting before opening the options menu if you adjust the volume when "Maximum VOL level" is "On" and cursor is on the menu.
INPUT lock	◀ ▶	<p>Off ↔ PC ↔ INPUT1 ↔ INPUT2 ↔ INPUT3 Locks the input switch operation.</p> <p>Notes:</p> <ul style="list-style-type: none"> • Only the adjusted signal is displayed (see page 13). • Signal can be displayed when the Terminal board is installed. • Input switch can be used when this is set to "Off". • In two screen display mode, if anything other than "Off" is set, the value will be fixed as the value input in the single screen display mode. • When a dual input terminal board is attached, A or B is displayed depending on the selected input signal. (Ex. INPUT1A, INPUT1B)
Button lock	◀ ▶	<p>Off ↔ MENU&ENTER ↔ On Off: All the buttons at the bottom of the main unit can be used.</p> <p>MENU & ENTER: Locks  and  buttons on bottom face of main unit.</p> <p>On: Locks all the button on bottom face of main unit. Sets Button lock with the unit buttons in the following procedure.</p> <p>Off: Press  four times → Press  four times → Press  four times → Press </p> <p>MENU & ENTER: Press  four times → Press  four times → Press  four times → Press </p> <p>On: Press  four times → Press  four times → Press  four times → Press </p>
Remocon User level	◀ ▶	<p>Off ↔ User1 ↔ User2 ↔ User3 Off: You can use all of the buttons on the remote control.</p> <p>User1: You can only use , , , , , , , , , ,  buttons on the remote control.</p> <p>User2: You can only use ,  buttons on the remote control.</p> <p>User3: Locks all the buttons on remote control.</p>
Advanced PIP	◀ Off ▶ On	<p>Off: Sets normal two screen display mode (see page 20). On: Sets Advanced PIP mode (see page 21).</p> <p>Notes:</p> <ul style="list-style-type: none"> • When "INPUT lock" is "On", you cannot use all the two screen display functions. • , ,  buttons are unavailable during Advanced PIP mode operation.

Options Adjustments

Options		2/3
Off-timer function	Enable	▶
Initial Power Mode	Normal	▶
ID select	0	▶
Remote ID	Off	▶
Serial ID	Off	▶
Display size	Off	▶
Studio W/B	Off	▶
Studio Gain	Off	▶



Item	Effect	Adjustments
Off-timer function	◀ Enable ▶ Disable	<p>Enable: Enables the “Off-timer function”.</p> <p>Disable: Disables the “Off-timer function”.</p> <p>Note: When “Disable” is set, the Off-timer is cancelled.</p>
Initial Power Mode	◀ ▶	<p>Normal ↔ Standby ↔ On</p> <p>Sets the power mode of the unit for when the power recovers from failure or after plugging off and in again.</p> <p>Normal: Power returns in as the same state as before the power interruption.</p> <p>Standby: Power returns in standby mode. (Power Indicator : red/orange)</p> <p>On: Power returns in power On. (Power Indicator : green)</p> <p>Note: When using multiple displays, “Standby” is preferred to be set in order to reduce a power load.</p>
ID select	◀ ▶	<p>Sets panel ID number when panel is used in “Remote ID” or “Serial ID”.</p> <p>Set value range: 0 - 100 (Standard value: 0)</p>
Remote ID	◀ Off ▶ On	<p>Off: Disables ID remote control functions. You can use normal remote control operations.</p> <p>On: Enable ID remote control functions.</p>
Serial ID	◀ Off ▶ On	<p>Sets the panel ID Control.</p> <p>Off: Disables external control by the ID.</p> <p>On: Enables the external control by the ID.</p>
Display size	◀ Off ▶ On	<p>Adjusts the image display size on screen.</p> <p>Off: Sets the normal image display size on screen.</p> <p>On: Sets the image display size approximately 95 % of the normal image display.</p> <div style="display: flex; justify-content: space-around; align-items: center;"> <div style="text-align: center;"> <p>Off</p>  </div> <div style="text-align: center;"> <p>On</p>  </div> </div> <p>Notes:</p> <ul style="list-style-type: none"> • This setting is valid only when the input signals are as follows; NTSC, PAL, SECAM, M.NTSC, PAL60, PAL-M, PAL-N (BNC Dual Video Terminal Board (TY-FB9BD)) 525i, 525p, 625i, 625p, 750/60p, 750/50p, 1125/60i, 1125/50i, 1125/24sF, 1125/25p, 1125/24p, 1125/30p, 1250/50i (Component Video, RGB, DVI, SDI, HDMI) • This setting is invalid when two screen display, digital zoom or Multi screen is selected. • When “Display size” is set to “On”, Pos. /Size adjustment cannot be used. • Refer to each board’s operating instruction for DVI, SDI, HDMI’s corresponding signals.
Studio W/B	◀ Off ▶ On	<p>Off: Nullify all the settings adjusted.</p> <p>On: Sets the colour temperature for TV studio.</p> <p>Note: Valid only when the low is set as colour temperature on screen adjustment.</p>
Studio Gain	◀ Off ▶ On	<p>Sharpens the contrast for a better view when a part of the image is too light to see.</p> <p>Off: Disables “Studio Gain”.</p> <p>On: Enables “Studio Gain”.</p> <p>Note: This setting is valid only when the input signals are as follows: Component Video, RGB (analog), SDI, HDMI</p>

Options		3/3
Slot power	◀ Off ▶	
V. Installation	◀ Off ▶	
Rotate	◀ Off ▶	
Serial Slot Select	◀ Slot1 ▶	

Item	Effect	Adjustments
Slot Power	◀ ▶	Off ↔ Auto ↔ On Off: Power is not transmitted to the slot power. Auto: Power is transmitted to the slot power only when main power is on. On: Power is transmitted to the slot power when main power is on or in the standby state. Note: In some cases, power is transmitted to the slot power when main power is on or in the standby state regardless of the slot power setting.
V.Installation	◀ Off ▶ On	Off: Sets fan to the horizontal installation mode. On: Sets fan to the vertical installation mode. Notes: <ul style="list-style-type: none"> • This functions when display is turned on. • Turn up the power switch for the upward direction when you set Display vertically.
Rotate	◀ Off ▶ On	Off: Does not rotate the image. On: Rotates the image 180 degrees.
Serial Slot Select	◀ ▶	Slot1 ↔ Slot2 ↔ Slot3 Selects the slot which communicates serial. Note: The setting of an external command can be set only from the fixed serial terminal (see page 10).

Normalization

When both main unit buttons and remote control are disabled due to the "Button lock", "Remocon User level" or "Remote ID" adjustments, set all the values "Off" so that all the buttons are enabled again.

Press the  button on main unit together with  button on the remote control and hold for more than 5 seconds. The "SHIPPING" menu is displayed and the lock is released when it disappears.

Weekly Command Timer (for TH-42PH10BK/S, TH-50PH10BK/S, TH-58PH10BK)

You can set 7-day timer programming by setting time and command.

Note:

Before setting Weekly Command Timer, set PRESENT TIME Setup. (see page 27)

1

Press to select Function.

Press to select "On".

Note:

- When Function is set to On, Set up TIMER (see page 28) is unavailable and Interval / Time Designation in Mode of Screensaver (see page 29) cannot be selected.

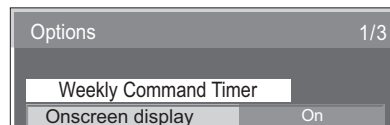

↓ Press ACTION (■) button

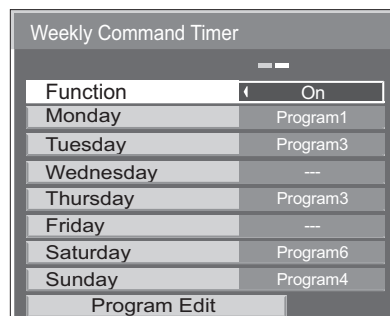

2

Press to select a day.

Press to select a program number.

Note:

- You can set the program from 1 to 7. --- indicates unset.

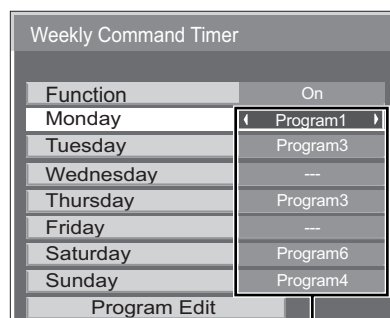

Program number

3

Press to select Program Edit.

Press to show the Program Edit screen.

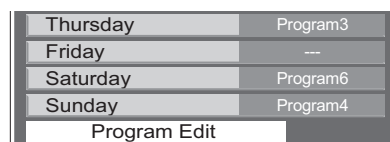

4

Press to select Program.

Press to change the program numbers (1-7).

Program Edit screen

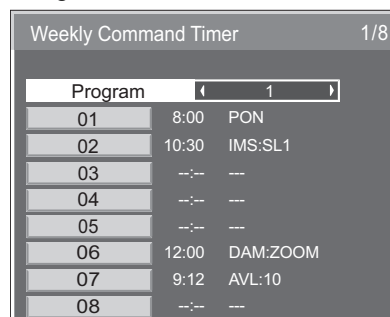

5

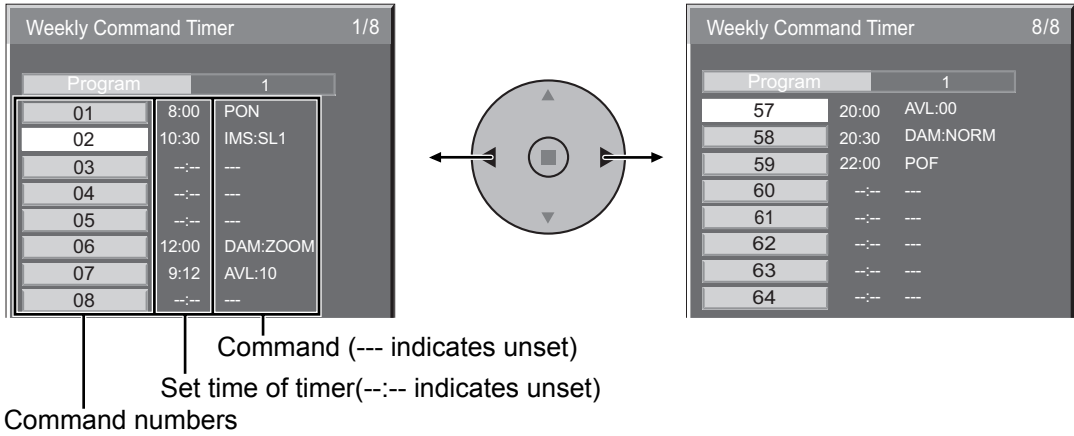
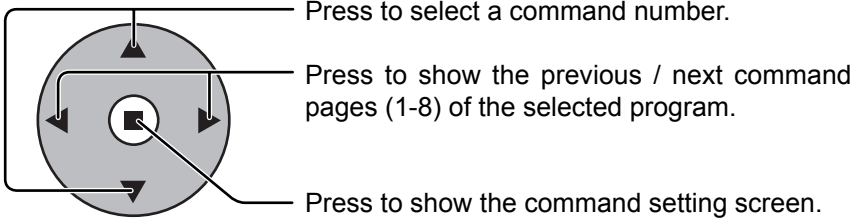

6

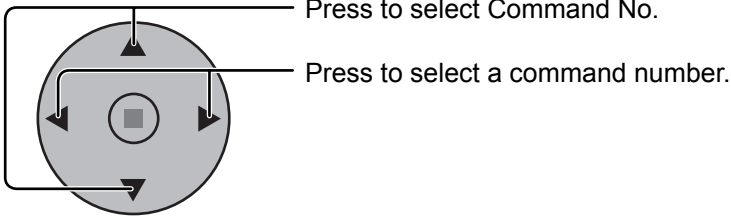

Command setting screen

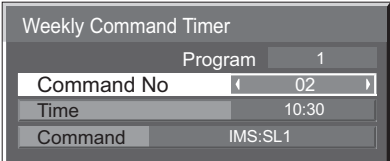

7

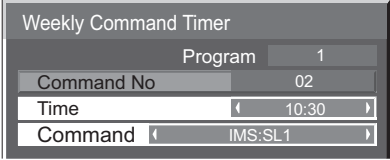
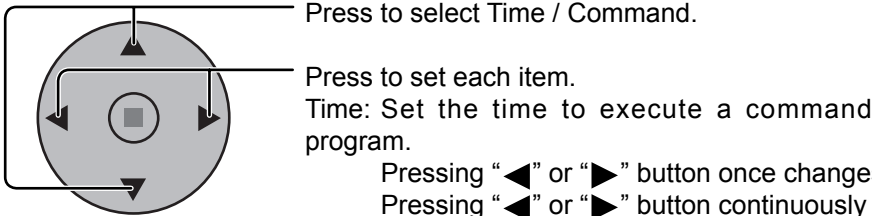

Time: Set the time to execute a command program.
 Pressing “◀” or “▶” button once changes “Time” 1 minute.
 Pressing “◀” or “▶” button continuously changes “Time” by 15 minutes.
 Command: Select a command to execute at the set time. This unit has 64 commands to set. (see page 53)

- Notes:**
- Command is performed in order of execution time, regardless of the command number.
 - If a command execution time overlaps with that of other commands, these commands are performed in number order.
 - Pressing Time becomes --:-- and Command becomes ---.

Note:
 • Press to return to the previous screen.



Shipping condition

This function allows you to reset the unit to the factory setting.

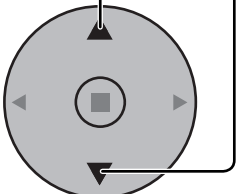
1  Press to display the Setup menu.

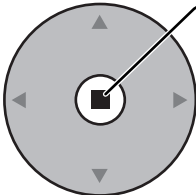
2  Press to select "OSD Language".

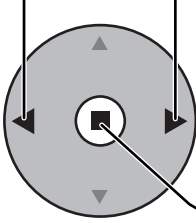
3  Press and hold till the SHIPPING menu is displayed.

4  Press to select "YES".
 Press to confirm.

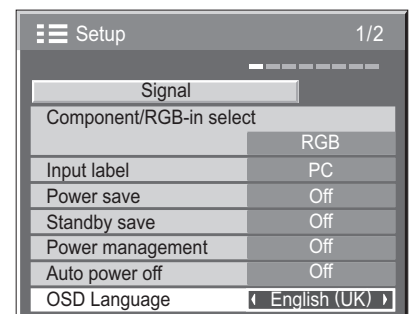
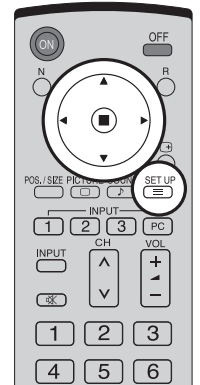

[from the unit]









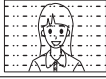

- 1 Press the MENU button till the Setup menu is displayed.
- 2 Press the Volume Up "+" or Down "-" button to select "OSD Language".
- 3 Press and hold the ENTER button till the SHIPPING menu is displayed.
- 4 Press the Volume Up "+" or Down "-" button to select "YES".
- 5 Press the ENTER button and wait for 10 sec.

Note:

Press the R button to return to Setup menu when SHIPPING menu is displayed.

Troubleshooting

Before you call for service, determine the symptoms and make a few simple checks as shown below.

Symptoms		Checks
Picture	Sound	
 Interference	 Noisy Sound	Electrical Appliances Cars / Motorcycles Fluorescent light
 Normal Picture	 No Sound	Volume (Check whether the mute function has been activated on the remote control.)
 No Picture	 No Sound	Not plugged into AC outlet Not switched on Picture and Brightness/Volume setting (Check by pressing the power switch or stand-by button on the remote control.)
 No Picture	 Normal Sound	If a signal with a non-applicable colour system format, or frequency is input, only the input terminal indication is displayed.
 No Colour	 Normal Sound	Colour controls set at minimum level (see page 22, 23) Colour system (see page 39)
No remote control operations can be performed.		Check whether the batteries have discharged completely and, if they have not, whether they were inserted properly. Check whether the remote control sensor is exposed to an outdoor light or a strong fluorescent light. Check whether the remote control designed specifically for use with the unit is being used. (The unit cannot be operated by any other remote control.)
A cracking sound is sometimes heard from the unit.		If there is nothing wrong with the picture or sound, this is the sound of the cabinet undergoing very slight contractions in response to changes in the room temperature. There are no adverse effects on the performance or other aspects.
The top or bottom of the picture on the screen is cut off when I use the zoom function.		Adjust the position of the picture on the screen.
Areas at the top and bottom of the screen where the image is missing appear when I use the zoom function.		When using a video software program (such as a cinema size program) with a screen wider than one in the 16:9 mode, blank areas separate from the images are formed at the top and bottom of the screen.
I can hear sounds coming from inside the unit.		When the power is turned on, a sound of the display panel being driven may be heard: This is normal and not indicative of malfunctioning.
This Plasma Display uses special image processing. Hence a slight time lag may occur between image and audio, depending on the type of input signal. However, this is not a malfunction.		

Plasma Display panel

Symptoms	Check
The screen darkens slightly when bright pictures with minimal movements are shown.	The screen will darken slightly when photos, still images of a computer or other pictures with minimal movements are shown for an extended period. This is done to reduce image retention on the screen and the shortening of the screen's service life: It is normal and not indicative of malfunctioning.
It takes a while for the picture to appear.	The unit digitally processes the various signals in order to reproduce esthetically pleasing images. As such, it sometimes takes a few moments for the picture to appear when the power has been turned on, when the input has been switched or when the images for the main picture and sub picture on the two screens are swapped.
The edges of the images flicker.	Due to the characteristics of the system used to drive the panel, the edges may appear to flicker in the fast-moving parts of the images: This is normal and not indicative of malfunctioning.
The brightness on both sides of images in the 4:3 mode changes.	When viewing the side panels at the "High" or "Mid" setting, the brightness on both sides may change depending on the kind of program shown: This is normal and not indicative of malfunctioning.
Some parts of the screen do not light up.	The plasma display panel is manufactured using an extremely high level of precision technology, however, sometimes some parts of the screen may be missing picture elements or have luminous spots. This is not a malfunction.
 Image retention appears	Do not allow a still picture to be displayed for an extended period, as this can cause a permanent image retention to remain on the Plasma Display. Examples of still pictures include logos, video games, computer images, teletext and images displayed in 4:3 mode. Note: The permanent image retention on the Plasma Display resulting from fixed image use is not an operating defect and as such is not covered by the Warranty. This product is not designed to display fixed images for extended periods of time.
[for TH-42PH10BK/S, TH-50PH10BK/S, TH-58PH10BK] Whirring sounds can be heard from the display unit.	The display unit is fitted with a cooling fan to dissipate heat generated during normal use. The whirring sound is caused by rotation of the fan and is not a malfunction.

VIDEO/PC input signals

VIDEO input (for TH-42PH10BK/S, TH-50PH10BK/S, TH-58PH10BK)

	Signal name	Horizontal frequency(kHz)	Vertical frequency(Hz)
1	NTSC	15.73	59.94
2	PAL	15.63	50.00
3	PAL60	15.73	59.94
4	SECAM	15.63	50.00
5	Modified NTSC	15.73	59.94

Applicable input signals for Mini D-sub 15P (Component) / Mini D-sub 15P (RGB) (* Mark)

	Signal name	Horizontal frequency (kHz)	Vertical frequency (Hz)	Dot clock frequency (MHz)	Mini D-sub 15P (Component)	Mini D-sub 15P (RGB)
1	525 (480) / 60i	15.73	59.94	13.5	*	*
2	525 (480) / 60p	31.47	59.94	27.0	*	* *1
3	625 (575) / 50i	15.63	50.00	13.5	*	*
4	625 (575) / 50p	31.25	50.00	27.0	*	*
5	750 (720) / 60p	45.00	60.00	74.25	*	*
6	750 (720) / 50p	37.50	50.00	74.25	*	*
7	1,125 (1,080) / 60i	33.75	60.00	74.25	*	*
8	1,125 (1,080) / 50i	28.13	50.00	74.25	*	*
9	1,125 (1,080) / 24sF	27.00	47.92	74.25	*	*
10	1,125 (1,080) / 30p	33.75	30.00	74.25	*	*
11	1,125 (1,080) / 25p	28.13	25.00	74.25	*	*
12	1,125 (1,080) / 24p	27.00	24.00	74.25	*	*
13	1,250 (1,080) / 50i	31.25	50.00	74.25	*	*
14	640 × 400 @70 Hz	31.46	70.07	25.17		*
15	640 × 480 @60 Hz	31.47	59.94	25.18		* *2
16	640 × 480 @72 Hz	37.86	72.81	31.5		*
17	640 × 480 @75 Hz	37.50	75.00	31.5		*
18	640 × 480 @85 Hz	43.27	85.01	36.0		*
19	852 × 480 @60 Hz	31.47	59.94	33.54		* *2
20	800 × 600 @56 Hz	35.16	56.25	36.0		*
21	800 × 600 @60 Hz	37.88	60.32	40.0		*
22	800 × 600 @72 Hz	48.08	72.19	50.0		*
23	800 × 600 @75 Hz	46.88	75.00	49.5		*
24	800 × 600 @85 Hz	53.67	85.06	56.25		*
25	1,024 × 768 @60 Hz	48.36	60.00	65.0		*
26	1,024 × 768 @70 Hz	56.48	70.07	75.0		*
27	1,024 × 768 @75 Hz	60.02	75.03	78.75		*
28	1,024 × 768 @85 Hz	68.68	85.00	94.5		*
29	1,152 × 864 @75 Hz	67.50	75.00	108.0		*
30	1,280 × 960 @60 Hz	60.00	60.00	108.0		*
31	1,280 × 960 @85 Hz	85.94	85.00	148.5		*
32	1,280 × 1,024 @60 Hz	63.98	60.02	108.0		*
33	1,280 × 1,024 @75 Hz	79.98	75.03	135.0		*
34	1,280 × 1,024 @85 Hz	91.15	85.02	157.5		*
35	1,600 × 1,200 @60 Hz	75.00	60.00	162.0		*
36	1,600 × 1,200 @65 Hz	81.25	65.00	175.5		*
37	1,066 × 600 @60 Hz	37.64	59.94	53.0		*
38	1,366 × 768 @60 Hz	48.36	60.00	86.71		*
39	Macintosh13" (640 × 480)	35.00	66.67	30.24		*
40	Macintosh16" (832 × 624)	49.72	74.54	57.28		*
41	Macintosh21" (1,152 × 870)	68.68	75.06	100.0		*

*1: When selected the RGB format and 525p signal input to the Mini D-sub 15P terminal, it is recognized as VGA 60Hz signal.

*2: When inputted VGA 60Hz format signal from the other than Mini D-sub 15P terminal, it is recognized as 525p signal.

Note: Signals without above specification may not be displayed properly.

Command list of Weekly Command Timer

No.	Command	Control details
1	AAC:MENCLR	Audio Menu (Clear)
2	AAC:MENDYN	Audio Menu (Dynamic)
3	AAC:MENSTD	Audio Menu (Standard)
4	AAC:SURMON	Surround (ON)
5	AAC:SUROFF	Surround (OFF)
6	AMT:0	Audio Mute (OFF)
7	AMT:1	Audio Mute (ON)
8	ASO:M	Audio out when PIP mode (Main Picture)
9	ASO:S	Audio out when PIP mode (Sub Picture)
10	AVL:00	Audio Volume (00)
11	AVL:10	Audio Volume (10)
12	AVL:20	Audio Volume (20)
13	AVL:30	Audio Volume (30)
14	AVL:40	Audio Volume (40)
15	AVL:50	Audio Volume (50)
16	AVL:60	Audio Volume (60)
17	DAM:FULL	Aspect (16:9)
18	DAM:JUST	Aspect (Just)
19	DAM:NORM	Aspect (4:3)
20	DAM:SELF	Aspect (Panasonic Auto)
21	DAM:ZOOM	Aspect (Zoom)
22	DWA:OFF	Advanced PIP mode (OFF)
23	DWA:OVL1	Advanced PIP mode (1) (see page 21)
24	DWA:OVL2	Advanced PIP mode (2) (see page 21)
25	DWA:OVL3	Advanced PIP mode (3) (see page 21)
26	DWA:OVL4	Advanced PIP mode (4) (see page 21)
27	DWA:OVL5	Advanced PIP mode (5) (see page 21)
28	DWA:OVL6	Advanced PIP mode (6) (see page 21)
29	DWA:OVLOF	Advanced PIP mode (OFF) (normal two screen display mode)
30	DWA:OVLON	Advanced PIP mode (ON)
31	DWA:PIN0	The location of the sub picture (lower right)
32	DWA:PIN1	The location of the sub picture (lower left)
33	DWA:PIN2	The location of the sub picture (upper left)
34	DWA:PIN3	The location of the sub picture (upper right)
35	DWA:PIP	Dual Picture mode (Picture in Picture)
36	DWA:POP	Dual Picture mode (Picture out Picture)
37	DWA:SWP	Swap main picture and sub picture when PIP mode
38	DWA:TNW	Dual Picture mode (Picture and Picture)
39	IMS:PC1	Input select (PC1) (Main Picture when PIP mode)
40	IMS:SL1	Input select (SLOT1) (Main Picture when PIP mode)
41	IMS:SL1A	Input select (SLOT1A) (Main Picture when PIP mode)
42	IMS:SL1B	Input select (SLOT1B) (Main Picture when PIP mode)
43	IMS:SL2	Input select (SLOT2) (Main Picture when PIP mode)
44	IMS:SL2A	Input select (SLOT2A) (Main Picture when PIP mode)
45	IMS:SL2B	Input select (SLOT2B) (Main Picture when PIP mode)
46	IMS:SL3	Input select (SLOT3) (Main Picture when PIP mode)
47	ISS:PC1	Sub Picture Input Select (PC1)
48	ISS:SL1	Sub Picture Input Select (SLOT1)
49	ISS:SL1A	Sub Picture Input Select (SLOT1A)
50	ISS:SL1B	Sub Picture Input Select (SLOT1B)
51	ISS:SL2	Sub Picture Input Select (SLOT2)
52	ISS:SL2A	Sub Picture Input Select (SLOT2A)
53	ISS:SL2B	Sub Picture Input Select (SLOT2B)
54	ISS:SL3	Sub Picture Input Select (SLOT3)
55	OSP:SCR0	Screen Saver White bar scroll (OFF)
56	OSP:SCR1	Screen Saver White bar scroll (ON)
57	POF	Power OFF
58	PON	Power ON
59	SSC:FNC0	Screen Saver function (White bar scroll)
60	SSC:FNC1	Screen Saver function (Image Reversal)
61	SSC:MOD0	ScreenSaver (Mode (OFF))
62	SSC:MOD3	ScreenSaver (Mode (ON))
63	VMT:0*	Picture Mute (OFF)
64	VMT:1*	Picture Mute (ON)

* Picture Mute cannot be unlocked by powering off/on with the remote control. Turn off and on again with the button on the unit or enter the command VMT:0 to unlock Picture Mute.

Specifications

		TH-42PS10BK/S	
Power Source		220 - 240 V AC, 50/60 Hz	
Power Consumption			
	Power on	280 W	
	Stand-by condition	Save off 0.8 W, Save on 0.6 W	
	Power off condition	0.2 W	
Plasma Display panel		Drive method : AC type 42-inch, 16:9 aspect ratio	
Screen size		920 mm (W) × 518 mm (H) × 1,056 mm (diagonal)	
	(No. of pixels)	408,960 (852 (W) × 480 (H)) [2,556 × 480 dots]	
Operating condition			
	Temperature	0 °C - 40 °C	
	Humidity	20 % - 80 %	
Applicable signals			
	Scanning format	525 (480) / 60i · 60p, 625 (575) / 50i · 50p, 750 (720) / 60p · 50p, 1125 (1080) / 60i · 50i · 24p · 25p · 30p · 24sF ... SMPTE274M, 1250 (1080) / 50i	
	PC signals	VGA SVGA, XGA, SXGA, UXGA ... (compressed) Horizontal scanning frequency 15 - 110 kHz Vertical scanning frequency 48 - 120 Hz	
Connection terminals			
	PC IN	(HIGH-DENSITY MINI D-SUB 15PIN)	Y or G with/sync 1.0 Vp-p (75 Ω) Y or G without/sync 0.7 Vp-p (75 Ω) B/P _B /C _B : 0.7 Vp-p (75 Ω) R/P _R /C _R : 0.7 Vp-p (75 Ω) HD/VD: 1.0 - 5.0 Vp-p (high impedance) with/picture 1.0 Vp-p (high impedance) without/picture 0.3 Vp-p (high impedance)
		VBS (use HD port)	0.5 Vrms (high impedance)
		AUDIO IN (M3 JACK)	
	SERIAL	EXTERNAL CONTROL TERMINAL (D-SUB 9PIN)	RS-232C COMPATIBLE
	SPEAKERS (6 Ω)	16 W [8 W + 8 W] (10 % THD)	
Accessories Supplied			
	Remote Control Transmitter	EUR7636090R	
	Batteries	2 × R6 Size	
	Fixing bands	TMME203 × 2	
Dimensions (W × H × D)		1,020 mm × 610 mm × 89 mm	
Mass (weight)			
	main unit only	approx. 26.0 kg net	
	with speakers	approx. 30.0kg	

Notes:

- Design and specifications are subject to change without notice. Mass and dimensions shown are approximate.
- This equipment complies with the EMC standards listed below.
EN55022, EN55024, EN61000-3-2, EN61000-3-3.

Specifications

	TH-42PH10BK/S	TH-50PH10BK/S	TH-58PH10BK
Power Source	220 - 240 V AC, 50/60 Hz		
Power Consumption			
Power on	365 W	485 W	630 W
Stand-by condition	Save off 1.0 W, Save on 0.8 W	Save off 0.8 W, Save on 0.6 W	Save off 0.8 W, Save on 0.6 W
Power off condition	0.5 W	0.3 W	0.3 W
Plasma Display panel	Drive method : AC type 42-inch, 16:9 aspect ratio	Drive method : AC type 50-inch, 16:9 aspect ratio	Drive method : AC type 58-inch, 16:9 aspect ratio
Screen size	922 mm (W) × 518 mm (H) × 1,057 mm (diagonal)	1,106 mm (W) × 622 mm (H) × 1,269 mm (diagonal)	1,287 mm (W) × 723 mm (H) × 1,476 mm (diagonal)
(No. of pixels)	786,432 (1,024 (W) × 768 (H)) [3,072 × 768 dots]	1,049,088 (1,366 (W) × 768 (H)) [4,098 × 768 dots]	1,049,088 (1,366 (W) × 768 (H)) [4,098 × 768 dots]
Operating condition			
Temperature	0 °C - 40 °C		
Humidity	20 % - 80 %		
Applicable signals			
Colour System	NTSC, PAL, PAL60, SECAM, Modified NTSC		
Scanning format	525 (480) / 60i · 60p, 625 (575) / 50i · 50p, 750 (720) / 60p · 50p, 1125 (1080) / 60i · 50i · 24p · 25p · 30p · 24sF ··· SMPTE274M, 1250 (1080) / 50i		
PC signals	VGA, SVGA, XGA SXGA, UXGA ··· (compressed) Horizontal scanning frequency 15 - 110 kHz Vertical scanning frequency 48 - 120 Hz		
Connection terminals			
AV IN	VIDEO IN (BNC) S VIDEO IN (MINI DIN 4PIN) AUDIO IN (RCA PIN JACK × 4)	1.0 Vp-p (75 Ω) Y: 1.0 Vp-p (75 Ω), C: 0.286 Vp-p (75 Ω) 0.5 Vrms (high impedance)	
PC IN	(HIGH-DENSITY MINI D-SUB 15PIN) VBS (use HD port) AUDIO IN (M3 JACK)	Y or G with/sync 1.0 Vp-p (75 Ω) Y or G without/sync 0.7 Vp-p (75 Ω) B/Pb/Cb: 0.7 Vp-p (75 Ω) R/Pr/CR: 0.7 Vp-p (75 Ω) HD/VD: 1.0 - 5.0 Vp-p (high impedance) with/picture 1.0 Vp-p (high impedance) without/picture 0.3 Vp-p (high impedance) 0.5 Vrms (high impedance)	
SERIAL	EXTERNAL CONTROL TERMINAL (D-SUB 9PIN)	RS-232C COMPATIBLE	
SPEAKERS (6 Ω)	16 W [8 W + 8 W] (10 % THD)		
Accessories Supplied			
Remote Control Transmitter	EUR7636090R		
Batteries	2 × R6 Size		
Fixing bands	TMME203 × 2		
Dimensions (W × H × D)	1,020 mm × 610 mm × 89 mm	1,210 mm × 724 mm × 95 mm	1,399 mm × 843 mm × 99 mm
Mass (weight)			
main unit only	approx. 26.0 kg net	approx. 36.0 kg net	approx. 54.0 kg net
with speakers	approx. 30.0 kg	approx. 40.0 kg	approx. 59.0 kg

Notes:

- Design and specifications are subject to change without notice. Mass and dimensions shown are approximate.
- This equipment complies with the EMC standards listed below.
EN55022, EN55024, EN61000-3-2, EN61000-3-3.

Panasonic

Sales and Support Information

Customer Care Centre

- For customers within the UK : **0844 844 3852**
- For customers within the Republic of Ireland: **01 289 8333**
- Visit our website for product information
www.panasonic.co.uk
- E-mail: customer.care@panasonic.co.uk

Direct Sales at Panasonic UK

- Order accessory and consumable items for your product with ease and confidence by phoning our Customer Care Centre Monday – Thursday 9:00am – 5:30pm, Friday 9:30am – 5:30pm (Excluding public holidays).
- Or go on line through our Internet Accessory ordering application at www.panasonic.co.uk.
- Most major credit and debit cards accepted.
- All enquiries transactions and distribution facilities are provided directly by Panasonic UK Ltd.
- It couldn't be simpler!
- Also available through our Internet is direct shopping for a wide range of finished products, take a browse on our website for further details.

Exclusive to Plasma / DVD Ram / LCD Television / LCD Projector product:

Interested in purchasing an extended guarantee? Please contact your dealer or our Customer Support Department on 01344 476540 or customer.care@panasonic.co.uk for more details.

Information on Disposal for Users of Waste Electrical & Electronic Equipment (private households)



This symbol on the products and/or accompanying documents means that used electrical and electronic products should not be mixed with general household waste. For proper treatment, recovery and recycling, please take these products to designated collection points, where they will be accepted on a free of charge basis. Alternatively, in some countries you may be able to return your products to your local retailer upon the purchase of an equivalent new product. Disposing of this product correctly will help to save valuable resources and prevent any potential negative effects on human health and the environment which could otherwise arise from inappropriate waste handling. Please contact your local authority for further details of your nearest designated collection point.

Penalties may be applicable for incorrect disposal of this waste, in accordance with national legislation.

For business users in the European Union

If you wish to discard electrical and electronic equipment, please contact your dealer or supplier for further information.

Information on Disposal in other Countries outside the European Union

This symbol is only valid in the European Union.

If you wish to discard this product, please contact your local authorities or dealer and ask for the correct method of disposal.

Customer's Record

The model number and serial number of this product can be found on its back cover. You should note this serial number in the space provided below and retain this book, plus your purchase receipt, as a permanent record of your purchase to aid in identification in the event of theft or loss, and for Warranty Service purposes.

Model Number _____

Serial Number _____

Matsushita Electric Industrial Co., Ltd.

Web Site : <http://panasonic.net>

© 2007 Matsushita Electric Industrial Co., Ltd. All Rights Reserved.

Printed in Czech Republic
MBS0307S1047