

# Panasonic®

## Basic Operating Instructions

Digital Camera

Model No. **DMC-FZ330**



# LUMIX

Please read these instructions carefully before using this product, and save this manual for future use.

More detailed instructions on the operation of this camera are contained in "Operating Instructions for advanced features (PDF format)" in the supplied disc.



Web Site: <http://www.panasonic.com>

Model number suffix "EB" denotes UK model.

**EB**

SQT0962-2  
M0715KZ2082

## Dear Customer,

We would like to take this opportunity to thank you for purchasing this Panasonic Digital Camera. Please read these Operating Instructions carefully and keep them handy for future reference. Please note that the actual controls and components, menu items, etc. of your Digital Camera may look somewhat different from those shown in the illustrations in these Operating Instructions.

### Carefully observe copyright laws.

- Recording of pre-recorded tapes or discs or other published or broadcast material for purposes other than your own private use may infringe copyright laws. Even for the purpose of private use, recording of certain material may be restricted.

## Information for Your Safety

### WARNING:

To reduce the risk of fire, electric shock or product damage,

- Do not expose this unit to rain, moisture, dripping or splashing.
- Use only the recommended accessories.
- Do not remove covers.
- Do not repair this unit by yourself. Refer servicing to qualified service personnel.

The socket outlet shall be installed near the equipment and shall be easily accessible.

### ■ Product identification marking

Product	Location
Digital camera	Bottom
Battery charger	Bottom

### ■ About the battery charger

#### CAUTION!

To reduce the risk of fire, electric shock or product damage,

- Do not install or place this unit in a bookcase, built-in cabinet or in another confined space. Ensure this unit is well ventilated.

- The battery charger is in the standby condition when the AC power supply cord is connected. The primary circuit is always "live" as long as the power cord is connected to an electrical outlet.

## ■ About the battery pack

### CAUTION

- Danger of explosion if battery is incorrectly replaced. Replace only with the type recommended by the manufacturer.
  - When disposing of the batteries, please contact your local authorities or dealer and ask for the correct method of disposal.
- 
- Do not heat or expose to flame.
  - Do not leave the battery(ies) in a car exposed to direct sunlight for a long period of time with doors and windows closed.
  - Do not expose to low air pressure at high altitudes.
  - Do not expose to extremely low air pressure, as this may result in explosions or leakage of flammable liquids and gases.

### Warning

Risk of fire, explosion and burns. Do not disassemble, heat above 60 °C or incinerate.

## ■ Cautions for Use

- Do not use any other USB connection cables except the supplied one or a genuine Panasonic USB connection cable (DMW-USBC1: optional).
- Always use a genuine Panasonic AV cable (DMW-AVC1: optional).
- Use a "High Speed HDMI micro cable" with the HDMI logo. Cables that do not comply with the HDMI standards will not work.  
"High Speed HDMI micro cable" (Type D-Type A plug, up to 2 m (6.6 feet) long)
- Always use a genuine Panasonic shutter remote control (DMW-RSL1: optional).

### **Keep this unit as far away as possible from electromagnetic equipment (such as microwave ovens, TVs, video games etc.).**

- If you use this unit on top of or near a TV, the pictures and/or sound on this unit may be disrupted by electromagnetic wave radiation.
- Do not use this unit near cell phones because doing so may result in noise adversely affecting the pictures and/or sound.
- Recorded data may be damaged, or pictures may be distorted, by strong magnetic fields created by speakers or large motors.
- Electromagnetic wave radiation may adversely affect this unit, disturbing the pictures and/or sound.
- If this unit is adversely affected by electromagnetic equipment and stops functioning properly, turn this unit off and remove the battery or disconnect AC adaptor (DMW-AC10E: optional). Then reinsert the battery or reconnect AC adaptor and turn this unit on.

### **Do not use this unit near radio transmitters or high-voltage lines.**

- If you record near radio transmitters or high-voltage lines, the recorded pictures and/or sound may be adversely affected.

**Declaration of Conformity (DoC) for EU:**

Hereby, "Panasonic Entertainment & Communication Co., Ltd." declares that this product is in compliance with the essential requirements and other relevant provisions of Directive 2014/53/EU. Customers can download a copy of the original DoC for our RE products from our DoC server: <https://www.ptc.panasonic.eu/compliance-documents>  
Importer for EU: Panasonic Marketing Europe GmbH  
Authorized Representative in EU: Panasonic Testing Centre, Winsbergring 15, 22525 Hamburg, Germany

**Declaration of Conformity (DoC) for UK:**

Hereby, "Panasonic Entertainment & Communication Co., Ltd." declares that this product is in compliance with the essential requirements and other relevant provisions of the Radio Equipment Regulations 2017.  
Customers can download a copy of the original DoC for our RE products from our DoC server: <https://www.ptc.panasonic.eu/compliance-documents>  
Importer for UK: Panasonic UK, a branch of Panasonic Marketing Europe GmbH Maxis 2, Western Road, Bracknell, Berkshire, RG12 1RT

**Wireless transmitter:**

Frequency range used: 2412 MHz to 2462 MHz (Central frequency)

Max. output power: 13 dBm (EIRP)

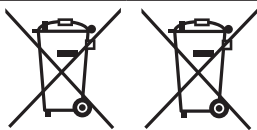

These symbols indicate separate collection of waste electrical and electronic equipment or waste batteries. More detailed information is contained in "Operating Instructions for advanced features (PDF format)".



## Caution for AC Mains Lead

For your safety, please read the following text carefully.

This appliance is supplied with a moulded three pin mains plug for your safety and convenience.

A 5-ampere fuse is fitted in this plug.

Should the fuse need to be replaced please ensure that the replacement fuse has a rating of 5-ampere and that it is approved by ASTA or BSI to BS1362.

Check for the ASTA mark  or the BSI mark  on the body of the fuse.

If the plug contains a removable fuse cover you must ensure that it is refitted when the fuse is replaced.

If you lose the fuse cover the plug must not be used until a replacement cover is obtained.

A replacement fuse cover can be purchased from your local dealer.

### ■ Before use

Remove the connector cover.

### ■ How to replace the fuse

The location of the fuse differ according to the type of AC mains plug (figures A and B).

Confirm the AC mains plug fitted and follow the instructions below.

Illustrations may differ from actual AC mains plug.

1. Open the fuse cover with a screwdriver.

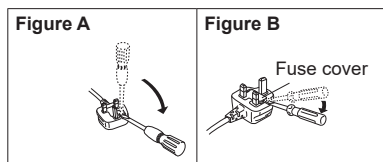

2. Replace the fuse and close or attach the fuse cover.

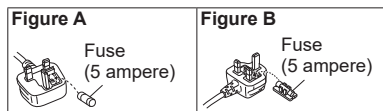

# Contents

■ Information for Your Safety .....	2
-------------------------------------	---

## Preparations

■ Before use .....	8
■ Standard accessories .....	9
■ Names and Functions of Main Parts .....	10
■ Preparations .....	12
Attaching the Lens Hood .....	12
Attaching the Lens Cap .....	13
Attaching the Shoulder Strap .....	13
Charging the battery .....	14
Inserting and removing the battery/ the card (optional) .....	15
Formatting the card (initialisation) .....	16
Opening the Monitor .....	17
Setting the clock .....	17

## Basics

■ Zoom lever/Side lever (Use zoom) ...	18
■ Shutter button (Taking pictures) .....	18
■ Mode dial (Select the recording mode) .....	19
■ Focus mode lever .....	19
■ Side dial / Rear dial .....	20
■ Side button .....	21
■ [LVF] button (Switching between the monitor and viewfinder) .....	22
■ Touch screen (Touch operations) ....	22
■ Setting the menu .....	23
■ Calling frequently-used menus instantly (Quick Menu) .....	24
■ Assigning frequently used functions to the buttons (Function buttons) .....	24

## Recording

■ Taking pictures with automatic settings (Intelligent Auto Mode) .....	25
Switching between Intelligent Auto Plus Mode and Intelligent Auto Mode .....	25
Taking pictures using a handheld camera ([iHandheld Night Shot]) .....	25
Combining pictures into a single still picture with rich gradation ([iHDR]) .....	26
Defocusing the background (Defocus control function) .....	26
Recording images by changing the brightness (exposure) or colour tone .....	26
■ Recording motion pictures by setting the aperture value/shutter speed (Creative Video Mode) .....	27
■ Setting the picture quality and size .....	27
Changing the aspect ratio of the still pictures .....	27
Setting the picture size .....	28
Setting the compression rate of pictures ([Quality]) .....	28
■ Taking close-up pictures (Macro recording) .....	29
■ Taking pictures with Manual Focus .....	29
■ Selecting a Drive Mode .....	30
■ Recording 4K Photos .....	31
Selecting pictures from 4K burst file and saving .....	32
■ Correcting jitter .....	33
■ Zoom types and use .....	33
■ Recording motion pictures .....	34
Recording 4K motion pictures .....	35

## Playback

- Viewing your pictures..... 36
- Viewing motion pictures ..... 37
- Deleting pictures..... 38
- Using the [Playback] menu ..... 39
  - [RAW Processing].....39

## Wi-Fi

- What you can do with the Wi-Fi® function ..... 41
- Operating the camera by connecting it to a smartphone..... 42
  - Installing the smartphone/tablet app
  - “Panasonic Image App” .....42
  - Connecting to a smartphone .....43
  - Taking pictures via a smartphone (remote recording).....44
  - Playing back pictures in the camera on a smartphone .....44
  - Saving pictures in the camera to a smartphone .....44
  - Sending pictures in the camera to social networking services .....44
  - Adding location information to pictures in the camera from a smartphone .....45
  - Combining motion pictures recorded with Snap Movie according to your preference on a smartphone .....45

## Others



- Reading the Operating Instructions (PDF format) ..... 46
- About supplied software ..... 47
  - Installing supplied software .....47
- List of monitor/viewfinder displays..... 48
- Menu list ..... 52
- Q&A Troubleshooting ..... 54
- Specifications..... 59
- Digital Camera Accessory System ... 62

---

### ■ About the symbols in the text

**MENU** Indicates that the menu can be set by pressing [MENU/SET] button.

In this Operating Instructions, steps for setting a menu item are described as follows:

**MENU** →  [Rec] → [Quality] → []

## Before use

### Care of the camera

**To avoid damaging your camera and to experience the maximum enjoyment you should exercise the following precautions.**

- The lens, monitor and the camera body can sustain damage if the camera body is dropped or subjected to excessive temperature, moisture, water or dust.
- The monitor can be damaged if excessive pressure is applied to the screen surface, during actual use or while cleaning.

#### ■ Splash Proof

Splash Proof is a term used to describe an extra level of protection this camera offers against exposure to a minimal amount of moisture, water or dust. Splash Proof does not guarantee that damage will not occur if this camera is subjected to direct contact with water.

In order to minimise the possibility of damage please be sure the following precautions are taken:

- Make sure the built-in flash is closed.
- Make sure that all doors are securely closed.
- Make sure that you are in a dry and secure place when changing the battery or memory card. After changing, make sure their protective doors are securely closed.
- If this camera is exposed to water, sand or any other foreign material clean it as soon as possible, taking the necessary precautions that the foreign substance does not get inside the camera.
- Under no circumstances should you place any foreign objects within the camera.

If sand, dust, or liquids such as water droplets adhere to the camera, wipe them off with a dry soft cloth.

- Not doing so may result in incorrect recognition of touch operations or erroneous flash display.
- If the monitor is closed when such liquids are present, malfunction may result.

#### ■ Condensation

- Condensation may occur on the lens, monitor or in the viewfinder when the room temperature or humidity changes rapidly. This may cause the image to temporarily become hazy. If this occurs, turn the camera off and allow the camera to sit so that the camera temperature can stabilise to the room's ambient temperature. The required time will vary and can take up to an hour. It will clear by itself.
- If you know that you will be moving between areas where there will be a large change in temperature or humidity, you can help prevent condensation forming on the camera by placing the camera in a large plastic zipper bag, so condensation will form on the bag, not the camera. Allow the temperature to stabilise before removing the camera from the bag.

#### ■ Caring for your camera









- To clean your camera, remove the battery, the DC coupler (DMW-DCC8: optional) or a card, or disconnect the power plug from the outlet, and wipe with a soft, dry cloth.
- Do not press the monitor with excessive force.
- Do not press the lens with excessive force.
- Do not keep rubber or plastic products in contact with the camera for a long period of time.
- Do not use benzine, thinners, alcohol, or kitchen detergent, as these may damage the outer casing and finish of the camera.
- Do not leave the camera with the lens facing the sun as rays of light from the sun may cause it to malfunction.
- Do not extend the supplied cord or cable.

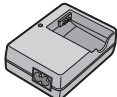

- While the camera is accessing the card (for an operation such as picture writing, reading, deletion, or formatting), do not turn off the camera or remove the battery, card, AC adaptor (DMW-AC10E: optional) or DC coupler (DMW-DCC8: optional).
- The data on the card may be damaged or lost due to electromagnetic waves, static electricity or breakdown of the camera or the card. We recommend storing important data on a PC etc.
- Do not format the card on your PC or other equipment. Format it on the camera only to ensure proper operation.

## Standard accessories

Check that all the accessories are supplied before using the camera. Part numbers are as of July 2015. These may be subject to change.

<input type="checkbox"/> <b>Battery pack</b> DMW-BLC12E • Charge the battery before use. Battery pack is indicated as battery pack or battery in the text.		<input type="checkbox"/> <b>Lens cap / Lens cap string</b> VYQ5607	
<input type="checkbox"/> <b>Battery charger</b> DE-A80A		<input type="checkbox"/> <b>Shoulder strap</b> VFC4453	
<input type="checkbox"/> <b>AC mains lead</b> K2CT3YY00034		<input type="checkbox"/> <b>USB connection cable</b> K1HY08YY0031	
<input type="checkbox"/> <b>Lens hood</b> SYQ0547		<input type="checkbox"/> <b>DVD</b> SFM0099 • Software: Use it to install the software on your PC. • Operating Instructions for advanced features	

- **Cards are optional.**
- SD Memory Card, SDHC Memory Card and SDXC Memory Card are indicated as card in the text.
- Consult the dealer or your nearest Service Centre if you lose the supplied accessories. (You can purchase the accessories separately.)
- Please dispose of all packaging appropriately.
- Keep small parts in a safe place out of the reach of children.
- The illustrations and screens in this manual may differ from the actual product.

## Names and Functions of Main Parts

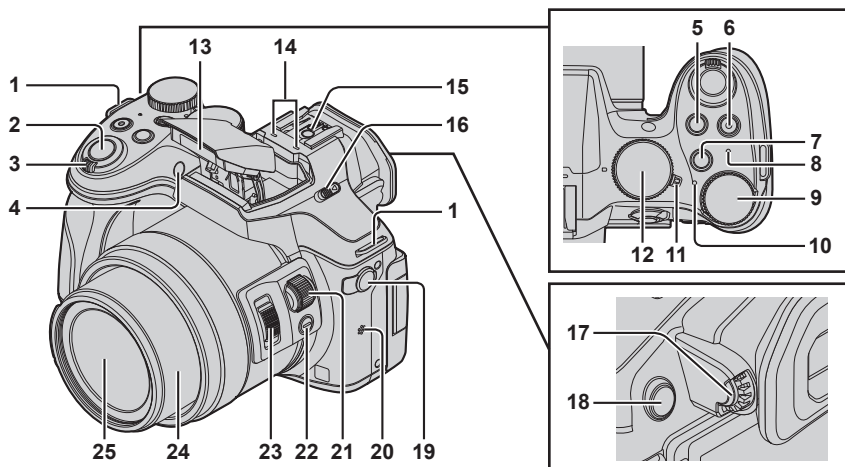

- 1** Shoulder strap eyelet (→13)
- 2** Shutter button (→18)
- 3** Zoom lever (→18)
- 4** Self-timer indicator / AF Assist Lamp
- 5** [ ] (Exposure Compensation) button / [Fn1] button (→24)
- 6** Motion picture button (→34)
- 7** [Fn2] button (→24)
- 8** Wi-Fi® connection lamp
- 9** Rear dial (→20)
- 10** Status indicator (→17)
- 11** Camera [ON/OFF] switch (→17)
- 12** Mode dial (→19)  
Use this to select the recording mode.
- 13** Flash
- 14** Stereo microphone  
Be careful not to cover the microphone with your finger. Doing so may make sound difficult to record.

- 15** Hot shoe
- 16** Flash open lever  
The flash opens, and recording with the flash becomes possible.
- 17** Diopter adjustment dial (→22)
- 18** [LVF] button (→22) / [Fn4] button (→24)
- 19** [MIC] socket  
An external microphone (optional) can record higher quality audio than the built-in microphone.
- 20** Speaker  
Be careful not to cover the speaker with your finger. Doing so may make sound difficult to hear.
- 21** Side dial (→20)
- 22** Side button (→21)
- 23** Side lever (→18)
- 24** Lens barrel
- 25** Lens

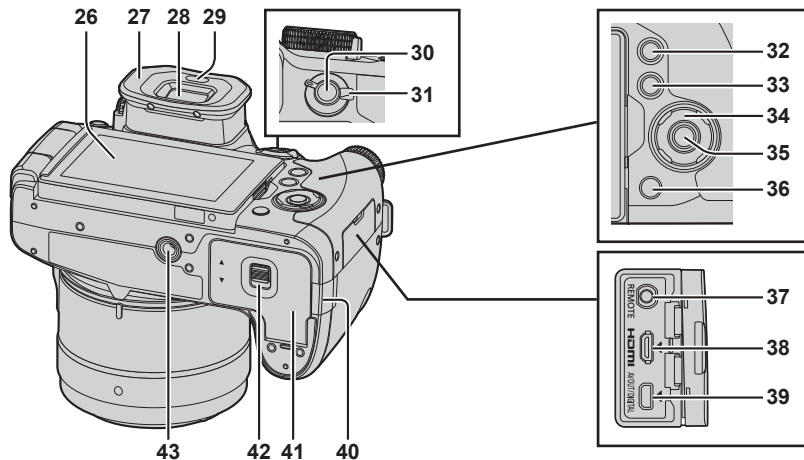

**26** Touch screen / monitor (→17, 22, 48)

**27** Eye cup

**28** Viewfinder (→22)

**29** Eye sensor (→22)

**30** [AF/AE LOCK] button

**31** Focus mode lever (→19)

**32** [▶] (Playback) button (→36)

**33** [DISP.] button  
Use this to change display.

**34** Cursor button



- Selection of items or setting of values etc., is performed.
- In this manual, the button that is to be used is indicated by ▲▼▶◀.

[ISO] (ISO sensitivity) (▲)

[WB] (White Balance) (▶)

[] (Drive Mode) (▼) (→30)

[] (AF Mode) (◀)

**35** [MENU/SET] button

**36** [Q.MENU /▶] (Delete/Cancel) button  
(→24, 38) /  
[Fn3] button (→24)

**37** [REMOTE] socket

**38** [HDMI] socket

**39** [AV OUT/DIGITAL] socket

**40** DC coupler cover (→15)

- Always use a genuine Panasonic AC adaptor (DMW-AC10E: optional).
- When using an AC adaptor, ensure that the Panasonic DC coupler (DMW-DCC8: optional) and AC adaptor (DMW-AC10E: optional) are used.
- When using an AC adaptor, use the AC mains lead supplied with the AC adaptor.

**41** Card/Battery door (→15)

**42** Release lever (→15)

**43** Tripod mount

Do not attach this unit to tripods that have screws with a length of 5.5 mm (0.22 inch) or more. Doing so may damage this unit or the unit may not be secured properly on the tripod.

# Preparations

## Attaching the Lens Hood

- Do not hold the lens hood in such a way that it will be bent.
- Make sure that the camera is turned off.
- Be sure to close the flash beforehand.



- 1** Align the mounting mark on the lens hood a little above the mounting mark on the tip of the lens

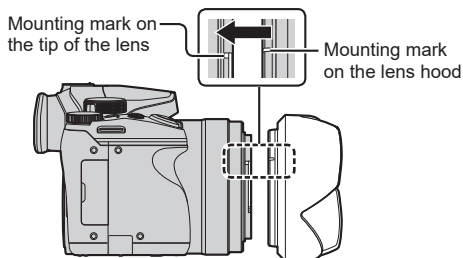

- 2** Turn the lens hood in the direction of the arrow to secure it

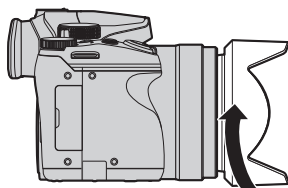

- 3** Turn the lens hood until it clicks and align the mounting mark on the lens hood with the mark at the bottom of the camera

- Make sure the lens hood is secured properly and its reflection does not fall on images.

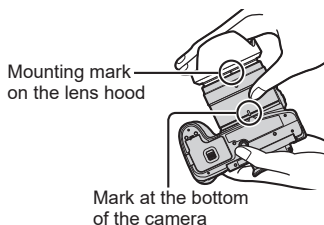

- When temporarily detaching and carrying the lens hood, we recommend attaching with the orientation reversed. Return it to the normal direction when taking pictures.
- If you attach the lens hood while using the flash, the flash light would be blocked by the lens hood causing the bottom part of images to be darkened (vignetting) and also making it impossible to modulate the light. It is recommended to remove the lens hood before using the flash.

## Attaching the Lens Cap

Cover the lens with the lens cap to protect it when you are not taking pictures.

- Do not hang or swing around the camera with the lens cap string.
- Make sure to detach the lens cap when turning this unit on.
- Be careful that the lens cap string does not become entangled with the shoulder strap.

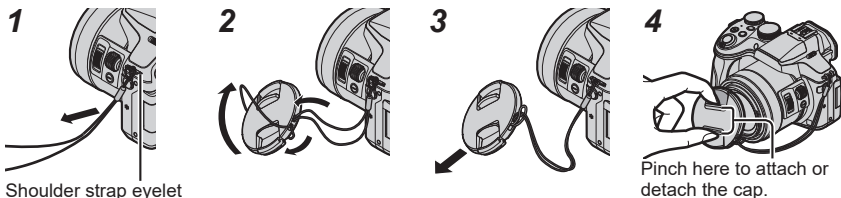

- 1** Pass the string through the hole on the camera
- 2** Pass the string through the lens cap, and then pass the lens cap through the loop formed by the string
- 3** Fasten the string
- 4** Attach the lens cap

## Attaching the Shoulder Strap

We recommend attaching the shoulder strap when using the camera to prevent it from dropping.

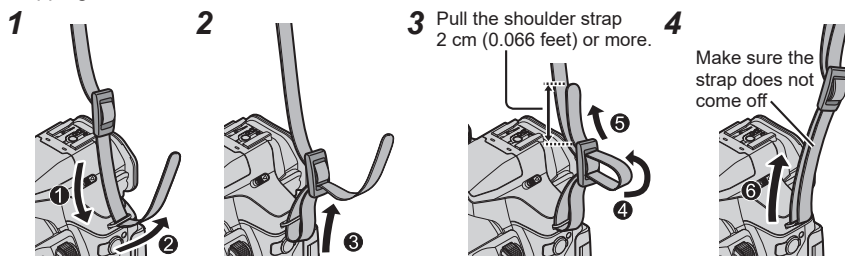

- Perform steps **1** to **4** and then attach the other side of the shoulder strap.
- Use the shoulder strap around your shoulder.
  - Do not wrap the strap around your neck. It may result in injury or accident.
- Do not leave the shoulder strap where an infant can reach it.
  - It may result in an accident by mistakenly wrapping around the neck.

## Charging the battery

The battery that can be used with this unit is DMW-BLC12E.

The battery is not charged when the camera is shipped. Charge the battery before use.

- Use the dedicated charger and battery.

### 1 Attach the battery paying attention to the direction of the battery

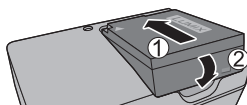

### 2 Connect the charger to the electrical outlet

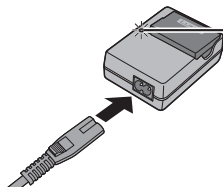

- The AC mains lead does not fit entirely into the AC input terminal. A gap will remain.



#### Charging light ([CHARGE])

**On:** Charging in progress

**Off:** Charging complete

#### If light is flashing:

- Battery temperature is too high or too low. We recommend charging in a location where the ambient temperature is between 10 °C and 30 °C (50 °F to 86 °F).
- Battery/charger connector is dirty. Clean with a dry cloth.

- Charge the battery with the charger indoors.

### 3 Detach the battery after charging is completed

#### ■ Notes on charging time

Charging time	Approx. 140 min
<p>• The charging time indicated above is the time required for charging in case when the battery is completely used up. The time required for charging differs depending on conditions of battery usage. Charging takes longer in cases when temperatures are either high or low and when the battery has not been used for a long period of time.</p>	

## Inserting and removing the battery/the card (optional)

- Always use genuine Panasonic batteries (DMW-BLC12E).
- If you use other batteries, we cannot guarantee the quality of this product.
- Make sure that the camera is turned off.

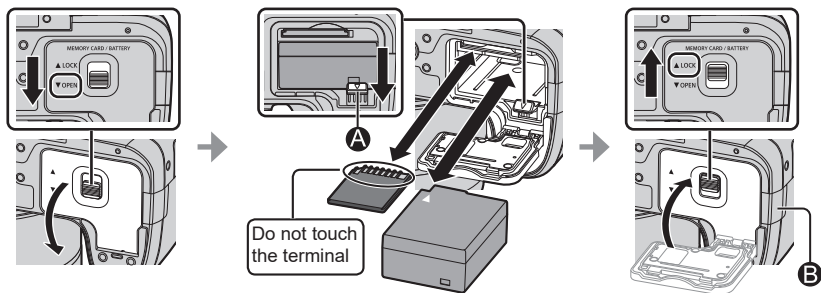

### ● Battery:

Insert the battery all the way firmly until a locking sound is heard, and check that the lever **(A)** is hooked over the battery.

Move the lever **(A)** in the direction of the arrow to remove the battery.

### ● Card:

Insert the card all the way firmly until it clicks.

To remove the card, push the centre of the card until it clicks, then pull the card out upright.

### ● DC coupler cover **(B)**:

Make sure the DC coupler cover is securely closed, and then close the card/battery door.

### ■ About the Card

The following SD standard-based cards (Panasonic brand recommended) can be used.





Type of Card	Capacity	Notes
SD Memory Cards	512 MB – 2 GB	• Operation of the cards on the left has been confirmed with Panasonic's cards.
SDHC Memory Cards	4 GB – 32 GB	• Can be used with devices compatible with the respective formats.
SDXC Memory Cards	48 GB – 128 GB	• <b>This unit is compatible with UHS-I UHS Speed Class 3 standard SDHC/SDXC memory cards.</b>

- Keep the Memory Card out of reach of children to prevent swallowing.

### ■ About motion picture/4K photo recording and speed class ratings

According to the [Rec Format] (→35) and [Rec Quality] (→35) of a motion picture, the required card differs. To record 4K photos, you need a card with a speed class rating that supports 4K photo recording. Use a card that meets the following ratings of the SD Speed Class or UHS Speed Class.

- SD Speed Class and UHS Speed Class are the speed standards regarding continuous writing. Confirm the SD speed by checking the card label or other card related materials.

[Rec Format]	[Rec Quality]	Speed class	Label example
[AVCHD]	All	Class 4 or higher	CLASS  
[MP4]	[FHD]/[HD]/[VGA]		
[MP4]	[4K]/[High Speed Video]	UHS Speed Class 3	
When recording 4K photos		UHS Speed Class 3	

- Latest information:  
<http://panasonic.jp/support/global/cs/dsc/>  
 (This site is available in English only.)

### Formatting the card (initialisation)

Format the card before recording a picture with this unit. **Since data cannot be recovered after formatting, make sure to back up necessary data in advance.**

#### 1 Set the menu (→23)

**MENU** →  **[Setup]** → **[Format]**

- A confirmation screen is displayed. If you select [Yes], the operation is executed.



## Opening the Monitor

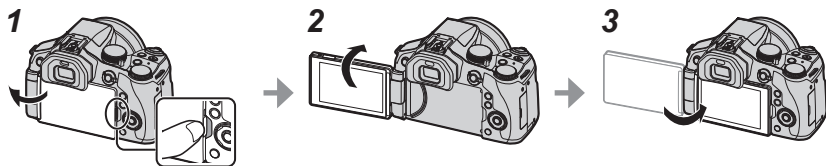

- 1** Place your finger in the cleft on the right side of the monitor and open the monitor toward the left side (maximum 180°)
- 2** It can be rotated 180° to the direction of the lens
- 3** Return the monitor to its original position

- Only rotate the monitor after opening it wide enough, and be careful not to use excessive force. Doing so may cause damage to this unit.
- When not using the monitor it is recommended that you close it with the screen facing inward to prevent dirt and scratches.

## Setting the clock

The clock is not set when the camera is shipped.

- 1** Turn the camera on
  - The status indicator lights up when you turn this unit on.
- 2** Press [MENU/SET]
- 3** Press ◀▶ to select the items (year, month, day, hour, minute), and press ▲▼ to set
- 4** Press [MENU/SET]
- 5** When [The clock setting has been completed.] is displayed, press [MENU/SET]
- 6** When [Please set the home area] is displayed, press [MENU/SET]
- 7** Press ◀▶ to set your home area and press [MENU/SET]

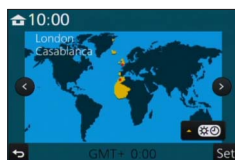
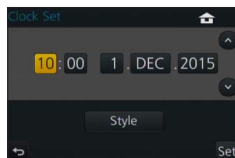
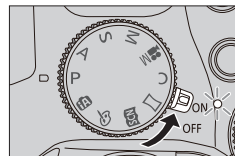

## Zoom lever/Side lever (Use zoom)

You can adjust the area of a picture to be taken using the zoom or side lever.

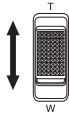
Zoom lever	Side lever
<b>Move the zoom lever</b> 	<b>Slide the side lever</b> 
T side: Telephoto, Enlarge the subject W side: Wide-angle, Capture a wider area	
Turning angle is large: Zoom speed is high Turning angle is small: Zoom speed is low	Slide width is large: Zoom speed is high Slide width is small: Zoom speed is low

- Do not touch the lens barrel during zooming.
- For details about zoom types and use, refer to (→33).

## Shutter button (Taking pictures)

- Press the [ ] button (▼) to set the drive mode to [ ] ([Single]).

### 1 Press the shutter button halfway (press lightly) to focus on the subject

- The aperture value and shutter speed are displayed. (If the aperture value and shutter speed are shown in red and flashing, you do not have the appropriate exposure, unless you are using the flash.)



**Focus display**  
 (When focus is aligned: illuminated  
 When focus is not aligned: flashing)

**Shutter speed**  
**Aperture value**

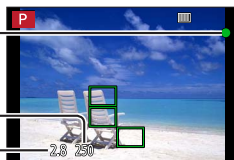

### 2 Press the shutter button fully (push the button all the way), and take the picture



- Pictures can be taken only when the image is correctly focused as long as the [Focus/Release Priority] is set to [FOCUS].
- Even during menu operation or picture playback, if you press the shutter button halfway, you can instantly set the camera ready for recording.

## Mode dial (Select the recording mode)

### 1 Set to the desired recording mode

- Rotate the mode dial slowly to select the desired mode.

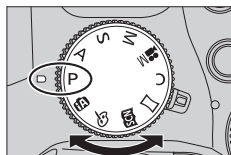

<b>iA</b>	<b>Intelligent Auto Mode (→25)</b> Take pictures with automatic settings.
<b>IA+</b>	<b>Intelligent Auto Plus Mode (→25)</b> Allows you to adjust the brightness (exposure) and colour hue as desired.
<b>P</b>	<b>Programme AE Mode</b> Take pictures with automatic shutter speed and aperture value settings.
<b>A</b>	<b>Aperture-Priority AE Mode</b> Determine aperture, then record pictures.
<b>S</b>	<b>Shutter-Priority AE Mode</b> Determine shutter speed, then record pictures.
<b>M</b>	<b>Manual Exposure Mode</b> Determine aperture and shutter speed, then record pictures.
<b>M</b>	<b>Creative Video Mode (→27)</b> Determine aperture and shutter speed, then record motion pictures. • You cannot take still pictures.
<b>C</b>	<b>Custom Mode</b> Record pictures using pre-registered settings.
<b>SCN</b>	<b>Panorama Shot Mode</b> Record panorama pictures.
<b>SCN</b>	<b>Scene Guide Mode</b> Take pictures using Scene modes.
<b>CC</b>	<b>Creative Control Mode</b> Take pictures by selecting your preferred picture effect.

## Focus mode lever

Set the focusing operation to be performed when the shutter button is pressed halfway.

<b>[AFS/AFF]</b>	Auto Focus. Focus is set automatically when the shutter button is pressed halfway. [AFS]: Focus will be fixed while it is pressed halfway. [AFF]: If the subject moves while the shutter button is pressed halfway, the focus is corrected to match the movement automatically.
<b>[AFC]</b>	Auto Focus. While the shutter button is pressed halfway, focusing is constantly performed to match the movement of the subject.
<b>[MF]</b>	Manual Focus. (→29)

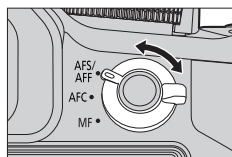

## Side dial / Rear dial

Rotate the side dial to adjust focus, and rotate the rear dial to set the aperture value and shutter speed. You can also select items and set numeric values.

- This operating instructions describes operations of the dials as follows:

Rotating the side dial: 

Rotating the rear dial: 

### Side dial

You can adjust focus in the following cases:

- In Manual Focus
- In Auto Focus  
(Only when the focus mode lever is set to [AFS/AFF], and [AF+MF] in [Custom] menu is set to [ON])

Rotating the side dial to the side **A**:

Focusing on a nearby subject

Rotating the side dial to the side **B**:

Focusing on a distant subject

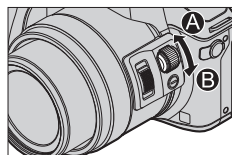

### Rear dial

You can set the aperture value, shutter speed, and other settings when in following recording modes.

Mode dial	 Rear dial*1
[P]	Programme Shift
[A]	Aperture value
[S]	Shutter speed
[M]	Shutter speed / Aperture value*2

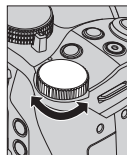

\*1 You can make the settings with the side dial as well. (→21)

\*2 You can switch between the shutter speed setting operation and the aperture value setting operation each time the  button/[Fn1] button is pressed.

### Temporarily changing the items assigned to the side/rear dials ([Dial Operation Switch])

You can temporarily change the items assigned to the side/rear dials using the function button to which [Dial Operation Switch] is assigned.

[Dial Operation Switch] is assigned to [Fn2] at the time of purchase.

- You can set the items to be assigned temporarily to the side/rear dials in [Dial Operation Switch Setup] in [Dial Set.] in the [Custom] menu.

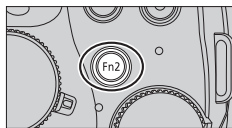

## 1 Press [Fn2] button

- A guide will be displayed showing the items assigned to the side/rear dials.
- If no operations are performed, the guide will disappear in a few seconds.

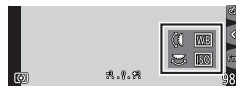

## 2 Rotate the side/rear dial while the guide is displayed

- The settings assigned to each dial will change.

## 3 Press [MENU/SET] to set

- When the recording screen is displayed, the original assignment settings for the dials are restored.
- Items that are temporarily assigned to the side/rear dials can be used only while the guide (step 1) or setting screen (step 2) is displayed.

## Side button

If you press the side button in recording, you can use it in the following two ways.

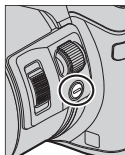

### ■ Calling the function for supporting the focus operation

**In Auto Focus:** If you press the side button, the selection screen for the case when focus is on a nearby subject (macro recording) is displayed\*.

\* In the Intelligent Auto Mode ([iA] or [iA<sup>+</sup>]), the AF Tracking function is applicable.

**In Manual Focus:** If you press the side button, the Auto Focus starts working temporarily (One-shot AF).

### ■ Switching the operation of the side dial

#### ① Set the menu (→23)

**MENU** → **Fc [Custom]** → **[Side Button Setting]** → **[F/SS]**

#### ② Press the side button

- You can rotate the side dial to set the aperture value and shutter speed.

You can switch the setting operation of the side dial each time you press the side button.  
Aperture value or shutter speed setting ←→ Focus adjustment

- Select [AF<sup>+</sup>/FOCUS] in step ① to return to the default setting.
- In the Manual Exposure Mode, you can set the aperture value with the side dial, and the shutter speed with the rear dial. If you press the [M] button/[Fn1] button, you can switch the setting operation of both of the dials.

## [LVF] button (Switching between the monitor and viewfinder)

### 1 Press [LVF] button

- The display is switched as shown below.



- \* If [Eye Sensor AF] in the [Custom] menu is set to [ON], the camera automatically adjusts the focus as the eye sensor is activated.

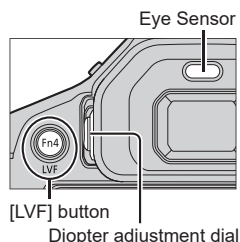

### ■ Automatic switching between viewfinder and monitor

For automatic switching between the viewfinder and monitor, the eye sensor automatically switches the display to viewfinder when your eye or an object moves close to the viewfinder.

### ■ About diopter adjustment

Rotate the diopter adjustment dial to adjust until you are able to clearly see the characters displayed in the viewfinder.

## Touch screen (Touch operations)

Touch screen of this unit is capacitive. Touch the panel directly with your bare finger.

### Touch

To touch and release the touch screen. Be sure to touch the centre of the desired icon.



### Drag

To touch and slide your finger across the touch screen. This can also be used to forward or rewind a picture during playback, etc.



### Pinch (spread/pinch)

On the touch screen, spread (pinch out) your 2 fingers to zoom in, and pinch (pinch in) your 2 fingers to zoom out.



## Setting the menu

You can use the menu to set camera and recording functions, operate playback functions, and perform other operations.

- The menu types and items that are displayed vary according to the mode.
- The setting methods vary depending on the menu item.

### 1 Press [MENU/SET] to bring up the menu

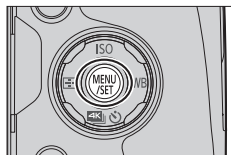

### 2 Press ▲▼ to select the menu item and press [MENU/SET]

### 3 Press ▲▼ to select the setting and press [MENU/SET]

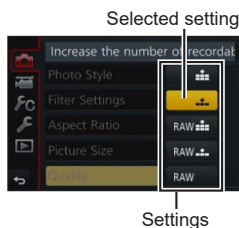

### 4 Press the [Q.MENU / ] button repeatedly until the recording or playback screen reappears

- During recording, the menu screen can also be exited by pressing the shutter button halfway.

#### ■ Switching menu type





- 1 Press ◀
- 2 Press ▲▼ to select a menu switch icon such as
  - Items can also be selected by rotating the side dial.
- 3 Press [MENU/SET]



Menu type

## Calling frequently-used menus instantly (Quick Menu)

You can easily call some of the menu items and set them.

- 1 Press [Q.MENU  ] button
- 2 Rotate the side dial or zoom lever to select a menu item
- 3 Rotate the rear dial to select the setting
- 4 Press [Q.MENU  ] button to close the Quick menu



## Assigning frequently used functions to the buttons

(Function buttons)

You can assign frequently-used functions to particular buttons ([Fn1] - [Fn4]) or icons displayed on the screen ([Fn5] - [Fn9]).

- 1 Set the menu

MENU →  [Custom] → [Fn Button Set]

- 2 Use ▲ ▼ to select [Setting in REC mode] or [Setting in PLAY mode] and press [MENU/SET]
- 3 Press ▲ ▼ to select the function button you want to assign a function to and press [MENU/SET]
- 4 Press ▲ ▼ to select the function you want to assign and press [MENU/SET]

- Certain functions cannot be assigned to some function buttons.

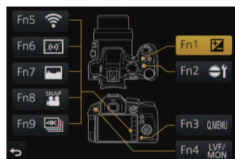



## Taking pictures with automatic settings (Intelligent Auto Mode)

Recording mode:  

This mode is recommended for those who want to point and shoot as the camera optimises settings to match the subject and recording environment.

### 1 Set mode dial to [IA]

- The camera will switch to either the most recently used of Intelligent Auto Mode or Intelligent Auto Plus Mode. At the time of purchase, the mode is set to Intelligent Auto Plus Mode.

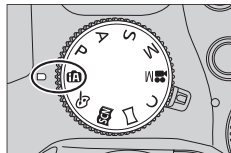

### 2 Point the camera at the subject

- When the camera identifies the optimal scene, the icon for each scene turns blue for 2 seconds and then changes to the normal red indication.



## Switching between Intelligent Auto Plus Mode and Intelligent Auto Mode

1 Press [MENU/SET]

2 Press ◀

3 Press ▲ ▼ to select the [iA+] or [IA] tab

- Items can also be selected by rotating the side dial.

4 Use ▶ to select [iA+] or [IA] and press [MENU/SET]

- If [DISP.] button is pressed, the description of the selected mode will be displayed.



## Taking pictures using a handheld camera ([iHandheld Night Shot])

Recording mode:  

If a night scene is detected automatically while the unit is being handheld, [iHandheld Night Shot] can record a still picture with less jitter and less noise without using a tripod by combining a burst of pictures.

**MENU** →  [Rec] → [iHandheld Night Shot] → [ON] / [OFF]

## Combining pictures into a single still picture with rich gradation ([iHDR])

Recording mode:  

When there is, for example, strong contrast between the background and the subject, [iHDR] records multiple still pictures with differing exposures and combines them to create a single still picture rich in gradation.

[iHDR] is activated when required. When activated, [HDR] will be displayed on the screen.

**MENU** →  **[Rec]** → **[iHDR]** → **[ON]** / **[OFF]**

## Defocusing the background (Defocus control function)

Recording mode:  

You can easily set the blurriness of the background while checking the screen.

**1 Press [Fn2] button to display the setting screen**

**2 Rotate the rear dial to adjust the background defocusing condition**

- Press [MENU/SET] to return to the recording screen.
- Pressing [Fn2] button on the blurriness setting screen will cancel the setting.



## Recording images by changing the brightness (exposure) or colour tone

Recording mode: 

This mode enables you to change the brightness (exposure) and colour tone to your preferred settings from the ones set by the camera.

### Setting brightness (exposure)

**1 Press [Z] button**

**2 Rotate the rear dial to adjust brightness (exposure)**

- Press [Z] button again to return to the recording screen.



### Setting colouring

**1 Press ► to display the setting screen**

**2 Rotate the rear dial to adjust colour**

- This will adjust the colour of the image from a reddish colour to a bluish colour.
- Press [MENU/SET] to return to the recording screen.



## Recording motion pictures by setting the aperture value/shutter speed (Creative Video Mode)

Recording mode: 

You can record motion pictures by manually setting the aperture value and shutter speed.

**1** Set mode dial to [M]

**2** Set the menu

MENU →  [Motion Picture] → [Exposure Mode]

**3** Press ▲ ▼ to select [P], [A], [S] or [M], and press [MENU/SET]

- The operation for changing the aperture value or shutter speed is the same as the operation for setting the mode dial to [P], [A], [S] or [M].

**4** Press the motion picture button (or shutter button) to start recording

- Still pictures cannot be taken.

**5** Press the motion picture button (or shutter button) to stop recording

## Setting the picture quality and size

### Changing the aspect ratio of the still pictures

Recording mode:   P A S M  C  

This allows you to select the aspect ratio of the pictures to suit printing or the playback method.

MENU →  [Rec] → [Aspect Ratio]

[4:3]	Aspect ratio of a 4:3 TV
[3:2]	Aspect ratio of standard film cameras
[16:9]	Aspect ratio of high-definition TV, etc.
[1:1]	Aspect ratio of a square image

- Edges may be cut off when printing - be sure to check in advance.

## Setting the picture size

Recording mode: **PAS** **M** **C**

The higher the numbers of pixels, the finer the detail of the pictures will appear even when they are printed onto large sheets.

**MENU** → **[Rec]** → **[Picture Size]**

[Aspect Ratio]	4:3	3:2	16:9	1:1
[Picture Size]	<b>[L] 12M</b> 4000×3000	<b>[L] 10.5M</b> 4000×2672	<b>[L] 9M</b> 4000×2248	<b>[L] 9M</b> 2992×2992
	<b>[EX M] 8M</b> 3264×2448	<b>[EX M] 7M</b> 3264×2176	<b>[EX M] 8M</b> 3840×2160	<b>[EX M] 6M</b> 2448×2448
	<b>[EX S] 3M</b> 2048×1536	<b>[EX S] 2.5M</b> 2048×1360	<b>[EX S] 2M</b> 1920×1080	<b>[EX S] 3.5M</b> 1920×1920

## Setting the compression rate of pictures ([Quality])

Recording mode: **PAS** **M** **C**

Set the compression rate used for storing pictures.

**MENU** → **[Rec]** → **[Quality]**

Settings	File format	Description
	JPEG	Gives priority to picture quality and saves pictures in JPEG file format.
		Saves pictures in JPEG file format using standard picture quality. This setting is useful when you want to increase the number of recordable pictures without changing the number of pixels.
 	RAW + JPEG	Saves pictures in JPEG file format ( or ) in addition to the RAW file format.*1
	RAW	Saves pictures in the RAW file format.*2 [RAW] images are recorded with a smaller data volume than [RAW ] or [RAW ].

\*1 If you delete a RAW file from the camera, the corresponding JPEG file is also deleted.

\*2 Regardless of the aspect ratio of the picture during recording, a RAW image is always recorded with the aspect ratio of the picture set to [4:3] (4000 × 3000).

- You can develop the RAW file pictures using [RAW Processing] in the [Playback] menu. (→39)
- To develop and edit RAW file pictures on a PC, use the supplied DVD software (Ichikawa Soft Laboratory's "SILKYPIX Developer Studio"). (→47)

### ■ About RAW file

In RAW file format the data is saved without any picture processing by the camera. This format delivers a higher picture quality than the JPEG format, but the amount of data is greater.

## Taking close-up pictures (Macro recording)

Recording mode: 

**1** Set the focus mode lever to [AFS/AFF] or [AFC]

**2** Press the side button

- If you cannot select the macro recording mode, set the [Side Button Setting] under the [Custom] menu to [AF $\updownarrow$ /FOCUS], and then press the side button.

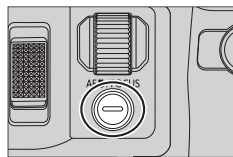

**3** Press  $\blacktriangleleft$   $\blacktriangleright$  to select the item and press [MENU/SET]

[AF $\updownarrow$ ] ([AF Macro])	You can take pictures of a subject as close as 1 cm (0.033 feet) from the lens by rotating the zoom lever upmost to Wide (1x).
[ $\updownarrow$ ] ([Macro Zoom])	Use this setting to get close to the subject and then further enlarge when taking the picture. You can take a picture with the Digital Zoom up to 3x while maintaining the distance to the subject for the extreme Wide position (1 cm (0.033 feet)).
[ $\updownarrow$ OFF] ([Off])	—

## Taking pictures with Manual Focus

Recording mode: 

Manual Focus is convenient when you want to lock the focus to take pictures or when it is difficult to adjust focus using Auto Focus.

**1** Set the focus mode lever to [MF]

**2** Press [ $\square$ ] button ( $\blacktriangleleft$ )

**3** Set the focus position with  $\blacktriangle$   $\blacktriangledown$   $\blacktriangleleft$   $\blacktriangleright$ , and press [MENU/SET]

- The screen changes to the assist screen and an enlarged display appears. (MF Assist)
- If you press [DISP.] button, the area to be enlarged will be reset to the centre.

**4** Rotate the side dial to adjust focus ( $\rightarrow$ 20)

- Colour is added to the portions of the image that are in focus. (Peaking)
- You can check whether the point of focus is to the near side or the far side. (MF Guide)

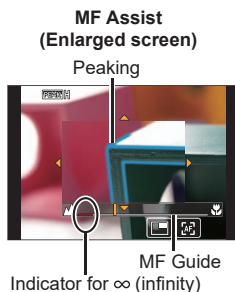

Button operation	Touch operation	Description
▲▼◀▶	Drag	Moves the enlarged area.
—	Pinch in / Pinch out	Enlarges/reduces the AF area in small steps.
	—	Enlarges/reduces the AF area in large steps.
—		Switches the enlarged display. (windowed/full screen)
[DISP.]	[Reset]	Resets the area to be enlarged back to the centre.

## 5 Press the shutter button halfway

- The assist screen will close. The recording screen will be displayed.
- You can also exit MF Assist by pressing [MENU/SET].

## Selecting a Drive Mode

Recording mode:

You can switch the operation to be performed when you press the shutter button.

### 1 Press [ ] button (▼)

### 2 Press ◀▶ to select the drive mode and press [MENU/SET]

- The icons in the table are just examples.

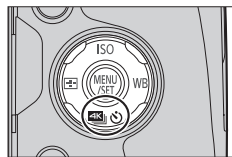

[Single]	When the shutter button is pressed, only one picture is recorded.
[Burst]	The pictures are recorded in succession while the shutter button is pressed.
[4K PHOTO] (→31)	When the shutter button is pressed, a 4K photo is recorded.
3-1/3  [Auto Bracket]*	Each time the shutter button is pressed, the pictures are recorded with different exposure settings based on the Exposure Compensation range.
[Self Timer]	When the shutter button is pressed, recording takes place after the set time has elapsed.

\* Cannot be set when using Intelligent Auto Mode.

- To cancel drive mode, select [] ([Single]) or [] ([Off]).

## Recording 4K Photos

Recording mode: PASM CSCN

You can select the desired moment from a burst of 4K photos taken at 30 frames/second and save that moment as a picture of approx. 8 million pixels.

**Record a 4K photo** → **Select and save pictures** → **The picture is complete**

- To record pictures, use a UHS Speed Class 3 card. (→16)
- When recording 4K photos, the angle of view becomes narrower.

**1** Press [] ] button (▼) (→30)

**2** Press ◀▶ to select an item ([], etc.) and press ▲

**3** Press ◀▶ to select the recording method and press [MENU/SET]

- Settings will be optimised for 4K photo recording. The recording method is set to [] (4K Burst) by default.

<p>[4K Burst]</p>	<p><b>For capturing the best shot of a fast-moving subject</b></p> <p>Burst recording is performed while the shutter button is pressed and held. The shutter sound will be heard repeatedly.</p> <p>(A) Press and hold (B) Recording is performed</p> <ul style="list-style-type: none"> <li>• Recording will start approximately 0.5 seconds after you press the shutter button fully.</li> </ul> <p>Continuous recording length: Up to 29 minutes and 59 seconds*</p>
<p>[4K Burst(S/S)] “S/S” is an abbreviation of “Start/Stop”.</p>	<p><b>For capturing unpredictable photo opportunities</b></p> <p>Burst recording starts when the shutter button is pressed and stops when pressed again. Start and stop tones will be heard.</p> <p>(C) Start (First) (D) Stop (Second) (E) Recording is performed</p> <p>Continuous recording length: Up to 29 minutes and 59 seconds*</p>

\* You can continue recording without interruption even if the file exceeds 4 GB, but the 4K burst file will be saved and played back in separate files.



[4K Pre-Burst]

**For recording as needed whenever a photo opportunity arises**

Burst recording is performed for approximately 1 second before and after the moment that the shutter button is pressed. The shutter sound will be heard only once.

- When the drive mode is set to [4K PHOTO] and [4K PHOTO] is set to ([4K Pre-Burst]), the battery drains faster and the camera temperature rises. **Select ([4K Pre-Burst]) only when recording.**

- Ⓕ Approximately 1 second  
Ⓖ Recording is performed

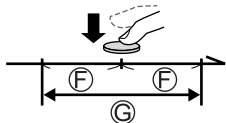

Recording length: Approximately 2 seconds

## 4 Press the shutter button to perform recording

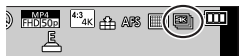

[4K Burst]	<ol style="list-style-type: none"> <li>① Press the shutter button halfway</li> <li>② Press and hold the shutter button fully for as long as you want to perform recording</li> </ol>
[4K Burst(S/S)]	<ol style="list-style-type: none"> <li>① Press the shutter button fully</li> <li>② Press the shutter button fully again</li> </ol>
[4K Pre-Burst]	<ol style="list-style-type: none"> <li>① Press the shutter button fully</li> </ol>

- When you perform 4K burst photo recording, a 4K burst file will be saved in the MP4 format.
- When [Auto Review] is enabled, the picture selection screen will be displayed automatically.

## Selecting pictures from 4K burst file and saving





- **The picture will be saved in JPEG format.**
  - For details, refer to "Operating Instructions for advanced features (PDF format)".



## Correcting jitter

Recording mode: 

Automatically detects and prevents jitter. For motion picture recording, the 5-Axis Hybrid Image Stabiliser function is available. It uses both the optical stabiliser of the lens and the electronic stabiliser of the camera's sensor.

[Operation Mode]	 (Normal)	Corrects vertical and horizontal jitter.
	 (Panning)	Corrects vertical jitter. This setting is ideal for panning (technique of recording a subject by matching the camera movement with the movement of a subject going in a specific direction). We recommend using the Viewfinder.
	[OFF]	[Stabilizer] does not work.
[E-Stabilization (Video)]	<p>Corrects jitters that occur in 5 directions during motion picture recording, namely the vertical direction, horizontal direction, rotation axis, vertical rotation, and horizontal rotation (5-axis Hybrid Image Stabiliser function).</p> <p><b>[ON] / [OFF]</b></p> <ul style="list-style-type: none"> <li>If you set this item to [ON],  is displayed on the screen while recording motion pictures. However, in the Creative Video Mode,  is displayed on the screen at all times.</li> <li>The angle of view may become narrower as compared to that during recording.</li> </ul>	

## Zoom types and use

Optical Zoom*1	You can zoom in without degrading the picture quality. <b>Maximum magnification: 24x</b>
Extra optical zoom*1	This function works when picture sizes with <b>[EX]</b> have been selected in [Picture Size] (→28). Extra optical zoom allows you to zoom in using a higher zoom ratio than Optical Zoom, without degrading the picture quality. <b>Maximum magnification: 46.9x (Including the optical zoom ratio. This maximum zoom ratio varies depending on the picture size.)</b>
[i.Zoom]*1	You can use the camera's Intelligent Resolution technology to increase the zoom ratio up to 2x higher than the original zoom ratio with limited deterioration of picture quality.
[Digital Zoom]*1, *2	Zoom 4x further than Optical/Extra optical zoom. Note that, with Digital Zoom, enlarging will decrease picture quality. ● When [Digital Zoom] is used simultaneously with [i.Zoom], you can only increase the zoom ratio up to 2x.

\*1 You can not use this function in Panorama Shot Mode.

\*2 You can not use this function in Intelligent Auto Mode and Intelligent Auto Plus Mode.

## Recording motion pictures

Recording mode: 

You can record full high-definition quality images that comply with the AVCHD standard, as well as motion pictures recorded in MP4. You can also record a 4K motion picture in MP4. (→35) Audio is recorded in stereo.

### 1 Press the motion picture button to start recording

- Recording of motion picture appropriate for each motion picture mode is possible.
- Immediately release the motion picture button after pressing it.
- While you are recording motion pictures, the recording status indicator (red) will flash.
- **With recording in a quiet environment, the sound of aperture, focus and other actions may be recorded in motion pictures. This is not a malfunction.**

The focus operation during recording of motion pictures can be set to [OFF] in [Continuous AF].

- If some information is no longer displayed on the screen, press the [DISP.] button or touch the monitor.
- If you press the shutter button down fully, you can take still pictures while recording motion pictures.

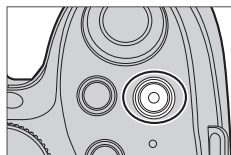

Recording state indicator



Elapsed recording time

Remaining recording time

### 2 Press the motion picture button again to end recording

- If the surrounding temperature is high, or a motion picture is recorded continuously, [] is displayed and recording may be stopped halfway through to protect the camera. Wait until the camera cools down.
- [AVCHD] motion pictures: Recording stops when the continuous recording time exceeds 29 minutes and 59 seconds.
- Motion pictures with their file size set to [FHD], [HD] or [VGA] in [MP4]: Recording stops when the continuous recording time exceeds 29 minutes and 59 seconds or the file size exceeds 4 GB.
  - Since the file size becomes larger with [FHD], recording with [FHD] will stop before 29 minutes 59 seconds.
- Motion pictures with their file size set to [4K] in [MP4]: Recording stops when the continuous recording time exceeds 29 minutes 59 seconds. (You can continue recording without interruption even if the file exceeds 4 GB, but the motion picture file will be recorded and played back in separate files.)

## ■ Setting the format, picture size and recording frame rate

**MENU** →  **[Motion Picture]** → **[Rec Format]**

<b>[AVCHD]</b>	This is a data format suitable for playback on high-definition TVs.
<b>[MP4]</b>	This data format is suited for playing back motion pictures on a computer and other such devices.

**MENU** →  **[Motion Picture]** → **[Rec Quality]**

### When [AVCHD] is selected

Item	Picture size	Recording frame rate	Bit rate (approx.)
<b>[FHD/28M/50p]*</b>	1920×1080	50p	28 Mbps
<b>[FHD/17M/50i]</b>	1920×1080	50i	17 Mbps
<b>[FHD/24M/25p]</b>	1920×1080	50i	24 Mbps
<b>[FHD/24M/24p]</b>	1920×1080	24p	24 Mbps

\*AVCHD Progressive

### When [MP4] is selected

Item	Picture size	Recording frame rate	Bit rate (approx.)
<b>[4K/100M/25p]</b>	3840×2160	25p	100 Mbps
<b>[4K/100M/24p]</b>	3840×2160	24p	100 Mbps
<b>[FHD/28M/50p]</b>	1920×1080	50p	28 Mbps
<b>[FHD/20M/25p]</b>	1920×1080	25p	20 Mbps
<b>[HD/10M/25p]</b>	1280×720	25p	10 Mbps
<b>[VGA/4M/25p]</b>	640×480	25p	4 Mbps

## Recording 4K motion pictures

Recording mode:   **PAS**    

You can record high-resolution 4K motion pictures by setting [Rec Quality] to [4K].

- To record 4K motion pictures, use a UHS Speed Class 3 card. (→16)
- When you record 4K motion pictures, the angle of view will be narrower than motion pictures of other sizes.

### ■ To record 4K motion pictures

- ① Select the recording mode (→19)
- ② Set the [Rec Format] in the [Motion Picture] menu to [MP4] (above)
- ③ Set [Rec Quality] in the [Motion Picture] menu to [4K/100M/25p] or [4K/100M/24p] (above)
- ④ Press the motion picture button to start recording
- ⑤ Press the motion picture button again to end recording

## Viewing your pictures

### 1 Press the Playback button

### 2 Press ◀▶ to select a picture to be displayed

- When you press and hold ◀▶, the pictures are displayed one after another.
- Pictures can also be forwarded or rewound by rotating the rear dial or dragging the screen horizontally (→22).
- If you keep your finger touching the left or right edge of the screen after scrolling the pictures, the pictures will continue to be scrolled. (The pictures are displayed in a reduced size.)
- The playback speed of pictures varies depending on the playback conditions.

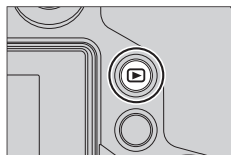

### ■ Sending pictures to the WEB services

If you press ▼ while a single picture is being displayed, you can send the picture to the WEB service quickly. For details, refer to “Operating Instructions for advanced features (PDF format)”.

### ■ Ending Playback

Press the Playback button again or press the Motion picture button.  
The Playback can also be ended by pressing the shutter button halfway.

- When the camera is switched to the playback screen from the recording screen, the lens barrel is retracted after approx. 15 seconds.

## Viewing motion pictures

This unit was designed to play motion pictures using the AVCHD and MP4 formats.

- Motion pictures are displayed with the motion picture icon ([]).

### 1 Press to start playback

- Touching [] in the middle of the screen allows you to play back motion pictures.

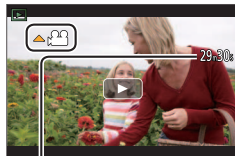















Motion picture recording time

Example:

29 minutes and 30 seconds:  
[29m30s]

### ■ Operations during motion picture playback

Button operation	Touch operation	Description
		Play/pause
		Fast rewind*1
		Single-frame rewind*2 (while paused)
		Volume down
		Stop
		Fast forward*1
		Single-frame forward (while paused)
		Volume up

\*1 The fast forward or rewind speed increases if you press  again.

\*2 Motion pictures recorded in [AVCHD] are reformed frame by frame approximately every 0.5 seconds.

- If you press [MENU/SET] during a pause, you can create a picture from a motion picture.

## Deleting pictures

Deleted pictures cannot be recovered.

### [Delete Single]

#### 1 Press [Q.MENU ] button to delete displayed picture

- The same operation can be performed by touching .

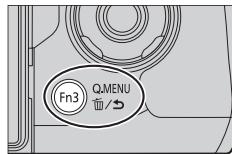

#### 2 Use to select [Delete Single] and press [MENU/SET]

- A confirmation screen is displayed. If you select [Yes], the operation is executed.

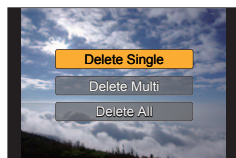

### To delete multiple (up to 100)/To delete all pictures

A picture group is handled as 1 picture. (All the pictures in the selected picture group are deleted.)

#### 1 Press [Q.MENU ] button while viewing a picture (Step 1 above)

#### 2 Use to select [Delete Multi]/[Delete All] and press [MENU/SET]

- When [Delete All] is selected → A confirmation screen is displayed. If you select [Yes], the operation is executed.
- You can select [All Delete Except Favorite] in [Delete All] if there are pictures that have been set as [Favorite].

#### 3 (When [Delete Multi] is selected) Use to select picture and press [MENU/SET] (repeat)

- To cancel → Press [MENU/SET] again.

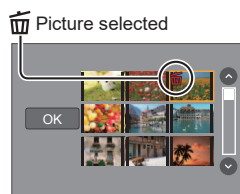

#### 4 (When [Delete Multi] is selected) Use to select [OK] and press [MENU/SET]

- A confirmation screen is displayed. If you select [Yes], the operation is executed.

## Using the [Playback] menu

### [RAW Processing]

You can use the camera to develop still pictures that were recorded in RAW format (→28). The created still pictures are saved in JPEG format. You can check how effects are applied to each picture while processing it.

#### 1 Set the menu (→23)

[MENU] → [Playback] → [RAW Processing]



#### 2 Press ◀▶ to select RAW file and press [MENU/SET]

#### 3 Press ▲▼ to select the item

[White Balance]	[Shadow]
[Exposure Comp.]	[Saturation] / [Color Tone]*
[Photo Style]	[Filter Effect]*
[i.Dynamic]	[Noise Reduction]
[Contrast]	[i.Resolution]
[Highlight]	[Sharpness]
[Setup] ([Reinstate Adjustments] / [Color Space] / [Picture Size])	

\* Only when [Monochrome] is selected for [Photo Style].

#### 4 Press [MENU/SET] to set

- The setting methods vary depending on the item.

#### 5 Press [MENU/SET]

- The screen in step 3 reappears. To set another item, repeat steps 3 to 5.

#### 6 Press ▲▼ to select [Begin Processing] and press [MENU/SET]

- A confirmation screen is displayed. If you select [Yes], the operation is executed.

#### ■ When [Setup] is selected

When you select [Setup] in step 3, the screen for selecting [Reinstate Adjustments], [Color Space], or [Picture Size] is displayed.

##### ① Use ▲▼ to select the item and press [MENU/SET]

- When [Reinstate Adjustments] is selected, confirmation screen is displayed. When you select [Yes], the item selection screen reappears.

##### ② Use ▲▼ to select the setting and press [MENU/SET]

## ■ Setting each item

When you select an item, the setting screen appears.

Button operation	Touch operation	Description
	<b>Drag</b>	Used to make adjustments
<b>▲</b>	<b>[WB K Set]</b>	Used to display the colour temperature setting screen (Only when [White Balance] is set to <b>[K]</b> )
<b>▼</b>	<b>[Adjust.]</b>	Used to display the White Balance fine adjustment screen (Only when [White Balance] is set)
<b>[DISP.]</b>	<b>[DISP.]</b>	Used to display the comparison screen
<b>[MENU/SET]</b>	<b>[Set]</b>	Used to finalise an adjustment you just made and to return to the item selection screen

- If you have selected [Noise Reduction], [i.Resolution], or [Sharpness], the comparison screen is not displayed.
- Pictures can be enlarged by operating the zoom lever. You can also zoom in by quickly touching the touch screen twice. (If the display was enlarged, it returns to the same magnification ratio.)

The following operating methods are available to make adjustments on the comparison screen.

Button operation	Touch operation	Description
	<b>Drag</b>	Used to make adjustments
<b>[DISP.]</b>	<b>[DISP.]</b>	Used to return to the setting screen
<b>[MENU/SET]</b>	<b>[Set]</b>	Used to finalise an adjustment you just made and to return to the item selection screen

- If you touch the picture at the centre, it will be enlarged. If you touch , the picture will be reduced to the original size.
- The result of a RAW file developed by this camera and a RAW file developed by the supplied DVD software "SILKYPIX Developer Studio" will not be exactly the same.
- Regardless of the aspect ratio of the picture during recording, a RAW image recorded on this camera is always recorded with the aspect ratio set to [4:3] (4000×3000), but if you perform [RAW Processing] from the [Playback] menu, the picture will be processed with the aspect ratio fixed as that at the time of recording.
- You can perform RAW processing on pictures recorded using this unit only.



## What you can do with the Wi-Fi® function

### Operating the camera by connecting it to a smartphone/tablet (→42)

Taking pictures via a smartphone (remote recording) (→44)

Playing back pictures in the camera on a smartphone (→44)

Saving pictures in the camera to a smartphone (→44)

Sending pictures in the camera to social networking services (→44)

Adding location information to pictures in the camera from a smartphone (→45)

Combining motion pictures recorded with Snap Movie according to your preference on a smartphone (→45)

#### ■ Connect easily

You can easily set up a direct connection to your smartphone without entering a password.

### Displaying still pictures on a TV

### Wireless printing

### Sending pictures to AV device

### Sending pictures to a PC

### Using WEB services

- Hereafter, this manual uses the term “smartphone” for both smartphones and tablets unless it is necessary to distinguish between them.
- For details, refer to “Operating Instructions for advanced features (PDF format)”.
- The camera cannot be used to connect to a public wireless LAN connection.

## About the [Wi-Fi] button

In this operating instructions, a function button to which [Wi-Fi] is assigned is referred to as the [Wi-Fi] button. (At the time of purchase, [Wi-Fi] is assigned to [Fn5] button.)

- For details on the function button, refer to (→24).

### ■ To start up the Wi-Fi function



- ① Touch [Fn]
- ② Touch [Wi-Fi]



## Operating the camera by connecting it to a smartphone

### Installing the smartphone/tablet app “Panasonic Image App”

The “Image App” is an application provided by Panasonic that allows your smartphone to perform the following operations of a Wi-Fi-compatible LUMIX.

	For Android™ apps	For iOS apps
<b>Supported OS</b>	Android 4.0 or later	iOS 6.0 or later (iPhone 3GS is not supported.)
<b>Installation procedure</b>	<ol style="list-style-type: none"> <li>① Connect your Android device to a network</li> <li>② Select “Google Play™ Store”</li> <li>③ Enter “Panasonic Image App” or “LUMIX” to search for the app</li> <li>④ Select “Panasonic Image App” and install it</li> </ol> <ul style="list-style-type: none"> <li>• The icon will be added to the menu.</li> </ul> 	<ol style="list-style-type: none"> <li>① Connect the iOS device to the network</li> <li>② Select “App Store<sup>SM</sup>”</li> <li>③ Enter “Panasonic Image App” or “LUMIX” to search for the app</li> <li>④ Select “Panasonic Image App” and install it</li> </ol> <ul style="list-style-type: none"> <li>• The icon will be added to the menu.</li> </ul> 

- Use the latest version.
  - Supported OS versions as of July 2015. Supported OS versions may be changed without prior notice.
  - For details about the operating procedure, etc., refer to [Help] in the “Image App” menu.
  - If you connect the camera and smartphone over a Wi-Fi connection and run “Image App”, [Help] may not be displayed in the “Image App” menu for some smartphones. In such a case, disconnect the Wi-Fi connection with the camera, connect the camera to a cellular data line such as 3G and LTE, or the Internet to display [Help] in the “Image App” menu.
  - Some of the screens and information provided in this document may be different depending on the supported operating system and “Image App” version.
  - The service may not be able to be used properly depending on the type of smartphone being used.
- For the latest information on the “Image App”, refer to the support site below.  
<http://panasonic.jp/support/global/cs/dsc/> (This site is available in English only.)
- When downloading the app on a mobile network, high packet communication fees may be incurred depending on the details of your contract.

## Connecting to a smartphone

For both iOS devices (iPhone/iPod touch/iPad) and Android devices

### Connecting without entering the password

You can easily establish a Wi-Fi connection on this unit without entering a password on your smartphone.

#### 1 Select the menu on the camera (→23)

**MENU** →  **[Setup]** → **[Wi-Fi]** → **[Wi-Fi Function]** → **[New Connection]**  
→ **[Remote Shooting & View]**

- The information required for directly connecting your smartphone to this unit (SSID) is displayed.
- You can also display the information by pressing [Wi-Fi] button on the camera.



#### 2 Turn on the Wi-Fi function in the setting menu of the smartphone

#### 3 Select the SSID displayed on the screen of the camera

#### 4 On the smartphone, start “Image App”

- When the connection confirmation screen appears on the camera, select [Yes] and press [MENU/SET]. (Only when making a connection for the first time.)



[Wi-Fi Password] is set to [OFF] at the time of purchase. In [OFF] state, a third party can tap into the Wi-Fi transmission and steal transmitted data. Set [Wi-Fi Password] to [ON].

For details, refer to “Operating Instructions for advanced features (PDF format)”.

### Closing the connection

After use, close the connection with the smartphone.

(On the camera)

#### 1 On the recording standby screen, terminate the connection from the menu of the camera

**MENU** →  **[Setup]** → **[Wi-Fi]** → **[Wi-Fi Function]** → **[Yes]**

- You can also terminate the connection by pressing [Wi-Fi] button on the camera.

(On your smartphone)

#### 2 Close “Image App”

- For details on how to close the application, refer to the operating instructions of your device.

## Taking pictures via a smartphone (remote recording)

### 1 Connect to a smartphone (→43)

### 2 Operate the smartphone

- ① Select [
- ② Take pictures
  - The recorded images are saved in the camera.
  - Some settings are not available.



## Playing back pictures in the camera on a smartphone

### 1 Connect to a smartphone (→43)

### 2 Operate the smartphone

- ① Select []
  - When the picture is touched, it is played back at a larger size.



- When playing back motion pictures, the data size is reduced during transmission of motion pictures to "Image App". Therefore, the picture quality may be different from the actual motion picture that you have recorded. Depending on your smartphone and its usage environment, you may notice degradation in the picture quality or skipping of sound when playing back motion pictures and still pictures.

## Saving pictures in the camera to a smartphone

### 1 Connect to a smartphone (→43)

### 2 Operate the smartphone

- ① Select []
- ② Press and hold the picture and drag it to save it on the smartphone



- Functions can be assigned to the top, bottom, left and right as you wish.
- Pictures in RAW format, AVCHD motion pictures, MP4 motion pictures with a [Rec Quality] size of [4K], and 4K burst files cannot be saved.

## Sending pictures in the camera to social networking services

### 1 Connect to a smartphone (→43)

### 2 Operate the smartphone

- ① Select []
- ② Press and hold the picture and drag it to send it to the social networking service, etc.
  - The picture will be sent to the social networking service or other WEB services.



- Functions can be assigned to the top, bottom, left and right as you wish.

## Adding location information to pictures in the camera from a smartphone

You can send the location information acquired from a smartphone to the camera. After the information is sent, you can write it on the pictures in the camera.

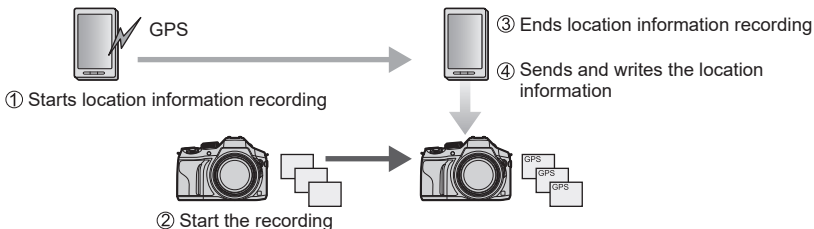

### ■ Operate the smartphone

- ① Connect to a smartphone (→43)
- ② Select []
- ③ Select []
- ④ Select an icon



	<p>Start/stop recording location information. (① and ③ above)</p> <ul style="list-style-type: none"> <li>• The smartphone battery drains faster while location information is being recorded. When recording of location information is not necessary, stop it.</li> </ul>
	<p>Sending and writing location information. (④ above)</p> <ul style="list-style-type: none"> <li>• Follow the messages on the screen to perform the operation.</li> <li>• [GPS] is displayed for pictures that have location information written to it.</li> </ul>

## Combining motion pictures recorded with Snap Movie according to your preference on a smartphone

Using a smartphone, you can combine motion pictures recorded with the camera's [Snap Movie] function (→52). Music can be added to motion pictures to be combined. In addition, you can save the combined motion picture or upload it on a web service.

### 1 Connect to a smartphone (→43)

### 2 Operate the smartphone



- ① Select []
- ② Select []
  - The camera's [Snap Movie] motion pictures with recent recording dates will be selected and automatically sent to the smartphone.
  - When motion pictures with recent recording dates are not available, a screen that lets you select motion pictures will be displayed. Select motion pictures and send them.
- ③ Edit the motion pictures
  - Read the [Help] in the "Image App" menu for further details on how to operate [Snap Movie] of "Image App".

- [Snap Movie] of the "Image App" requires a smartphone that supports Android OS 4.3 or higher.
- The iPhone 4 and iPod touch (4th generation) do not support [Snap Movie] of the "Image App".

## Reading the Operating Instructions (PDF format)

More detailed instructions on the operation of this camera are contained in "Operating Instructions for advanced features (PDF format)" in the supplied disc.

### ■ For Windows

- ① Turn the PC on and insert the disc containing the Operating Instructions (supplied)
  - If the automatic playback screen is displayed, you can display the menu by selecting and executing [Launcher.exe].
  - In Windows 8.1/Windows 8, you can display the menu by clicking a message that is displayed after inserting the disc and then selecting and executing [Launcher.exe].
  - You can also display the menu by double-clicking [SFMXXXX] in [Computer]. (The "XXXX" portion differs depending on the model.)
- ② Click [Operating Instructions]
  - The list of Operating Instructions (PDF format) will be displayed.
- ③ Click the language of the Operating Instructions you want to open
  - The "Operating Instructions for advanced features (PDF format)" will open. You can save the "Operating Instructions for advanced features" on the PC.
- You will need Adobe Reader to browse or print the Operating Instructions (PDF format). You can download and install a version of Adobe Reader that you can use with your OS from the following website. (As of July 2015)  
<http://www.adobe.com/products/acrobat/readstep2.html>

### ■ For Mac

- ① Turn the PC on and insert the disc containing the Operating Instructions (supplied)
- ② Open the "Manual" folder in the disc
- ③ Double click the [INDEX.pdf]
  - The list of Operating Instructions (PDF format) will be displayed.
- ④ Click the language of the Operating Instructions you want to open
  - The "Operating Instructions for advanced features (PDF format)" will open. You can save the "Operating Instructions for advanced features" on the PC.
- You can also open the "Operating Instructions for advanced features (PDF format)" directly from the "Manual" folder.

## About supplied software

The supplied DVD contains the following software.  
Install the software on your computer before using.

### PHOTOfunSTUDIO 9.7 PE

- Supported OS: Windows 8.1 / Windows 8 / Windows 7 / Windows Vista
- Refer to the Operating Instructions of "PHOTOfunSTUDIO" (PDF) for further information about the operating environment.

### SILKYPIX Developer Studio 4.3 SE

- Supported OS: Windows 8.1 / Windows 8 / Windows 7 / Windows Vista  
Mac OS X v10.6 to v10.10
- For details on the operating environment and how to use the SILKYPIX Developer Studio, refer to the "Help" or the Ichikawa Soft Laboratory's support website:  
<http://www.isl.co.jp/SILKYPIX/english/p/support/>

### LoiLoScope 30 day full trial version

- Supported OS: Windows 8.1 / Windows 8 / Windows 7 / Windows Vista
- **For more information on how to use LoiLoScope and its operating environment, read the LoiLoScope manual available for download at the link below.**  
**Manual URL:** <http://loilo.tv/product/20>

## Installing supplied software

The software compatible with your PC will be installed.

### Preparations

- Check your PC's specifications and operating environment for each software.
- Before inserting the DVD (supplied), close all running applications.

### 1 Insert the DVD with the supplied software

- If the automatic playback screen is displayed, you can display the menu by selecting and executing [Launcher.exe].
- In Windows 8.1/Windows 8, you can display the menu by clicking a message that is displayed after inserting the DVD and then selecting and executing [Launcher.exe].
- You can also display the menu by double-clicking [SFMXXXX] in [Computer]. (The "XXXX" portion differs depending on the model.)

### 2 Click [Applications]

### 3 Click [Recommended Installation]

- Continue the installation procedure following the instructions displayed on the screen.
- If you are using a Mac, you can manually install SILKYPIX.
  - ① Insert the DVD with the supplied software
  - ② Double-click the application folder on the DVD
  - ③ Double-click the folder that automatically appears
  - ④ Double-click the icon in the folder
- PHOTOfunSTUDIO / LoiLoScope are not compatible with Mac.

## List of monitor/viewfinder displays

- The following images are examples of when the display screen is set to [MONITOR] (monitor style) in the monitor.

### In recording

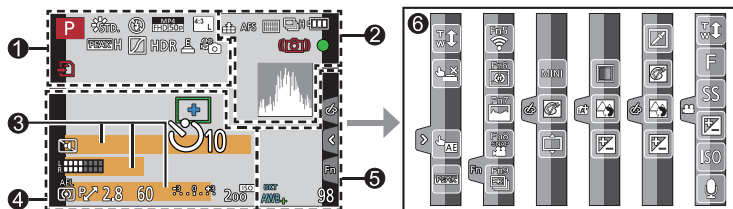

1

	Recording mode (→19)
C 1	Custom Set
	[Photo Style]
	Flash Mode
	Flash
	[Rec Format]/[Rec Quality] (→35)
	[Snap Movie]
	[Aspect Ratio] (→27)/ [Picture Size] (→28)
	Image size (Panorama Shot Mode)
	Picture effect (Filter) adjustment display
EXPS	Types of picture effects (Filter)
	Card (displayed only during recording)
XXmXXs	Elapsed recording time*1 (→34)
	Simultaneous recording indicator
	Automatic switching between viewfinder and monitor (→22)

	[Peaking] (→29)
	[Highlight Shadow]
HDR	[HDR]/[iHDR] (→26)
	[Multi Exp.]
	[Conversion]
	Electronic shutter
	Picture Mode (Photo Priority)
	Overheat indicator (→34, 55)



2

	RAW	[Quality] (→28)
	200fps 100fps	[High Speed Video]
	AFS AFF AFC MF	Focus Mode (→29)
	AF Mode	
		[Pull Focus]
		[Face Recog.]
	AFL	AF Lock
	Burst	(→30)
	4K PHOTO	(→31)
	[Auto Bracket]	(→30)
	[Self Timer]	(→30)
	Remaining battery	
	Macro recording	
	[Level Shot]	
	[Stabilizer]	
	Jitter alert	
	Recording state (Flashes red.) (→34)/ Focus (Lights green.) (→18)	
	Focus (Under low illumination)	
	Focus (Starlight AF)	
	Wi-Fi connection status	
	Histogram	

4

	AF area
	Spot metering target
	Centre marker display
	[Self Timer]*4 (→30)
	[Zoom Mic]
	[Mic Level Disp.]
	[Mic Level Limiter] ([OFF])
	[Silent Mode]
	External Microphone
	AE Lock
	[Metering Mode]
	Programme Shift
	2.8 Aperture value (→18)
	60 Shutter speed (→18)
	Exposure compensation value
	-3 . 0 . +3 Brightness (exposure) (→26)
	Manual Exposure Assist
	200 <sup>ISO</sup> ISO sensitivity

3

Name*2
Travel elapsed days*3
Age in years/months*2
Location*3
Current date/time*3
Travel destination setting*3: ✈
Exposure meter
Zoom

5

<b>Fn1 F</b>	<b>[Dial Guide]</b>
BKT AWB +	White Balance Bracket
	White Balance Fine Adjustment
	White Balance
	Colouring (→26)
98	Number of recordable pictures*5
RXXmXXs	Available recording time*1, *5

6

<b>Touch tab</b>	
	Touch zoom
	Touch Shutter
	[Touch AE]
	[Peaking]
	Function buttons (→24, 41)
	Colouring (→26)
	Defocus control function (→26)
	Brightness (exposure) (→26)
	Type of defocus ([Miniature Effect])
	[One Point Color]
	[Sunshine]
	Picture effect (Filter) adjustment display
	Picture effects (Filter)
	Aperture value (→18)
	Shutter speed (→18)
	ISO sensitivity
	[Mic Level Adj.]

\*1 [m] and [s] indicate "minute" and "second".

\*2 This is displayed for about 5 seconds when the camera is turned on if the [Profile Setup] setting is set.

\*3 This is displayed for about 5 seconds when the camera is turned on, after setting the clock and after switching from Playback Mode to Recording mode.

\*4 This is displayed during countdown.

\*5 It is possible to switch the display between the number of recordable pictures and available recording time with the [Remaining Disp.] setting in the [Custom] menu.

## ■ On-monitor recording information

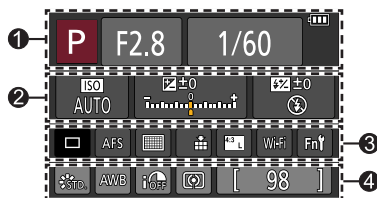

	<b>Recording mode</b> (→19)
<b>F2.8</b>	<b>Aperture value</b> (→18)
<b>1/60</b>	<b>Shutter speed</b> (→18)
	<b>Remaining battery</b>

	<b>ISO sensitivity</b>
<b>AUTO</b>	<b>ISO sensitivity</b>
	<b>Exposure compensation value</b>
<b>±0</b>	<b>Brightness (exposure)</b> (→26)
	<b>Manual Exposure Assist</b>
	<b>Flash Mode</b>
	<b>Flash</b>

	<b>Single</b> (→30)
	<b>Burst</b> (→30)
	<b>[4K PHOTO]</b> (→31)
	<b>[Auto Bracket]</b> (→30)
	<b>[Self Timer]</b> (→30)
	<b>Focus Mode</b> (→19, 29)
	<b>AF Mode</b>
	<b>[Quality]</b> (→28)
	<b>[Aspect Ratio]</b> (→27)/ <b>[Picture Size]</b> (→28)
	<b>Wi-Fi</b> (→41)
	<b>Function button setting</b> (→24)

	<b>[Photo Style]</b>
	<b>White Balance</b>
	<b>[i.Dynamic]</b>
	<b>[Metering Mode]</b>
<b>98</b>	<b>Number of recordable pictures</b>
<b>RXXmXXs</b>	<b>Available recording time*</b>

\* [m] and [s] indicate "minute" and "second".

## Menu list

- The [Photo Style], [Filter Settings], [AFS/AFF], [Metering Mode], [Highlight Shadow], [i.Dynamic], [i.Resolution], [Diffraction Compensation], [i.Zoom], [Digital Zoom], and [Conversion] menu items are common for both [Rec] and [Motion Picture] menus. If a setting in one menu is changed, the setting with the same name in other menu will also be changed automatically.

### [Rec]

[Photo Style]	[i.Dynamic]	[ISO Limit Set]
[Filter Settings]	[i.Resolution]	[ISO Increments]
[Aspect Ratio]	[i.Handheld Night Shot]	[Diffraction Compensation]
[Picture Size]	[iHDR]	[i.Zoom]
[Quality]	[HDR]	[Digital Zoom]
[AFS/AFF]	[Multi Exp.]	[Conversion]
[Metering Mode]	[Time Lapse Shot]	[Color Space]
[Burst Rate]	[Stop Motion Animation]	[Stabilizer]
[4K PHOTO]	[Panorama Settings]	[Face Recog.]
[Auto Bracket]	[Shutter Type]	[Profile Setup]
[Self Timer]	[Flash]	
[Highlight Shadow]	[Red-Eye Removal]	

### [Motion Picture]

[Snap Movie]	[Continuous AF]	[Special Mic.]
[Rec Format]	[Level Shot]	[Mic Level Limiter]
[Rec Quality]	[Flkr Decrease]	[Wind Noise Cancellor]
[Exposure Mode]	[Silent Operation]	[Wind Cut]
[High Speed Video]	[Mic Level Disp.]	[Zoom Mic]
[Picture Mode]	[Mic Level Adj.]	

## [Custom]

[Cust.Set Mem.]	[MF Guide]	[Remaining Disp.]
[Silent Mode]	[Peaking]	[Auto Review]
[AF/AE Lock]	[Histogram]	[Fn Button Set]
[AF/AE Lock Hold]	[Guide Line]	[Side Button Setting]
[Shutter AF]	[Center Marker]	[Zoom lever]
[Half Press Release]	[Highlight]	[Side Lever]
[Quick AF]	[Zebra Pattern]	[Zoom Resume]
[Eye Sensor AF]	[Monochrome Live View]	[Q.MENU]
[Pinpoint AF Time]	[Constant Preview (M Mode)]	[Dial Set.]
[Pinpoint AF Display]	[Expo.Meter]	[Video Button]
[AF Assist Lamp]	[Dial Guide]	[Eye Sensor]
[Direct Focus Area]	[LVF Disp.Style]	[Touch Settings]
[Focus/Release Priority]	[Monitor Disp. Style]	[Touch Scroll]
[AF+MF]	[Monitor Info. Disp.]	[Menu Guide]
[MF Assist]		
[MF Assist Display]	[Rec Area]	

## [Setup]

[Clock Set]	[Monitor Luminance]	[Version Disp.]
[World Time]	[Economy]	[Exposure Comp. Reset]
[Travel Date]	[USB Mode]	[Self Timer Auto Off]
[Wi-Fi]	[TV Connection]	[No.Reset]
[Beep]	[Menu Resume]	[Reset]
[Live View Mode]	[Menu Background]	[Reset Wi-Fi Settings]
[Monitor Display/ Viewfinder]	[Menu Information]	[Format]
	[Language]	

## [Playback]

[Slide Show]	[Video Divide]	[Favorite]
[Playback Mode]	[Time Lapse Video]	[Print Set]
[Location Logging]	[Stop Motion Video]	[Protect]
[RAW Processing]	[Resize]	[Face Rec Edit]
[Clear Retouch]	[Cropping]	[Picture Sort]
[Title Edit]	[Rotate]	[Delete Confirmation]
[Text Stamp]	[Rotate Disp.]	

## Q&A Troubleshooting

- Performing [Reset] in the [Setup] menu may resolve the issue.
- Further information is provided in the “Operating Instructions for advanced features (PDF format)”. Check it together with the information in this section.

### Camera does not work even if the camera is turned on. Camera switches off as soon as the camera is turned on.

- Battery needs recharging.
- If you leave the camera on, the battery will be exhausted.  
→ Turn the camera off frequently by using the [Economy] etc.

### This unit is turned off automatically.

- [Economy] is activated.
- The linked operation of VIERA Link (HDMI) is enabled.  
→ If you are not using VIERA Link (HDMI), set [VIERA Link] to [OFF].

### The battery runs down quickly.

- The drive mode is set to [4K PHOTO] and [4K PHOTO] is set to [ ] ([4K Pre-Burst]).  
→ When [ ] ([4K Pre-Burst]) has been selected, the battery drains faster.  
Select [ ] ([4K Pre-Burst]) only when recording.

### Cannot record pictures. The shutter will not operate immediately when the shutter button is pressed.

- When the drive mode is set to [4K PHOTO] and [4K PHOTO] in the [Rec] menu is set to [ ] ([4K Pre-Burst]), the camera temperature rises. In some cases, the camera may display [△], switch to [ ] ([4K Burst]) and stop the recording to protect itself. Wait until the camera cools down.

### Focus not aligned correctly.

- Subject outside of focus range.
- Caused by jitter or subject movement.
- [Focus/Release Priority] is set to [RELEASE]. (→53)
- [Shutter AF] is set to [OFF]. (→53)
- AF Lock is set inappropriately.

### Recorded pictures are blurred. The stabiliser function ineffective.

- Shutter speed is slower in dark locations and the stabiliser function is less effective.  
→ Hold camera firmly with both hands, keeping arms close to body.  
→ Use a tripod and the self-timer when using a slower shutter speed.
- If you take a picture of a moving subject using the electronic shutter, the subject in the picture may be skewed in some cases.

### Subject appears skewed in pictures.

- If you take a picture of a moving subject in the electronic shutter mode, motion picture recording mode, or 4K photo recording mode, the subject in the picture may be skewed in some cases. This is characteristic of MOS sensors which serve as the camera's pickup sensors. This is not a malfunction.

### Striping or flicker may appear under lighting such as fluorescent lighting and LED lighting fixture.

- This is characteristic of MOS sensors which serve as the camera's pickup sensors. This is not a malfunction.
- If you are taking still pictures using the electronic shutter, the striping may be reduced by setting a slower shutter speed.
- When noticeable flicker or striping is seen under lighting such as a fluorescent or LED lighting fixture in the motion picture recording mode, you can reduce the flicker or striping by setting up [Flkr Decrease] (→52) and fixing the shutter speed. It is possible to select a shutter speed from [1/50], [1/60], [1/100], or [1/120]. You can set the shutter speed manually in the Creative Video Mode. (→27)

### Brightness or colouring of recorded picture different from real life.

- When recording under fluorescent or LED lighting fixture etc., increasing the shutter speed may introduce slight changes to brightness and colour. These are a result of the characteristics of the light source and do not indicate a malfunction.
- When recording subjects in extremely bright locations or recording under fluorescent lighting, LED lighting fixture, mercury lamp, sodium lighting etc., the colours and screen brightness may change or horizontal striping may appear on the screen.

### 4K photo recording stops before finishing.

- When the ambient temperature is high or recording with [ ] ([4K Burst]) or [ ] ([4K Burst(S/S)]) of the 4K Photo function is performed continuously, the camera may display [ ] and stop the recording to protect itself. Wait until the camera cools down.

### Cannot record motion pictures.

- When a large capacity card is used, you may not be able to take a picture for a while after you turn on the camera.

### Motion picture recording stops midway.

- When the ambient temperature is high or motion picture is recorded continuously, the camera may display [ ] and stop the recording to protect itself. Wait until the camera cools down.

### The screen turns momentarily black or noise is recorded.

- While motion pictures are being recorded, the screen may momentarily turn black or noise may be recorded due to static electricity or strong electromagnetic waves (radio transmitters, high-voltage lines, etc.) under some environmental conditions.

### Sometimes focus adjustment with Auto Focus mode is difficult while recording 4K motion pictures.

- This may occur when taking a picture by reducing the Auto Focus speed in order to adjust the focus at high precision. This is not a malfunction.

### No flash emitted.

The flash becomes unavailable in the following cases.

- The flash is closed.
- When the electronic shutter is used  
→ Set [Shutter Type] to [AUTO] or [MSHTR].
- When [Silent Mode] is set to [ON]  
→ Set [Silent Mode] to [OFF].

**The flash fires twice.**

- The flash fires twice. (Except when [Firing Mode] (→52) of [Flash] is set to [MANUAL]) When red-eye reduction is set, the firing interval will be longer. Make sure that the subject does not move until the second firing is completed.

**Cannot view pictures. There are no recorded pictures.**

- A card is not inserted in the camera.
- There is no picture on the card to play back.
- Has the file name of the picture been changed on a computer? If so, it cannot be played back on the camera.  
→ It is recommended to use the "PHOTOfunSTUDIO" software in the DVD (supplied) to write pictures from PC to card. (→47)
- [Playback Mode] (→53) is set to other than [Normal Play].  
→ Set [Playback Mode] to [Normal Play].

**Folder/file number displayed as [-]. Picture is black.**

- Is this a non-standard picture, a picture which has been edited using a PC or a picture which was taken by another device?
- Battery removed immediately after picture taken, or picture taken with low battery.  
→ Save needed data on a computer or other device, and then use [Format] on the camera. (→16)

**[Thumbnail is displayed] is shown on the screen.**

- The pictures may have been recorded on another device. If so, they may be displayed with poor picture quality.

**Motion pictures taken with this camera cannot be played in other cameras.**

- Even if a motion picture is played back on a compatible device, it may have bad picture quality or sound quality upon playback, or it may not be played back. Also, the recording information may not be displayed correctly.

**It cannot connect to the wireless LAN. Radio waves get disconnected. Wireless access point is not displayed.**

**General tips for using a Wi-Fi connection**

- Use within the communication range of the wireless LAN network.
- Is any device, such as microwave oven, cordless phone, etc., that uses 2.4 GHz frequency operated nearby?  
→ Radio waves may get interrupted when used simultaneously. Use them sufficiently away from the device.
- When the battery indicator is flashing red, the connection with other equipment may not start or the connection may be disrupted. (A message such as [Communication error] is displayed.)
- When this unit is placed on a metal table or shelf, the connection may not be established easily because the camera is affected by radio waves. Use the camera away from metal surfaces.



### **It cannot connect to the wireless LAN. Radio waves get disconnected. Wireless access point is not displayed. (continued)**

#### **About a wireless access point**

- Check if the wireless access point to connect is in operating state.
- The camera may not display or connect to a wireless access point depending on the radio wave condition.
  - Perform the connection closer to the wireless access point.
  - Remove the obstacles between this unit and the wireless access point.
  - Change the direction of this unit.
  - Move the location or change the angle of the wireless access point.
  - Perform the [Manual Input].
- It may not display even if the radio waves exist depending on the setting of the wireless access point.
- Is the network SSID of the wireless access point set not to broadcast?
  - It may not be detected when it is set not to broadcast. Enter and set the network SSID. Alternatively, set the network SSID of the wireless access point to broadcast.
- Connection types and security setting methods are different depending on the wireless access point.
  - Refer to the operating instructions of the wireless access point.
- Is the 5 GHz/2.4 GHz switchable wireless access point connected to other equipment using the 5 GHz band?
  - The use of a wireless access point that can use 5 GHz/2.4 GHz simultaneously is recommended. It cannot be used simultaneously with this camera if it is not compatible.

#### **The camera cannot be connected to Mac computer/Windows PC via Wi-Fi connection.**

- When the system time of Mac computer or Windows PC connected to a camera differs severely from that of the camera, the camera cannot be connected to the computer or PC in some OSs. Please confirm clock set and world time of the camera matches with time, date and time zone in Windows PC or Mac computer. When both settings do not match severely, please match them.

#### **I am having a problem connecting to my Windows 8 PC. The user name and password are not recognised.**

- Depending on the OS version, on Windows 8, for example, there are two types of user account (local account/Microsoft account).
  - Be sure to set the local account and use the user name and password for the local account.

#### **The Wi-Fi connection is not recognising my PC.**

- By default, the Wi-Fi connection uses the default workgroup name of "WORKGROUP". If the name of the workgroup has been changed, it will not be recognised.
  - Select [PC Connection] then [Change Workgroup Name] in the [Wi-Fi Setup] to change the workgroup name to match that of your PC.

**Pictures cannot be transmitted to the computer.**

- If a firewall is enabled by the OS or security software, this unit may be unable to connect to the computer.

**Transmission of the image fails midway. There is an image that could not be transmitted.**

- Image cannot be transmitted when the battery indicator is flashing red.
- Is the size of the image too large?
  - Divide the motion picture using [Video Divide]. (→53)
  - Reduce the image size at [Size], and then send.
- File format of the picture that can be sent differs depending on the destination.
- Capacity or number of images in the WEB service is full.
  - Login to "LUMIX CLUB", and check the status of the destination on the WEB service link settings.

**Cannot play motion pictures on TV.**

- Card is inserted into TV.
  - Connect with AV cable (optional) or HDMI micro cable and play on camera.

**VIERA Link (HDMI) is not working.**

- Is the HDMI micro cable connected correctly?
  - Check that the HDMI micro cable is fully inserted.
- Is the camera's [VIERA Link] setting set to [ON]?
  - The input setting may not be able to be changed automatically with certain television HDMI sockets. In this case, please change the input setting with your television's remote control (consult your television's operating instructions for details).
  - Check the VIERA Link (HDMI) settings on the device you are connecting to.
  - Turn the camera off and on again.
  - Turn the "VIERA Link control (HDMI device control)" setting on your television (VIERA) to off and then to on again. (Consult your VIERA's operating instructions for details.)

**The lens makes a clicking noise.**

- When the camera is turned on or off, the lens is moved, or an aperture operation is performed, such a noise may be heard. This is not a malfunction.
- When the brightness changes after a zooming operation or moving the camera, the lens may make a noise while adjusting the aperture. This is not a malfunction.

**Zooming stops instantaneously.**

- When using the Extra Optical Zoom, the zooming action will stop temporarily. This is not a malfunction.

**Camera is hot.**

- Camera may become a little warm during use, but this does not affect performance or quality.

**Clock is incorrect.**

- If you do not use the camera for a long time, the clock may be reset.
  - Reset the clock (→17).

## Specifications

### Digital Camera: Information for your safety

<b>Power Source</b>	DC 8.4 V (≈ 8.4 V)
<b>Power</b>	2.1 W (When recording with monitor)
<b>Consumption</b>	2.4 W (When recording with viewfinder)
	1.6 W (When playing back with monitor)
	1.6 W (When playing back with viewfinder)

<b>Camera effective pixels</b>	12,100,000 pixels
<b>Image sensor</b>	1/2.3" MOS sensor, total pixel number 12,800,000 pixels Primary colour filter
<b>Lens</b>	Optical 24x zoom f=4.5 mm to 108 mm (35 mm film camera equivalent: 25 mm to 600 mm) Max. Wide: F2.8 to F8.0 (When recording motion pictures: F2.8 to F11) Max. Tele: F2.8 to F8.0 (When recording motion pictures: F2.8 to F11) Filter diameter $\Phi$ 52 mm
<b>Image Stabiliser</b>	Optical method
<b>Focus range</b>	AF: 30 cm (0.98 feet) (Max. Wide) / 2 m (6.6 feet) (Max. Tele) to $\infty$ AF Macro / MF / Intelligent Auto / Motion picture: 1 cm (0.033 feet) (Max. Wide) / 1 m (3.3 feet) (Max. Tele) to $\infty$
<b>Shutter system</b>	Electronic shutter + Mechanical shutter
<b>Minimum Illumination</b>	Approx. 9 lx (when i-Low light is used, the shutter speed is 1/25th of a second)
<b>Shutter speed</b>	Still picture: B (Bulb) (Max. approx. 60 seconds), 60 seconds to 1/4000th of a second (When the mechanical shutter is used), 1 second to 1/16000th of a second (When the electronic shutter is used) Motion picture: 1/25th of a second to 1/16000th of a second, 1/2 second to 1/16000th of a second (When [M] is selected in Creative Video Mode, MF)

<b>Exposure (AE)</b>	Programme AE (P) / Aperture-priority AE (A) / Shutter-priority AE (S) / Manual exposure (M) / AUTO Exposure Compensation (1/3 EV steps, -3 EV to +3 EV)
<b>[Metering Mode]</b>	Multiple/Centre weighted/Spot
<b>Monitor</b>	3.0" TFT LCD (3:2) (Approx. 1,040,000 dots) (field of view ratio about 100%) Touch screen
<b>Viewfinder</b>	0.39" OLED Live Viewfinder (4:3) (Approx. 1,440,000 dots) (field of view ratio about 100%) [Magnification approx. 3.88x, 0.7x (35 mm film camera equivalent), with 50 mm lens at infinity; -1.0 m <sup>-1</sup> ] (with diopter adjustment -4.0 to +4.0 diopter)
<b>Flash</b>	Built-in pop up flash AUTO, AUTO/Red-Eye Reduction, Forced ON, Forced ON/Red-Eye Reduction, Slow Sync., Slow Sync./Red-Eye Reduction, Forced OFF
<b>Microphones</b>	Stereo
<b>Speaker</b>	Monaural
<b>Recording media</b>	SD Memory Card / SDHC Memory Card* / SDXC Memory Card* * UHS-I UHS Speed Class 3
<b>Recording file format</b>	
<b>Still picture</b>	RAW/JPEG (based on Design rule for Camera File system, based on Exif 2.3 standard / DPOF corresponding)
<b>Motion picture</b>	AVCHD Progressive / AVCHD / MP4
<b>Audio compression format</b>	AVCHD: Dolby® Digital (2 ch) MP4: AAC (2 ch)
<b>Interface</b>	
<b>Digital</b>	USB 2.0 (High Speed) Data from the PC can not be written to the camera using the USB connection cable.
<b>Analogue video</b>	NTSC / PAL Composite (Switched by menu)
<b>Audio</b>	Audio line output (Monaural)
<b>Terminal</b>	
<b>[REMOTE]</b>	Φ2.5 mm jack
<b>[HDMI]</b>	MicroHDMI Type D
<b>[AV OUT/DIGITAL]</b>	Dedicated jack (8 pin)
<b>[MIC]</b>	Φ3.5 mm jack

<b>Dimensions</b>	Approx. 131.6 mm (W) x 91.5 mm (H) x 117.1 mm (D) [5.18" (W) x 3.60" (H) x 4.61" (D)] (excluding the projection part)
<b>Mass</b>	With card and battery: Approx. 691 g (1.52 lb) Excluding card and battery: Approx. 640 g (1.41 lb)
<b>Operating temperature</b>	0 °C to 40 °C (32 °F to 104 °F)
<b>Operating humidity</b>	10%RH to 80%RH
<b>Dust-proof and splash-proof</b>	Yes

#### ■ Wi-Fi

<b>Compliance standard</b>	IEEE 802.11b/g/n (standard wireless LAN protocol)
<b>Frequency range used (central frequency)</b>	2412 MHz to 2462 MHz (1 to 11 ch)
<b>Encryption method</b>	Wi-Fi compliant WPA™/WPA2™
<b>Access method</b>	Infrastructure mode

#### ■ Battery Charger (Panasonic DE-A80A):

Information for your safety

<b>Input:</b>	AC~110 V to 240 V, 50/60 Hz, 0.2 A
<b>Output:</b>	DC ≡ 8.4 V, 0.65 A

#### ■ Battery Pack (lithium-ion) (Panasonic DMW-BLC12E):

Information for your safety

<b>Voltage/capacity:</b>	7.2 V/1200 mAh
--------------------------	----------------

The symbols on this product (including the accessories) represent the following:

~	AC
≡	DC
□	Class II equipment (The construction of the product is double-insulated.)

Specifications are subject to change without notice.

## Digital Camera Accessory System

Description	Accessory#
Battery pack	DMW-BLC12
AC adaptor*1	DMW-AC10
DC coupler*1	DMW-DCC8
Lens adaptor	DMW-LA7
Tele conversion lens*2	DMW-LT55
Close-up lens*2	DMW-LC55
MC protector	DMW-LMC52
ND filter	DMW-LND52
PL filter (Circular type)	DMW-LPL52
Flash	DMW-FL360L / DMW-FL580L
LED video light	VW-LED1
Shutter remote control	DMW-RSL1
Stereo shotgun microphone	DMW-MS2
Stereo microphone	VW-VMS10
AV cable	DMW-AVC1
USB connection cable	DMW-USBC1

\*1 The AC adaptor (optional) can only be used with the designated Panasonic DC coupler (optional).  
The AC adaptor (optional) cannot be used by itself.

\*2 The lens adaptor (DMW-LA7: optional) is necessary to attach a tele conversion lens or close-up lens.

- Part numbers are as of July 2015. These may be subject to change.
- Some optional accessories may not be available in some countries.

### Sales and Support Information

#### Customer Communications Centre

- For customers within the U.K.: 0344 844 3899
- For customers within Ireland: 01 289 8333
- Monday - Friday 9:00am - 5:00pm (Excluding public holidays).
- For further support on your product, please visit our website:  
[www.panasonic.co.uk](http://www.panasonic.co.uk)

#### Direct Sales at Panasonic U.K.

- Order accessory and consumable items for your product with ease and confidence by phoning our Customer Communications Centre  
Monday - Friday 9:00am - 5:00pm (Excluding public holidays).
- Or go on line through our Internet Accessory ordering application at  
[www.pas-europe.com](http://www.pas-europe.com).
- Most major credit and debit cards accepted.
- All enquiries transactions and distribution facilities are provided directly by Panasonic U.K.
- It couldn't be simpler!
- Also available through our Internet is direct shopping for a wide range of finished products. Take a browse on our website for further details.

- SDXC Logo is a trademark of SD-3C, LLC.
- HDMI, the HDMI Logo, and High-Definition Multimedia Interface are trademarks or registered trademarks of HDMI Licensing LLC in the United States and other countries.
- HDAVI Control™ is a trademark of Panasonic Holdings Corporation.
- “AVCHD”, “AVCHD Progressive” and the “AVCHD Progressive” logo are trademarks of Panasonic Holdings Corporation and Sony Corporation.
- Manufactured under license from Dolby Laboratories.  
Dolby and the double-D symbol are trademarks of Dolby Laboratories.
- Adobe is a trademark or registered trademark of Adobe Systems Incorporated in the United States and/or other countries.
- Windows and Windows Vista are either registered trademarks or trademarks of Microsoft Corporation in the United States and/or other countries.
- Mac and Mac OS are trademarks of Apple Inc., registered in the U.S. and other countries.
- iPad, iPhone, iPod, and iPod touch are trademarks of Apple Inc., registered in the U.S. and other countries.
- App Store is a service mark of Apple Inc.
- Android and Google Play are trademarks or registered trademarks of Google Inc.
- The Wi-Fi CERTIFIED™ Logo is a certification mark of Wi-Fi Alliance®.
- The Wi-Fi Protected Setup™ Identifier mark is a certification mark of Wi-Fi Alliance®.
- “Wi-Fi®” and “Wi-Fi Direct®” are registered trademarks of Wi-Fi Alliance®.
- “Wi-Fi Protected Setup™”, “WPA™”, and “WPA2™” are trademarks of Wi-Fi Alliance®.
- DLNA, the DLNA Logo and DLNA CERTIFIED are trademarks, service marks, or certification marks of the Digital Living Network Alliance.
- QR Code is a registered trademark of DENSO WAVE INCORPORATED.
- This product uses “DynaFont” from DynaComware Corporation. DynaFont is a registered trademark of DynaComware Taiwan Inc.
- Other names, company names, and product names mentioned in these instructions are trademarks or registered trademarks of the companies concerned.



**AVCHD**™  
Progressive



Manufactured by:  
Panasonic Entertainment & Communication Co., Ltd.  
1-10-12, Yagumo-higashi-machi, Moriguchi City, Osaka, Japan

Importer for UK:  
Panasonic UK, a branch of Panasonic Marketing Europe GmbH Maxis 2, Western  
Road, Bracknell, Berkshire, RG12 1RT

Importer for EU:  
Panasonic Marketing Europe GmbH  
Authorized Representative in EU:  
Panasonic Testing Centre  
Winsbergring 15, 22525 Hamburg, Germany



---

Panasonic Entertainment & Communication Co., Ltd.  
Web Site: <http://www.panasonic.com>

© Panasonic Entertainment & Communication Co., Ltd. 2015