

Panasonic®

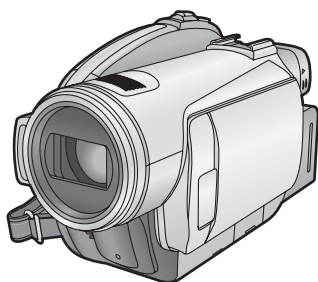

Operating Instructions High Definition Video Camera

Model No. **HDC-SX5**

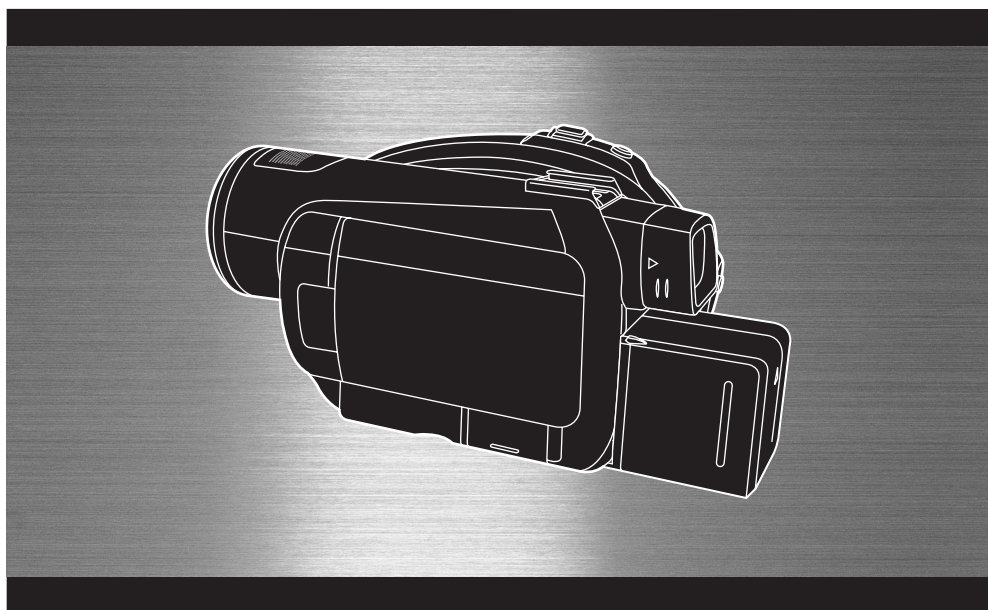

Before use, please read these instructions completely.

AVCHD



HDMI™
HIGH-DEFINITION MULTIMEDIA INTERFACE



**LEICA
DICOMAR**

**VIERA
Link**

EP

Web Site: <http://www.panasonic-europe.com>

VQT1G62

Information for Your Safety

WARNING:

TO REDUCE THE RISK OF FIRE, ELECTRIC SHOCK OR PRODUCT DAMAGE,

- DO NOT EXPOSE THIS APPARATUS TO RAIN, MOISTURE, DRIPPING OR SPLASHING AND THAT NO OBJECTS FILLED WITH LIQUIDS, SUCH AS VASES, SHALL BE PLACED ON THE APPARATUS.
- USE ONLY THE RECOMMENDED ACCESSORIES.
- DO NOT REMOVE THE COVER (OR BACK); THERE ARE NO USER SERVICEABLE PARTS INSIDE. REFER SERVICING TO QUALIFIED SERVICE PERSONNEL.

CAUTION!

- DO NOT INSTALL OR PLACE THIS UNIT IN A BOOKCASE, BUILT-IN CABINET OR IN ANOTHER CONFINED SPACE. ENSURE THE UNIT IS WELL VENTILATED. TO PREVENT RISK OF ELECTRIC SHOCK OR FIRE HAZARD DUE TO OVERHEATING, ENSURE THAT CURTAINS AND ANY OTHER MATERIALS DO NOT OBSTRUCT THE VENTILATION VENTS.
- DO NOT OBSTRUCT THE UNIT'S VENTILATION OPENINGS WITH NEWSPAPERS, TABLECLOTHS, CURTAINS, AND SIMILAR ITEMS.
- DO NOT PLACE SOURCES OF NAKED FLAMES, SUCH AS LIGHTED CANDLES, ON THE UNIT.
- DISPOSE OF BATTERIES IN AN ENVIRONMENTALLY FRIENDLY MANNER.

The socket outlet shall be installed near the equipment and easily accessible.

The mains plug of the power supply cord shall remain readily operable.

To completely disconnect this apparatus from the AC Mains, disconnect the power supply cord plug from AC receptacle.

EMC Electric and magnetic compatibility

This symbol (CE) is located on the rating plate.

Use only the recommended accessories.

- Do not use any other AV cables, Component cable and USB cables except the supplied one.
- When you use the cable which are sold separately, please make sure to use the one whose length is less than 3 metres.
- Keep the Memory Card out of reach of children to prevent swallowing.

**CLASS 1
LASER PRODUCT**

IEC60825-1:2001

CAUTION

This product contains a laser diode of higher class than 1.

To ensure continued safety, do not remove any covers or attempt to gain access to the inside of the product. Refer all servicing to qualified personnel.

Product Identification Marking is located on the bottom of units.

Information on Disposal for Users of Waste Electrical & Electronic Equipment (private households)



This symbol on the products and/or accompanying documents means that used electrical and electronic products should not be mixed with general household waste.

For proper treatment, recovery and recycling, please take these products to designated collection points, where they will be accepted on a free of charge basis. Alternatively, in some countries you may be able to return your products to your local retailer upon the purchase of an equivalent new product.

Disposing of this product correctly will help to save valuable resources and prevent any potential negative effects on human health and the environment which could otherwise arise from inappropriate waste handling. Please contact your local authority for further details of your nearest designated collection point.

Penalties may be applicable for incorrect disposal of this waste, in accordance with national legislation.

For business users in the European Union

If you wish to discard electrical and electronic equipment, please contact your dealer or supplier for further information.

Information on Disposal in other Countries outside the European Union

This symbol is only valid in the European Union.

If you wish to discard this product, please contact your local authorities or dealer and ask for the correct method of disposal.

Indemnity concerning recording content

The manufacturer shall in no event be liable for the loss of recordings due to malfunction or defect of this unit, its accessories or recordable media.

Carefully observe copyright laws

Recording of pre-recorded tapes or discs or other published or broadcast material for purposes other than your own private use may infringe copyright laws. Even for the purpose of private use, recording of certain material may be restricted.

- SDHC Logo is a trademark.
- miniSD Logo is a trademark.
- "AVCHD" and the "AVCHD" logo are the trademarks of Matsushita Electric Industrial Co., Ltd. and the Sony Corporation.
- Manufactured under license from Dolby Laboratories. Dolby and the double-D symbol are trademarks of Dolby Laboratories.
- "HDMI", the HDMI Logo and the High-Definition Multimedia Interface are the registered trademarks or trademarks of HDMI Licensing LLC.
- HDAVI Control™ is a trademark of Matsushita Electric Industrial Co., Ltd.
- LEICA is a registered trademark of Leica Microsystems IR GmbH and DICOMAR is a registered trademark of Leica Camera AG.
- Microsoft®, Windows®, Windows Vista™ and DirectX® are either registered trademarks or trademarks of the Microsoft Corporation in the United States and/or other countries.
- IBM and PC/AT are registered trademarks of International Business Machines Corporation of the U.S.
- Intel®, Core™, Pentium® and Celeron® are the registered trademarks or trademarks of the Intel Corporation in the United States and other countries.
- Microsoft product screen shot(s) reprinted with permission from Microsoft Corporation.
- Other names of systems and products mentioned in these instructions are usually the registered trademarks or trademarks of the manufacturers who developed the system or product concerned.

This product is licensed under the AVC patent portfolio license for the personal and non-commercial use of a consumer to (i) encode video in compliance with the AVC Standard ("AVC Video") and/or (ii) decode AVC Video that was encoded by a consumer engaged in a personal and non-commercial activity and/or was obtained from a video provider licensed to provide AVC Video. No license is granted or shall be implied for any other use. Additional information may be obtained from MPEG LA, LLC.

See <http://www.mpegla.com>.

Contents

Information for Your Safety	2
-----------------------------------	---

Before using

Features of the High Definition Video Camera	7
Accessories	11
Parts identification and handling	12
Using the LCD monitor	16
Using the viewfinder	16
Using the remote control	17
Discs that can be used on this unit ...	19
Cards that you can use with this unit	24
Disc and card handling	26

Setup

Charging the battery	27
Fitting/Removing the battery	28
Charging and recording time	29
Connecting to the AC outlet	32
Selecting a mode (Turning the unit on/off)	33
Quick start	35
Inserting/removing a disc	36
Inserting/removing an SD card	38
How to use the cursor button	39
Switching the language	44
Using the menu screen	45
Setting date and time	46
Adjusting LCD monitor/viewfinder	47

Recording

Before recording	50
Recording motion pictures	52
PRE-REC function	54
Recording modes/recordable time available for the motion picture	55
Recording still pictures (JPEG)	57
Number of pixels and picture quality for still picture recording	59
Various recording functions	60
Zoom in/out function	60
Recording yourself	62
Intelligent contrast control	62
Fade in/fade out function	63
Colour night view function	64
Soft skin mode	65
Backlight compensation function	65
Self-timer recording	66
Built-in flash	67
Tele macro function	69
Image stabilizer function	69
Guide line function	70
Wind noise reduction function	71
Microphone level	71
Zebra display	72
Colour bar	73
Auto slow shutter mode	73
Manual recording functions	74
Scene mode	74
Manual focus adjustment	75
White balance	76
Manual shutter speed/aperture adjustment	77

Playback

Playback of motion pictures	79
Playback of still pictures (JPEG) on an SD card	84

Editing

Editing scenes	86
Deleting scenes	86
Dividing a scene to delete	87
Protecting scenes	88
Copying from an SD card to a disc ...	89
Editing still pictures	90
Deleting still pictures	90
Protecting still pictures	92
DPOF setting	92

Disc and card management

Formatting	94
Formatting discs	94
Formatting SD cards	94
Finalizing a disc	95
Finalizing a disc	95
Un-finalizing a DVD-RW	96
Creating a top menu	97
Protecting a disc	98
Disc protection setting	99
Displaying disc information	100

With other products

With a TV	101
Playback on TV	101
Playback using VIERA Link (HDAVI Control)	107
With Blu-ray Disc Player, DVD recorder, DVD player, computer etc.	109
Playback using Blu-ray Disc Players	109
Playback on DVD recorder, DVD player, computer etc.	109
With a DVD recorder or video device	110
Dubbing images onto a connected DVD recorder or video device	110
With a printer (PictBridge)	111

With a computer

Before using with a computer	113
What you can do with a computer	113
Contents on provided CD-ROM	114
End User License Agreement	115
Operating environment	116
Installation	118
Installing HD Writer 2.0E for SX/SD	118
Reading the operating instructions of the software applications	119
Software application uninstallation	119
Connection and recognition	120
Connection and recognition procedures	120
About the computer display	121
To disconnect USB cable safely	123
Verifying the unit is correctly recognised by the computer	124
Using HD Writer 2.0E for SX/SD	125
If using a Macintosh	129

Others

Menus and Indications	130
Menu list	130
Indications	135
Messages	137
Functions that cannot be used simultaneously	140
Frequently asked questions	141
Troubleshooting	142
Cautions for use	152
Explanation of terms	155
Specifications	157

Before using

Features of the High Definition Video Camera

Very clear high definition pictures

This unit can record highly detailed high definition images to an 8 cm DVD disc or an SD card. You can watch images in high-resolution HD video if you connect this unit and a high definition TV and then play back the images. (→ 101)

You can also record to a conventional standard picture quality 8 cm DVD disc by rotating the mode dial. Playback is possible on existing devices that do not support AVCHD.

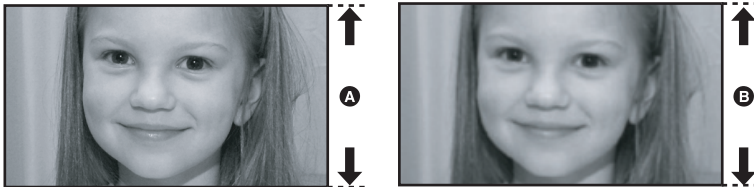

A High Definition images (1920×1080)*:

Number of available scan lines 1080

B Standard images until now (720×480):

Number of available scan lines 480

High definition images

• The still pictures above are images for explanation purposes.

* If the recording mode is HG

What is the AVCHD?

This is a format for recording and playing back highly detailed high definition images.

Images are recorded based on the MPEG-4 AVC/H.264 codec for compressing images and audio is recorded in Dolby Digital. It is compatible with various discs such as DVD-RAM, DVD-RW, DVD-R and DVD-R DL. (→ 21, About recording formats in conventional standard picture quality)

Important Notice

Do not insert discs which have been recorded in AVCHD format into devices which do not support the AVCHD format. In some cases the disc may get stuck in the device. The disc will not play back on devices that do not support the AVCHD format.

About the SDHC Memory Card and the compatibility of motion pictures recorded in high definition (Be careful about the following.)

About the SDHC Memory Card

- It is not compatible with devices other than those that support SDHC.
- If you use the SDHC Memory Card in another device, use a device that is SDHC compatible. (→ 24)

About the compatibility of discs recorded in HD mode (high definition picture quality) on this unit

- They are not compatible with devices other than those that support AVCHD. (Refer to the operating instructions of the device for details.)
- There are some cases where the recorded motion pictures cannot be played back, even if the device supports AVCHD. In such cases, play the recorded motion picture with this unit instead.
- Do not insert them into devices that are not compatible (DVD players, computers, etc. that do not support AVCHD) as they will not be played back.
- A format message may appear when you insert a disc into a device that is not compatible. (If you accidentally format the disc, the pictures you recorded will all be deleted.)
- We recommend setting [AUTO PROTECT] to [ON] (→ 98) to prevent important scenes being deleted by mistake. (This function's default setting is [ON].)

Existing DVD recorders, DVD players, computers, etc. that do not support AVCHD.

- Discs recorded in STD mode can be played back on devices other than those that support AVCHD. (→ 109)

Watching High Definition images

If you connect this unit and a high definition TV **A** with a HDMI cable (optional) **B** and then play back the pictures, you can enjoy watching them in high definition.

- Pictures recorded in STD mode cannot be played back.

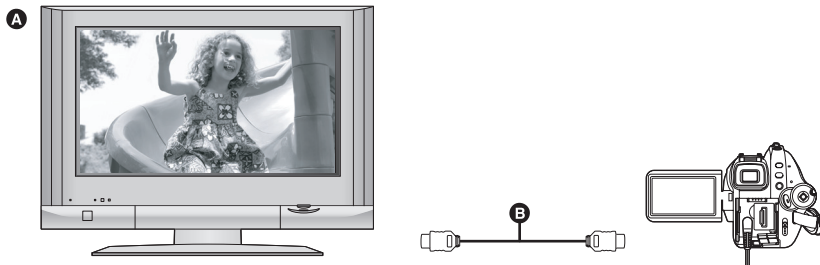

- If you connect this unit to a TV that does not support high definition, the images will be standard picture quality.

When connecting to a TV that does not have a HDMI terminal

Connecting with the component cable and the AV cable (→ 104)

- Pictures recorded in STD mode cannot be played back.

Connecting with the AV cable (→ 105)

- The pictures cannot be played in high definition. They will be played back in standard picture quality.

Using the remote control for the TV for playback

If you connect this unit to a Panasonic TV (VIERA) compatible with VIERA Link (HDAVI Control™) **A** with a HDMI cable (optional) **B**, you can use the remote control for the TV for playback. Refer to the operating instructions of the TV for details.

- Pictures recorded in STD mode cannot be played back.

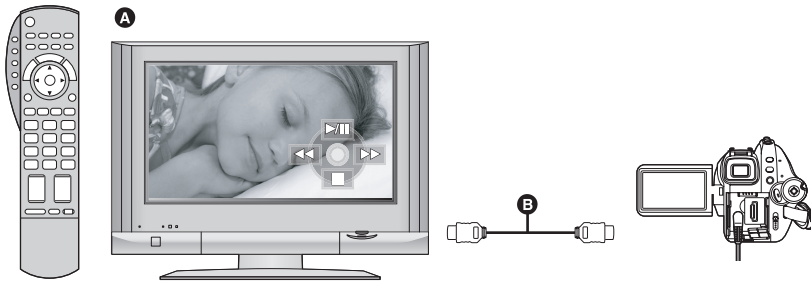

■ What is the VIERA Link?

- This function allows you to use your VIERA remote control for easy operations when this unit has been connected to a VIERA Link compatible device using a HDMI cable (optional) for automatic linked operations.
- * Not all operations are possible.
- VIERA Link is a unique Panasonic function built on a HDMI control function using the standard HDMI CEC (Consumer Electronics Control) specification. Linked operations with HDMI CEC compatible devices made by other companies are not guaranteed.
- This unit is compatible with VIERA Link Ver.2. VIERA Link Ver.2 is the newest Panasonic version and is also compatible with existing Panasonic VIERA Link devices. (As of February 2007)

■ Other linked operations

Turning off the power on the TV

If you turn off the power on the TV with the remote control for the TV, the power on this unit also turns off.

Automatic input switching:

If you connect with a HDMI cable and then turn on the power on this unit, the input channel on the TV automatically switches to this unit's screen. If the TV's power is in standby status, it will turn on automatically (if [Set] has been selected for the TV's [Power on link] setting).

- Depending on HDMI terminal of the TV, the input channel may not switch automatically. In this case, use the remote control for the TV to switch input. (For details on how to switch input, please read the operating instructions for the TV.)

Saving data to a computer

You can use the supplied software (HD Writer 2.0E for SX/SD) to copy data recorded on a disc or an SD card with this unit to the hard disk of the computer.

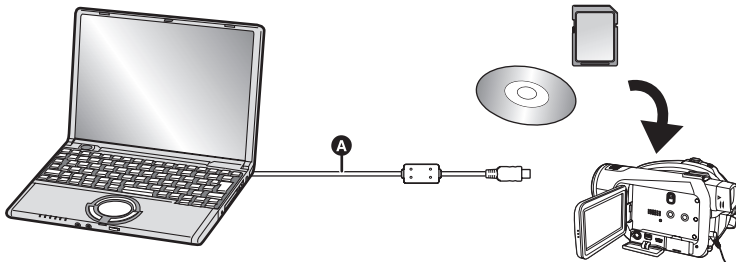

A USB cable (supplied)

What you can do with HD Writer

Copying data to a computer

You can copy data on a disc or an SD card to the hard disk of the computer.

Writing data to media

You can copy motion picture data from the hard disk of the computer to an SD card or a disc.

Copying between media

You can copy motion picture data from an SD card to a disc or from a disc to an SD card.

Playing back on a computer

You can play back the images in high definition picture quality on a computer.

Easy editing

You can easily edit (split, merge, delete etc.) motion picture data that was copied to the hard disk of the computer. Also, you can convert data to MPEG2 format and create a DVD-Video.

- For details on how to use the software application, read the PDF operating instructions.

Important Notice

Do not insert a disc recorded in AVCHD format with the supplied HD Writer 2.0E for SX/SD in a device that does not support the AVCHD format. In some cases the disc may get stuck in the device. The disc will not play back on devices that do not support the AVCHD format.

The SD Media Storage

The SD Media Storage (VW-PT2: optional) is convenient if you are on the move. It is an extremely compact, lightweight and easy to carry HDD (hard disk).

- If you insert an SD card with recorded motion pictures and still pictures in the SD Media Storage, the data can easily be saved to the SD Media Storage by pressing the copy button only.
- You can save all the data from approximately ten 4 GB cards to its 40 GB HDD capacity.



Accessories

Check the accessories before using this unit.

Battery pack

VW-VBG260



AC adaptor

VW-AD21E



DC cable

K2GJYYC00001



AV cable

K2KC4CB00024



Component cable

K2KZ9DB00004



AC cable

K2CQ2CA00006



Remote control

N2QAEC000023

Button-type battery

CR2025

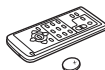

USB cable

K2KZ4CB00011



CD-ROM



Optional accessories

Some optional accessories may not be available in some countries.

AC adaptor (VW-AD21E-K)
Battery pack (lithium/VW-VBG260/2640 mAh)
Battery pack (lithium/VW-VBG130/1320 mAh)
Battery pack (lithium/VW-VBG6*/5800 mAh)
Battery pack holder kit (VW-VH04)
Wide conversion lens (VW-W3707H)
Tele conversion lens (VW-T3714H)
Filter kit (VW-LF37WE)
Video DC light (VW-LDH3E)
Light bulb for video DC light (VW-LL3E)
Stereo zoom microphone (VW-VMH3E)
Video flash (VW-FLH3E)
Tripod (VW-CT45E)
8 cm DVD-RAM disc (single sided/LM-AF30E)
8 cm DVD-RAM disc (double sided/LM-AF60E)
8 cm DVD-RW disc (single sided/LM-RW30E)
8 cm DVD-RW disc (double sided/LM-RW60E)
8 cm DVD-R disc (single sided/LM-RF30E)
8 cm DVD-R disc (double sided/LM-RF60E)
8 cm DVD-R DL disc (dual rayers on single side/LM-RF55LE)

* The battery pack holder kit VW-VH04 (optional) is necessary.

Parts identification and handling

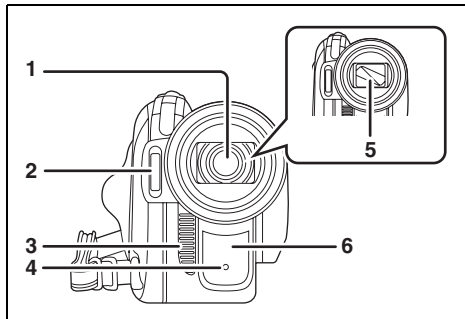

- 1 Lens (LEICA DICOMAR)
- 2 Built-in flash (→ 67)
- 3 Outlet
- 4 Recording lamp (→ 133)
- 5 Lens cover
- 6 White balance sensor/remote control sensor (→ 18, 77)

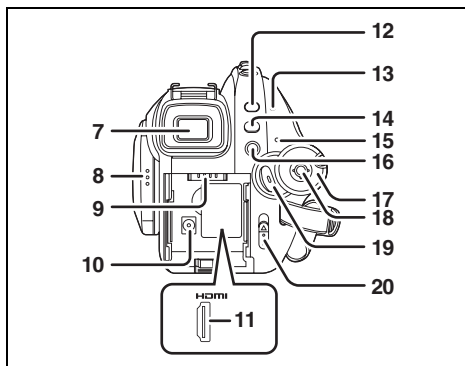

- 7 Viewfinder (→ 16)

Due to limitations in LCD production technology, there may be some tiny bright or dark spots on the viewfinder screen. However, this is not a malfunction and does not affect the recorded picture.

- 8 LCD monitor open part (→ 16)
- 9 Battery holder (→ 28)
- 10 DC input terminal [DC IN 9.3V] (→ 32)
- 11 HDMI terminal [HDMI] (→ 102, 107)
- 12 PRE-REC button [PRE-REC] (→ 54)

- 13 Disc/computer access lamp [ACCESS/PC] (→ 36)
- 14 Menu button [MENU] (→ 45)
- 15 Status indicator (→ 33)
- 16 Delete button [⏮] (→ 86, 90)
- 17 Mode dial (→ 33)
- 18 Cursor button (→ 39)
- 19 Recording start/stop button (→ 52)
- 20 Disc eject lever [DISC EJECT] (→ 36)

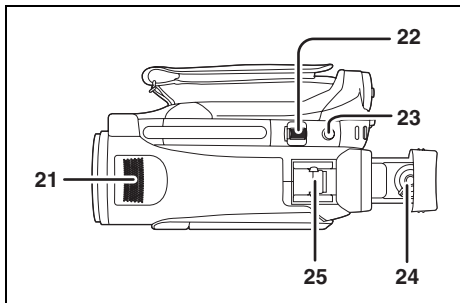

- 21 Internal stereo microphones
- 22 Zoom lever [W/T] (In recording mode) (→ 60)
- Volume lever [-VOL+] (In playback mode) (→ 83)
- 23 Photoshot button [📷] (→ 57)
- 24 Eyepiece corrector knob (→ 49)
- 25 Smart accessory shoe (→ 15)
 - Accessories, such as a video DC light/VW-LDH3E (optional), are attached here.

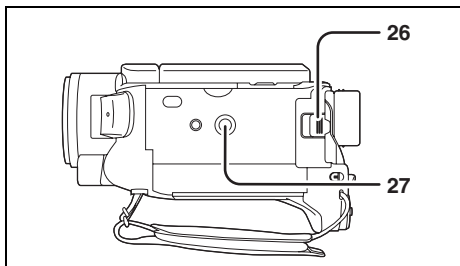

- 26 Battery release lever [BATTERY] (→ 28)
- 27 Tripod receptacle (→ 15)

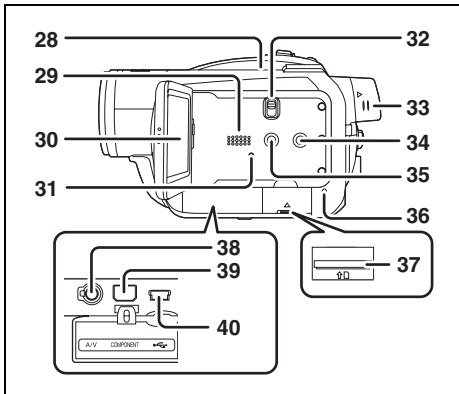

28 Inlet (cooling fan)

About the cooling fan

- The cooling fan rotates to prevent the internal temperature rising. Take care not to cover the inlet and outlet when using this unit.

29 Speaker

30 LCD monitor (→ 16)

Due to limitations in LCD production technology, there may be some tiny bright or dark spots on the LCD monitor screen. However, this is not a malfunction and does not affect the recorded picture.

31 Reset button [RESET] (→ 147)

32 Mode select switch [AUTO/MANUAL/ FOCUS] (→ 51, 74)

33 Viewfinder extension knob (→ 16)

34 DISC COPY button [DISC COPY] (→ 89)

35 Power LCD EXTRA button [POWER LCD EXTRA] (→ 48)

36 Card access lamp [ACCESS] (→ 39)

37 Card slot (→ 28)

38 Audio-video output terminal [A/V] (→ 104, 105, 110)

- Use the supplied AV cable only.

39 Component terminal [COMPONENT] (→ 104)

40 USB terminal [↔] (→ 111, 120)

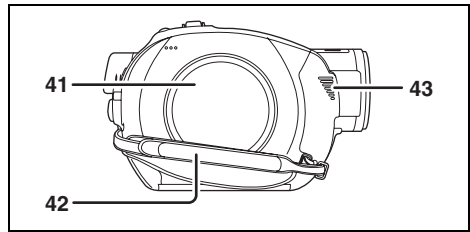

41 Disc compartment (→ 36)

42 Grip belt (→ 13)

43 Outlet

Using grip belt

Adjust the belt length so it fits your hand.

Adjust the belt length and the pad position.

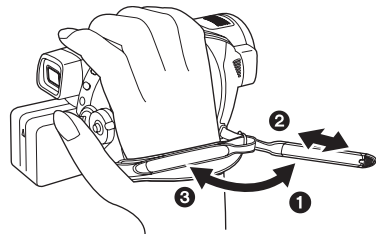

1 Flip the belt.

2 Adjust the length.

3 Replace the belt.

Lens hood

Rotate the lens hood counter-clockwise **A** to remove it. In order to attach it, place into slot **B**, and then rotate it clockwise **C**.

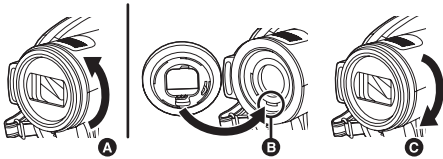

- Attach the MC protector or the ND filter of the Filter Kit (VW-LF37WE; optional) in front of the lens hood. Do not attach the other accessories on the hood. (Except for the lens cap) (Refer to the operating instructions for the Filter Kit.)
- When fitting the tele conversion lens (VW-T3714H; optional) or the wide conversion lens (VW-W3707H; optional), first remove the lens hood. (Refer to the operating instructions for the tele conversion lens or the wide conversion lens.)

(Be careful about the following.)

When 2 lens accessories, such as the ND filter and tele conversion lens, are fitted and the zoom lever is pressed toward the W side, the 4 corners of an image will be darkened. (Vignetting)
(When fitting 2 lens accessories, first remove the lens hood and then fit them.)

Attaching the lens cap (Included in the Filter Kit (VW-LF37WE; optional))

Attach the lens cap to protect the surface of the lens.

- When the MC protector or the ND filter of the Filter Kit (VW-LF37WE; optional) is attached to the front of the lens hood, use the lens cap included in the Filter Kit.

1 Pass the end of the lens cap cord through the belt.

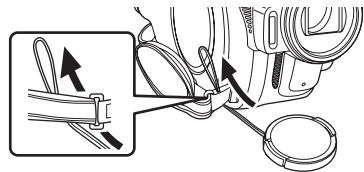

2 Pass the lens cap through the loop.

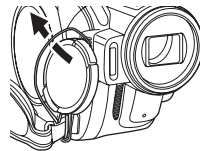

3 To attach or remove the lens cap, hold both sides of the lens cap with the tips of your finger and thumb.

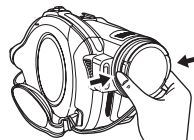

Smart accessory shoe

You can mount an optional microphone, light etc.

- When using an accessory for the smart accessory shoe, the power is supplied from this product.

Connect to the smart accessory shoe.

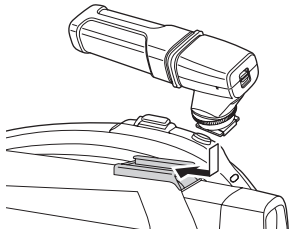

If using an accessory for the smart accessory shoe, be sure to use the following.

- Stereo zoom microphone (VW-VMH3E; optional)
- Video DC light (VW-LDH3E; optional)
- Video flash (VW-FLH3E; optional)
- Mounting an accessory for the smart accessory shoe other than the above may cause the unit to malfunction.
- When the AC adaptor or the battery pack (VW-VBG130; optional) is used, you cannot use the video DC light.

Tripod receptacle

This is a hole for attaching the unit to the optional tripod.

(Please carefully read the operating instructions for how to attach the unit to the tripod.)

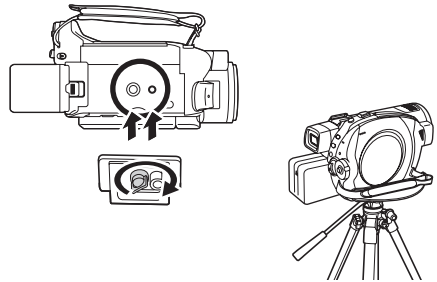

- When a tripod is used, you can perform operations easily using the remote control. (→ 17)

Using the LCD monitor

You can record the image while viewing it on the LCD monitor.

- 1 Place your finger on LCD monitor open part and pull the LCD monitor out in the direction of the arrow.**

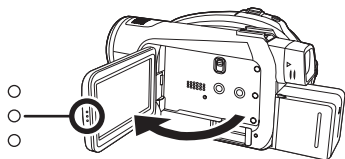

- It can open up to 90°.

- 2 Adjust the angle of the LCD monitor as desired.**

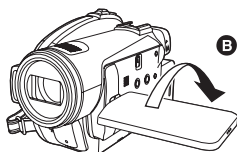
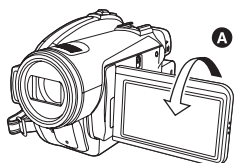

- It can rotate up to 180° **A** towards the lens or 90° **B** towards the viewfinder.

- The brightness and colour level of the LCD monitor can be adjusted. (→ 47)
- The unit may be damaged or fail if the LCD monitor is forcibly opened or rotated.
- If the LCD monitor is rotated by 180° towards the lens and the viewfinder is extended (when recording yourself), the LCD monitor and the viewfinder simultaneously light.

Using the viewfinder

Pull out the viewfinder.

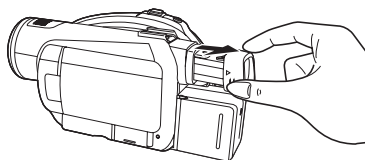

- The brightness of the viewfinder (→ 47) and the field of view can be adjusted. (→ 49)

Using the remote control

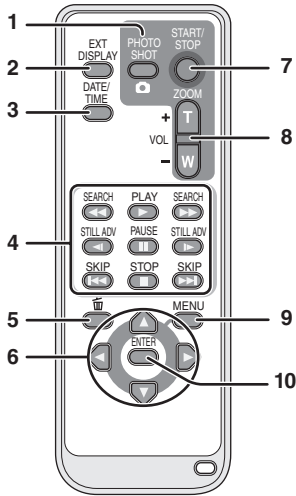

- 1 Photoshot button []*
- 2 On-screen display button [EXT DISPLAY] (→ 101)
- 3 Date/time button [DATE/TIME] (→ 47)
- 4 Playback operation buttons (→ 81, 82)
- 5 Delete button []*
- 6 Direction buttons [▲, ▼, ◀, ▶] (→ 46)
- 7 Recording start/stop button [START/STOP]*
- 8 Zoom/volume buttons [ZOOM, VOL]*
- 9 Menu button [MENU]* (→ 46)
- 10 Enter button [ENTER] (→ 46)

* means that these buttons function in the same manner as the corresponding buttons on the unit.

Install a button-type battery

Install the supplied button-type battery in the remote control before using it.

- 1 While pressing the stopper **A**, pull out the battery holder.

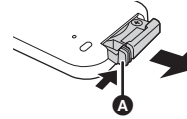

- 2 Set the button-type battery with its (+) mark facing upward and then put the battery holder back in place.

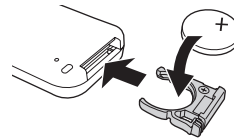

Concerning the button-type battery

- When the button-type battery runs down, replace it with a new battery (part number: CR2025). The battery should normally last about 1 year, however this depends on how frequently the unit is used.

CAUTION

Danger of explosion if battery is incorrectly replaced. Replace only with the same or equivalent type recommended by the manufacturer. Dispose of used batteries according to the manufacturer's instructions.

Warning

Risk of fire, explosion and burns. Do not recharge, disassemble, heat above 60 °C or incinerate.

Warning

Keep the Button-Type battery out of the reach of children. Never put Button-Type battery in mouth. If swallowed call your doctor.

■ Remote control usable range



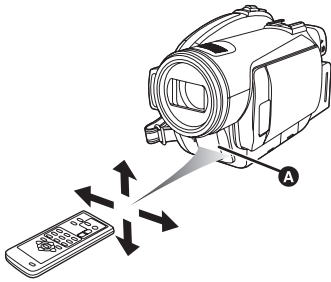

The distance between the remote control and the unit's remote control sensor **A**: Within approx. 5 m

Angle: Approx. 10° up and 15° down, left, and right











-
- The remote control is intended for indoor operation. Outdoors or under strong light, the unit may not operate properly even within the usable ranges.

Discs that can be used on this unit

	DVD-RAM 8 cm Single sided/ double sided	DVD-RW 8 cm Single sided/ double sided	DVD-R 8 cm Single sided/ double sided	DVD-R DL 8 cm Dual layer on single side
Disc type	 R A M R A M 4.7	 R W 2X/1X	 R R 4.7	 R R DL
	(DVD-RAM Ver. 2.1)	[DVD-RW Ver. 1.1/ 2X-SPEED (2X/ 1X)]	(DVD-R for General Ver. 2.0)	(DVD-R for DL Ver. 3.0)

■ If recording in high definition picture quality (HD mode)

Disc type	DVD-RAM	DVD-RW	DVD-R	DVD-R DL
Recording format	AVCHD format	AVCHD format	AVCHD format	AVCHD format
Characteristic	Rewritable disc	Rewritable disc*1	One time recording disc	One time recording disc
Display on the screen				
Indication in these instructions				
Functions				
• Deleting recorded scenes	●	●*2	●*2	●*2
• Playback on other products*3	●	●*4	●*4	●*4
• Recording after finalizing	●*5	●*6	—	—

●: available —: not available

*1 By formatting the disc, it can be used repeatedly. Please be aware that if a disc is formatted, then all the data recorded on the disc will be erased and it cannot be restored. (→ 94)

*2 The remaining space on the disc will not increase even if scenes are deleted.











*3 Products that support 8 cm discs and the AVCHD.

*4 Must be finalized on this unit. (→ 95)

*5 Does not need to be finalized.

*6 Un-finalize the disc. (→ 96)

■ If recording in conventional standard picture quality (STD mode)

Disc type	DVD-RAM	DVD-RW		DVD-R	DVD-R DL
Recording format	DVD Video Recording format (VR format)	DVD Video Recording format (VR format)	DVD-Video format (Video format)	DVD-Video format (Video format)	DVD-Video format (Video format)
Characteristic	Rewritable disc	Rewritable disc	Rewritable disc*1	One time recording disc	One time recording disc
Display on the screen					
Indication in these instructions					
Functions					
● Deleting recorded scenes	●	●	—	—	—
● Editing on this unit	●	●	—	—	—
● Playback on other products*2	●*3	●*4	●*5	●*5	●*5, 6
● Recording after finalizing	●*7	●	●*8	—	—

●: available —: not available

*1 By formatting the disc, it can be used repeatedly. Please be aware that if a disc is formatted, then all the data recorded on the disc will be erased and it cannot be restored. (→ 94)

*2 DVD player or DVD recorder that supports 8 cm discs.

*3 Can only be played back on a device that supports DVD-RAM.

*4 Must be finalized on this unit. (→ 95) Playback of DVD-RW (VR format) is possible on compatible products.

*5 Must be finalized on this unit. (→ 95)

*6 Can only be played back on a device that supports DVD-R DL.

*7 Does not need to be finalized.

*8 Un-finalize the disc. (→ 96)

- **Still pictures cannot be recorded on a disc with this unit.**
- You cannot record or play continuously from one side of the disc to the other when using a double sided disc. You will need to eject the disc and turn it over.
- Discs inserted in a holder, cartridge, or caddy case cannot be used. Always remove bare discs from these containers prior to use.
- It is recommended that you use Panasonic discs. Usually discs compatible with the DVD standard can be used for recording and playback with no problems. However, some commercially available discs do not meet the DVD standard for quality and performance. If you use one of these discs, you may not be able to record or playback normally. (The message "FOR BEST PERFORMANCE PANASONIC DISC IS RECOMMENDED." appears.) Refer to the following support site for information about discs that have been confirmed as compatible by Panasonic.
http://panasonic.jp/support/global/cs/e_cam
(This website is in English only.)
- **(HD mode) Discs recorded in high definition picture quality with this unit may not be playable on other devices even if the other devices support AVCHD. In such cases, play back the discs with this unit instead.**
- (STD mode) Recording on DVD-R in DVD Video Recording format is not supported.
- **When using DVD-RW, DVD-R or DVD-R DL do not perform the following as it may make the disc unusable.**
 - Record on a disc with other products after recording on it with this unit.
 - Record on a disc with this unit after recording on it with other products.
 - Insert an un-finalized disc in any other products.

■ About recording formats in conventional standard picture quality

What is the DVD Video Recording format (VR format)?

This is a recording format which allows you to erase recorded images and use one disc repeatedly. You can also edit images. You can record on DVD-RAM and DVD-RW in VR format with this unit.

What is the DVD-Video format (Video format)?

By finalizing the disc, it can be played back on most DVD players. You can record on DVD-RW and DVD-R in Video format with this unit.

- Refer to P7 about the recording format of high definition picture quality.

■ About DVD-R DL (dual layer on single side)

DVD-R DL (dual layer on single side) discs have two layers of recording and playback surface on one side. If the recording does not fit on the first layer (L0), it continues on the second layer (L1). In this case, the recording continues across two layers.

In STD mode, the recording is divided into two scenes at the point where the layers switch. This unit automatically switches layers during disc playback so you can play back the whole of the disc continuously like a normal disc. However, the picture or the sound may momentarily stop at the point where the layers switch.

Examples of discs that cannot be used on this unit

- Discs other than those with diameter of 8 cm
- Dual layer on single side discs other than DVD-R DL
- +RW
- +R
- DVD-ROM
- CD-RW
- CD-R
- CD-ROM
- CD

When using brand-new DVD-RAM or DVD-RW

◇ HD mode

When using DVD-RAM or DVD-RW, format the disc.

When a brand-new DVD-RAM or DVD-RW is inserted in this unit, the screen shown in the illustration may be displayed.

Move the cursor button up or down to select [YES], then press the cursor button.



◇ STD mode

When using DVD-RW, select whether to record in DVD Video Recording format (VR format) or DVD-Video format (Video format) and then format the disc. (→ 21, About recording formats in conventional standard picture quality)

When a brand-new DVD-RW is inserted in this unit, the screen shown in the illustration may be displayed.

1 Move the cursor button left or right to select [YES], then press the cursor button.



2 Select format type, then press the cursor button.



[VIDEO]: DVD-Video format

[VR]: DVD Video Recording format

3 When the confirmation message appears, select [YES], then press the cursor button.

- If the disc is formatted, then all the data recorded on the disc will be erased.
- To change the format type, format the disc again. (→ 94)

When inserting a disc recorded on another device or in another mode

When a DVD-RAM or a DVD-RW recorded on another device or in another mode is inserted in this unit, the screen shown in the illustration may be displayed.

If the disc is formatted (→ 94), then it can be used. However, all the data recorded on the disc will be erased. Check the data before formatting.

- DVD-R or DVD-R DL recorded on another device cannot be formatted and used for recording.

◇ HD mode

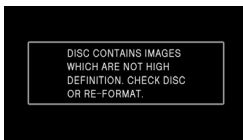

- First format the disc in HD mode. (→ 94)

◇ STD mode

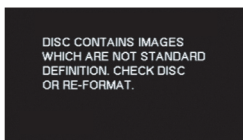

- First format the disc in HD mode, then format it again in STD mode and use it. (→ 94)

Cards that you can use with this unit

Card type	SD Memory Card			SDHC Memory Card
	Capacity	8 MB, 16 MB	32 MB, 64 MB, 128 MB	
Motion picture recording	Cannot be used.	Cannot be guaranteed in operation.*	Refer to "About SD cards that you can use for motion picture recording".	
Still picture recording	Can be used.			

* The recording may suddenly stop during motion picture recording depending on the SD card you use. (→ 53)

- Functions that can be used for motion picture recording/motion picture playback using an SD card are indicated by **VIDEO** and functions that can be used for still picture recording/still picture playback using an SD card are indicated by **PHOTO** in these operating instructions.

This unit (an SDHC compatible device) is compatible with both SD Memory Cards and SDHC Memory Cards. You can use SDHC Memory Cards on devices that are compatible with them. However, you cannot use SDHC Memory Cards on devices that are only compatible with SD Memory Cards. (When using an SDHC Memory Card on another device, always read the operating instructions of that device.)

About SD cards that you can use for motion picture recording

We recommend using SD Memory cards and SDHC Memory cards conforming to Class 2 or higher of the SD Speed Class Rating or the following SD cards made by Panasonic for motion picture recording.

Card type	Pro High Speed SD Memory Card	Super High Speed SD Memory Card	High Speed SD Memory Card	SDHC Memory Card
256 MB	—	RP-SDH256*1	RP-SDR256	—
512 MB	RP-SDK512*1	RP-SDH512*1	RP-SDR512	—
1 GB	RP-SDK01G*1 RP-SDV01G	RP-SDH01G*1	RP-SDQ01G*1 RP-SDR01G	—
2 GB	RP-SDK02G*1 RP-SDV02G	—	RP-SDQ02G*1 RP-SDR02G*1 RP-SDM02G	—
4 GB	—	—	—	RP-SDM04G RP-SDR04G*1 RP-SDV04G
8 GB	—	—	—	RP-SDV08G*2

*1 No longer made.

*2 Available from Sep. 2007

- Operation in motion picture recording is not guaranteed with an SD card memory from 32 MB to 8 GB except the cards above. (The recording may suddenly stop during motion picture recording.)
- Please confirm the latest information about SD Memory Cards/SDHC Memory Cards that can be used for motion picture recording on the following website.

http://panasonic.jp/support/global/cs/e_cam

(This website is in English only.)

- For the purposes of these operating instructions, SD Memory Card and SDHC Memory Card are referred to as the "SD card".
- This unit supports SD Memory Cards formatted in FAT12 system and FAT16 system based on SD Memory Card Specifications and SDHC Memory Cards formatted in FAT32 system.
- If you wish to use Memory Cards that are 4 GB and 8 GB, only SDHC Memory Cards can be used.
- 4 GB (or more) Memory Cards that do not have the SDHC logo are not based on SD Memory Card Specifications.
- Use this unit to format SD cards. If an SD card is formatted on other products (such as a computer), the time spent for recording may become longer and you may not be able to use the SD card. (→ 94) **(Do not format it on a PC etc.)**
- When the write-protect switch **A** on the SD card is locked, no recording, deletion or editing will be possible on the card.
- Keep the Memory Card out of reach of children to prevent swallowing.
- A MultiMediaCard cannot be used on this unit.

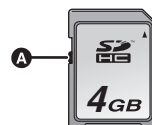

Disc and card handling

How to hold a disc or card

Do not touch the recorded surface or the terminal surface.



When inserting/removing a disc

Do not allow fingerprints or dirt to get on the recording/playback side of the disc.

- If there are scratches or dirt (e.g. dust or fingerprints) on the recording/playback side of the disc, normal recording/playback may not be possible and the following kind of phenomena may occur:
 - Recording/playback is not possible.
 - The image or the sound is interrupted or stops momentarily.
 - Noise appears on the image or the sound.
 - The message “NO DATA.”, “PLEASE CHECK THE DISC.”, “CHECK THE DISC AFTER PUSHING THE RESET SWITCH TO REPAIR IT.”, etc. appears.

If there is dirt on the disc

- Clean it with a soft cloth. Wipe the disc from the centre to the outer edge to remove the dirt. Do not use force when wiping the disc as it may scratch it. Also, do not use solvents (thinner, water, antistatic agent, detergent etc.).



Handling precautions

- Be careful about scratches and dirt.
- Do not attach labels or stickers to discs. (This may cause disc warping and un-balanced rotation, rendering it unusable.)
- Write on the label side of the disc only with a soft, oil-based felt pen. Do not use ballpoint pens or other hard writing implements.

- Do not use record cleaning sprays, benzine, thinner, static electricity prevention liquids or any other solvent.
- Do not use scratch-proof protectors or covers.
- Do not drop, stack, or impact discs. Do not place objects on them.
- Do not use the following discs:
 - Discs with exposed adhesive from removed stickers or labels.
 - Discs that are badly warped or cracked.
 - Irregularly shaped discs, such as heart shapes.

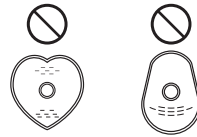

- Do not expose the terminals of the card to water, garbage or dust.
- Do not place in the following areas:
 - In direct sunlight.
 - In very dusty or humid areas.
 - Near a heater.
 - Locations susceptible to significant difference in temperature (condensation can occur).
 - Where static electricity or electromagnetic waves occur.
- To protect discs and cards, return them to their cases when you are not using them.

Setup

Charging the battery

When this unit is purchased, the battery is not charged. Charge the battery before using this unit.

- **If the DC cable is connected to the AC adaptor, then the battery will not charge. Remove the DC cable from the AC adaptor.**
- **Refer to page 29 concerning batteries that can be used with this unit.**

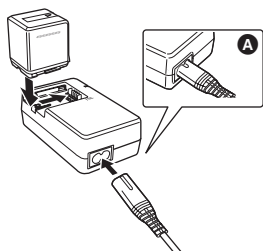

1 Connect the AC cable to the AC adaptor and the AC outlet.

- Remove the DC cable beforehand.

2 Put the battery on the battery mount by aligning the mark, and then securely plug it in.

- The output plug of the AC cable is not completely connected to the AC adaptor socket. As shown in **A**, there is a gap.

■ Charging lamp

Lights up:

Charging

Goes off:

Charging completed

Flashing:

Make sure that the terminals of the battery or the AC adaptor are not exposed to dirt, foreign objects or dust, then reconnect them properly. Disconnect the AC cable from the AC outlet when you remove dirt, foreign objects or dust on the terminals of the battery or the AC adaptor.

If the charging lamp is still flashing, something may be wrong with the battery or AC adaptor. Contact your dealer.

- Battery charging time (→ 29)
- We recommend using Panasonic batteries (→ 11, 29).
- If you use other batteries, we cannot guarantee the quality of this product.

Fitting/Removing the battery

Fitting the battery

Push the battery against the battery holder and slide it until it clicks.

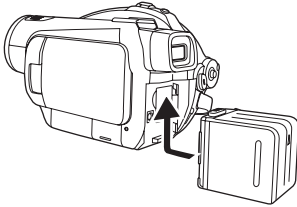

Removing the battery

While sliding the BATTERY lever, slide the battery to remove it.

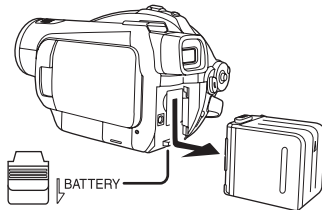

- Hold the battery with your hand so it does not fall.
- Before removing the battery, be sure to set the Mode dial to OFF and check that the status indicator is off.

CAUTION

Danger of explosion if battery is incorrectly replaced. Replace only with the same or equivalent type recommended by the manufacturer. Dispose of used batteries according to the manufacturer's instructions.

Warning

Risk of fire, explosion and burns. Do not disassemble, heat above 60 °C or incinerate.

Notice about the rechargeable battery

The battery is designated recyclable. Please follow your local recycling regulations.

Charging and recording time

About batteries that you can use with this unit

The Panasonic battery that can be used with this unit is VW-VBG260/VW-VBG6/VW-VBG130.

VW-VBG260/VW-VBG6/VW-VBG130 come with a function to check whether the battery and unit can be safely used together.

- Batteries made by other companies which have been certified by Panasonic may be used with this unit, but we offer no guarantee as to the quality, performance or safety of such batteries.
- In order to safely use the unit we recommend that you use genuine Panasonic batteries which have been subject to our quality control process.
- We cannot accept any liability whatsoever for damages to the unit or accidents caused by non-genuine Panasonic batteries (including those that have been certified by Panasonic).
- Exercise care when purchasing batteries. Many fake or imitation batteries have been found among those sold at unusually low prices and those which customers cannot check for themselves before purchasing.

Charging time

The times shown in the tables below are for when the temperature is 25 °C and the humidity is 60%.

If the temperature is higher or lower than 25 °C, the charging time will become longer.

Battery model number	Voltage/capacity	Charging time
Supplied battery/ VW-VBG260 (optional)	7.2 V/2640 mAh	4 h
VW-VBG130 (optional)	7.2 V/1320 mAh	2 h 20 min
VW-VBG6 (optional)	7.2 V/5800 mAh	8 h 50 min

- The charging time shown in the table are approximations.
- "8 h 50 min" indicates 8 hours 50 minutes.

- When you charge a battery that has not been used for long time, the charging time will become longer.

Recordable time

- The times shown in the table below are for when the temperature is 25 °C and the humidity is 60%. These times are approximations. The times indicate the recordable time when the viewfinder is used. The times in parentheses indicate the recordable time when the LCD monitor is used.
- The actual recordable time refers to the recordable time on a disc when repeatedly starting/stopping recording, turning the unit on/off, moving the zoom lever, etc.

Battery model number	Voltage/capacity	Recording mode		Maximum continuously recordable time	Actual recordable time
Supplied battery/ VW-VBG260 (optional)	7.2 V/ 2640 mAh	Disc* (HD mode)	HG	2 h (1 h 55 min)	50 min (50 min)
			HN	2 h 10 min (2 h 5 min)	55 min (50 min)
			HE	2 h 20 min (2 h 10 min)	55 min (55 min)
		Disc* (STD mode)	XP	2 h 5 min (2 h)	55 min (55 min)
			SP	2 h 15 min (2 h 10 min)	55 min (55 min)
			LP	2 h 25 min (2 h 20 min)	1 h (55 min)
		SD card (HD mode)	HG	2 h 55 min (2 h 40 min)	1 h 45 min (1 h 40 min)
			HN	3 h	1 h 50 min (1 h 45 min)
			HE	(2 h 45 min)	(1 h 45 min)
VW-VBG130 (optional)	7.2 V/ 1320 mAh	Disc* (HD mode)	HG	1 h 5 min (1 h)	25 min (25 min)
			HN	1 h 10 min (1 h 5 min)	30 min (25 min)
			HE	1 h 15 min (1 h 10 min)	30 min (30 min)
		Disc* (STD mode)	XP	1 h 5 min (1 h 5 min)	30 min (25 min)
			SP	1 h 15 min (1 h 10 min)	30 min (30 min)
			LP	1 h 15 min (1 h 15 min)	30 min (30 min)
		SD card (HD mode)	HG	1 h 35 min (1 h 25 min)	55 min (55 min)
			HN	1 h 35 min	1 h (55 min)
			HE	(1 h 30 min)	(55 min)

Battery model number	Voltage/capacity	Recording mode		Maximum continuously recordable time	Actual recordable time
VW-VBG6 (optional)	7.2 V/ 5800 mAh	Disc* (HD mode)	HG	5 h (4 h 45 min)	2 h 5 min (2 h 15 min)
			HN	5 h 30 min (5 h 10 min)	2 h 15 min (2 h 10 min)
			HE	5 h 50 min (5 h 30 min)	2 h 25 min (2 h 15 min)
		Disc* (STD mode)	XP	5 h 15 min (5 h)	2 h 20 min (2 h 15 min)
			SP	5 h 45 min (5 h 30 min)	2 h 25 min (2 h 25 min)
			LP	6 h 5 min (5 h 50 min)	2 h 30 min (2 h 25 min)
		SD card (HD mode)	HG	7 h 15 min (6 h 45 min)	4 h 30 min (4 h 10 min)
			HN HE	7 h 30 min (7 h)	4 h 40 min (4 h 20 min)

* When using a DVD-RAM disc

- The recordable times shown in the table are approximations.
- "1 h 30 min" indicates 1 hour 30 minutes.

- The recordable times will vary depending on the status of use. These times are approximations. The recordable time will become shorter in the following cases:
 - When you use both the viewfinder and the LCD monitor simultaneously while rotating the LCD monitor frontward to record yourself, etc.
 - When you use this unit with the LCD monitor lit up by pressing the POWER LCD EXTRA button.
 - When you use accessories fitted on the unit's smart accessory shoe such as the stereo zoom microphone and video DC light, etc.
- The batteries heat up after use or charging. This unit will also heat up while being used. This is not a malfunction.
- Be aware that the operating time of the battery will become shorter in low temperatures. We recommend charging a spare battery for use when recording.

About the remaining battery capacity indication

The remaining battery capacity is displayed in minutes when using the Panasonic battery that you can use for this unit. It may take time to display the remaining battery capacity.

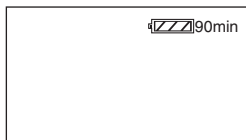

- The display changes as the battery capacity reduces.



If there are less than 3 minutes, then the battery symbol will become red. If the battery discharges, then the battery symbol will flash.

- The remaining battery capacity may not be displayed correctly where the temperature is low or high or if the battery was not used for a long period of time. To correctly display the remaining battery capacity, recharge the battery, discharge it and then charge it again. (Even if this operation is performed, it may not be possible to display the remaining battery capacity correctly if the battery was used for a long period of time where the temperature is low or high or if the battery was repeatedly charged.)
- The maximum amount of remaining battery capacity able to be indicated is 999 minutes. If the actual remaining time exceeds 999 minutes, the indication will stay green and will not change until the remaining time falls below 999 minutes.
- Depending on the conditions of use, the time displayed on the remaining battery capacity indication will change so use it as an approximation.
- When rotating the mode dial to switch modes, the time indication will turn off in order to recalculate the remaining battery capacity time.
- When using the AC adaptor or batteries made by other companies, the remaining battery capacity will not be shown.

Connecting to the AC outlet

The unit is in the standby condition when the AC adaptor is connected. The primary circuit is always "live" as long as the AC adaptor is connected to an electrical outlet.

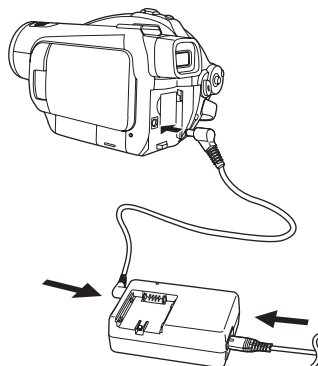

- 1 Connect the AC cable to the AC adaptor and the AC outlet.**
- 2 Connect the DC cable to the AC adaptor.**
- 3 Connect the DC cable to the DC input terminal DC IN 9.3V.**



- Do not use the AC cable with any other equipment as it is designed only for this unit. Do not use the AC cable from other equipment with this unit.
- While the DC cable is connected to the AC adaptor, the battery will not charge.

Selecting a mode (Turning the unit on/off)

Rotate the mode dial to switch to recording, playback or OFF.

- Rotate the mode dial slowly.

How to turn on the power

While pressing the lock release button, set the mode dial to ,  or .

- Rotate the mode dial while at the same time pressing in the lock release button **A** if changing from OFF to another mode.
- Align with the mark **B**.

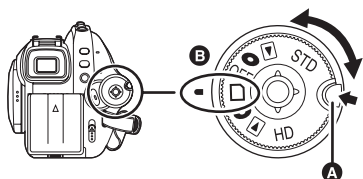

The status indicator lights and the power turns on.

- The lens cover opens in recording mode.
- When the unit is turned on for the first time, a message asking you to set the date and time will appear. Select [YES] and set the date and time. (→ 46)



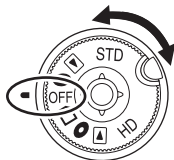

How to turn off the power

Set the mode dial to OFF.



The status indicator goes off and the power turns off.

- The lens cover closes when the mode dial is set to OFF.

STD mode		Disc Recording mode (→ 52) Use this to record motion pictures in standard picture quality on a disc.
		Playback mode (→ 80) Use this to play back motion pictures recorded in standard picture quality on a disc.
OFF		The power turns off.
HD mode		SD Card Recording mode (→ 52, 57) Use this to record motion pictures and still pictures in high definition picture quality on an SD card.
		Disc Recording mode (→ 52, 57) Use this to record motion pictures in high definition picture quality on a disc and still pictures in high definition picture quality on an SD card.
		Playback mode (→ 79, 84) Use this to play back motion pictures recorded in high definition picture quality on a disc and motion pictures and still pictures recorded in high definition picture quality on an SD card.



- Do not forcefully rotate the dial.
- If changing from HD mode to STD mode or STD mode to HD mode when a disc is inserted in this unit, first slide the DISC EJECT lever and then change the mode.

When the power is turned on for the first time after changing the disc or battery, the unit carries out a recognition procedure to check that there are no problems with the disc. If you want to start using the unit as soon as you turn on the power, do the following.

- 1 Turn on the power.
- 2 After "READING DISC..." disappears from the screen, turn off the power.

- Depending on the condition of the disc, it may take longer than this.
- If the date and time are not set, it will take longer than usual before you can start recording.

How to turn the power on and off with the LCD monitor/viewfinder

When the mode dial is set to  or , the power can be turned on and off with the LCD monitor and the viewfinder.

■ To turn on the power Open the LCD monitor or extend the viewfinder.

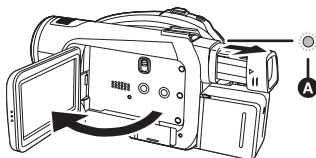

The status indicator **A** lights and the power turns on.

- It lights up when the viewfinder is extended with the LCD monitor closed. (When the LCD monitor is opened, the viewfinder turns off.)

■ To turn off the power Close the LCD monitor and retract the viewfinder.

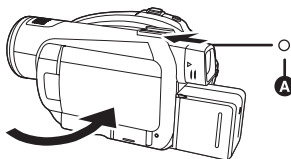

The status indicator **A** goes off and the power turns off. (If [QUICK START] (→ 35) is set to [ON], the unit goes into quick start standby mode and the status indicator flashes green.)

- The power will not turn off unless the LCD monitor is closed and the viewfinder is retracted.
- The power will not turn off while recording motion pictures even if the LCD monitor is closed and the viewfinder is retracted.

Set the mode dial to OFF when this unit is not being used.

Quick start

When quick start is ON the battery power is still being consumed, even when the LCD monitor and the viewfinder are closed.

This unit will resume recording/pause mode about 1.7 seconds after the LCD monitor and the viewfinder are reopened.

- When in quick start standby mode, about 70% of the power used in recording pause mode is being consumed so the recording time will be reduced.
- This is only activated in the following case.
 - When the mode dial is set to  and an SD card is inserted.

- 1 Press the MENU button, then select [SETUP] → [QUICK START] → [ON] and press the cursor button.

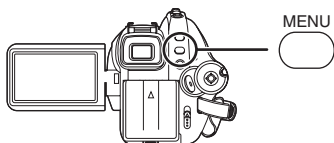

- 2 Close the LCD monitor and retract the viewfinder while the mode dial is set to  .

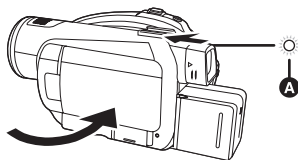

The status indicator  flashes green and the unit goes into quick start standby mode.

- The lens cover does not close.

- 3 Open the LCD monitor or extend the viewfinder.

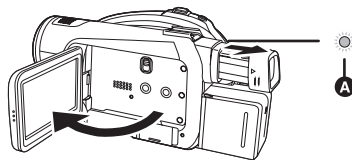

The status indicator  lights red and the unit is put into recording pause approx. 1.7 seconds after it is turned on.

To cancel Quick start

Press the MENU button, then select [SETUP] → [QUICK START] → [OFF] and press the cursor button.

- The status indicator goes off, the lens cover closes and the power turns off if the mode dial is set to OFF while the unit is in quick start standby mode.
 - The status indicator goes off and the power turns off if quick start standby mode continues for approx. 5 minutes.
-
- Quick start standby mode is cancelled, the status indicator goes off and the power turns off in the following cases.
 - the mode dial is switched
 - the battery is removed or the AC adaptor is disconnected
 - When this unit is quick-started with the white balance on automatic, it may take some time until the white balance is adjusted if the scene being recorded has a light source different from the scene last recorded. (When the colour night view function is used, however, the white balance of the scene last recorded is retained.)
 - When this unit is quick-started, the zoom magnification becomes 1× and the picture size may differ from what it was before quick start standby mode.
 - If [POWER SAVE] (→ 134) is set to [5 MINUTES] and the unit automatically goes into quick start standby mode, close the LCD monitor and then open it again.

Inserting/removing a disc

When inserting or removing the disc, fit the charged battery pack or connect the AC adaptor to the unit. The cover of the disc compartment will not open unless the unit is powered.

- 1 Attach the battery or connect the AC adaptor.**
- 2 Slide the DISC EJECT lever once and release it.**

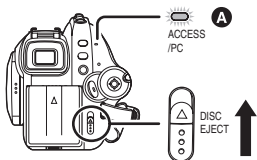

A few moments after the ACCESS/PC lamp **A** blinks, the cover of the disc compartment will open slightly.

- 3 Open the cover of the disc compartment by hand and insert/remove the disc.**

Inserting disc

Fit the disc onto the spindle in the centre.

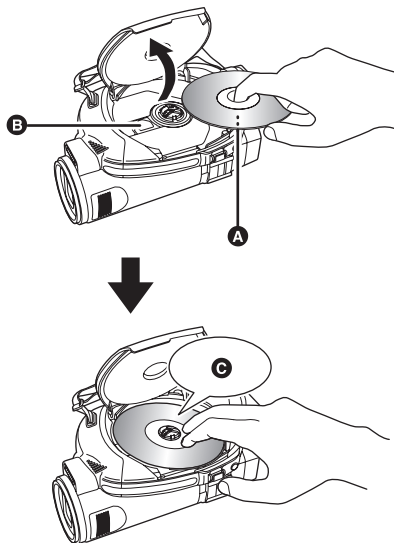

- A** Recording/playback side
 - B** Pickup lens
 - C** Press until it clicks.
- Be careful not to touch the recording/playback side of the disc when inserting/removing it.

Removing disc

While pressing down on the spindle, grasp the edge of the disc and gently lift it out.

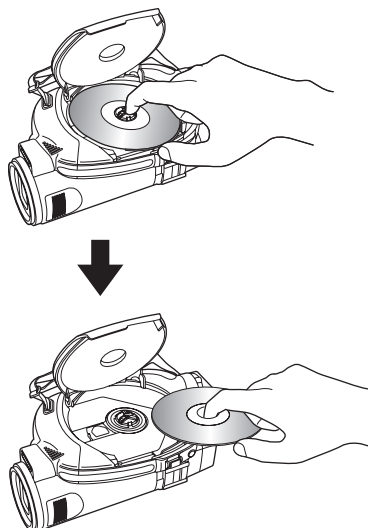

4 Push the section marked **PUSH CLOSE** on the cover of the disc compartment to close the cover.

- When using brand-new DVD-RAM or DVD-RW (→ 22)
- When inserting a disc recorded on another device or in another mode (→ 23)
- You cannot remove a disc while recording motion pictures on an SD card or in PRE-REC. (→ 54)

Identifying recording/playback sides of disc

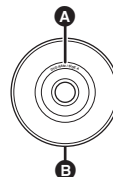

- A** "SIDE A" mark
- B** The opposite side is the "SIDE A" recording/playback side.

Single sided disc/dual layer on single side disc:

The recording/playback side is opposite to the labelled side.

Double sided disc:

The "SIDE A" recording/playback side is the side opposite the side with the "SIDE A" mark.

The "SIDE B" recording/playback side is the side with the "SIDE A" mark.

- Do not use excessive force when opening the cover.
- Do not touch the pickup lens or the recording/playback side of the disc.
This may impair recording and playback.
- Insert the disc securely to prevent damage.
- When you open the cover, the ACCESS/PC lamp flashes. Do not leave the cover open.
- If the cover is open, the power will not turn off even if the Mode dial is set to OFF.
- If the disc is not correctly inserted, the cover will not close. Never try to forcibly close the cover. This could cause damage. Reinsert the disc properly.
- If a single sided disc is inserted into the unit with the printed label facing the inside, an error message will appear. Remove the disc and reinsert it with its recording/playback side facing the inside.
- Do not allow the recording/playback side to become dirty or scratched.
- Do not remove the battery pack or disconnect the AC adaptor while removing the disc or until power is completely turned off. If you do, the cover will not open. If this happens, reattach the battery pack or reconnect the AC adaptor, slide the DISC EJECT lever once, and then

release it. A repair disc message may be displayed when the power is turned back on. (→ 139)

- Do not insert anything other than the 8 cm DVD-RAM, DVD-RW, DVD-R or DVD-R DL disc into the disc compartment. Doing so could cause malfunctions. (→ 22)
- Do not touch the pickup lens or other parts inside the disc compartment. Be sure not to touch the area around the pickup lens for it becomes extremely hot.

After inserting a disc/After recording finishes

While the ACCESS/PC lamp is lit, the disc is rotating and disc information is being recorded. If the power supply is interrupted at this time, the disc may become unusable. Do not disconnect the AC adaptor or remove the battery. Also, do not strongly shake or cause impact to the unit.

Inserting/removing an SD card

Be sure to set the mode dial to OFF before inserting/removing an SD card.

If the SD card is inserted or removed while the power is on, this unit may malfunction or the data recorded on the SD card may be lost.

1 Set the mode dial to OFF.

- Check that the status indicator has gone off.

2 Open the card slot cover.

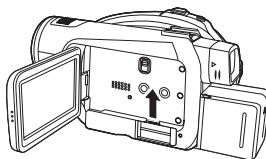

3 Insert/remove the SD card into/from the card slot.

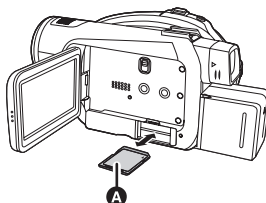

- When inserting an SD card, face the label side **A** upwards and press it straight in as far as it goes.
- When removing the SD card, press the centre of the SD card and then pull it straight out.

4 Securely close the card slot cover.

Concerning the SD card

- Do not touch the terminals on the back of the SD card.
- Electrical noise, static electricity or the failure of this unit or the SD card may damage or erase the data stored on the SD card. Save important data recorded on this unit to a PC using the USB cable (supplied), HD Writer 2.0E for SX/SD etc. (→ 125) (We recommend using HD Writer 2.0E for SX/SD to acquire data recorded on this unit.)
- When using an SD card on which data has been written many times, the remaining time left for recording may be reduced. (→ 53)

Card access lamp [ACCESS]

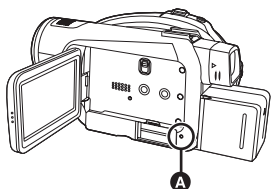

- When this unit accesses the SD card (reading, recording, playback, erasing, etc.), the access lamp **A** lights up.
- If the following operations are performed when the access lamp is lit, then the SD card or the recorded data may be damaged or this unit may malfunction.
 - Opening the card slot cover and removing the SD card
 - Operating the mode dial
 - Removing the battery or disconnecting the AC adaptor

How to use the cursor button

This unit has a cursor button **A** for selecting functions, performing operations, etc. so it is easy to operate this unit with one hand.

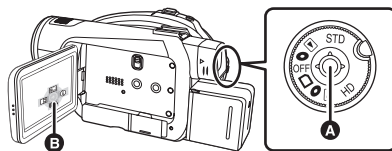

- **B** Operating the operation icons and menu screens that are displayed

Basic operations

Operations on the menu screen and selection of files on the thumbnail view screen, etc.

Move the cursor button up, down, left, or right to select an item or scene, and then press the cursor button to set it.



- 1** Select by moving up.
 - 2** Select by moving down.
 - 3** Select by moving left.
 - 4** Select by moving right.
 - 5** Press the cursor button to set the item.
- Menu screen operations (→ 45)

Operations during recording

- ◇ Rotate the mode dial to select  or .

- 1 Press the centre of the cursor button, and icons will be displayed on the screen.



- The indication disappears when the centre of the cursor button is pressed again.
- The indication changes each time the cursor button is moved down.

- 2 Move the cursor button up, left or right to select an item.

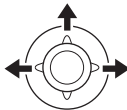

Operations during playback

- ◇ Rotate the mode dial to select .

- 1 Move the cursor button up, down, left or right to select the scene to be played back and press the cursor button.

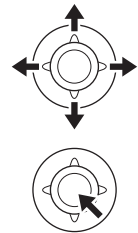

The selected scene is played back on the full screen. The operation icon is automatically displayed on the screen.

- 2 Move the cursor button up, down, left or right to operate.

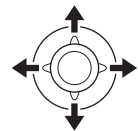

- The operation icon appears or disappears each time the centre of the cursor button is pressed.

About the operation icons displayed in each mode

HD Recording mode



Icon	Direction	Function	Page	
(1/3)		▲	Intelligent contrast control	62
		◀	Fade	63
		▶	Help mode	44
(2/3)		▲	Colour night view	64
		◀	Soft skin mode	65
		▶	Backlight compensation	65
(3/3)		▲	Self-timer recording	66
		◀	Flash	67
		▶	Tele macro	69

Set the AUTO/MANUAL/FOCUS switch to MANUAL.

In manual mode [MANUAL] (4/4)	<u>WB</u>	▲	White balance	76
	<u>IRIS</u>	◀	Iris or gain value	77
	<u>SHTR</u>	▶	Shutter speed	77

Set the AUTO/MANUAL/FOCUS switch to FOCUS.

In manual focus mode [FOCUS] (5/5)	<u>MF</u> <u>MF</u>	◀▶	Manual focus adjustment	75
--	---------------------	----	-------------------------	----

- The shaded operation icons are not displayed while recording.
- About switching between AUTO and MANUAL (→ 51)

STD Recording mode

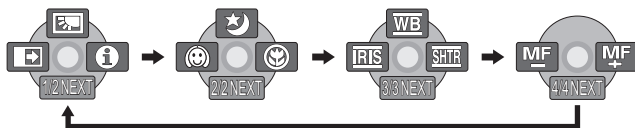

Icon	Direction	Function	Page	
(1/2)		▲	Backlight compensation	65
		◀	Fade	63
		▶	Help mode	44
(2/2)		▲	Colour night view	64
		◀	Soft skin mode	65
		▶	Tele macro	69

Set the AUTO/MANUAL/FOCUS switch to **MANUAL**.

In manual mode [MANUAL] (3/3)		▲	White balance	76
		◀	Iris or gain value	77
		▶	Shutter speed	77

Set the AUTO/MANUAL/FOCUS switch to **FOCUS**.

In manual focus mode [FOCUS] (4/4)		◀▶	Manual focus adjustment	75
--	--	----	-------------------------	----

- The shaded operation icons are not displayed while recording.
- About switching between AUTO and MANUAL (→ 51)

HD/STD Playback mode

▶ (In motion picture playback)

HD mode

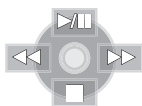

STD mode



Icon	Direction	Function	Page
▶/	▲	Playback/pause	79
■	▼	Stop playback and show thumbnails	79
◀◀	◀	Rewind (during playback)	79
◀		Reverse slow/frame playback (during pause)	82
▶▶	▶	Fast forward (during playback)	79
▶		Forward slow/frame playback (during pause)	82

HD Playback mode

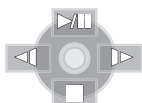

▶ (In still picture playback)



Icon	Direction	Function	Page
▶/	▲	Slide show start/pause	85
■	▼	Stop playback and show thumbnails	85
◀	◀	Playback previous picture (during pause)	85
▶	▶	Playback next picture (during pause)	85

Help mode

The help mode explains the operation icons displayed when the AUTO/MANUAL/FOCUS switch is set to AUTO in recording mode.

◇ Rotate the mode dial to select  or .

1 Press the cursor button to display the icon.

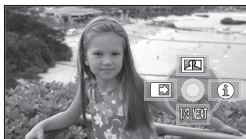

2 Move the cursor button right to select [].



3 Move the cursor button up, left or right to select the desired icon.

◇ HD mode



An explanation of the selected icon scrolls at the bottom of the screen.

◇ STD mode



An explanation of the selected icon is displayed on the screen.

- The indication changes each time the cursor button is moved down.

To exit the help mode

Press the MENU button or select [END] (HD mode)/[EXIT] (STD mode).



- When the help mode is used, functions cannot be set.
- When the help mode is used, motion pictures and still pictures cannot be recorded.

Switching the language

You can switch the language on the screen display or the menu screen.

1 Press the MENU button, then select [LANGUAGE] and press the cursor button.



2 Select [English] and press the cursor button.

Using the menu screen

Refer to "Menu list" (→ 130) for information about the menus.

1 While stopped, press the MENU button.



The menu displayed differs depending on the position of the mode dial.

- Do not switch the mode dial when the menu is displayed.

2 Move the cursor button up or down in order to select the desired top menu **A**.



3 Move the cursor button right or press the cursor button.

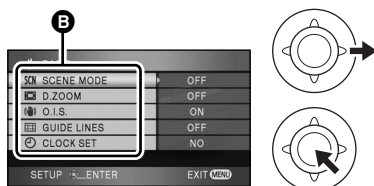

The submenu **B** is displayed.

4 Move the cursor button up or down in order to select the submenu item.

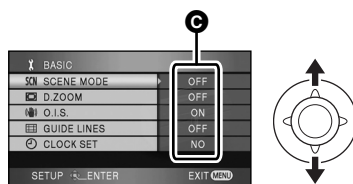

C Current settings on menus

5 Move the cursor button right or press the cursor button.

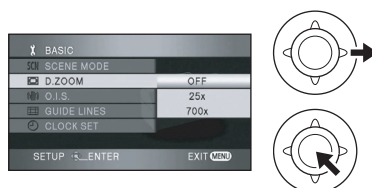

6 Move the cursor button up or down in order to select the desired item.



7 Press the cursor button to enter the selection.



To get back to the previous screen
Move the cursor button left.

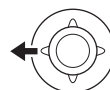

To exit the menu screen

Press the MENU button.



- The menu screen does not appear during recording or playing. You cannot start other operations while the menu screen appears.

Operating with remote control

The menu screen transition is the same as when the buttons on the main unit are used.

1 Press the MENU button.

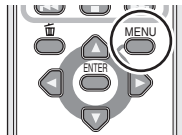

2 Select a menu item.

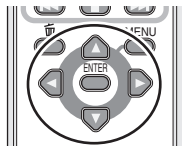

- Use the direction buttons (▲, ▼, ◀, ▶) and ENTER button in place of the cursor button on the main unit.

3 Press the MENU button to exit the menu screen.



Setting date and time

When the unit is turned on for the first time, a message asking you to set the date and time will appear.

- Move the cursor button to select [YES], press the cursor button and then perform steps 2 and 3 below to set the date and time.

◇ Rotate the mode dial to select  or .

- 1 Press the MENU button, then select [BASIC] → [CLOCK SET] → [YES] and press the cursor button.
- 2 Move the cursor button left or right to select the item to be set. Then, move the cursor button up or down to set the desired value.



- The year will change as follows: 2000, 2001, ..., 2039, 2000, ...
- The 24-hour system is used to display the time.

3 Press the cursor button to enter the selection.

- The clock function starts at [00] seconds when the cursor button is pressed.
- After pressing the MENU button to finish the setting, check the date and time display.

Changing the date and time display style

Press the MENU button, then select [SETUP] → [DATE/TIME] → desired display style and press the cursor button.

- You can also show or change the date and time display by repeatedly pressing the DATE/TIME button on the remote control.



[OFF]

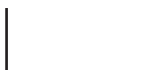

Changing the display style

Press the MENU button, then select [SETUP] → [DATE FORMAT] → desired display style and press the cursor button.

Display style	Screen display
[Y/M/D]	2008. 1. 1
[M/D/Y]	1 1 2008
[D/M/Y]	1. 1.2008

- The date and time function are driven by a built-in lithium battery.
- Make sure to check the time before recording.
- If the time display becomes [- -], the built-in lithium battery has run down. Use the following steps to charge the battery. When you turn on the power for the first time after charging, a message asking you to set the date and time will appear. Select [YES] and set the date and time.

To recharge the built-in lithium battery:

Connect the AC adaptor or attach the battery to the unit, and the built-in lithium battery will be recharged. Leave the unit as it is for approx. 24 hours and the battery will save the date and time for approx. 6 months. (The battery is still being recharged even if the mode dial is set to OFF.)

Adjusting LCD monitor/viewfinder

Adjusting the brightness and colour level

- Press the MENU button, then select [SETUP] → [LCD SET] or [EVF SET] → [YES] and press the cursor button.
- Move the cursor button up or down to select the item to be adjusted. Then, move the cursor button left or right to make the adjustment.
 - (HD mode) Move the cursor button to select the item to be adjusted. Then, press the centre of the cursor button to set and then move the cursor button to make the adjustment.



The bar display moves.

- (HD mode) After adjustments are made if no operations are performed for about 2 seconds, the bar will disappear.
- Press the MENU button to exit the menu screen.

[LCD SET]

[BRIGHTNESS]:

Brightness of the LCD monitor

[COLOUR]:

Colour level of the LCD monitor

[EVF SET]

[BRIGHTNESS]:

Brightness of the viewfinder

- To adjust the brightness of the viewfinder, extend the viewfinder and close the LCD monitor to activate it.
- When the viewfinder is extended and the LCD monitor is rotated by 180° towards the lens, the brightness and colour level of the LCD monitor cannot be adjusted.

- These settings will not affect the images actually recorded.

■ In order to increase the brightness of the entire LCD monitor

Press the POWER LCD EXTRA button.

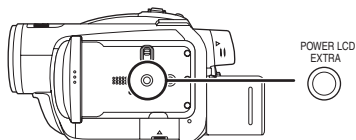

The [☀] indication appears on the LCD monitor.

- Each time the POWER LCD EXTRA button is pressed, the indication changes by one setting in the following order: [☀] → [☀☀] → setting cancelled (standard)
 - Press the POWER LCD EXTRA button if the surroundings are bright and the LCD monitor is difficult to see. The entire LCD monitor will become brighter than usual.
-
- This will not affect the images to be recorded.
 - If you use the AC adaptor, the [☀] indication appears and the screen becomes brighter automatically when the power is turned on.

Changing the picture quality on the LCD monitor ([LCD AI]) (HD mode only)

Press the MENU button, then select [SETUP] → [LCD AI] → [DYNAMIC] or [NORMAL] and press the cursor button.

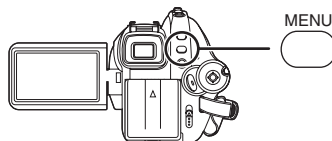

[DYNAMIC]:

The image on the LCD monitor becomes clear and vivid. Optimum contrast and brightness are set depending on the scenes recorded. Clear and brilliant images are presented.

[NORMAL]:

Switches to the standard picture quality.

-
- The effect will vary depending on the scene recorded.
 - The picture quality on the viewfinder will not be affected.
 - This function is automatically set to [DYNAMIC] when the brightness of the LCD monitor is increased (the [☀] or [☀☀] indication appears on the LCD monitor) and cannot be set to [NORMAL] independently.
 - This will not affect the images to be recorded.
 - When the viewfinder is extended and the LCD monitor is rotated by 180° towards the lens, the [LCD AI] is set to [NORMAL].

Adjusting the field of view

Adjust the focus by sliding the eyepiece corrector knob.

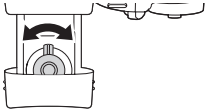

Recording

Before recording

First, format the SD card or the disc if one which has been used on another device is going to be used for the first time on this unit. (→ 94) When the SD card or the disc is formatted, all of the recorded data is deleted. Once the data is deleted, it cannot be restored. Copy valuable data onto a PC or other device before proceeding with the formatting.

We recommend using HD Writer 2.0E for SX/SD to import data recorded on this unit. (→ 125)

Basic camera positioning

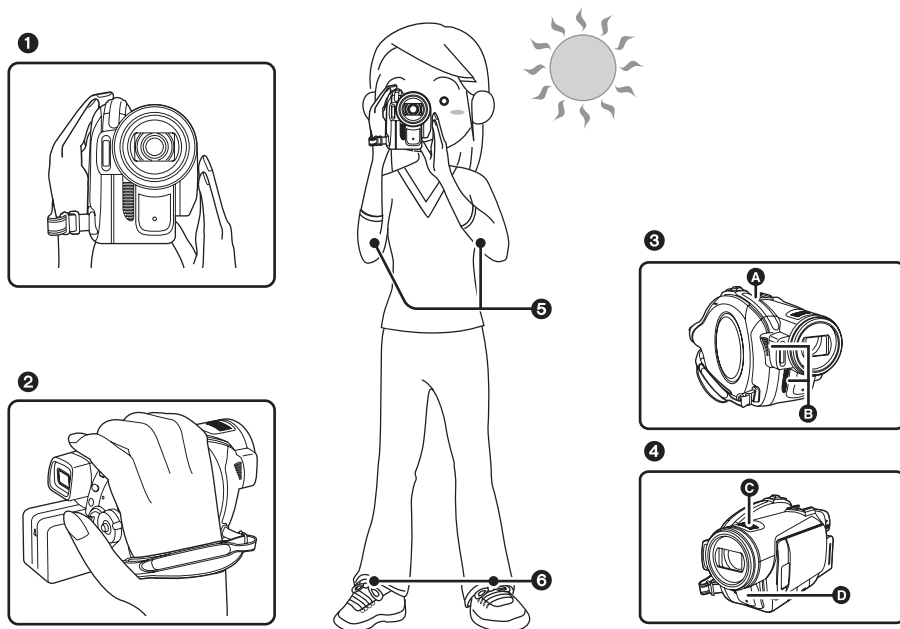

- ① Hold the unit with both hands.
 - ② Put your hand through the grip belt.
 - ③ Do not cover inlet **A** or outlet **B** of the cooling fan with your hand as it will prevent heat release. If heat builds up inside the unit, it could be damaged.
 - ④ Do not cover the microphones **C** or the sensors **D** with your hands.
 - ⑤ Keep your arms near your body.
 - ⑥ Slightly open your legs.
- When you are outdoors, record pictures with the sunlight behind you. If the subject is backlit, it will become dark in the recording.
 - When recording, make sure your footing is stable and there is no danger of colliding with another person, a ball etc.

About auto mode

Set the AUTO/MANUAL/FOCUS switch to AUTO, and colour balance (white balance) and focusing will be adjusted automatically.

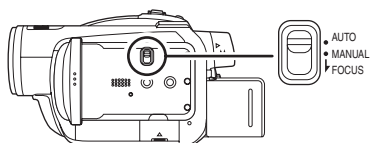

- Automatic white balance (→ 155)
- Auto focus (→ 156)

Depending on the brightness of the subject etc., the aperture and shutter speed are automatically adjusted for an optimum brightness.

(The shutter speed is adjusted to a maximum of 1/250 in recording mode.)

- Colour balance and focus may not be adjusted automatically depending on light sources or scenes. If so, manually adjust these settings.
 - Scene mode setting (→ 74)
 - White balance setting (→ 76)
 - Shutter speed setting (→ 77)
 - Iris/gain value setting (→ 77)
 - Manual focus setting (→ 75)

Anti-Ground-Shooting (AGS)

This function prevents unnecessary recording when you forget to pause recording and walk with the unit tilted upside down while recording continues.



- If the unit continues to be tilted upside down from the normal horizontal position while recording motion pictures, it is automatically set to recording pause.

Turning the AGS function on/off

- ◇ Rotate the mode dial to select **●** or **□**.

Press the MENU button, then select [VIDEO] (HD mode) or [SETUP] (STD mode) → [AGS] → [ON] or [OFF] and press the cursor button.

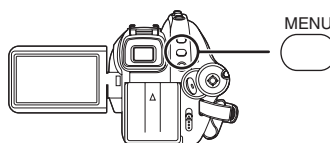

- This function's default setting is [OFF].
- The AGS function may activate and cause the unit to pause the recording if you are recording a subject right above or right below you. In these cases, set [AGS] to [OFF] then continue the recording.
- Use the recording start/stop button to pause the recording. The AGS function is only a backup function for when you forget to pause the recording.
- The time it takes the unit to be put into recording pause after being tilted upside down varies depending on the operating conditions.

Recording motion pictures



Record motion pictures to a disc or an SD card.

- Use an SD card that can be used for motion picture recording. (→ 25)
- This unit is compatible with the 16:9 aspect ratio of a wide-screen TV and images are recorded in high definition or conventional standard picture quality.

1 Rotate the mode dial to select or .

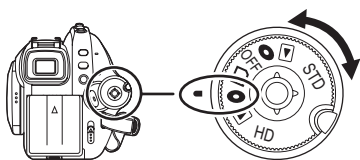

The lens cover opens automatically.

◇ HD mode

- Records motion pictures in high definition picture quality on a disc or an SD card.

◇ STD mode

- Records motion pictures in conventional standard picture quality on a disc.

2 Open the LCD monitor or extend the viewfinder.

3 Press the recording start/stop button to start recording.

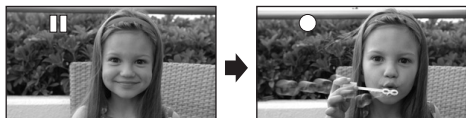



- The power will not turn off while recording motion pictures even if the LCD monitor is closed and the viewfinder is retracted.

To end the recording

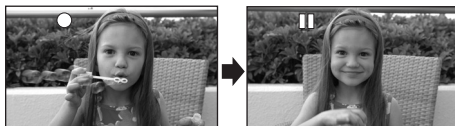
Press the recording start/stop button again to pause recording.



-  and  are red during recording. Do not move this unit until  is green.
- The images recorded between pressing the recording start/stop button to start recording and pressing it again to pause recording become one scene.
- When about 5 minutes have passed without any operation in recording pause, the unit automatically turns off to prevent the battery from running down. When you want to use the unit, turn it on again.

This setting can also be set to [OFF]. (→ 134)

■ Screen indications in the disc recording mode (HD mode)



- A** Recording mode
- B** Remaining time left for recording
(When the remaining time is less than 1 minute, [R0min] flashes red.)
- C** Recording time elapsed

- The maximum number of scenes (on one side if a disc): 999 (Even if there is remaining capacity for recording on a disc or an SD card, you may not be able to record 999 scenes.)
- The maximum number of recordable scenes with different dates (on one side if a disc): 99 (In some cases, scenes recorded on the same day will be recorded with different dates (→ 83))

- Discs or SD cards with more than the maximum scenes or dates cannot be used with this unit.
- Sound is recorded from the internal microphones on the top of this unit. Take care not to block this microphone.
- Each time the unit is put into recording pause, the counter display will be reset to "0h00m00s".
- When recording motion pictures, do not remove the battery or disconnect the AC adaptor. Also do not remove the SD card while the card access lamp is lit. If you do either of the above, the scene recovery message is displayed and the recovery operation will begin when the SD card is next inserted or the power is turned back on. (→ 139)
- While "WRITING CONTROL DATA TO DISC. DO NOT SHAKE THE UNIT." is displayed, do not disconnect the AC adaptor or remove the battery as doing so may make the disc unusable.
- While motion picture recording is in progress, do not disconnect the AC adaptor or remove the battery. If you do, a repair disc message may be displayed when the power is turned back on. (→ 139)

The ACCESS/PC lamp lights immediately after recording finishes. While it lights, the disc is rotating and disc information is being recorded. If you run while holding the unit or swing it, the recorded images may be distorted so do not strongly shake or cause impact to it.

■ When recording stops suddenly during motion picture recording on an SD card

When using an SD card other than one that can be used for motion picture recording (→ 25), the recording may stop suddenly. At this time, the following message appears.

When motion pictures are to be recorded, use a Panasonic SD card or another SD card which can be used to record motion pictures. (→ 25)



Even if you use an SD card that can be used for motion picture recording (→ 25), this kind of message may appear.

The data on the card has been written many times and the data writing speed has reduced. We recommend formatting the SD card being used. (→ 94) When an SD card is formatted, all the data recorded on it will be deleted so copy valuable data to the PC prior to formatting. (→ 125) (When acquiring data recorded on this unit, we recommend using HD Writer 2.0E for SX/SD to acquire it. (→ 125))

PRE-REC function
This prevents you missing a shot.



This allows recording of the pictures and sound to start approximately 3 seconds before the recording start/stop button is pressed so you can capture moments you would otherwise have missed.

◇ When the mode dial is set to  and an SD card is inserted in this unit

1 Open the LCD monitor or extend the viewfinder.

2 Press the PRE-REC button.

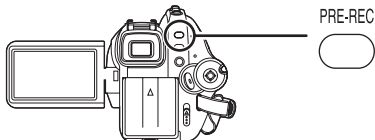

The  indication appears.

- Aim this unit at the subject and position it securely.
- Recording of the pictures and sound starts approximately 3 seconds before the recording start/stop button is pressed.

3 Press the recording start/stop button to start recording.

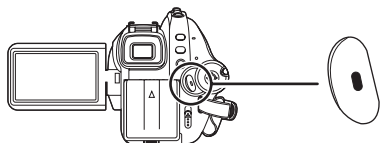

- There is no beep sound.
- After recording starts, the PRE-REC setting is cancelled.

To end PRE-REC

- PRE-REC is also ended if you press the PRE-REC button in PRE-REC.

- PRE-REC is cancelled in the following cases.
 - If you operate the mode dial.
 - If you turn the unit off.
 - If you open the card slot cover.
 - If you press the MENU button.
 - In quick start standby mode.
- When the remaining time left for recording motion pictures is less than 1 minute, PRE-REC cannot be set.
- If you start recording less than 3 seconds after pressing the PRE-REC button, the PRE-REC function is not activated and the pictures are recorded normally.
- When the recording start/stop button is pressed, image shake and operation sound may be recorded.

Recording modes/recordable time available for the motion picture



Switch the picture quality of the motion pictures to be recorded.

◇ Rotate the mode dial to select or .

Press the MENU button, then select [VIDEO] (HD mode) or [BASIC] (STD mode) → [REC MODE] → desired item and press the cursor button.

■ Approximate recordable time for 1 disc

HD mode

Disc type	HG	HN	HE
	14 min	21 min	31 min
	26 min	40 min	60 min

HG (1920×1080):

Motion pictures can be recorded with the highest picture quality.

HN (1440×1080):

Motion pictures can be recorded with normal picture quality.

HE (1440×1080):

Motion pictures can be recorded for a longer time.

- The recordable times shown in the table are approximations.
- **The recording is in high definition picture quality no matter what recording mode is used to record.**
- This unit records in CBR in HG mode. CBR is an abbreviation for Constant Bit Rate. CBR recording does not vary the bit rate (amount of data in a fixed time).
- This unit records in VBR in HN/HE mode. VBR is an abbreviation for Variable Bit Rate. VBR recording automatically varies the bit rate (amount of data in a fixed time) depending on the subject being recorded. This means if a subject with sharp movements is recorded, the recording time is reduced.

STD mode

Disc type	XP	SP	LP
	18 min	37 min	1 h 15 min
	18 min	37 min	1 h 14 min
	35 min	1 h 9 min	2 h 18 min

XP: Motion pictures can be recorded with the highest picture quality.

SP: Motion pictures can be recorded with normal picture quality.

LP: Motion pictures can be recorded for longer time.

- The recordable times shown in the table are approximations.
- **The recording is in standard picture quality no matter what recording mode is used to record.**
- This unit records in VBR in XP/SP/LP mode. VBR is an abbreviation for Variable Bit Rate. VBR recording automatically varies the bit rate (amount of data in a fixed time) depending on the subject being recorded. This means if a subject with sharp movements is recorded, the recording time is reduced.

■ Approximate recordable time for 1 SD card made by Panasonic

SD card memory	HG	HN	HE
256 MB	2 min	3 min	5 min
512 MB	5 min	7 min	10 min
1 GB	10 min	15 min	22 min
2 GB	20 min	30 min	45 min
4 GB	40 min	1 h	1 h 30 min
8 GB	1 h 20 min	2 h	3 h

- HD** (1920×1080):
Motion pictures can be recorded with the highest picture quality.
- FHD** (1440×1080):
Motion pictures can be recorded with normal picture quality.
- HD** (1440×1080):
Motion pictures can be recorded for longer time.

- The recordable times shown in the table are approximations.
- **The recording is in high definition picture quality no matter what recording mode is used to record.**
- This unit records in CBR in HG mode. CBR is an abbreviation for Constant Bit Rate. CBR recording does not vary the bit rate (amount of data in a fixed time).
- This unit records in VBR in HN/HE mode. VBR is an abbreviation for Variable Bit Rate. VBR recording automatically varies the bit rate (amount of data in a fixed time) depending on the subject being recorded. This means if a subject with sharp movements is recorded, the recording time is reduced.

● Recordable time using the battery (→ 30)

- 8 MB and 16 MB SD cards cannot be used for motion picture recording.
- If the write protection switch on the SD card is set to LOCK, it cannot be used for recording. (→ 25)
- If an SD card is recorded on or erased many times, it may no longer be possible to record motion pictures even if there is available memory on the SD card. In this case, after saving the data on PC, format the SD card.
- Mosaic-pattern noise may appear on a playback image in the following cases.
 - When there is a complicated pattern in the background
 - When the unit is moved too much or too fast
 - When a subject with sharp movements has been recorded (Particularly if it has been recorded in [HE] or [LP] mode.)
- Sound is recorded with the Dolby Digital.

Recording still pictures (JPEG)

PHOTO

Record the still picture on an SD card.

- This number of recording pixels for still pictures is compatible with the 16:9 aspect ratio of a wide-screen TV. They are recorded at [1920×1080].
- Still pictures cannot be recorded in STD mode.

1 Rotate the mode dial to select or .

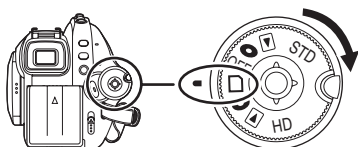

The lens cover opens automatically.

2 Open the LCD monitor or extend the viewfinder.

3 Press the PHOTO SHOT button halfway in order to adjust focusing. (For auto focusing only)

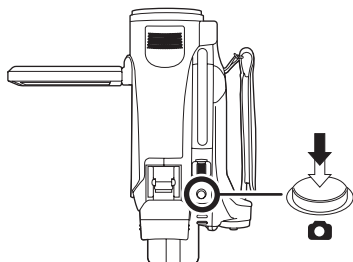

The shutter speed and the iris/gain value are fixed and the unit focuses on the subject automatically.

- If you set [O.I.S.] (→ 69) to [ON], then the image stabilizer function will be more effective. ([MEGA] ) (MEGA optical image stabilizer) will be displayed.)

Focus indication:

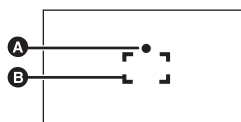

A Focus indication

B Focus area

○ (The white lamp flashes.):

Focusing

● (The green lamp lights up.):

When in focus

No mark:

When focusing is unsuccessful.

4 Press the PHOTO SHOT button fully to take the picture.

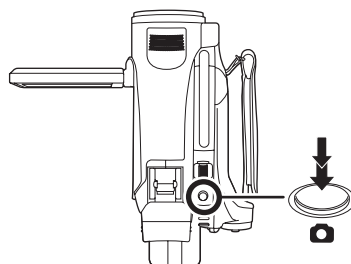

- In order to take better still pictures, the screen will brighten when recording.

To record still pictures clearly

- When zooming in on the subject with a magnification of 4× or higher, it is difficult to reduce the slight shaking from holding this unit by hand. We recommend decreasing the zoom magnification and approaching the subject when recording.
- When recording still pictures, hold the unit firmly with your hands and keep your arms stationary at your side so as not to shake the unit.
- You can record stable pictures without shaking by using a tripod and the remote control.

• For information about the number of recordable still pictures on an SD card (→ 60)

- The sound cannot be recorded.

- If the write protection switch on the SD card is set to LOCK, it cannot be used for recording.
- The PHOTO SHOT button on the remote control cannot be pressed halfway.
- If the [PICT. QUALITY] is set to [], mosaic-pattern noise may appear on a playback image depending on the picture content.
- While this unit accesses the SD card (▶ is displayed/the access lamp is lit), do not perform the following operations. The SD card or the recorded data may be damaged.
 - Turn the unit off.
 - Open the card slot cover and remove the SD card.
 - Operate the mode dial.
- Other products may degrade or not play back still pictures recorded on this unit.
- The edges of still pictures recorded on this unit with a 16:9 aspect ratio may be cut at printing. Check the printer or photo studio before printing.

About the screen indications when the PHOTO SHOT button is pressed halfway

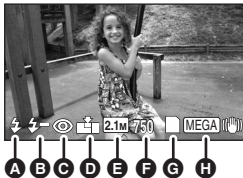

- A** Flash (→ 67)
- B** Flash level (→ 68)
- C** Red eye reduction (→ 68)
- D** Quality of still pictures (→ 59)
- E** Size of still pictures
- F** Remaining number of still pictures (Flashes in red when [0] appears.)
- G** Card indication (→ 135)
- H** MEGA optical image stabilizer (→ 57)

About the focus indication

- The focus indication does not appear in manual focus mode.
- Focus on a subject manually when it is not easily focused. (→ 75)
- You can record still pictures on the card even if the focus indication does not appear, but pictures may be recorded without being focused.
- The focus indication does not appear or has difficulty displaying in the following cases.
 - When the zoom magnification is high.
 - When the unit is shaken.
 - When the subject is moving.
 - When the subject stands in front of a light source.
 - When close subjects and far subjects are included in the same scene.
 - When the scene is dark.
 - When there is a bright part in the scene.
 - When the scene is filled with only horizontal lines.
 - When the scene lacks contrast.
 - When recording motion pictures.
 - When the colour night view function is used.
 - When PRE-REC is used.

Concerning the focusing area

When there is a contrasting object ahead or behind the subject in the focus area, the subject may not be focused. If so, move the contrasting object out of the focus area.

Even when it is still difficult to focus, adjust the focus manually.

- The focusing area is not displayed when the digital zoom (more than approx. 10×) is used.

Switching the shutter sound on/off

You can add a shutter sound when recording still pictures.

Press the **MENU** button, then select **[PICTURE]** → **[SHTR SOUND]** → **[ON]** or **[OFF]** and press the cursor button.

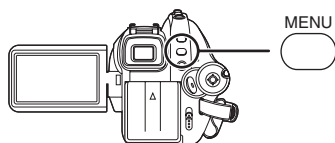

- This function's default setting is [ON].
- This function does not work during motion picture recording.

About simultaneous recording (recording still pictures while recording motion pictures)

You can record still pictures on an SD card even while recording motion pictures.

While recording motion pictures, press the **PHOTO SHOT** button fully (press to the bottom) to take the picture.

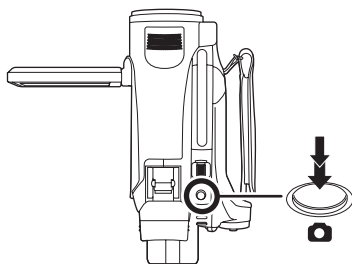

- The PHOTO SHOT button cannot be pressed halfway in the simultaneous recording.
- The screen indications that appear when the PHOTO SHOT button is pressed halfway will be displayed.

- The picture quality is different from normal still picture recording because priority is given to the motion picture recording. We recommend pausing the motion picture recording to record a still picture with better picture quality.
- Still pictures cannot be recorded in STD mode.

Number of pixels and picture quality for still picture recording



PHOTO

Picture quality

Selecting the picture quality.

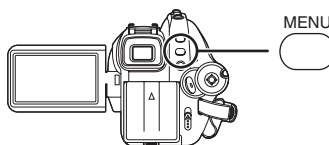

Press the **MENU** button, then select **[PICTURE]** → **[PICT. QUALITY]** → desired item and press the cursor button.





-  : Still pictures with a high picture quality are recorded.
-  : Priority is given to the number of still pictures recorded. Still pictures are recorded in normal picture quality.

Approximate Number of Recordable Pictures on an SD Card

Picture quality and number of recordable pictures

Picture size	2.1M (1920×1080)	
Picture quality		
8 MB	4	6
16 MB	10	17
32 MB	20	32
64 MB	47	74
128 MB	94	150
256 MB	200	320
512 MB	410	640
1 GB	820	1290
2 GB	1670	2630
4 GB	3290	5160
8 GB	6690	10520



- The number of recordable pictures depends on whether [] and [] are used together and on the subject being recorded.
- The numbers shown in the table are approximations.

Various recording functions

Zoom in/out function



You can zoom in up to 10× optically.

- ◇ Rotate the mode dial to select  or .

Move the zoom lever.

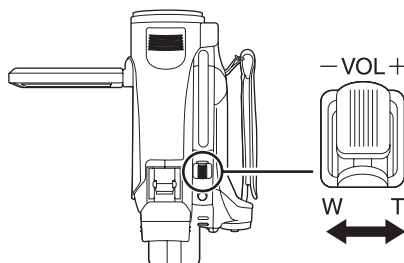

T side:

Close-up recording (zoom in)

W side:

Wide-angle recording (zoom out)

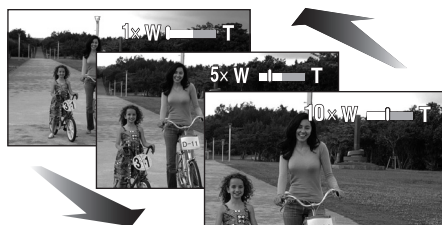

- If you take your finger off the zoom lever during zoom operation, the operation sound may be recorded. When returning the zoom lever to the original position, move it quietly.
- When zooming in while holding this unit by hand, we recommend using the image stabilizer function. (→ 69)
- When distant subjects are brought closer, they are focused at about 1.2 m or more.

- When the zoom magnification is 1×, this unit can focus on a subject approx. 4 cm away from the lens. (Macro function)
- The zoom speed varies depending on the range over which the zoom lever is moved. (The zoom speed does not vary when operating with the remote control.)
- If the zoom lever is pushed to the end, you can zoom from 1× up to 10× in as fast as approx. 2.5 seconds.
- When the zoom speed is high, the subject may not be focused easily.

Digital zoom function

If the zoom magnification exceeds 10×, then the digital zoom function will be activated. The maximum magnification provided by the digital zoom can be switched.

Press the MENU button, then select [BASIC] (HD mode) or [ADVANCED] (STD mode) → [D.ZOOM] → desired item and press the cursor button.

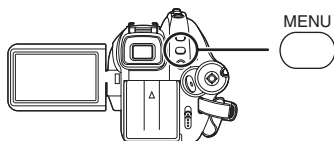

[OFF]: Optical zoom only (Up to 10×)

[25×]: Up to 25×

[700×]: Up to 700×

- If [25×] or [700×] is selected, the digital zoom range is displayed in blue while zooming.

- The larger the digital zoom magnification, the more the image quality is degraded.

About using the zoom microphone function

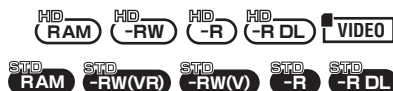

The zoom microphone is linked to the zooming operation so that far-away sounds with a tele-shot and close-up sounds with a wide-angle shot are recorded more clearly.

Press the MENU button, then select [VIDEO] (HD mode) or [ADVANCED] (STD mode) → [ZOOM MIC] → [ON] and press the cursor button.

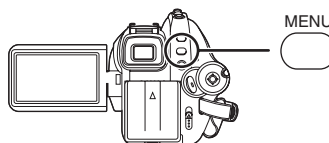

- The stereo effect will be reduced with tele-shots.

Recording yourself



You can record yourself while viewing the LCD monitor. You can record persons in front of the unit while showing them the image.

◇ Rotate the mode dial to select  or .

Rotate the LCD monitor towards the lens side.

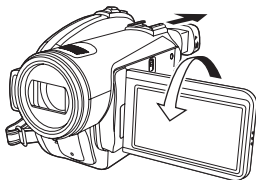

The image is horizontally flipped as if you see a mirror image. (However the image recorded is the same as a normal recording.)



- Extend the viewfinder to see the picture while recording.
-
- When the LCD monitor is rotated towards the lens side, the icon will not be displayed even if you press the cursor button.
 - Only some indications will appear on the screen. When  appears, return the direction of the LCD monitor to normal position and check the warning/alarm indication. (→ 137)

Intelligent contrast control

This is for recording both bright and dark parts clearly at the same time.



Use this function to brighten parts that are in the shadow and difficult to see and to stop white saturation in bright parts.

◇ Rotate the mode dial to select  or .

1 Press the cursor button. Then move the cursor button down to display the icon shown in the illustration.



2 Move the cursor button up to select .



To cancel intelligent contrast control

Select  again.

- If there are extremely dark or bright parts or the brightness is insufficient, the effect may not be clear.
- If you turn off the power or operate the mode dial, the intelligent contrast control is cancelled.

Fade in/fade out function

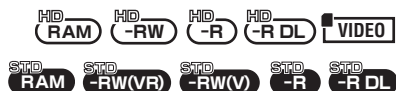

Fade in:

The image and audio gradually appear.

Fade out:

The image and audio gradually disappear.

- ◇ Rotate the mode dial to select **HD** or **STD**.

- 1 Press the cursor button. Then move the cursor button down to display the icon shown in the illustration.



- 2 Move the cursor button left to select [▶].

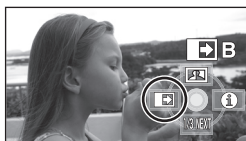

- 3 Press the recording start/stop button. (Fade in)



When you start recording, the image/audio gradually appears.

- 4 Press the recording start/stop button. (Fade out)



The image/audio gradually disappears. After the image/audio completely disappears, recording stops.

- After recording, the fade setting is cancelled.

To cancel fading

Select [▶] again.

To select the colour for fade in/out

The colour which appears in fading pictures can be selected.

Press the **MENU** button, then select **[VIDEO]** (HD mode) or **[ADVANCED]** (STD mode) → **[FADE COLOUR]** → **[WHITE]** or **[BLACK]** and press the cursor button.

- If you turn off the power, the fade function is cancelled.
- While the fade in/fade out function is selected, it takes several seconds to display the image when you start recording. It also takes several seconds to pause recording.
- The thumbnails of scenes recorded using fade in become black (or white).

Colour night view function

This allows recording in dark locations.



This function allows you to record colour subjects in dark locations (Minimum required illumination: approx. 1 lx) to stand out against the background.

Attach this unit to a tripod, and you can record images free from vibration.

- Recorded scene is seen as if frames were missed.

◇ Rotate the mode dial to select or .

1 Press the cursor button. Then move the cursor button down to display the icon shown in the illustration.



2 Move the cursor button up to select [].

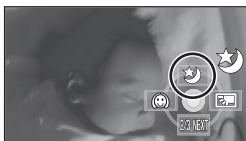

To cancel the colour night view function

Select [] again.

- The focus indication does not appear even if the PHOTO SHOT button is pressed halfway.
- When using auto focus, it will take some time to focus in dark areas. If there is difficulty focusing with auto focus, manually adjust the focus.



- The colour night view function makes the signal charging time of CCD up to approximately 25× longer than usual, so that dark scenes can be recorded brightly. For this reason, bright dots that are usually invisible may be seen, but this is not a malfunction.
- If you turn off the power or operate the mode dial, the colour night view function is cancelled.
- If set in a bright place, the screen may become whitish for a while.

Soft skin mode

This makes skin colours appear softer for a more attractive appearance.



This is more effective if you record the bust image of a person.

◇ Rotate the mode dial to select  or .

1 Press the cursor button. Then move the cursor button down to display the icon shown in the illustration.



2 Move the cursor button left to select [].



To cancel the soft skin mode

Select [] again.



- If the background or anything else in the scene has colours similar to the skin colour, they will also be smoothed.
- If the brightness is insufficient, the effect may not be clear.
- If you record a person in the distance, the face may not be recorded clearly. In this case, cancel soft skin mode or zoom in on the face (close-up) to record.

Backlight compensation function

This is for preventing a backlit subject from being darkened.



Use this function when the light is emanating from behind the subject and the subject appears dark.

◇ Rotate the mode dial to select  or .

1 Press the cursor button. Then move the cursor button down to display the icon shown in the illustration.

◇ HD mode



◇ STD mode



2 (HD mode) Move the cursor button right to select [].



(STD mode) Move the cursor button up to select [E].



- The image on the screen will become brighter.

To return to normal recording

Select [E] again.

- If you turn off the power or operate the mode dial, the backlight compensation function is cancelled.

Self-timer recording

This is for recording shots of yourself as well.

PHOTO

You can record still pictures on an SD card using the timer.

- ◇ Rotate the mode dial to select **●** or **□**.

1 Press the cursor button. Then move the cursor button down to display the icon shown in the illustration.

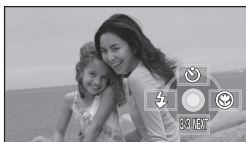

2 Move the cursor button up to select [10].

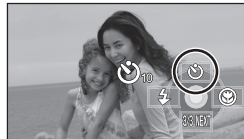

- Each time the cursor button is pressed up, the indication changes by one setting in the following order: [10] → [2] → setting cancelled

10: Starts recording after 10 seconds

2: Starts recording after 2 seconds

3 Press the PHOTO SHOT button.

A still picture is recorded after the [10] or [2] display and the recording lamp flashes for the time which has been set.

- After recording, the self-timer is cancelled.
- If you press the PHOTO SHOT button halfway and then fully in auto focus mode, the subject is focused when the button is pressed halfway.
- When you press the PHOTO SHOT button fully in auto focus mode, the subject is focused just before recording.

To stop the timer midway through



Press the MENU button. (The self-timer setting is cancelled.)

- The self-timer is cancelled if the power is turned off or the mode dial is operated.
- The self-timer standby mode is cancelled when you press the recording start/stop button to start motion picture recording. Even if you press the recording start/stop button while the self-timer is counting down, motion picture recording is not possible.
- Depending on the time taken to bring the subject into focus, the recording may take longer than set to start.
- Setting the self-timer to [2] is a good way to prevent image shake when the PHOTO SHOT button is pressed while using a tripod etc.

Built-in flash

PHOTO

Use the built-in flash in order to record still pictures in dark places.

◇ Rotate the mode dial to select  or .

1 Press the cursor button. Then move the cursor button down to display the icon shown in the illustration.

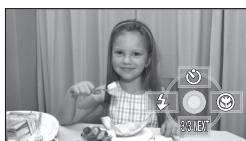

2 Move the cursor button left to select .



- Each time the cursor button is pressed left, the indication changes by one setting in the following order: [FLASH ON] → [FLASH AUTO] → [FLASH OFF]
- When the PHOTO SHOT button is pressed halfway, the flash indicator will appear in the bottom left corner of the screen.

[FLASH ON]: 

[FLASH AUTO]: 

[FLASH OFF]: 



- When [FLASH AUTO] is set, the ambient brightness is automatically detected, and the flash will activate only when necessary. (If the flash is not necessary, the  indicator will not appear when the PHOTO SHOT button is pressed halfway.)
- This function's default setting is [FLASH AUTO].

3 Press the PHOTO SHOT button.

The flash is activated and the picture will be recorded.

When the flash is not used

Set the flash to [FLASH OFF].

- Do not block the flash with your hand or by other means.
- The unit automatically determines if the flash is necessary even when it has been set to [FLASH OFF] by detecting the ambient brightness. (If it determines that the flash is necessary, the  indication lights up in red when the PHOTO SHOT button is pressed halfway.)
- If the  indication etc. flashes or is not displayed when the PHOTO SHOT button is pressed halfway, the flash is not activated.
- The available range of the flash is approx. 1 m to 2.5 m in dark places. Pictures will appear dark or reddish when they are recorded by using the flash at distances greater than 2.5 m.
- Using the flash fixes a shutter speed of 1/750 or faster to 1/500.
- The picture may become out of focus in dark places. If so, adjust the focus manually.
- The picture may appear dark if the flash is lit in front of a white background.
- A conversion lens (optional) can block the flash and may cause a vignetting effect.
- Do not use the flash with the ND filter (optional) attached.
- Set the flash to [FLASH OFF] where using a flash is prohibited.
- If the flash will be activated a large number of times, it may take longer to charge it.

Red eye reduction function

Reduces the phenomena where human eyes become red from flashes.

Press the MENU button, then select [PICTURE] → [RED EYE] → [ON] and press the cursor button.

To cancel the red eye reduction function

Press the MENU button, then select [PICTURE] → [RED EYE] → [OFF] and press the cursor button.

- The flash is activated 2 times. Do not move until the second flash is finished.
- Use this when you take pictures of people in dark places.
- Red eye phenomenon may appear depending on the recording conditions.

To adjust the brightness of the flash

Press the MENU button, then select [PICTURE] → [FLASH LEVEL] → desired item and press the cursor button.

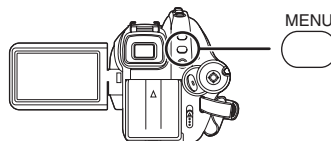

- [⚡-]: If the brightness is too high.
- [⚡±0]: In normal recording
- [⚡+]: If the brightness is insufficient.

■ Using the flash VW-FLH3E (optional)

- The flash permits still picture recording in a dark place 2.5 m or more distant from the subject. The available range of the flash is approx. 1 m to 4 m.
- The [⚡] or [⚡A] indication appears only when the PHOTO SHOT button is pressed halfway.
- The flash setting cannot be changed when the power switch on the flash is set to [ON] or [AUTO].
- The optional flash and the built-in flash cannot be used simultaneously.
- The brightness of the flash cannot be adjusted.
- The shutter speed, iris/gain, and white balance become fixed.
- Using the flash outdoors or with backlight or other bright conditions may result in white blotches (colour blotches) on the pictures. If so, either adjust the iris manually or use the backlight compensation function, without using the flash.
- Carefully read the operating instructions for the flash.

Tele macro function

This is for bringing only what you want to record into focus to take close-ups.

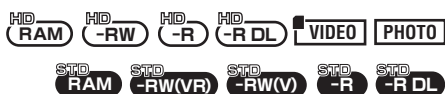

By focusing only on the subject and blurring the background, the image can be impressive.

The unit can focus on the subject at a distance of approx. 50 cm.

◇ Rotate the mode dial to select or .

1 Press the cursor button. Then move the cursor button down to display the icon shown in the illustration.

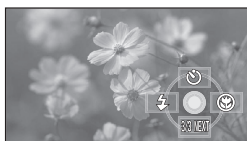

2 Move the cursor button right to select .



- If the magnification is 10× or less, then it is automatically set to 10×.

To cancel the tele macro function

Select again.

- If a sharper focus cannot be achieved, adjust the focus manually. (→ 75)
- In the following cases, the tele macro function is cancelled.
 - The zoom magnification becomes lower than 10×.
 - The power is turned off or the mode dial is operated.

Image stabilizer function

This is for reducing image shakes during recording.

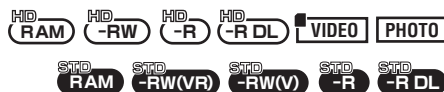

Reduces the image shaking due to hand movement when recording.

◇ Rotate the mode dial to select or .

Press the MENU button, then select [BASIC] (HD mode) or [ADVANCED] (STD mode) → [O.I.S.] → [ON] and press the cursor button.

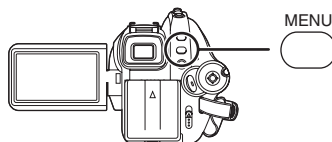

To cancel the image stabilizer function

Press the MENU button, then select [BASIC] (HD mode) or [ADVANCED] (STD mode) → [O.I.S.] → [OFF] and press the cursor button.

- This function's default setting is [ON].
- In still picture recording mode, pressing the PHOTO SHOT button halfway increases the effect of the image stabilizer function. (MEGA optical image stabilizer)
- When a tripod is used, we recommend that you turn the image stabilizer off.
- In the following cases, the image stabilizer function may not work effectively.
 - When the digital zoom is used
 - When the unit is shaken greatly
 - When you record a moving subject while tracking it
 - When the conversion lens is used

Guide line function

This is for viewing the slope and the balance of the image while recording or playing back.



You can check if the image is level while recording or playing back motion pictures and still pictures. The function can also be used to estimate the balance of the composition.

HD mode

◇ Rotate the mode dial to select or or rotate the mode dial to and then select the [] or [] tab. (→ 79)

Press the MENU button, then select [BASIC] or [PLAY SETUP] → [GUIDE LINES] → desired item and press the cursor button.

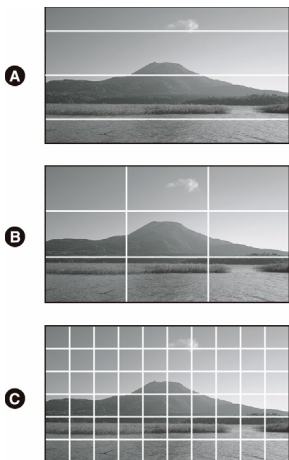

- A [HORIZONTAL]
- B [GRID1]
- C [GRID2]

To cancel the guide line function

Press the MENU button, then select [BASIC] or [PLAY SETUP] → [GUIDE LINES] → [OFF] and press the cursor button.

STD mode

◇ Rotate the mode dial to select . Press the MENU button, then select [BASIC] → [GUIDE LINES] → [ON] and press the cursor button.

To cancel the guide line function

Press the MENU button, then select [BASIC] → [GUIDE LINES] → [OFF] and press the cursor button.

- The guide lines do not appear on the images actually recorded.
- The guidelines are not displayed while rotating the LCD monitor forward to record yourself.

Wind noise reduction function

This is for reducing the wind noise coming into the microphone when recording.

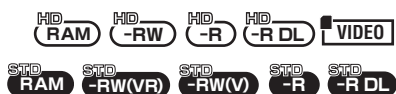

- ◇ Rotate the mode dial to select  or .

Press the MENU button, then select [VIDEO] (HD mode) or [ADVANCED] (STD mode) → [WIND CUT] → [ON] and press the cursor button.

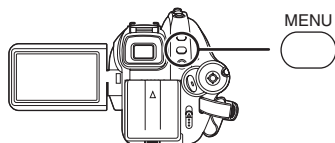

To cancel the wind noise reduction function

Press the MENU button, then select [VIDEO] (HD mode) or [ADVANCED] (STD mode) → [WIND CUT] → [OFF] and press the cursor button.



- This function's default setting is [ON].
- The wind noise reduction depends on the wind strength. (The stereo effect may be reduced if this function is activated in strong winds. However, the stereo effect is automatically restored when then the wind weakens.)

Microphone level

This is for adjusting the microphone input level.



When recording, the input level from the built-in microphones and the external microphone terminal can be adjusted.

- ◇ Rotate the mode dial to select  or .

1 Press the MENU button, then select [VIDEO] → [MIC LEVEL] → [SET+AGC] or [SET] and press the cursor button.

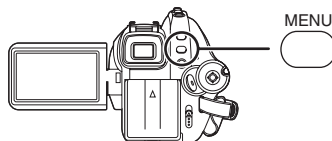

AGC: Auto Gain Control

[AUTO]: AGC is activated, and the recording level is adjusted automatically.

[SET+AGC]: The desired recording level can be set. AGC will also be activated to reduce the amount of sound distortion.

[SET]: AGC is not activated and so natural recording can be performed.

2 Move the cursor button left or right to adjust the microphone input level.

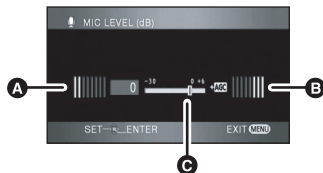

- A** Left
- B** Right
- C** Microphone input level
- A gain value for each of the 2 built-in microphones is displayed. (The input level of the microphones cannot be set individually.)

3 Press the cursor button to set and then press the MENU button to finish the setting.

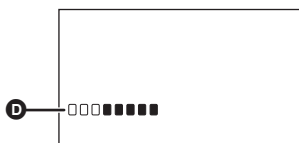

- D** Microphone input level meter
- Microphone input level meter is displayed on the screen.

To return to automatic setting

Press the MENU button, then select [VIDEO] → [MIC LEVEL] → [AUTO] and press the cursor button.

- Adjust the gain value so that the last 2 bars of the microphone input level on the centre of the screen will not light red. (Otherwise, the sound is distorted.) Select a lower setting for gain value or set [MIC LEVEL] to [AUTO].
- The microphone input level meter displays the microphone input level for the built-in microphone with the larger volume.
- When [ZOOM MIC] is [ON], the volume will be different depending on the zoom rate. Set [ZOOM MIC] to [OFF] or set the microphone input level after adjusting the zoom rate. (→ 61)

Zebra display

This is for displaying the parts that are too bright.



Parts where white saturation (colour saturation) is likely to occur (extremely brightly lit or shiny parts) are displayed with diagonal lines (zebra pattern).

◇ Rotate the mode dial to select **VIDEO** or **PHOTO**.

Press the MENU button, then select [ADVANCED] → [ZEBRA] → [ON] and press the cursor button.

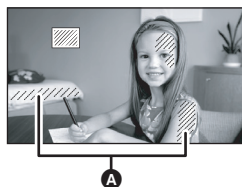

- A** Zebra pattern
- You can record an image with little white saturation if you manually adjust the shutter speed or brightness (iris/gain) (→ 77).

To cancel the zebra display

Press the MENU button, then select [ADVANCED] → [ZEBRA] → [OFF] and press the cursor button.



- The zebra pattern does not appear on the images actually recorded.

Colour bar

This is for displaying colour bars to check the colour tone.



This unit displays a 7 colour bar which is useful for adjusting the picture quality of the TV or the external monitor.

◇ Rotate the mode dial to select  or .

Press the MENU button, then select [ADVANCED] → [COLOUR BARS] → [ON] and press the cursor button.



To cancel the colour bar



Press the MENU button, then select [ADVANCED] → [COLOUR BARS] → [OFF] and press the cursor button.

- This function is cancelled when the power is turned off.
- The icon will not be displayed even if you press the cursor button.

Auto slow shutter mode



You can record bright pictures even in dark places by slowing the shutter speed.

◇ Rotate the mode dial to select  or .

Press the MENU button, then select [ADVANCED] → [AUTO SLOW SHTR] → [ON] and press the cursor button.

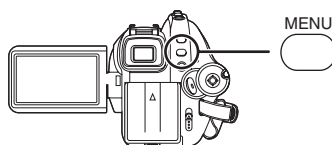

- When auto slow shutter mode is selected, the shutter speed is adjusted between 1/25 and 1/250 depending on the surrounding brightness.
- When adjusting the shutter speed manually, it can be adjusted between 1/25 and 1/8000. (→ 77)

To cancel the slow shutter mode

Press the MENU button, then select [ADVANCED] → [AUTO SLOW SHTR] → [OFF] and press the cursor button.

- If [AUTO SLOW SHTR] is set to [OFF], then the shutter speed will be set between 1/50 and 1/250. (When adjusting the shutter speed manually, it can be adjusted between 1/50 and 1/8000.)
- This function's default setting is [ON].
- If the scene is low in brightness or contrast, the subject may not be focused in on.
- When the shutter speed becomes 1/25, the screen may be seen as if frames are missed and afterimages may appear.

Manual recording functions

Scene mode

This is for recording in various situations.



When you record images in different situations, this mode automatically sets optimum shutter speeds and apertures.

◇ Rotate the mode dial to select or .

1 Set the AUTO/MANUAL/FOCUS switch to MANUAL.

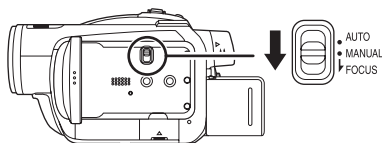

2 Press the MENU button, then select [BASIC] → [SCENE MODE] desired item and press the cursor button.

Sports

To record sports scenes or scenes where there are quick motions

Portrait

To make people stand out against the background

Low light

To make the scene brighter in dark conditions

Spotlight

To make the subject under a spotlight look more attractive

Surf & snow

To record images in bright places such as ski slopes and beaches

To cancel the scene mode function

Press the MENU button, then select [BASIC] → [SCENE MODE] → [OFF] and press the cursor button.

- You can also cancel the scene mode function by setting the AUTO/MANUAL/FOCUS switch to AUTO.

Sports mode

- For slow-motion playback or playback pause of recorded pictures, this mode helps diminish camera shake.
- During normal playback, the image movement may not look smooth.
- Avoid recording under fluorescent light, mercury light or sodium light because the colour and brightness of the playback image may change.
- If you record a subject illuminated with strong light or a highly reflective subject, vertical lines of light may appear.
- If the brightness is insufficient, the sports mode does not function. The display flashes.
- If this mode is used indoors, the screen may flicker.

Portrait mode

- If this mode is used indoors, the screen may flicker. If so, change the scene mode setting to [OFF].

Low light mode

- Extremely dark scenes may not be able to be recorded finely.

Spotlight mode

- If the recording subject is extremely bright, the recorded image may become whitish and the periphery of the recorded image extremely dark.

Surf & snow mode

- If the subject is extremely bright, the recorded image may become whitish.

Manual focus adjustment



If auto focusing is difficult due to the conditions, then manual focusing is available.

◇ Rotate the mode dial to select **VIDEO** or **PHOTO**.

1 (When MF assist function is used)
(HD mode only)

Press the **MENU** button, then select **[ADVANCED]** → **[MF ASSIST]** → **[ON]** and press the cursor button.

2 Set the **AUTO/MANUAL/FOCUS** switch to **MANUAL**.

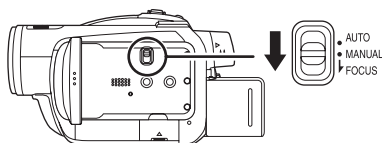

3 Move the switch down and set it to **FOCUS** position.



The manual focus indication [MF] and the icon shown in the illustration appear.

4 Move the cursor button left or right to bring the subject into focus.



To restore to the automatic adjustment

Press the **AUTO/MANUAL/FOCUS** switch down again to the **FOCUS** position.

- You can also restore the auto focusing by setting the **AUTO/MANUAL/FOCUS** switch to **AUTO**.
- The subject may not be in focus when zoomed in if focusing with a wide angle. First, zoom in on the subject, and then focus on it.



About the MF assist function (HD mode only)

The centre of the screen is enlarged during manual focus adjustment. This allows you to focus on the subject more easily.

The normal screen returns approximately 2 seconds after you finish bringing the subject into focus.

- The centre of the screen is not enlarged if **[MF ASSIST]** is set to **[OFF]**.
- MF assist does not work if the zoom magnification is more than 10×.
- The part of the screen that is enlarged is not enlarged on the image actually recorded.
- The zebra pattern does not appear on the part of the screen that is enlarged when **[ZEBRA]** is **[ON]**.

White balance

This is for recording in natural colours.



The automatic white balance function may not reproduce natural colours depending on the scenes or lighting conditions. If so, you can adjust the white balance manually.

◇ Rotate the mode dial to select or .

1 Set the AUTO/MANUAL/FOCUS switch to MANUAL.



The icon shown in the illustration is displayed automatically.

2 Move the cursor button up to select .



3 Move the cursor button left or right to select the white balance mode.



: Auto white balance adjustment

: Indoor mode (for recording under incandescent lamps)

- Incandescent lights, halogen lamps

: Outdoor mode

- Outdoors under a clear sky

: Manual adjustment mode

- Mercury-vapor lamps, sodium lamps, some fluorescent lights
- Lights used for wedding receptions at hotels, stage spotlights in theatres
- Sunrise, sunset etc.

To restore to the automatic adjustment

Set the white balance mode to .

- You can also restore the automatic adjustment by setting the AUTO/MANUAL/FOCUS switch to AUTO.

To set the white balance manually

1 Select , fill the screen with a white subject.

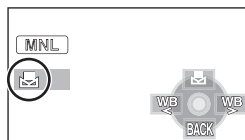

2 Move the cursor button up to select .

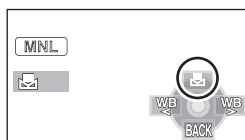

- When the display changes from flashing to on, setting is complete.
- When the display continues flashing, the white balance cannot be set because the place is dark etc. In this case, use the automatic white balance.

About the white balance sensor

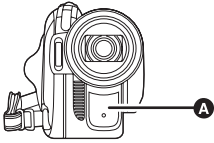

The white balance sensor **A** detects the type of light source during recording.

Do not cover the white balance sensor during recording, or it may not function properly.

About the black balance adjustment

This is one of the 3CCD system functions that automatically adjusts the black when the white balance is set in the manual adjustment mode. When the black balance is adjusted, the screen will temporarily be black. (The black balance cannot be adjusted manually.)

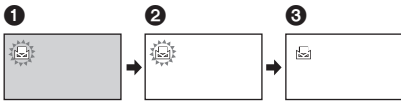

- 1 Black balance adjustment in progress. (Flashes.)
- 2 White balance adjustment in progress. (Flashes.)
- 3 Adjustment completed. (Lights up.)

- When the [WB] display flashes, the manual white balance previously adjusted is stored. Whenever recording conditions change, re-set the white balance for correct adjustment.
- When setting both the white balance and the iris/gain, set the white balance first.

Manual shutter speed/aperture adjustment



Shutter Speed:

Adjust it when recording fast-moving subjects.

Aperture:

Adjust it when the screen is too bright or too dark.

- ◇ Rotate the mode dial to select **◉** or **◻**.

1 Set the AUTO/MANUAL/FOCUS switch to MANUAL.



The icon shown in the illustration is displayed automatically.

2 Move the cursor button left or right to select [IRIS] (aperture) or [SHTR] (shutter speed).



3 Move the cursor button left or right to make the adjustment.



A Shutter speed:

HD mode:

1/25 to 1/8000

STD mode:

1/50 to 1/8000

- The shutter speed closer to 1/8000 is faster.
- (HD mode) If [AUTO SLOW SHTR] is set to [OFF], then the shutter speed will be set between 1/50 and 1/8000.

B Iris/Gain value:

CLOSE → (F16 to F2.0) → OPEN → (0dB to 18dB)

- Value closer to [CLOSE] darken the image.
- Value closer to [18dB] brighten the image.
- When the iris value is adjusted to brighter than [OPEN], it changes to the gain value.

To restore to automatic adjustment

Set the AUTO/MANUAL/FOCUS switch to AUTO.

- When setting both the shutter speed and the iris/gain value, set the shutter speed and then set the iris/gain value.

Manual shutter speed adjustment

- Avoid recording under fluorescent light, mercury light or sodium light because the colour and brightness of the playback image may change.
- If you increase the shutter speed manually, the gain value will increase automatically depending on how much the sensitivity lowers and the noise on the screen may increase.
- You may see vertical lines of light in the playback image of a brightly shining subject or highly reflective subject, but this is not a malfunction.
- During normal playback, image movement may not look smooth.
- When recording in an extremely bright place, the screen may change colour or flicker. If so adjust the shutter speed manually to [1/50] or [1/100].

Manual iris/gain adjustment

- If the gain value is increased, the noise on the screen increases.
- Depending on the zoom magnification, there are iris values that are not displayed.

Playback

Playback of motion pictures

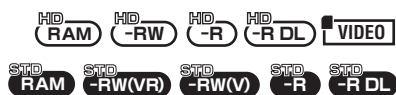

Play back the motion pictures recorded on the disc or SD card.

◇ HD mode

1 Rotate the mode dial to select

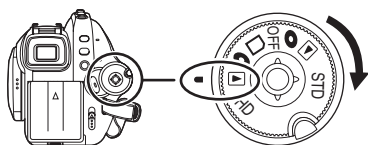

The lens cover closes.

2 Press the cursor button up and then select the [●] or [□] tab.

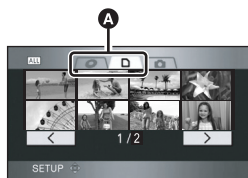

- A** Motion picture playback tab
The motion pictures recorded on the disc or SD card are displayed as thumbnails.

3 Select the scene to be played back.



- B** Previous page
 - C** Next page
 - D** Scene number
- The selected scene will be encircled by a yellow frame.
- If 9 or more scenes have been recorded, the next (or previous) page can be displayed by moving the cursor button left and right or moving the cursor button down, selecting [◀]/[▶] by moving the cursor button left and right and then pressing the centre of the cursor button.
 - The scene number display switches to the page number when the motion picture playback tab or [◀]/[▶] is selected.

4 Press the cursor button.



The selected scene is played back on the full screen.

- The operation icon is automatically displayed on the screen.

5 Move the cursor button to operate.

- ▶/||: Playback/Pause
- ◀◀: Rewind playback (→ 81)
- ▶▶: Fast forward playback (→ 81)
- : Stops the playback and shows the thumbnails.

Repeat playback

Playback of the first scene starts after playback of the last scene finishes.

Press the **MENU** button, then select **[PLAY SETUP]** → **[REPEAT PLAY]** → **[ON]** and press the cursor button.

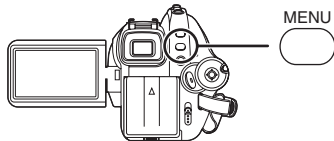

The [↺] indication appears on the thumbnail and full screen views.

- The following scenes can be played back repeatedly.
 - When [PLAY MODE] is set to [VIEW ALL]: All the scenes on the disc or SD card
 - When [PLAY MODE] is set to [BY DATE]: All the scenes on the selected date

To cancel the repeat playback function

Press the MENU button, then select [PLAY SETUP] → [REPEAT PLAY] → [OFF] and press the cursor button.

◇ STD mode

1 Rotate the mode dial to select

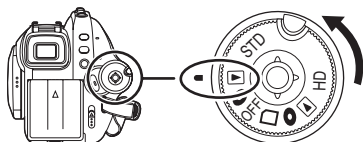

The lens cover closes.

- The motion pictures recorded on the disc are displayed as thumbnails.

2 Select the scene to be played back.

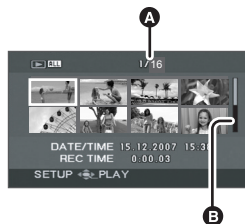

- **A** Scene number
- **B** Scroll bar display

The selected scene will be encircled by a yellow frame.

- When 9 or more scenes have been recorded, the next (or previous) page is displayed by moving the cursor button.
- If you move and hold the cursor button up or down, you can advance 8 scenes at a time. The screen will not change at this time, but the scene numbers and scroll bar display will change so release the cursor button when you have arrived at the page with the scene you want to display.

3 Press the cursor button.

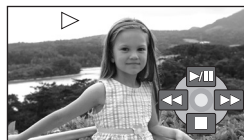

The selected scene is played back on the full screen.

- The operation icon is automatically displayed on the screen.

4 Move the cursor button to operate.

- ▶/||: Playback/Pause
- ◀◀: Rewind playback (→ 81)
- ▶▶: Fast forward playback (→ 81)
- : Stops the playback and shows the thumbnails.

- Discs recorded in HD mode cannot be played back in STD mode and discs recorded in STD mode cannot be played back in HD mode.

- No sound will be heard except during normal playback.
- If pause play is continued for 5 minutes, the screen returns to the thumbnails.
- When the amount of time recorded on the scene is short, playback may not be possible.
- Scenes which cannot be displayed as thumbnails (the thumbnails are displayed as [!]) cannot be played back.
(HD mode) An error message appears and the screen shows the thumbnails.
- The power will not turn off when the LCD monitor and the viewfinder are closed and retracted.
- The date/time displayed may be different from the recording date/time and it may take time to display the thumbnail display when playing back motion pictures not recorded on this unit.
- (HD mode) The remaining time for playback indication will be reset to "0h00m00s" each scene.
- The high definition picture quality video signals that can be played back on this unit are 1920×1080/50i or 1440×1080/50i.
- (HD mode) This unit may degrade or not playback motion pictures recorded or created on other products, and other products may degrade or not playback motion pictures recorded on this unit, even if the products support AVCHD.
- (HD mode) If you continuously record motion picture data that exceeds 4 GB on an SD card and then play back the data on another device, the picture may momentarily stop where the data has reached 4 GB.
- If motion pictures recorded on another device with a 4:3 aspect ratio are played back on this unit in STD mode, the images on the LCD monitor and the viewfinder are squeezed vertically.

Fast forward/rewind playback

Move the cursor button right during playback.

(Move the cursor button left to rewind.)



- Move the cursor button again to increase the speed. (The screen display changes from ►► to ►►►.)
- Normal playback is restored when you move the cursor button up.

Operating with the remote control

Press the ◀◀ or ▶▶ button.

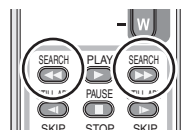

Skip playback (to the start of a scene)

(Operation is possible with the remote control only.)

Press the ◀◀ or ▶▶ button on the remote control during playback.



Slow-motion playback

- 1 Move the cursor button up during playback to pause the playback.
- 2 Move and hold the cursor button right. (Slow-motion pictures will be played back in reverse when you move and hold the cursor button left.)



- Normal playback is restored when you move the cursor button up.
- When slow-motion pictures are played back in reverse, they will be shown continuously at approximately 1/1.5th the speed of normal playback in HD mode (intervals of 0.5 seconds) and at approximately 1/5th the speed of normal playback in STD mode.

Operating with the remote control

Press the ◀ or ▶ button.

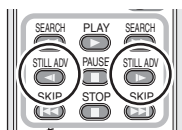

Frame-by-frame playback

The motion picture is advanced one frame at a time.

- 1 Move the cursor button up during playback to pause the playback.
- 2 Move the cursor button right. (The frames will be advanced one at a time in reverse when you move the cursor button left.)



- Normal playback is restored when you move the cursor button up.
- If the frames are advanced one at a time in reverse when in HD mode, they will be shown in intervals of 0.5 seconds.

Operating with the remote control

- 1 Press the ||| button.

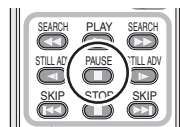

- 2 Press the ◀ or ▶ button.

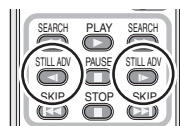

To adjust the volume

Adjust the speaker volume during playback.

Move the volume lever to change the volume level.

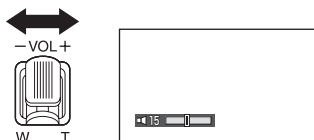

Towards “+”:

increases the volume

Towards “-”:

decreases the volume

- The further the [] indicator moves to the right, the higher the volume level becomes.
- When the adjustment is completed, the volume setting display will disappear.

Playing back motion pictures by date

Recorded scenes are grouped by date on this unit.

Scenes recorded on the same day can be played back in succession.

- 1 Press the MENU button, then select [PLAY SETUP] → [PLAY MODE] → [BY DATE] and press the cursor button.**

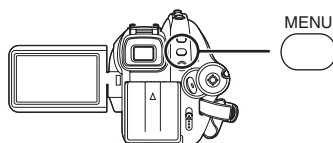

- 2 Select the date for playback, then press the cursor button.**



The scenes recorded on the same day are displayed as thumbnails.

- 3 Select the scene to be played back.**

To return to playing back all the scenes

Press the MENU button, then select [PLAY SETUP] → [PLAY MODE] → [VIEW ALL] and press the cursor button.

- When [PLAY MODE] is set to [VIEW ALL], all recorded motion pictures will be played back in succession. ([ALL] is displayed.)

- Playing back all the scenes returns if the power is turned off or the mode dial is operated.
- Even if scenes are recorded on the same day, they are grouped separately in the following cases.

– When the number of scenes exceeds 99



– When the recording mode is changed from HN/HE to HG or HG to HN/HE (–1, –2... is added after the recording date displayed on the screen.)



– When the layers switch on a DVD-R DL



Resuming the previous playback

If playback of a scene was stopped halfway, the playback can be resumed from where it was stopped.

Press the MENU button, then select [PLAY SETUP] → [RESUME PLAY] → [ON] and press the cursor button.



If playback of a motion picture is stopped, [▶▶] appears on the thumbnail view of the stopped scene.

To cancel the resume playback function

Press the MENU button, then select [PLAY SETUP] → [RESUME PLAY] → [OFF] and press the cursor button.

- The memorised resume position is cleared if you turn off the power, operate the mode dial or eject the disc. (The [RESUME PLAY] setting is kept.)

Playback of still pictures (JPEG) on an SD card

PHOTO

Play back the still pictures recorded on the card.

1 Rotate the mode dial to select

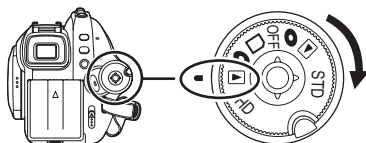

The lens cover closes.

2 Press the cursor button up and then right to select the [P] tab.

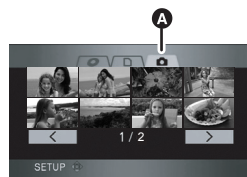

- A** Still picture playback tab
The still pictures recorded on the SD card are displayed as thumbnails (reduced-size images).

3 Select the file to be played back.



- B** Previous page
- C** Next page
- D** File number
- E** Folder/file name

The selected file will be encircled by a yellow frame.

- If 9 or more files have been recorded, the next (or previous) page can be displayed by moving the cursor button left and right or moving the cursor button down, selecting [◀] / [▶] by moving the cursor button left and

right and then pressing the centre of the cursor button.

- The file number display switches to the page number when the still picture playback tab or [<] / [>] is selected.

4 Press the cursor button.



The selected file is played back on the full screen.

- The operation icon is automatically displayed on the screen.

5 Move the cursor button to operate.

- ▶/||: Slide show (playback of the still pictures on the SD card in numerical order) start/pause.
- ◀: Plays back the previous picture.
- ▶: Plays back the next picture.
- : Stops the playback and shows the thumbnails.

■ About still picture compatibility

- This unit is compliant with the unified standard DCF (Design rule for Camera File system) established by JEITA (Japan Electronics and Information Technology Industries Association).
 - The file format supported by this unit is JPEG. (Not all JPEG formatted files will be played back.)
 - If a non-standard file is played back, the folder/file name may not be displayed.
 - This unit may degrade or not play back data recorded or created on another product and another product may degrade or not play back data recorded on this unit.
-
- While this unit accesses the SD card (the access lamp is lit), do not remove the SD card.
 - Do not operate the mode dial during the slide show.
 - It takes time to display the file depending on the number of pixels of the file.
 - Files which cannot be displayed as thumbnails (the thumbnails are displayed as [?]) cannot be played back.
 - If you attempt to play back a file which is a different format or a damaged file, an error message appears and the screen shows the thumbnails.
 - The date/time displayed may be different from the recording date/time and it may take time to display the thumbnail display when playing back still pictures not recorded on this unit.
 - The power will not turn off when the LCD monitor and the viewfinder are closed and retracted.

Editing

Editing scenes

Deleting scenes

This is for deleting scenes.



The deleted scenes cannot be restored.

- (HD mode) The remaining space on DVD-RW, DVD-R and DVD-R DL will not increase even if scenes are deleted.
- (STD mode) Scenes on DVD-RW (Video format), DVD-R and DVD-R DL cannot be deleted.

Deleting scenes one at a time

HD mode

- ◇ Rotate the mode dial to select and then select the or tab.

STD mode

- ◇ Rotate the mode dial to select .

- 1 Press the button during playback.

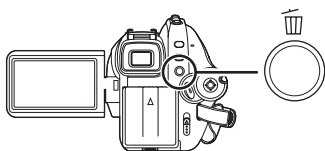

- 2 When the confirmation message appears, select [YES], then press the cursor button.

Deleting multiple scenes from the thumbnail display

HD mode

- ◇ Rotate the mode dial to select and then select the or tab.

STD mode

- ◇ Rotate the mode dial to select .

- 1 Press the button while the thumbnail view screen is displayed.

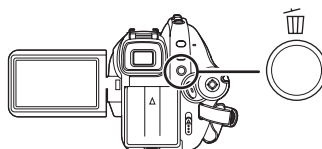

- 2 Move the cursor button up or down to select [ALL SCENES] (HD mode)/[ALL] (STD mode) or [SELECT] and press the cursor button.

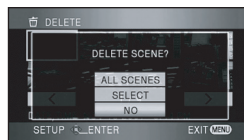

- When [ALL SCENES] (HD mode)/[ALL] (STD mode) is selected, the following scenes except the protected scenes will be deleted. Proceed to step 5.
 - When [PLAY MODE] is set to [VIEW ALL]: All the scenes on the disc or SD card
 - When [PLAY MODE] is set to [BY DATE]: All the scenes selected by date

- 3** (Only when [SELECT] is selected in step 2)
Select the scene to be deleted, then press the cursor button.



The selected scene is encircled by a red frame.

- When the cursor button is pressed again, the selected scene will be cancelled.
- Up to 99 scenes (HD mode)/8 scenes (STD mode) can be set in succession.

- 4** (Only when [SELECT] is selected in step 2)
Press the  button.

- 5** When the confirmation message appears, select [YES], then press the cursor button.

(Only when [SELECT] is selected in step 2)

To continue deleting other scenes

Repeat steps 3-5.

To complete editing

Press the MENU button.

- You can also delete scenes by pressing the MENU button, selecting [EDIT SCENE] → [DELETE] and then selecting [ALL SCENES] (HD mode)/[ALL] (STD mode) or [SELECT].
- To delete an unwanted part of a scene, divide the scene first, and then delete the unnecessary part. (→ 87)
- Scenes which cannot be played back (the thumbnails are displayed as ) cannot be deleted.
- Protected scenes cannot be deleted.
- Do not open the card slot cover while deleting. The deletion will stop.
- In case of [ALL SCENES] (HD mode)/[ALL] (STD mode), the deletion may take time if there are many scenes on the disc or SD card.
- Do not turn off this unit while deleting.
- When you delete scenes, use a battery with sufficient battery power or use the AC adaptor.



- If you delete scenes recorded on other products with this unit, all the data related to the scenes may be deleted.
- (STD mode) It may not be possible to delete scenes that have been divided.

Dividing a scene to delete
 This is for dividing a scene into two to delete an unnecessary portion.



To delete an unnecessary portion of a scene, first divide the scene and then delete the unnecessary portion.

HD mode

- ◇ Rotate the mode dial to select  and then select the  or  tab.

STD mode

- ◇ Rotate the mode dial to select  .

- 1** Press the MENU button, then select [EDIT SCENE] → [DIVIDE] → [SET] (HD mode) or [YES] (STD mode) and press the cursor button.

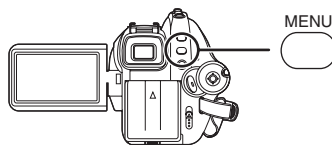

- 2** Select the scene to be divided, then press the cursor button.



The selected scene is played back.

3 When you reach the area where you want to divide the scene, press the cursor button down to set the dividing point.

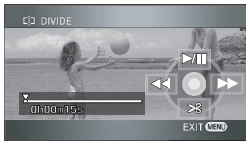

- Using slow-motion playback or frame-by-frame playback makes it easy to search for the point where you want to divide the scene. (→ 82)

4 When the confirmation message appears, select [YES], then press the cursor button.

5 Delete the unnecessary scenes.

- Refer to P86 for deleting scenes.

To continue dividing other scenes
Repeat steps 2-4.

To complete editing
Press the MENU button.

(HD mode only)

To delete all the divided points

Press the MENU button, then select [EDIT SCENE] → [DIVIDE] → [CANCEL ALL] and press the cursor button.

- When the confirmation message appears, select [YES], then press the cursor button.
- All divided points set on this unit will be cancelled.
- The scenes that were deleted after division cannot be recovered.

- Scenes cannot be divided if the number of scenes has reached 999.
- When the amount of time recorded on the scene is too short, dividing may not be possible.
- If images that have been divided are played back on another device, the points where the scenes join may not be clear.

- Data that has been recorded on another device cannot be divided.
- When [CANCEL ALL] is selected, the divided points of all scenes are deleted and the unit turns back to the setting that plays back all scenes even if you selected to play back the scenes by date.
- Data that has been recorded or edited on another device cannot be divided and the divided points cannot be deleted.
- Discs other than DVD-RAM cannot be divided or deleted and the divided points cannot be deleted when the remaining space on the disc becomes small.

Protecting scenes
This is for preventing scenes from being deleted by mistake.



Recorded scenes can be protected so that they are not deleted by mistake.
(Even if you protect some scenes, formatting the disc or SD card will delete them.)

◇ Rotate the mode dial to select and then select the or tab.

- 1 Press the MENU button, then select [PLAY SETUP] → [SCENE PROTECT] → [YES] and press the cursor button.**
- 2 Select the scene to be protected and then press the cursor button.**



The indication appears and the scene is protected.

- Press the cursor button again to cancel the setting.
- 2 or more scenes can be set in succession.

To complete the settings
Press the MENU button.

Copying from an SD card to a disc



You can easily copy motion pictures recorded on an SD card with this unit to a disc.

- Compatible discs are DVD-RAM, DVD-RW, DVD-R and DVD-R DL.

Copying all the scenes at one time

- ◇ Connect the AC adaptor to this unit, then insert a DVD-RAM or a DVD-RW formatted on this unit (→ 94) or a new disc.

- ◇ Rotate the mode dial to select and then select the [D] tab.

- 1 Press the DISC COPY button while the thumbnail view screen is displayed.

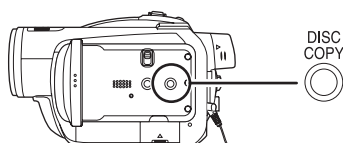

- 2 Move the cursor button up or down to select [YES] and press the cursor button.



- A** The number of discs necessary for copying by disc type.
- When 2 or more discs are necessary for copying, follow the on-screen instructions to switch discs.
- When copying is complete, press the MENU button to exit the message screen.

Selecting the scenes to copy

- ◇ Connect the AC adaptor to this unit, then insert a DVD-RAM or a DVD-RW formatted on this unit (→ 94) or a new disc.

- ◇ Rotate the mode dial to select and then select the [D] tab.

- 1 Press the MENU button, then select [DISC COPY] → [COPY SELECT] → [YES] and press the cursor button.

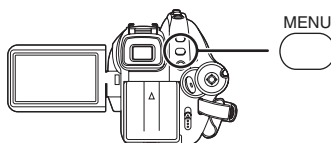

- 2 Select the scene to be copied and then press the cursor button.

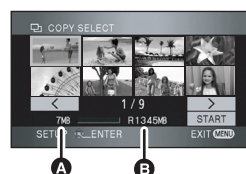

- A** Scene size
 - B** Remaining space on the disc
- The selected scene is encircled by a red frame.
- When the cursor button is pressed again, the selected scene will be cancelled.
 - Up to 99 scenes can be set in succession.
 - If you select a scene with a scene size that exceeds the remaining space on the disc, the remaining space on the disc display will turn red and the amount exceeded will be displayed.

Cancel the selected scene and select scenes that do not exceed the space on 1 disc.

- 3 Move the cursor button up or down to select [START] and press the cursor button.

4 When the confirmation message appears, select [YES], then press the cursor button.

To complete copying

Press the MENU button.

- Do not turn off the power on this unit while copying.
- You can copy all the scenes at one time when [COPY ALL] is selected in step 1.
- We recommend preparing a spare disc before copying.
- The order in which the scenes were copied cannot be changed.
- Data that has been recorded on another device cannot be copied.
- When 2 or more discs are necessary for copying, the last scene copied to a disc is automatically divided to fit the space on the disc.
- If you will delete all the data on the SD card when copying is complete, be sure to play back the discs to check that they have been copied correctly before deleting.

Editing still pictures

Deleting still pictures

This is for deleting still picture files recorded on SD cards.

PHOTO

The deleted files cannot be restored.

Deleting files one at a time

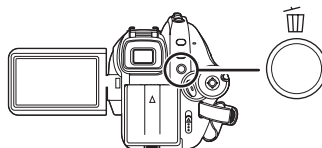

◇ Rotate the mode dial to select and then select the [] tab.

1 Press the  button during playback.



2 When the confirmation message appears, select [YES], then press the cursor button.

Deleting multiple files from the thumbnail display

- ◇ Rotate the mode dial to select  and then select the  tab.

- 1** Press the  button while the thumbnail view screen is displayed.

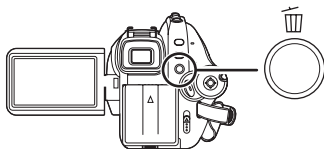

- 2** Move the cursor button up or down to select [ALL SCENES] or [SELECT] and press the cursor button.

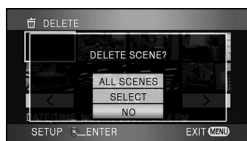

- When [ALL SCENES] is selected, all files on the SD card except the protected files will be erased. Proceed to step 5.

- 3** (Only when [SELECT] is selected in step 2) **Select the file to be deleted, then press the cursor button.**

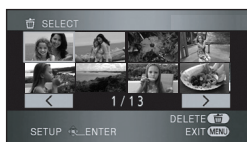

The selected file is encircled by a red frame.

- When the cursor button is pressed again, the selected file will be cancelled.
- Up to 99 files can be set in succession.

- 4** (Only when [SELECT] is selected in step 2) **Press the  button.**

- 5** When the confirmation message appears, select [YES], then press the cursor button.

(Only when [SELECT] is selected in step 2)

To continue deleting other files

Repeat steps 3-5.

To complete editing

Press the MENU button.

Deleting still picture files recorded on an SD card by other products

A still picture file (other than JPEG) that cannot be played back on this unit may be erased.



- Protected files cannot be deleted.
- Do not open the card slot cover while deleting. The deletion will stop.
- In case of [ALL SCENES], the deletion may take time if there are many files on the SD card.
- Do not turn off this unit while deleting.
- When you delete files, use a battery with sufficient battery power or use the AC adaptor.
- If files conforming to DCF standard are deleted, all the data related to the files will be deleted.

Protecting still pictures

This is for preventing still picture files from being deleted by mistake.

PHOTO

Files recorded on an SD card can be protected so that they are not deleted by mistake. (Even if you protect some files on an SD card, formatting the SD card will delete them.)

◇ Rotate the mode dial to select  and then select the  tab.

1 Press the MENU button, then select [PLAY SETUP] → [SCENE PROTECT] → [YES] and press the cursor button.

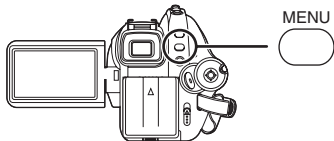

2 Select the file to be protected and then press the cursor button.



The  indication appears and the file is protected.

- Press the cursor button again to cancel the setting.
- 2 or more files can be set in succession.

To complete the settings



Press the MENU button.

DPOF setting

This is for writing the printing data on an SD card.

PHOTO

You can write the data of the still pictures to be printed and the number of prints (DPOF data) onto the SD card.

◇ Rotate the mode dial to select  and then select the  tab.

1 Press the MENU button, then select [PLAY SETUP] → [DPOF SET] → [SET] and press the cursor button.

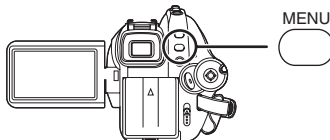

2 Select the file to be set and then press the cursor button.



The number of prints set to be in DPOF is displayed.

3 Move the cursor button up or down to select the number of prints, then press the cursor button.

- You can select from 0 to 999. (The selected number of pictures can be printed with the printer supporting DPOF.)
- To cancel the setting, set the number of prints to [0].
- You can also select multiple files in succession.

To complete the settings

Press the MENU button.

To cancel all DPOF settings

Press the MENU button, then select [PLAY SETUP] → [DPOF SET] → [CANCEL ALL] and press the cursor button.

- When the confirmation message appears, select [YES], then press the cursor button.
-

■ What is DPOF?

DPOF stands for Digital Print Order Format. This enables picture printing information to be written onto an SD card so that it can be used on a system supporting DPOF.

- The DPOF setting can be established for up to 999 prints.
- DPOF setting made on other devices may not be recognised by this unit. Please perform the DPOF settings on this unit.
- You cannot add the recording date to pictures to be printed with the DPOF settings.

Disc and card management

Formatting

Formatting discs

This is for initializing discs.



Please be aware that if a disc is formatted, then all the data recorded on the disc will be erased. Store important data on a computer, etc.

HD mode

◇ Rotate the mode dial to select or and then select the [] tab.

STD mode

◇ Rotate the mode dial to select or .

1 Press the MENU button, then select [DISC SETUP] or [SETUP] → [FORMAT DISC] → [YES] and press the cursor button.

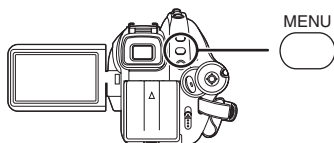

2 (When formatting a DVD-RW in STD mode only)

Select format type, then press the cursor button.



3 When the confirmation message appears, select [YES], then press the cursor button.

- When formatting is complete, press the MENU button to exit the message screen.

- Use this unit to format discs. If a disc is formatted on other products (such as a computer), the time spent for recording may become longer and you may not be able to use the disc.
- In the case of a double sided disc, format each side.
- It may not be possible to format a disc with many scratches or dirt. Such discs cannot be used.
- During formatting, do not turn this unit off.
- When you format the disc, use a battery with sufficient battery power or the AC adaptor.
- Refer to P23 about formatting discs recorded on another device or in another mode.

Formatting SD cards

This is for initializing SD cards.



Please be aware that if an SD card is formatted, then all the data recorded on the card will be erased. Store important data on a computer, etc.

◇ Rotate the mode dial to select or .

1 Press the MENU button, then select [SETUP] → [FORMAT CARD] → [YES] and press the cursor button.

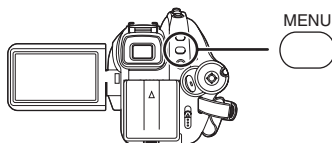

2 When the confirmation message appears, select [YES], then press the cursor button.

- When formatting is complete, press the MENU button to exit the message screen.
-
- Use this unit to format SD cards. If an SD card is formatted on other products (such as a computer), the time spent for recording may become longer and you may not be able to use the SD card.
 - Depending on the type of SD card being used, it may take time to format.
 - During formatting, do not turn this unit off.
 - When you format the SD card, use a battery with sufficient battery power or the AC adaptor.
 - Do not open the card slot cover while formatting.

Finalizing a disc

Finalizing a disc



If you insert a DVD-RW, DVD-R or DVD-R DL disc recorded in this unit (that has not been finalized) into another device such as DVD recorder, computer, etc., the disc may become unusable.

Be sure to finalize the disc on this unit before inserting it in other devices.

To allow the disc to be played back on other devices that support AVCHD (HD mode)

Important Notice

Do not insert discs which have been recorded in AVCHD format into devices which do not support the AVCHD format. In some cases the disc may get stuck in the device. The disc will not play back on devices that do not support the AVCHD format.

DVD-RW, DVD-R and DVD-R DL:

- After finalizing, the disc becomes play-only and you can no longer record.
- When you un-finalize a DVD-RW, the disc can be used for recording again. (→ 96)

DVD-RAM:

- It is not necessary to finalize DVD-RAM.

To allow the disc to be played back on other DVD players etc. (STD mode)

DVD-RAM:

- It is not necessary to finalize DVD-RAM.



DVD-RW (VR format):

- DVD-RW (VR format) after finalization can be recorded and edited in the same way as DVD-RW (VR format) before finalization.
- After finalizing a DVD-RW (VR format) once, you cannot finalize it again. (Even if you record on or edit a DVD-RW (VR format) after finalizing, it is not necessary to finalize it again.)

DVD-RW (Video format), DVD-R and DVD-R DL:

- After finalizing, the disc becomes play-only and you can no longer record.
- When you un-finalize a DVD-RW (Video format), the disc can be used for recording again. (→ 96)

HD mode

- ◇ Rotate the mode dial to select  and then select the [] tab.

STD mode

- ◇ Rotate the mode dial to select  .

1 Connect this unit to the AC adaptor.

- Finalization cannot be executed when using a battery.
- If the power supply stops while finalizing, the finalization will fail and the data may be damaged.

- 2 Press the MENU button, then select [DISC SETUP] → [FINALIZE] → [YES] and press the cursor button.**

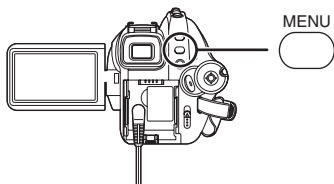

- 3 When the confirmation message appears, select [YES], then press the cursor button.**

- When finalizing is complete, press the MENU button to exit the message screen.

HD mode

- When finalizing a DVD-RW, DVD-R or DVD-R DL a top menu containing thumbnails is created.

STD mode

- When finalizing a DVD-RW (Video format) or DVD-R, a top menu containing thumbnails is created.

-
- Do not finalize a disc recorded on this unit using any other device.
 - In the case of a double sided disc, finalize each side.
 - The top menu created when finalizing does not appear on this unit. It appears when the disc is played back on other devices.
 - Depending on the condition of the disc, the time it takes for finalizing will differ. It may take up to 22 minutes.
 - Do not allow the unit to be heavily vibrated or shaken while finalizing a disc. Doing so may prevent the disc from being finalized resulting in an unplayable disc.
 - If the power supply stops while finalizing, the finalization will fail and the disc may become unplayable on other devices even if disc repair is carried out.

Un-finalizing a DVD-RW
This is for un-finalizing a DVD-RW so that it can be used for recording.



HD mode

- ◇ Rotate the mode dial to select and then select the [] tab.

STD mode

- ◇ Rotate the mode dial to select .

- 1 Press the MENU button, then select [DISC SETUP] → [UN-FINALIZE] → [YES] and press the cursor button.**

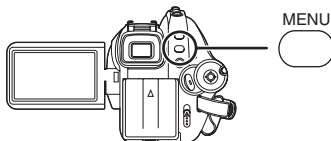



- 2 When the confirmation message appears, select [YES], then press the cursor button.**

- When un-finalizing is complete, press the MENU button to exit the message screen.
-
- (HD mode) Discs other than DVD-RW cannot be un-finalized. If there is no space remaining on the DVD-RW, the disc may not be un-finalized.
 - (STD mode) Discs other than DVD-RW (Video format) cannot be un-finalized. DVD-RW (VR format) after finalization can be recorded and edited in the same way as DVD-RW (VR format) before finalization.
 - When you un-finalize the disc, use a battery with sufficient battery power or the AC adaptor.

Creating a top menu

A top menu is displayed when a DVD-RAM is played back on other devices that support AVCHD.



- ◇ Rotate the mode dial to select  and then select the [] tab.

1 Connect this unit to the AC adaptor.

- Creating a top menu cannot be executed when using a battery.
- If the power supply stops while creating a top menu, the creating a top menu will fail and the data may be damaged.

2 Press the MENU button, then select [DISC SETUP] → [CREATE TOP MENU] → [YES] and press the cursor button.

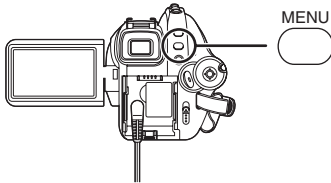

3 When the confirmation message appears, select [YES], then press the cursor button.

- After creating the top menu, press the MENU button to exit the message screen.
-
- If a top menu is created, the disc becomes play-only and you can no longer record.
 - The top menu that was created is not displayed on this unit. It is displayed when the disc is played back on other devices that support AVCHD.
 - Except for DVD-RAM, the top menu is created during finalizing.
-

Deleting the top menu

If you insert a DVD-RAM which a top menu was created on, the confirmation message appears when you set a recording mode. If you select [YES] to erase the top menu, the DVD-RAM can be recorded and edited in the same way as before the top menu was created.

Protecting a disc





This is for protecting discs (write protection) when they are being ejected from this unit to prevent them from being formatted if they are inserted in other devices.

Discs protected using this unit cannot be edited or used to record on other devices, but they can be used the same as unprotected discs with this unit.

Auto Protect Operation

	Insert into unit →	Operations on the unit →	Status of ejected disc
Protected disc	When auto protect is [ON]	Motion picture recording, editing, etc.	Protected
		Playback only	
Unprotected disc		Motion picture recording, editing, etc.	Unprotected
		Playback only	
Protected disc	When auto protect is [OFF]	Motion picture recording, editing, etc.	Unprotected
		Playback only	Protected
Unprotected disc		Motion picture recording, editing, etc.	Unprotected
		Playback only	

- After disc writing operations (recording motion pictures, editing, finalizing, un-finalizing, creating a top menu and deleting a top menu), the disc is protected when [AUTO PROTECT] is [ON], and it is not protected when [AUTO PROTECT] is [OFF].
- When the protected disc is ejected, "WRITE PROTECTED DISC-CANNOT BE RECORDED BY OTHER DEVICES." appears on the screen.

- ◇ Rotate the mode dial to select  or  and then select the [] tab. Press the MENU button, then select [DISC SETUP] or [SETUP] → [AUTO PROTECT] → [ON] and press the cursor button.

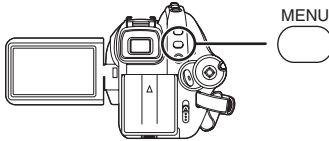

- This function's default setting is [ON].
- We recommend that the auto protect function is set to [ON] in order to prevent accidental deletion on other devices. If discs recorded on this unit are inserted into other devices without protecting them, a message may be displayed prompting you to format the disc. If the disc is formatted, the data on it will be erased, and the process cannot be reversed.

- Even if a disc with no recorded motion pictures is ejected, it will not be protected.

■ To release the disc protection

Erase all the motion pictures on the disc or format the disc.

- Please be aware that if a disc is formatted, then all the data recorded will be erased and cannot be recovered.
- The disc will need to be re-formatted on the device you will use.

Disc protection setting



This is for preventing recorded contents from being deleted or edited by mistake. Further recording and editing is not possible on protected discs until the protection is released.

- ◇ Rotate the mode dial to select  .

- 1 Press the MENU button, then select [DISC SETUP] → [DISC PROTECT] and press the cursor button.

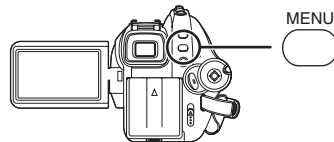

- 2 When the confirmation message appears, select [YES], then press the cursor button.

To release disc protection

- 1) Press the MENU button, then select [DISC SETUP] → [DISC PROTECT] and press the cursor button.
- 2) When the confirmation message appears, select [YES], then press the cursor button.

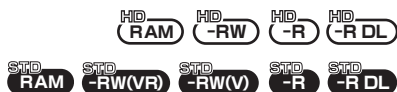

- If the disc has been protected on another device, it may not be possible to release the protection on this unit. In this case, release the protection on the device that you used to protect it.

Displaying disc information





Information such as the type of recorded disc, the number of recorded scenes, the remaining space, whether or not the disc is finalized etc. is displayed.

HD mode

- ◇ Rotate the mode dial to select  and then select the [] tab.

STD mode

- ◇ Rotate the mode dial to select  or  .

Press the MENU button, then select [DISC SETUP] → [INFORMATION] → [YES] and press the cursor button.

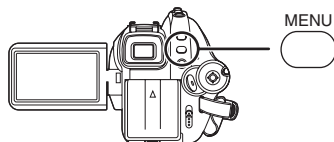

To exit the information screen

Press the MENU button.

With other products

With a TV

Playback on TV

The motion pictures and still pictures recorded on this unit can be played back on a TV screen.

Connect this unit to a TV with one of the following terminals. When connecting to a HDMI terminal, a connection cable (optional) is necessary.

◇ **Difference in picture quality depending on the terminal used for connection**

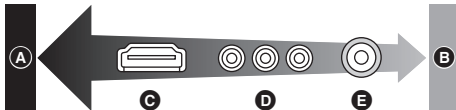

- A** High Definition images
- B** Standard images until now
- C** HDMI terminal
- D** Component terminal
- E** Video terminal

- Connect with the AV cable for pictures recorded in conventional standard picture quality. The pictures cannot be played back in high definition picture quality.

TV you use	Reference items
TV with a HDMI terminal	① Connecting with a HDMI cable (optional) (→ 102)
TV with a component terminal	② Connecting with the component cable (supplied) and the AV cable (supplied) (→ 104)
Other TVs	③ Connecting with the AV cable (supplied) (→ 105)

- Do not use any other AV cables except the supplied one.
- Do not use any other component cables except the supplied one.
- Use the AC adaptor to free you from worrying about the battery running down.

■ To display the on-screen information on the TV

The information displayed on the screen (operation icon, time code etc.) can be displayed on the TV.

Press the EXT DISPLAY button on the remote control.

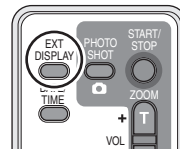

- Press the button again to erase the information.
- The screen on this unit will not change.

Refer to the following support site for information about the Panasonic TVs that you can directly insert an SD card into the SD card slot on the TV and then play it back.

<http://panasonic.net/>

- For details on how to play back, please read the operating instructions for the TV.

1 Connecting with a HDMI cable (optional)



What is HDMI?

HDMI is the next-generation interface for digital devices. When this unit is connected to a HDMI compatible device, the image and audio can be output with a digital signal. If you connect this unit and a HDMI compatible high definition TV and then play back the recorded high definition images (→ 7), you can enjoy them in high resolution with high quality sound.

If you connect this unit to a Panasonic TV (VIERA) compatible with VIERA Link, linked operations are possible. (→ 107)

- Use the AC adaptor to free you from worrying about the battery running down.

1 Connect this unit and a TV with the HDMI cable (optional).

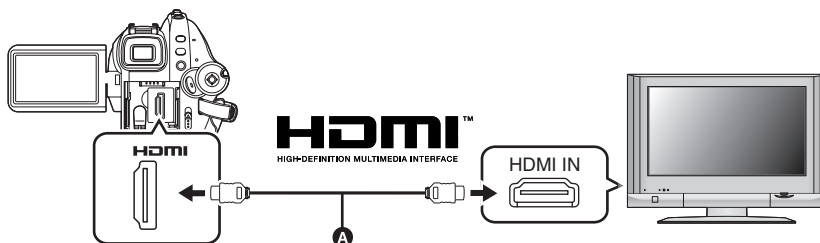

- Use a HDMI cable (optional) **A** with the logo shown on above.

2 Set the mode dial to to turn on the power.

3 Select the input channel on the TV.

Example:

Select the [HDMI] channel etc.

(The name of the channel may differ depending on the connected TV.)

4 Start playback on this unit.

The image and audio are output on the TV.

■ If the image or audio from this unit is not output on the TV

- Check that the plugs are inserted as far as they go.
- Check the connected terminal.
- Check the input setting (input switch) and the audio input setting on the TV.
(For more information, please read the operating instructions for the TV.)
- Check [HDMI RESOLUTION]. (→ 103)

■ About the settings when connecting with HDMI

When this unit is connected to another device with a HDMI cable, the output setting on this unit can be changed.

HDMI output resolution

You can switch the method to output the images.

Press the MENU button, then select [SETUP] → [HDMI RESOLUTION] desired item and press the cursor button.

[AUTO]: The output resolution is automatically set based on the information from the connected TV.

Information from the connected TV	Output resolution
720p, 1080i	1080i
Others	576p

[1080i]: The interlace method with 1080 available scan lines is used for output.

[576p]: The progressive method with 576 available scan lines is used for output.

- If the images are not output on the TV when the setting is [AUTO], switch to the method – [1080i] or [576p] – which enables the images to be displayed on your TV. (Please read the operating instructions for the TV.)
- Be sure to connect to an HDMI input terminal. Do not connect to an HDMI output terminal on other products.

1080i

This is an interlace scan method which scans 1080 scan lines to display a high definition image. The 1080 available scan lines are divided in half and scanned on the screen alternatively every 1/50th of a second. The number of available scan lines is nearly double the 576 scan lines used to display standard images until now so the images have clearer detail and a lot of presence.

576p

This is a progressive scan method which scans all 576 available scan lines on the screen at the same time every 1/50th of a second. This method reduces the flickering as the scan lines are not scanned on the screen alternatively like in the interlace method.

576i

This is an interlace scan method in which the 576 available scan lines are divided in half and scanned on the screen alternatively every 1/50th of a second.

Interlace method/progressive method

Video signals until now (PAL) are referred to as 576i ("i" is short for interlace) whereas a high-density video signal that doubles the number of scan lines is called 576p ("p" is short for progressive).

The component terminal and the HDMI terminal on this unit are also compatible with high definition image output [1080i]. It is necessary to have a compatible TV to enjoy progressive and high definition images.

2 Connecting with the component cable (supplied) and the AV cable (supplied)



- Use the AC adaptor to free you from worrying about the battery running down.

1 Connect this unit and a TV with the component cable (supplied) and the AV cable (supplied).

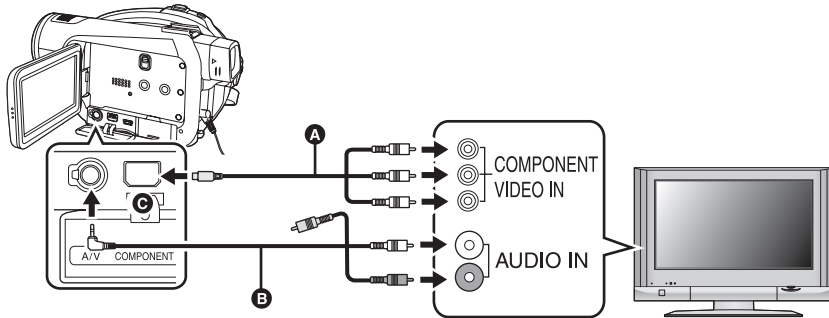

A Component cable (supplied)

B AV cable (supplied)

- Connect to terminals of the same colour.
- The component terminal  is for outputting images only so be sure to also connect the AV cable. (Insert it in the audio input terminal for the component terminal input. Refer to the operating instructions of the TV for details.)

2 Set the mode dial to to turn on the power.

3 Select the input channel on the TV.

Example:

Select the [Component] channel etc.

(The name of the channel may differ depending on the connected TV.)

4 Start playback on this unit.

The image and audio are output on the TV.

About the setting when connecting the component terminals

When this unit is connected to a TV with the component cable, the output setting on this unit can be changed. Set it to match the terminal on the TV that you connect to.

Press the MENU button, then select [SETUP] → [COMPONENT OUT] desired item and press the cursor button.

[576i]: When connecting to the component terminal on the TV compatible with 576i.
(Playback is in standard quality.)

[1080i]: When connecting to the component terminal on the TV compatible with 1080i.
(Playback is in high definition quality.)

■ If the image or audio from this unit is not output on the TV

- Check that the plugs are inserted as far as they go.
 - Check the connected terminal.
 - **Check the TV's input setting (input switch).** (For more information, please read the operating instructions for the TV.)
-
- If the images are not displayed correctly on a wide-screen TV, adjust the setting in screen mode on the TV. (For more information, please read the operating instructions of the TV.) If the pictures are displayed squeezed horizontally on a regular TV (4:3), change the setting on this unit. (→ 106)

③ Connecting with the AV cable (supplied)



- Use the AC adaptor to free you from worrying about the battery running down.

1 Connect this unit and a TV with the AV cable (supplied).

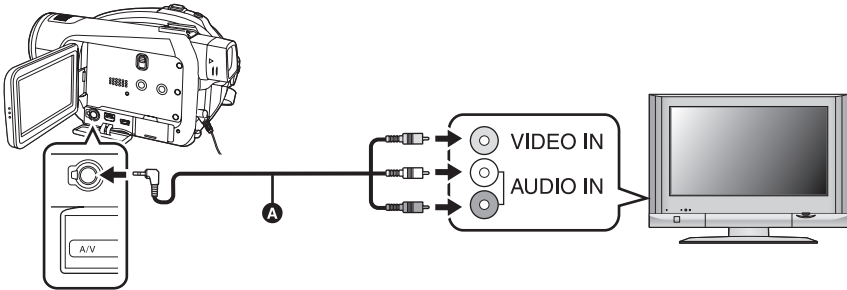

- A** AV cable (supplied)

2 Set the mode dial to to turn on the power.

3 Select the input channel on the TV.

Example:

Select the [Video 2] channel etc.

(The name of the channel may differ depending on the cable.)

4 Start playback on this unit.



The image and audio are output on the TV.

■ To watch images with a 16:9 aspect ratio on a regular TV (4:3)

When playing back motion pictures or still pictures recorded on this unit with a 16:9 aspect ratio on a TV with a 4:3 aspect ratio, the images on the screen may be squeezed horizontally. In this case, change the menu setting to play back the pictures in the original aspect ratio. (Depending on the TV setting, the pictures may not be displayed correctly. For more information, please read the operating instructions of your TV.)

Press the MENU button, then select [SETUP] → [TV ASPECT] → [4:3] and press the cursor button.

Example of images with a 16:9 aspect ratio on a regular TV (4:3)

[TV ASPECT] setting	
[16:9]	[4:3]
	

■ If the image or audio from this unit is not output on the TV

- Check that the plugs are inserted as far as they go.
 - Check the connected terminal.
 - **Check the TV's input setting (input switch).** (For more information, please read the operating instructions for the TV.)
-
- (HD mode) When a HDMI cable is connected at the same time, priority is given to the output from the HDMI cable.
 - (HD mode) When the component cable is connected at the same time, priority is given to the component cable for image output.
 - If the images are not displayed correctly on a wide-screen TV, adjust the setting in screen mode on the TV. (For more information, please read the operating instructions of the TV.)

Playback using VIERA Link (HDAVI Control)



If you connect this unit to a Panasonic TV (VIERA) compatible with VIERA Link (HDAVI Control™) with a HDMI cable, the following linked operations become possible.

- You can use the remote control for the TV to control playback on this unit.
- If you use the remote control for the TV to turn off the power, the power on this unit also turns off. (The power cannot be cut off when recording a motion picture, formatting a disc, finalizing a disc, un-finalizing a disc, deleting data, recovering data or connecting the unit to a computer with a USB cable.)
- If you connect with a HDMI cable and then turn on the power, the input channel on the TV automatically switches to this unit's screen. If the TV's power is in standby status, it will turn on automatically (if [Set] has been selected for the TV's [Power on link] setting).
 - Depending on the HDMI terminal on the TV, the input channel may not switch automatically. In this case, use the remote control for the TV to switch the input channel. (For details on how to switch input, please read the operating instructions for the TV.)
- If VIERA Link does not work properly, refer to page 147.

1 Connect this unit and a Panasonic TV (VIERA) compatible with VIERA Link with a HDMI cable (optional).

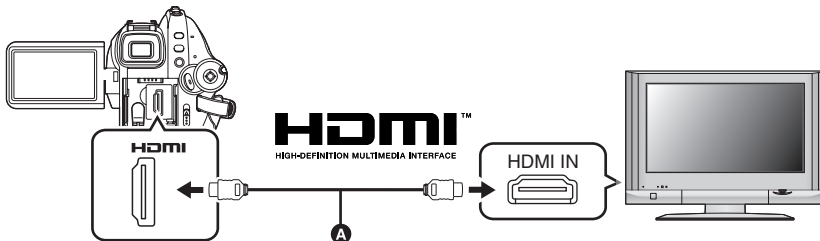

- Use a HDMI cable (optional) **A** with the logo shown on above.
- If the TV has two or more HDMI input terminals, it is recommended to connect this unit to HDMI2 or HDMI3.

2 Set so that VIERA Link is activated on the connected TV.

- Read the operating instructions of the TV for how to set etc.

3 Set the mode dial to to turn on the power.

4 Press the MENU button, then select [SETUP] → [VIERA Link] → [ON] and press the cursor button.

- The default setting is [ON].

5 Operate with the remote control for the TV.

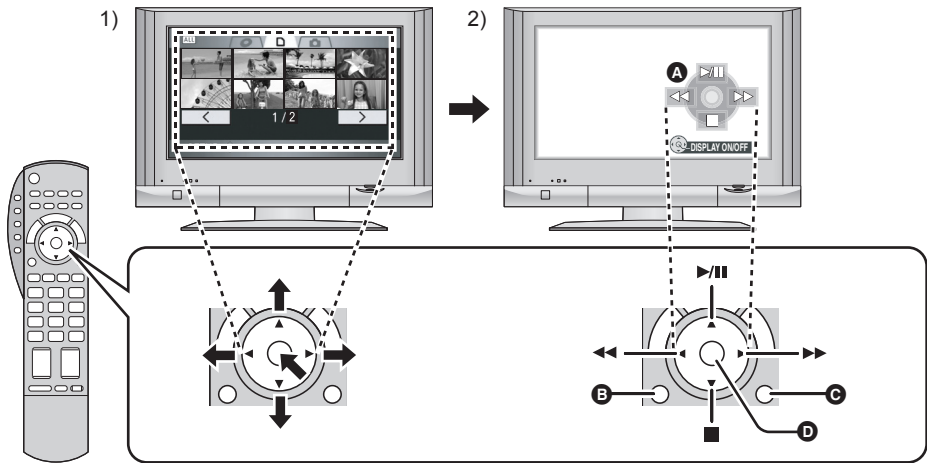

- 1) Press the button up, down, left or right to select a scene or file to be played back, and then press the button in the centre to set it.
 - 2) Operate the operation icons that are displayed on TV screen with the remote control for the TV.
 - A** Operation icons
 - B** Display operation icons
 - C** Cancel operation icons
 - D** Display/cancel operation icons
- The playback operation is performed the same as on this unit.
 - Playing back motion pictures (→ 79)
 - Playing back still pictures (→ 84)

To cancel VIERA Link (HDAVI Control)

Press the MENU button, then select [SETUP] → [VIERA Link] → [OFF] and press the cursor button.

- If you are unsure whether or not the TV you are using are compatible with VIERA Link, read the operating instructions for the TV.
- Available linked operations between this unit and a Panasonic TV is different depending on the types of Panasonic TVs even if they are compatible with VIERA Link. Refer to the operating instructions of the TV for the operations that support on the TV.
- Operation is not possible with a cable that is not based on the HDMI standard.
We recommend Panasonic cables.
Part numbers:
RP-CDHG15 (1.5 m), RP-CDHG30 (3.0 m), RP-CDHG50 (5.0 m) etc.

With Blu-ray Disc Player, DVD recorder, DVD player, computer etc.

Do not insert DVD-RW, DVD-R or DVD-R DL discs that have not been finalized into a Blu-ray Disc Player, DVD recorder, DVD player, computer etc. Doing so could result in an unusable disc. Also, when inserting discs into a Blu-ray Disc Player, DVD recorder, DVD player, computer etc, a message may be displayed prompting you to format the disc, but doing so will delete important data which cannot be restored, so do not format the disc.

Playback using Blu-ray Disc Players

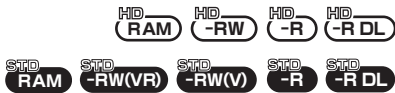

Discs recorded with this unit can be inserted in Panasonic Blu-ray Disc Players and played back.

Devices which can play back discs recorded with this unit

– DMP-BD10 Blu-ray Disc Player

- 1** (Only when playing back DVD-RW, DVD-R or DVD-R DL discs)
Finalize the disc using this unit.
(→ 95)
 - 2** **Insert the disc into a Blu-ray Disc Player to play it back.**
- Refer to the Blu-ray Disc Player operating instructions for details on how to play back discs.

Playback on DVD recorder, DVD player, computer etc.



- When playing back a disc on a DVD recorder/ player, place the device so that the disc lies flat.

■ **Playing back a DVD-RAM or a DVD-RW (VR format)**

- 1** [Only when playing back DVD-RW (VR format) discs]

Finalize the disc on this unit.
(→ 95)

2 **Insert the disc in the playback device and then play it back.**

- Playback is only possible on devices that support 8 cm DVD-RAM or DVD-RW (VR format). Refer to the operating instructions of the playback device.
- You cannot record images that allow "One time only recording" on a 8 cm disc.

■ **Playing back a DVD-RW (Video format) or a DVD-R**

- 1** **Finalize the disc on this unit.**
(→ 95)

2 **Insert the disc in the playback device and then play it back.**

- Playback is possible on devices that support 8 cm DVD-Video, but playback on all DVD players is not guaranteed.
- Playback of DVD-R DL is only possible on devices that support 8 cm DVD-R DL. Refer to the operating instructions of the playback device.
- The recording time is not displayed.

With a DVD recorder or video device

Dubbing images onto a connected DVD recorder or video device

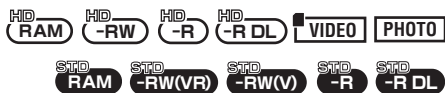

Dubbing images onto a connected DVD recorder or video device

• Images are dubbed in standard picture quality.

• Use the AC adaptor to free you from worrying about the battery running down.

1 Connect this unit and a video device.

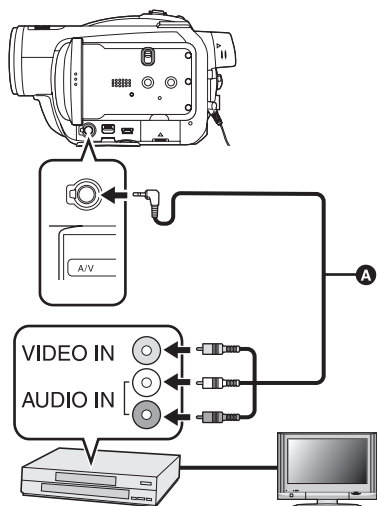

A AV cable (supplied)

• Insert the plugs as far as they will go.

2 Set the mode dial to  to turn on the power.

3 Change the input channel on the video device and TV.

• The channel set will differ depending on the terminal to which the unit is connected.

4 Start playback on this unit.

5 Then start recording on the connected device.

• See the operating instructions of the video device for details.

To stop dubbing

- 1) Stop recording on the connected device.
- 2) Then stop playback on this unit.

• If the date and time display and function indication are unnecessary, cancel them before dubbing. (→ 47, 101)

If the dubbed images are played back on a wide-screen TV, the images may be stretched vertically.

In this case, refer to the operating instruction of the device you are connecting to or read the operating instructions of the wide-screen TV and set the aspect ratio to 16:9.

With a printer (PictBridge)

PHOTO

To print pictures by directly connecting this unit to the printer, use a printer compatible with PictBridge.

(Read the operating instructions for the printer.)

- Use the AC adaptor to free you from worrying about the battery running down.
- **Insert an SD card with recorded images in this unit and then turn on the power.**
- You cannot use in STD mode.

1 Connect this unit and a printer.

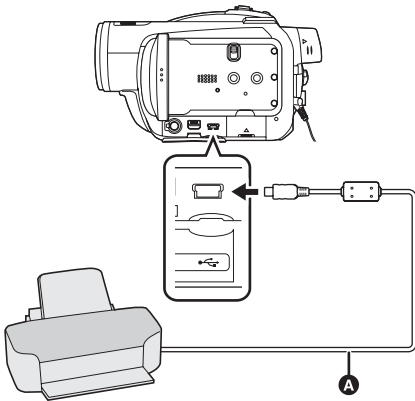

- A** USB cable (supplied)

The USB function selection screen will appear.

- Insert the plugs as far as they will go.
- Do not use any other USB connection cables except the supplied one. (Operation is not guaranteed with any other USB connection cables.)

2 Select [PictBridge] and press the cursor button.

The [PictBridge] indication appears on this unit's screen.

- If the [PictBridge] indication does not appear or continues to flash, disconnect and then reconnect the USB cable or check the printer, SD card and settings on this unit.

3 Select a file to be printed, then press the cursor button.



The number of prints set is displayed.

4 Move the cursor button up or down to select the desired number of prints, then press the cursor button.

- You can set up to 9 prints.
- To cancel the setting, set the number of prints to [0].
- Up to 8 files can be set in succession by repeating steps 3 and 4.

5 Press the MENU button to display the PictBridge menus.

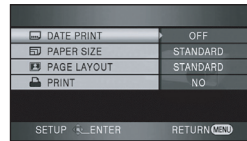

6 Select the date print setting on [DATE PRINT].

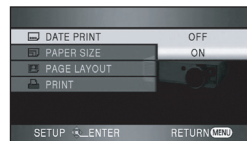

- If the printer is not capable of date printing, this setting is unavailable.

7 Select the paper size setting on [PAPER SIZE].

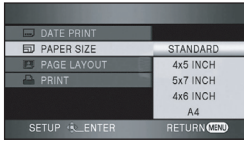

[STANDARD]: Size specific to the printer

[4×5 INCH]: L size

[5×7 INCH]: 2L size

[4×6 INCH]: Postcard size

[A4]: A4 size

- You cannot set paper sizes not supported on the printer.

8 Select the layout setting on [PAGE LAYOUT].

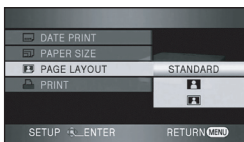

[STANDARD]: Layout specific to the printer

[]: No frame print

[]: Frame print

- You cannot set page layouts not supported on the printer.

9 Select [PRINT] → [YES] and press the cursor button to print the pictures.



- Exit PictBridge by disconnecting the USB cable (supplied) after the pictures have been printed.

When you stop printing halfway

Move the cursor button down.

- A confirmation message appears. If [YES] is selected, the number of prints set is cancelled and the screen returns to step 3. If [NO] is selected, all the settings are kept and the screen returns to step 4.

- Avoid the following operations during printing. These operations disable proper printing.
 - Disconnecting the USB cable
 - Opening the card slot cover and removing the SD card
 - Switching the mode dial
 - Turning off the power
- Check the settings for the paper size, quality of print, etc. on the printer.
- The edges of still pictures recorded on this unit with a 16:9 aspect ratio may be cut at printing. When using a printer with a trimming or borderless printing function, cancel this function before printing. (Refer to the operating instructions of the printer for details.)
- You may not be able to print still pictures recorded with other products.
- When the unit is connected directly to the printer, the DPOF settings cannot be used.
- Connect the printer directly to this unit. Do not use a USB hub.

With a computer

Before using with a computer

What you can do with a computer

Data type	Can do	Software used
Motion picture	Copying data to computer	HD Writer 2.0E for SX/SD
	Writing data to a media*	
	Copying data between media*	
	Playing back on a computer	
	Easy editing	
	Converting to MPEG2	
Still picture	Creating a DVD-Video disc	Standard Windows picture viewer or a commercially available picture viewer
	Playing back on a computer	
	Copying files to a computer	Windows Explorer
Refer to P129 if using a Macintosh.		

* Compatible media are SD card and discs (DVD-RAM, DVD-RW, DVD-R and DVD-R DL).

● Be sure to finalize all discs other than DVD-RAM on this unit before using them with a computer.

- You cannot write data to a disc when this unit is connected to a PC. Insert a media in the DVD writing drive on the computer and copy the data.
- Operation is not guaranteed when reading or writing motion picture data using software other than that supplied with this unit.
- Do not start the software supplied with this unit and other software at the same time. Close any other software if you start the software supplied with this unit and close the software supplied with this unit if you start any other software.
- Be sure to use the supplied USB cable when connecting this unit and a computer. (Operation is not guaranteed with any other USB cables.)

Contents on provided CD-ROM

The following software applications are contained on the provided CD-ROM.

■ HD Writer 2.0E for SX/SD

You can acquire data of motion pictures and still pictures to the hard disk of the computer, easily edit (split, merge, delete) the motion pictures, then write the data to an SD card or disc.

- You cannot copy data recorded in STD mode to a computer, play back data recorded in STD mode or create a DVD-video from data recorded in STD mode.



[Copy to PC]:

If you copy data to the hard disk of the computer, you can easily edit it (split, delete etc.).

[Write data to media]:

You can copy motion picture data and still picture data from the hard disk of the computer to an SD card. You can also copy motion picture data to a disc.

[Copy between media]:

You can copy motion picture data from an SD card to a disc or from a disc to an SD card.

[Easy editing]:

You can easily edit (split, merge, delete etc.) motion picture data that was copied to the hard disk of the computer. Also, you can convert data to MPEG2 format and create a DVD-Video.

[Start Playback]:

You can play back the images in high definition picture quality on a computer.

[Format disc]:

Depending on the type of disc that you use, formatting is necessary. Discs are formatted using the UDF 2.5 file system that supports the AVCHD format.

■ DirectX

If using Windows 2000, Microsoft DirectX 9.0c must be installed in order to operate the HD Writer 2.0E for SX/SD.

If DirectX is not already installed on your computer, you can install it from the CD-ROM. Click [DirectX] and follow the on-screen messages to install it. If you install the software on a computer that is not compatible with DirectX 9.0c, the computer may not work properly. If you are unsure whether or not your computer is compatible, contact the maker of your computer.

End User License Agreement

Before opening the CD-ROM package, please read the following.

You ("Licensee") are granted a license for the Software defined in this End User Software Agreement ("Agreement") on condition that you agree to the terms and conditions of this Agreement. If Licensee does not agree to the terms and conditions of this Agreement, promptly return the Software to Matsushita Electric Industrial Co., Ltd. ("Matsushita"), its distributors or dealers from which you made the purchase.

Article 1 License

Licensee is granted the right to use the software, including the information recorded or described on the CD-ROM, instruction manuals, and any other media provided to Licensee (collectively "Software"), but all applicable rights to patents, copyrights, trademarks and trade secrets in the Software are not transferred to Licensee.

Article 2 Use by a Third Party

Licensee may not use, copy, modify, transfer or allow any third party, whether free of charge or not, to use, copy or modify the Software, except as expressly provided for in this Agreement.

Article 3 Restrictions on Copying the Software

Licensee may make a single copy of the Software in whole or in part solely for back-up purposes.

Article 4 Computer

Licensee may only use the Software on a single computer at a single location.

Article 5 Reverse Engineering, Decompiling or Disassembly

Licensee may not reverse engineer, decompile, or disassemble the Software, except to the extent either of them is permitted under law or regulation of the country where Licensee resides. Matsushita, or its distributors or dealers will not be responsible for any defects in the Software or damage to Licensee caused by Licensee's reverse engineering, decompiling, or disassembly of the Software.

Article 6 Limitation of Liability

The Software is provided "AS-IS" without warranty of any kind, either expressed or implied, including, but not limited to, warranties of non-infringement, merchantability and/or fitness for a particular purpose. Further, Matsushita does not warrant that the operation of the Software will be uninterrupted or error free. Matsushita or any of its distributors or dealers will not be liable for any damage suffered by Licensee arising from or in connection with Licensee's use of the Software.

Article 7 Export Control

Licensee agrees not to export or re-export to any country the Software in any form without the appropriate export licenses under regulations of the country where Licensee resides, if necessary.

Article 8 Termination of License

The right granted to Licensee hereunder will be automatically terminated if Licensee violates any of the terms and conditions of this Agreement. Upon such automatic termination, Licensee must destroy the Software and related documentation together with all the copies thereof at Licensee's own expense.

Operating environment

- A CD-ROM drive is necessary to install the supplied software applications. (A compatible drive and media are necessary for writing to a DVD.)
- When 2 or more USB devices are connected to a computer, or when devices are connected through USB hubs or by using extension cables, proper operation is not guaranteed.
- Use the supplied USB cable when connecting to the computer. (Operation is not guaranteed with any other USB cables.)
- Even if the system requirements mentioned in these operating instructions are fulfilled, some personal computers cannot be used.
- This software is not compatible with Microsoft Windows 3.1, Windows 95, Windows 98/98SE, Windows Me and Windows NT.
- Operation on an upgraded OS is not guaranteed.
- Operation on an OS other than the one pre-installed is not guaranteed.

Operating environment for HD Writer 2.0E for SX/SD

Personal computer	IBM PC/AT compatible personal computer
OS	Microsoft Windows 2000 Professional Service Pack 4 Microsoft Windows XP Home Edition Service Pack 2 Microsoft Windows XP Professional Service Pack 2 Microsoft Windows Vista Home Basic Microsoft Windows Vista Home Premium Microsoft Windows Vista Ultimate
CPU	Intel Pentium III 1.0 GHz or higher (including compatible CPU) (Intel Core 2 Duo 1.86 GHz or higher or Intel Pentium D 3.0 GHz or higher is recommended when a playback function or MPEG2 output is used.)
RAM	Windows Vista: 1024 MB or more Windows XP/2000: 512 MB or more (1024 MB or more recommended)
Display	High Colour (16 bit) or more (32 bit or more recommended) Desktop resolution of 1024×768 pixels or more (1280×1024 pixels or more recommended) Windows Vista: DirectX 10 compatible video card Windows XP/2000: DirectX 9.0c compatible video card Compatible with DirectDraw overlay PCI Express™×16 compatible recommended
Free hard disk space	Ultra DMA — 100 or more 250 MB or more (for installing the application) When writing to a DVD, more than double the amount of free space as the disc being created is necessary.
Necessary software	Windows Vista: DirectX 10 Windows XP/2000: DirectX 9.0c • If you install the software on a computer that is not compatible with DirectX 9.0c, the computer may not work properly. If you are unsure whether or not your computer is compatible, contact the maker of your computer. Adobe Acrobat Reader 5.0 or later or Adobe Reader 7.0 or later

Sound	DirectSound Support
Interface	USB port [Hi-Speed USB (USB 2.0)]
Other requirements	Mouse or equivalent pointing device

- Supplied CD-ROM is available for Windows only.
- Operation is not guaranteed on computers that are not PC/AT compatible.
- Input is not supported in languages other than English, German, French, Italian, Spanish and Simplified Chinese.
- Operation cannot be guaranteed on all DVD drives.
- Discs recorded in AVCHD with this software cannot be played back on devices that do not support AVCHD.
- Operation is not guaranteed on Microsoft Windows XP Media Center Edition, Tablet PC Edition, Windows Vista Business/Enterprise and not compatible with 64 bit operation systems.
- This software is not compatible with a multi-boot environment.
- If using Windows XP/2000, an administrative account user only can use this software. If using Windows Vista, administrative account and standard account users only can use this software. (An administrative account user should install and uninstall this software.)
- This software is not compatible with a multi-CPU environment.
- If your computer does not satisfy the above system requirements, an error may occur when writing data to disc.
- Set the display resolution to 1024×768 (16 bits colour) or higher.
Select [start] → ([Settings] →) [Control Panel] → ([Appearance and Themes] →) [Display (Adjust screen resolution)] and select [Settings] tab, and then adjust [Screen resolution (Resolution)] and [Color quality (Colors)].

■ Operating environment for the card reader function (mass storage)

Personal computer	IBM PC/AT compatible personal computer
OS	Microsoft Windows 2000 Professional Service Pack 4 Microsoft Windows XP Home Edition Microsoft Windows XP Professional Microsoft Windows Vista Home Basic Microsoft Windows Vista Home Premium Microsoft Windows Vista Ultimate Microsoft Windows Vista Business Microsoft Windows Vista Enterprise
CPU	Windows Vista: Intel Pentium III 1.0 GHz or higher Windows XP/2000: Intel Pentium III 450 MHz or higher or Intel Celeron 400 MHz or higher
RAM	Windows Vista Home Basic: 512 MB or more Windows Vista Home Premium/Ultimate/Business/Enterprise: 1 GB or more Windows XP/2000: 128 MB or more (256 MB or more recommended)
Interface	USB port
Other requirements	Mouse or equivalent pointing device

- The USB equipment operates with the driver installed as standard in the OS.

Installation

When installing the software, log on to your computer as the Administrator (or with a user name with equivalent authorization) or with the user name for a standard user account. (If you do not have authorization to do this, consult your manager.)

- Before starting the installation, close any other software applications which are running.
- Do not perform any other operations on your computer while the software is being installed.

Installing HD Writer 2.0E for SX/SD

1 Insert the CD-ROM into the computer.



The [Setup Menu] screen will appear.

- If the [Setup Menu] screen does not appear, double-click the CD-ROM drive icon in [My Computer (Computer)].

2 Click [HD Writer 2.0E for SX/SD].



- The software application may not run properly if you cancel the installation at any point e.g. by pressing [Cancel].
- If using Windows 2000, Microsoft DirectX 9.0c must be installed in order to operate the HD Writer 2.0E for SX/SD. If you install the software on a computer that is not compatible with DirectX 9.0c, the computer may not work properly. If you are unsure whether or not your computer is compatible, contact the maker of your computer.

3 Click [Next].



4 Read carefully through the [End User License Agreement], then place a check beside [I accept the terms of the license agreement] if you agree to them and click [Next].



- If you do not agree to the terms and conditions of the License Agreement, installation is not possible.
- Continue to follow the on-screen messages to install it.

5 After the installation is complete, restrictions are displayed. Check the contents, then click [X] on the top right of the window.

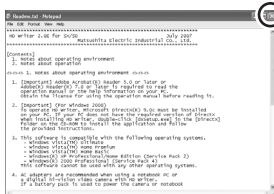

6 Click [Finish].

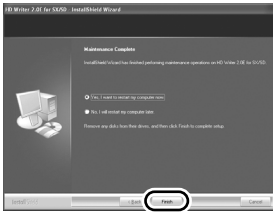

The computer must be rebooted for the application to work.

Reading the operating instructions of the software applications

For details on how to use the software applications, read the PDF operating instructions.

- You will need Adobe Acrobat Reader 5.0 or later or Adobe Reader 7.0 or later to read the PDF operating instructions.

Select [start] → [All Programs (Programs)] → [Panasonic] → [HD Writer 2.0E] → [Operating Instructions].

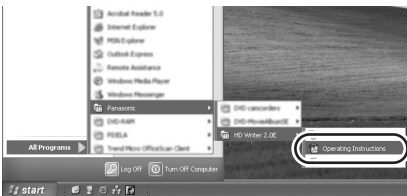

Software application uninstallation

Follow the steps below to uninstall any software applications that you no longer require.

1 Select [start] → ([Settings] →) [Control Panel] → [Add or Remove Programs (Applications)] or [Uninstall a program].

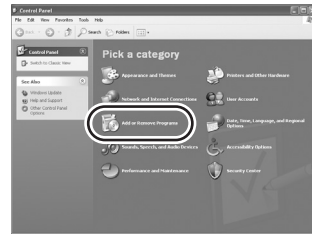

2 Select [HD Writer 2.0E for SX/SD], then click [Change/Remove] ([Change or Remove] or [Add/Remove] or [Uninstall]).

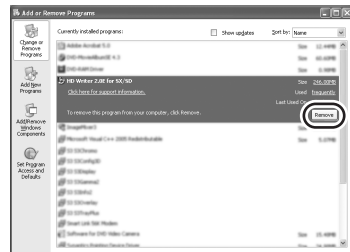

- Proceed with the uninstallation by following the on-screen instructions.
- After uninstalling the software, be sure to reboot the computer.

Connection and recognition

Connection and recognition procedures

After the software applications are installed, this unit must be connected to the computer and be correctly recognised by the computer.

- Connect after installing the software applications.
- Remove the supplied CD-ROM if it is inserted in the computer. (If the [Setup Menu] screen is displayed, wait until it finishes and then remove the CD-ROM.)
- If the recognition procedure is not accomplished properly, operation will not be possible after connecting the unit to the computer.
- If the unit fails to operate normally, it may mean that you have not conducted the installation or recognition procedure properly.
- **Be sure to finalize all discs other than DVD-RAM before using them with a computer. Un-finalized discs cannot be recognised by the computer.**

1 Connect this unit to the AC adaptor.

- If a battery is used, operation is not possible when this unit is connected to a computer.

2 Insert a disc or card with recorded images in the unit, then turn on the unit.

3 Connect this unit and a computer.

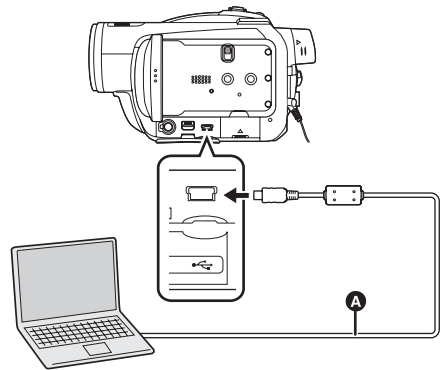

A USB cable (supplied)

The USB function selection screen will appear.

- Insert the plugs as far as they will go. The unit and computer will not operate properly if the plugs are not inserted fully.
- Do not use any other USB connection cables except the supplied one. (Operation is not guaranteed with any other USB connection cables.)

4 Select [PC CONNECT (DISC)] or [PC CONNECT (CARD)] and then press the cursor button.

This unit is automatically recognised by the computer.

- When the unit is connected to a computer, the operation mode cannot be changed and its power cannot be turned off. In this case, disconnect the USB cable. (→ 123)
- (STD mode) If the unit is connected to a computer when the USB function is set to [PC CONNECT (DISC)], no image will appear on the LCD monitor or the viewfinder.
- When this unit is connected to a computer, you cannot use this unit's DISC EJECT lever to remove a disc.
- When a computer is accessing a disc or card in this unit, the ACCESS/PC lamp or card access lamp lights. (When a card is being accessed,  appears on the LCD monitor.) Do not disconnect the USB cable or AC adaptor while the disc or card is being accessed as it may damage the data.
- It may be necessary to reboot the computer after connecting this unit to it for the first time.

About the computer display

When the unit is connected to a computer, it is recognised as an external drive.

SD card drive display

- [Removable Disk] is displayed in [My Computer (Computer)].

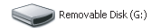

Example folder structure of an SD card:

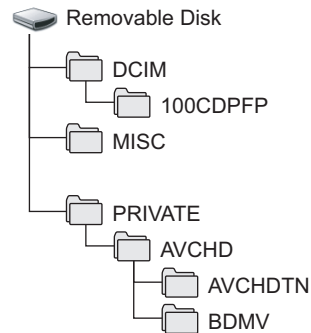

- AVCHD format motion picture files ([00000.MTS] etc.) are saved in the [BDMV] folder.
- The motion picture thumbnails are recorded in the [AVCHDTN] folder.
- JPEG format still pictures (IMGA0001.JPG etc.) are stored in the [100CDPFP] folder. These can be opened with picture software that supports JPEG pictures.
- Up to 999 files can be recorded in the [100CDPFP] or other such folder.
- The DPOF setting files are recorded in the [MISC] folder.

Disk drive display

<HD mode>

[Optical Disk Drive] is displayed in [My Computer (Computer)], but it cannot be opened on computers that do not support the UDF 2.5.

Example folder structure of a disk:

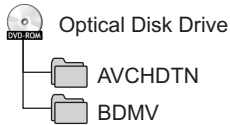

- AVCHD format motion picture files ([00000.MTS] etc.) are saved in the [BDMV] folder.
- The motion picture thumbnails are recorded in the [AVCHDTN] folder.
- The data cannot be written.

<STD mode>

Optical disc drive is displayed in [My Computer (Computer)].



- When a DVD-RAM or DVD-RW (VR format) is inserted in this unit, it can be accessed from the removable disk drive.



- When a DVD-RW (Video format) or DVD-R is inserted in this unit, it can be accessed from the optical disc drive.



Example folder structure of a DVD-RAM or DVD-RW (VR format):

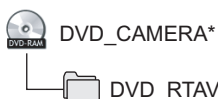

- DVD video recording format motion pictures are stored in the [DVD_RTAV] folder.

Example folder structure of a DVD-RW (Video format) or DVD-R:

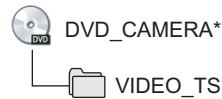

- DVD-Video format motion pictures are stored in the [VIDEO_TS] folder.
- * Depending on the maker of the disc and the device used to format it, the name displayed will differ.

We recommend using HD Writer 2.0E for SX/SD to copy motion picture data recorded in HD mode on a disc, an SD card or SD media storage.

Using Windows Explorer or other programmes on the computer to copy, move or rename files and folders recorded with this unit will result in them being unusable with HD Writer 2.0E for SX/SD.

■ Copying your still pictures to your computer

Card reader function (mass storage)

When an SD card with recorded data on it is inserted into the unit and the unit is connected to a computer using a USB cable, the SD card can be used as an external drive so that still pictures on the card can be copied to the computer with Explorer or other programmes.

1 Connect this unit to the computer and then select [PC CONNECT (CARD)].

[Removable Disk] is displayed in [My Computer (Computer)].

2 Double click the folder that contains the files on the removable disk ([DCIM] → [100CDPFP] etc.).

3 Drag and drop the files onto the destination folder (on the computer hard disk).

- Do not use the computer to delete, move or rename the SD card's folders. Otherwise, it may no longer be possible for this unit to read the SD card.
- Always use this unit to format SD cards.
- When data not supported by this unit has been recorded on a computer, it will not be recognised by this unit.

To disconnect USB cable safely

1 Double click the () icon in task tray displayed on the computer.

- Hardware disconnect dialogue appears.
- Depending on your computer's settings, this icon may not be displayed.

2 Select [USB Mass Storage Device] and click [Stop].

When using a disc:

- Verify [MATSHITA HDC-SX5(DVD) USB Device] is selected and click [OK].

When using an SD card:

- Verify [MATSHITA HDC-SX5(SD) USB Device] is selected and click [OK].
- Click [Close], and you can safely disconnect the USB cable.

- Do not disconnect the USB cable while the ACCESS/PC lamp or card access lamp lights ( appears on the LCD monitor) as it may damage the data.

Verifying the unit is correctly recognised by the computer

To verify this unit is correctly recognised by the computer, connect the unit to the computer with a USB cable, select [PC CONNECT (DISC)] or [PC CONNECT (CARD)] on the USB function selection screen and then follow the steps below.

- With some computers including those made by NEC, the Device Manager may not be displayed if a mode that places restrictions on the functions has been established. Consult the manufacturer or follow the steps in your computer's operating instructions to establish a mode in which all the functions can be used, then proceed with operation.

- 1 (When using Windows XP/2000)
Select [start] → ([Settings] → [Control Panel] → ([Performance and Maintenance] → [System].

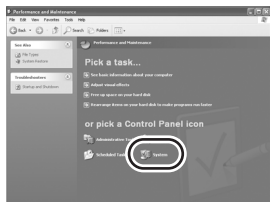

- (When using Windows Vista)
- 1 **Select [start] → [Control Panel] → [System and Maintenance] → [Device Manager].**

- 2 (When using Windows XP/2000)
Click the [Hardware] tab, then click [Device Manager].

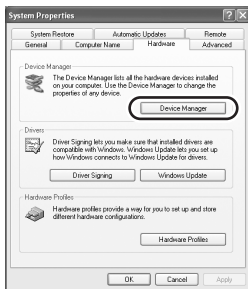

3 Verify the following items are displayed.

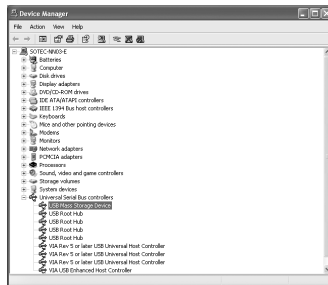

■ If the driver has been recognised properly

When using a disc:

- [MATSHITA HDC-SX5(DVD) USB Device] is displayed at [DVD/CD-ROM drives].
- [USB Mass Storage Device] is displayed at [Universal Serial Bus controllers].

When using an SD card:

- [MATSHITA HDC-SX5(SD) USB Device] is displayed at [Disc drives].
- [USB Mass Storage Device] is displayed at [Universal Serial Bus controllers].

■ If the driver has not been recognised properly

[!] or [Unknown device] appears at [Universal Serial Bus controllers] or [Other devices], etc. (Where the display will appear depends on the type of computer you are using.)

You can use the following method to enable it to be recognised.

Method 1:

Turn off the unit and your computer once and try again.

Method 2:

Eject the disc or SD card and try verifying again.

Method 3:

Try connecting the unit to another USB port on your computer.

Using HD Writer 2.0E for SX/SD

- When using HD Writer 2.0E for SX/SD on Windows XP/2000, log on to your computer as Administrator (or with a login name equally authorized). If you log on with a login name other than Administrator, you cannot use the applications.
- When using HD Writer 2.0E for SX/SD on Windows Vista, log on to your computer as Administrator (or with a login name equally authorized) or with the user name for a standard user account. If you log on with a user name for a guest user account, the software cannot be used.

■ Copying data on a disc or an SD card to the hard disk of the computer

1 Connect this unit to the AC adaptor.

- If a battery is used, operation is not possible when this unit is connected to a computer.

2 Insert a disc or card with recorded images in the unit, then turn on the unit.

3 Connect this unit and a computer.

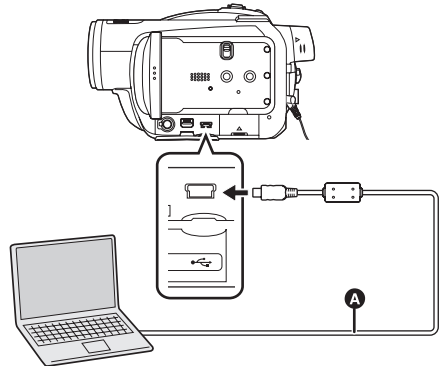

A USB cable (supplied)

The USB function selection screen will appear.

- Insert the plugs as far as they will go. The unit and computer will not operate properly if the plugs are not inserted fully.
- Do not use any other USB connection cables except the supplied one. (Operation is not guaranteed with any other USB cables.)

4 Select [PC CONNECT (DISC)] or [PC CONNECT (CARD)] and then press the cursor button.

This unit is automatically recognised by the computer.

5 (On the computer)

Select [start] →

[All Programs (Programs)] →

[Panasonic] → [HD Writer 2.0E]

→ [HD Writer].

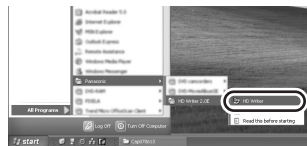

The HD Writer 2.0E for SX/SD introductory screen is displayed. If [OK] is clicked, the software will start.

6 Click the [Copy to PC] button.



7 Click the [Start copying] button.



- A confirmation message appears. Click [Yes] and copying starts.
- After copying is complete, a message appears. If [Yes] is clicked, all the motion pictures and still pictures on the SD card will be deleted.
- If you switch from an SD card to a disc or a disc to an SD card, first disconnect and then reconnect the USB cable, click the [Refresh] button and then select [PC CONNECT (DISC)] or [PC CONNECT (CARD)] again.

■ Playing back the high definition images on the computer

- Start HD Writer 2.0E for SX/SD.

1 Click the [Start Playback] button.



2 Select the media to be played back and then click [OK].

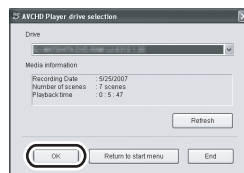

3 Select the scene to be played back and then click the [Play] button.



- The scenes from the selected one to the last one are played back on the full screen.
- Right click on the screen and then select [Stop] to stop playback.

■ Converting data that was copied to the hard disk of the computer to MPEG2 format

- The images are in conventional standard quality.
- You can record the converted data to a DVD disc using other DVD-Video writing software and then play it back on a DVD recorder etc.
- Start HD Writer 2.0E for SX/SD.

1 Click the [Easy editing] button.



2 Select the file to be converted into MPEG2 and then click the [Save as MPEG2] button.



3 Click [...], select the save destination, input the file name and then click the [Save] button.

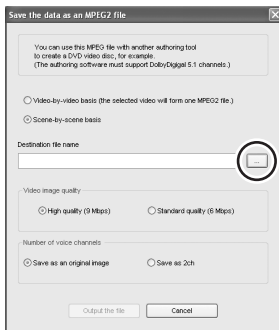

4 Click the [Output the file] button.

- A confirmation message appears. Click [OK] and converting to MPEG2 starts.

■ Formatting a disc

- Format the disc on this unit or with [Format disc] in HD Writer 2.0E for SX/SD.
- Please be aware that if a disc is formatted, then all the data recorded on the disc is erased and cannot be recovered.

■ Creating a DVD-Video disc

You can create a disc (DVD-Video) that can be played back on conventional devices that do not support the AVCHD.

- The images are in conventional standard quality.
- Insert an unused DVD-RW or DVD-R in a drive for DVD writing on the computer. DVD-RAM cannot be used.
- You cannot record on a disc that has been already recorded on. However, you can record on a DVD-RW that has already been recorded on if you use HD Writer 2.0E for SX/SD to format it. Please be aware that if a disc is formatted, then all the data recorded on the disc is erased and cannot be recovered. Save important data on a computer etc.
- Start HD Writer 2.0E for SX/SD.

1 Click the [Select videos to copy to media] button on the [Easy editing] screen.



2 Select the desired scenes and then click the [Confirm selection] button.



3 Insert the disc in a drive for writing, click  and then select the save destination.



4 Click  and then select [DVD-Video (High quality)] or [DVD-Video (Standard quality)].

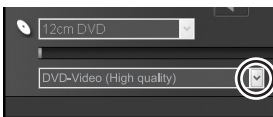

5 Click the [Start Copy] button.

- A confirmation message appears. Click [OK] and creating the DVD-video starts.
 - It takes time to convert to MPEG2 format.
 - The disc created is a DVD-Video so it cannot be used with HD Writer 2.0E for SX/SD.
-
- Refer to the operating instructions of the software (PDF file) for details on how to use it.
 - Do not insert a disc recorded in AVCHD format with HD Writer 2.0E for SX/SD in a device that does not support the AVCHD format. It may no longer be possible to eject it. Also, the disc cannot be played back on devices that do not support the AVCHD format.
 - Some discs recorded in AVCHD with HD Writer 2.0E for SX/SD may not be playable on other devices even if the other devices support AVCHD. In such cases, play them back on this unit instead.
 - The menu screen recorded in AVCHD with HD Writer 2.0E for SX/SD does not appear on this unit or HD Writer 2.0E for SX/SD. Use a device that supports AVCHD for playback.
 - Do not use Windows Explorer or other programmes on the computer to copy, move or rename folders and files of motion picture data copied to the hard disk of the computer. They will become unusable with HD Writer 2.0E for SX/SD.

If using a Macintosh

- Even if the system requirements mentioned in these operating instructions are fulfilled, some personal computers cannot be used.
- Apple, Mac OS is either registered trademarks or trademarks of Apple Inc. in the United States and/or other countries.
- PowerPC is a trademark of International Business Machines Corporation.

■ Operating environment for the card reader function (mass storage)

Personal computer	Macintosh
OS	Mac OS X v10.4
CPU	PowerPC G5 (1.8 GHz or higher) Intel Core Duo Intel Core Solo
RAM	64 MB or more
Interface	USB port

- The USB equipment operates with the driver installed as standard in the OS.
- Supplied CD-ROM is available for Windows only.

■ Copying still pictures on PC

1 Connect this unit and a computer via the supplied USB cable.

- The USB function selection screen will appear.

2 Select [PC CONNECT (CARD)] and press the cursor button.

3 Double-click [NO_NAME] or [Untitled] displayed on the desktop.

- Files are stored in [100CDPFP] folder etc. in the [DCIM] folder.

4 Using a drag-and-drop operation, move the pictures you want to acquire or the folder storing those pictures to any different folder on the computer.

■ To disconnect USB cable safely

Drag [NO_NAME] or [Untitled] disk icon to the [Trash], and then disconnect the USB cable.

Others

Menus and Indications

Menu list

HD mode recording menus

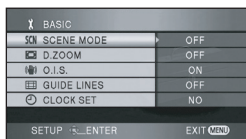

■ [BASIC]

[SCENE MODE] (→ 74)

[D.ZOOM] (→ 61)

[O.I.S.] (→ 69)

[GUIDE LINES] (→ 70)

[CLOCK SET] (→ 46)

■ [VIDEO]

[REC MODE] (→ 55)

[FADE COLOUR] (→ 63)

[WIND CUT] (→ 71)

[ZOOM MIC] (→ 61)

[MIC LEVEL] (→ 71)

[H.SHOE MIC] (→ 133)

[AGS] (→ 51)

■ [PICTURE]

[PICT. QUALITY] (→ 59)

[FLASH LEVEL] (→ 68)

[SHTR SOUND] (→ 59)

[RED EYE] (→ 68)

■ [ADVANCED]

[REC LAMP] (→ 133)

[ZEBRA] (→ 72)

[COLOUR BARS] (→ 73)

[MF ASSIST] (→ 75)

[AUTO SLOW SHTR] (→ 73)

■ [SETUP]

[FORMAT DISC] (→ 94)*1

[AUTO PROTECT] (→ 98)*1

[FORMAT CARD] (→ 94)

[DISPLAY] (→ 134)

[DATE/TIME] (→ 47)

[DATE FORMAT] (→ 47)

[POWER SAVE] (→ 134)

[QUICK START] (→ 35)*2

[BEEP SOUND] (→ 134)

[LCD AI] (→ 48)

[LCD SET] (→ 47)

[EVF SET] (→ 47)

[COMPONENT OUT] (→ 104)

[HDMI RESOLUTION] (→ 103)

[VIERA Link] (→ 107)

[TV ASPECT] (→ 106)

[INITIAL SET] (→ 134)

[DEMO MODE] (→ 134)

■ [LANGUAGE] (→ 44)

*1 Disc recording mode only

*2 SD card recording mode only

STD mode recording menus



BASIC	
SCENE MODE	OFF
GUIDE LINES	OFF
REC MODE	SD
CLOCK SET	NO

SETUP ← ENTER EXIT (MENU)

■ [BASIC]

[SCENE MODE] (→ 74)

[GUIDE LINES] (→ 70)

[REC MODE] (→ 55)

[CLOCK SET] (→ 46)

■ [ADVANCED]

[D.ZOOM] (→ 61)

[O.I.S.] (→ 69)

[FADE COLOUR] (→ 63)

[REC LAMP] (→ 133)

[WIND CUT] (→ 71)

[ZOOM MIC] (→ 61)

[H.SHOE MIC] (→ 133)

■ [DISC SETUP]

[FORMAT DISC] (→ 94)

[INFORMATION] (→ 100)

■ [SETUP]

[DISPLAY] (→ 134)

[DATE/TIME] (→ 47)

[DATE FORMAT] (→ 47)

[POWER SAVE] (→ 134)

[AGS] (→ 51)

[BEEP SOUND] (→ 134)

[LCD SET] (→ 47)

[EVF SET] (→ 47)

■ [LANGUAGE] (→ 44)

HD mode playback menus

(▶ motion picture playback)

PLAY SETUP	
PLAY MODE	VIEW ALL
REPEAT PLAY	OFF
RESUME PLAY	OFF
SCENE PROTECT	NO
GUIDE LINES	OFF

SETUP ← ENTER EXIT (MENU)

■ [PLAY SETUP]

[PLAY MODE] (→ 83)

[REPEAT PLAY] (→ 80)

[RESUME PLAY] (→ 84)

[SCENE PROTECT] (→ 88)

[GUIDE LINES] (→ 70)

■ [EDIT SCENE]

[DIVIDE] (→ 87)

[DELETE] (→ 86)

■ [DISC COPY]*1

[COPY ALL] (→ 89)

[COPY SELECT] (→ 89)

■ [DISC SETUP]*2

[FORMAT DISC] (→ 94)

[FINALIZE]

(When using a DVD-RW, DVD-R or DVD-R DL)

(→ 95)

[CREATE TOP MENU]

(When using a DVD-RAM) (→ 97)

[UN-FINALIZE] (→ 96)



[AUTO PROTECT] (→ 98)

[INFORMATION] (→ 100)

■ [SETUP]

- [FORMAT CARD] (→ 94)
- [DISPLAY] (→ 134)
- [DATE/TIME] (→ 47)
- [DATE FORMAT] (→ 47)
- [POWER SAVE] (→ 134)
- [BEEP SOUND] (→ 134)
- [LCD AI] (→ 48)
- [LCD SET] (→ 47)
- [EVF SET] (→ 47)
- [COMPONENT OUT] (→ 104)
- [HDMI RESOLUTION] (→ 103)
- [VIERA Link] (→ 107)
- [TV ASPECT] (→ 106)

■ [LANGUAGE] (→ 44)

- *1 When selecting the [] (motion picture playback) tab
- *2 When selecting the [] (motion picture playback) tab

HD mode playback menus

( still picture playback)



■ [PLAY SETUP]

- [SCENE PROTECT] (→ 92)
- [DPOF SET] (→ 92)

■ [SETUP]

- [FORMAT CARD] (→ 94)
- [DISPLAY] (→ 134)
- [DATE/TIME] (→ 47)
- [DATE FORMAT] (→ 47)
- [POWER SAVE] (→ 134)
- [BEEP SOUND] (→ 134)
- [LCD AI] (→ 48)
- [LCD SET] (→ 47)
- [EVF SET] (→ 47)
- [COMPONENT OUT] (→ 104)
- [HDMI RESOLUTION] (→ 103)
- [VIERA Link] (→ 107)
- [TV ASPECT] (→ 106)

■ [LANGUAGE] (→ 44)

STD mode playback menus (▶ motion picture playback)

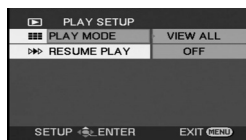

■ [PLAY SETUP]

[PLAY MODE] (→ 83)
[RESUME PLAY] (→ 84)

■ [EDIT SCENE]

[DIVIDE] (→ 87)
[DELETE] (→ 86)

■ [DISC SETUP]

[FINALIZE] (→ 95)
[UN-FINALIZE] (→ 96)
[DISC PROTECT] (→ 99)
[FORMAT DISC] (→ 94)
[INFORMATION] (→ 100)

■ [SETUP]

[DISPLAY] (→ 134)
[DATE/TIME] (→ 47)
[DATE FORMAT] (→ 47)
[POWER SAVE] (→ 134)
[BEEP SOUND] (→ 134)
[LCD SET] (→ 47)
[EVF SET] (→ 47)
[TV ASPECT] (→ 106)

■ [LANGUAGE] (→ 44)

Menus related to [VIDEO] and [ADVANCED]

■ [H.SHOE MIC]

- [NORMAL]
- [LOWCUT]

Set to [LOWCUT] and this reduces low sound noise and wind noise hitting the stereo zoom microphone (VW-VMH3E; optional) mounted on the smart accessory shoe.

■ [REC LAMP]

- [OFF]
- [ON]

The recording lamp lights during recording and flashes when the unit receives a signal from the remote control or when the self-timer is counting down. When this is set to [OFF], it does not light during recording.

Menus related to [SETUP]

■ [DISPLAY]

- [OFF]
- [ON]

The screen indications are selected as shown in the illustration below.

[OFF]



[ON]



■ [POWER SAVE]

- [OFF]
- [5 MINUTES]

[OFF]:

The power saving function is not activated.

[5 MINUTES]:

When about 5 minutes have passed without any operation, this unit automatically turns off to prevent the battery from running down. When you use this unit turn it on again.

- In the following cases, the unit may not turn off even when you set this to [5 MINUTES].
 - When using the AC adaptor
 - When connecting the unit to a computer or printer via the USB cable
 - When PRE-REC is used

■ [BEEP SOUND]

- [OFF]
- [ON]

This allows operations such as starting and ending recording to be signaled by a beep. When [OFF] is set, no beep is heard when an operation such as recording is started or ended.

1 Beep

When you start recording

When you turn on the power

When this unit is recognised by the computer or the printer, etc.

2 Beeps

When you pause recording

When you turn off the power

2 Beeps for 4 times

When an error occurs e.g. recording not starting. Check the sentence displayed on the screen.

(→ 137)

■ [INITIAL SET] (HD mode only)



- [YES]
- [NO]

When there is a menu that cannot be selected due another function or mode being activated, set to [YES] for changing the menu settings back to the initial shipping condition.

(The language setting cannot be changed back to the initial shipping condition.)

■ [DEMO MODE] (HD mode only)

- [OFF]
- [ON]

This item is used to start the unit demonstration. (Only when the mode dial is at the  or  position) If you set this to [ON] without inserting a disc or an SD card, this unit is automatically set to the demonstration mode for introducing its functions. If any button is pressed or operated, the demonstration mode is cancelled. If no operations take place for approx. 10 minutes, the demonstration mode automatically starts. To terminate the demonstration mode, insert a disc or an SD card, or set this to [OFF]. For normal use, set this function to [OFF].

Indications

Recording indications

Motion picture recording

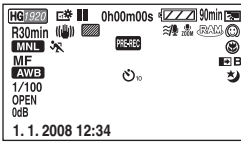

Still picture recording (when the PHOTO SHOT button is pressed halfway)

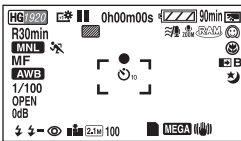

	Remaining battery power
90min	Remaining time for battery power
R30min	Remaining time for motion picture recording
0h00m00s	Elapsed recording time
1.1.2008 12:34	Date indication Time indication
●/II (Red)	Recording/writing to a disc or an SD card
II (Green)	Recording pause
AUTO	Auto mode
MNL	Manual mode
MF	Manual focus
10×	Zoom magnification indication
	Backlight compensation
	Image stabilizer
	POWER LCD EXTRA
1/100	Shutter speed
OPEN, F2.0	F number
0dB	Gain value
PRE-REC	PRE-REC
	Intelligent contrast control
	Soft skin mode

	Tele macro
	Fade (White), Fade (Black)
	Colour night view function
	Zoom microphone
	Wind noise reduction
	External microphone supporting the smart accessory shoe
	External microphone supporting the smart accessory shoe (LOW CUT)
	Microphone level
	Zebra display
	HG mode
	HN mode
	HE mode
	XP mode
	SP mode
	LP mode
	Sports mode
	Portrait mode
	Low light mode
	Spotlight mode
	Surf & snow mode
	Auto white balance
	Indoor mode (recording under incandescent lamp)
	Outdoor mode
	Manual adjustment mode
	Disc type DVD-RAM
	DVD-RW
	DVD-RW (VR format)
	DVD-RW (Video format)
	DVD-RW (unformatted)
	DVD-R
	DVD-R DL (dual layer on single side)
	Flash
	Flash level
	Red eye reduction

○ (White) ● (Green)	Focus indication
⌚ ₁₀ /⌚ ₂	Self-Timer recording
MEGA OIS	MEGA OIS
2.1M	Number of recording pixels for still pictures 1920×1080
■ (White) ■ (Green) ■ (Red)	Card can be recorded to Recognising the card Recording/accessing the card
📷 / 📷	Still picture quality
100	Remaining number of still pictures

■ Playback indications

Motion picture playback

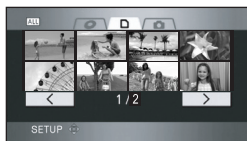

Still picture playback



▶	Playback
⏸	Pause
⏩, ⏪ / ⏴, ⏵	Fast forward/rewind playback
▶/⏪	Last/first scene paused
⏩/⏴	Skip playback
⏩/⏴	Slow motion playback
⏩/⏴	Frame-by-frame playback
0h00m00s	Playback time
	Play mode
ALL	All scenes on the disc or SD card
DATE	Scenes recorded on the selected date

	Number of recording pixels for motion pictures
1920	1920×1080
1440	1440×1080
No.10	Scene number
🔊	Volume adjustment
🔄	Repeat playback
⏩	Resume playback
100-0001	Still picture folder/file number display
PictBridge	When a printer compatible with PictBridge is connected
📷 1	DPOF already set (to more than 1)
🔒	Contents that have been protected.
2.1M	Number of recording pixels for still pictures 1920×1080
The picture size is not displayed for still pictures recorded with other products that have different picture sizes from the sizes shown above.	

■ PC connection indications

📷	Accessing the card (When connected to a computer)
---	---

■ Confirmatory indications

-- (Time display)	The built-in battery is low. (→ 47)
!	The warning/alarm indication appears when LCD monitor is rotated towards the lens side. Return the direction of the LCD monitor to normal position and check the warning/alarm indication.
NO DISC	No disc is inserted.
📷	Unusable disc
📷	No card is inserted

Messages

CANNOT RECORD.	Data writing to the disc or SD card has failed.
NO DATA.	There are no images recorded on the disc or SD card. If this message appears although data is recorded on the SD card, the condition of the card is probably not stable. Turn off the power and then turn it on again.
CANNOT BE USED DUE TO INCOMPATIBLE DATA.	The recording format is different so it cannot be used.
CANNOT RECORD -INCOMPATIBLE CONTROL DATA.	Insert a new disc or save the data on the SD card to a computer and then format the SD card before using it.
INCOMPATIBLE DISC.	You inserted an incompatible disc (copy-protected discs, etc.).
PLEASE CHECK THE DISC.	You inserted a disc that cannot be read on this unit. Or the disc has been protected (write-protect).
THIS IS A NON-RECORDABLE DISC.	The disc cannot be used for recording on this unit. Insert a new disc.
FOR BEST PERFORMANCE PANASONIC DISC IS RECOMMENDED.	You inserted a disc that does not meet the DVD standard for quality and performance so you may not be able to record normally. Refer to the following support site for information about discs that have been confirmed as compatible by Panasonic. http://panasonic.jp/support/global/cs/e_cam (This website is in English only.)
CANNOT RECORD. (THIS DISC IS FINALIZED)	A finalized DVD-RW (HD mode)/DVD-RW (Video format/STD mode) or DVD-R, DVD-R DL has been inserted. After finalizing, the discs become play-only and cannot record. If you un-finalize a DVD-RW (HD mode)/DVD-RW (Video format/STD mode), it can be used for recording. (→ 96)
CANNOT RECORD. THE NUMBER OF SCENES HAS EXCEEDED THE MAXIMUM LIMIT.	The disc or SD card is full or the number of scenes has reached the maximum limit so no further data can be recorded. Delete unnecessary scenes (→ 86) or insert a new disc or SD card.
CANNOT RECORD - DATE CAPACITY IS FULL.	The scenes grouped by date have reached the maximum number of dates so recording is not possible. Delete unnecessary scenes (→ 86) or insert a new disc or SD card.
NO NEED TO FORMAT THIS DISC.	DVD-R and DVD-R DL can only be recorded on once so cannot be formatted.
THIS DISC IS FINALIZED.	A finalized disc has been inserted. DVD-R and DVD-R DL cannot be un-finalized. If you un-finalize a DVD-RW, it can be used for recording again. (→ 96)

CANNOT FINALIZE.	The disc cannot be finalized (un-finalized) on this unit. (The disc was recorded on another device etc.) Or, you are trying to finalize a disc that has no motion pictures recorded on it.
CANNOT READ DISC. PLEASE CHECK CONDITION OF DISC.	There are scratches or dirt on the recording/playback side of the disc. If there is dirt on the disc, use a soft cloth to wipe it. (→ 26) If the disc is scratched, insert a new one.
CHECK CARD.	This card is not compatible or it cannot be recognised by the unit.
THIS CARD CANNOT RECORD IN VIDEO MODE.	An 8 MB or 16 MB SD card on which motion pictures cannot be recorded is inserted.
CARD LOCKED.	The write protection switch on the SD card is set to LOCK. (→ 25)
NOW ACCESSING. PLEASE DO NOT REMOVE CARD.	The data is being processed. Close the card slot cover and wait for a while.
CARD FULL.	The SD card is full so no further data can be recorded. Delete unnecessary files (→ 86, 90) or insert a new SD card.
CANNOT OPERATE THIS FUNCTION IN THIS MODE.	PRE-REC cannot be set in disc recording mode. Or, you are trying to copy a disc in STD playback mode.
TOP MENU COULD NOT BE CREATED.	Creating a top menu has failed. There may be scratches or dirt on the recording/playback side of the disc. If there is dirt on the disc, use a soft cloth to wipe it. (→ 26)
CANNOT DIVIDE. THE NUMBER OF SCENES IS FULL.	The disc or SD card is full or the number of scenes has reached the maximum limit so no further data can be divided. Delete unnecessary scenes (→ 86).
CANNOT OPERATE. INTERNAL TEMPERATURE IS TOO HIGH.	The temperature of the unit is high so it cannot be operated. Turn off the power, wait until the unit cools and then turn on the power again.
INTERNAL TEMPERATURE TOO HIGH. PLEASE TURN UNIT OFF AND WAIT A WHILE.	
THIS BATTERY CANNOT BE USED.	Use a battery that you can use for this unit. (→ 29) You are attempting to connect an AC adaptor not compatible with this unit. Use the supplied AC adaptor. (→ 32) If using a Panasonic battery compatible with this unit (→ 29), eject the battery and then insert it again. If the message appears even after repeating this several times, this unit needs repair. Detach the power and consult the dealer who you purchased this unit from. Do not attempt to repair it by yourself.
CANNOT RECORD IN AGS MODE.	The AGS function is activated. (→ 51)

PUSH THE RESET SWITCH.	An irregularity in the unit has been detected. Press the RESET button to restart the unit. (→ 147)
CHECK THE DISC AFTER PUSHING THE RESET SWITCH TO REPAIR IT.	There may be scratches or dirt on the recording/playback side of the disc. If there is dirt on the disc, use a soft cloth to wipe it. (→ 26) If the disc is scratched, insert a new one.
CANNOT SET.	The [GUIDE LINES], [ZEBRA], [MF ASSIST], [MIC LEVEL] and [RED EYE] menu settings cannot be set when the colour bar is set.
DISCONNECT USB CABLE.	The unit cannot correctly establish the connection to the computer or printer. Disconnect and then reconnect the USB cable.
(HD mode) DISCONNECT USB CABLE.	The unit's power cannot be turned off when the unit is connected to the computer.
(STD mode) CANNOT OPERATE WHILE USB CONNECTED.	

About recovery

It is possible that the system cannot complete writing of a file normally when, for example, power is turned off for some reason during recording or editing.

If faulty management information is found when a disc or an SD card is accessed, the following message may appear. (Repairing may take time depending on the error.)

◇ HD mode

CONTROL DATA ERROR HAS BEEN DETECTED.

When connecting to AC adaptor or the remaining capacity of the battery is enough:
[FINISHED.]

When the remaining capacity of the battery is low:
[CANNOT REPAIR CONTROL INFORMATION DUE TO LOW BATTERY POWER.]

THUMBNAIL DATA ERROR IS DETECTED.

When connecting to AC adaptor or the remaining capacity of the battery is enough:
[THUMBNAIL DATA HAS BEEN REPAIRED SUCCESSFULLY.]

When the remaining capacity of the battery is low:
[CANNOT REPAIR CONTROL INFORMATION DUE TO LOW BATTERY POWER.]

◇ STD mode

DISC ERROR HAS OCCURRED. NOW REPAIRING THE DISC.

- Use a sufficiently charged battery or the AC adaptor.
- Depending on the condition of the data, it may not be possible to completely repair the data.
- If the recovery fails, you will no longer be able to playback the data recorded before the power went off.
- When data recorded on another device is recovered, it may not be possible to play back the data on this unit or the other device.
- If the thumbnail information is recovered, displaying the thumbnails may become slower.

Functions that cannot be used simultaneously

Some functions in this unit are disabled or cannot be selected due to the unit's specifications. The table below shows examples of functions restricted by various conditions.

Functions	Conditions which disable the functions
Backlight compensation	<ul style="list-style-type: none"> ● When the colour night view function is used ● When the iris/gain is set
Intelligent contrast control	
Colour night view (Set and cancel)	<ul style="list-style-type: none"> ● While recording ● When PRE-REC is used
Soft skin mode (Set and cancel)	
Tele macro (Set and cancel)	
Help mode	
Self timer	
Red eye reduction	
Fade	
Shutter effect	<ul style="list-style-type: none"> ● While motion pictures recording ● When PRE-REC is used
Flash	<ul style="list-style-type: none"> ● While motion pictures recording ● When PRE-REC is used ● When the colour night view function is used
Zoom	<ul style="list-style-type: none"> ● When the PHOTO SHOT button is pressed halfway in still picture recording
Zoom microphone	<ul style="list-style-type: none"> ● An external microphone is used
Wind noise reduction	
Scene mode	<ul style="list-style-type: none"> ● When setting the AUTO/MANUAL/FOCUS switch to AUTO ● When the colour night view function is used
MF assist function	<ul style="list-style-type: none"> ● When digital zoom (10× or higher) is used
Change of white balance	<ul style="list-style-type: none"> ● When digital zoom (10× or higher) is used ● When the colour night view function is used
Adjusting the shutter speed, iris/gain	<ul style="list-style-type: none"> ● When the colour night view function is used ● When the scene mode is used

Frequently asked questions

? What kind of discs can be used?

-  DVD-RAM, DVD-RW, DVD-R and DVD-R DL can be used if they are 8 cm bare discs.
(→ 19)

? Can discs with a cartridge be used?

-  They can be used if the cartridge is removed.

? Can double sided discs be used?

-  They can be used.
However you cannot record or play continuously from one side of the disc to the other.
You will need to eject the disc and turn it over.

? Can I record continuously from one side of the disc to the other on a double sided disc?

-  You cannot record continuously from one side of the disc to the other. The recording time indicated on the disc package is the total time for both sides. You will need to eject the disc and turn it over to record on both sides.

? Can DVD-R or DVD-R DL be recorded to once only?

-  Recording can be started and stopped until the disc is full.
(HD mode) The remaining space on the disc will not increase even if recorded scenes are deleted.
(STD mode) Once data is recorded it cannot be deleted.

? Is playback possible on a DVD player?

HD mode:

To playback a disc recorded on this unit, you will need a playback device that supports AVCHD.

Also if a DVD-RW, DVD-R or DVD-R DL recorded on this unit is inserted in another device without it being finalized, it may no longer be possible to use the disc. Always finalize the disc on this unit before inserting it in another device.



STD mode:

By finalizing a DVD-RW (VR format/Video format) or a DVD-R in this unit, it can be played back on a DVD player.

To playback a DVD-RAM, DVD-RW (VR format) or DVD-R DL, you will need a DVD recorder or a DVD player that supports DVD-RAM, DVD-RW (VR format) or DVD-R DL. Refer to the operating instructions of the DVD recorder or DVD player.

? Can I use computer software other than that supplied?



-  For information about software from other companies, contact the makers of the software.





Troubleshooting

■ Unit operations

Problem	Check points
<p>This unit cannot be turned on.</p>	<ul style="list-style-type: none"> ● Is the battery fully charged? → Charge the battery using the AC adaptor. (→ 27) ● The battery protection circuit may have operated. Attach the battery to the AC adaptor for 5 to 10 seconds. If the unit still cannot be used, the battery is faulty. ● Is the LCD monitor opened or the viewfinder extended?
<p>This unit is turned off automatically.</p>	<ul style="list-style-type: none"> ● If you do not use the unit for approximately 5 minutes, the power is automatically turned off to conserve the battery charge. To resume recording, turn the power back on. The power will not turn off automatically when the power save function is set to [OFF]. (→ 134) ● Are you connecting to a TV compatible with VIERA Link with a HDMI cable? → If you connect to a TV compatible with VIERA Link with a HDMI cable and turn off the power on the TV with the remote control for the TV, the power on this unit also turns off. If you are not using VIERA Link, set [VIERA Link] to [OFF]. (→ 107)
<p>This unit does not stay on long enough.</p>	<ul style="list-style-type: none"> ● Is the battery low? → If the remaining battery power indication is flashing or the message "CHANGE THE BATTERY" is displayed, the battery has run down. Charge the battery. (→ 27)
<p>Battery runs down quickly.</p>	<ul style="list-style-type: none"> ● Is the battery fully charged? → Charge it with the AC adaptor. (→ 27) ● Are you using the battery in an extremely cold place? → The battery is affected by ambient temperature. In cold places, the operating time of the battery becomes shorter. ● Has the battery worn out? → The battery has a limited life. If the operating time is still too short even after the battery is fully charged, the battery has worn out and can no longer be used.
<p>The minute display of the remaining battery power indication is not displayed correctly.</p>	<ul style="list-style-type: none"> ● The remaining battery capacity indication is an approximation. If you think the remaining battery capacity indication is not displayed correctly, fully charge the battery, discharge it and then charge it again. (Even if this operation is performed, it may not be possible to display the remaining battery capacity correctly if the battery was used for a long period of time where the temperature was low or high or if the battery was repeatedly charged.)

Problem	Check points
<p>This unit cannot be operated though it is turned on.</p> <p>This unit does not operate normally.</p>	<ul style="list-style-type: none"> ● The unit cannot be operated unless you open the LCD monitor or extend the viewfinder. ● Press the RESET button. (→ 147) If normal conditions are not restored yet, remove the battery or AC adaptor, wait about 1 minute and then reconnect the battery or AC adaptor. Then about 1 minute later, turn on the power again. (Conducting the above operation when the access lamp is on may destroy the data on the disc or SD card.)
<p>The remote control does not function.</p>	<ul style="list-style-type: none"> ● Has the button-type battery of the remote control run out? → Replace it with a new button-type battery. (→ 17)
<p>The message “DISC DOOR OPENED.” appears although the disc cover is closed.</p>	<ul style="list-style-type: none"> ● This message may appear if the battery is removed or the AC adaptor is disconnected while removing a disc or before the power to the unit fully turns off. → Open the disc cover with the DISC EJECT lever and then close it again.
<p>The DISC EJECT lever does not work.</p>	<ul style="list-style-type: none"> ● The disc cover will not open unless the unit is powered. → Connect a charged battery or AC adaptor. ● The DISC EJECT lever does not work when the unit is connected to the computer. → Disconnect the USB cable.
<p>The screen has changed suddenly.</p>	<ul style="list-style-type: none"> ● Has the demonstration started? → If you set [DEMO MODE] to [ON] without inserting a disc or an SD card in recording mode, the unit is automatically set to the demonstration mode for introducing its functions. Normally this should be set to [OFF]. Press the MENU button, then select [SETUP] → [DEMO MODE] → [OFF] and press the cursor button.
<p>A function indication such as the remaining time indication or the elapsed time indication is not shown.</p>	<ul style="list-style-type: none"> ● If you set [SETUP] → [DISPLAY] → [OFF], indications other than warnings and date indications disappear.
<p>The disc cannot be read.</p>	<ul style="list-style-type: none"> ● Are there fingerprints or dirt on the surface of the disc? → If there are fingerprints or dirt on the disc, wipe them off. (→ 26)

Problem	Check points
<p>Recording does not start although power is supplied to this unit and the disc or SD card is correctly inserted.</p>	<ul style="list-style-type: none"> ● (HD mode) Has the DVD-RW, DVD-R or DVD-R DL been finalized? → After finalizing, the discs become play-only and cannot record. If you un-finalize a DVD-RW, it can be used for recording. (→ 96) ● (STD mode) Is the DVD-RAM or the DVD-RW (VR format) write-protected? → Release the protection. (→ 99) If the DVD-RAM or DVD-RW (VR format) was protected on another device, release the protection on the same device. ● (STD mode) Has the DVD-RW (Video format) or DVD-R been finalized? → After finalizing, the discs become play-only and cannot record. If you un-finalize a DVD-RW (Video format), it can be used for recording. (→ 96) ● Has the SD card's write protect switch been set to LOCK? → No recording is possible while the write protect switch is set to LOCK. (→ 25) ● Is the memory of the disc or SD card full? → If the disc or SD card has no more available memory, free up some memory by deleting unnecessary scenes (→ 86, 90) or use a new disc or SD card. ● Is the unit set to the recording mode? → No recording is possible unless the mode dial is at  or . ● Is the disc cover or card slot cover open? → If the disc cover or card slot cover is open, this unit may not operate normally. Close the disc cover or card slot cover.
<p>Recording starts but stops immediately.</p> <p>The playback picture breaks up for a moment.</p>	<ul style="list-style-type: none"> ● Is the disc scratched or dirty? → Wipe off the dirt on the disc. (→ 26) If the disc is scratched, insert a new one. ● The unit is hot. Follow the messages on the display. To use the unit again, turn the unit off and leave it for a while.
<p>The unit arbitrarily stops recording.</p>	<ul style="list-style-type: none"> ● Can the SD card be used for motion picture recording? → Use an SD card that can be used for motion picture recording. (→ 25) ● Is the AGS function activated? → Record in the normal horizontal position or set [AGS] to [OFF]. (→ 51)
<p>Auto focus function does not work.</p>	<ul style="list-style-type: none"> ● Is manual focus mode selected? → Set the AUTO/MANUAL/FOCUS switch to AUTO. ● Are you trying to record a scene which is hard to bring into focus in auto focus mode? → There are some recording subjects and surroundings for which the auto focus does not operate correctly. (→ 156) If so, use the manual focus mode to adjust the focus. (→ 75)

Problem	Check points
<p>Recorded still pictures are not clear.</p>	<ul style="list-style-type: none"> ● Are you trying to record small or finely detailed objects with [PICT. QUALITY] set at []? → If you try to record small or finely detailed objects with [PICT. QUALITY] set at [], the images may break up into a mosaic-like pattern. Record with [PICT. QUALITY] set at [] instead. (→ 59)
<p>Sound is not played back from the built-in speaker of this unit.</p>	<ul style="list-style-type: none"> ● Is the volume too low? → During playback, move the volume lever to display the volume indication and adjust it. (→ 83)
<p>Although this unit is correctly connected to a TV, images cannot be seen.</p> <p>The images are squeezed horizontally.</p>	<ul style="list-style-type: none"> ● Does the input switch on the TV match the connected terminal? → Please read the operating instructions of your TV and select the channel that matches the input used for the connection. ● Is the [TV ASPECT] setting correct? → Change the setting to match the aspect ratio of the TV. Press the MENU button, then select [SETUP] → [TV ASPECT] → [16:9] or [4:3] and press the cursor button. ● If both HDMI and component cables are connected, priority in recording mode is given to the output from the HDMI cable. If you set the unit to playback mode, output is from both cables. ● Pictures recorded in STD mode cannot be played back using the HDMI or component cables. Use the AV cable to play back pictures recorded in STD mode.
<p>Scenes cannot be deleted or edited.</p>	<ul style="list-style-type: none"> ● (STD mode) Is the DVD-RAM or the DVD-RW (VR format) write-protected? → Release the protection. (→ 99) If the disc or the contents on the disc have been protected on another device, release the protection on the same device. ● (HD mode) Is the scene protected? → Release the protection. (→ 88) If the disc or the contents on the disc have been protected on another device, release the protection on the same device. ● Scene which cannot be displayed as thumbnails (the thumbnails are displayed as []) cannot be deleted. If the scenes are unnecessary, format the disc or SD card to erase the data. (→ 94) Please be aware that if a disc or an SD card is formatted then all the data recorded on the disc or SD card will be erased. ● Is the still picture file protected? → Protected files cannot be deleted. Release the protect setting. (→ 92) ● If the SD card's write protect switch is set to LOCK, then deletion is disabled. (→ 25)

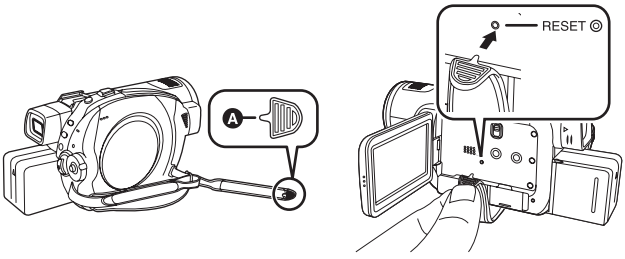

Problem	Check points
<p>The images on the SD card do not look normal.</p>	<ul style="list-style-type: none"> ● The data may be destroyed. It may have been destroyed by static or electromagnetic waves. Store important data on a computer or other products as well.
<p>Even if a disc or an SD card is formatted, it cannot be used.</p>	<ul style="list-style-type: none"> ● Either this unit or the disc or SD card may be damaged. Please consult a dealer. Use an SD card from 8 MB to 8 GB with this unit.
<p>If the SD card is inserted in this unit, it is not recognised.</p>	<ul style="list-style-type: none"> ● Is the SD card formatted on a computer inserted? → Use this unit to format SD cards. Please be aware that if an SD card is formatted, then all the data recorded on the card will be erased. (→ 94)
<p>If the SD card is inserted in another device, it is not recognised.</p>	<ul style="list-style-type: none"> ● Check that the device is compatible with the capacity or type of SD card (SD Memory Card/SDHC Memory Card) that you inserted. (→ 24) → Refer to the operating instructions of the device for details.
<p>The indication disappears.</p> <p>The screen is frozen.</p> <p>No operation can be performed.</p>	<ul style="list-style-type: none"> ● Is this unit connected to a computer? → No operation can be performed on this unit when it is connected to a computer. ● Turn off the power to this unit. If the power cannot be turned off, press the RESET button, or remove the battery or AC adaptor and then reattach it. After that, turn on the power again. If normal operation is still not restored, detach the power connected, and consult the dealer who you purchased this unit from.
<p>White round spots like soap bubbles appear on the recorded picture.</p>	<ul style="list-style-type: none"> ● If you take a picture with the flash in a dark place or indoors, white round spots may appear on the picture caused by the flash reflecting of particles of dust in the air. This is not a malfunction. A characteristic of this is that the number of round spots and their position differ in every picture. 

Problem	Check points
<p>“PUSH THE RESET SWITCH.” or “CHECK THE DISC AFTER PUSHING THE RESET SWITCH TO REPAIR IT.” is displayed.</p>	<ul style="list-style-type: none"> ● Is the disc scratched or dirty? → After using the following method to restart the unit, eject the disc and clean it. (→ 26) If there are scratches on the disc, use a new disc. ● The unit has automatically detected an error. Press the RESET button with the projecting part of the grip belt A. This will restart the unit. <div style="text-align: center;">  </div> <ul style="list-style-type: none"> ● If you do not press the RESET button, the power to this unit is turned off automatically about 1 minute later. ● Even after you press the RESET button, the indication may still appear repeatedly. If so, this unit needs repair. Detach the power connected, and consult the dealer who you purchased this unit from. Do not attempt to repair the unit by yourself.

When connected to another device

Problem	Check points
<p>VIERA Link does not work.</p>	<ul style="list-style-type: none"> ● Are you connecting with the component cable or the AV cable? → Connect with a HDMI cable (purchase separately). (→ 107) ● Is the [VIERA Link] setting appropriate? → Press the MENU button, then select [SETUP] → [VIERA Link] → [ON] with the cursor button. ● Depending on HDMI terminal of the TV, the input channel may not switch automatically. In this case, use the remote control for the TV to switch input. (For details on how to switch input, please read the operating instructions for the TV.) ● Check the VIERA Link setting on the connected device. ● Turn the power to the unit off and then back on again. ● Set [VIERA Link] to [Off] on the TV and then turn it back to [On]. (Refer to the operating instructions of the TV (VIERA) for details.) ● Are you using pictures recorded in STD mode? – Use pictures recorded in HD mode.

With a computer

Problem	Check points
<p>Even if connected by the USB cable, this unit is not recognised by the computer.</p>	<ul style="list-style-type: none"> ● Is the AC adaptor connected? → Use the AC adaptor when connecting this unit and a computer. ● Select another USB terminal on the computer. ● Check the operating environment. (→ 116) ● Turn the power to the unit off and then back on again and reconnect the USB cable.
<p>When the USB cable is disconnected, an error message will appear on the computer.</p>	<ul style="list-style-type: none"> ● To disconnect the USB cable safely, double-click the   icon in the task tray and follow the instructions on the screen.
<p>Cannot see the PDF operating instructions for HD Writer 2.0E for SX/SD.</p>	<ul style="list-style-type: none"> ● Is Adobe Acrobat Reader 5.0 or later or Adobe Reader 7.0 or later installed on the computer that you are using? → You will need Adobe Acrobat Reader 5.0 or later or Adobe Reader 7.0 or later to read the PDF operating instructions for HD Writer 2.0E for SX/SD.

If scenes do not change smoothly when played back on another device

The images may be still for several seconds at the joins between the scenes if the following operations are performed when multiple scenes have been continuously played back using another unit.

* Just how smoothly the scenes will be played back continuously depends on the playback unit.
Depending on the unit used, the images may stop moving and become still for a moment even when none of the following conditions are applicable.

When the scenes were recorded on different dates

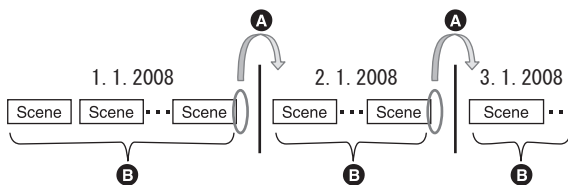

- A** The image will be still for several seconds wherever the date changes.
- B** The images are played back smoothly if the scenes were recorded on the same date.

■ When more than 99 scenes were recorded on the same date

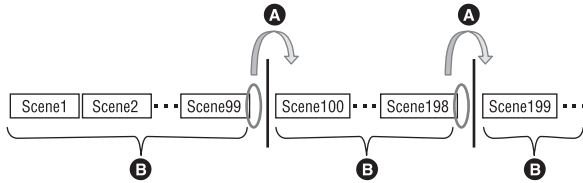

- Ⓐ The image will be still for several seconds when the scene changes every time 99 recorded scenes have been played back.
- Ⓑ The images of 99 consecutive scenes are played back smoothly.

■ When scenes lasting under 3 seconds have been recorded

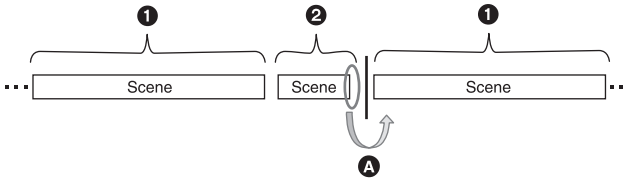

- ① 3 or more seconds
- ② Under 3 seconds
- Ⓐ The image will be still for several seconds after a scene which lasts under 3 seconds.

■ When PRE-REC was used for recording

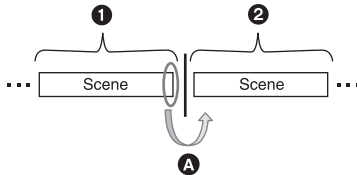

- ① Normal recording
- ② PRE-REC recording
- Ⓐ The picture momentarily stops at the end of the last scene that was recorded normally before PRE-REC recording.

■ When the recording mode was changed from HN/HE to HG or from HG to HN/HE

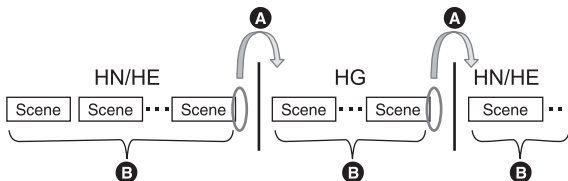

- A** The picture momentarily stops where the scenes switch between HN/HE and HG modes.
- B** Playback is smooth if the same mode is used or the mode is switched between HN and HE.

■ When deleting scenes

Example 1: Deleting scenes midway through a sequence of scenes.

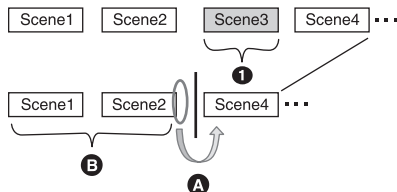

- 1** Scene to be deleted
- A** The image will be still for several seconds wherever a scene was deleted.
- B** The images of consecutive scenes where they are no deletions are played back smoothly one after another.

Example 2: When recording again after having deleted the last scene.

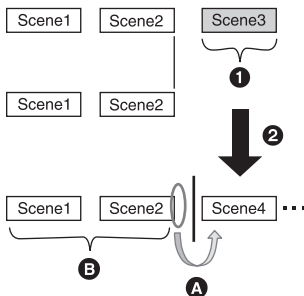

- 1** Scene to be deleted
- 2** A new scene is recorded here.
- A** The image will be still for several seconds wherever a scene was deleted.
- B** The images of consecutive scenes where they are no deletions are played back smoothly one after another.

■ When editing scenes on a computer using a programme such as HD Writer 2.0E for SX/SD

Example 1: When scenes were selected using HD Writer 2.0E for SX/SD and output to the media



If scenes were dragged and dropped from the scene display area **A** and output to the media, the images will be still for several seconds wherever one scene changes to the next.

This stopping of the images for several seconds wherever one scene changes to the next can be prevented by dragging and dropping the scenes in the Image display area **B** or by clicking [Copy between media] button on the Start Menu.

Example 2: When deleting scenes was initiated by HD Writer 2.0E for SX/SD

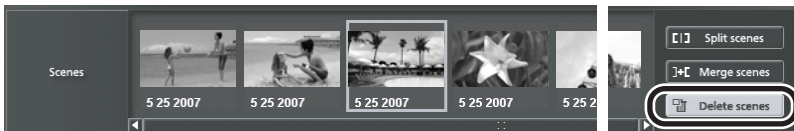

When a scene is deleted, the images may be still for several seconds where that scene was deleted.

Example 3: When merging scenes was initiated by HD Writer 2.0E for SX/SD

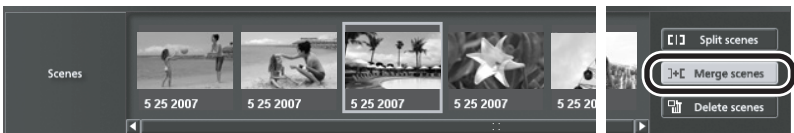

Wherever scenes are merged, the images may be still for several seconds where the original scenes were split.

Cautions for use

About this unit

- The unit, disc and SD card become warm after long operation, but this is not a malfunction.

Keep the High Definition Video Camera as far away as possible from electromagnetic equipment (such as microwave ovens, TVs, video games etc.).

- If you use the High Definition Video Camera on top of or near a TV, the pictures and sound on the High Definition Video Camera may be disrupted by electromagnetic wave radiation.
- Do not use the High Definition Video Camera near cell phones because doing so may result in noise adversely affecting the pictures and sound.
- Recorded data may be damaged, or pictures may be distorted, by strong magnetic fields created by speakers or large motors.
- Electromagnetic wave radiation generated by microprocessors may adversely affect the High Definition Video Camera, disturbing the pictures and sound.
- If the High Definition Video Camera is adversely affected by electromagnetic equipment and stops functioning properly, turn the High Definition Video Camera off and remove the battery or disconnect AC adaptor. Then reinsert the battery or reconnect AC adaptor and turn the High Definition Video Camera on.

Do not use the High Definition Video Camera near radio transmitters or high-voltage lines.

- If you record near radio transmitters or high-voltage lines, the recorded pictures and sound may be adversely affected.

Make sure to use the supplied cords and cables. If you use optional accessories, use the cords and the cables supplied with them. Do not extend the cords and the cables.

Do not spray insecticides or volatile chemicals onto the unit.

- If the unit is sprayed with such chemicals, its body may be marred and the surface finish may peel off.
- Do not leave rubber or plastic products in contact with the unit for a long time.

When you use the unit in a sandy or dusty place such as a beach, do not let sand or fine dust get into the body and terminals of the unit.

Also, keep the unit away from sea water.

- Sand or dust may damage the unit. (Care should be taken when inserting and removing a disc or a card.)
- If sea water splashes onto the unit, wipe off the water with a well wrung cloth. Then wipe the unit again with a dry cloth.

When carrying the unit, do not drop or bump it.

- A strong impact can break the unit's casing, causing it to malfunction.

Do not use benzine, paint thinner or alcohol for cleaning the unit.

- Before cleaning, detach the battery or pull out the AC cable from the AC outlet.
- The camera body may be discoloured and the surface finish may peel off.
- Wipe the unit with a soft dry cloth to remove dust and fingerprints. To remove stubborn stains, thoroughly wring a cloth that has been soaked in a neutral detergent diluted with water and wipe the unit with it. Afterwards, wipe it with a dry cloth.
- When you use a chemical dust cloth, follow the instructions that came with the cloth.

Do not touch the laser pickup lens.

- If you touch the laser pickup lens directly it may cause malfunctions.

Do not use the unit for surveillance purposes or other business uses.

- If you use the unit for a long time, heat will build up inside it and this may cause a malfunction.
- This unit is not intended for business use.

When you are not going to use the unit for an extended time.

- When storing the unit in a cupboard or cabinet, it is recommended that you place a desiccant (silica gel) in with it.

About the battery

The battery used in this unit is a rechargeable lithium-ion battery. It is susceptible to humidity and temperature and the effect increases the more the temperature rises or falls. In cold areas, the full charge indication may not appear or the low battery indication may appear about 5 minutes after starting use. At high temperatures, the protection function may be triggered, making it impossible to use the unit.

Be sure to detach the battery after use.

- If the battery is left attached, a minute amount of current continues to flow even if the unit's power is off. Keeping the unit in this state may result in over discharge of the battery. This may result in you not being able to use the battery even after it is charged.
- The battery should be stored in the vinyl bag so metal does not come into contact with the terminals.
- The battery should be stored in a cool place free from humidity, with as constant temperature as possible. (Recommended temperature: 15 °C to 25 °C, Recommended humidity: 40% to 60%)
- Extremely high temperatures or low temperatures will shorten the life of the battery.
- If the battery is kept in high-temperature, high-humidity, or oily-smoky places, the terminals may rust and cause malfunctions.
- To store the battery for a long period of time, we recommend you charge it once every year and store it again after you have completely used up the charged capacity.
- Dust and other matter attached to the battery terminals should be removed.

Prepare spare batteries when going out for recording.

- Prepare batteries appropriate to 3 to 4 times the period during you want to record pictures in. In cold places such as a ski resort, the period during which you can record pictures is shortened.
- When you travel, do not forget to bring an AC adaptor so that you can recharge the batteries at your destination.

If you drop the battery accidentally, check to see if the terminals are damaged.

- Attaching a battery with damaged terminals can damage the unit or AC adaptor.

Do not throw old battery into fire.

- Heating a battery or throwing it into a fire may result in an explosion.

If the operating time is very short even after the battery has been recharged, the battery has worn out. Please purchase a new battery.

About the AC adaptor

- If the temperature of the battery is extremely high or extremely low, charging may take time or the battery may not be charged.
- If the charging lamp keeps flashing, make sure that the terminals of the battery or the AC adaptor are not exposed to dirt, foreign objects or dust, then reconnect them properly. Disconnect the AC cable from the AC outlet when you remove dirt, foreign objects or dust on the terminals of the battery or the AC adaptor. If the charging lamp is still flashing, something may be wrong with the battery or AC adaptor. Contact your dealer.
- If you use the AC adaptor near a radio, radio reception may be disturbed. Keep the AC adaptor 1 m or more away from the radio.
- When using the AC adaptor, it may generate whirring sounds. However, this is normal.
- After use, be sure to disconnect the AC adaptor. (If it is left connected, a minute amount of current is consumed.)
- Always keep the electrodes of the AC adaptor and battery clean.

Put this unit near the outlet to make it easy for the interrupting device (plug) to reach it.

About the disc

● If there is dust, a scratch, or dirt on disc or if it is warped, the following phenomena may occur:

- Block noise in playback image
- Momentary stop of playback image
- Sound interrupted during playback, or abnormal sound
- [] appears for thumbnail displays
- Disc cannot correctly be recognised
- Delay between video and audio

When the ACCESS/PC lamp is illuminated (during access to the disc), do not open the disc cover, turn off the power, or cause any vibrations or impacts.



DVD-R/DVD-R DL

- For optimum recording on DVD-R or DVD-R DL discs, this unit writes control data to a DVD-R or DVD-R DL used for recording when it is being inserted and ejected. If the disc has no area for control data to be written, recording may not be possible. To prevent this, do not insert a DVD-R or DVD-R DL which has been recorded on more than 50 times.
- Do not insert a DVD-R or DVD-R DL recorded on this unit that has not been finalized into a recordable device, such as a DVD recorder. The recorded data may be damaged.

About the SD card

- The memory capacity indicated on the label of an SD card is the total of the capacity for copyright protection and management and the capacity which can be used on the unit, a computer etc.
- During prolonged use, the unit's surfaces and the SD card will heat up slightly. This is normal.

Always set the mode dial to OFF when inserting or removing an SD card.

While this unit accesses the SD card (while  or  is being displayed/the access lamp is lit), do not remove the SD card, operate the

mode dial, turn off the power or shake or impact the unit.

About the miniSD Card

- Be sure to insert miniSD Cards in the dedicated card adaptor before use. Inserting a card in this unit without the adaptor may damage the unit or the card.
- Do not insert an empty card adaptor in this unit. Do not leave the adaptor in this unit while inserting or removing miniSD Cards. This may cause the unit to malfunction.

LCD monitor/viewfinder

- When the LCD monitor gets dirty, wipe it with a dry soft cloth.
- In a place with drastic temperature changes, condensation may form on the LCD monitor. Wipe it with soft dry cloth.
- When the unit has become very cold, for example due to storage in a cold area, its LCD monitor will be slightly darker than usual immediately after the power is turned on. The normal brightness will be restored when the unit's internal temperature rises.

Extremely high precision technology is employed to produce the LCD Monitor screen featuring a total of approximately 300,000 pixels. The result is more than 99.99% effective pixels with a mere 0.01% of the pixels inactive or always lit. However, this is not a malfunction and does not affect the recorded picture.

Extremely high precision technology is employed to produce the viewfinder screen featuring a total of approximately 183,000 pixels. The result is more than 99.99% effective pixels with a mere 0.01% of the pixels inactive or always lit. However, this is not a malfunction and does not affect the recorded picture.

About condensation

When condensation forms on the unit, the lens will cloud up and the unit may not work properly. Make every effort to ensure that condensation does not form. If it does form, take the actions described below.

Causes of condensation

Condensation takes place when the ambient temperature or humidity is changed as follows.

- When this unit is brought inside from the cold (e.g. a ski slope) to a warm room.
- When this unit is moved from an air-conditioned car to outside.
- When a cold room has been warmed up quickly.
- When cool wind from an air conditioner is directly blown onto this unit.
- After summer afternoon showers of rain.
- When this unit is in a very humid place where the air is thick with steam. (e.g. a heated swimming pool)

When this unit is taken to a location with a significant temperature difference such as from a cold place to a hot place.

If, for example, you have used this unit for recording on a ski slope and are taking it into a heated room, place the unit inside a plastic bag, remove as much of the air from inside the bag as possible, then seal the bag. Leave the unit for about an hour in the room so the temperature of the unit is close to the ambient temperature of the room, then use it.

What to do with the lens is fogged up.

Remove the battery or AC adaptor and leave the unit for about 1 hour. When the unit becomes close to the ambient temperature, the fog disappears naturally.

Explanation of terms

Automatic white balance

White balance adjustment recognises the colour of light and adjusts so the white colour will become a purer white. The unit determines the hue of light that comes through the lens and white balance sensor, thereby judging the recording condition, and selects the closest hue setting.

This is called automatic white balance adjustment.

However, since the unit only stores white colour information under several light sources, automatic white balance adjustment does not function normally under other light sources.

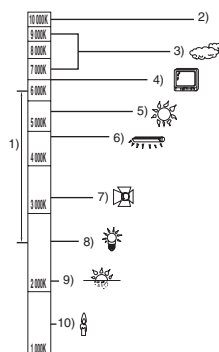

The illustration above shows the range over which the auto white balance functions.

- 1) The effective range of automatic white balance adjustment on this unit
- 2) Blue sky
- 3) Cloudy sky (rain)
- 4) TV screen
- 5) Sunlight
- 6) White fluorescent lamp
- 7) Halogen light bulb
- 8) Incandescent light bulb
- 9) Sunrise or sunset
- 10) Candlelight

Outside of the effective range of automatic white balance adjustment, the image will become reddish or bluish. Even within the effective range of automatic white balance adjustment, the automatic white balance adjustment may not function properly if there is more than one light source. For light outside the functional automatic white balance adjustment range, use the manual white balance adjustment mode.

White balance

The images recorded by the unit may become bluish or reddish under the influence of certain light sources. To avoid such phenomena, adjust the white balance.

White balance adjustment determines the white colour under different light sources. By recognising which is the white colour under sunlight and which is the white colour under a fluorescent light, the unit can adjust the balance among the other colours.

Since the white colour is the reference for all the colours (that make up light), the unit can record pictures in a natural hue if it can recognise the reference colour white.

Auto focus

The lens is moved forward or backward automatically to bring the subject into focus.

Auto focus has the following characteristics.

- **Adjusts so that the vertical lines of a subject are seen more clearly.**
- **Attempts to bring an object with higher contrast into focus.**
- **Focuses on the screen centre only.**

Due to these characteristics, auto focus does not work correctly in the following situations. Record pictures in the manual focus mode.

- **Recording distant and close-up objects at the same time**

Since the unit focuses on whatever is at the centre of the screen, it is difficult to bring the background into focus when close-up objects are placed in focus. When recording people with distant mountains in the background, you cannot focus on both the subject which is close-up and the objects which are in the distance.

- **Recording a subject behind dirty or dusty window**

The subject behind the window will not be focused because the focus is on the dirty window.

Similarly, when recording something on the opposite side of a road with heavy traffic, a vehicle that happens to pass by may be brought into focus.

- **Recording a subject that is surrounded by objects with glossy surfaces or by highly reflective objects**

Since whatever is shiny or glistens is brought into focus, it is hard to focus on the subject to be recorded. The focus may become blurry when recording subjects at the seashore, in night views or in scenes involving fireworks or special lights.

- **Recording a subject in dark surroundings**

The unit cannot focus correctly because the light information that comes through the lens decreases considerably.

- **Recording a fast-moving subject**

As the focus lens-inside moves mechanically, it cannot keep up with a fast-moving subject. When, for example, recording a sports event with fast moving subjects, the focus may lose its sharpness.

- **Recording a subject with little contrast**

It is easy to bring subjects with a sharp contrast or vertical lines or stripes into focus. This means that a subject with little contrast, such as a white wall, may become blurry because the unit achieves focus based upon the vertical lines of an image.

Specifications

High Definition Video Camera

Information for your safety

Power source:	DC 9.3 V (When using AC adaptor)/7.2 V (When using battery)
Power consumption:	Recording 10.2 W

Signal system	HD mode: 1080/50i STD mode: 625/50i
Recording format	HD mode: Motion picture: AVCHD format compliant Still picture: JPEG STD mode : Motion picture: DVD Video Recording format (DVD-RAM, DVD-RW) DVD-Video format (DVD-RW, DVD-R, DVD-R DL)
Image sensor	1/6" 3CCD image sensor Total: 560 K×3 Effective pixels: Motion picture/still picture: 520 K×3
Lens	Auto Iris, F1.8 to F2.8 Focal length: 3.0 mm to 30.0 mm Macro (Full range AF)
Filter diameter	37 mm
Zoom	10× optical zoom, 25/700× digital zoom
Monitor	2.7" wide LCD monitor (approx. 300 K pixels)
Viewfinder	0.44" wide EVF (approx. 183 K pixels)
Microphone	Stereo (with a zoom function)
Speaker	1 round speaker \varnothing 20 mm
White balance adjustment	Auto tracking white balance system
Standard illumination	1,400 lx
Minimum required illumination	Approx. 5 lx (Low light mode: 1/25) Approx. 1 lx (Colour night view mode)
Video output level	1.0 Vp-p, 75 Ω
Component terminal output level	Y: 1.0 Vp-p, 75 Ω Pb: 0.7 Vp-p, 75 Ω Pr: 0.7 Vp-p, 75 Ω 1125i (1080i)/625i (576i)
HDMI terminal output level	HDMI 1125i (1080i)/625p (576p)

Audio output level (Line)	316 mV, 600 Ω
USB	Card reader function (No copyright protection support) Hi-Speed USB (USB 2.0), USB terminal Type miniB PictBridge-compliant
Flash	Available range: Approx. 1 m to 2.5 m
Dimensions	83.5 mm (W)×93.5 mm (H)×151.5 mm (D) (excluding projecting parts)
Mass	Approx. 540 g (without supplied battery, disc and an SD card)
Mass in operation	Approx. 660 g (with supplied battery, disc and an SD card)
Operating temperature	0 °C to 40 °C (0 °C to 30 °C when connected to the computer)
Operating humidity	10% to 80%
Battery operation time	See page 29

Motion pictures

Recording media	<p>Disc: 8 cm DVD-RAM Ver. 2.1 8 cm DVD-RW Ver. 1.1/2X-SPEED (2X/1X) 8 cm DVD-R for General Ver. 2.0 8 cm DVD-R for DL Ver. 3.0</p> <p>SD Memory Card: 256 MB, 512 MB, 1 GB, 2 GB (FAT12 and FAT16 system compliant)</p> <p>SDHC Memory Card: 4 GB, 8 GB (FAT32 system compliant)</p>
Compression	<p>HD mode: MPEG-4 AVC/H.264</p> <p>STD mode: MPEG2</p>
Recording mode and transfer rate	<p>HD mode: HG: Approx. 13 Mbps (CBR) (Approx. 14 min recordable time on a single-sided DVD-RAM) HN: Approx. 9 Mbps (VBR) (Approx. 21 min recordable time on a single-sided DVD-RAM) HE: Approx. 6 Mbps (VBR) (Approx. 31 min recordable time on a single-sided DVD-RAM)</p> <p>STD mode: XP: 10 Mbps (VBR) (Approx. 18 min recordable time on a single-sided DVD-RAM) SP: 5 Mbps (VBR) (Approx. 37 min recordable time on a single-sided DVD-RAM) LP: 2.5 Mbps (VBR) (Approx. 75 min recordable time on a single-sided DVD-RAM)</p>
Picture size	<p>HG: 1920×1080 HN/HE: 1440×1080</p>

Audio compression	Dolby Digital (Dolby AC3)/2ch
--------------------------	-------------------------------

Still pictures

Recording media	SD Memory Card: 8 MB/16 MB/32 MB/64 MB/128 MB/256 MB/512 MB/1 GB/2 GB (FAT12 and FAT16 format corresponding) SDHC Memory Card: 4 GB, 8 GB (FAT32 format corresponding)
Compression	JPEG (Design rule for Camera File system, based on Exif 2.2 standard), DPOF corresponding
Picture size	1920×1080

AC adaptor

Information for your safety

Power source:	AC 110 V to 240 V, 50/60 Hz
Power consumption:	19 W
DC output:	DC 9.3 V, 1.2 A (Unit operation) DC 8.4 V, 0.75 A (Battery charging)

Dimensions	92 mm (W)×33 mm (H)×61 mm (D)
Mass	Approx. 115 g

Battery pack

Information for your safety

Maximum voltage:	DC 8.4 V
Nominal voltage:	DC 7.2 V
Rated capacitance:	2640 mAh

Specifications may change without prior notice.



VQT1G62
F0707BL0 (500 (A))



Matsushita Electric Industrial Co., Ltd.
Web site: <http://panasonic.net>